

SECTION 6 STARTING AND STOPPING PROCEDURES

IGNITION SWITCH	2
STARTING THE ENGINE	2
STARTING FROM THE DRIVER'S SEAT	3
STARTING THE ENGINE FROM THE ENGINE COMPARTMENT	4
COLD WEATHER STARTING	4
JUMP STARTING	5
ENGINE BLOCK HEATER.....	6
ENGINE WARM-UP	6
ALLISON TRANSMISSION WARM-UP.....	7

6-2 STARTING AND STOPPING PROCEDURES

IGNITION SWITCH

Coaches may be equipped with an ignition lever instead of an ignition key.

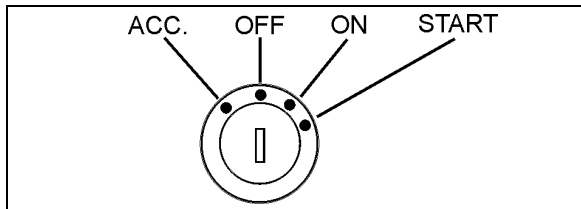

IGNITION SWITCH POSITIONS

06354

The ignition switch is located on the lower left side of the dashboard. It has four positions:

OFF - In the off position, ignition cannot take place. The key can be removed when in this position.

The electrical circuits are not activated when the switch is in this position. Only the accessories connected directly to the batteries can be activated. These are:

- The preheater, the preheater timer and the water pump;
- The battery master switch;
- The entrance door;
- The baggage compartments central locking system;
- The battery equalizer;
- The engine and transmission control unit;
- The fire detection and suppression system.

Maintain the switch in this position when parked overnight or for an extended period.



CAUTION

When the vehicle is parked overnight or for an extended period of time, the battery master switch should be set to the OFF position.

NOTE

The battery master switch is ON when the hazard flashers are activated, even if the key is in the OFF position.

ACCESSORIES - To operate the accessories only, turn the ignition key counterclockwise to the ACC position. The key cannot be removed in this position.

The electrical circuits are activated when the switch is in this position or when the hazard flashers are activated.

The features enabled when the key is in the ACC position are all those linked directly to the battery plus the exterior temperature display, the radio or entertainment system, exterior and interior lighting.

ON - Set the ignition switch to on by turning the key clockwise to the first position. The key cannot be removed in this position.

The electrical circuits activated when the switch is in the ACC position plus the transmission, engine and accessories, ABS system, wipers, dashboard cluster gauges and buzzers, air horn and air dryer heater are activated when the key is in this position. Do not leave the key in this position unless the engine is running.

NOTE

To prevent discharge of the batteries when the engine is not running, some functions are automatically switched off if the batteries voltage drops below 24.0 volts for more than 30 seconds. A pictogram and a message will appear in the DID while this protection mode is active. Set the ignition key to the OFF position and then turn the ignition key to the ON position to reactivate the functions for a period of 30 seconds before they switch off again. If a prolonged use of the functions with the engine not running is necessary, connect the battery to a charger.

START - Use this position to crank the engine. The ignition switch is equipped with a starter protection which inhibits turning the lever to the START position if the lever has not previously been turned to the OFF position.

The features activated when the engine is running are all those described above plus the HVAC system and daytime running lights.

STARTING THE ENGINE

In normal circumstances, the engine should be started from the driver's seat. However, a rear-start panel in the engine compartment permits starting of the engine from that location, mainly for maintenance purposes.

STARTING FROM THE DRIVER'S SEAT

1. Make sure the rear start selector switch located in the engine compartment is set to the NORMAL position and that the battery master switch located in the main power compartment is set to the ON position;

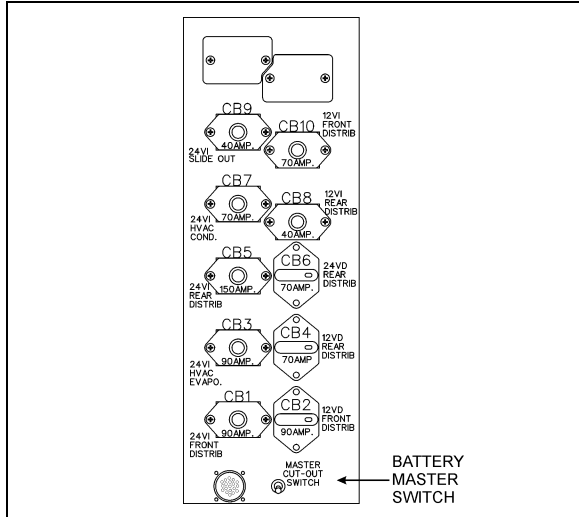

INSIDE MAIN POWER COMPARTMENT 06605A

2. Make sure the parking brake is applied, if not, apply the parking brake by pulling the parking brake control button all the way up;
3. Turn ignition switch to ON and wait a few second;

NOTE
 When the ignition is turned to ON, the M32QR ABS Pressure Modulator Valve solenoids are briefly energized. This can be audibly detected by a rapid cycling of the PMVs. If the air system is fully charged and the service brake pedal is depressed when ignition is turned to ON, the modulator valves create a sharp audible "chuff" of air pressure.

4. The transmission control system automatically selects neutral (N) when the ignition switch is turned to ON;
5. With your foot off the accelerator pedal, turn ignition switch to START position, release the ignition switch after the engine starts. If the engine did not start, return the ignition switch to the OFF position before trying to restart the engine;
6. Brake pedal must be applied when selecting Drive (D) otherwise the transmission will stay in neutral (N).

CAUTION
 Do not engage starter for more than 15 seconds at a time. If engine does not start within 15 seconds, release ignition key and let starter cool for one minute before attempting to restart.

CAUTION
 Do not press the accelerator pedal before starting. This could result in an electronic control unit fault and degrade the fuel system control.

CAUTION
 Special precautions are necessary with turbocharged engines to avoid possible turbine damage. After starting, run the engine at normal idle for two minutes to allow lubricating oil to reach the turbocharger. Then run the engine at fast idle. Let oil pressure reach normal operating range before driving.

NOTE
 If engine does not start, return key to OFF position before attempting to restart.

NOTE
 If the accelerator pedal is depressed before starting, release and wait 30 seconds before attempting to restart.

WARNING
 Do not use ether or other combustible starting aid fluid on any engine equipped with an intake air preheater. If the engine is equipped with a preheater, introduction of ether or similar starting aids could cause a fire or explosion resulting in severe property damage, serious personal injury or death.

Stopping the Engine

1. Apply parking brake and place transmission in neutral (N);
2. Shut off all electrical loads;
3. Allow engine to idle for at least two minutes before shutting down the engine. This

6-4 STARTING AND STOPPING PROCEDURES

insures that the turbine speed drops and allows time for the engine exhaust gas temperature to drop to about 300°F (150°C);

4. Turn the ignition key to the OFF position.



CAUTION

Do not shut off the engine when running above normal idle.



CAUTION

Set the Safety switch to the OFF position after parking and when left unattended for an extended period of time.

STARTING THE ENGINE FROM THE ENGINE COMPARTMENT

Switches to start and stop the engine from inside the engine compartment are mounted on a small panel on the R.H. side of engine compartment.



WARNING

Apply parking brake before starting engine from inside the engine compartment.

1. Set the battery master switch to the ON position;
2. Set the starter selector switch to the REAR START position;
3. Press the REAR START push-button switch. Release the push-button after the engine starts.

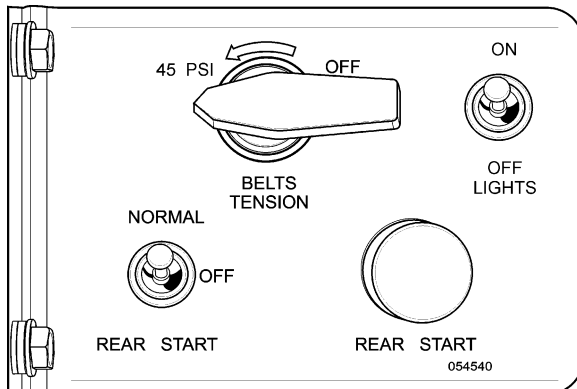

ENGINE REAR START PANEL

01044



WARNING

Do not wear loose clothing when working near engine. Stand clear of rotating components.



CAUTION

Refer to cautions in "Starting From The Driver's Seat" and "Stopping the Engine" in this chapter.

STOPPING THE ENGINE

To stop the engine, set the starter selector switch to the OFF position.



CAUTION

Do not stop engine by any other method.



WARNING

Apply the parking brake before stopping engine. In the event the engine is stopped while the parking brake is not applied, a reminder alert will sound.

COLD WEATHER STARTING

When starting a cold engine, the intake air will be warmed up with the intake air preheater. Turn the ignition switch to the ON position. The intake air preheater will not engage at coolant temperature above 54°F (12°C). If the coolant temperature is below 54°F (12°C), the intake air preheater will engage and will light the preheater telltale between 0 and 50 seconds, depending on the engine coolant temperature. Wait before the preheater telltale has turned off before starting the engine.

If necessary, once the engine has started, the preheater will reengage (post heating) for the same length of time as the preheat time.

 **WARNING**

Do not use ether or other combustible starting aid fluid on any engine equipped with an intake air preheater. If the engine is equipped with a preheater, introduction of ether or similar starting aids could cause a fire or explosion resulting in severe property damage, serious personal injury or death.

Engines not equipped with an intake air preheater may, depending on coolant temperature, take longer to start. If this should happen, DO NOT release the ignition key until the engine has started (while still observing the 15 second maximum cranking time).

JUMP STARTING

In order to avoid damage to solid-state electrical components, it is important that jumper (booster) cables be used correctly and only in emergencies. To jump start, use another 24 volt DC, negative grounded, power source. Use only jumper cables rated at 500 cranking amperes.

 **WARNING**

Injury, explosion, battery acid damage or charging system overload may result if these jump starting procedures are not precisely followed.

 **WARNING**

Wear eye protection and remove rings, metal jewelry and watches with metal bands.

 **WARNING**

The battery could rupture or explode if jump started when the run-down battery fluid is frozen or if the battery fluid level is low. Check condition of run-down battery before attempting to jump start.

 **WARNING**

The gases given off by batteries while jump starting are explosive. Do not smoke near batteries.

 **CAUTION**

Do not let the two vehicles touch. Keep a walk-through distance between the two vehicles. Make sure positive (red) and negative (black) jumper cable clamps do not touch.

 **CAUTION**

Never connect the jumper cable to the negative terminal post of the run-down battery.

 **CAUTION**

Do not jump start if a maintenance-free battery has a yellow test indicator. Have the battery replaced.

 **CAUTION**

Before attempting to jump start, make sure the parking brake is applied and the transmission is in neutral (N). Turn off all lights, heaters and other electrical accessories.

 **CAUTION**

Choose a booster vehicle which produces comparable amperage as your vehicle.

 **CAUTION**

Off-board battery charger with a start boost facility must not be used to jump start the vehicle. This could damage the electrical system.

6-6 STARTING AND STOPPING PROCEDURES

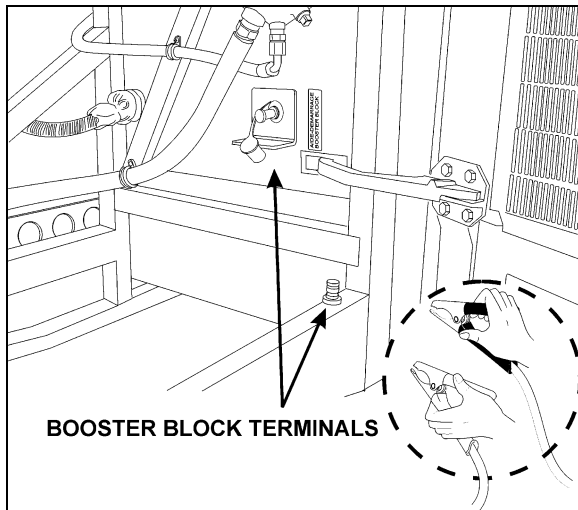

BOOSTER BLOCK TERMINALS IN ENGINE R.H. SIDE ACCESS COMPARTMENT

18645

To jump start, proceed as follows:

1. Remove the protective caps from the booster block terminals located in the main power compartment.
2. Connect one end of the red jumper cable to the positive (+) post of the booster power source. If the good battery is in another vehicle, that vehicle's engine must be stop before connecting;
3. Connect the other end of the same red jumper cable to the positive (+) terminal on the booster block;
4. Connect one end of the black jumper cable to the negative (-) post on the booster power source;
5. Connect the other end of the same black jumper cable to the negative (-) terminal on the booster block; If the good battery is in another vehicle, start that vehicle's engine;
6. Let the engine run for a few minutes, then start the vehicle with the run-down battery;
7. Disconnect the jumper cables in reverse order given in steps 2 through 5;
8. Install protective caps on the booster block terminals.

NOTE

Jumper cables must be rated at 500 cranking amperes. If jumper cable length is 20 feet (6 m) or less, use 2/0 (AWG) gauge wires. If cable length is between 20 to 30 feet (6 to 9 m), use 3/0 (AWG) gauge wires.

ENGINE BLOCK HEATER

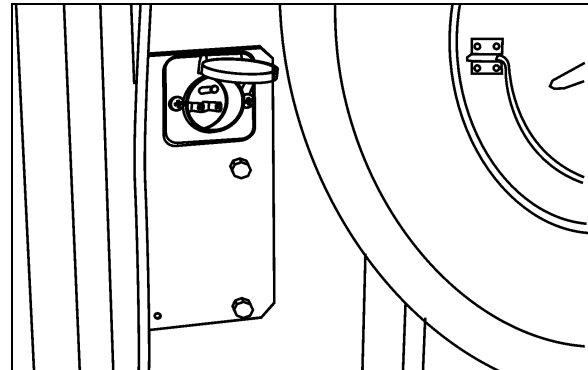

110-120 VOLTS BLOCK HEATER CONNECTOR 06650

The vehicle is equipped with an engine immersion-type electric block heater to assist cold weather starting. A connector is located inside the engine R.H. side compartment. Using an extension cord, connect to a 120 VAC outlet. Use the engine block heater when the vehicle is parked in cold weather for a long period and the proper power source is available.



CAUTION

Connect only to a 120 VAC power source. Use only grounded (three prongs) extension cords with a minimum rated capacity of 15 amps. Disconnect the extension cord before starting. Before driving, make sure the extension cord is disconnected and the engine R.H. side compartment door is closed.

ENGINE WARM-UP

After starting the engine, keep the parking brake applied and let the engine run at normal idle for two minutes to allow lubricating oil to reach the turbocharger. Increase engine speed to fast idle, using the fast idle switch located on the dashboard for five minutes, without loading the engine. Monitor the gauges and indicator lights to make sure all conditions are normal. If an abnormal condition is observed, stop the engine immediately and have the condition corrected.



WARNING

Never let the engine run in an enclosed, non-ventilated area. Engine exhaust fumes contain dangerous gases which can be fatal if inhaled. Before warming up the engine, open the door(s) or move the vehicle outside.

NOTE

The engine will reach normal operating temperature shortly after driving. Avoid driving at full throttle until engine coolant temperature reaches 140°F (60°C).

ALLISON TRANSMISSION WARM-UP

With an automatic transmission, when the temperature falls below -20°F (-29°C), the CHECK TRANS telltale light illuminates after the engine is started, and a reminder tone will sound. In this case, the transmission will be locked in neutral (N) until the transmission temperature rises above -20°F (-29°C) and the CHECK TRANS telltale light goes out. The transmission will only operate in first or reverse gears until it reaches normal operating temperature.

