

Driver's Handbook

Volvo 9700 US/CAN

B13R



VOLVO

Foreword

This manual contains information concerning the operation and function of the Volvo 9700 US/CAN bus with version 3 of the multiplex electrical system. The information in this manual applies to vehicles complying with EPA 14 Emission Standard. Please keep this manual in the vehicle at all times.

Note: Illustrations in this manual are used for reference only and may differ slightly from the actual vehicle. However, key components addressed in this document are represented as accurately as possible.

The National Highway Traffic Safety Administration (NHTSA) and Prevost should be informed immediately if you believe that the vehicle has a defect that could cause a crash, injury or death.

Contact NHTSA by calling the Auto Safety Hotline at 1 (888) 327-4236, by writing to NHTSA, U.S. Department of Transportation, Washington, DC 20590, by TTY at 1 (800) 424-9153, or visit their website at www.nhtsa.dot.gov.

Volvo Bus Corporation

Göteborg, Sweden

Order number: 89186651

©2015 Volvo Bus Corporation, Göteborg, Sweden

All rights reserved. No part of this publication may be reproduced, stored in retrieval system, or transmitted in any forms by any means, electronic, mechanical, photocopying, recording or otherwise, without the prior written permission of Volvo Bus Corporation

Contents

Introduction	1
Driver's Responsibility.....	1
Keys	2
Key and Cylinder Replacement	3
Entering the Bus.....	4
Main Power Switch.....	4
Emergency Stop.....	5
Protection Against Battery Discharge.....	5
Doors and Hatches	6
Doors.....	6
Opening from Inside	6
Closing.....	7
Hatches.....	8
9700 US/CAN (with Wheel Chair Lift).....	9
9700 US/CAN (without Wheel Chair Lift).....	10
Roof Hatches.....	11
Driver's Position	12
Driver's Position.....	12
Driver's Seat.....	13
Horn	14
Dashboard.....	15
Instruments and Controls	17
Faults and Warnings.....	17
Accelerator Pedal Deactivated.....	18
STOP Message.....	19
Warning Message.....	19
Stop at the next bus stop Message	19
Instrumentation	20
Types of Instruments.....	20
Instrument Panel Lamps and Symbols.....	27
Light Switch.....	29
Switches.....	31
Main Switch.....	31
Emergency Stop.....	32
Kneeling.....	33
Level Control	34
Increasing Load on the Driving Axle (trailing axle lift).....	35
Traction Control System (TCS).....	36
Differential Lock.....	37
Hill Start Assistance.....	37
Passenger Compartment Lighting.....	38
Night Lighting (Option).....	38
Half-Light	38

Driver Compartment Lighting	39
Passengers' Individual Lighting	39
Rear Door Lighting	40
Position Lights	40
Destination Sign Lighting (option)	40
Electrically heated rear—view mirrors	41
Driver's window heating	41
Driver's Blower	42
Central Locking	42
Sun Visor	42
Driver's Window	43
Activation of the Toilet	43
Audio System	43
Opening the Doors from the Outside	44
Emergency Window in use Indicator Lamp	44
Wheel Chair Lift, System (Optional)	45
Wheelchair Lift System Indicator Lights	45
Switches in the Electrical Center	46
Controls	47
Starting Switch	47
Adjusting External Rear-view Mirrors	48
Open Door Brake	49
Steering Wheel Adjustment	50
Directional indicator, Dipped/full beam changer	51
Windscreen Wipers, Windscreen/headlight Washer	52
Transmission	53
Transmission, I-Shift Lever Selector	53
Transmission, I-Shift Pad Selector	54
Allison, automatic transmission (Optional)	55
Allison transmission, pad selector	56
Allison transmission, pad selector	57
Allison transmission, Mode function	58
Retarder (if installed)	59
Retarder Overheating	60
Transmission Overheating	61
Brakes	62
Parking Brake	62
Blocking Valve	63
Service Brakes	64
A/C Controller	67
Destination Sign (Optional)	68
Destination sign Mobitec	68
Destination sign Innova	69
Interior Equipment	70
Interior Equipment	70

Toilet	71
Basket integrated in the rear interior panel	71
Passenger's Clock Display	72
Passengers Panel	73
Lighting Stripe LED	73
Passenger's AC 110 V Power Outlets	74
Passenger's AC 110 V Power Outlets Circuit Braker	74
TGW (Telematics Gate Way) system and Liaison communication system	75
Passenger's sliding seats	76
Control pendant (for Wheel Chair Lift)	77
Audiovisual System	78
Audiovisual System	78
Audiovisual Controller	79
Video System	79
Audio System	79
Emergency and Safety Equipment	80
Overview	80
Fire Extinguisher	80
Automatic Fire Suppression System	81
Manual Discharge	82
Warning Triangle	83
First-aid Kit	83
Park Pilot System (optional)	84
Tire Pressure Monitoring System	85
Tire Pressure Monitoring System (TPMS) Display	85
Tire Inflation Valve	86
External Air Supply Connection	86
Jack	87
Toolbox	88
Engine Control Box in Engine Bay	89
Emergency Exits	90
Doors	90
Ceiling, Roof Hatches	90
Emergency Windows	91
Starting and Driving	92
Checking Before Driving	92
Cleaning and Maintenance	93
Checking Warning Lights	94
Daily Inspection	94
Engine	94
Steering Servo/Hydraulic Fan	95
Coolant	95
Washer Fluid	95

Refuelling.....	96
Diesel Exhaust Fluid (DEF) Tank.....	97
Engine Block Heater	98
Starting the Engine.....	99
Starting.....	99
Checks After the Engine Has Been Started.....	100
Idling (programming).....	101
Cruise Control.....	102
Retarder (optional).....	103
Power Steering.....	106
Aftertreatment DPF with vertical SCR.....	107
Exhaust Aftertreatment System	108
DPF Regeneration Required Icon	109
High Exhaust System Temperature.....	109
Emission Green House Gas Component Warranty.....	110
Critical emissions-related Maintenance.....	110

Some Advice for Driving	111
Safe Driving.....	111
Economy Driving.....	112
Driving in Cold Weather.....	113
QR Code Labels.....	114

If Something Happens	115
VAS Assistance Label.....	115
Safety	115
If the Engine is Not Working.....	116
Punctures.....	116
Punctured Air Springs.....	116
Towing	117
Towing procedure.....	118
Second Fire Detection Circuit.....	119
Releasing the Parking Brake.....	120
Release the Parking Brake with Air from the Bus Tires.....	120
Mechanical Releasing of the Parking Brake.....	121
Disc Brakes.....	122
Changing the Batteries.....	123
Starting Assistance.....	124
Battery Cut-off Switch.....	125
Bulb Replacement.....	126
Headlamps.....	126
Rear Lights.....	126
Xenon Lights.....	127
Licence Plate Lighting.....	127
Fuses and Relays (body & chassis).....	128
Relays (chassis).....	129

Fuses (chassis)	130
Fuses and relays (body)	133
Relays	133
Fuses	134
Replacement of wheels	136
Spare wheel	136
Technical Data	137
Technical Specification	137
Bulbs	138
Type Plates	139
Identification Plate	139
Vehicle Identification (VIN)	140
Engine (identification labels)	140
I-Shift transmission (identification plate)	141
Allison transmission (identification plate)	141
Rear Axle (identification plate)	142
Retarder (If installed), identification plate	142
Service Intervals	143

Safety Information

IMPORTANT: Before driving this vehicle, be certain that you have read and that you fully understand each and every step of the driving and handling information in this manual. Be certain that you fully understand and follow all safety warnings.

IT IS IMPORTANT THAT THE FOLLOWING INFORMATION BE READ, UNDERSTOOD AND ALWAYS FOLLOWED.

The following types of advisories are used throughout this manual:



DANGER

Danger indicates an unsafe practice that could result in serious personal injury or death. A danger advisory banner is in **white** type on a **black** background with a **black** border.



WARNING

Warning indicates an unsafe practice that could result in personal injury. A warning advisory banner is in **black** type on a **gray** background with a **black** border.



CAUTION

Caution indicates an unsafe practice that could result in damage to the product. A caution advisory is in **black** type on a **white** background with a **black** border.

Note: Note indicates a procedure, practice, or condition that must be followed in order for the vehicle or component to function in the manner intended.

Driver's Responsibility

- As the driver, you are responsible for the safety and comfort of the passengers during the journey. Therefore, do not drive the bus before you have read this driver's manual. You must be familiar with all the indicators and warning lights and know what to do if something unexpected happens.
- As the driver of the vehicle, you should be aware of the vehicle weight and loading capacity. See instructions on warning stickers, the vehicle registration book and on the identification plate.
- As the driver of the vehicle, it is your responsibility to foresee any hazards that could threaten your passengers.
- It is also your responsibility to ensure that all the safety equipment of the bus is in place. Therefore check regularly the working order of safety belts, emergency door and window opening, door sensitive edges, fire extinguishers and first aid equipment.
- The brakes on the bus are operated by compressed air. Never drive if the air pressure is too low or if you discover other problems with the brakes.
- Pay attention to any steering faults. The vehicle can be steered even if the power steering is not working, although the steering will be heavy.
- Never crawl under the bus if it is supported by a jack. Use approved vehicle supports or a solid pallet in case of punctures or wheel changes.
- Lifting devices and supports should stand securely on a horizontal surface. The wheels that are not to be lifted should be blocked to ensure that the vehicle will not start to move.
- Re-tighten the wheel nuts after approximately 200 km (125 mi) if the wheels have been removed.
- Tighten the wheel nuts every 6 months regardless of whether the wheels have been removed or not.
- Follow the recommended service and maintenance program to maintain the bus's condition and safety.
- Pay attention to exhaust and fuel smells. Any leaks should be taken care of immediately at the garage.
- The bus tires and rims should be approved for the intended load and speed in accordance with current legal requirements.

2 Introduction

Keys

The following keys are delivered with the bus:

- 1 Ignition
- 2 Exterior and Interior Hatches
- 3 Engine RH Side Access Door, Radiator Door

There may be alternative versions of the keys, depending on the types of locks that are fitted.

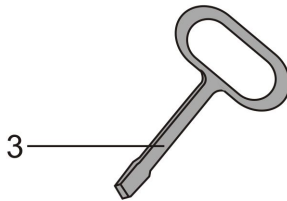
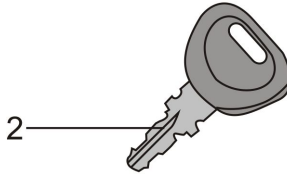
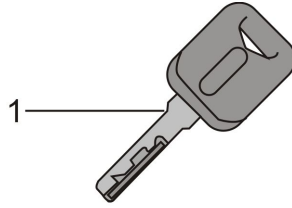

W0089523

Note: Note the number of the ignition key to facilitate ordering of spare keys.

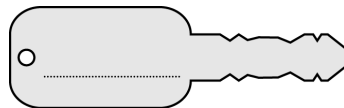

T0013333

Key and Cylinder Replacement

Key and Cylinder Replacement

Key and Cylinder Replacement	
Location	Part Number
Exterior and Interior hatches	(*) 70348099 (cylinder) 70364098 (key).
Ignition	8159908 (1 ignition lock + switch, 2 door locks, 2 keys)
Engine RH Side Access Door, Radiator Door	70319047

(*) Both parts (Cylinder and Key) must be ordered.

4 Introduction

Entering the Bus

To open the front door:

- turn the key in the lock to the horizontal position
- turn the knob to the vertical position
- push the pneumatic door opening button

The button for the pneumatic opening of the first door is placed in the door handle.

Note: In case of total or partial emptying of the door pneumatic system, open the door by pushing the right side of the door.

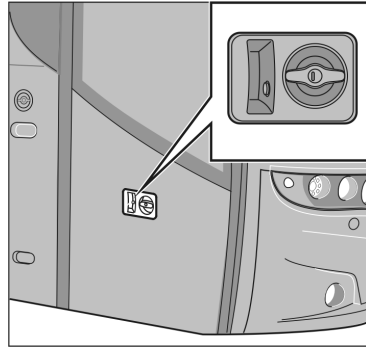

T8012405

Main Power Switch

Is located on the dashboard. Always turn off the power supply with the main switch before leaving the bus.

Note: Never turn off the main switch while the engine is running.

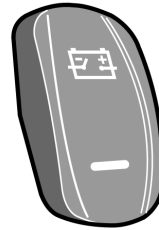

T0012043

Emergency Stop

An emergency switch is located on the left side of the dashboard. Depending on the market specification, the emergency switch may disconnect the bus electrical power supply, cut off the fuel supply and activate the hazard warning lights.

Note: Only use the emergency cut out in an emergency situation.

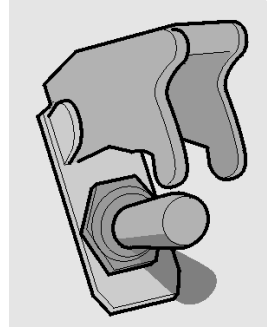

T0009170

Protection Against Battery Discharge

In order to prevent battery discharge while the bus is standing, the Volvo 9700 US/CAN bus is equipped with a function that disconnects the supply to major electrical consumers such as: electric heaters, some external lighting, etc.

Power to these consumers is switched off around 30 seconds after the engine is shut down, and it is then switched back on once the engine is started and its revolutions reach at least 1000 rpm for 10 seconds.

6 Doors and Hatches

Doors

The Volvo 9700 US/CAN bus is equipped with one single-leaf door opening outwards. The door is normally operated by pneumatic cylinders.

The door may be equipped with a system protecting passengers from being trapped in the doorway during opening or closing, this system has sensors measuring the air pressure in the door system.

Note: In the case of excessive drop of the door pneumatic system air pressure, the “Door failure” warning lamp lights in the lower right corner of the bus instrument cluster.



T0012008

Opening from Inside

There is a button for door opening on the right hand side of the driver's dashboard. Pushing the button causes the door to open. The button indicator lamp is lit when the door is open.

Note: Before closing the door ensure that there are no passengers standing in the doorway.

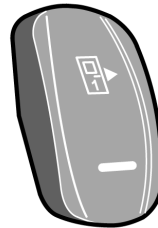

T3018176

Closing

Proceed as follows:

- 1 Select neutral position on the gear selector.
- 2 Engage the parking brake
- 3 Turn on the switch that activates the door opening push-button in the door handle
- 4 Open the door
- 5 Turn off the power supply with the main switch
- 6 Leave the bus and close the door using the push-button in the door handle
- 7 Lock the door with the key

Note: After locking the door with the key, the push-button in the door handle becomes inactive.

After turning off the power supply with the main power switch, the light above the entrance door remains on for about 90 seconds.

If the button activating the button in the handle for opening the door **is not switched on**, in order to enter the bus again, the emergency valve must be used.

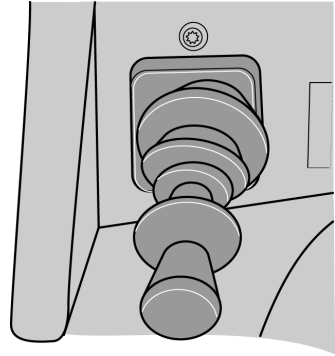

T5014881

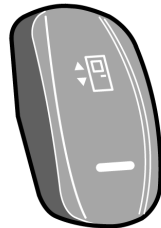

T1008555

Button for outside opening of the door

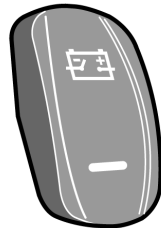

T0012043

8 Doors and Hatches

Hatches

If any of the bus hatches are open or not properly closed, a “hatch open” symbol will appear on the instrument panel display.

Note: The engine cannot be started unless the engine hatch is closed.

Note: With the engine hatch open, the engine can be started by means of a button in the control box. See: “Engine Control Box in Engine Bay”, page 89



T3018116

The configuration of the service and luggage compartment hatches depends on the bus variant. Possible variants are shown below. The description refers to items located behind the hatch.

9700 US/CAN (with Wheel Chair Lift)

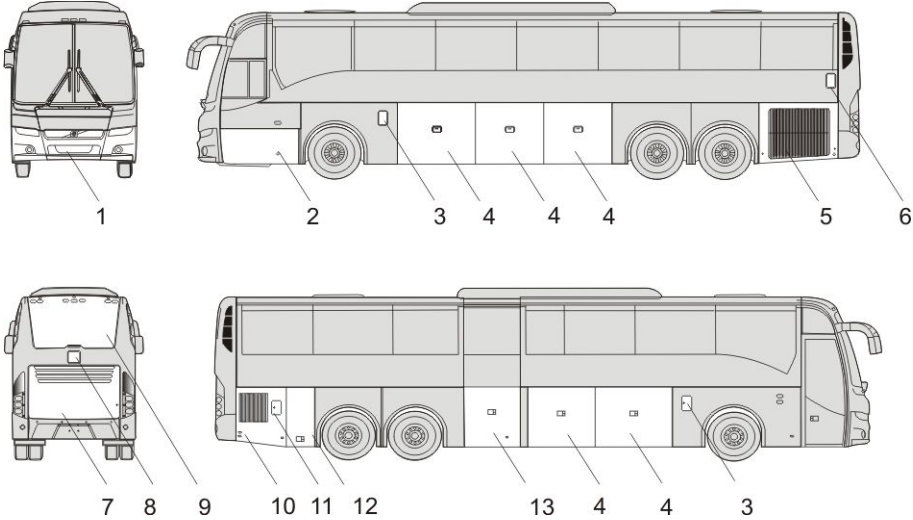

T8061040

- | | |
|---|---------------------|
| 1 External Air Valve, Towing Point, Spare Wheel | 7 Engine |
| 2 Battery Box, Battery Cut-off Switch, Main Fuses, Washer Fluid Reservoir | 8 Coolant Filler |
| 3 Fuel Filler | 9 SCR |
| 4 Luggage Compartment Hatch | 10 Auxiliary Heater |
| 5 Radiator | 11 DEF Filler |
| 6 Urea Injector Service Access | 12 Waste Tank |
| | 13 Wheel Chair Lift |

10 Doors and Hatches

9700 US/CAN (without Wheel Chair Lift)

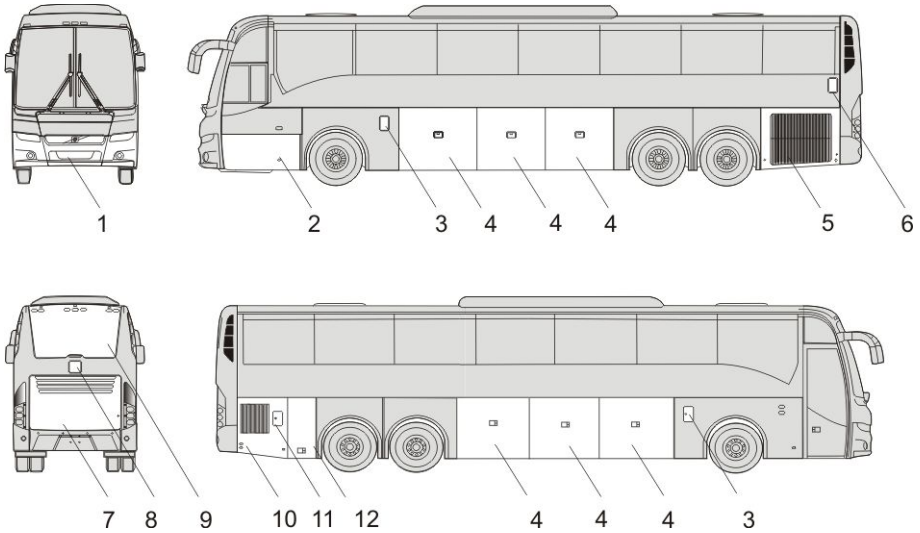

T8061041

- | | |
|---|---------------------------------------|
| 1 External Air Valve, Towing Point, Spare Wheel | 7 Engine |
| 2 Battery Box, Battery Cut-off Switch, Main Fuses, Washer Fluid Reservoir | 8 Coolant Filler |
| 3 Fuel Filler | 9 Selective Catalytic Reduction (SCR) |
| 4 Luggage Compartment | 10 Auxiliary Heater |
| 5 Radiator | 11 Diesel Exhaust Fluid (DEF) Filler |
| 6 Urea Injector Service Access | 12 Waste Tank |

Roof Hatches

The Volvo 9700 US/CAN bus is equipped with roof hatches manually operated. Manually operated hatches are opened by the handles on each side of the hatch.

For more information see separated instructions “Manual Roof Hatch”

Note: When the A/C is activated in the bus its hatches should be closed, since the air coming in from outside may interfere with the operation of the equipment controlling the temperature inside the bus.

Note: Make sure that the hatches are closed when it's raining and when you leave the bus for a longer period of time.

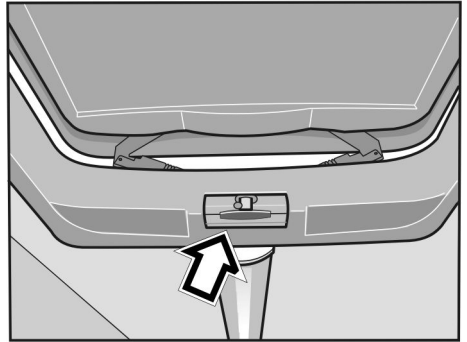

T8010110

12 Driver's Position

Driver's Position

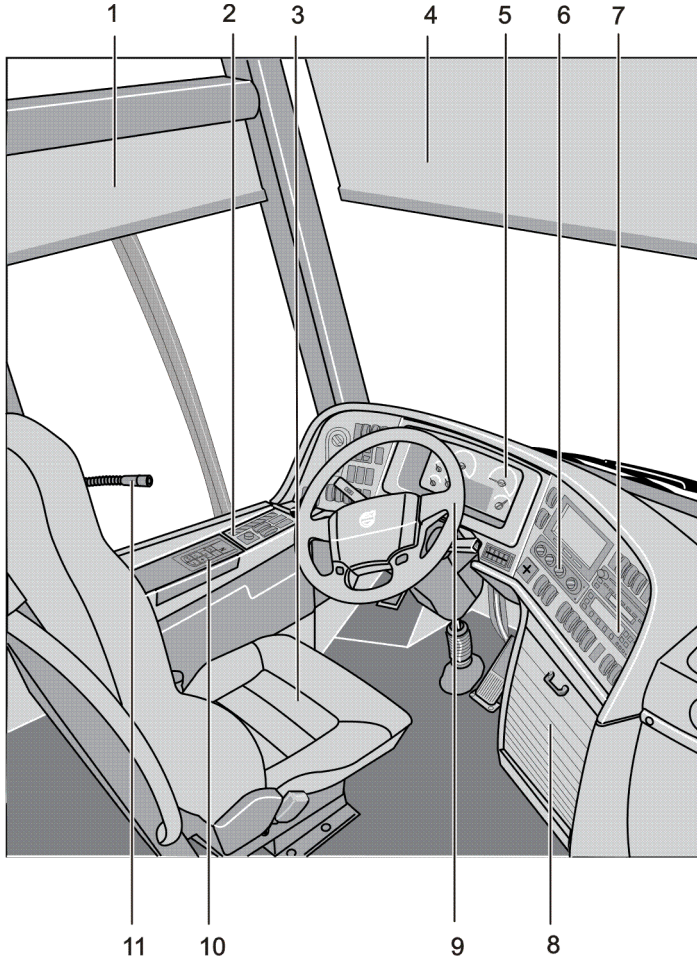

W0089969

- | | |
|---------------------------------|-----------------------------------|
| 1 Side Sun Visor | 7 Controllers, Audiovisual System |
| 2 Side Panel | 8 Locker, Audio Equipment |
| 3 Driver's Seat | 9 Steering Wheel |
| 4 Front Sun Visor | 10 Gear Selector |
| 5 Dashboard, Instrument Cluster | 11 Driver's Microphone |
| 6 Controller, AC | |

Driver's Seat

The Volvo 9700 US/CAN bus is equipped with “National Seating” driver's seat type. For more driver's seat information see separated instructions “Driver's seat”.

Note: The safety belt should not be twisted or blocked when properly fastened.

Note: Before adjusting, check whether there are any objects in front of the seat or behind it, that could hinder adjustment.



W0089527



DANGER

Adjusting seat position or fastening a seat belt should only be performed when the vehicle is stationary. Attempting this while the vehicle is moving may lead to an accident, causing serious personal injury or death.

14 Driver's Position

Horn

The Volvo 9700 US/CAN bus is equipped with one electrical horn (diaphragm) and one operated by compressed air. Pushing the central part of the steering wheel activates the electrical horn, while pushing one of the two small buttons beneath activates the air horn.

Note: Remember that the use of horns is subject to regulations.

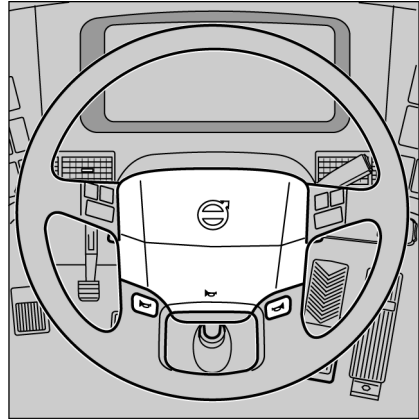

T6010187

Dashboard

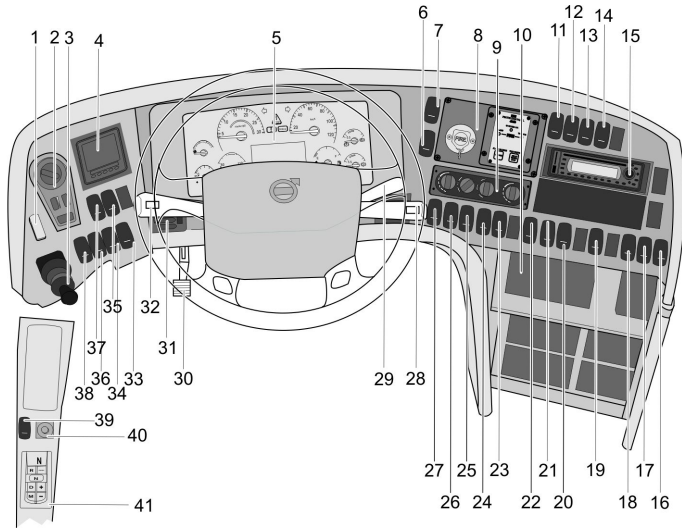

W8081292

- | | |
|---|---|
| 1 Emergency Stop Switch | 18 Spare |
| 2 Light Switch | 19 Central Lock |
| 3 Parking Brake | 20 Driver's Microphone enabled |
| 4 Tire Monitoring System | 21 Position Lights |
| 5 Instrument Cluster | 22 Service First Door |
| 6 Delay Automatic Fire Suppression System | 23 Door Lock |
| 7 Emergency Windows Open Warning | 24 Night Light Under Seats |
| 8 Automatic Fire Suppression System | 25 Interior Lights |
| 9 AC controller | 26 Reading Light |
| 10 Spare | 27 Night Light |
| 11 Light for Driver's Position | 28 Display Control Stalk, Wipers and Washers Control Stalk |
| 12 Front Sun Visor | 29 Retarder |
| 13 Wheel Chair Lift System Enable and Door Ajar | 30 Steering Wheel Adjustment Pedal |
| 14 Wheel Chair Lift Main Switch | 31 Air Inlet |
| 15 Audio and Video System | 32 Control Stalk at the Steering Wheel, Direction Indicators and Cruise Control |
| 16 Toilet Activation | 33 Traction Control System |
| 17 Driver's fan | |

16 Driver's Position

34 Hill Start Auxiliary

35 Bogie

36 Bus Level

37 Kneeling

38 Main Switch

39 Mirror Heater

40 Mirror Adjustment

41 I-Shift Selector Pad or Allison
Transmission Shift Selector Pad

Faults and Warnings

There are three different types of signals that give the driver all the necessary information on the vehicle:

- STOP message
- Warning message
- Stop at the next bus stop message

Above the display there are three lamps (for stop at the next bus stop, warning and STOP messages), that alert the driver's attention when necessary.

Messages with appropriate symbols are shown automatically on the display.

Several messages can be active simultaneously. A new message will only replace the current message on the display if it is of higher priority. This means that the display always shows the message with the highest priority.

For more detailed information about display functions, see the separate Operating Instruction "Display".

18 Instruments and Controls

Accelerator Pedal Deactivated

The bus is fitted with prioritized brake function.

This function deactivates a request for acceleration if **both** the accelerator pedal and the foot brake pedal or parking brake have been activated simultaneously.

The accelerator pedal remains deactivated until it is reset, which occurs once the pedal has been fully released.

For additional information on this function, see the separate Operating Instruction “Display”.



T0013511

STOP Message

 DANGER
If this lamp lights while driving, stop the bus immediately and turn off the engine. Continuing to drive may severely endanger the vehicle, the driver and/or passengers.



T3014364

Note: If the STOP message appears while the engine is running, it is accompanied by activation of the audible warning buzzer.

Warning Message

If this lamp lights, the vehicle must be taken to a workshop for repair as soon as possible. There is no immediate danger of the vehicle breaking down, and under normal circumstances it should be possible to complete the journey. This lamp is also used to draw the driver's attention to problems other than vehicle failures, e.g. as a warning in the case of an open luggage compartment hatch.



T3014365

Stop at the next bus stop Message

Simultaneously with this lamp lighting up, a new message is shown on the display. The fact that this lamp lights up does not mean that there is something wrong with the vehicle. This lamp may for example illuminate to draw the driver's attention to low fuel level.

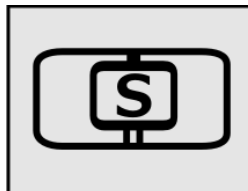

W3079585

Acknowledge the message with **ESC** key. If the information message is still activate, it will be shown again next time the starter key is turned to the starting position.

20 Instruments and Controls

Instrumentation

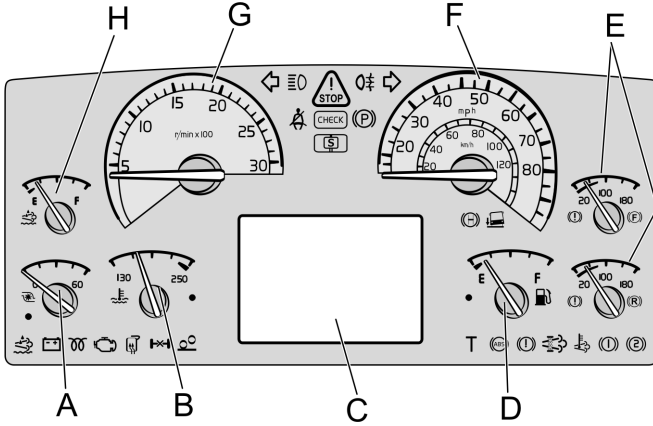

W3081293

Types of Instruments

- A Turbo Pressure Gauge
- B Coolant Temperature Gauge
- C For the display, see the separate Operating Instruction "Display"
- D Fuel Gauge
- E Air Pressure Gauge for Circuit Brakes
- F Speedometer
- G Tachometer
- H Diesel Exhaust Fluid Gauge

Turbo Pressure Gauge (A)

The turbo pressure gauge indicates the pressure in the intake manifold. A high turbo pressure increases fuel consumption. This gauge helps you drive in the most economical manner. When driving on level roads at constant speed, the pointer should remain still within the green zone.

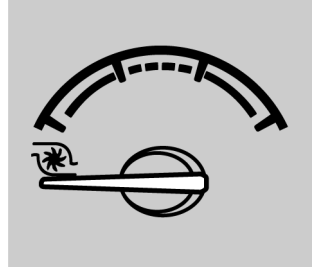

T0011983

22 Instruments and Controls

Engine Coolant Temperature Gauge (B)

This gauge indicates the temperature in the engine's coolant system. Under normal driving conditions, the pointer should stay just below the red zone (normal operating temperature is between 80°C (176°F) and 100°C (212°F)).

The engine is fitted with overheating protection, that reduces the engine power output to 50% if the temperature reaches the red zone. The bus can still be driven even after activation of the overheating protection.

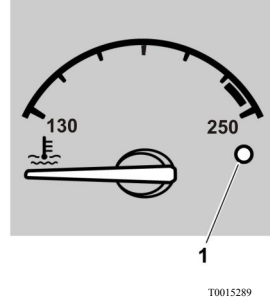

1 Warning lamp, red



CAUTION

The bus must not be driven if the temperature rises even higher as this can result in damage to the engine.

An indicator signals when the cooling system temperature is too high.

- warning lamp (1) lights
- STOP– lamp lights
- the acoustic signal sounds (if the engine is running)

Display (C)

The display consists of the main menu and several submenus with their relevant functions. For additional information, see the separate Operating Instruction “Display”.

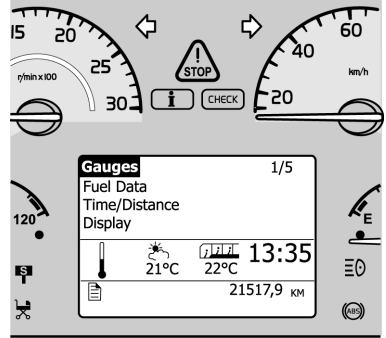

T0012082

Fuel Gauge (D)

The Fuel Gauge shows the amount of fuel in the tank. The red zone and the warning lamp (1) give a warning of low fuel level.

The display gives considerable information on the fuel situation, i.e. fuel consumption, A to B information and remaining fuel. For more information, see separate driver instructions “Display”.

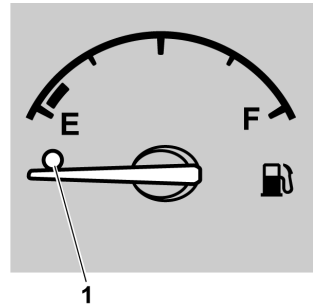

T0011986

24 Instruments and Controls

Air Pressure Gauge for Brakes (E)

DANGER

Stop the bus immediately if any of the warning lamps illuminate! A warning lamp will illuminate if there is an excessive pressure drop in the braking system. Investigate the cause of the fall in pressure. Failure to do so may result in failure of the vehicles brakes that may cause an accident, leading to serious personal injury or death.

If the engine remains switched off for a long time, the compressed air pressure may fall to a level which will prevent the bus being started immediately. The warning lamp remains lit until the pressure in the braking system rises to a sufficiently high level. If the compressed air in the braking system has been completely exhausted, it may take quite a long time before the pressure starts to rise.

During driving, the gauge pointer should remain within the green zone, but it can temporarily drop below that zone during braking.

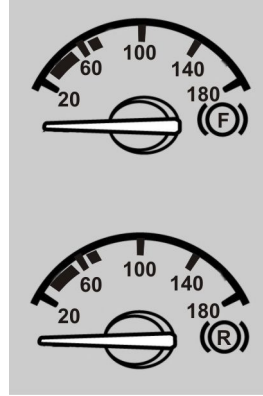

T0015292

F. Air Pressure, front brake circuit

R. Air pressure, rear brake circuit

Speedometer (F)

The speedometer indicates the speed of the bus in mph. For some markets, speedometers are also available that indicate speed both in mph and km/h.

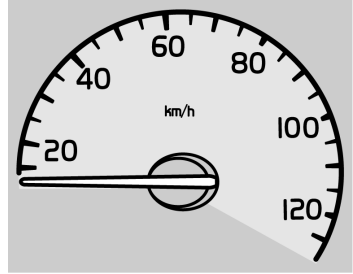

T0011985

Tachometer (G)

The tachometer scale is divided into three zones. During normal driving you should stay within the green zone, which gives the best fuel economy.

	CAUTION
Avoid operating the vehicle with the tachometer in the red zone. Such high engine speeds can result in damage to the engine and the transmission.	

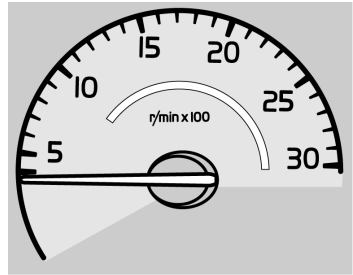

T0011984

26 Instruments and Controls

Diesel Exhaust Fluid Gauge (H)

The Diesel Exhaust Fluid (DEF) gauge shows the amount of DEF in the tank. The red zone and warning lamp (1) give a warning of low DEF level.

The following will be indicate if the DEF level drops too low

- If level is equal or less than about 12% tank volume the dash lamp will light constantly, it warns drivers to fill the tank;
- If the warning was ignored and the gauge reads empty, the dash lamp starts flashing and the engine will experience a 25% torque reduction
- If driver continues to ignore warnings and the bus becomes stationary, the bus speed will be limited to 5 mph.

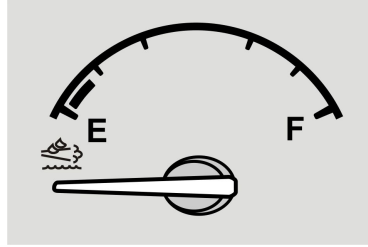

T0061352







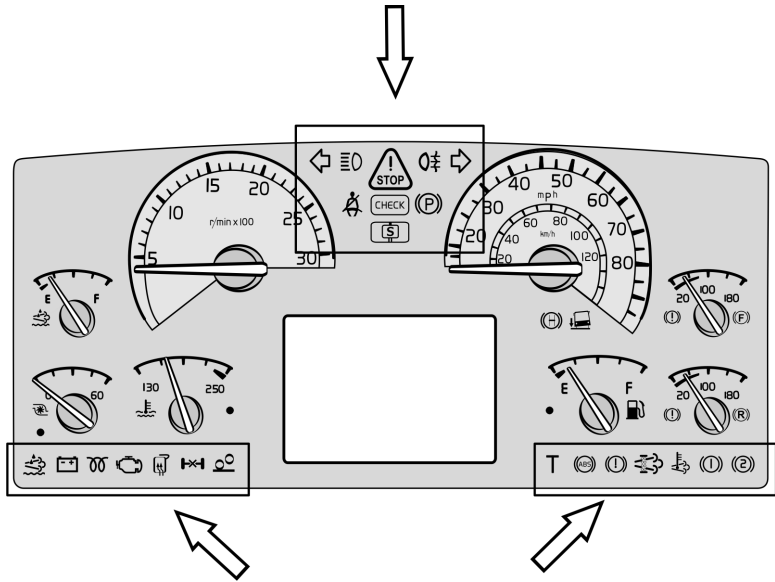



T8061207

















Instrument Panel Lamps and Symbols



W3081294

Symbol	Meaning	Symbol	Meaning
	Left indicator ON		Main beam
	If there is a problem with the bus you must stop.		Fog Light Rear
	Right indicator ON		Safety belt reminder
	Check		Parking brake applied

28 Instruments and Controls

	Stop at the next bus stop		
	Door brake activated		Kneeling activated (for easier access)
 <small>T8061207</small>	DEF Low Level		Battery not charging
	Pre-heating ON		OBD – On-Board Diagnostics
	Screen / mirrors heating activated		Differential lock activated
	The switch for increasing load on the drive axle (bogie lift) of the bogie is on		
	Tachograph event		ABS not functioning
	Brake Air Pressure Low	 <small>T00154 82</small>	DPF Regeneration Required
 <small>T00154 83</small>	High Exhaust System Temperature (HEST)		Brake Air Pressure Circuit 1
	Brake Air Pressure Circuit 1		

Light Switch

- a Lights OFF or automatic activation of Dipped Beam
- b Parking Lights
- c Dipped Beam
- d Auxiliary Spotlights
- 1 Lighting Switch
Pressing the switch turns the front fog lights on and off. Pulling it turns the rear fog lights on and off.
- 2 Indication (Repeater) Lamp, Front Fog Light
- 3 Indicator Light, Fog Light, Rear
- 4 Instrument Lighting Rheostat
- 5 Hazard Warning Lights

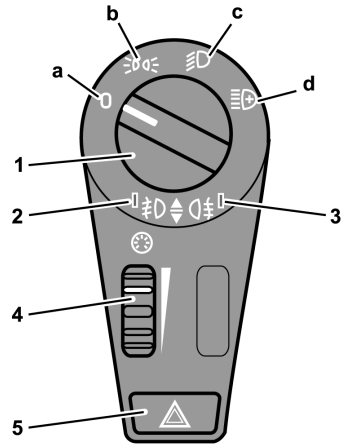

T0012036

30 Instruments and Controls

Hazard Warning Lights

Pressing this button in will turn on all the bus hazard warning lights (both sets of direction indicators). The hazard warning lights will work even if both the ignition and power supply are turned off (with the main power switch).

DANGER

Use the hazard warning lights if the bus is stopped in a manner that may put other road users at risk. Failure to do so may lead to an accident, resulting in serious personal injury or death.

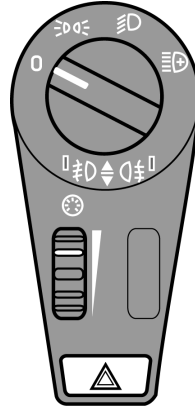

T0014325

Two rear upper lights (**A**; at each side of the bus) works as direction indicators and hazard warning lights

When exterior lights switch is at ON position, five upper rear lamps (**B**) turns on.

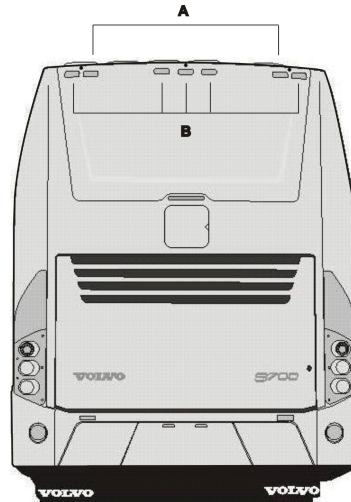

W0089559

Switches

The number of switches depends on the bus specification.

Main Switch

The bus is equipped with a main power switch. By switching off the main power before leaving the bus, all the major electrical consumers are switched off, which helps to preserve sufficient battery capacity to enable subsequent bus starting. The main switch does not cut off the power supply to the clocks and auxiliary heater.

Note: Never turn off the main switch while the engine is running.

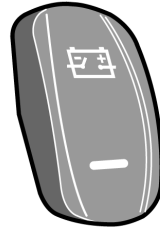

T0012043

32 Instruments and Controls

Emergency Stop

Note: Only use the emergency cut out in an emergency situation; to switch off the electrical feed in normal conditions use only the main switch.

When the emergency stop is activated the following occurs (can vary from country to country):

- air is exhausted from the door system
- engine is stopped
- power supply to the main electrical consumers is cut off
- fuel supply to the engine is cut off and so is outflow of fuel from the tanks
- hazard lights are switched on
- lights above the doors are switched on

Activate the emergency cut out by lifting the cover upwards and pressing up the switch. When the cover is closed the power switch automatically is pressed down to the disconnected position.

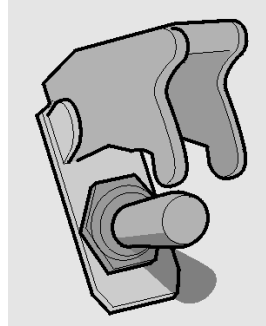

T0009170

Kneeling

This switch allows the right-hand side of the bus to be lowered (kneeling) to a level that facilitates passenger entry and exit.

There are two possible operating modes for the kneeling switch:

- 1 The bus lowers while the kneeling switch is depressed. After reaching the lowest level, i.e. entry/exit level, kneeling stops and the switch can be released. Releasing the switch prior to reaching the lowest level causes the bus to return to the normal ride height.
- 2 Pressing the switch once lowers the bus to its lowest level for entry/exit.

When kneeling function is active, an icon in the instrument cluster lit and a blinking lamp is activated at the door as well as an acoustic signal

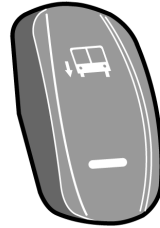

T0012054

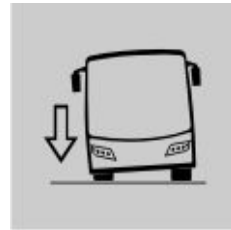

W0081879

Various ways to resume normal riding height:

- Pressing the upper part of the switch
- Closing the door
- Starting the bus and accelerating beyond 5 km/h (3 mph) road speed (only buses without door brake)
- Restarting the engine

Conditions for kneeling:

- Engine running (vehicle stopped)
- Without extra step



DANGER

Ensure that the bus can kneel without the risk of trapping passengers' feet between the door sill and the curb. Failure to do so may result in serious personal injury.

34 Instruments and Controls

Level Control

The ground clearance of the bus can be adjusted with this switch.

- to lower the bus press the lower part of the switch, e.g. while passing under a low bridge.
- to raise the bus press the upper part of the switch, e.g. while driving onto a ferry.

Note: Levelling control should only be used temporarily. During normal driving the switch **must** be in the middle position.

When the bus reaches the selected level a symbol is shown on the display panel.

The suspension system attempts to keep the bus at a constant ride height independent of the load. Any faults in the system are indicated by a symbol on the display panel.

Note: If the pneumatic suspension of the bus is in the highest or lowest position and if the bus speed exceeds 12.4 mph (20 km/h), accelerator will be disengage.

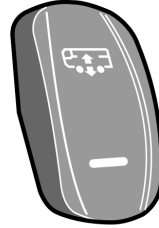

T0012058

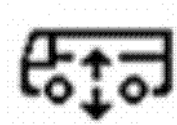

W0096368

Air suspension system is working.



T0012224

Low pressure in the air suspension system.

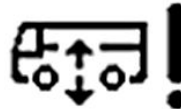

T0012467

Fault in the air suspension system.

Increasing Load on the Driving Axle (trailing axle lift)

The drive axle load is increased by pressing this switch. Increase in drive axle load is often an advantage when moving on slippery surfaces.

Pressing this switch increases the load on the driving axle by removing the suspension load on the trailing (non-driving) axle.

The unweighting continues until one of the following takes place:

- speed of the bus rises above 30 km/h (20 mph)
- the switch is pressed again

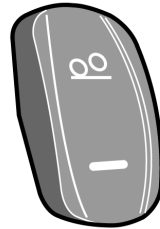

T0012046

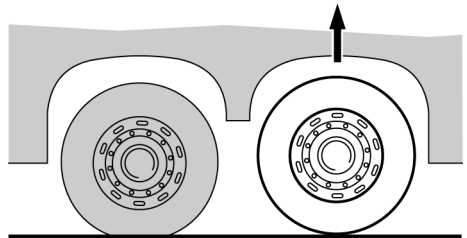

T6009559

36 Instruments and Controls

Traction Control System (TCS)

The TCS system automatically reduces the driving torque of the engine if the drive wheels start to spin.

At speeds below 40 km/h (25 mph) the TCS system also acts as an automatic differential brake, braking the driving wheel that begins to spin.

For more information, see separate driver instructions “EBS”.

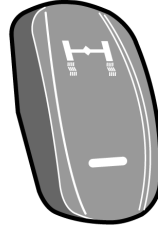

T0012059



CAUTION

Turn off the TCS before towing. Failure to do so may result in damage to the system components.

Differential Lock

Differential lock allows drive axle shafts to be connected together. The wheels then rotate at the same speed, which makes driving on slippery surfaces easier.

The differential lock is only to be used on slippery surfaces. Engage as soon as the bus is on the slippery surface. It can be coupled in during driving, at any speed, but will not actually engage until the bus is travelling at less than 15 km/h (10 mph).

Do not forget to disengage the differential lock when you have left the slippery surface! For more information, see separate driver instructions “EBS”.

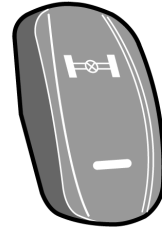

T0012041

3 stage switch for the manual/automatic coupling of the differential lock.

 CAUTION
<p>The differential lock is only to be used on slippery surfaces. Other uses may result in damage to the drive axle.</p>

Hill Start Assistance

This function helps the driver to pull away on inclines by holding the bus still until the required torque at the wheels is applied.

This function's mode of operation depends on whether the bus is equipped with a manual or automatic transmission. Additional information, see separate Operating Instruction “EBS”.

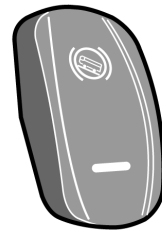

T0012045

Passenger Compartment Lighting

This switch turns on the passenger compartment lighting as follows:

Press button once— after 3 seconds, all lamps will illuminate at 50% intensity.

Press twice— after 3 seconds, all the passenger compartment lights will illuminate at 100% intensity.

Press three or more times — switching between interval of 3 seconds the light intensity decreases from 100% to 50% and vice versa.

Press and hold button for 3 seconds — to turn off passenger compartment lighting.

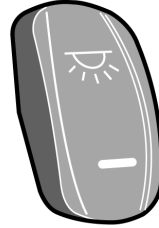

T1008556

Night Lighting (Option)

This switch has two positions, ON and OFF. Activation of the night lighting turns on the lamps illuminating the gangway, which are located under the seats.

When the night lighting is on, the passenger compartment lighting level is dimmed to 30% regardless of the positions of the other switches.

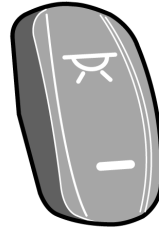

T1008549

Half-Light

Switches on blue lights around reading lights. Press once — to turn on only the blue lights in the passenger compartment.

Press twice — to turn on the blue lights in the driver's compartment.

Press three times — to turn on all the blue lights.

Press and hold for 3 seconds — to turn off all the blue lights.

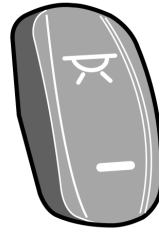

T1008549

Driver Compartment Lighting

This switch has three positions as follows:
 Position I — or bottom position, all lighting is OFF.
 Position II — or middle position, the lighting is OFF if the door is closed, but the lighting is on if the door is open.
 Position III — or top position, the lighting turns on without any restriction.

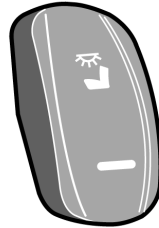

T1008557

Passengers' Individual Lighting

Enabling/disabling of the passengers' individual lighting. Lamps are located in the panels above the passenger seats. See "Passengers Panel", page 73.
 Position I - or bottom position all lamps are turned on, which is useful for example when checking whether all bulbs are OK
 Position II - or middle position all lamps are turned off.
 Position III — or top position every passenger can individually turn on the lighting with the push-button on the panel.

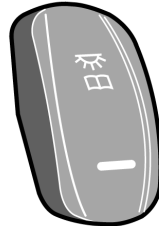

T1008548

40 Instruments and Controls

Rear Door Lighting

When this button is activated, the entrance lighting of the rear door switches on when it is open.

In some buses there is a double-position control. It operates as follows:

Position I — the light switches on when the door is open.

Position II — the lighting switches on when reverse gear is selected.

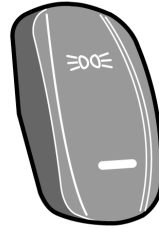

T3019957

Position Lights

This switch allows the creation of signs with position lights.

If the position lights are off, press and hold the switch to turn on the position lights.

If the position lights are on, press and hold the switch to turn off the position lights.

Press and depress and so on for position lights blinking

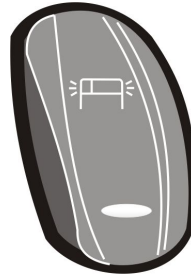

T0015279

Destination Sign Lighting (option)

This switch has three positions as follows:

Position I — or bottom position, destination sign lighting is off.

Position II — or middle position, destination sign lighting turns on when parking lights are on.

Position III — or top position, lighting turns on when the ignition switch is in position II.

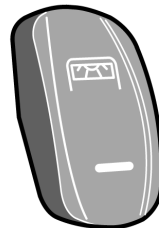

T1008545

Electrically heated rear—view mirrors

Pressing the button switches on the heating for 8 minutes.

Heating can be used to remove water droplets and ice from the mirror glass. Make sure the mirrors are free of mist or ice when driving.

Note: On some buses this switch, besides heating the rear-view mirrors, also switches on heating of the driver's window and front door window.

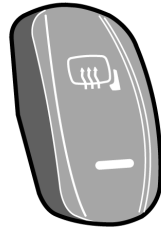

T1008551

Driver's window heating

Pressing the button switches on the heating for 8 minutes. Pressing the button again switches off the heating.

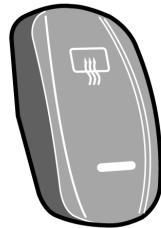

T1008580

42 Instruments and Controls

Driver's Blower

Switch for the driver's blower.

It turns on/off two small fans located on the top of the driver's and guide's seats. Push the switch to turn on both fans and push again to turn off.

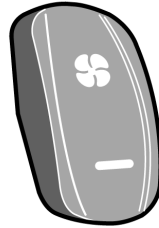

T1008550

Central Locking

This switch locks/unlocks all luggage compartment hatches.

Additionally this switch turns on the luggage compartment lights (Luggage compartment lighting turns off after 10 minutes of luggage hatches stills opened).

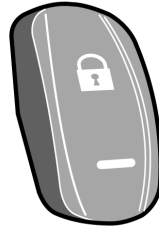

T1008543

Sun Visor

This switch facilitates lowering and raising of the front sun visor as follows:

- Lowering — Press at the bottom to low the sun visor, depress to stop the movement.
- Raising — Press at the top to raise the sun visor, depress to stop the movement.



T3018180

Driver's Window

This switch facilitates lowering and raising of the driver's window.

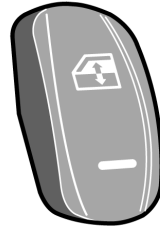

T3018172

Activation of the Toilet

Activates the power for the toilet. For more information, see the separate instructions “Toilet”.

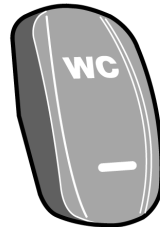

T3018183

Audio System

This switch has two positions as follows:
Position I — or bottom position, enabled radio, CD or mp3 audio for passengers (microphones disabled)
Position II — or top position, enabled microphones (for driver or guide).



W0082466

44 Instruments and Controls

Opening the Doors from the Outside

Allows for the opening of the doors using the external push-button.

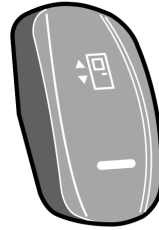

T1008555

Emergency Window in use Indicator Lamp

This lamp lights up to indicate that one of the emergency windows has been opened.

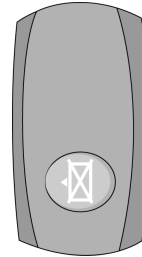

T0015524

Wheel Chair Lift, System (Optional)

Enables Wheel Chair Lift System to be operated by its remote pendant.



W3081609

Wheelchair Lift System Indicator Lights

Upper light indicates the Wheelchair lift system is enabled.

Bottom light indicates wheelchair lift door is ajar.

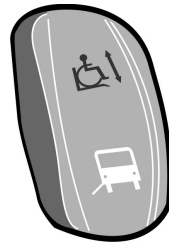

W3081610

46 Instruments and Controls

Switches in the Electrical Center

The Volvo 9700 US/CAN bus is equipped with additional push button switches in the electrical distribution box.

Air Conditioning Test.

Using this switch the driver can check if the air condition is working.

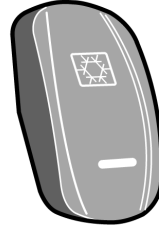

T3018175

Door Brake Switch.

A two position toggle switch with a protective cover is installed in the electrical center enables/ disables the door brake function.

- With the switch in the up position, the door brake is enabled.
- With the switch in the down position, the door brake is disabled.

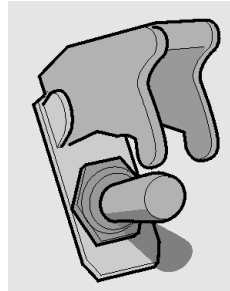

T0009170

Controls

Starting Switch

The ignition switch has four positions:

- 0 **Stop position.**
- I **Intermediate position.** In this position certain electrical devices can be used according to customer requirements.
- II **Drive position.** Between positions II and III there is a spring-return position for preheating.
- III **Start position.** Spring-return.

Note: Removing the key from the starting switch activates the steering lock.

Note: The key can only be removed from the starting switch when it is in the stop position.

Note: Do not remove the key from the starting switch when the bus is being towed!

Note: Always remove the key from the starting switch when leaving the bus.



T0014333

Adjusting External Rear-view Mirrors

Both rear-view mirrors are adjusted using the same switch. The switch can be turned to one of the two positions (adjustment of the right or left mirror). The arrow shows which of the mirrors has been selected. The selected mirror is adjusted by moving the switch in the appropriate direction.

Note: Rear-view mirrors should be adjusted before starting to drive.

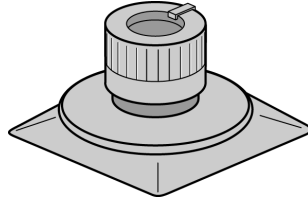

T0014718

Open Door Brake

The open door brake can be activated in various ways, depending on its design and customer requirements. The open door brake is activated only at speeds below 5 km/h (3 mph) if any of the/specified doors are opened. In the event that the door brake is activated, its indicator light comes on the instrument panel.

Note: The open door brake does **not** engage if the brake system registers poor traction when the bus is stopping on a slippery surface. This prevents the bus skidding when stopping on a slippery surface.

Note: The open door brake does **not** engage at speeds over 5 km/h (3 mph).

Open Door Brake Deactivation

- 1 The accelerator must not be active (fully release the accelerator)
- 2 Doors/The specified door(s) must be completely closed.
- 3 The accelerator must be activated again (depress the accelerator again)

In the event that, due to the bus stopping on a slippery surface, the brake system has not activated the door brake, you must brake again (in a place where no slippery surface is detected) to enable this brake to be reactivated.

50 Instruments and Controls

Door Brake Deactivation

This switch is used to disengage the door brake. The switch is located in the electrical distribution box close to the entrance door.

Note: The switch for disengaging the door brake must only be used in emergency, if the bus cannot be moved in the usual way.

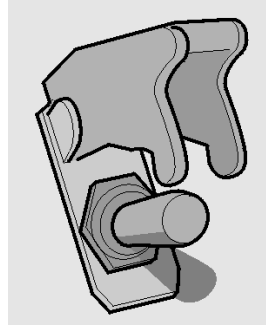

T0009170

Steering Wheel Adjustment

Both the steering wheel height and its tilt allow of continuous adjustment.

Adjust the steering wheel as follows:

- depress the pedal to which the arrow points
- Setting the steering wheel
- after releasing the pedal the steering wheel is locked in its new position.

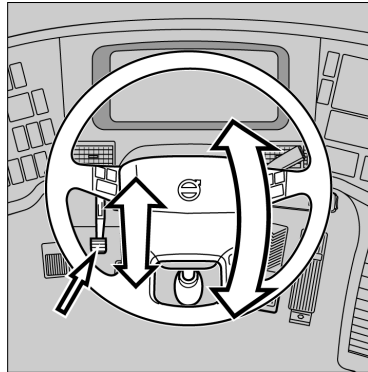

T6010216

DANGER

Steering wheel adjustments should only be performed while the bus is stationary. Adjustments with the vehicle is moving may lead to an accident, resulting in serious personal injury or death.

Directional indicator, Dipped/full beam changer

1 Location of point of resistance.

When making maneuvers requiring only slight movements of the steering wheel (changing lanes, overtaking), move the stalk up or down and hold it there. After releasing the stalk, it will immediately return to its neutral position.

2 Move the stalk beyond the resistance point.

The directional indicators will continue to flash until the stalk is manually moved back to the neutral position, or the steering wheel is returned to the straight ahead position after the turn.

3 Main beam “flash”.

Pull the stalk towards the steering wheel (until you feel slight resistance). The main beam will stay lit until the stalk is released.

Main/dipped beam switching (lights on).

Pull the stalk towards the steering wheel beyond the “flashing point” and release it. Each time you do this, the headlamps will toggle between main and dipped beam.

In addition, engine idling speed can be controlled with this stalk. See: “Low Idle Adjustment”, page 101

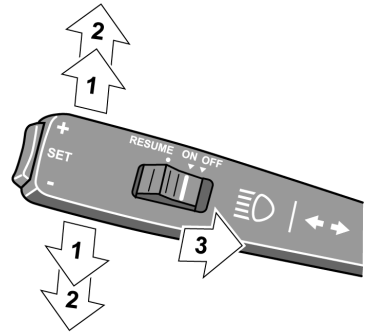

T0012077

52 Instruments and Controls

Windscreen Wipers, Windscreen/headlight Washer

Note: This stalk also provides control of the display, for additional information about display control, see the separate Operation Instruction “Display”.

1 Interval wiping

Used when driving in mist or drizzle conditions.

The wipers make one sweep every 10 seconds. To reduce the time between sweeps, move the stalk to the normal sweeps, move the stalk to the normal position, and then, after the desired time interval, back to the interval wiping position. This permits the wiping interval to be set to any value between 1 and 10 seconds.

2 Flick wipe position.

If you want the wiper to make only one or two strokes (e.g. drizzle), move the lever to the flick wipe position and keep it there with your finger. The wipers will stop in parking position after releasing the lever.

3 Windscreen wipers, normal speed.

4 Windscreen wipers, high speed.

5 Windscreen washers + headlight washers.

Moving the stalk to this position will also activate the windscreen wipers, which will make an additional 2-3 sweeps after the stalk has been released.

The headlight washers and windscreen washers have a common fluid reservoir.

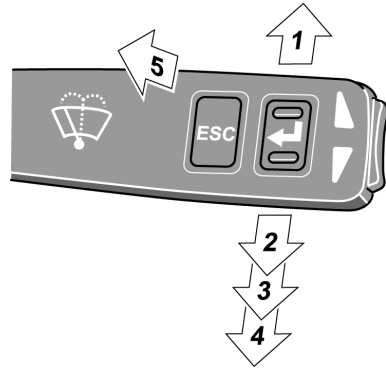

T0012079

Transmission

Transmission, I-Shift Lever Selector.

The Volvo 9700 US/CAN bus may be fitted with an I-shift automatic transmission lever selector.

Both clutch operation and gear shifts are performed fully automatically. If necessary the gears can be changed manually.

By pressing the FOLD button and tilting the lever downwards to the position where the lever is on a level with the seat, extra room may be created for the driver.

For more information, see separate driver instructions “I-shift”.

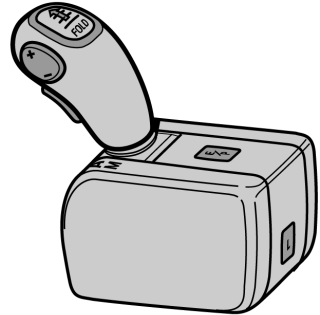

Transmission, I-Shift Pad Selector.

The Volvo 9700 US/CAN bus may be fitted with an I-shift automatic transmission pad selector.

Both clutch operation and gear shifts are performed fully automatically. If necessary the gears can be changed manually.

The push-button shift selector has four positions: R, N, D and M.

- R — Reverse: Vehicle must be stationary when selecting R.
- N — Neutral: No gear engaged.
- D — Drive: Automatic drive mode. The transmission will select most suitable gear for running conditions such as load, speed, accelerator pedal position, hill climbing, etc.
- M — Manual Program: Changing up and down is done with the + and — buttons.

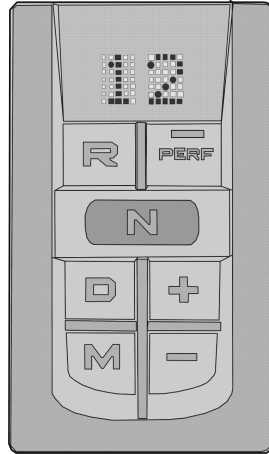

W0089562

Allison, automatic transmission (Optional)

Volvo Bus 9700 US/CAN can optionally be equipped with automatic transmission Allison 4000 Series model 6B500, which is an automatic transmission with 6 forward speeds and reverse.

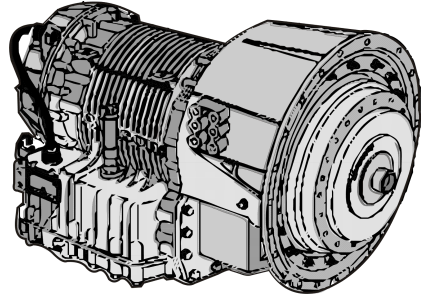

W0095730

Allison transmission, pad selector

The Volvo 9700 US/CAN bus may be fitted with an Allison automatic transmission shift pad selector.

The push-button shift selector has four positions: R, N, D and Mode.

- R — Reverse: Vehicle must be stationary when selecting R.
- N — Neutral: No speed coupled.
- D — Drive: Press this button to select Drive function, the highest forward range available will appear in the digital display window under SELECT. The transmission will start out in the lowest available forward range, displayed under MONITOR, and advance automatically to the highest range.
- + or — buttons: Press respectively the (Upshift) or (Downshift) arrow button when in DRIVE to request the next higher or lower range. One press changes speeds by one range. If the button is held down, the selection will scroll up or down until the button is released or until the highest or lowest possible range is selected. Protection mechanisms inhibit selecting ranges that are not appropriate for the current speed or which may damage driveline components.

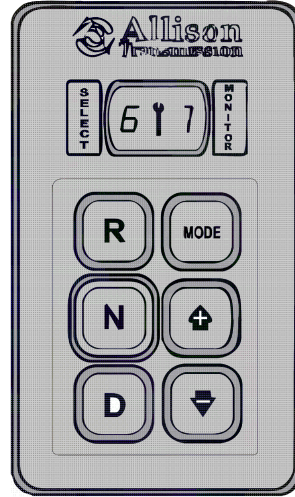

W0095731

Allison transmission, pad selector

- Mode — The MODE button can allow the driver to enable a secondary shift mode that has been programmed into the TCM (Transmission Control Module) unit. Pressing the MODE button activates the PERFORMANCE shift schedule and illuminates the mode indicator (LED).

Allison transmission, Mode function

The MODE button have the following function. Both ECONOMY (default mode at starting of the engine) and PERFORMANCE (secondary shift mode) modes are equivalent from the first to the fourth gear as the transmission upshifts at around 2000 rpm.

The ECONOMY mode allows for upshifts in fifth and sixth gear at around 1700 rpm. This is a more efficient operation of the transmission and thereby helps improve fuel economy.

The PERFORMANCE mode keeps upshifts at 2000 rpm in fifth and sixth gears. This makes for better performance than the economy mode but with higher fuel consumption. It is recommended this mode be selected while driving up or down grades. The mode indicator (LED) is illuminating when PERFORMANCE mode is selected.

When a button is depressed on the transmission control pad, the corresponding letter or number is displayed indicating the transmission is ready to operate in the selected range. If the transmission control module (TCM) detects a serious problem in the transmission, the "CHECK" telltale light will illuminate on the dashboard. For more information see the separate operation instructions in the “Allison Bus Series Operator’s Manual ”.

Retarder (if installed)

The transmission can be equipped optionally with a hydraulic retarder, which helps to brake the bus reducing the load on the brakes as a result. It is automatically engaged by the initial movement of the foot brake pedal, even before the wheel brakes are engaged.

Note: The retarder brakes only the driving wheels. If the bus is fitted with the Anti-Lock Brake system (ABS), the retarder is automatically disengaged on any signs of the wheels locking. When the retarder is active, its symbol is shown on the display.

The retarder can be disabled by pressing its switch on the dashboard.

Note: Under normal driving conditions, the retarder should not be disabled.

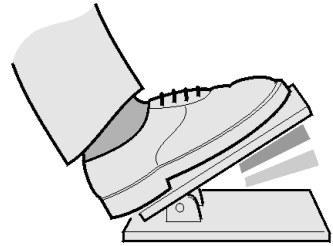

T0009004



T3018117

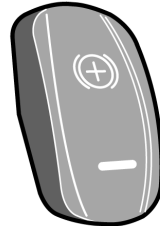

T1008547

 <b style="font-size: 1.2em; margin-left: 10px;">DANGER
<p>Avoid using the retarder on slippery roads because of the risk of locking the wheels and skidding (the retarder brakes only the driving wheels). Failure to do so may lead to an accident, resulting in serious personal injury or death.</p>

Retarder Overheating

Note: Just apply, if the coach equipped with the hydraulic retarder.

If the retarder remains engaged for a long time (e.g. during a long downhill stretch) it may overheat, causing an increase in retarder oil temperature.

The first indication of retarder overheating is the “CHECK” lamp lighting and the temperature symbol showing up on the display. If this happens, select a lower gear and make greater use of the main brakes.

If the temperature continues to rise, the red “STOP” lamp will light and there will be an increase in the temperature accompanying the symbol on the display. Stop the bus as soon as possible and select neutral, i.e. N. To increase the circulation of the coolant run the engine at higher idle until the temperature returns to the normal level.



T3014365



T3008844



T3014364

 CAUTION
Do not switch off the engine before the temperature is back to normal. Failure to do so may result in component damage.

Transmission Overheating

If the transmission overheats, the “CHECK” lamp will light and the display will show a red symbol.

If the temperature rises further, the red “STOP” lamp will light. Slow down and stop the bus as soon as it is safe to do so. Contact Service for advice.



T3014365



T3014364



T0008817

62 Instruments and Controls

Brakes

Parking Brake

The parking brake acts on the drive wheels. When the hand control is in the forward position with the compressed air system charged and the blocking valve depressed, the parking brake is released.

When the parking brake hand control is moved backwards, the parking brake is gradually applied. It is fully applied when the hand control is in its backmost, locked position.

To release the parking brake hand control from the locked position, lift the ring upwards and move the lever forwards.

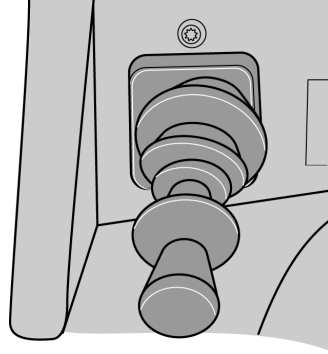

T5014881

DANGER

Never leave the bus without engaging the parking brake. Failure to do so will prevent the bus from staying stationary leading to an accident that may result in seriously personal injury or death.

DANGER

Never start driving while the brake system warning lamp is still lit. Failure to do so may result in serious personal injury or death.

DANGER

If the warning lamp lights while driving, stop the bus immediately. Failure to do so may result in serious personal injury or death.

Emergency Brake

To use the parking brake as an emergency brake, move the lever gradually backwards to the parking position. Keep the catch pulled in all the time, or the control will fasten in the locked position.

Note: The parking brake is only to be used for parking or as an emergency brake in case of malfunction of the foot brake system. The parking brake only brakes the drive wheels, the braking distance will be longer than when using the foot brake. There is also an increased risk of skidding because only the drive wheels are used for braking.

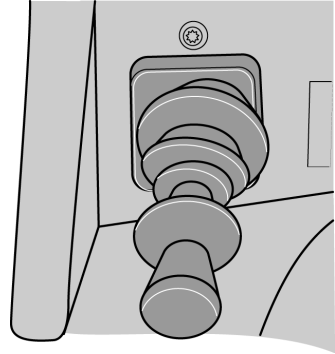

T5014881

Blocking Valve

If the brake system at any point in time is emptied of air, for example — the bus standing parked for a longer time period, the parking brake cannot be released.

To release the parking brake you must first start the engine and wait until the brake system warning light has gone out. Then press the blocking valve.

Even if the hand lever for the parking brake has been moved to the forward position, the brake will not be released until the blocking valve has been pressed in.

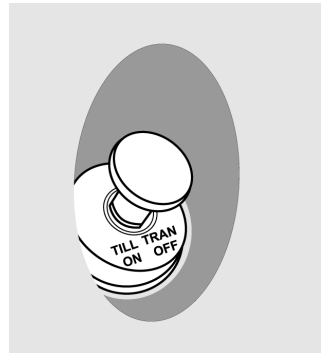

T0015484

Service Brakes

The bus is equipped with an EBS brake system (Electronically-controlled Braking System). This system monitors and controls brake operation. For additional information concerning the EBS system, refer to the separate Operating Instruction “EBS”.

If the main brakes are used without care when driving down steep and long inclines, they will heat up very quickly to extreme temperatures. The low speed that is generally the rule in such cases means that the brakes are not cooled as efficiently as when driving on level roads.

When driving downhill, in the first instance use the retarder brake, and only supplement this with the main brakes as necessary. For additional information about the retarder, see “Retarder (optional)”, page 103.

If you have to use the footbrake while driving downhill, do not pump the brakes, as this will only use up compressed air. Brake sufficiently hard, and then release the brake pedal completely, or just to the pedal position where only the retarder is engaged. Heat builds up very quickly in the brakes, causing increased wear of the brake linings and reduced brake efficiency.

The main purpose of the EBS system is to increase road traffic safety by shortening braking distances.

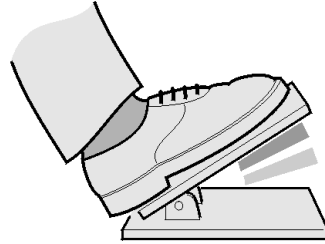

T0009004

Dark zone — only retarder

Light zone — retarder and foot brake



T0009682



T3008834

EBS controls the ABS and ASR braking forces. It is fitted only on buses with disc brakes. ABS is a part of the EBS system and works completely automatically. The ABS (Anti-lock Brake System) prevents the wheels from locking up during braking. In case of ABS failure, the appropriate symbol appears on the instrument panel.



T0009682

Note: ABS efficiency is limited. Remember, that on slippery surfaces ABS will not shorten the braking distance significantly. It can nevertheless help in avoiding obstacles during braking.



T3008834

66 Instruments and Controls

Compensating for Differences in the Wear of the Brake Pads

If the brake pads on one of the axles wear down faster than those on the other, braking force is redistributed so that a greater portion of the braking force is applied to the wheels on the axle with less wear.

Note: This function activates when braking lightly. During hard braking the braking force is distributed so as to achieve the most efficient braking.

When the thickness of the brake pads is reduced to 20% of the thickness of new pads, a warning symbol is shown on the display.

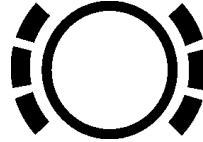

T5013668

DANGER

When brake pad warning symbol is displayed, immediately proceed to the nearest service station to replace the brake pads with new ones. Driving any further with worn out brake pads may lead to losing control of the vehicle and cause an accident resulting in serious personal injury or death.

Brake temperature High Warning

If the temperature of the brakes increases too much, the “CHECK” lamp lights, and the relevant symbol is shown on the display.

Note: If the temperature is allowed to rise further, maintaining the same braking force will require increased pressure on the brake pedal.



T5013670



T3014365

A/C Controller

The Volvo 9700 US/CAN bus is equipped with an AC controller to maintain a constant temperature inside the bus.

For more detailed information, see separate instructions “AC controller”

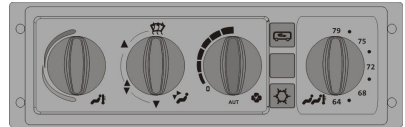

T8061140

Destination Sign (Optional)

The Volvo 9700 USCAN bus may be fitted with a two optional high definition destination signs, Mobitec or Innova. For use, follow the instructions below:

Destination sign Mobitec

- Destination text selection: Press the “check mark” button, the value of the digit to be changed will flash. Use the “up” and “Down” buttons for increase or decrease the value of the digit to change. Use the “Left” and “Right” buttons for change the digit to modify.
- Extra text selection: Press the “check mark” button for enter to the destination text selector mode. Press the “right” button for change the extra text. Use the “Up” and “Down” buttons to increase or decrease the value of the digit to change. Use the “right” or “left” buttons to change the digit to modify.
- Departure time selection: Press the “check mark” button for enter to the destination text selector mode. Press the “right” button for change the departure time text. Use the “Up” and “Down” buttons to increase or decrease the value of the digit to change. Use the “right” or “left” buttons to change the digit to modify.

After to each configuration (departure time, destination and extra text informations), press the “check mark” button to confirm or the “cross” button to cancel. For more information see the separated user manual provided by **Mobitec**.



W0097186

Mobitec Destination Sign Digital Control



W0097187

Destination display selector

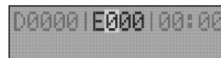

W0097188

Extra text display selector



W0097189

Departure time display selector

Destination sign Innova

- Destination text: Press the (1) button and then use the buttons (2) or (3) until the route message adjust function appears in the display by the next following name "RUTA"; Then press the (4) button to enter this function. In this function, use the buttons (2) or (3) to select the wanted destination text and press the (4) button for insert your selection. Press the (1) button to return the main menu.
- Extra text: Press the (1) button and use the buttons (2) or (3) until the extra text function appears in the display by the following name "Extra". Then press (4) button to enter the function. The "P-01" message in the display will appear, press (4) button to confirm the selection and "P-ON" message will appear in the display, use the buttons (5) and (6) to insert the wanted extra text that you want. Press (4) button and the message "01:ON" appears. Use the buttons (5) and (6) to adjust the exposure time of the extra text. Press button (4) for apply the adjustments and return to the main menu.
- Departure time: Press the (1) button and use the buttons (2) or (3) until the departure hour function appears in the display by the following name "HrSd". Then press the (4) button to select the function and use (2) and (3) buttons to adjust the time hour, press (4) button to entered the time hour, now again use the (2) and (3) buttons to adjust the time minutes, press (4) button to entered the time minutes and return to the main menu.

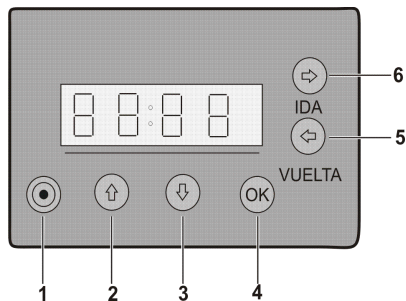

W0091881

For more information, see separated user manual provided by **Innova** .

70 Interior Equipment

Interior Equipment

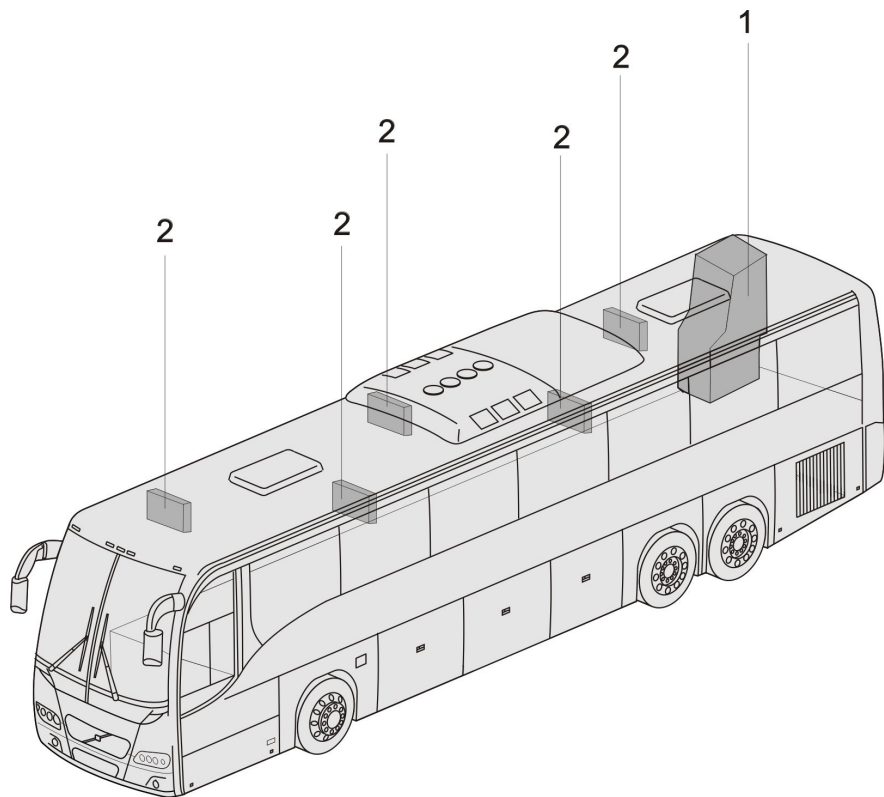

W0089616

To enhance travel comfort, the bus may be fitted with additional interior equipment such as:

- 1 Toilet
- 2 Monitors

Toilet

The Volvo 9700 USCAN bus is equipped with a toilet, located on the right-hand side at the rear of the vehicle. Pressing a switch on the dashboard enables the toilet to be used, by releasing its central lock and switching on the toilet power supply.

While the toilet is occupied (after locking the door) a sign lights up in the passenger compartment.

In the toilet compartment there is an emergency push-button with backlight. After it has been pressed, the toilet indicator lamp flashes on the dashboard.

For additional information and instructions regarding the servicing and maintenance of the toilet, see the separate Operating Instructions “Toilet”.

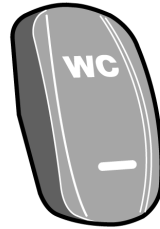

T3018183

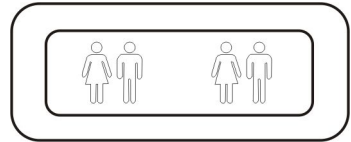

T0015272

Basket integrated in the rear interior panel

The Volvo 9700 USCAN bus is equipped with an integrated interior rear panel basket, located at the bottom of passenger's lounge, beside the toilet.

For more information regarding access and maintenance of the basket, see the separate instructions “Toilet”.



W0095904

72 Interior Equipment

Passenger's Clock Display

The bus is equipped with a clock display located on the front of the passenger's cabin roof.

Display shown:

- Time.
- Date.
- Toilet occupied.
- Toilet unoccupied.

For more information, see the separate instructions "Passenger Compartment Clock".

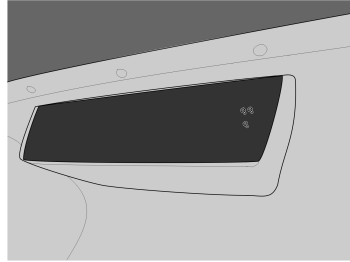

W3081817

Passengers Panel

Above every pair of passenger seats there is a passenger panel. On each panel there is:

- 1 Left Reading Light ON/ OFF.
- 2 Right Reading Light ON/ OFF.
- 3 Loudspeaker ON/OFF
- 4 Not in use.
- 5 Reading Light.
- 6 A/C Outlet Grill.

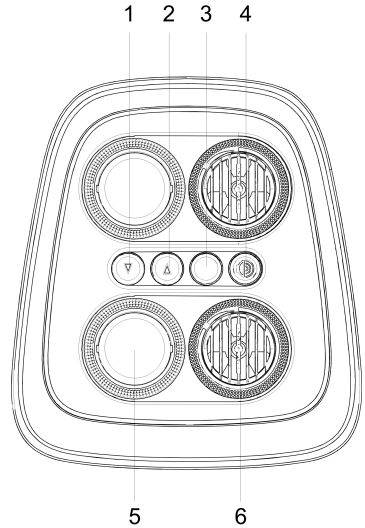

W3081339

Lighting Stripe LED

The Volvo 9700 US/CAN bus is equipped with a lighting stripe LED (1) mounted on each passenger's panel. The stripe illuminates 100% when the main switch is turned on and when the parking brake is released, the stripes dim at 50%.

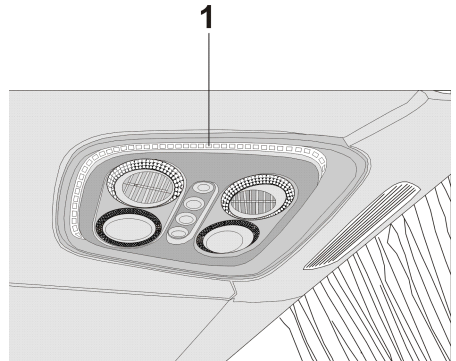

W0089617

74 Interior Equipment

Passenger's AC 110 V Power Outlets

For each pair of passenger's seats there are two power outlets to connect:

- Cell phone charger.
- Laptop.
- MP3 player

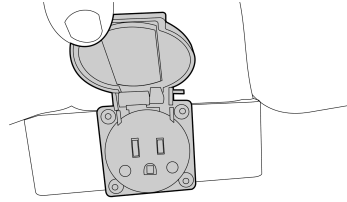

W0096345

Passenger's AC 110 V Power Outlets Circuit Braker



WARNING

Do not connect high power consumption electrical devices such as: Hair dryers or curling iron or similar electrical equipment, if this equipment is connected to the power outlets system, it may cause damage to the electrical system of the bus.

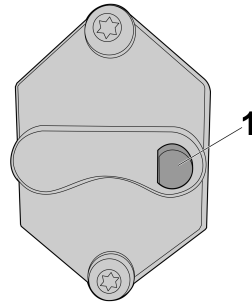

W3081815

In case of an electrical overload, the system is equipped with a thermally protected circuit breaker, which disables the electrical power outlet system. The operator can reset the system by pressing the blue button (1) integrated into the protection device. The protection device is located in the lower center console of the dashboard.

TGW (Telematics Gate Way) system and Liaison communication system

The Volvo 9700 US/CAN bus are equipped with a TGW system using the new 3G protocol communication.

For USA and Canada markets the coach using the Liaison communication software, which use the TGW-3G system architecture components.

The TGW-3G is a electronic control module used for data logging and communication between the vehicle and fleet manager computer. The main functions for TGW are as follows:

- Functions as a gateway for remote services. GSM (Global System for Mobile Communications) / GPRS (General Packet Radio Services) / 3G and WLAN.
- Gather and transmit vehicle and driver data that has been logged in other vehicle units.
- Geographic positioning of the vehicle (GPS).
- Functions as a computer interface for third party file transfers.
- Functions as a gateway for AIC to the vehicle network.

TGW also has a SIM (Subscriber Identity Module) reader and a USB interface. TGW is connected to:

- The vehicle's electrical and electronic systems.
- AIC

Note: For more information to the Liaison communication system, see the separate instructions “Liaison 2.0 Communication system”.

76 Interior Equipment

Passenger's sliding seats

Note: Apply only for a Wheel Chair Lift coach version.



CAUTION

The edges of the pedestal need to be aligned with the arrows on the lateral plate, to properly secure the seat retainers pressing pedestal pedals. Do not try to press down the pedestal pedals if the pedestal is not aligned with the arrows, because the seat retainers does not applies properly.

Only buses equipped with WCL (Wheel Chair Lift) have four pairs of folding and sliding passenger's seats and two pairs of folding passenger's seats, which use when required accommodate a person in a wheelchair. For more information to operate the folding and sliding passenger's seats, see separate operating instructions: "Wheel Chair Lift."

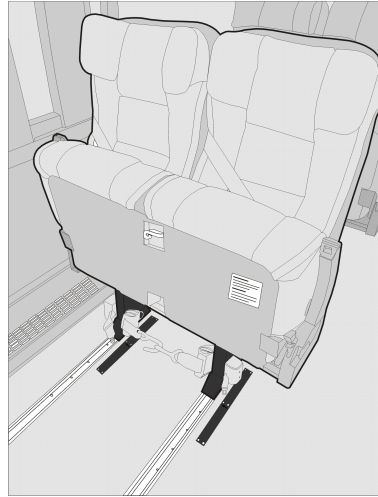

W0089974

Control pendant (for Wheel Chair Lift)

The wheel chair lift is operated with a hand-held, hard-wired remote-control pendant. This Control Pendant is located on the left side from the Wheelchair Lift.

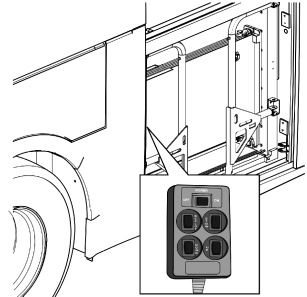

W9089525

The control pendant for Wheel Chair Lift have the following buttons:

- Power switch — Turn ON the Wheel Chair Lift equipment.
- Deploy — Extends the platform from the storage compartment.
- Stow — Retracts the platform back into the storage compartment.
- Down — Lowers the platform towards the ground.
- Up — Raises the platform towards the vehicle floor.



W0095900

For more information, see separate operating instructions: “Wheel Chair Lift”.

78 Audiovisual System

Audiovisual System

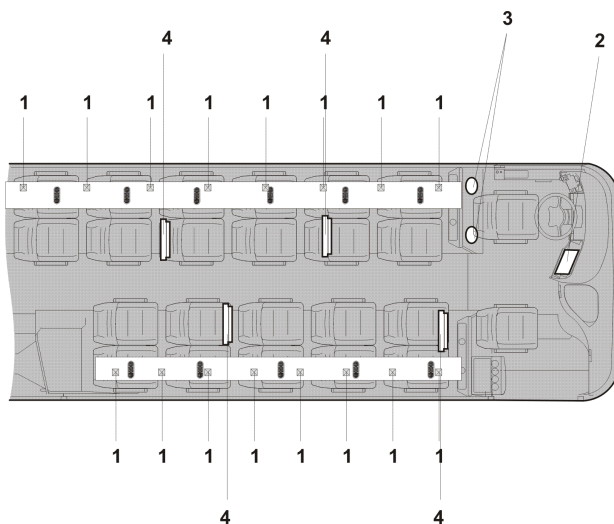

W0089970

To enhance the comfort of the passengers during journeys, the Volvo 9700 US/CAN bus is equipped with an audiovisual system, whose main components are:

- 1 Loudspeakers in the luggage racks
- 2 CD, DVD player
- 3 Driver's loudspeakers
- 4 LCD monitors

Audiovisual Controller

The Volvo 9700 US/CAN bus could be equipped with main unit, giving the driver complete control of the system. See separate Operating Instructions: “Bosch Multimedia System”.

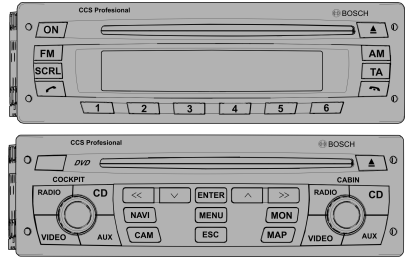

W8081374

Video System

There are four or five LCD monitors in the bus. They are activated by selecting the VIDEO signal source on the audiovisual controller. See separate Operating Instructions. “Bosch Multimedia System”.

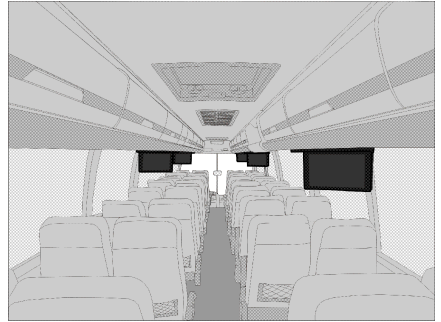

W0089755

Audio System

The main elements of the audio system are:

- Radio
- CD player
- USB mp3 input
- Loudspeakers

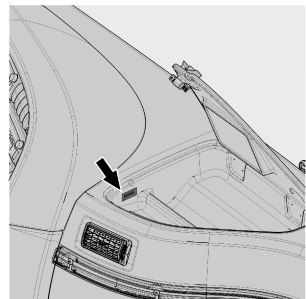

W8081636

USB port to connect a pendrive with MP3 or a plug to charging other devices

80 Emergency and Safety Equipment

Overview

As the driver you must always be familiar with the location of the emergency equipment in the bus, and how to use it.

It is essential that all emergency equipment is checked on a regular basis to make sure that it is in working condition and in place. The location of the safety equipment and its scope can vary, depending on the regulations in the country in question. Therefore make sure that you know where the equipment is and check that nothing is missing.

Fire Extinguisher

The fire extinguisher is located in the front of the bus (most often mounted under dashboard on the right-hand side).

The fire extinguisher can be used to put out fires in volatile fluids, wood, fabric, paper and electrical equipment. Check regularly that the pressure gauge indicator is in the green zone.

How to use the fire extinguisher:

- 1 Remove the fire extinguisher from its holder.
- 2 Hold the extinguisher by its handle with one hand, and pull the safety pin with the other.
- 3 Point the rubber hose at the heart of the fire and press the trigger.

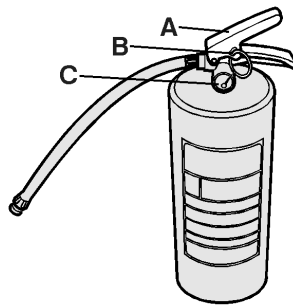

T0008196

- | | |
|---|----------------|
| A | Trigger |
| B | Safety pin |
| C | Pressure gauge |

Automatic Fire Suppression System

The bus is equipped with an Automatic fire detection and suppression system (AFSS) . This system provides continuous monitoring of the hazard areas of the engine bay. It responds to fires fueled by diesel, oil, lubricants and another flammable liquids.

If a fire is detected, the system will alert the driver with both audible and visual alarms while immediately shutting down the Air Conditioning system. A time delay allows the driver the capability to bring the vehicle to a safe stop prior of the activation of the fire extinguisher and engine shutdown.

Note: If additional time is required the timer can be reset by pressing the

For more information see separate operating instruction “Automatic Fire Detection System”.

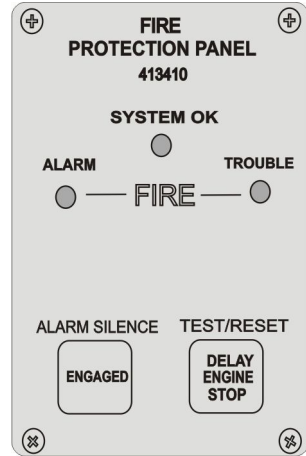

T8061163

82 Emergency and Safety Equipment

Manual Discharge

In the event of fire:

- 1 Twist and pull tamper seal to remove
- 2 Lift cover
- 3 Push red button

If the driver activates the Manual discharge switch the following will occur:

The “FIRE” alarm lamp will illuminate and the alarm buzzer will sound

The extinguisher will discharge

The engine will shutdown

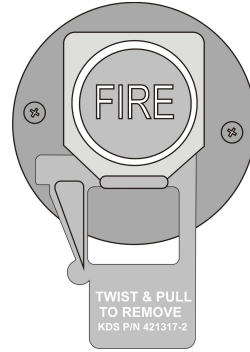

T8061299



CAUTION

Service fire suppression system before restarting equipment.

Warning Triangle

The warning triangle is located either in the toolbox, or in a holder to the right of the driver.

The warning triangle is used whenever a fault forces the bus to stop in a hazardous location. Switch on the hazard warning lights and place the warning triangle at a distance stipulated by the traffic regulations of the country in question.

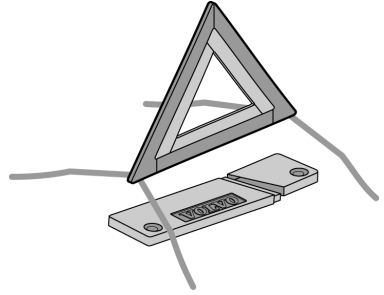

T8011683

First-aid Kit

The first aid kit contains basic first aid materials.

For location of the first aid kit: see the markings inside the bus.

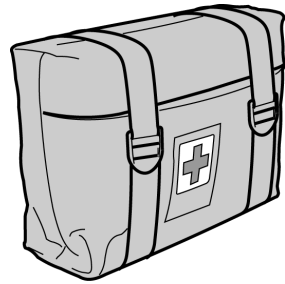

T1008716

Park Pilot System (optional)

The park pilot system, is a bus parking assistant with four ultrasonic sensors and helps the driver to reduce the potential collision risk with the obstacles or other vehicles when parking maneuvers are performed.

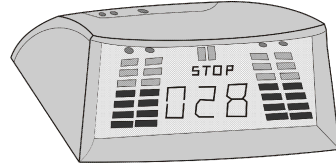

W0095901



WARNING

The Park Pilot System does not replace the use of the rear view mirrors and drive the vehicle so cautious.

The system consist of the following elements:

- Electronic control unit, (ECU).
- Driver's display.
- Four ultrasonic sensors.

The system detects the distance between the rear bumper and an obstacle through its four ultrasonic sensors (mounted in the rear bumper). These sensors generate a signal, which is shown on the driver's display and inform the driver the distance with respect to an obstacle, also and a visual LED bars indicator on the display providing graphical information of the distance between the rear bumper and an obstacle and a warning alarm will be heard when the distance to the obstacle is less than 2 meters.

For more information, see the separate operating instructions: "ACTIA, Bus parking assistant".

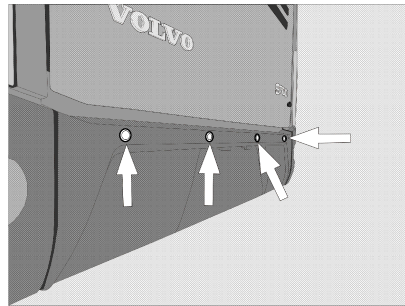

W0090016

Tire Pressure Monitoring System

The Tire Pressure Monitoring System (TPMS) is a sensing device (1) designed to identify and display tire operating data and activate an alert or warning when pressure or temperature irregularities are detected.

Note: Is it responsibility of the driver to react promptly and with discretion to alerts and warnings. Abnormal tire inflation pressures should be corrected at the earliest opportunity.

The system will monitor all vehicle tires plus the spare tire when a spare is supplied. For more information see separate operating instruction “Tire Pressure Monitoring System”.

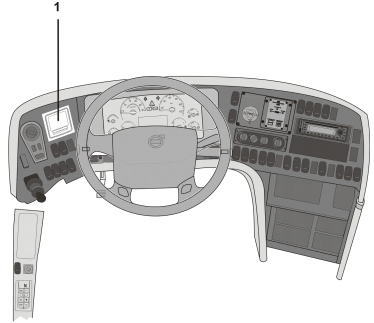

W0089756

Tire Pressure Monitoring System (TPMS) Display

The TPMS Display knows where the sensor are located. It receives the raw temperature and pressure readings from the TPMS receiver, it reads several signals from the vehicle and does the calculation required to generate the various screens.

When no readings have been received for a tire location or when the received data correspond to a parameter range defined as unavailable and appears as two dash lines “_ _”.

The TPMS display is initially configured to define how many axles and running tires are present on the vehicle.

The TPMS display is also configured with several other parameters, including threshold levels for the alarms.

The TPMS display power supply turns OFF when the ignition key is switched OFF.



W0089757

Tire Inflation Valve

Tire Inflation Valve may be used to:

- Inflate a tire using the bus pneumatic system
- Release the parking brake with air from a tire

Its main use is to release the parking brake in a situation when the bus cannot supply its own air, e.g. engine breakdown.

The bus toolbox contains a hose that connects between the tire and the tire inflation valve.

The tire inflation valve is located next to the driver's seat or inside the first service hatch.

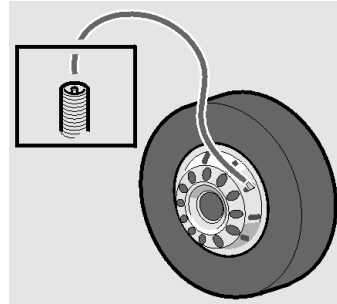

T0009182

External Air Supply Connection

Behind the front hatch there is a valve to which an external air supply can be connected. This could be used when parking the bus overnight, to prevent emptying of the air system.

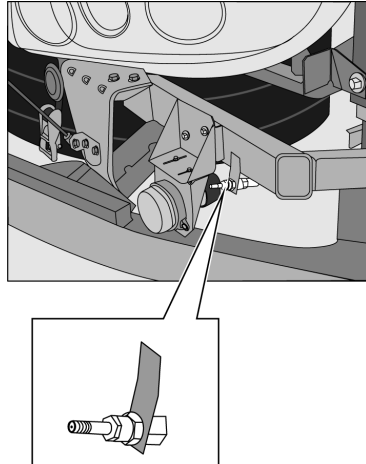

T0015390

Jack

The bus is fitted with special jacking points to comply with safety regulations. For detailed information concerning the use of the jack and changing wheels, see the separate Operating Instruction “Replacement of Wheels, 9700”



DANGER

Always ensure that the bus is standing on a level surface and chock the wheels so it cannot move. Failure to do so may result in serious personal injury or death.

Note: The jack supplied with the bus should be only be used to lift the bus to change a wheel.

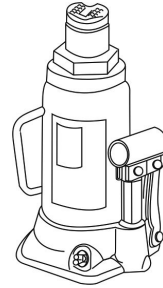

T0015345

88 Emergency and Safety Equipment

Toolbox

The toolbox and tools can be purchased from your local dealer. A complete toolbox contains:

Toolbox	
Item	Part Number
Jack (2 units)	3124497
Adaptor for the jack	3178753
Wheel wrench	9521826
Towing kit	205465449
Hammer	962207
Pumping hose	942868
Warning triangle	3176488
Key for the hatches	70319047
Female key	70344906
Male key	70344905
Pliers	962042
Adjustable wrench	755
Screwdriver with bits	978201
Spare wheel wrench	1062412
Winch handle	1590997
Extension for pumping valve	1621456
Socket wrench 19/24 mm	8189085
Jack extension	1586079
Jack extension	1577686
Wheel wrench extension	20592217
Tool bag	1577384
Wheel chocks (2)	8158698

Engine Control Box in Engine Bay

The engine control box is located behind the engine hatch in the back of the bus. It is used only in conjunction with servicing.

 CAUTION
<p>To avoid accidental engine turning on while you are in the engine bay, the switch (1) must be in position 0.</p>

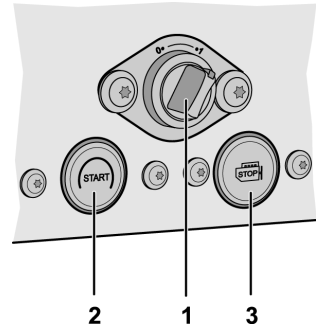

T2023998

The control box has three controls:

1 Start enable switch

When the switch is turned to position **1**, the engine can be started from either the start button on the control box, or the key ignition on the dashboard. When the switch is turned to position **0**, the engine cannot be started from the engine bay, nor from the dashboard.

2 Start button

When switch (1) is turned to position **1**, pressing this button starts the engine. To allow the engine to be started from the control box in the engine bay, the transmission must be in neutral position (N), and the ignition key in the “DRIVE” position.

3 Emergency stop button

To stop the engine press the red button.

Emergency Exits

Doors

There is a valve for emergency door opening above the door. Turning the knob cuts off the compressed air supply to the door.

After turning the valve knob and hence cutting off the compressed air supply to the door, a warning lamp lights up and a buzzer sounds. To return the compressed air system to its normal state, turn the knob back to its initial position and press the appropriate door button on the dashboard.

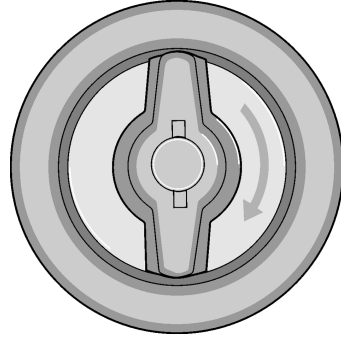

T8009617

Ceiling, Roof Hatches

To open the roof hatch in case of emergency, pull the hatch red handles and push the hatch upwards.

For more information see separate operating instruction “Manual roof hatch operation”.

- From inside, pull the hatch red handles and push the hatch upwards
- From outside, pull the hatch red handles and pull the hatch.

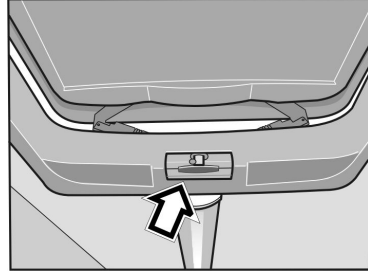

T8010110

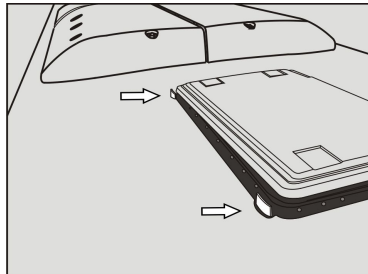

T8061298

Emergency Windows

These windows can be opened from inside the vehicle as emergency exits. A decal on window sills indicates the location of the emergency windows. To open an emergency window, lift the window release bar (sill) and push the window open from the bottom. To close, lift the release bar and pull the window into position. Push down on release bar to lock the window shut.

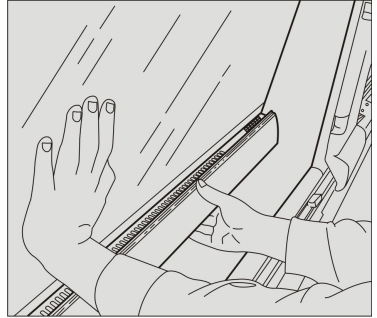

T8061781

Checking Before Driving

Before starting the bus and driving off, check the pressure sensitive edges on the doors. If the door leaf during opening encounters an obstacle, the door should stop. If the door leaf encounters an obstacle during closing, the door should open again. It should not be possible to open the doors by hand while the engine is running.

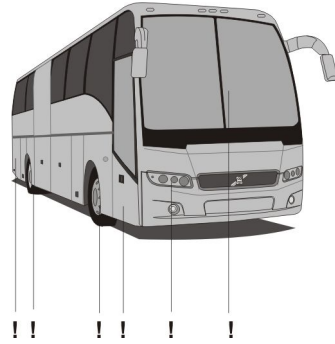

T0015270



WARNING

Make sure that the sensitive edges on the door work prior to vehicle use. Failure to do so may lead to personal injury of passengers.

Make sure that:

- all hatches are closed
- all the lighting is working properly
- the windscreen wipers/washers are working properly
- safety equipment is in place
- the direction indicators and horn are working properly
- the air pressure in the tires is in order (using a hammer) and nothing has got stuck between the back twin wheels.
- destination information and line number are correct
- the emergency opening system for the doors is working properly.
- all emergency windows and roof hatches are properly closed

Cleaning and Maintenance

It's recommended to perform daily or before each trip, the inside cleaning of the bus greater attention especially; the windows, passenger's seats and floor. As well as; should also make s clean for the outside of the bus. With this, will remain the attractive appearance of the vehicle and ensure optimum service life and durability.

Note: Areas subject to heavy passenger use require greater attention on the part of the cleaning team.

For more information, see the separate instructions "Bus Interior Maintenance" and "Cleaning and Maintaining the Paint Finish".

Checking Warning Lights

When the key is in position **I**, the control system checks that all the warning lamps are working properly.

All the warning lamps and the warning LEDs in the instrument cluster are lit for about 5 seconds. The ABS system indicator lamp will light up for slightly longer than the others. If it continues to be lit then a fault has been detected in the ABS system.

Daily Inspection

Engine oil level, as well as the servo fluid and coolant levels in the bus should be checked on a daily basis. The checks are carried out with the engine **warm**, but switched off.

Note: It is a good idea to do these checks after a tour as the engine is then at normal operating temperature.

All tanks are located in the back of the bus.

Engine

When checking the oil level:

- position the bus on level ground.
- if the engine is cold, let it idle for 1-2 minutes
- turn the engine off. Wait at least 2 minutes before carrying out the check
- remove the dipstick and wipe it with a clean cloth
- check the oil level with the dipstick. The oil level should be between MAX and MIN
- top up if necessary.

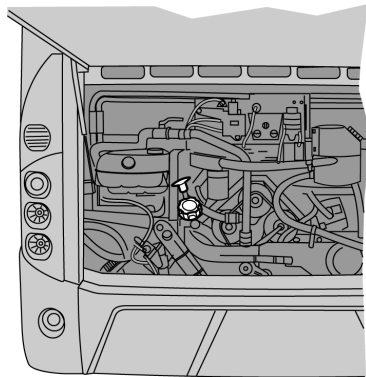

Steering Servo/Hydraulic Fan

Check that the oil level is between the MAX and MIN markings on the reservoir (B). Top up if necessary.

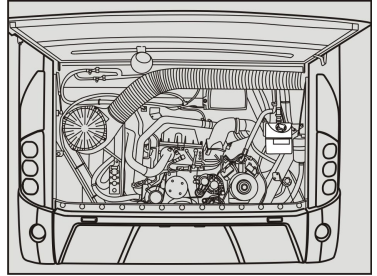

T1061953

Coolant

Check that the coolant level is between the MAX and MIN markings on the reservoir (A). Top up if necessary.

The reservoir is located over the rear engine door.

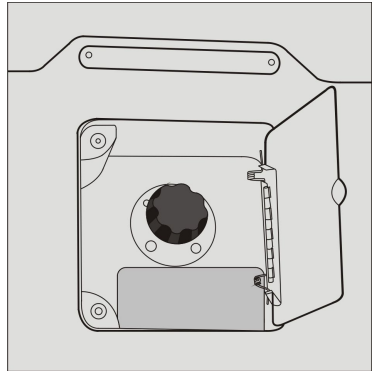

T8061297

Washer Fluid

Check the level of the washer fluid in the reservoir. Top up if necessary.

Note: In winter use appropriate fluid with lower freezing temperature.

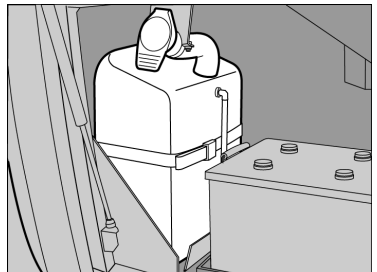

T2024567

Refuelling

Open the flap and the fuel filler cap. Insert the end of the fuel hose into the filler neck. Fill up the tank. After filling up the tank, remove the fuel pipe and put it back on the pump. Close the fuel filler cap and the flap. The Volvo 9700 US/CAN bus has two tanks with 400 liter (105 gallons) capacity each one.



CAUTION

The use of Diesel fuel other than ULSD, will adversely affect performance, efficiency and durability of the DPF system and the engine, to the point where the engine may not run at all. Manufacturer's warranties can also be rendered void due to usage of improper fuel. None approved fuel additives (including engine oil) are NOT permitted. Blends of No. 1D and No. 2D grades of ULSD are recommended and allowable for cold weather operations.

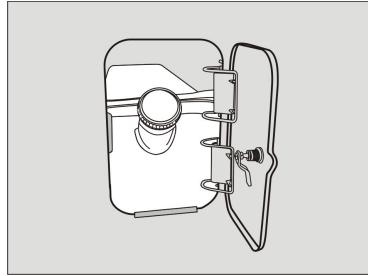

T2061889

Note: Avoid spilling fuel on to painted surfaces. Refuel only at designated places.

Diesel Exhaust Fluid (DEF) Tank

On the right side and on the rear is the Diesel Exhaust Fluid (DEF) tank. The tank can hold 60 l. As a guide , use 5 — 7% DEF

 WARNING
<p>Use only pure certified DEF from an approved dispenser or sealed container.</p>

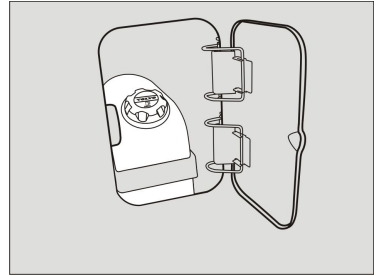

T2061890

 CAUTION
<p>Do not put diesel fuel in the DEF tank. Diesel fuel, if sprayed into the hot exhaust along with the DEF, could ignite explosively causing a fire resulting in personal injury or damage to the exhaust system.</p>

Note: Avoid spilling DEF on to painted surfaces. In case of spilling, rinse the painted surfaces immediately.

The level of DEF is indicated on the display in the “Gauges” menu, in the “DEF tank, level” submenu.

If the level of DEF drops below defined level (12% of the tank capacity), an information or warning message is displayed on the dashboard and the DEF dash lamp illuminates. Fill the tank as quickly as possible.

For additional information, see the separate Operating Instructions “Exhaust Aftertreatment System”



T3014365

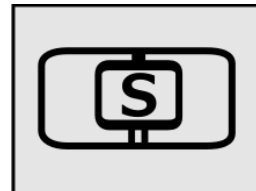

W3079585

Engine Block Heater

An electric engine block heater can be installed for keeping the coolant hot when the vehicle is parked. The heater is mounted through the side of the engine block with the heater coils in the coolant jacket. The heater does not interfere with normal operation and can be permanently installed.

The heater runs on 120V and has an easily accessible plug, located on the right side of the engine compartment. The plug will hook up to a normal extension cable.

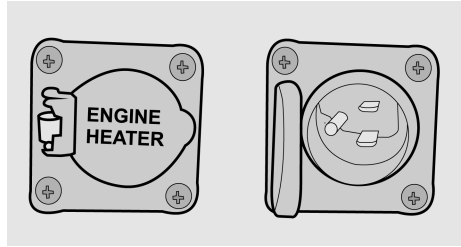

T0015492

Starting the Engine

Starting

When starting the engine, the parking brake must be engaged and the gear selector must be in neutral, i.e. N.

Starting a Cold Engine

When starting the engine at temperatures of around 10°C (50°F) and below, the air entering the engine should be heated. To prevent wear and possible damage to the engine when it is cold, gradually bring it up to operating temperature before operating at high engine speeds or full load. After starting and before moving the vehicle run the engine at 800 to 1000 rpm for 3 to 5 minutes. Operate at partial engine load until the coolant temperature reaches 75°C (167°F).



T0014333

Proceed as follows:

Turn the ignition key to the position between **II** and **III**. This starts the preheating, which can take up to about 50 seconds, depending on the temperature of the coolant. The indicator lamp is lit during preheating. Once the lamp has extinguished and the needle of the temperature gauge has moved off its lower stop, the engine can be started.

Do not race the engine when it is cold. This could damage the engine.



CAUTION

Do not let a cold engine run faster than 1000 rpm in very low temperatures (< -20 °C (-4°F)). Failure to do so may cause internal engine damage.

100 Starting and Driving

Starting a Hot Engine

Start directly by turning the key to the start position.

Stopping the Engine

To shut down the engine, turn the key to the STOP position. In an emergency situation the engine can be shut down by using the emergency stop, see “Emergency Stop”, page 32.

Note: Before turning off engine. If the engine has run at high temperature for a significant time before it is shut down, let the engine run at idle for 3 minutes to cool the engine off to avoid heat soak.

Checks After the Engine Has Been Started.

The coolant level warning lamp will stay lit for a few seconds after the engine has started. The parking brake warning lamp is lit when the parking brake is engaged. After releasing the parking brake, the lamp should remain lit until the pressure increases to about 540 kPa (78 psi). The footbrake warning lamp and the “STOP” lamp should remain lit until the pressure in the compressed air tanks reach a sufficiently high level.

DANGER

Do not drive the vehicle until the warning lamps have gone out, as the brake system needs the correct air pressure to work properly. Failure to do so may lead to an accident, resulting in serious personal injury or death.

Idling (programming)

The engine idling speed is 575–625 rpm. Keeping the idling speed constant is the task of the electronic control system, which makes manual adjustment unnecessary. When the bus is stationary, the idling speed can be temporarily raised to 1200 rpm.

Low Idle Adjustment

Before you start to adjust the idling speed, the engine must be warmed up to operating temperature. The bus must be stationary with the engine idling.

- switch (B) must be in the ON position
- the idling speed is increased by pressing the “+” side of the SET button (A). Each press on this button gives an increase of 10 rpm.
- if the idling speed becomes too high, it can be reduced by pressing the “-” side of the SET button. Each press gives a decrease of 10 rpm.

Note: The change in idling speed is only temporary. After pressing a pedal, engaging a gear or releasing the parking brake, the idling speed will return to its manufacturer settings. If new programming of idling rpm is required, keep your foot on the brake pedal and turn off the engine when the new engine rpm has been set.

Note: If the engine does not “run smoothly” at the default programmed by the manufacturer, please visit a Volvo workshop.

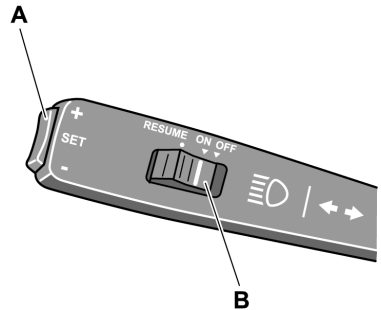

T0012078

102 Starting and Driving

Cruise Control

Cruise control is activated by moving the switch (B) to the ON position.

When the bus reached the desired speed, press the “+” or “-” side of the SET button (A). The set speed is increased or decreased by pressing the “+” or “-” side of the switch respectively.

If the speed is temporarily increased, e.g. for overtaking, the vehicle will return to the set speed when the accelerator is released.

Cruise control is deactivated if:

- the brake pedal is depressed
- the retarder stalk is moved to another position
- the switch (B) is moved to its OFF position

After cruise control has been switched off, the most recent set speed can be restored by moving the switch (B) to RESUME. This however does not apply if cruise control has been deactivated by moving switch (B) to its OFF position.

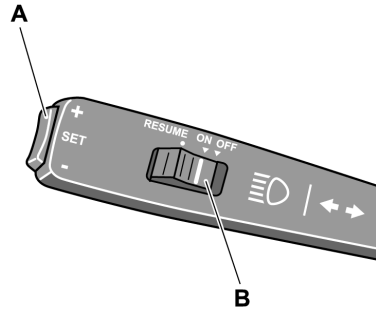

T0012078

Retarder (optional)

The function of the retarder is to supplement the main brake, and it acts as an additional brake. This function may be based on an engine brake, or a transmission brake together with the VEB (Volvo Engine Brake), which is an exhaust brake combined with a compression brake.

When the retarder stalk is in its (A) position, depressing the brake pedal will engage both the footbrake and the auxiliary brake. This mode is called “brake blending”, and means that the brake system decides how great a contribution to the total braking force will come from the auxiliary brake, and how much from the footbrake. It allows for optimal use of the auxiliary brake.

In other situations (1-3) the bus is braked by the additional brake as soon as the accelerator pedal is released. The braking force is increased by moving the lever down and decreased by moving the lever up.

Note: The retard function works together with the EBS system. See the separate driver instructions for “EBS”.



DANGER

Avoid using the retarder on slippery roads because of the risk of locking the wheels and skidding (the retarder brakes only the driving wheels). Failure to do so may lead to an accident, resulting in serious personal injury or death.

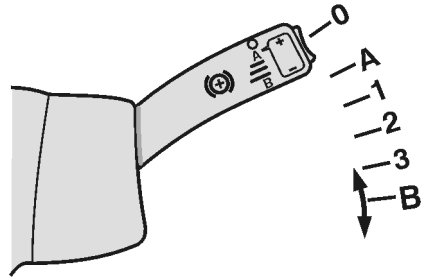

T0010263

The (B) position of the stalk is only present in buses fitted with I-shift. For additional information, see the separate Operating Instruction “I-shift”.

104 Starting and Driving

Speed Limiting

When the bus is driven downhill with the stalk in position (A), the retarder acts as a speed limiter. When the bus has reached the desired speed, lightly press the "+" or "-" side of the SET button (A). The retarder will maintain the speed of the bus at the setting it had when the SET button was pressed.

The set speed can be increased or decreased by pressing the plus (+) or minus (-) side of the SET button. Each pressing of the switch increases or decreases the speed by 1 km/h. If the switch is held in, the speed is adjusted by 1 km/h for each second it is held in.

Note: Buses that have a retard switch instead of a retard lever do not have this function.

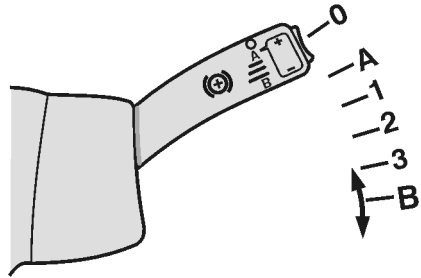

T0010263

Use the SET button on the retard switch to control the speed limitation.

Combined Cruise Control and Speed Limitation

If the bus is equipped with cruise control (see “Cruise Control”, page 102), the cruise control system will work together with the retarder. The stalk of the retarder should be in position (A).



T3008844

With cruise control active. While driving downhill with the cruise control active, the retarder will be engaged if the road speed exceeds the set speed by 5 km/h (3 mph). This overspeed value can be modified by means of the +/- button to any value in the range 3–15 km/h (2– 9 mph).

Note: The retarder is automatically deactivated if there is a risk for wheel locking.

Note: If the symbol for high retarder temperature is displayed, a lower gear range must be selected to cool it down. See separate Operating Instruction “Display”.

Power Steering

If the wheel is blocked on one side, against a curb for example, drive carefully forward and turn the steering wheel to allow the bus to move away from the kerb. Never try to force the wheels to turn.

Do not attempt to turn the bus by using excessive force on the steering wheel. Using excessive force on the steering wheel increases pressure in the power steering system, causing risk of overheating that may damage the oil pump.

If the power steering is malfunctioning it may feel as if the steering gear was blocked, this is however not the case, but steering the bus requires the use of much greater force.

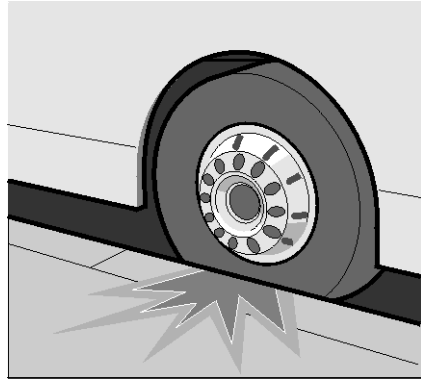

T0008960

Aftertreatment DPF with vertical SCR

- 1 SCR (Aftertreatment Selective Catalytic Reduction)
- 2 DEF Dosing Valve (Aftertreatment Diesel Exhaust Fluid Dosing Valve)
- 3 DPF (Aftertreatment Diesel Particulate Filter)

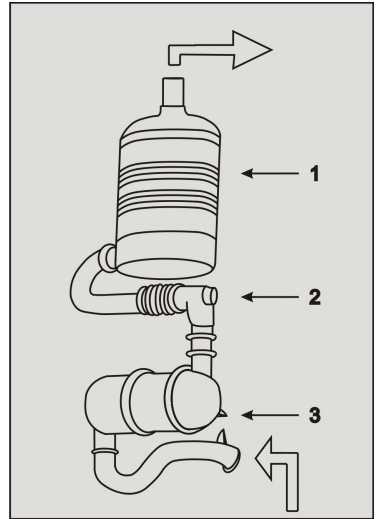

T8061296

Exhaust Aftertreatment System

The Volvo 9700 US/CAN bus has an exhaust aftertreatment system which includes a Aftertreatment Diesel Particulate Filter (DPF) and Aftertreatment Selective Catalytic Reduction unit (SCR). These components are part of the overall vehicle emissions control system. In normal operation, these components can experience surface temperatures as high as 350° C (662° F). It is important to periodically check to ensure there are no trapped material or substances between the DPF/SCR and the cover or shield. Failure to do so may result in fire.

New stringent standards for exhaust emissions control begin with the US 2010 engine model year. The Aftertreatment Diesel Particulate Filter (DPF) system has been developed to act in combination with ultra low sulfur diesel (ULSD) fuel to reduce particulate emissions to meet the requirement. The Exhaust Aftertreatment System (EATS) includes all the engine and exhaust emissions control components that are required to meet the stringent US 2010 standard.

Note: The DPF/SCR and associated components are part of a U.S. EPA and California Air Resources Board (CARB) certified engine emissions system. These components must not be moved, altered or modified in any way. Tampering with these systems render the emissions warranty void and may result in possible tampering charges by the EPA or CARB.



CAUTION

The Aftertreatment Diesel Particulate Filter (DPF), Aftertreatment Selective Catalytic Reduction unit (SCR) and their components, can not be moved or altered from OEM installation in any fashion. Any alterations may cause component damage and is prohibited by the law.



DANGER

The DPF/SCR cover should not be removed while the vehicle is in use. Also, only remove the cover, once the vehicle is out of use and the SCR/DPF is sufficiently cooled. Failure to follow these instructions can result in fire, which can cause component damage, personal injury or death.

DPF Regeneration Required Icon

If the icon “DPF Regeneration Required” lights on, means that the diesel particulate filter is becoming full and regeneration is needed; the icon flashes when the filter is full, maintain uninterrupted highway speed for an automatic regeneration or move the vehicle to a safe location and initiated a parked regeneration.

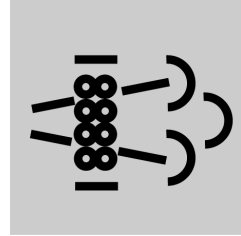

T0015482

High Exhaust System Temperature

The icon “High Exhaust System Temperature” lights on when a parked regeneration is initiated. It also indicates high exhaust gas temperature during an speed regeneration. When the high exhaust system temperature icon is light on, do not park or operate the vehicle near people, or any flammable materials, vapors, or structures. For more information about Exhaust Aftertreatment System, see separated instruction “Exhaust Aftertreatment System”.

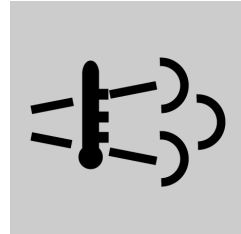

T0015483

Note: It is important to enable regeneration as soon as possible to avoid engine problems. Long—term engine operation with regeneration disabled will result in a loss of engine performance including horsepower, torque and speed decrease.

Emission Green House Gas Component Warranty

Critical emissions-related Maintenance

Source of parts and repair: A repair shop or person of the owner's choosing must maintain, replace, or repair emission control devices and systems per manufacturer's recommendations.

Replace of the tires that are GHG certified:

The original equipment tires installed on this vehicle at the factory were certified to the U.S. EPA Greenhouse Gas (GHG) and National Highway Traffic Safety Administration (NHTSA) Fuel Efficiency regulations. Replacement of these tires should be with a tire of equal or lower rolling resistance levels (TRRL or Crr). Please consult tire supplier(s) for appropriate replacement tires.

Maintaining a GHG certified tire: In order to maintain the certified tilling resistance of the tires which optimize fuel economy, the maintenance procedures provide by the tire manufacturer must be followed

Please visit Prevoist Web Site for further information about Warranty.

Safe Driving

- 1 After starting, and regularly while driving, check that the instruments are giving their normal readings. If any warning lamp lights while driving, stop the bus and investigate the cause.
- 2 Never race a cold engine! Avoid idling for long periods.
- 3 Never cover the radiator! The thermostat keeps the temperature constant regardless of ambient conditions. Check the coolant level regularly and use always the correct type of coolant. Check the hoses/pipes and tensioning of the belts. Do not drive with a leaking cooling or heating system.
- 4 Never drive off before the brake system warning lamps have extinguished. Do not forget the parking brake. The ABS/EBS indicator lamps may light, but this only indicates that the ABS/EBS system is malfunctioning.
- 5 If one of the front wheels is blocked sideways, never try to force it to turn by applying excessive force to the steering wheel.
- 6 While driving downhill and for gradual braking use the retarder function. When driving in slippery conditions take special care, or disable the retarder function altogether.
- 7 When driving on slippery surfaces, e.g. in snow or heavy rain, reduce speed and avoid rapid steering wheel movements. Brake and accelerate gently, to make the journey as safe as possible for the passengers. Driving in slippery conditions requires extra caution when there are strong side winds. Side winds can produce a lifting force acting on the front axle.

Economy Driving

As the driver, you are the most important link in the chain for getting the best overall driving economy.

- 1 **Warm up the engine as quickly as possible.** A warm engine and transmission uses less fuel than a cold one (and there is less wear).
- 2 **Treat the accelerator pedal gently.** Do not “pump” the accelerator pedal. Pumping increases fuel consumption without increasing the speed. A turbo pressure gauge helps you drive economically.
- 3 **High speeds increase fuel consumption** since, among other things, air resistance increases sharply with increase of speed. Strong side and head winds increase fuel consumption even more.
- 4 **Timely and correct servicing will keep the bus in good condition. This will also contribute to preserving low fuel consumption.**

Driving in Cold Weather

Before driving in cold weather conditions (ambient temperature +40°F [5°C] or below), pay attention to the following points:

- 1 The cooling system must be protected against freezing.
- 2 The washer fluid tank must be filled with winter liquid.
- 3 Batteries must be in good condition. In low temperatures, the capacity of batteries to deliver current, e.g. when starting the engine, drops. Make sure that the poles of the batteries are thoroughly clean, with the cable terminals properly tightened and covered with grease, and that there is the correct amount of electrolyte in every cell.
- 4 Engine oil, as well as transmission and rear axle oil, must have the correct viscosity.

Fill up the tanks with winter fuel. This reduces the risk of wax settling in the fuel system. If this has already happened, change the fuel filters and fill up the tanks with winter fuel. Keep the tanks as full as possible.

The compressed air system is particularly sensitive to low temperatures. Excessive condensation in the primary tank indicates that the air drier is not working properly. Drain the tank and change the desiccator cartridge in the air drier. If none of these measures help, use an external heating source to thaw out the system.

QR Code Labels

There are some QR code labels distributed inside the bus. The QR code labels provide the passenger's and the driver a basic information about the bus. To access this information, must have a smart phone with the QR code labels reader application:

- 1 For driver is located on left windshield pillar and cabine door (WCL) frame right structure pillar.

Link:

<https://www.prevostcar.com/QRPassP-revost>

- 2 For passengers are located in the side windows pillars.

Link:

<https://www.prevostcar.com/QRDrivV-2014>

Note: QR Codes can be read by mobile devices.

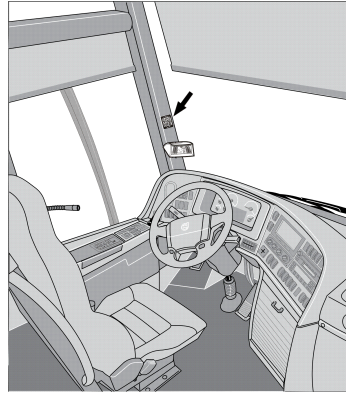

W0091714

QR code label for driver.

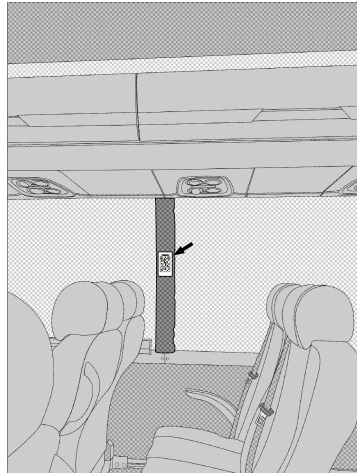

W0095902

QR code labels for passengers.

VAS Assistance Label

In the VAS assistance label there is the contact information for service assistance both Mexico and USA.

- VAS assistance label is located in the operator window.



W0086993

Safety

Always make passenger safety your first priority!

If something unexpected happens you should always proceed as follows:

- 1 Stop the bus in a place which is safe for the passengers, and where the bus itself does not constitute an obstacle for other road users and switch on the hazard warning lights, see “Hazard Warning Lights”, page 30
- 2 Open the doors. If necessary use the emergency valve which is placed in the vicinity of the door.
- 3 Let the passengers out.
- 4 Set the ignition key in position 0.
- 5 Turn off the power with the main switch, see “Main Switch”, page 31.
- 6 If necessary, use the emergency stop, see “Emergency Stop”, page 32.
- 7 Place a warning triangle behind the bus. Remember that the distance between the warning triangle and the vehicle depends on local regulations.
- 8 Call the service center and describe the problem.

116 If Something Happens

If the Engine is Not Working

If the engine refuses to start, check that:

- 1 The cover of the emergency switch is down.
- 2 The main power switch on the dashboard is set to on.
- 3 The gear selector is in the neutral position, i.e. N.
- 4 The parking brake is engaged.
- 5 The switch in the control box in the engine bay is turned towards **1**.

The engine cannot be started when the battery voltage is too low (below 18 V).

The engine cannot be started if either the engine hatch or the front service hatch is open. In that case the display will show an appropriate symbol. Close the hatch before trying to start the engine.



T3018116

Punctures

There are several safety requirements that need to be considered in the event of a punctured tire. For detailed information concerning wheel changing, see the separate Operating Instruction “Jacking points and puncture”.

Punctured Air Springs

In the event of puncture of any of the suspension air springs, the speed **must** be reduced to **20 km/h (12 mph)** and the bus taken to the nearest service facility.

Towing



CAUTION

Failure to disconnect the driveshaft, remove the drive axle shaft(s) or lift the drive wheels off the ground before towing or pushing the vehicle, can cause serious transmission damage and void the transmission warranty.

Note: TCS should be turned off if one of the axles is raised during towing.

For all long distance towing, assure that the tow vehicle has the necessary equipment to reach the front axle, per Bus specifications. Refer to “Technical Specification”, page 137 for more information. It may be necessary for the tow vehicle to attach an air supply to the bus during towing. The position for attaching is available in the front of the bus. See the accompanying illustration for the general location.

Towing or moving the bus for short distances can also be performed using a towing rod or bar. Refer to the accompanying illustrations for attaching points location.

After mechanically releasing the parking brake, the bus cannot be braked either with the main brake or with the parking brake. Block the wheels or connect to the tow vehicle, so that the bus cannot start moving after the parking brake has been released.

Towing requires either the drive shaft or both drive shafts to be removed, because otherwise the transmission may be damaged due to insufficient lubrication.

For, punctures, the tire must be repaired before towing begins.

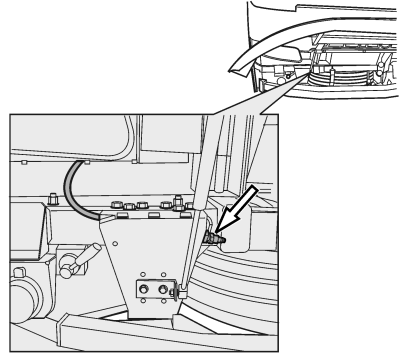

W1000252

Front Air Supply Connection Location

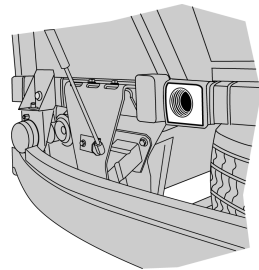

T8012390

Place for towing bar attachment (front).

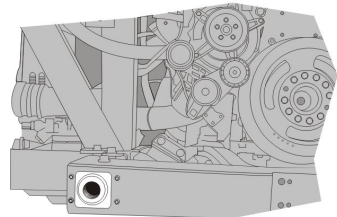

T8059309

Place for towing bar attachment (rear)

118 If Something Happens

Towing procedure.

Note: This procedure applies only for buses equipped with I-Shift transmission.

If the standard procedure can't be followed due to road conditions, follow the alternative procedure described below.

This will allow the vehicle to be towed without the removal of the driveshaft. The following conditions must be met.



CAUTION

Do not replace the towing standard procedure, this procedure does not have any indicator, if any of the steps below are not fulfilled a transmission damage may occur.

Towing gear 3 HR will be engaged if following points are fulfilled:

- The gear lever or the shift pad must be in neutral
- Engine is not running
- There must be enough air pressure to the gearbox (minimum 4 bar /58 psi)
- The vehicle must have electrical power.
- The ignition key must be in "ON" position.
- Vehicle must be towed forward



CAUTION

Reverse towing is not allowed when such towing alternative procedure applied. Reverse towing can damage the gearbox.

Second Fire Detection Circuit

The Volvo 9700 US/CAN bus is equipped with a second Fire Detection Circuit and in the event of fire, the STOP lamp lights up in the engine bay, an audible signal is emitted and a symbol appears on the display.



T0012298



DANGER

Shut down the engine immediately!
Failure to do so may keep the radiator fan running which impels air into the engine bay and fans the fire. This may result in serious personal injury or death.

120 If Something Happens

Releasing the Parking Brake

Release the Parking Brake with Air from the Bus Tires.

- 1 To prevent the bus from moving, block its wheels or attach it to a tow vehicle.
- 2 Connect the clamp head of the tire inflation hose to the valve of one of the tires.
- 3 Move the parking brake control to the drive position.
- 4 While pressing the other end of the tire inflation hose against the pump nipple, press in the blocking valve. Now the brake system is filled with the air from the tire. Filling can be interrupted as soon as the air flow stops.

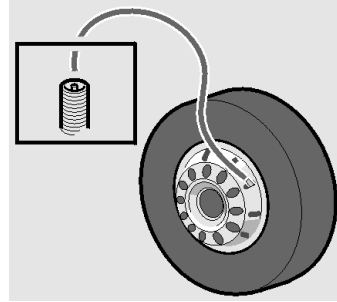

T0009182

Note: Chock the wheels to prevent the bus from moving when releasing the parking brake.

Mechanical Releasing of the Parking Brake

- 1 By blocking the wheels, make sure that the bus will not start rolling after releasing the parking brake.
- 2 On both drive shaft brake cylinders there are release bolts. Screw them out until a red plastic button appears out from the center of the bolt. The brakes are then released. This requires around 45 rotations. Use the designated wrench from the toolkit or the sleeve and locking handle.
- 3 The bus can now be towed. Towing should be performed using a properly equipped tow vehicle that can reach the front axle, since the bus is now completely without brakes.

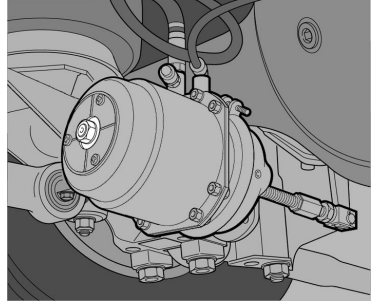

TS014634

Note: Do not forget to reset the bolts to their original position and attach the plastic cover after towing has been completed.



DANGER

Chock the wheels to prevent the bus from moving when releasing the parking brake. Failure to do so may result in serious personal injury or death.

122 If Something Happens

Disc Brakes

The brake cylinder is fitted with a release screw, which does not protrude from the cylinder during manual release. When starting to release the parking brake, a red peg emerges from the centre of the nut. It is fully out after three turns. Full compression of the parking brake spring requires approximately 45 turns. Whenever possible try always to fill the parking brake cylinders with air. It makes it easier to turn the nuts of the release mechanisms.

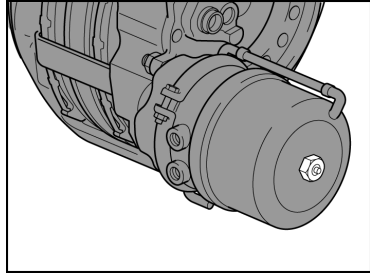

T5014635

Changing the Batteries

When changing batteries, both batteries should have the same capacity and be of the same age. When connecting batteries correct polarity must be observed.

To change a battery:

- turn off the power with the main switch
- disconnect the cable terminal from the negative pole of the battery
- disconnect the cable terminal from the positive pole of the battery
- change the battery
- clean the cable terminals and both poles of the battery
- connect the positive cable terminal to the battery pole
- connect the negative cable terminal to the battery pole
- apply an anti-corrosive agent to the poles with terminals



WARNING

Incorrect connection will seriously damage the electrical system.

If a cable clamp has been incorrectly installed, the battery terminal must be reamed to give a sufficiently large mating surface when correctly installed. Incorrect installation entails a high risk of oxidation in the space between the top of the battery terminal and the battery cable clamp.

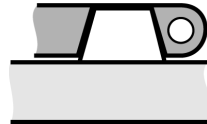
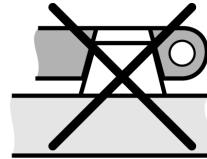

T3019198

Top: Mounted incorrectly, terminal not bottoming on the pole.

Bottom: Mounted correctly, terminal bottoming on the pole.

124 If Something Happens

Starting Assistance

In the event that the batteries are unable to start the engine, auxiliary batteries can be used to help in starting. These batteries are connected in parallel with the ordinary bus batteries.

Note: Note the polarity. Plus to plus and minus to minus.



CAUTION

Battery chargers with a start boost feature must not be used for starting assistance. Failure to do so may cause damage to the electrical system.

Battery Cut-off Switch

The battery cut-off switch is located next to the batteries and is there to completely cut off the bus power supply. To prevent battery discharge when the bus is standing for 24 hours or more, turn the battery cut-off switch to the OFF position.



CAUTION

Always switch off the power with the cut-off switch when charging the batteries and when connecting an auxiliary batteries to start the engine.



CAUTION

Before using the battery cut-off switch, the power must always be switched off using the main switch on the dashboard. Failure to do so may cause damage to the electrical system.

Note: After using the battery cut-off switch, it may be necessary to re-enter the radio code.

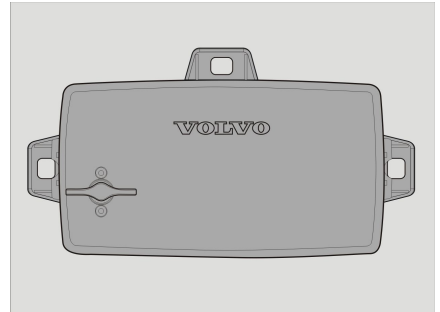

T8057553

Bulb Replacement

Headlamps

- Lift the front bumper
- Loosen the securing screws (A) and (B), delicately lower the lamp module and tilt it open
- Disconnect power supply cables
- Remove the bulb

Note: Replace it with a new bulb of the same type and power rating.

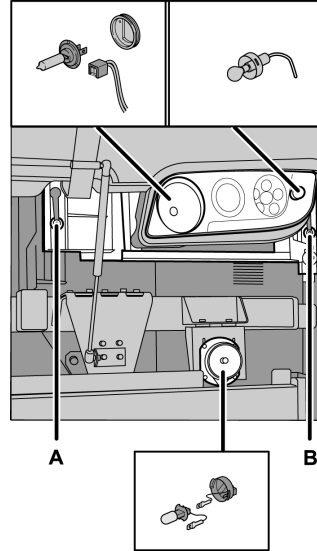

T8012393

Rear Lights

- Unscrew the five screws securing the cover
- Replace the bulb
- Before fitting the lamp check whether it is working properly

Note: Make sure that the bulb is replaced with a new bulb of the same type and power rating.

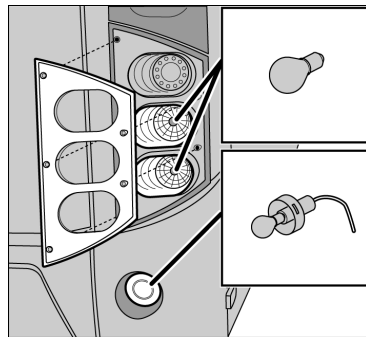

T3019941

Xenon Lights



DANGER

Xenon lights should only be serviced at an authorized service facility. Never try to repair the lights on your own. Ignition voltage in xenon bulbs is **28,000 V**. Servicing these lights without the necessary knowledge and service information may result in serious personal injury or death.

Licence Plate Lighting

Replace the licence plate lamp as follows:

- Unscrew the screws securing the lamp
- Replace the lamp

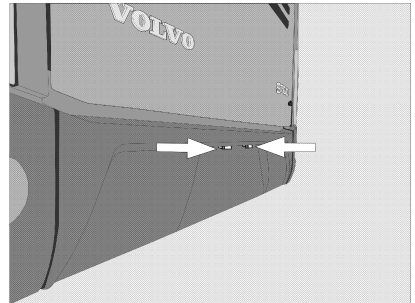

W0089795

128 If Something Happens

Fuses and Relays (body & chassis)

The fuse and relay boxes are located at the front right of the bus, next to the entrance stairs and under the division wall.



W0089803

Relays (chassis)

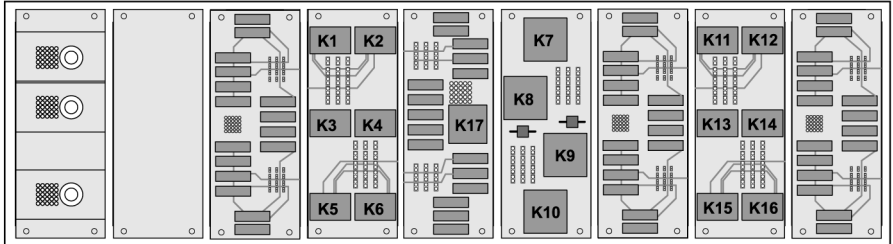

T0012034

Relays			
K1	FTM (Fuel Tank Monitor)	K11	Start inhibit relay
K2	Load indicator	K12	Starting signal, starter motor
			Luggage compartment lighting (alternative)
K3	Self-holding relay, ECS	K13	Emergency switch
K4 ¹	TCM (Transmission Control Module) GSECU (Gear Shift Electronic Control Unit) I-shift gearbox	K14 ¹	Spare
K5 ¹	Spare	K15 ¹	Spare
K6 ¹	Spare	K16 ¹	Spare
K7	Starter motor	K17	Ignition relay (+15)
K8 ¹	VECU (Vehicle Electronic Control Unit), ECM (Engine Control Module)	K48 ²	Preheating relay
K9	Interval relay, windscreen washer wiper motor	K51 ³	Main power supply relay
K10 ¹	Pre filter fuel heater		

1 Depends on version

2 This is located on the engine bay bracket near the emergency stop.

3 This is located in a steel box next to the battery box.

130 If Something Happens

Fuses (chassis)

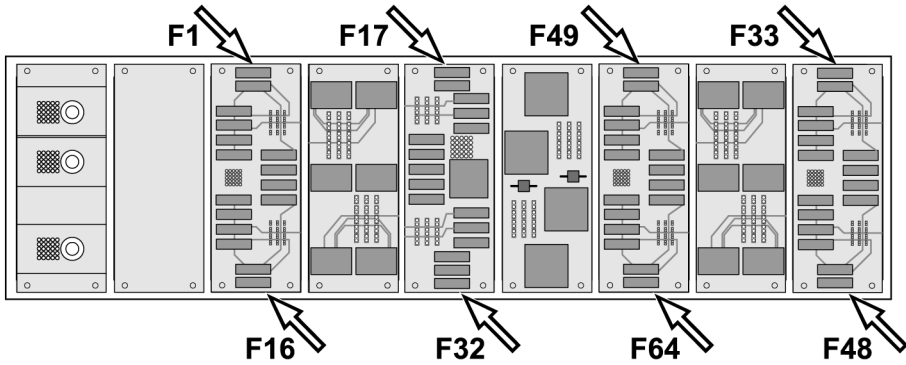

T0012035

Fuses					
F1	5A	ECS (Electronic Controlled Suspension)	F35	25A	LCM (Lighting Control Module)
F2	10A	BIC2 (instrument), control switch	F36	25A	LCM (Lighting Control Module)
F3	15A	Pre filter fuel heater	F37	25A	LCM (Lighting Control Module)
F4	20A	EBS (Electronic Brake System)	F38	—	Spare
F5	5A	Horn	F39 ¹	25A	Exhaust emissions cleaning control unit
F6	5A	Emergency release of parking brake	F40	—	Spare
	30A	Ignition switch (Early version)			
F7 ¹	15A	TCM (Transmission Control Module), GSECU (Gear Shift Electronic Control Unit)	F41 ¹	20A	Radio
				—	Spare
F8 ¹	5A	GSECU (Gear Shift Electronic Control Unit)	F42	5A	Emergency stop switch, main switch
F9	5A	Starting switch, engine compartment	F43	—	Spare
F10	5A	Fire Alarm	F44	25A	LCM (Lighting Control Module)

Fuses					
F11 ¹	10A	FMS (Fleet Management System)	F45	25A	LCM (Lighting Control Module)
F12	5A	Supply, main switch (+30) to body-builder outlet	F46	25A	LCM (Lighting Control Module)
F13	10A	Oilmaster	F47	5A	Side position lamp, right-hand side
F14	5A	BBM (Body Builder Module)	F48	5A	Side position lamp, left-hand side
F15	15A	ECM (Engine Control Module), Control valve * (1) ¹ , radiator fan, preheating relay	F49	5A	Fuel shut-off valve
F16	5A	VECU (Vehicle Control Unit)	F50 ¹	10A	RECU (Retarder Control Unit)
F17	5A	Switch feed	F51 ²	20A	Radio, 24–12 V (+30) converter
				—	Spare
F18	5A	Alternator 1, 2, 3	F52 ¹	10A	Baggage hold lighting
F19 ¹	10A	Hymer, oilmaster, starter motor	F53 ¹	5A	Trailing axle, dehydrator heater
F20	10A	EBS (Electronic Brake System)	F54	5A	Engine hatch/luggage compartment hatch
F21	15A	Wiper motor, windscreen	F55	10A	Engine break valve, preheat relay, fan speed clutch
F22	10A	TCM (Transmission Control Module), Voith automatic gearbox	F56	5A	Preheating relay
					Dehydrator heater
				10A	Engine brake
F23	5A	FMS (fleet management system)	F57	5A	Ignition key/Start switch
F24	5A	BIC2 (instrument panel), OBD2	F58	5A	FTM (Fuel Tank Monitor)
F25	15A	Washer motor	F59	—	Spare

132 If Something Happens

Fuses					
F26	5A	ECS (Electronic Controlled Suspension)	F60	10A	TCM (Transmission Control Module), ZF automatic transmission/gearbox
F27	10A	Spare	F61	10A	Baggage hold lighting
F28	10A	RECU (Retarder Control Unit)	F62	20A	Dimmed interior lighting
				—	Spare
F29	5A	Power from the ignition (+15) to body electrical system connector	F63	5A	LKS / DAS (Lane Keeping System/ Driver's Assisted System)
				—	Spare
F30	5A	Radio, 24–12 V (+15) converter ²	F64	10A	Load indicator
	20A	Fuel heater			
F31	5/10 A	Hydraulic oil level, hydraulic oil filter, exhaust emissions cleaning control unit	F80 ³	150 A	Main battery fuse (B+)
F32	5A	Tachograph	F81	80A	Power supply main fuse (+30)
F33	5A	BIC2 (instrument)	F93	5A	Alternator
F34	—	Spare			

1 Depends on version.

2 Loose fuse holder next to it.

3 This is located in a steel box next to the battery box.

Fuses and relays (body)

Relays

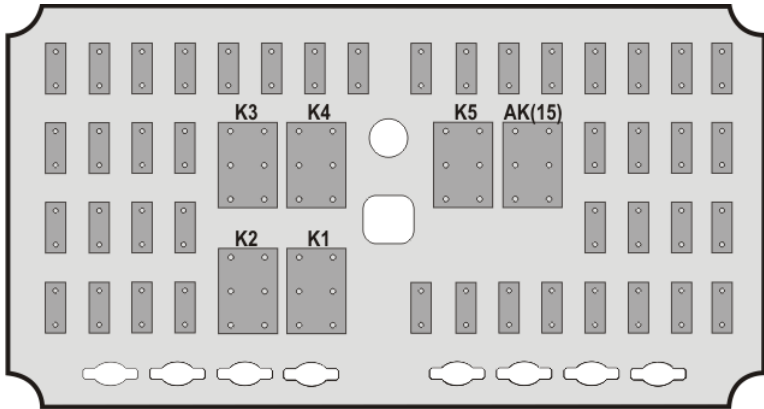

T8059319

Relays			
AK(15)	Loads +15	K3	Defroster, speed 2
K1	Over speed control 95 km/h [59 mph]	K4	Defroster, speed 3
K2	Defroster, speed 1	K5	Free relay

134 If Something Happens

Fuses

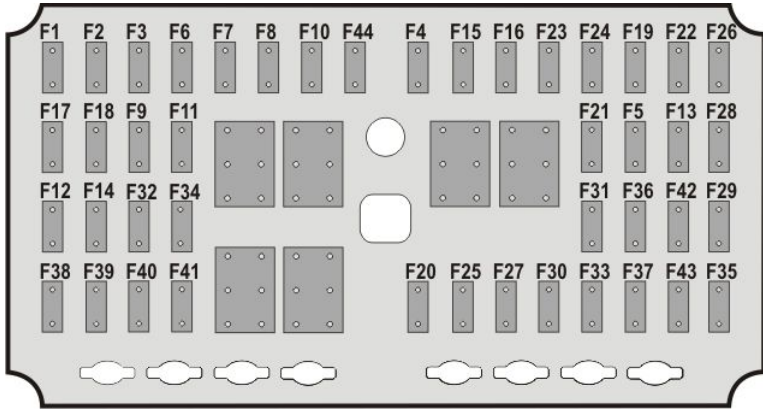

T8058916

Fuses					
F1	3A	Power Master ID	F23	5A	Light under seats
F2	5A	Transcom	F24	5A	Middle door I/O A Module
F3	20A	Audio & Video 12V	F25	5A	Webasto Timer 3
F4	30A	Feed Relay K5	F26	5A	Dashboard I/O Module
F5	30A	Floor I/O B Module	F27	30A	24V CD Output in Driver side
F6	5A	Climate I/O A Module	F28	5A	Pressure switch
F7	5A	Climate unit I/O A	F29	3A	Copiloto/ V-Link
F8	5A	Defroster Flap	F30	5A	Control panel air
F9	5A	Red led switches	F31	3A	Feed +15 TD7
F10	20A	Defroster	F32	5A	Mobitec (+15)

Fuses					
F11	30A	Floor Left 2 I/O B Module	F33	15A	DRC Air Conditioning
F12	7.5A	Mobitec control & CECM MSW signal.	F34	20A	Audio & Video (+15)
F13	7.5A- /15A	Left & Middle Toilet I/O B Module/FSS	F35	10A	Park Pilot
F14	20A	Electric Window	F36	5A	Time & Temperature display
F15	30A	Wheel Chair Lift	F37		FREE
F16	30A	Roof Left I/O Module	F38	3A	V-Link
F17	5A	Webasto Timer 2	F39	7.5A	Roof Hatch Front
F18	20A	Audio & Video 24 V	F40	5A	Middle door, I/O A Module
F19	7.5A	Toilet I/O B Module	F41	5A	Webasto Timer 1
F20	15A	Dashboard converter, cigarette output	F42	15A	Electrical Binder
F21	5A	Copiloto, TD7	F43	30A	Auxiliary heater
F22	15A	CECM B	F44	15A	Free over speed relay

136 If Something Happens

Replacement of wheels

Note: For more information and detail instructions to do this operation safely, see separate booklet “Replacement of wheel and air spring”.

The coach has a structural lifting points in both sides for lift and hold the bus if required changing anyone of wheels.

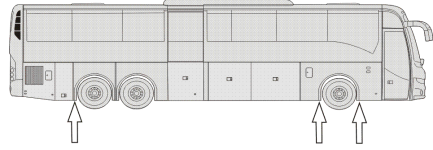

W0089962

Lifting points are indicated with a decal located at the bottom of each fender wheel of the bus.

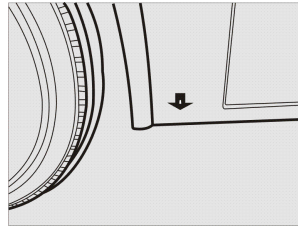

W0089967

Spare wheel

Is installed in the front of the bus, under the driver's area floor. To access it you must lift the front hatch.

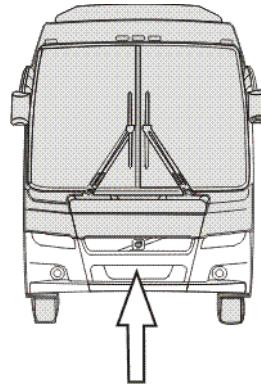

W0089968

Technical Specification

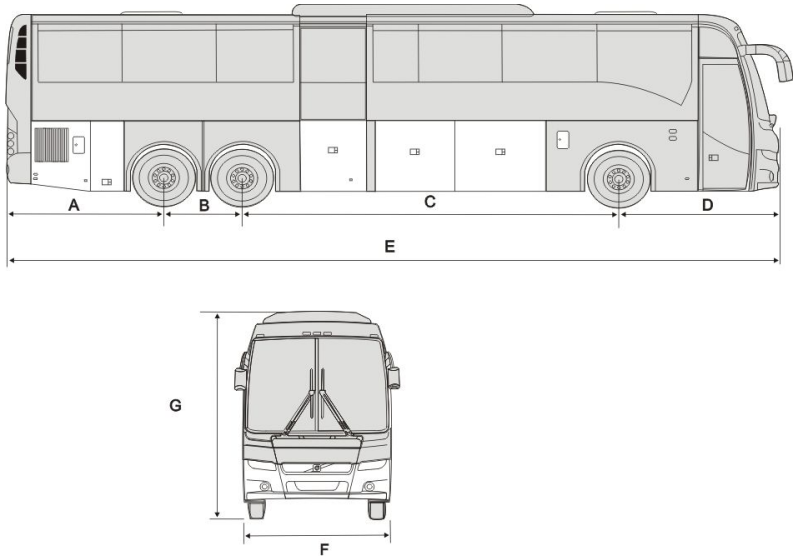

T8061190

Technical Specification	
	3-axle 13.7m
A	2,780 mm (109 in.)
B	1400 mm (55 in.)
C	6660 mm (262 in.)
D	2,850 mm (112 in.)
E	13,690 mm (539 in.)
F	2600 mm (102 in.)
G	3671 mm (145 in.)

138 Technical Data

Bulbs

Light	Rated Power	Volvo p/n
Main beam	70 W	990037
Dipped beam	35 W	21008653
Direction indicator, front	21 W	982558
Direction indicator, rear	21 W	982558
Fog lamps, front	70 W	943903
Reversing	21 W	967708

Type Plates

The vehicle identification number (VIN) is marked on an identification plate on the bus.

Identification Plate

Within its inside border, the identification plate is subdivided into a legal requirement section, as well as three boxes for the chassis number, drive and wheelbase. These latter are not used for buses, only for lorries. The identification plate is located by the driver's seat and contains the following information:

- G.V.W.R (Gross vehicle weight rating), is the maximum allowable total weight of the vehicle.
- G.A.W.R (Gross axle weight rating), is the maximum distributed weight that may be supported by an axle VIN is the same number that can be found on the frame member.
- Tires dimensions.
- Rims dimensions
- Cold inflation pressure, is the inflation pressure of the tires before the vehicle is driven and the tires warmed up.
- VIN is the same number that can be found on the frame member.



MANUFACTURED BY: VOLVO BUS CORPORATION
 FABRIQUE PAR: VIM

DATE OF MFG:
 DATE DE FAB:

G.V.W.R.: 22407 KG. (49400 LBS)
 P.N.B.Y.:

AXLES/ESSEUX	G.A.W.R./P.A.B.E.		TIRES/PNEUS	RIMS/JANTES	COLD INFLATION PRESS./PRESS. A FROID		SINGLE OR DUAL/SIMPLE OU DOUBLE
	KG	LBS			KPA	PSI	
FRONT/AVANT	7484	(16650)	315 / 80R22.5(J)	22.50,00	830	(120)	S
REAR/ARRIERE	10024	(22100)	315 / 80R22.5(J)	22.50,00	820	(90)	D
REAR TANDEM	4800	(10600)	315 / 80R22.5(J)	22.50,00	600	(85)	S

THIS VEHICLE CONFORMS TO ALL APPLICABLE U.S. FEDERAL MOTOR VEHICLE SAFETY STANDARDS AND CANADIAN MOTOR VEHICLE SAFETY REGULATIONS IN EFFECT ON THE DATE OF MANUFACTURE SHOWN ABOVE. VEHICULE EST CONFORME A TOUTES LES NORMES QUI LUI SONT APPLICABLES EN VERTU DES REGLEMENT SUR LA SECURITE DES VEHICULES AUTOMOBILES DU CANADA EN VIGUEUR A LA DATE DE SA FABRICATION INDIQUEE CI-HAUT.

VEHICLE IDENTIFICATION NO.
 NO. IDENTIFICATION VEHICULE

TYPE: BUS / B/A

T0015663

Vehicle Identification (VIN)

This is stamped on the chassis at the right-hand front end of the vehicle, in the wheel arch in front of or behind the front axle.

Example: **3CET2V228E5167543**

3CE	Manufacturer identification
T2	Chassis version
V2	Engine version
2	Brake system type
8	Check digit (according ISO 13779)
E	Model year
5	Assembly factory
167543	Chassis number

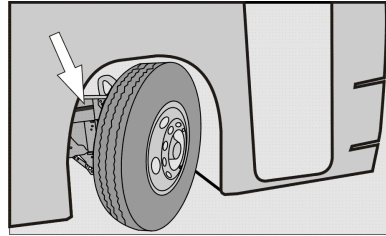

W0089910

Engine (identification labels)

Type designation, component number, serial number and emissions certification information are on the labels adhered at the top of the valve cover. On the engine block you have more information regarding engine identification, see the list below. For more information see the separate instructions "Volvo Engine, Operator's Manual".

- 1 Chassis and engine serial numbers information label.
- 2 Emissions certification information label.
- 3 Engine control module part number.
- 4 Engine type and serial number stamped on the engine block.
- 5 Certifications.

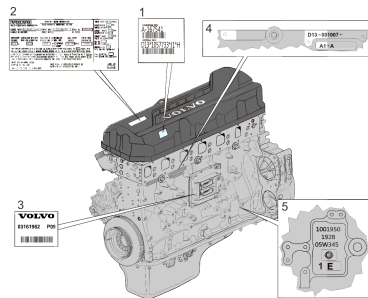

W0089939

Rear Axle (identification plate)

The plate is located on the axle housing.
The information provided on the plate is as follows:

- Carrier model.
- Carrier ratio.
- Service category.
- Rear axle part number.
- Differential assembly number.
- Chassis serial number.
- Axle serial number.

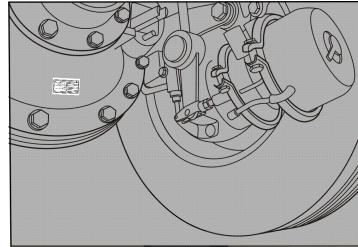

W0089943

Retarder (If installed), identification plate

Serial number and version are stamped on rear left side of retarder housing. The information provided on the plate is as follows:

- Component model.
- Serial number.
- Manufacturing date.
- VOITH part number.
- VOLVO part number.

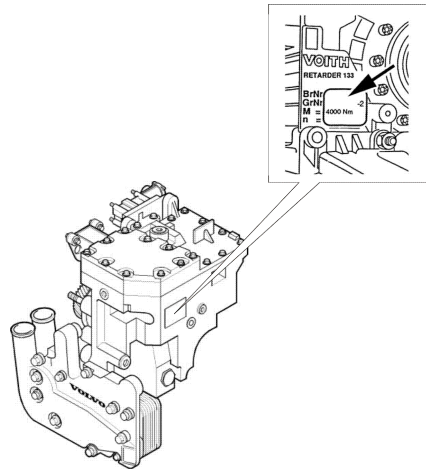

W0089959

Service Intervals

Regular servicing in accordance with the special service schedule is required to maintain the bus to its original specifications throughout its service life.

Carry out all servicing and maintenance of the bus at a Volvo workshop or, for Prevost support vehicles, in Prevost service center/provider.

These workshops have the trained personnel, special tools and necessary service literature that are vital in ensuring high quality of servicing. This quality also depends on the use of Volvo Original parts, which are of identical quality to the components installed at the Volvo manufacturing facility.

For service intervals, see the separate service literature.

When washing the bus, only use agents that are intended for this purpose. See also: Operating Instruction "Interior maintenance".

VOLVO

Volvo Bus Corporation

Göteborg, Sweden