



PREVOST®

OPERATOR'S MANUAL

X3-45 COACH

PREVOST®

COACH MANUFACTURER

OPERATOR'S MANUAL X3-45 COACH



PA1618 rev.5

January 2018

PA1618

Featuring:

- Cooling system electric fans.
- New electrical architecture
- GHG 2017 emission control

First edition: July 2016, Model-year 2016 preliminary vehicle G-6092

REV	EFFECTIVE	DESCRIPTION	DATE
0	First Release		July 2016
1	H-6180	Telematics note added and general revision	Dec 2016
2	H-6180	Starting and Stopping : Updated Rear Start panel	June 2017
3	J-6281 / J-7482	ELD interface connector added	Dec. 2017
4	From J-6295	ABS8	Jan 2018
5	From J-6313	Coolant Recovery Tank	June 2018



⚠ WARNING

Breathing diesel engine exhaust exposes you to chemicals known to the State of California to cause cancer and birth defects or other reproductive harm.

- Always start and operate the engine in a well-ventilated area.
- If in an enclosed area, vent the exhaust to the outside.
- Do not modify or tamper with the exhaust system.
- Do not idle the engine except as necessary.

For more information go to www.P65warnings.ca.gov/diesel

Proposition 65 Warning Decal on Diesel Engine Exhaust Health Hazard

<p style="text-align: right;">18755-1</p> <div style="background-color: black; color: white; padding: 10px;"> <p style="text-align: center;">⚠ WARNING</p> <p>Breathing diesel engine exhaust exposes you to chemicals known to the State of California to cause cancer and birth defects or other reproductive harm.</p> <ul style="list-style-type: none"> - Always start and operate the engine in a well-ventilated area. - If in an enclosed area, vent the exhaust to the outside. - Do not modify or tamper with the exhaust system. - Do not idle the engine except as necessary. <p>For more information go to www.P65warnings.ca.gov/diesel</p> <p style="text-align: right; font-size: small;">0691001</p> </div> <p>DECAL #0691001</p> <p>This warning decal is available through Prevost Parts.</p>	<div style="display: flex; justify-content: space-around;"> <div style="text-align: center;"> <p>H3 SERIES</p>  </div> <div style="text-align: center;"> <p>X3 SERIES</p>  </div> </div> <p style="text-align: right;">18755</p> <p>Best location where to affix the decal on the vehicle.</p>
---	---

CRITICAL EMISSION-RELATED MAINTENANCE

Source of parts and repair:

A repair shop or person of the owner's choosing must maintain, replace, or repair emission control devices and systems per manufacturer's recommendations.

Replacement of tires that are GHG certified:

The original equipment tires installed on this vehicle at the factory were certified to the U.S. EPA Greenhouse Gas (GHG) and **National Highway Traffic Safety Administration (NHTSA)** Fuel Efficiency regulations. Replacement of these tires should be with a tire of equal or lower rolling resistance levels (TRRL or Crr). Please consult your tire supplier(s) for appropriate replacement tires.

Maintaining a GHG certified tire:

In order to maintain the certified rolling resistance of the tires which optimize fuel economy, the maintenance procedures provide by the tire manufacturer must be followed.

EVENT DATA RECORDING DEVICES

This PREVOST vehicle is equipped with a device generally referred to as an "event data recorder" or "EDR." Please note that while the term "event data recorder" is typically used throughout the motor vehicle industry, not every EDR is the same; i.e., they do not all record the same data elements.

The EDR on this PREVOST vehicle records vehicle speed, engine RPM, time and date, plus a variety of pedal and switch positions, both before and after an "event." Sudden vehicle deceleration or the occurrence of certain other vehicle operational characteristics will define (trigger) an "event."

For any questions about this vehicle EDR device, contact a PREVOST Service Center or a regional service manager.

TELEMATICS DEVICE

Your vehicle is equipped with one or more recording devices ("Telematics Device"), associated with Prevost's Connected Vehicle Services (the "Telematics Services"). These services, which are described in greater detail at www.prevostcar.com (the "Website"), allow you to manage vehicle maintenance and repair in a cost-effective manner by providing: proactive diagnostic and repair planning assistance with detailed analysis of diagnostic trouble codes; streamlined service procedures with parts-on-hand confirmation before a vehicle arrives for service; and live repair and customer communication. The service eliminates or reduces diagnostics time, enhances repair efficiency, expedites decision process, improves communications and maximizes uptime. To access the Telematics Services, you must enter into a Telematics Subscription Agreement with Prevost, via the sales agreement pertaining to your vehicle.

The Telematics Device collects stores and/or transmits information about your vehicle. Such information may include direction and rate of speed, fuel consumption, engine performance, gearing, rpm, altitude, geo-location (including a history of where the vehicle travels), safety information related to the use and operation of the vehicle, vehicle performance, diagnostic data and error codes. The Telematics Device has the capacity to store historical data about the use and performance of your vehicle. The Telematics Device has the ability to transmit information to a central communications system. The information contained in your Telematics Device may be periodically transmitted to or accessed by Prevost and others authorized by Prevost, along with your vehicle's VIN number or other identifying information. Prevost does not collect any driver information. Prevost retains and uses this information to understand the operational use of your vehicle, to remotely tune your vehicle, and to help facilitate maintenance and vehicle improvements. To the extent allowed by law, Prevost reserves the right to access, use and control this information.

Declining to enter into a Telematics Subscription Agreement with Prevost, or canceling a Telematics Subscription Agreement, will not end the transmission of data from your Telematics Device or the collection of information by Prevost. Prevost may access Telematics Data, to the extent it is available, and use it in connection with providing services and vehicle improvements to you and your vehicle. Prevost will regularly purge from its systems all data collected from your Telematics Device, at time intervals determined by Prevost at its sole discretion.

ELECTRONIC LOGGING DEVICE (ELD)

This vehicle is equipped with a dedicated ELD interface connector located under the lower left part of the dashboard. This SAE J1939 9 PIN connector is compatible with most FMCSA approved ELD and will ensure that the ELD will not interfere with the vehicle communication, diagnostic and/or driving systems.

Please take note that **the OBD connector is only intended as a diagnostic equipment connection.** Installing an aftermarket plug-in device that uses the OBD port may cause interference and/or damage to the vehicle systems, potentially affecting safe operation.

Both connectors (OBD and ELD) are clearly identified under the dash by stickers. ***The OBD port must remain unconnected at all times except during vehicle maintenance (using Prevost approved diagnostic equipment only).***

Connecting aftermarket equipment to the OBD connector *may lead to:*

- Incorrect emission monitoring and failure to meet the requirements of emission tests.
- Erratic behaviour of one or more of the vehicle safety devices/driving aids, increasing the risk of accidents.
- False code readings and inconsistency during vehicle diagnostic procedures, increasing vehicle down time.
- Unreliable ELD connection/recording and potential violations with the federal ELD regulations*.

* For more information regarding Federal ELD requirements, consult the [FMCSA](#)

This **Operator's Manual** for the PREVOST H3-41 and H3-45 coaches has been prepared to thoroughly acquaint you, the driver, with the equipment and features of the coach in order for you to fully appreciate and safely enjoy this vehicle. Prevost Car Incorporated is committed to the continuous improvement of coach quality, reliability, durability and safety. With innovative features, the H3 series coach was designed with passenger and driver safety and comfort in mind.

This manual contains information available at the time of publication. Because standard and optional equipment is covered in this manual, some of the optional equipment described may not apply to your coach. If in doubt, refer to the technical documentation package provided with the coach.

Driver's controls and instruments incorporate advanced technology for enhanced driving ease and security. This manual describes the main features, instruments and controls, and servicing requirements for both standard and optional equipment. Read this manual carefully to take advantage of the coach's advanced features and to ensure optimum safety and passenger comfort.

Keep this manual in the coach at all times. Make sure this manual is kept with the coach when ownership is transferred. Please use the appropriate card at the end of this manual to promptly notify Prevost Car of any change of address or transfer of ownership. This will ensure we provide fast and reliable coach service to all coach operators.

<p>NOTE</p> <p><i>Illustrations in this manual are used for reference only and may differ slightly from the actual vehicle; however, key components addressed in the manual are represented as accurately as possible.</i></p>

Warnings, cautions and notes are used throughout this manual to emphasize important points when necessary:

 <p>WARNING</p> <p>Directs the operator's attention to unsafe practices which could result in serious personal injury or severe damage to the vehicle.</p>

 <p>CAUTION</p> <p>Directs the operator's attention to unsafe practices where personal injury is not likely but damage to vehicle components could occur.</p>
--

<p>NOTE</p> <p><i>Indicates supplementary information essential to the proper operation of the vehicle.</i></p>
--

The service life of the coach depends on the kind of attention it receives. Pay close attention to the warnings, cautions and notes. Read the various notices and instructions posted throughout the coach and attached to equipment.

Since continuous improvement is a primary focus at Prevost Car, we reserve the right to make changes anytime, without notice, and without incurring any obligation.

Before reproducing or copying this manual, in whole or in part, written consent must be obtained from Prevost Car Incorporated.

SAFETY PRECAUTIONS..... 1-1

COACH EXTERIOR..... 2-1

COACH INTERIOR..... 3-1

CONTROLS AND INSTRUMENTS 4-1

OTHER FEATURES 5-1

STARTING AND STOPPING PROCEDURE..... 6-1

SAFETY FEATURES AND EQUIPMENT..... 7-1

CARE AND MAINTENANCE..... 8-1

TECHNICAL INFORMATION 9-1

ABBREVIATIONS

APPENDIX A – SERVICE LITERATURE

APPENDIX B – TROUBLESHOOTING GUIDE FOR MULTIPLEX VEHICLES

APPENDIX C – ALLISON DIAGNOSTIC TROUBLESHOOTING CODES

APPENDIX D – VALEO PREHEATER FLASH CODES

APPENDIX E – TPMS TROUBLESHOOTING GUIDE

Safety Precautions 1-1

SAFE OPERATING PRACTICES	2
DEFENSIVE DRIVING PRACTICES.....	2
OTHER PRECAUTIONS	3

1-2 Safety Precautions

SAFE OPERATING PRACTICES

To ensure safe and reliable operation, heed the following safety precautions.

- Operation and maintenance of the vehicle must be performed only by qualified personnel.
- Before driving, conduct a walk around inspection and check that all baggage compartment doors and equipment access doors are securely shut.
- Make sure good visibility is maintained at all times. Keep windshields clean and free of obstructions.
- Adjust the driver's seat so that all controls can be reached easily.
- Always wear your safety belt when driving.
- Check the instrument panel frequently. Do not operate the vehicle when dials or indicators do not indicate normal operating conditions.
- Always pay attention to pedestrians passing in front and behind the vehicle. Always yield to pedestrians at pedestrian walkways.
- Do not drive over obstacles on the road. Empty boxes, piles of leaves, and snowdrifts could conceal hidden dangers that could damage the vehicle suspension and underbody.
- When turning or changing lanes, signal your intention well in advance.
- When approaching to make a right turn, reduce the space between the vehicle and the curb to make sure another vehicle cannot pass on the right. Since the vehicle makes wide turns, allow enough space to make safe turns.
- Switch from high beams to low beams when meeting or following other vehicles within 500 feet (150 meters).
- Never leave the vehicle unattended with the engine running or with the key in the ignition. Turn off the engine, remove keys and apply the parking brake before leaving the vehicle.
- Shut-off the engine before refueling, adding oil, performing maintenance or servicing tasks, unless stated otherwise.
- Fuel is highly flammable and explosive. Do not smoke when refueling. Keep away from open flames or sparks.

- Do not run the engine or HVAC system with access doors left open. Close compartment doors before operating any equipment.
- Do not remove the surge tank filler cap or the cooling system pressure cap when the engine is hot. Let the engine cool down before removing filler caps.
- Do not attempt to push or pull-start the vehicle.
- The service life of the vehicle depends on the kind of maintenance it receives. Always record any problems and report them immediately to maintenance personnel.

DEFENSIVE DRIVING PRACTICES

- For city driving, allow a four to six second travel interval between your vehicle and the vehicle ahead. Increase this travel interval to six to eight seconds for highway driving. Increase time interval for driving at night or in foul weather.
- Be prepared to stop when approaching an intersection. The stopping distance of the vehicle increases with the weight and speed.
- Establish eye-to-eye contact with other drivers and with pedestrians. Use, high beam and low beam headlights, turn signals and horn as needed.
- On highway, don't stare at the road ahead. Keep your eyes moving. Check mirrors and dashboard instruments frequently.
- To keep the vehicle from drifting across lanes during highway driving, always look over the horizon on the road ahead.
- Adjust your speed to road conditions, traffic and visibility. Never exceed the posted speed limits.
- If another vehicle is following close behind, reduce your speed to let the vehicle pass.
- For additional information about safe operation and defensive driving practices, contact the local department of motor vehicles authority.

OTHER PRECAUTIONS



WARNING

This vehicle is not designed to carry standing passengers.



WARNING

CALIFORNIA PROPOSITION 65:

Diesel engine exhaust and some of its constituents are known to the State of California to cause cancer, birth defects and other reproductive harm.

Battery posts, terminals and other related accessories contain lead and lead compounds, chemical known to the State of California to cause cancer and other reproductive harm.

Batteries also contain other chemicals known to the State of California to cause cancer.

Wash hands after handling.

NOTE

When the ignition switch is set to the OFF position, the electrical components are not energized except for the MCM (Master Chassis Module), the battery equalizer, the preheater system and some electronic modules; which are energized during 15 minutes after the ignition has been set to the OFF position. Prior to working on one of these electrical components, set the battery master switch in the main power compartment to the OFF position. If the vehicle will not be operated for a long period (more than 2 weeks), it is recommended, in order to prevent the batteries from discharging, to trip the main circuit breakers located in the main power compartment to stop the small current drawn by the radio preset station memory, the MCM memory and the instrument cluster clock. Note that the radio station presets will be erased, same thing for the diagnostic codes history and the instrument cluster clock will have to be reset.



DANGER

Make sure that electrical current or air pressure is removed before performing any work. A part may be energized even if the ignition switch is OFF. A part may be under pressure even if all tanks are empty. Before performing any work on the vehicle, refer to wiring diagrams and/or air schematics to thoroughly understand the system.

ENGINE COMPARTMENT COMPONENTS	3
ENGINE COMPARTMENT CURB-SIDE DOOR.....	4
ENGINE COMPARTMENT REAR DOOR	4
EXHAUST AFTERTREATMENT SYSTEM ACCESS DOOR	5
ENGINE RADIATOR DOOR	6
SCR ACCESS DOOR	6
CONDENSER COMPARTMENT (A/C)	7
EVAPORATOR COMPARTMENT	8
COOLANT HEATER.....	8
FRONT ELECTRICAL AND SERVICE COMPARTMENT	8
BAGGAGE COMPARTMENTS	9
SPARE WHEEL COMPARTMENT	10
FUEL AND DIESEL EXHAUST FLUID (DEF) FILLER DOOR.....	10
ENTRANCE DOOR.....	11
DOOR OPERATION LOGIC.....	12
EMERGENCY ENTRANCE DOOR OPENING	12
WHEELCHAIR LIFT ACCESS DOORS.....	12
REAR VIEW MIRRORS.....	12
BACK-UP CAMERA.....	13
120 VOLT CONNECTORS	13
HUBODOMETER	13
TRAILER HITCH	13

2-2 Coach Exterior

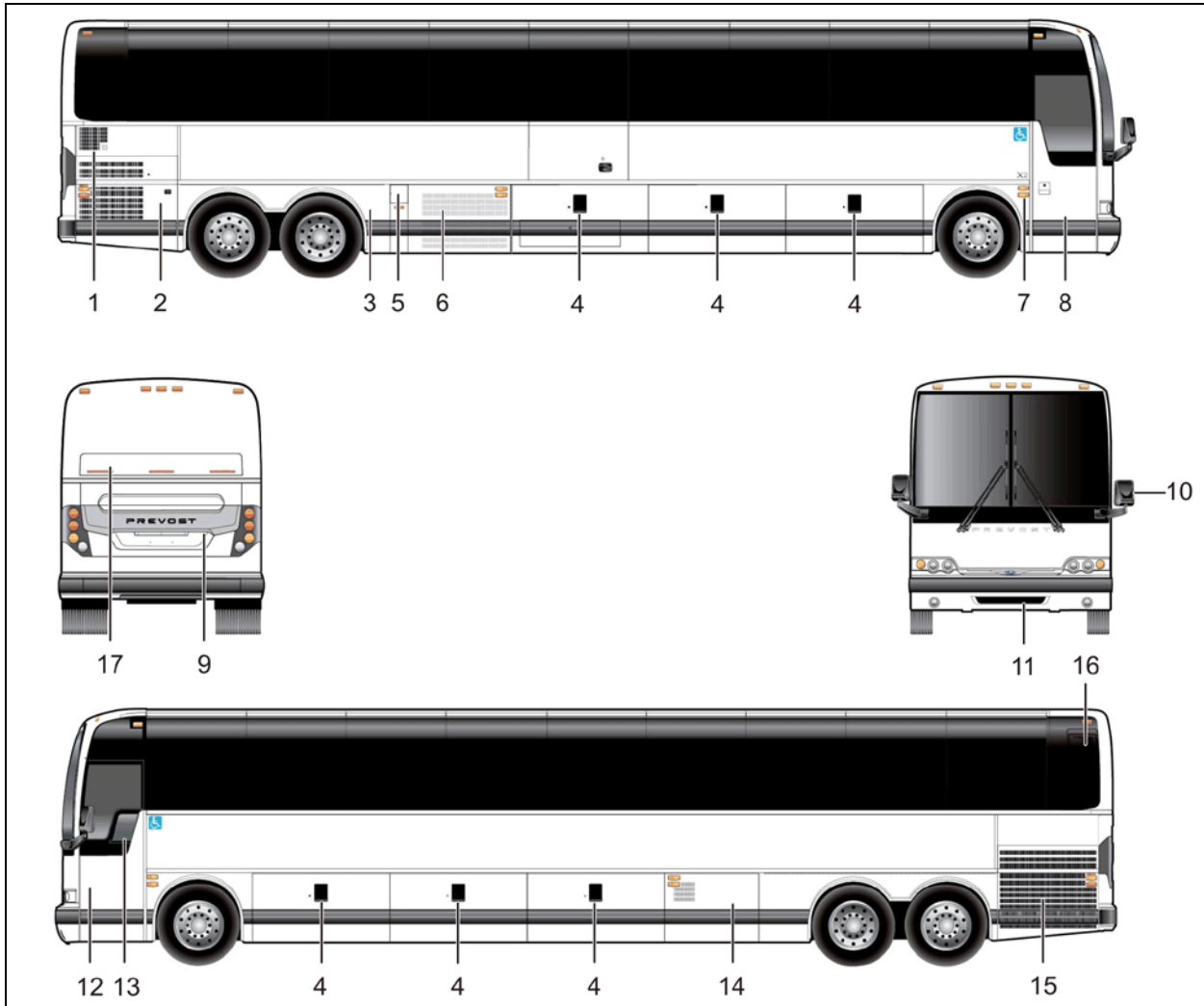

X3-45 EXTERIOR VIEW (TYPICAL)

18707

1. Engine air filter intake grill
2. Engine compartment curb-side door
3. Hinged rear fender
4. Baggage compartment
5. Fuel & DEF filler door
6. Condenser compartment
7. Entrance door control switch
8. Entrance door
9. Engine compartment rear door
10. Rear-view mirrors
11. Spare wheel compartment
12. Front electrical and service compartment
13. Driver's power window
14. Evaporator compartment and coolant heater compartment
15. Radiator door
16. Catalytic converter access door
17. Exhaust aftertreatment system access door

ENGINE COMPARTMENT COMPONENTS

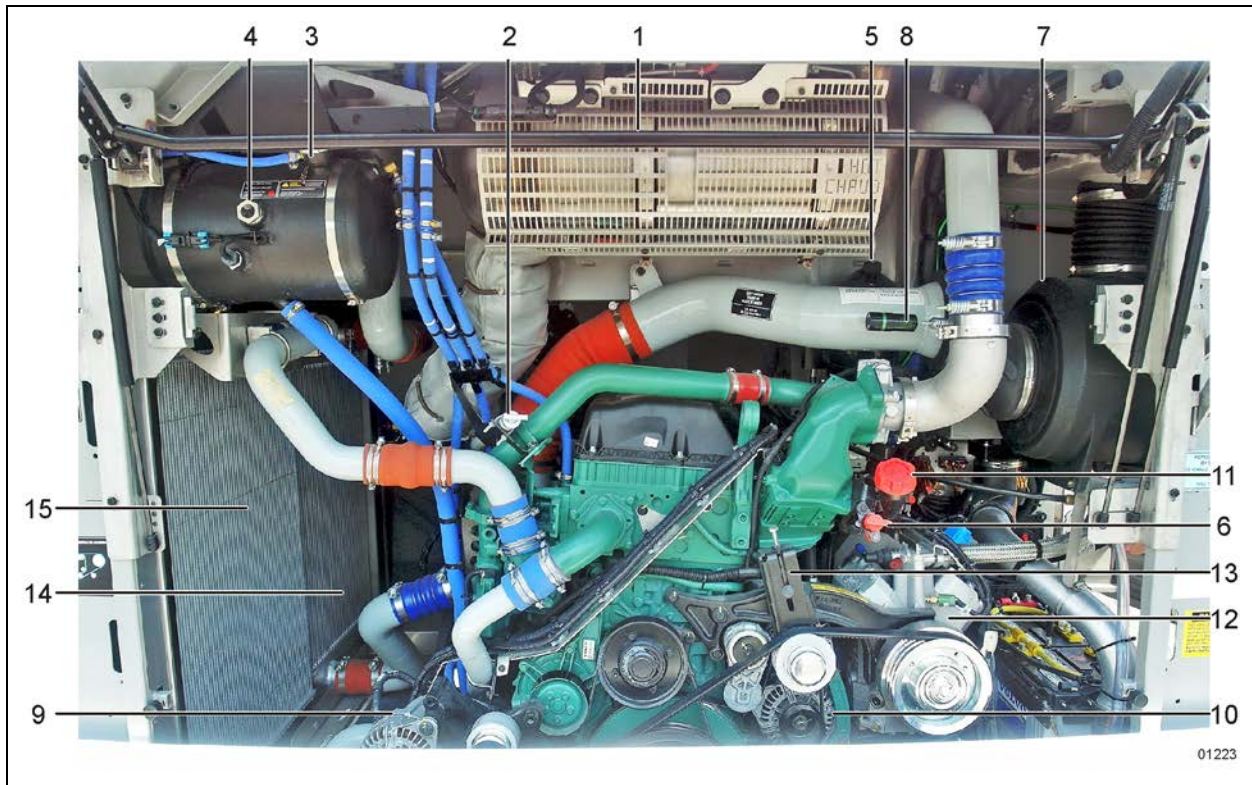

ENGINE COMPARTMENT FEATURING VOLVO D13 ENGINE

1. Diesel Oxidation Catalyst (DOC) & Diesel Particulate Filter (DPF) Assembly;
2. Transmission fluid dipstick (if equipped with Allison transmission);
3. Coolant fluid surge tank filler cap;
4. Coolant fluid surge tank sight glass;
5. Power steering fluid reservoir;
6. Engine oil dipstick;
7. Air filter;
8. Air filter restriction indicator;
9. Alternators, Road side
10. Alternator, Curb side;
11. Engine oil filler tube;
12. Central A/C compressor;
13. Compressor belt tensioner;
14. Charge air cooler;
15. Radiator;

2-4 Coach Exterior

ENGINE COMPARTMENT CURB-SIDE DOOR

The engine compartment curb-side door provides access to the following (if equipped):

- Engine compartment rear door release handle;
- Booster terminals;
- Rear electrical panel;
- Rear junction panel;
- Battery compartment;
- Fuel filter/water separator (Optional);
- Emergency air system fill valve;
- Sump tank access cap;
- 110 - 120 volt connector;
- Lavatory maintenance valve and connectors;
- Fresh water reservoir fill connector;

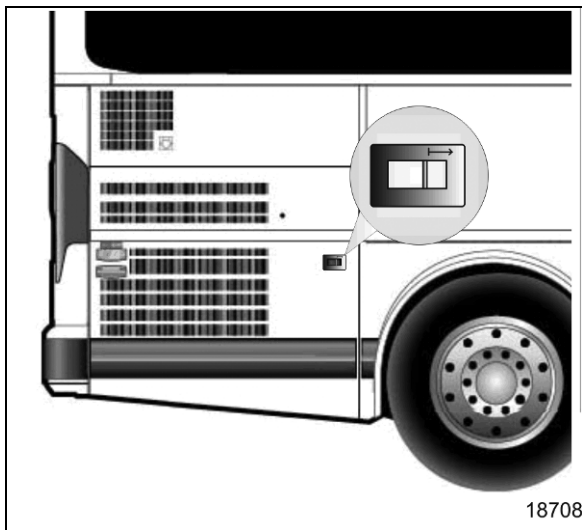

ENGINE COMPARTMENT CURB-SIDE DOOR

This door can be locked or unlocked using the exterior compartment key. To open, pull towards the front on the rod located in the recess to the right of the door.



ENGINE COMPARTMENT R.H. SIDE

18607_1

A telltale light illuminates when one or more compartments are unlocked.

ENGINE COMPARTMENT REAR DOOR

To open the engine compartment rear door, open the engine compartment curb side door and pull the yellow handle located on the rear door, grab the side of the door in the middle, pull and lift the door.



OPENING ENGINE COMPARTMENT REAR DOOR

18608



WARNING

Unless otherwise stated, do not run the engine when the engine compartment is open.

The door swings out to provide access to the following:

- Engine;
- Alternator(s);
- Compressor(s);
- Belt tension control valve (refer to chapter, Care and Maintenance);
- Engine starting selector (refer to chapter, Starting and Stopping Procedures);
- Coolant line shutoff valves;
- Certification plates;
- Engine coolant surge tank and filler cap;
- Air filter restriction indicator;
- Engine oil dipstick;
- Power steering fluid reserve tank;
- Allison automatic transmission fluid dipstick;

NOTE

The engine compartment lights will turn on automatically when the engine door is opened.

A catch engages to maintain the door in the full open position. To close the door, slightly lift up the door and release the catch before firmly shutting down the door.



REAR DOOR SAFETY CATCH



WARNING

Unless otherwise specified, do not run engine when the engine compartment rear door is open. Close the engine compartment rear door before starting the engine.

EXHAUST AFTERTREATMENT SYSTEM ACCESS DOOR

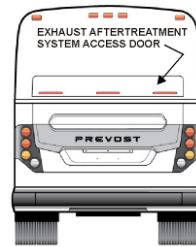

The engine door must be open before opening the exhaust aftertreatment system access door. To open the access door, lower the latch release lever, using a flat tip screwdriver.

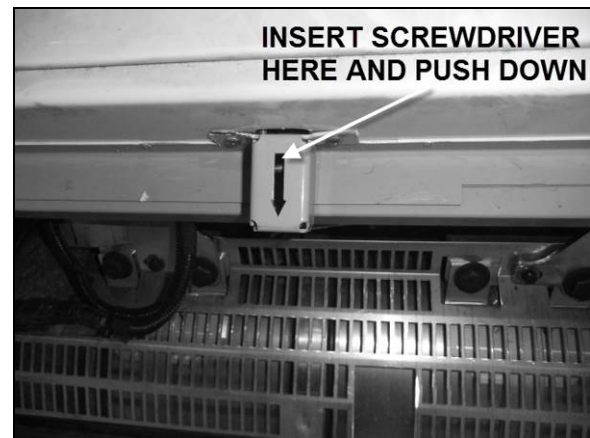

AFTERTREATMENT ACCESS DOOR LATCH

To close the door, lower the door and push against the release lever spring to latch the door shut.

2-6 Coach Exterior

ENGINE RADIATOR DOOR

The engine radiator door gives access to the radiator electrical fans and power distribution box.



RADIATOR DOOR

Open the engine compartment rear door to access the engine radiator door release handle

Radiator door release handle is located inside the left pillar (Arrow).



RADIATOR DOOR HANDLE LOCATION

Pull handle towards you to release radiator door.



RADIATOR DOOR RELEASE HANDLE



RADIATOR DOOR OPENED



WARNING

WHEN THE ENGINE IS RUNNING...

Cooling fans may activate at any moment.

Keep hands away from cooling fans or keep the radiator door closed.



WARNING

Cooling fans may be running when the engine is shut down in the following conditions:

- If a High Exhaust Temperature condition exists (e.g. following regeneration). The CAC fans will keep running for a maximum of 15 minutes.
- During the electric **Motor Test Sequence**, the cooling fans will start running briefly.

SCR ACCESS DOOR

To gain access to the SCR, open the radiator door first. At the top of the radiator compartment, pull the catch connecting rod to unlock the catalytic converter access door and lift the door open.

Hold the door open by inserting the support rod free end into the receptacle located on the left side of the DPF.

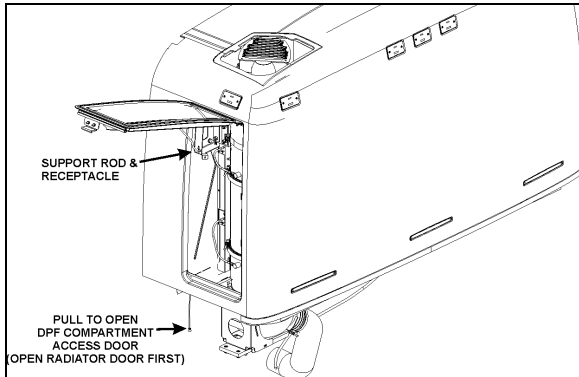

ACCESS TO THE SCR

04023

**WARNING**

After inserting the support rod into the receptacle, make sure the rod supports the door securely from falling down on to your head or body.

**WARNING**

External and internal temperatures remain hot long after engine has been shut down. Allow the Exhaust Aftertreatment System to cool before handling. Wear protective clothing and glove while servicing.

CONDENSER COMPARTMENT (A/C)

Pull the release latch located inside the adjacent baggage compartment to open the condenser door.

The condenser compartment provides access to the following:

- Diesel Exhaust Fluid (DEF) Tank
- Condenser;
- Condenser fans and motors;
- Filter dryer and moisture indicator;
- Receiver tank;

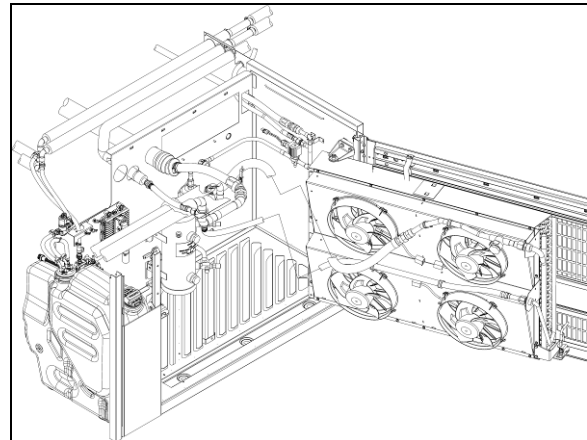

CONDENSER COMPARTMENT (A/C)

22299

**CAUTION**

Only the strap should be used to pull the condenser-fan assembly open. Damage to condenser could result if pulling by other means.



CONDENSER COMPARTMENT STRAP

EVAPORATOR COMPARTMENT

The HVAC (Heating, Ventilating and Air-Conditioning) evaporator and heater coils are located in this compartment along with the blowers.

The evaporator compartment door release latch is located on the right wall of the baggage compartment, left of the door. Pull the release latch then slide your hand in the opening to depress the secondary lock and swing open.

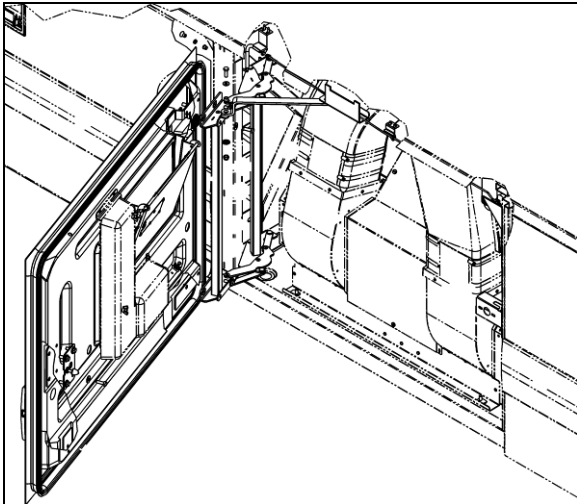

EVAPORATOR COMPARTMENT



SECONDARY LOCK LEVER

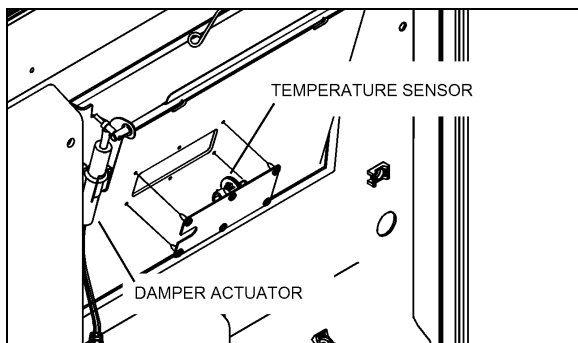

FRESH AIR DAMPER

22302_A

COOLANT HEATER

The vehicle may be equipped with the optional preheater located aft of the evaporator compartment, and accessible under left rear fender.

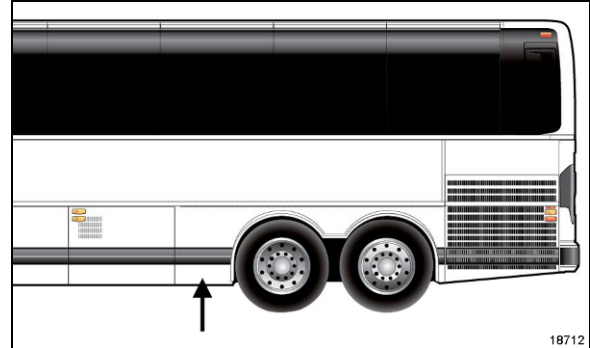

LOCATION OF PREHEATER

18712

The water recirculating pump is also located in this location.

FRONT ELECTRICAL AND SERVICE COMPARTMENT

To open the front electrical and service compartment door, pull the rod inside the vehicle, next to the driver's power window or use the key to open from outside the coach.

The electrical section of the front compartment provides access to the following:

- Vehicle Electrical Center Front (VECF)
- Relays and diodes;
- MCM;
- Front terminal block;
- IOE-B Multiplex Modules;
- VECU ;
- ABS Electronic Control Unit (ECU);
- IOE-A Multiplex Modules;

The lower section of the front service compartment provides access to the following:

- Emergency door opening unlatch valve;
- Windshield washer reservoir & headlights washer reservoir (optional);
- Accessories air tank fill valve;
- Accessories air tank drain valve;
- Jack and tools.

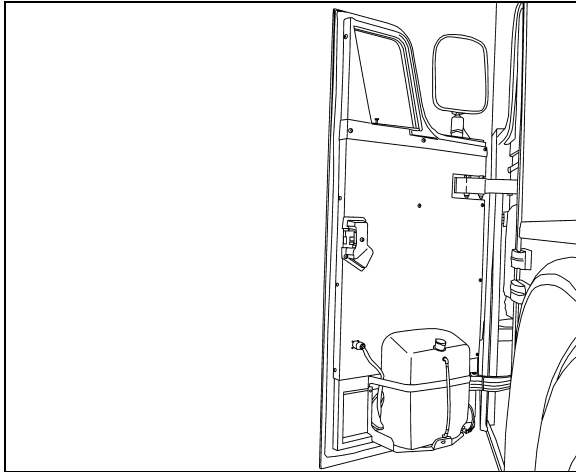

FRONT SERVICE COMPARTMENT DOOR 18610

This compartment door can be locked/unlocked using the exterior compartment key.

The light in the front electrical and service compartment turns *ON* automatically when the door is opened.

NOTE

Jack and tools are located inside the front electrical and service compartment.

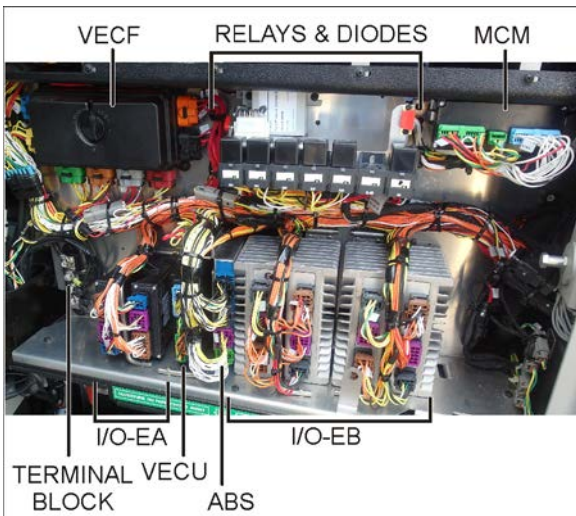

FRONT ELECTRICAL COMPARTMENT 06779

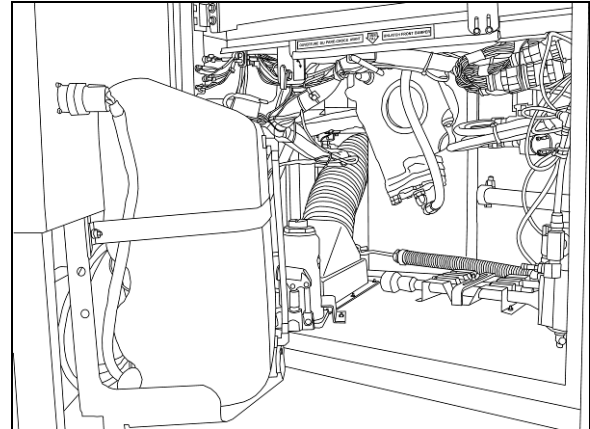

FRONT SERVICE COMPARTMENT 18611

BAGGAGE COMPARTMENTS

The baggage compartments of the X3-45 Coach provide 406 ft³ (11.5 m³) of storage capacity. The compartments can be locked or unlocked by using the exterior compartment key. Pull up operating handle to release the latch, and then pull the door open. Pressurized cylinders assist the opening and closing of the baggage compartment doors and hold the doors open.

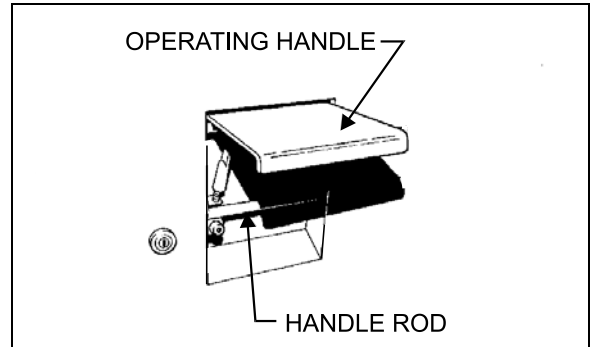

BAGGAGE DOOR LOCK AND LEVER 18043

To close, pull the door down by the handle rod. Complete the closing of the door by returning the operating handle to its initial position.

CAUTION

Do not slam shut the baggage compartment doors. Damage to door weather-stripping or locking mechanism could result.

Lights in the baggage compartments turn *ON* automatically when the door is opened.

2-10 Coach Exterior



BAGGAGE DOOR CATCH

18612

NOTE

For added safety, open the door until the catch assist in holding the door in the open position. Lift lever to release door

NOTE

The baggage compartment doors can be locked/unlocked from the driver's position by the optional central locking system. The switch is on the L.H. control panel. Refer to "Controls & Instruments" chapter.



WARNING

To avoid injury, keep hands clear of baggage compartment door edge and door frame when closing.

NOTE

To prevent theft and vandalism, always lock the baggage compartment doors before leaving the vehicle unattended.

SPARE WHEEL COMPARTMENT

The front bumper can be tilted downward to give access to the spare wheel.



WARNING

The compartment behind the bumper is not designed for miscellaneous storage. Never store loose objects in this compartment since they can interfere with the steering linkage mechanism.

Pull the release handle located inside front service compartment to tilt down the entire bumper assembly.

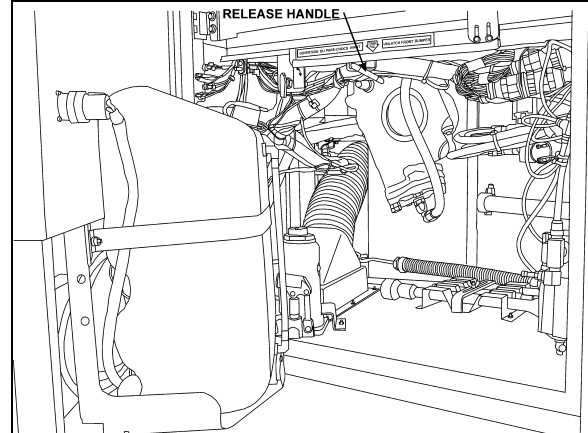

RELEASE HANDLE

18613

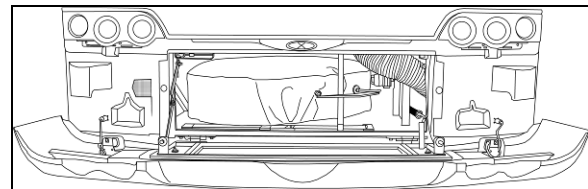

SPARE WHEEL IN FRONT BUMPER COMPARTMENT 18614



WARNING

Although a powerful spring assists in reclining the bumper, it remains heavy and rests low when open. Caution should be used when reclining.

Check that bumper is securely closed shut before driving.

FUEL AND DIESEL EXHAUST FLUID (DEF) FILLER DOOR

The fuel and Diesel Exhaust Fluid (DEF) filler door is located on the R.H. side of the coach providing easy filling. A spring keeps the door either open or shut. A key is provided for unlocking the door if the option was chosen.

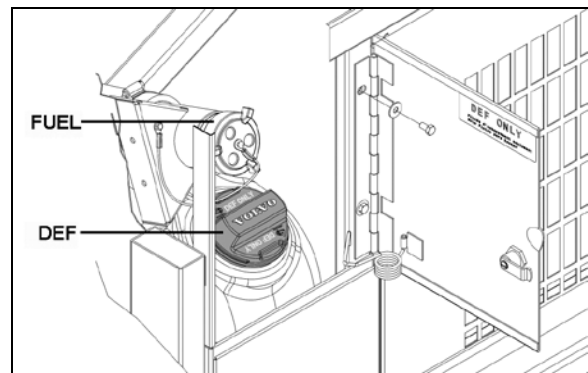

FUEL & DEF FILLER DOOR

03046

NOTE

Provided the vehicle is parked on level ground, an automatic nozzle will automatically shut off when fuel tank is approximately 95% full.

NOTE

The fuel & DEF filler door must be in the unlocked position before closing

**CAUTION**

Diesel exhaust fluid DEF will begin to crystallize and freeze at 12°F (-11°C) and expand by 7% when frozen. To allow expansion without damaging the DEF tank, do not fill the tank with more than 15.9 gallons (60 liters).

**CAUTION**

Do not fill to more than 95% of the fuel tank capacity. Do not "top off" the tank, doing so may result in fuel spillage when the fuel expands.

ENTRANCE DOOR

Lock or unlock the entrance door from outside the vehicle by turning the key in the door lock (counterclockwise to lock, clockwise to unlock).

From outside, open the door by pushing the switch forward, close by pushing the switch rearward.

The only way to unlock the entrance door from the inside is by sliding its lock lever to the left. If the orange tab on the door-lock lever is visible, the door is unlocked.

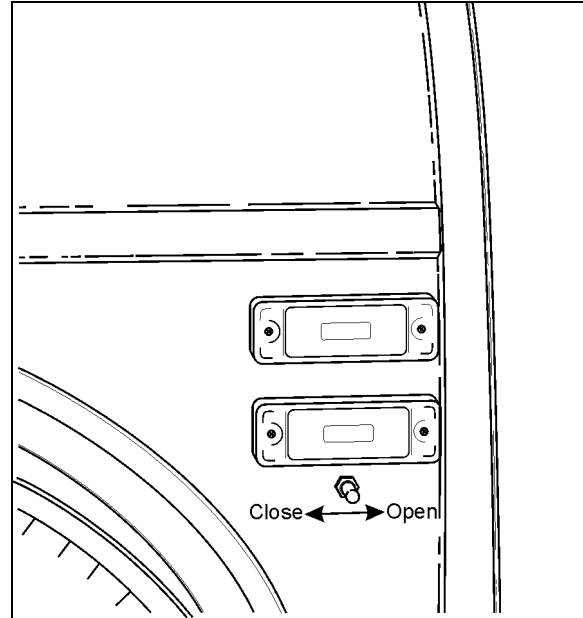
**ENTRANCE DOOR EXTERIOR SWITCH**

18599

From the inside, open the door by pressing the door opening switch (L.H. button) on the R.H. dashboard panel. Close by pressing the door closing switch (R.H. button) on the dashboard. Refer to "Controls and Instruments" chapter for more information.

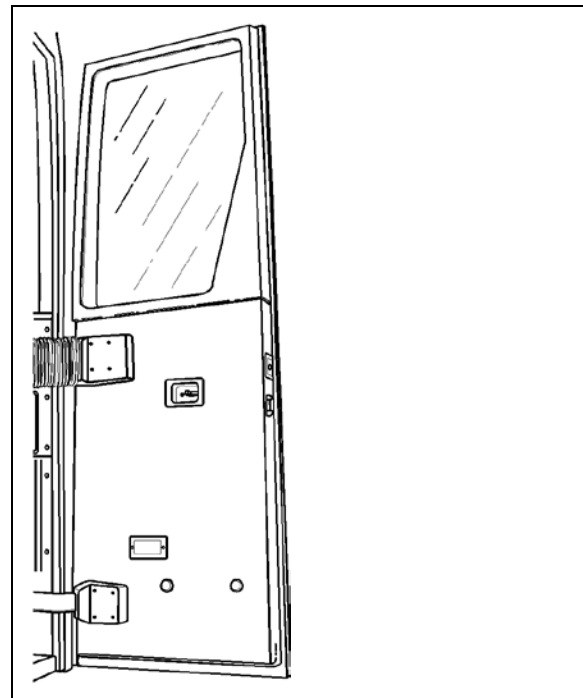
**ENTRANCE DOOR**

18001

2-12 Coach Exterior

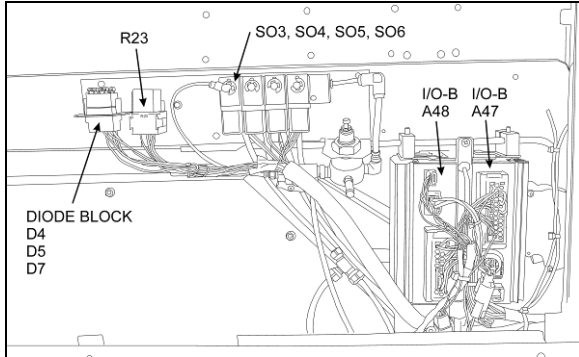

ENTRANCE DOOR & WIPER CONTROL PANEL 06614

DOOR OPERATION LOGIC

If the switch is held in position until the door is fully open or closed, the system holds pressure in the door cylinder, locking the door in that position. The door can be opened to any position by releasing the switch (or button, if inside) when the desired position is attained. However, the door is not locked in any position other than fully open or fully closed. The door can then be opened or closed further by pushing or pulling on the door.

A proximity sensor will finish the closing of the door when it senses the door is almost shut. This works even when the door is shut manually.

EMERGENCY ENTRANCE DOOR OPENING

Refer to "Safety Features and Equipment" chapter.

WHEELCHAIR LIFT ACCESS DOORS

To open the optional wheelchair lift access doors, the coach must be parked on a flat and level surface with the parking brake on. Using the exterior compartment doors key, unlock and carefully lower the lift mechanism access door which is part of the baggage compartment door. The lift mechanism access door is located directly below the wheelchair access door. A handle at the left of the lift mechanism unlocks and enables opening of the wheelchair access door. If the parking brake is not activated, a switch in the door will activate the parking brake when it detects the door is open.

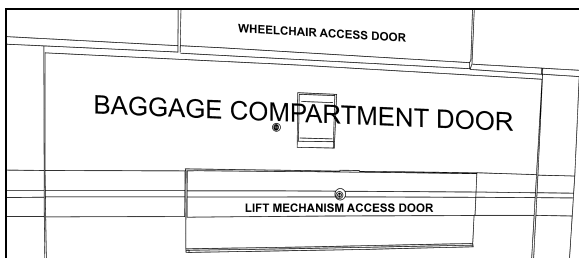

WHEELCHAIR LIFT ACCESS DOORS 18615

Open the wheelchair access door completely until it locks in the open position. To close the door, pull on the tab located on the inside of the door and slam the door shut. Refer to "Other Features" for more information on operating the optional wheelchair lift.

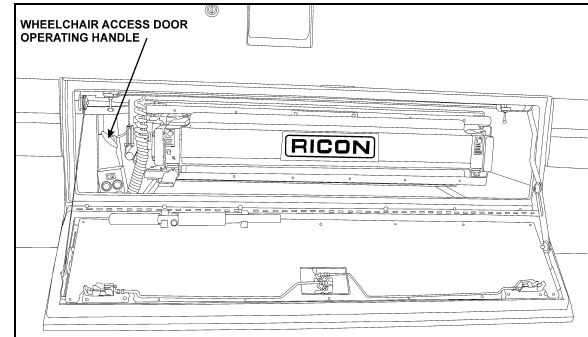

WHEELCHAIR ACCESS DOOR OPERATING HANDLE 18616

REAR VIEW MIRRORS

The vehicle is equipped with flat-type and convex-type rear-view mirrors. Convex mirrors give a wide angle view. Objects viewed in convex-type rear-view mirrors appear smaller and are actually closer than they appear.

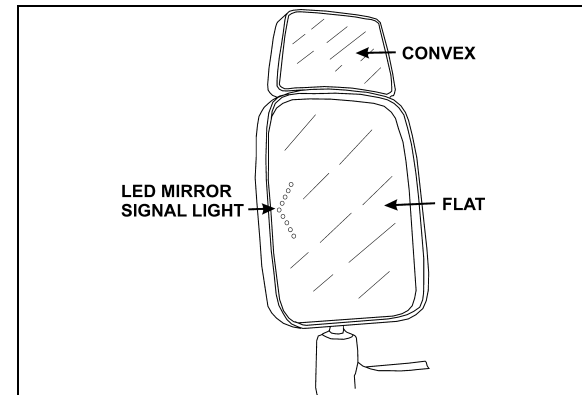

REAR VIEW MIRRORS 18668

To provide good visibility in cold weather, the mirrors can be equipped with heating elements. The elements are activated by a rocker switch located on the dashboard. Refer to "Controls & Instruments" chapter. Thermostats are used to prevent continuous operation of the heating elements.



CAUTION

Do not attach stick-on type convex mirror accessories to the heated mirror glass. This could impede uniform heat distribution on the mirror surface and could break the mirror glass.

As an option, the mirrors may be equipped with LED turning signal lights to give an additional signal light when turning or changing lane for extra safety or for other divers to see your signal when driving too close, in rain, fog or when in blind spot.

The mirrors are adjusted using the controls located on the L.H. control panel. Refer to "Controls & Instruments" chapter. Manual adjustment is also possible.

BACK-UP CAMERA

An optional back-up camera is available which provides the driver with visual assistance when backing-up. Camera monitor is installed on the dashboard L.H. side, on the windshield post. For additional information, refer to "Controls & Instruments".

120 VOLT CONNECTORS

One connector is provided for the electric block heater to connect to a 120 VAC power source. It is located near the engine compartment rear doors release handle. (Refer to chapter "Starting and Stopping Procedures").

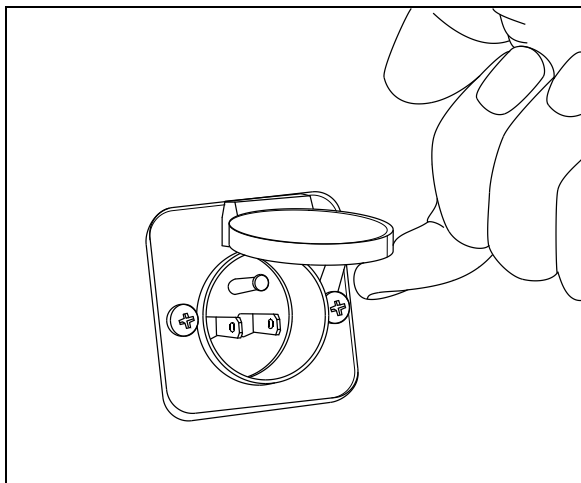

BLOCK HEATER 120 VOLT CONNECTOR 06390

Another connector is used to connect the battery charger to a 120 VAC power source. It is located above the engine compartment curbside door next to the air filter intake grill.

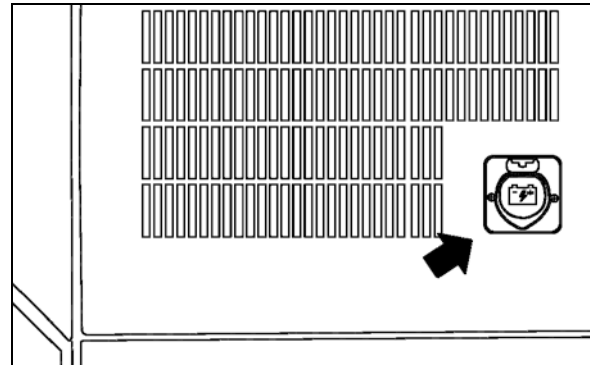

BATTERY CHARGER 120 VOLT CONNECTOR 06780

HUBODOMETER

An odometer is installed on the curb-side drive axle wheel hub. The odometer calculates the total distance in miles or kilometers (depending on model installed) traveled by the coach since manufacture, including factory road testing.

NOTE

It is normal for the hubodometer, the engine ECM and the vehicle odometer to disagree on the total mileage.

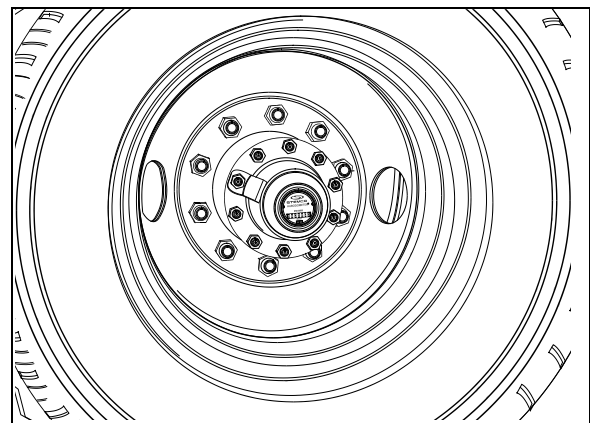

HUBODOMETER 13012

TRAILER HITCH

20 000 lbs. max. Gross trailer weight capacity (optional)

Your vehicle may be equipped with a factory installed trailer hitch which has been designed to meet the following rating:

2-14 Coach Exterior

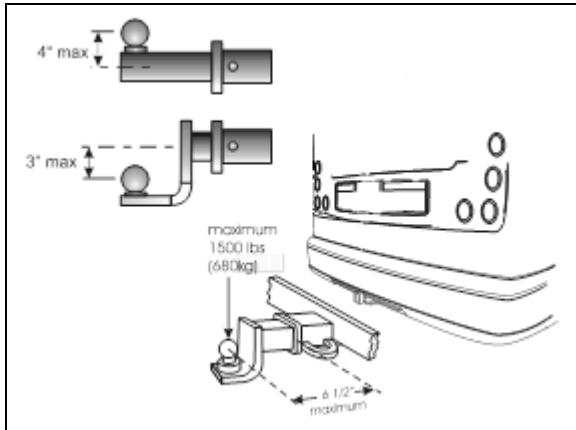

TRAILER HITCH

23337_2

- Maximum gross trailer weight: 20,000 lbs. (9072 kg)
- Maximum tongue weight at 6 1/2 inches (165 mm) or less from coupling receiver: 1,500 lbs. (680 kg)



DANGER

The draw bar and the ball used for towing the trailer should be rated for 20,000 lbs. capacity or more.



WARNING

Pulling a trailer weighing more than the recommended maximum gross weight may cause engine and transmission overheating, and also possible hitch failure.

NOTE

Pulling a trailer over long distances is considered as a "severe operating condition" for the vehicle and therefore, power plant requires more frequent servicing.

NOTE

The minimum requirement for a trailer weighing up to 20,000 lbs. when coupled to a 20,000 lbs. Prevost Trailer Hitch is as per the following:

1. Trailer must comply with **Federal Motor Carrier Safety Regulations 393.52** regarding trailer breaking capability.
2. The trailer coupling attachments meet the following minimum static test load requirements :
 - Longitudinal tension and compression: (1.5 x GVWR of trailer)
 - Transverse thrust: (0.5 x GVWR of trailer)
 - Vertical tension and compression: (0.5 x GVWR of trailer)

Loads indicated must be applied without incurring loss of attachments or distortion or failure which could affect the safe towing of trailer.

3. The ball and trailer coupling should meet the following minimum test load requirements without incurring failure:
 - Longitudinal tension and compression: (Gross Trailer Weight of trailer x 3)
 - Transverse thrust: (Gross Trailer Weight of trailer x 1)
 - Vertical tension and compression: (Gross Trailer Weight of trailer x 1.3)

In this case, failure is identified as the point at which the coupling or ball will accept no additional test load without separation of the ball from the coupling ball socket, or the occurrence of a metal fracture of either coupling ball or coupling assembly, which results in separation of the ball from the coupling ball socket.

4. Two lengths of safety chain shall be used. The strength rating (minimum breaking force) of each individual chain and its connecting means shall be equal to, or exceed the trailer GVWR.
5. Towing vehicle must be equipped with engine or transmission retarder. The engine or the transmission retarder on the vehicle must be functional at all time (to be inspected frequently).

ELECTRONIC DESTINATION SIGN 2

UTILITY COMPARTMENTS 2

MICROPHONE JACKS 2

STEERING WHEEL ADJUSTMENT..... 2

AISLE MIRROR 3

ADJUSTABLE HVAC REGISTERS 3

DRIVER’S SEAT - ISRI..... 3

 MECHANICAL ISRI SEAT 3

 PNEUMATIC ISRI SEAT 4

DRIVER’S SEAT – USSC 9100ALX 5

 DRIVER SEAT BELT 5

PASSENGER SEATS 6

 PASSENGER SEAT BELT 6

 SWIVEL SEATS 7

 FOLDING TRAYS 7

CARD TABLE 7

OVERHEAD CONSOLE 7

 ADJUSTABLE AIR REGISTERS 8

 SERVICE BELL 8

 READING LIGHTS..... 8

 PANORAMIC WINDOWS 8

 DRIVER’S POWER WINDOW..... 9

 DRIVER’S WINDOW SHADES 9

VENTILATION HATCH 9

OVERHEAD COMPARTMENTS 10

WASTE CONTAINER..... 10

GALLEY 10

LAVATORY..... 10

ELECTRONIC DESTINATION SIGN

Turn the optional destination sign lighting on and off using the rocker switch located on the dashboard. Refer to Controls & Instruments chapter.

Depress the selecting switches until the desired destination appears in the Liquid Crystal Display.

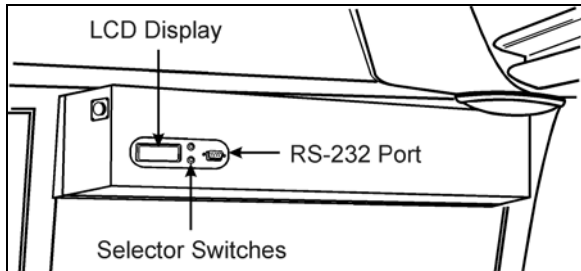

ELECTRONIC DESTINATION SIGN 23123

NOTE

The destination sign must be programmed with a computer connected to the RS-232 connector prior to first use. Follow the instructions on the computer disk to install and run the software.

UTILITY COMPARTMENTS

Two lockable utility compartments are located at the base of the windshield. Another utility compartment is located on the console, and includes a 12 volt appliance socket.

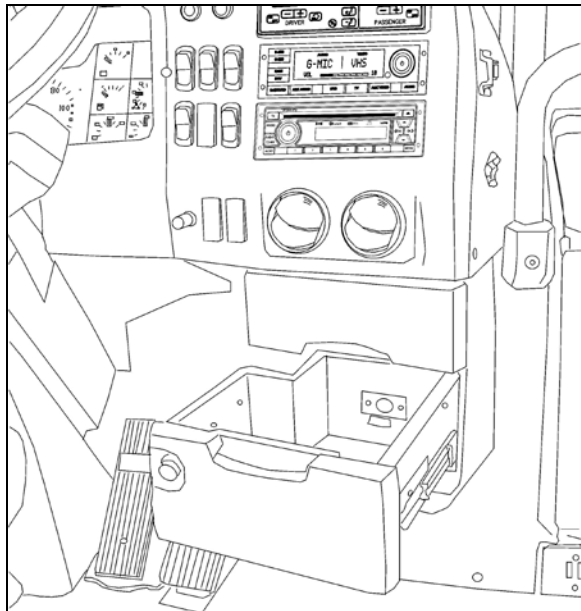

UTILITY COMPARTMENT IN CONSOLE 18669

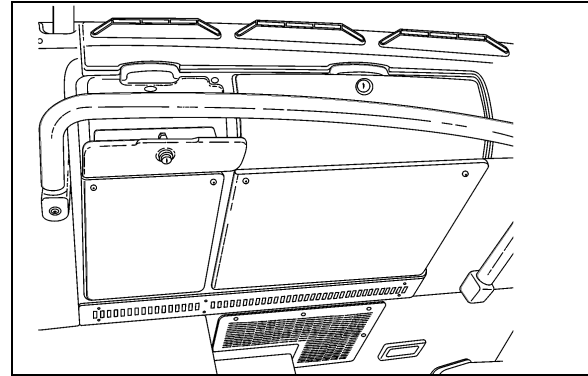

UTILITY COMPARTMENTS 18602

MICROPHONE JACKS

Up to six microphone jacks for the PA system can be located in the following locations:

- On the side wall of the driver's control panel;
- On the right hand side of the dashboard;
- One optional outlet for the tour guide on each of the modesty panels;
- One optional outlet on the lavatory wall, behind the last row of seats;
- One optional outlet under the overhead storage compartment, at the rear of the coach.

STEERING WHEEL ADJUSTMENT

Push on the valve button located in the foot-operated control housing to unlock the steering wheel for tilt and telescopic adjustment (refer to "Controls and Instruments" chapter).

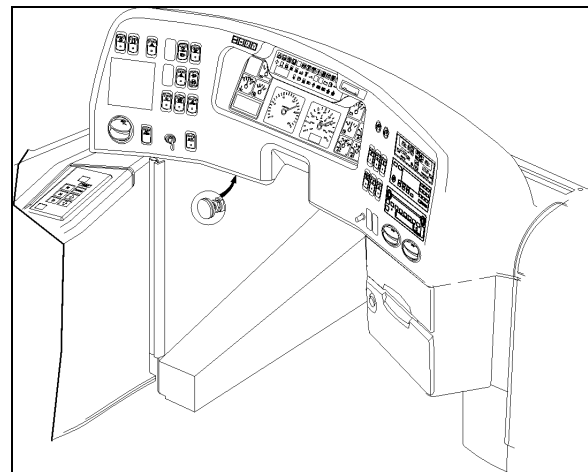

TILT AND TELESCOPIC ADJUSTMENT 18670



DANGER

Do not adjust the steering wheel while driving. Loss of control could result. Park the vehicle safely and apply parking brakes before adjusting the steering wheel.

AISLE MIRROR

A central mirror allows the driver to see in the aisle. Adjust mirror manually.

ADJUSTABLE HVAC REGISTERS

The HVAC system has adjustable registers to control air flow around the driver's area. Three are located on the dashboard; two on the R.H. side and one on the L.H. (refer to Controls & Instruments chapter). Another one is located close to the door, below the modesty panel wall for step de-icing. The direction and volume of air flow are adjustable manually.

Use the HVAC control panel to set air temperature.

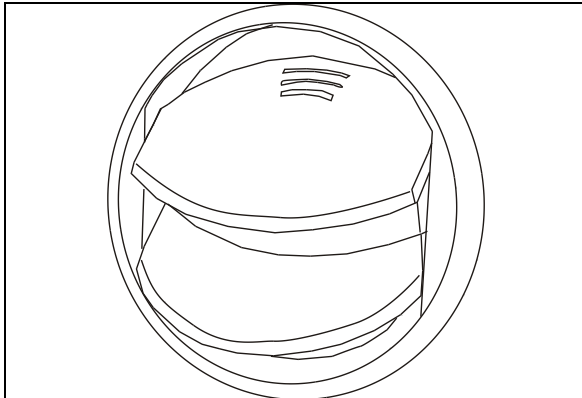

AIR REGISTER

22249

DRIVER'S SEAT - ISRI

The vehicle can be equipped with one of two models of *ISRI* driver's seats. Standard is the mechanically adjusted seat and pneumatic model is available as an option. Both seats are equipped with safety belts. Lumbar supports, heated cushions and adjustable armrests are optional.



DANGER

The driver's seat must be adjusted to allow the driver easy access to the coach controls. Never adjust seat while driving vehicle as this could result in loss of vehicle control.



DANGER

Make sure that seat is adjusted and that safety belt is buckled up before diving vehicle.

MECHANICAL ISRI SEAT

Adjustment

Seat can be adjusted to the desired driving position by following the instructions listed below:

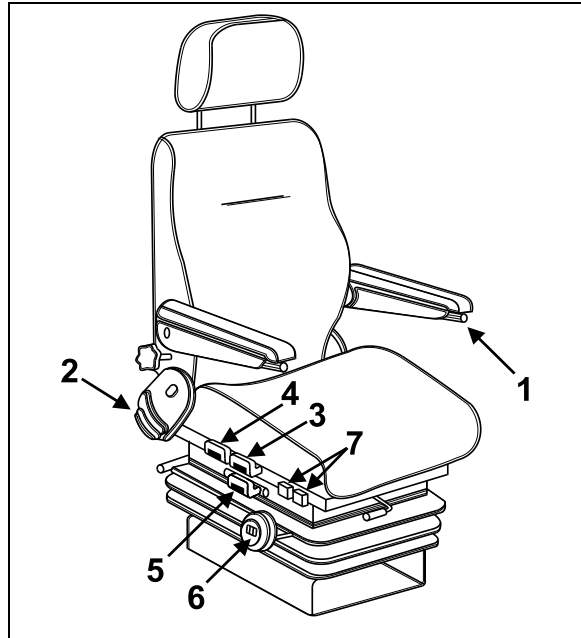

DRIVER'S SEAT ADJUSTMENT (MECHANICAL)

18333

Armrest

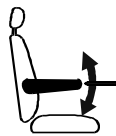

18334

The driver's seat can be equipped with two folding armrests.

To lower the armrest:

- Turn control knob #1 (refer to figure: Driver's seat adjustment (mechanical)) counter-clockwise without applying pressure on the armrest
- Push the armrest down.
- Repeat procedure until desired position is reached.

To raise the armrest, move it to the desired position and turn control knob clockwise until it stops.

3-4 Coach Interior

Backrest

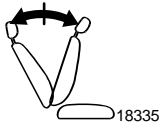

Lift lever #2 then adjust backrest to the desired angle.

Tilt (front)

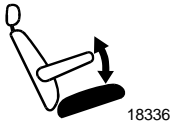

To lower or raise the seat's front section, pull handle #3 up and push or pull the seat cushion.

Tilt (rear)

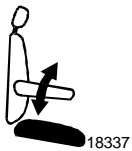

To lower or raise the seat's rear section, pull handle #4 up and push or pull the seat cushion.



WARNING

To avoid pinching the fingers between buckle and controls, lower safety belt buckle before adjusting seat height

Up and Down

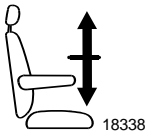

Pull both handles (3 and 4) up to adjust height of the seat.

Fore and Aft

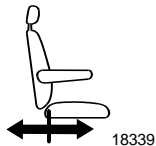

To adjust distance between driver and dashboard, pull handle #5 up and slide the seat forward or backward.

NOTE

Fore-and-aft seat adjustment control may also be located at the front of the seat.

Suspension

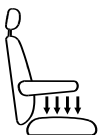

For maximum mechanical suspension performance, rotate handwheel #6 until your body weight (in pounds) is shown on the indicator.

The seat suspension resistance can be changed to suit the driver. Turn handwheel clockwise to increase suspension resistance and counter-

clockwise to decrease resistance.

Lumbar Support



To inflate the upper lumbar support bellows, depress the front rocker switch #7 upward. To deflate, depress the rocker switch downward.

Follow the same procedure to inflate and deflate the lower bellows using the rear rocker switch.

Headrest

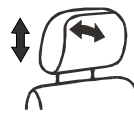

The headrest can be adjusted forward, rearward and vertically by 2 inches (50 mm). Directly move headrest to desired position.



DANGER

For best protection, position headrest behind your head, not behind your neck.

PNEUMATIC ISRI SEAT

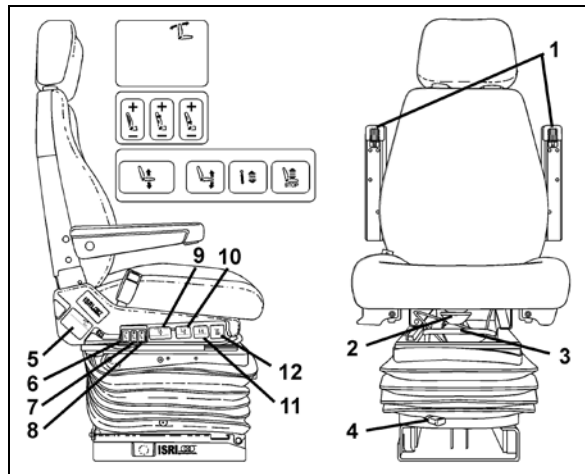

PNEUMATIC DRIVER'S SEAT

18385

Armrest (1)

Rotate control knob to select desired arm-resting angle. When not in use, raise armrest parallel with backrest.

Seat Cushion (2)

Provides optimum comfort and support for any driver size. Adjustable to 50 mm (2 inch) length.

Fore-and-aft (3)*

Pull handle up and slide seat forwards or backwards to adjust distance between seat and dashboard.

Isolator (4)

Reduces horizontal vibration, ensuring smooth ride.

Backrest (5)

Lift lever to select proper angle of backrest.

Air Side Bolster (6)

Offers desired side support to avoid body side-way.

Air Lumbar (7) (8)

Provides back support with upper and lower settings, ensuring comfort during lengthy sitting.

Air Height Adjustment (9)

Moves seat up or down independently of other seat settings. 100 mm (4 inch) total travel.

Adjustable Seat Recline (10)

Allows easy adjustment of four-setting inclination.

Adjustable Shock Absorber (11)

Choose stiff or soft ride infinitely.

Quick Air Release (12)

Exhausts all air from suspension, allowing for easy entry/exit. Returns seat to previous position.

DRIVER'S SEAT – USSC 9100ALX

The coach can be equipped with USSC 9100 ALX air suspension seat. This seat is equipped with 3-point safety belts, lumbar supports, dual shock suspension damping and quick dump air release. This seat also features adjustable headrest.

 <b style="font-size: 1.2em; margin-left: 10px;">DANGER
<p>The driver's seat must be adjusted to allow the driver easy access to the coach controls. Never adjust seat while driving vehicle as this could result in loss of vehicle control.</p>

 <b style="font-size: 1.2em; margin-left: 10px;">DANGER
<p>Make sure that seat is adjusted and that safety belt is buckled up before diving vehicle.</p>

DRIVER SEAT BELT

The driver's seat is equipped with a retractable seat belt as required by State, Provincial and Federal regulations.

 <b style="font-size: 1.2em; margin-left: 10px;">WARNING
<p>A snug fit with the lap belt positioned low on the hips is necessary to maximize driver safety. The belt should not be worn twisted. Avoid pinching belt and/or belt hardware in seat mechanism. Do not wear belt over rigid or breakable objects, such as eyeglasses, pens or keys as these may cause injuries.</p>

 <b style="font-size: 1.2em; margin-left: 10px;">CAUTION
<p>Never bleach or dry clean safety belt.</p>

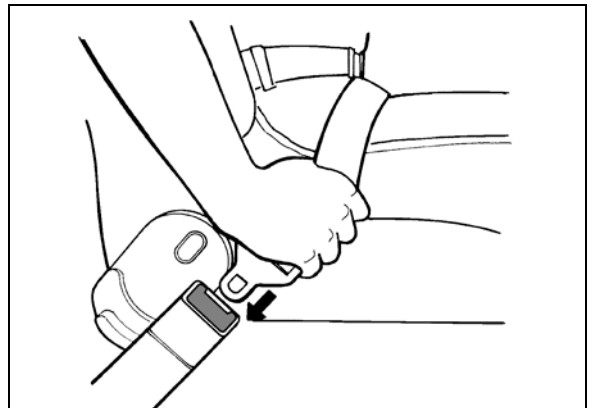

FASTENING SEAT BELT 18028

To unfasten belt, press the red button in center of buckle and allow belt to retract. If the belt does not fully retract, pull it out and check for kinks or twists. Make sure that it remains untwisted as it retracts.

3-6 Coach Interior

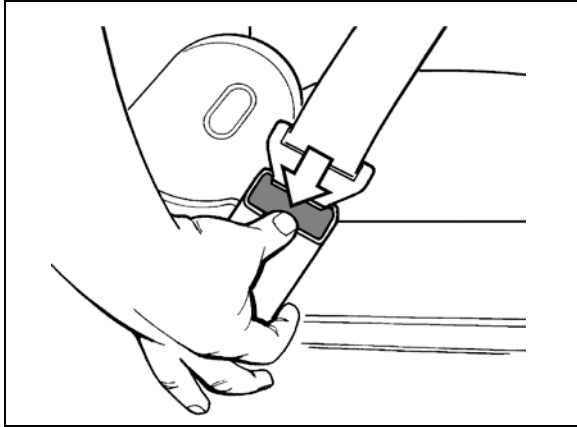

UNFASTENING SEAT BELT 18029



DANGER

Most State and Provincial laws require that safety belts be worn when they are supplied with the seat.

PASSENGER SEATS

Passenger seats may be equipped with grip handles, newspaper holders, trays, cup holders and footrests.

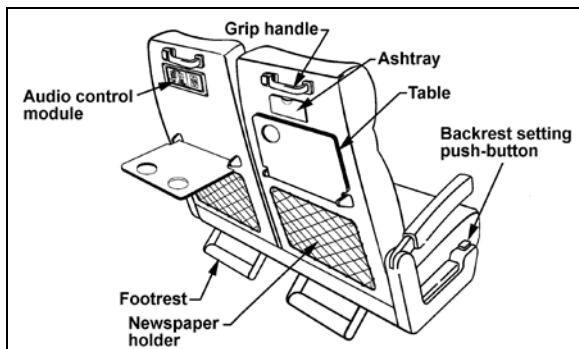

PASSENGER SEAT EQUIPMENT

18121A

All seats are track-mounted so that the seating configuration can be changed. Each set is mounted on rectangular aluminum bases to make cleaning between the base and side wall easier.

Passenger seat backrests can be tilted by using the push-button located on the base of the seat. Depress and hold push-button, then adjust backrest to the desired angle. Release push-button to lock backrest in position.

A folding armrest is installed on the aisle side of the passenger. Another folding armrest is located between the two seats and can be raised for passenger convenience. A fixed armrest is installed on the window side of the seat.

PASSENGER SEAT BELT

Passengers are strongly advised to wear seat belts at all times. Children can use a passenger seat belt as long as they are large enough to properly wear the seat belt. The shoulder belt must be correctly positioned over the child's shoulder and it must not touch the neck or lie below the shoulder.

To fasten, pull seat belt out of the retractor and insert the latch plate into the buckle until it clicks. No special adjustment is required since the retractor device is self-adjusting. If the seat belt operation becomes defective, report to maintenance personnel immediately.

ELR/ALR Retractor Lock Mode

Amaya passenger seat belts are equipped with switchable ELR/ALR retractor lock mode:

- **Emergency Locking Retractor (ELR) mode:** Allows the seat belt to extend and retract to allow passengers some freedom of movement in the seat. Locks only when the vehicle or occupant slows quickly/abruptly or stops suddenly. **Will not secure a child safety seat.**
- **Automatic Locking Retractor (ALR) mode:** Locks and maintains a fixed seat belt (lap belt) length during use. The belt cannot be extended further. **For use with a child safety seat.**



CHILD RESTRAINT SYSTEMS

Occupants under 40" height must use Child Seat / Booster

The seat belts are equipped with switchable ELR/ALR retractor lock mode.

Activate the ALR retractor lock mode to hold a child restraint system by pulling the shoulder belt all the way out. Allow it to retract to desired length. Check that the belt straps are fully tightened and the retractor / webbing is locked.

Note: Unbuckling the belt and allowing it to retract fully deactivates the ALR retractor

Failure to use the ALR lock mode will result in the child safety seat not being properly secured.

When using a **booster seat**, do not pull the shoulder belt all the way out. Doing so would engage the ALR lock mode which is not recommended with booster seat.

Install the child seat/booster according to the manufacturer's instructions.

SWIVEL SEATS

The coach may be equipped with two sets of swivel seats to allow installation of card tables. The swivel seat can be rotated for passenger privacy. To rotate seats, unscrew the wing nut from under each seat cushion then remove cushions. Remove the four wing screws, pull seats toward the aisle and rotate the seat counter-clockwise. Align mounting holes, secure with wing screws and install seat cushions.

NOTE

Instructions for making swivel seat adjustments are affixed on the rear frame under the seat cushion.

FOLDING TRAYS

Two optional folding tray models can be installed in the coach.

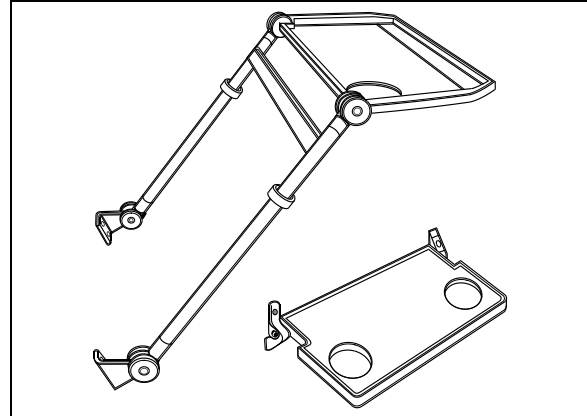

FOLDING TRAY MODELS

23140

NOTE

Both tray models as well as the tray installed onto each modesty panel are equipped with tumbler holders.

CARD TABLE

Two card tables are provided as standard equipment and are used in the passenger swivel seat configuration. The card tables are stored in the overhead storage compartments in separate stowage bags.

To install the card table, hold it at 45° (degrees) to the side wall. Insert the spring-loaded pin then the locking pin into the hinge. Push on the locking clamp to release the leg. Unfold the leg until the clamp locks it in position.

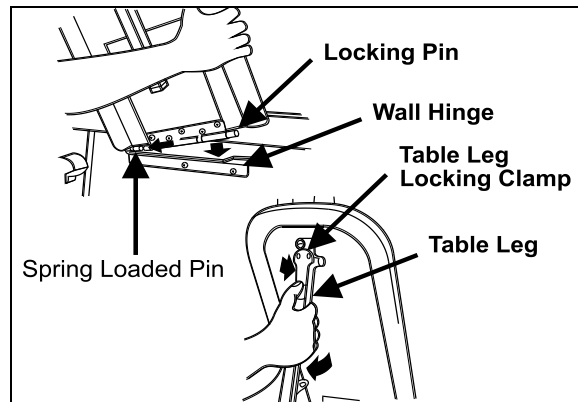

CARD TABLE INSTALLATION

23146

OVERHEAD CONSOLE

One airplane type overhead console is installed above each row of twin seats to provide a total of 107 ft³ (3.0 m³) of storage capacity. Such amenities as reading lights, air vents and an optional service bell are controlled from this panel.

3-8 Coach Interior

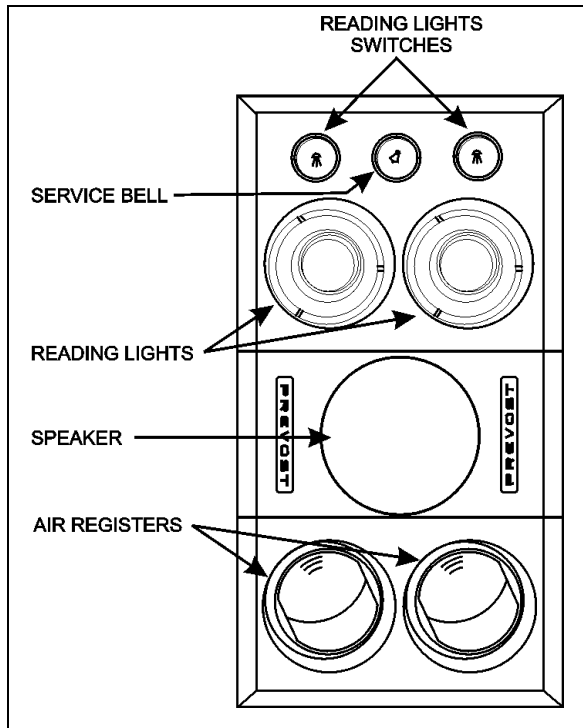

OVERHEAD CONSOLE

23137

ADJUSTABLE AIR REGISTERS

Manually adjustable registers located on the overhead console provide air flow to the passengers. Air flow can be directed, passengers can orient individual registers by rotating the nozzle. To adjust air flow, passengers must open or close the flaps. Activation of the fans is done by depressing a rocker switch on the dashboard. Refer to Controls & Instruments chapter.

SERVICE BELL

Pressing the service button on the overhead console will illuminate the button providing a visual cue for service personnel and, if activated, will sound a chime in the driver's area. The chime system is activated by a rocker switch located on the dashboard. Refer to Controls & Instruments chapter. Passengers may also use the chime system to request a stop for disembarking. Press the service button a second time to cancel the service request. To adjust the chime volume level, refer to "CONTROLS & INSTRUMENTS" chapter under Audiovisual Controller.

READING LIGHTS

Reading lights are mounted underneath the overhead storage compartments. Depressing a rocker switch located on the dashboard (refer to Controls & Instruments chapter) will activate the reading light circuit and allow passenger control of reading lights. Turning the key or ignition lever

to the accessory position "ACC" when the reading lights are on will activate the lights to full intensity, providing a clear view over the entire cabin area.

WINDOWS

The coach is equipped with frameless flush-mounted "Galaxsee" windows all around and a split-window windshield for maximum visibility.

PANORAMIC WINDOWS

Panoramic side windows can come in either single pane or, as an option, double pane (thermopane) glass. Some of these windows are of the fixed type; they are bonded to the structure and cannot be opened. Others can be easily opened to serve as emergency exits.

Fixed Windows

These windows are bonded to the structure and form an integral part of the body of the vehicle, helping reduce vibration and noise. Fixed windows cannot be opened.

Emergency Windows

These windows can be opened from inside the vehicle as emergency exits. A decal on window sills indicates the location of the emergency windows. To open an emergency window, lift the window release bar (sill) and push the window open from the bottom.

To close, lift the release bar and pull the window into position. Push down on release bar to lock the window shut.

For more information on emergency features, refer to "Safety Features and Equipment" chapter.

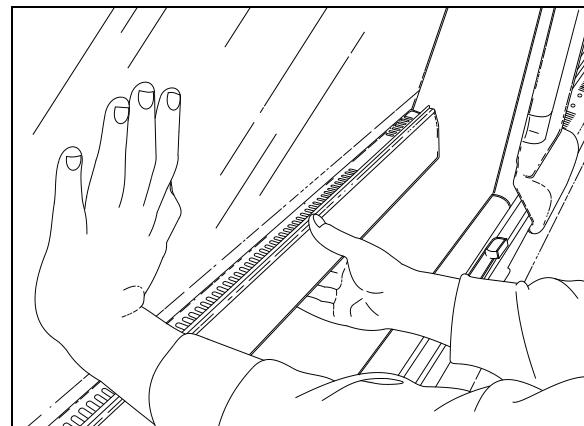

EMERGENCY WINDOW OPENING

18391

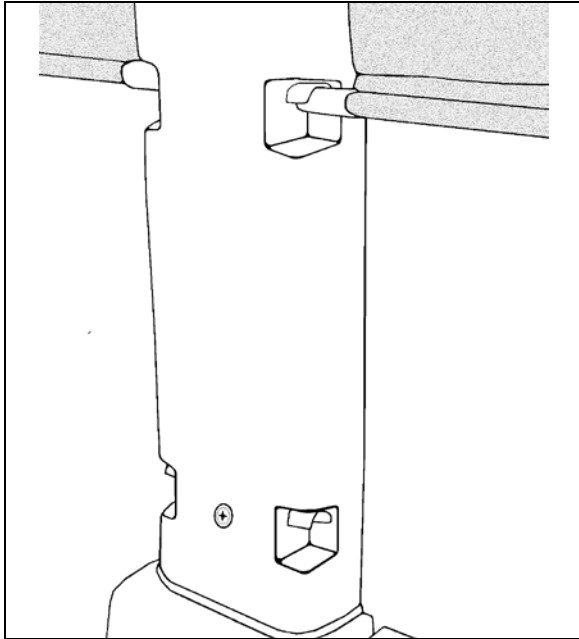
Window Sun Shades**PULL DOWN SUN SHADES**

18374

Passenger windows may be equipped with pull-down sun shades. To operate, pull down the shade and insert the hem into the first or second catch. To retract pull out from the slots and guide the shade back up.

DRIVER'S POWER WINDOW

The driver has a power window on the left side of the coach. The windows are controlled by a rocker switch located on the driver's control panel. Refer to "Controls and Instruments" chapter.

DRIVER'S WINDOW SHADES

This vehicle is provided with a spring release type sun shade on the driver's left side window. Another spring release type shade is available on the optional driver's guard. To operate, pull down the shade by its hem to the appropriate position and release. It will remain in position. To raise, depress the unlocking lever and guide the shade back up using the other hand.

Two electrically-operated shades are installed behind the windshields. Two rocker switches on the dashboard operate each shade individually. Refer to "Controls and Instruments" chapter for more information.

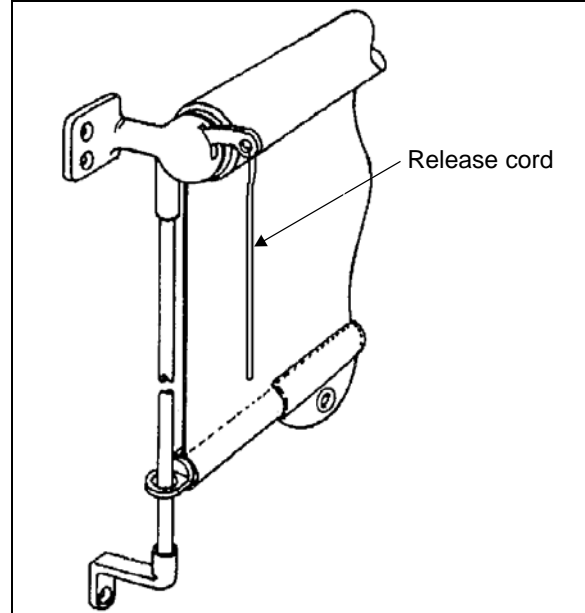
**SPRING RELEASE SUNSHADE**

23019

VENTILATION HATCH

A ventilation hatch may be installed in the ceiling at the rear of the coach. A second, optional hatch can be installed on the roof at the front of the coach. To open the hatch, push up with both hands and pull down to close. The ventilation hatch can be completely opened for emergency egress. Refer to "Safety Features and Equipment" chapter.

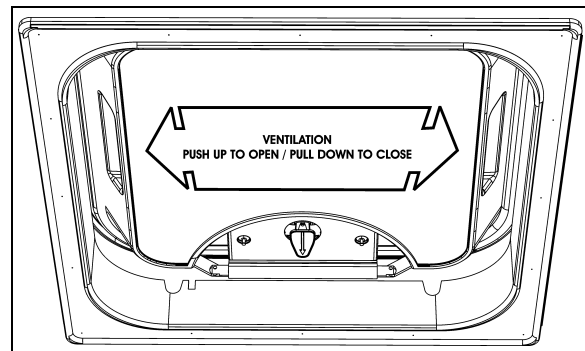
**VENTILATION HATCH****WARNING**

Be aware of coach overhead clearance when traveling under overpasses with the ventilation hatch(es) open. Check for maximum clearance height.

3-10 Coach Interior

OVERHEAD COMPARTMENTS

Passenger carry-on baggage is stored in overhead compartments on each side of the coach. A first aid kit is located in the first front curb side overhead storage compartment. An optional video cassette player and a CD player may be installed in the first front driver's side overhead storage compartment.

To open the optional closed overhead storage compartments, push the handle in to release the latch, then let go. A pressurized cylinder opens the door.

NOTE

The overhead storage compartments have a minimum amount of separators installed so as to quicken inspection for forgotten objects.

NOTE

An optional lock can be installed on the first front driver's side overhead storage compartment door.

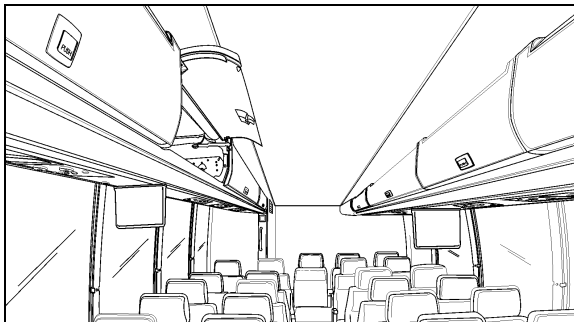

OVERHEAD STORAGE COMPARTMENTS

18603

WASTE CONTAINER

The waste container is located on the lavatory wall, and is accessible through an opening on each side of the wall. A small door, located on the aisle side, gives access to the waste container for cleaning.

GALLEY

The optional galley may include features such as a microwave oven and refrigerator to accommodate hot or cold food and beverage service. The galley's electrical power circuit is activated by a rocker switch located on the dashboard. Refer to "Controls & Instruments" chapter.

LAVATORY

The lavatory is located in the rear curb side corner of the coach. It is equipped with a chemical flush toilet, bathroom tissue dispenser, mirror and waste container access.

A movement detector will automatically illuminate a fluorescent light inside the lavatory and two outside signs to indicate occupation. One sign is located on the outer wall of the lavatory and another sign is located over the windshield. A telltale light on the dashboard will also illuminate to inform the driver when the lavatory is occupied.

If emergency assistance is required, the lavatory occupant can actuate a buzzer that will sound in driver's area. The buzzer's push-button is located just below the toilet flush button.



FLUSH AND EMERGENCY BUTTONS

The lavatory has its own ventilation system that operates only when the ignition switch is in the "ON" position.

NOTE

This fan runs constantly when the ignition switch located on the dashboard is in the "ON" position.

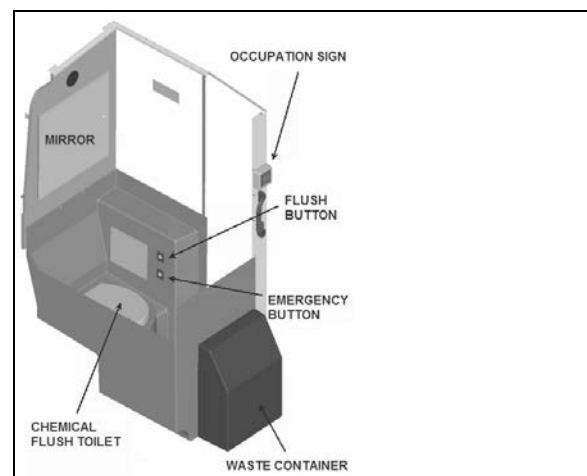

LAVATORY

23235_1

KEYS.....	3
ENTRANCE DOOR AND EXTERIOR COMPARTMENT DOORS KEY.....	3
UTILITY COMPARTMENTS KEY.....	3
FUEL FILLER DOOR KEY (OPTION).....	3
LAVATORY DOOR KEY.....	3
UTILITY AND VIDEO COMPARTMENT KEY.....	3
HAND TOWEL DISPENSER KEY.....	3
IGNITION SWITCH.....	3
ACCESSORIES.....	4
START.....	4
LATERAL CONTROL PANEL.....	6
TRANSMISSION CONTROL PAD (1).....	6
CONTROL SWITCHES (2).....	6
OPTION A: KNEELING / FRONT AXLE HI-BUOY (OPTIONAL).....	6
MIRROR CONTROLS (OPTION) (3).....	7
TAG AXLE CONTROL VALVE (4).....	8
PARKING BRAKES CONTROL VALVE (5).....	8
COOLANT HEATER TIMER (OPTION) (6).....	8
LOW-BUOY CONTROL VALVE (OPTION) (7).....	8
CIGARETTE LIGHTER (OPTION) (8).....	8
ASHTRAY (OPTION) (9).....	8
UTILITY COMPARTMENT (10).....	8
12-VOLT APPLIANCES SOCKET (11).....	8
TRAILER AIR SUPPLY CONTROL VALVE (OPTION) (12).....	9
EMERGENCY/PARKING BRAKES OVERRULE CONTROL VALVE.....	9
BACK-UP CAMERA AND MONITOR.....	9
SCENIC VIEWING SYSTEM CAMERA.....	9
ON BOARD DIAGNOSTIC RECEPTACLE.....	9
AUTOMATIC FIRE DETECTION AND SUPPRESSION SYSTEM (AFSS).....	9
PROTECTION PANEL.....	9
MANUAL ACTIVATION SWITCH.....	9
CRUISE CONTROL.....	10
PREVOST AWARE - ADAPTIVE CRUISE BRAKING.....	11
TIRE PRESSURE MONITORING SYSTEM (TPMS).....	16
DASHBOARD.....	20
CONTROL SWITCHES.....	21
L. H. DASHBOARD PANEL.....	21
R. H. DASHBOARD PANEL.....	25
HVAC CONTROL UNIT.....	27

4-2 Controls and Instruments

AUDIO-VIDEO SELECTOR FOR THE PASSENGER'S AREA	28
DASHBOARD RADIO/MP3/IPOD/CD PLAYER	31
AIR VENTS.....	32
INSTRUMENT CLUSTER.....	33
ANALOG INDICATORS.....	34
TELLTALE LIGHTS	38
STOP, CHECK AND INFORMATION TELLTALE LIGHTS.....	41
DRIVER INFORMATION DISPLAY	42
PICTOGRAMS DISPLAYED ON THE DRIVER INFORMATION DISPLAY (DID)	44
VEHICLE CLEARANCE INFORMATION	52
STEERING COLUMN CONTROLS.....	52
MULTI-FUNCTION LEVER	52
HORNS	55
TRANSMISSION RETARDER.....	55
FOOT-OPERATED CONTROLS.....	56
BRAKE PEDAL.....	56
ACCELERATOR PEDAL.....	56
Allison Transmission	56
OPERATION	56
PUSHBUTTON SHIFT SELECTOR	57
PRIMARY AND SECONDARY SHIFT SCHEDULES	57
TRANSMISSION SERVICE INDICATOR	57
DESCRIPTION OF AVAILABLE RANGES.....	58
VOLVO I-SHIFT TRANSMISSION	60
PUSHBUTTON SHIFT SELECTOR	60
DISPLAY	60
ACCELERATOR PEDAL.....	61
ECONOMY AND PERFORMANCE MODE	61
ECO-ROLL MODE (FREEWHEEL FUNCTION)	61
LIMP HOME MODE.....	61
STARTING AND STOPPING	62
STARTING THE VEHICLE UPHILL AND DOWNHILL.....	62
DRIVING	63
TOWING RECOMMENDATIONS.....	64

KEYS

Depending on options, up to eight different keys are provided with the coach.

ENTRANCE DOOR AND EXTERIOR COMPARTMENT DOORS KEY

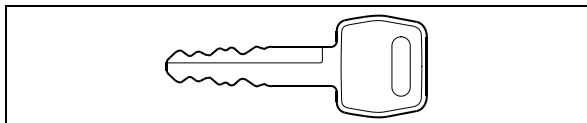

Use this key to lock or unlock the entrance door, the baggage doors the electrical and service compartment doors, except the fuel filler door.

NOTE

It is also possible to lock or unlock the baggage compartments and engine compartment R.H. side door from the inside by means of the optional baggage compartments locking system.

UTILITY COMPARTMENTS KEY

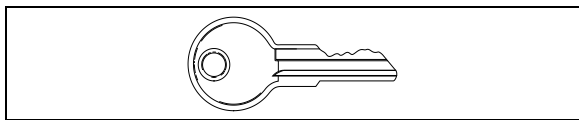

This key locks or unlocks the utility compartments and the utility drawer on the dashboard.

FUEL FILLER DOOR KEY (OPTION)



Use this key to lock or unlock the fuel filler door.

LAVATORY DOOR KEY

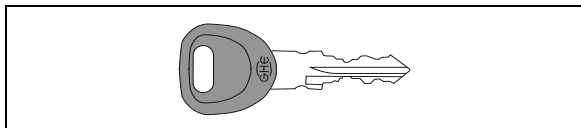

Use this key to lock or unlock the lavatory.

UTILITY AND VIDEO COMPARTMENT KEY

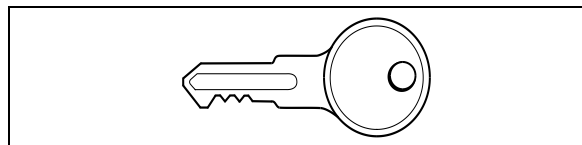

Use this key to lock or unlock the lockable utility compartments and the lockable overhead compartment containing the video cassette player.

HAND TOWEL DISPENSER KEY

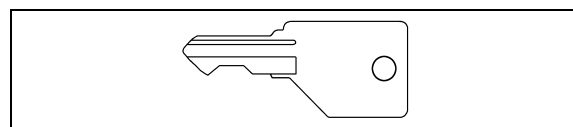

Use this key to open the hand towel dispenser.

NOTE

Optional moist towel dispenser uses another key.

IGNITION SWITCH

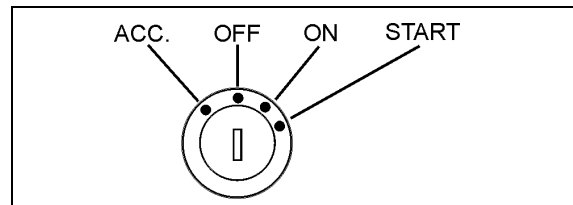

IGNITION SWITCH POSITIONS

06354

Coaches may be equipped with an ignition lever instead of an ignition key. Use the ignition switch to activate the electrical circuit by turning it counterclockwise to the ACC position.

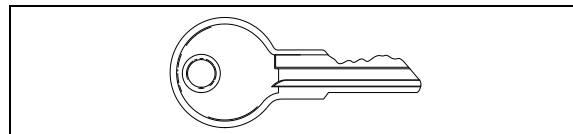

IGNITION KEY

To start the engine, turn the key clockwise to the START position, and then release it. The key will set to ON position.



CAUTION

When the vehicle is parked overnight or for an extended period of time, the battery master switch (ignition switch) should be set to the off position.

4-4 Controls and Instruments

NOTE

When the battery master switch (ignition switch) is set to the off position, all electrical supply from the batteries is cut off, with the exception of battery equalizer check module, ecm ignition and power supply, Allison tcm, i-shift transmission ecu), coolant electronic, coolant heater and water re-circulating pump, power-verter, fire alarm and entrance door.

The ignition switch doubles as the battery master switch. Any position other than OFF activates the electrical circuits.

The ignition switch is located on the lower left side of the dashboard. It has four positions:

ACCESSORIES

To operate the accessories only, turn the ignition key counterclockwise to the ACC position.

The electrical circuits are activated when the switch is in this position. The features enabled when the switch is in the ACC position are all those linked directly to the battery such as the radio or entertainment system, exterior and interior lighting.

Off

In the OFF position, ignition cannot take place.

The electrical circuits are not activated when the switch is in this position with the exception of the circuits of the accessories connected directly to the batteries and the “wake-up” systems which remains active for about 15 minutes after the ignition is set to the OFF position. Maintain the switch in this position when parked overnight or for an extended period.

On

To place ignition switch to the ON position, turn the key clockwise to the first position.

Do not leave the key in this position unless the engine is running.

START

Turn the key clockwise to the second position and release as soon as the engine starts. The key will return to the ON position. If the engine did not start, return the ignition key to the OFF position before trying to restart the engine.

The ignition switch is equipped with a starter protection which inhibits turning the key to the START position if the key has not previously been turned to the OFF position.



CAUTION

To avoid overheating the starter, do not engage the starter for more than 15 seconds at a time. Allow the starter to cool before trying to restart the engine.



DANGER

Do not use ether or other combustible starting aid fluid on any engine equipped with an intake air preheater. If the engine is equipped with a preheater, introduction of ether or similar starting aids could cause a fire or explosion resulting in severe property damage, serious personal injury or death.

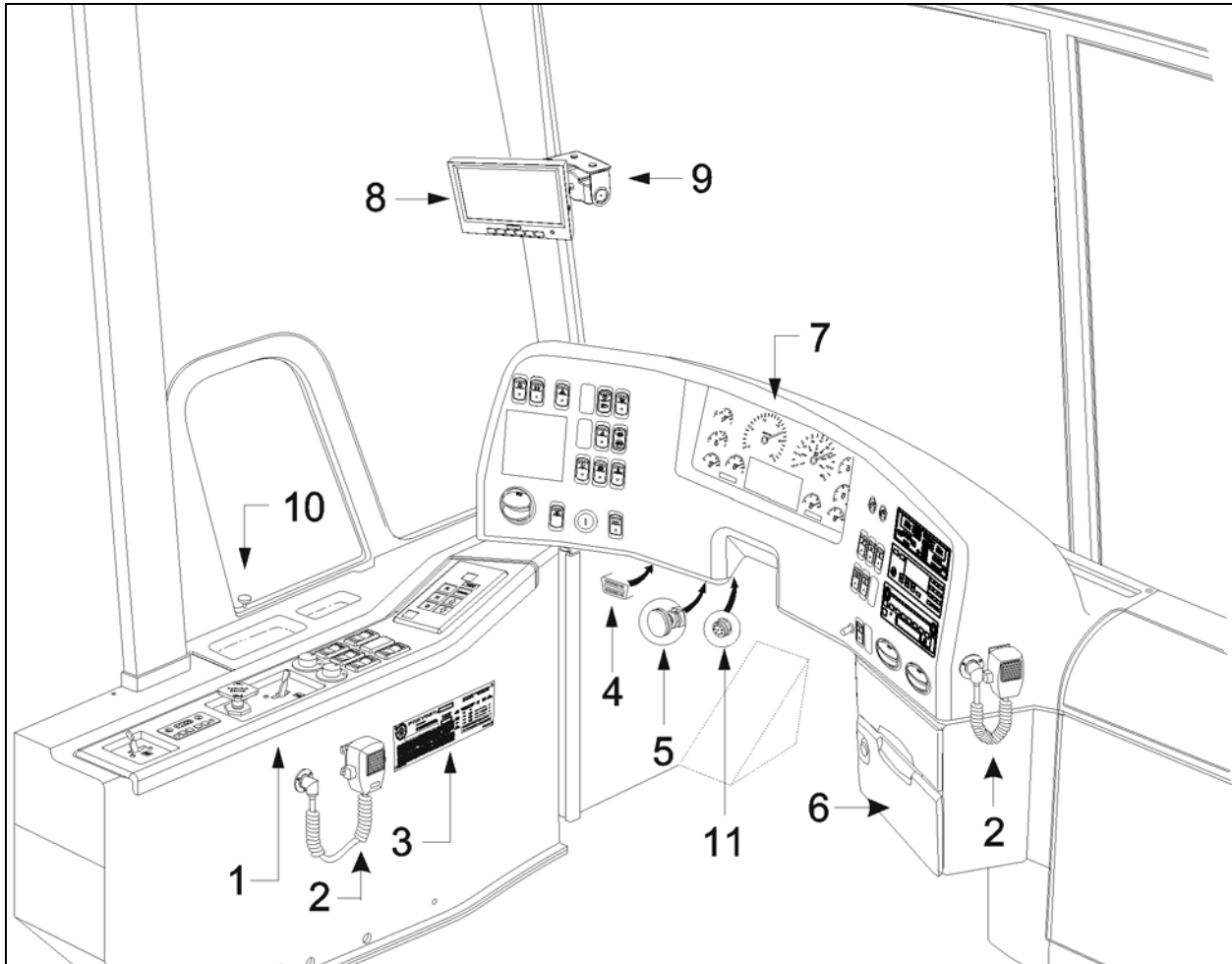

DRIVER'S SECTION

18671_B

1. Lateral control panel
2. Microphone
3. DOT certification plate
4. OBD (On Board Diagnostics) receptacle
5. Foot-operated steering wheel adjustment release knob
6. Driver's utility compartment
7. Dashboard
8. Rear view monitor (optional)
9. Front view scenic camera (optional)
10. Front service door unlocking pull rod
11. Electronic Logging Device Connection (ELD)

LATERAL CONTROL PANEL

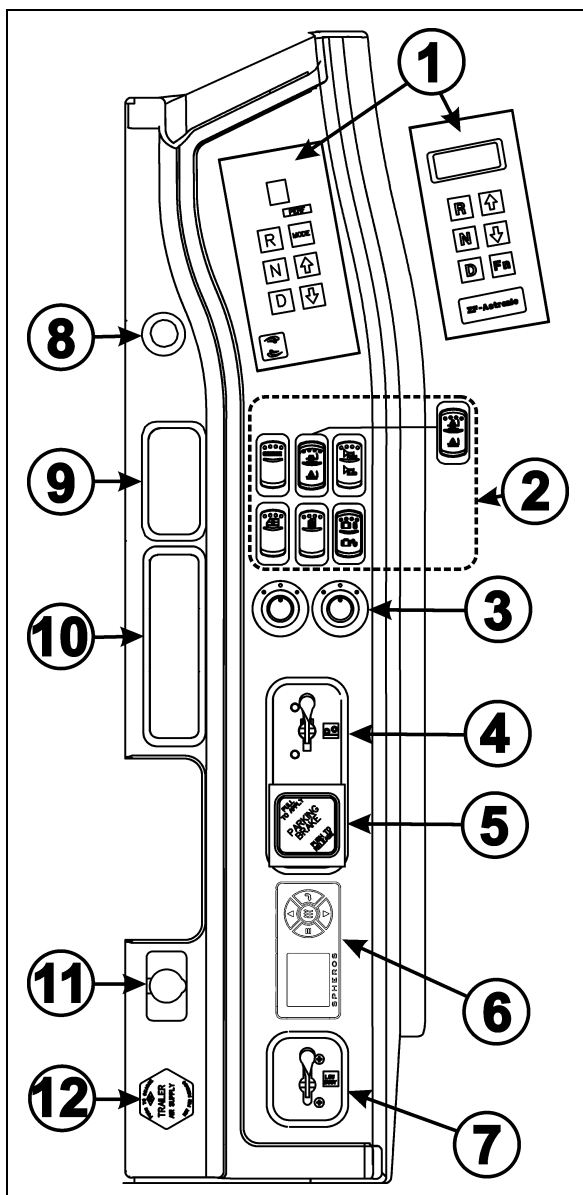

LATERAL CONTROL PANEL

06704_3

1. Transmission control pad
2. Control switches
3. Mirror controls
4. Tag axle control valve
5. Parking brakes control valve
6. Coolant heater timer (option)
7. Low-buoy control valve (option)
8. Cigarette Lighter (option)
9. Ashtray (option)
10. Utility Compartment
11. 12-volt Appliances Socket
12. Trailer Air Supply Control Valve (option)

TRANSMISSION CONTROL PAD (1)

The Allison or Volvo I-Shift transmission control pad is located on the lateral control panel. Refer to "Automatic Transmission" in this chapter for operating instructions and more information.

CONTROL SWITCHES (2)

CRUISE CONTROL SWITCH

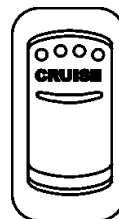

06701

Depress the **cruise** rocker switch to activate the cruise control. This turns the system on. A led on the switch shows that you can now set the vehicle at a desired cruising speed.

For operation of the cruise control, refer to "regular cruise control" or "prevost aware adaptive cruise braking" paragraph in this chapter.

KNEELING/HI-BUOY OPTIONS

OPTION A: KNEELING / FRONT AXLE HI-BUOY (OPTIONAL)

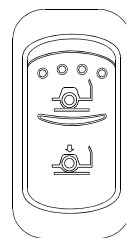

06250

Momentarily press the rocker switch downwards to lower the front end of the coach 4 inches (100 mm). Momentarily press the rocker switch upwards to raise the coach to the normal driving height. Refer to "OTHER FEATURES" chapter for more information.

Press and hold the rocker switch upwards to raise the front end of the coach 4 inches (100 mm). Release the rocker switch to return the coach to the normal driving height.

Option B: kneeling / full hi-buoy (optional)

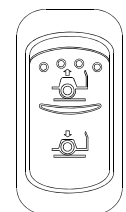

6251

Momentarily press the rocker switch downwards to lower the front end of the coach 4 inches (100mm). Momentarily press the rocker switch upwards to return the coach to normal driving height. Refer to "OTHER FEATURES" chapter.

Press and hold the rocker switch upwards to raise the complete suspension of the coach 4 inches (100 mm). Release the rocker switch to return the coach to the normal driving height.

NOTE

The parking brakes must be applied to allow the use of the kneeling.

HORN SELECTOR

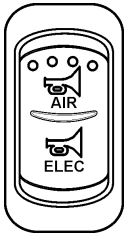

06700

Use this switch the toggle between the air horn and the electric horn when pressing the steering wheel center pad.

POWER WINDOW SWITCH

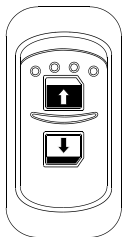

06338

Use this rocker switch to open or close the driver's power window.



CAUTION

Close power window when parked or leaving the coach unattended.

OUTSIDE REAR VIEW MIRROR HEAT (OPTIONAL)

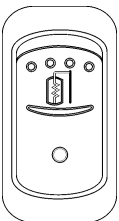

06261

Press this rocker switch to clear fog, frost or thin ice from outside mirror.

BAGGAGE COMPARTMENTS LOCKING SYSTEM

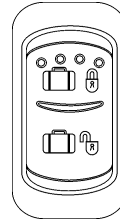

06266

This system enables locking all baggage compartment doors by pressing the switch forward. To unlock, press the switch rearward.

NOTE

Service compartment doors are not linked to the baggage compartments locking system.

NOTE

Baggage compartment doors must be unlocked using the key first, they can then be unlocked or locked using the baggage compartments locking system.

MIRROR CONTROLS (OPTION) (3)

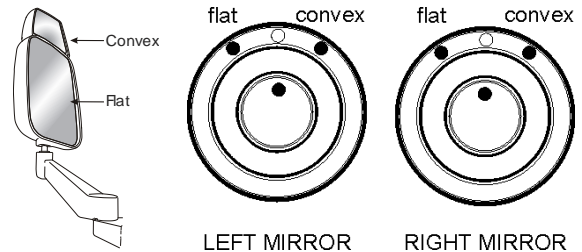

LEFT MIRROR

RIGHT MIRROR

MIRROR CONTROLS

06374

Turn left pointer knob counterclockwise for flat mirror adjustments and to the right for convex mirror adjustments, then use the joystick control to adjust the selected mirror's viewing angle. Adjust the right outside mirror similarly but by using the right side control.

NOTE

If the mirror assemblies on your vehicle do not include convex mirrors, only one (1) mirror control knob will be installed for both mirrors. To operate, turn knob to the left for L.H. Mirror adjustments and to the right for R.H. Mirror adjustments, then use the joystick control to adjust the selected mirror's viewing angle.

4-8 Controls and Instruments

TAG AXLE CONTROL VALVE (4)

Lift the tag axle by pushing the lever forward. Pulling the lever back will lower the tag axle. Refer to "Other Features" chapter for additional information.

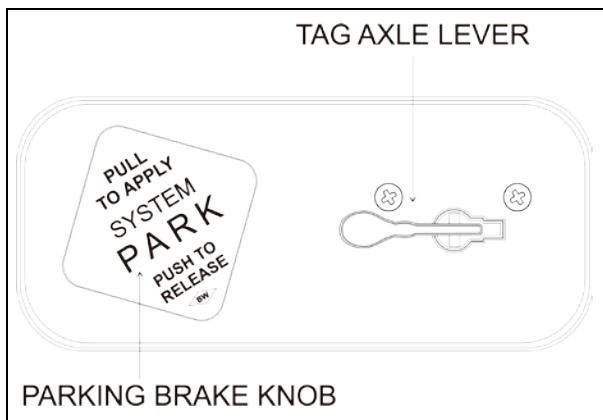

CONTROL VALVES

12129_EN

PARKING BRAKES CONTROL VALVE (5)

Spring-loaded parking brakes are applied by pulling up the control valve knob and protector assembly. Lift the safety cover and push down to release brakes. Refer to "Safety Features and Equipment" chapter.

COOLANT HEATER TIMER (OPTION) (6)

Use the timer to program the start time of the optional engine coolant heater. Refer to "Other Features" chapter and supplied manufacturer's manual for additional information.

LOW-BUOY CONTROL VALVE (OPTION) (7)

Toggle back the control lever to lower the coach by about four inches. Returning the lever to the normal (forward) position raises the vehicle back to its normal height.

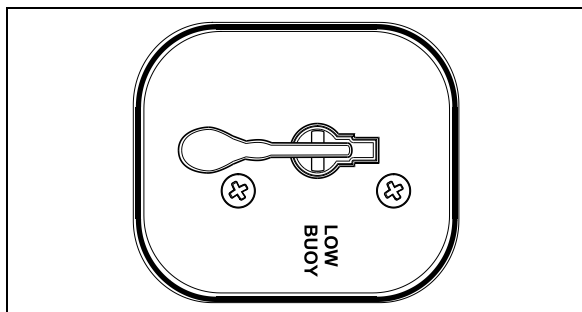

LOW-BUOY CONTROL VALVE

16088



CAUTION

DO NOT EXCEED SPEEDS OF 5 MPH (8 KM/H) WHEN ACTIVATED.

CIGARETTE LIGHTER (OPTION) (8)

Push lighter in to activate. When ready to use, it will spring out automatically. Replace lighter in non-activated position. The cigarette lighter socket can be used to power 12-volt appliances (e.g. flashlight, vacuum cleaner). The maximum power consumption allowed for appliances plugged in this socket is 130 watts. Make sure the appliances are equipped with suitable plugs that will not damage the socket.

NOTE

The cigarette lighter can still be used after the ignition key has been removed.

ASHTRAY (OPTION) (9)

To open the optional ashtray, push slightly on the cover's side. The ashtray can be removed for cleaning by pulling it out.



WARNING

To prevent a fire, never put paper or plastic wrappers in the ashtray, empty ashtray often.

UTILITY COMPARTMENT (10)

To open the compartment, lift the cover.

12-VOLT APPLIANCES SOCKET (11)

This 12 volts DC power outlet can be used to power small 12 volt DC appliances such as a cellular phone or a vacuum cleaner. The maximum power consumption allowed for appliances plugged in this socket is 130 watts. Make sure appliances are equipped with suitable plugs that will not damage the socket.

TRAILER AIR SUPPLY CONTROL VALVE (OPTION) (12)

The trailer air braking system is supplied by pushing this control valve.

EMERGENCY/PARKING BRAKES OVERRULE CONTROL VALVE

The coach may be equipped with the optional parking brake overrule system, which allows the vehicle to be moved to the nearest safe parking area if the spring-loaded emergency brake has automatically applied to the drive axle wheels. To actuate the parking brakes overrule system, push and hold down the control valve located on the lateral control panel.

BACK-UP CAMERA AND MONITOR

An optional back-up camera is available which provides the driver with visual assistance when backing-up.

The monitor is mounted on the windshield L.H. side pillar and switches ON automatically when the transmission is in the reverse (R) range.

SCENIC VIEWING SYSTEM CAMERA

The optional scenic viewing system enables the passengers to view the road ahead of the vehicle. The camera is mounted above the back up camera monitor and the system is switched ON using the dashboard mounted FRONT CAMERA/TV switch.

ON BOARD DIAGNOSTIC RECEPTACLE

To ease troubleshooting, you can connect a diagnostic tool through the OBD receptacle to access recorded data. The OBD receptacle is located under the dashboard, on the left side.

AUTOMATIC FIRE DETECTION AND SUPPRESSION SYSTEM (AFSS)

PROTECTION PANEL

The protection panel displays the current system status. The protection panel contains “SYSTEM OK”, fire “ALARM” and “TROUBLE” lamps, the

audio alarm, the “TEST/RESET” switch, and the “ALARM SILENCE” switch.

The “SYSTEM OK” lamp indicates power is on the system and that there are no trouble conditions present. The “TROUBLE” lamp blinks if there is a fault in the detection circuitry and illuminates solid if there is a fault in the extinguishing circuitry. When the “TROUBLE” lamp is on, the “SYSTEM OK” lamp will be off and the audible alarm will sound intermittently. The “SYSTEM OK” lamp will flash when the system is low on battery power. Depressing the “TEST/RESET” switch tests the protection panel lamps and audio alarm. The “ALARM SILENCE” switch will disable the audio alarm.

When a fire detector automatically detects a fire, the fire “ALARM” lamp and audio alarm activate. When the Manual Activation Switch is activated, the fire “ALARM” lamp blinks and the audio alarm activates. The lamp will remain blinking until power is cycled to the system.

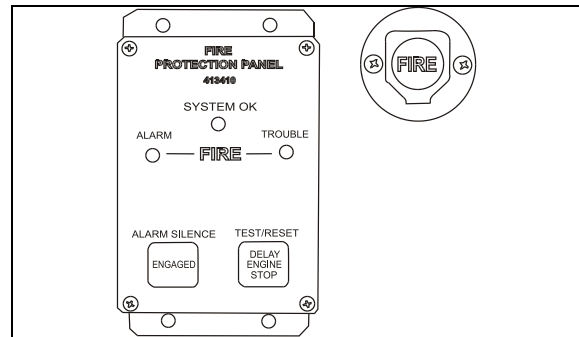

AFSS PROTECTION PANEL & MANUAL ACTIVATION SWITCH

MANUAL ACTIVATION SWITCH

The manual activation switch allows immediate system activation (extinguisher discharge and engine shutdown) by the operator at any time. Activation of the switch is accomplished by twisting and pulling the tamper seal to remove, lifting the cover and pressing the red “FIRE” button for more than half a second. After the manual activation switch has been activated, the protection panel will blink the fire “ALARM” indicator until power has been cycled to the system.

Refer to chapter “SAFETY FEATURES AND EQUIPMENT” for more information on *Kidde Dual Spectrum* Automatic Fire detection and Suppression System (AFSS).

4-10 Controls and Instruments

CRUISE CONTROL

REGULAR CRUISE CONTROL

The cruise control allows you to cruise the vehicle at a desired speed without having to use the accelerator pedal.

Turning the system on



06701

To operate the cruise control, press the **cruise** rocker switch located on the lateral control panel to the on position. This turns the system on; you can now set the vehicle at a desired cruising speed. To turn off the system, press the rocker switch to the off position.

NOTE

The **cruise** switch and **resume** button do not operate at speeds below 30 mph (50 km/h).

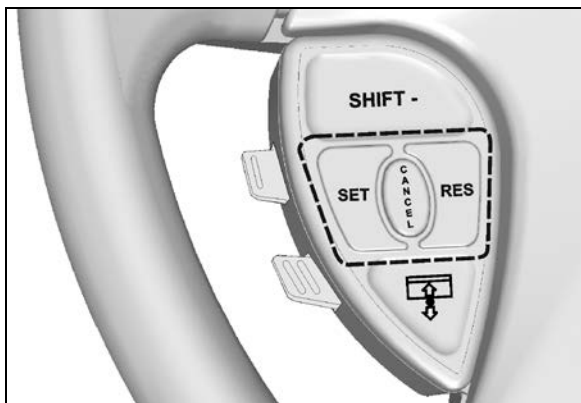

CRUISE CONTROL BUTTONS

Setting at a desired speed

Accelerate the vehicle to the desired cruising speed using the accelerator pedal. Press and release the **SET** button then remove foot from the accelerator pedal. This will set the vehicle cruise speed and store it in memory. The set speed will appear in the driver information display.

Increasing set speed

The vehicle cruise speed setting can be increased by one of the following methods.

1. Accelerate using the accelerator pedal until the desired cruising speed is reached. Press and release the **SET** button.

or

2. Press and hold the **RES** (RESUME) button until the desired cruising speed is reached. When the **RES** button is released, the new cruising speed will be stored in the cruise control memory.

or

3. When driving with cruise control, each time the **RES** button is momentarily depressed, the cruising set speed is raised by 1 mph (2 km/h).

NOTE

When driving with cruise control, the vehicle can still be accelerated by depressing the accelerator pedal in the usual manner. Once the accelerator pedal is released, the vehicle will return to the previously set cruising speed.

Decreasing set speed

The vehicle cruise speed setting can be decreased by one of the following methods.

1. Press and hold the **SET** button until the desired cruising speed is reached. When the **SET** button is released, the new cruising speed will be stored in the cruise control memory.

or

2. Each brief pressing of the **SET** button will decrease set cruising speed by 1 mph (2 km/h).

or

3. Slightly apply the service brake and when desired cruise speed is reached, press and release the **SET** button.

Canceling the set speed

You can cancel the set cruising speed by:

1. Pressing momentarily the **CANCEL** button;
2. Depressing the brake pedal.

Automatic Cruise Control Cancellation

The set speed is automatically canceled in any of the following situations:

- The windshield wipers are operating in low or high speed;
- The actual vehicle speed falls below 30 mph (50 km/h).

Resuming Set Speed

If the set speed is cancelled by pressing the **CANCEL** button or depressing the brake pedal, pressing the **RES** (RESUME) button will restore the speed set prior to cancellation, providing that your speed is above 30 mph (50 km/h).

NOTE

When driving downhill with the cruise control on and set, the engine brake or the transmission retarder engage automatically (if previously activated) when the selected cruise speed is exceeded by approximately:

- 4 mph (7 km/h) with the engine brake activated;
- 0.6 mph (1 km/h) with the transmission retarder activated.

The engine brake or the transmission retarder is then disengaged when speed has returned near to selected cruise speed.

The engine brake will provide low braking power or high braking power depending on which of the two steering wheel engine brake control buttons is activated;

① = engine brake low

② = engine brake high

The transmission retarder maximum braking level is determined by the retarder hand lever position on the steering wheel.

NOTE

To avoid sudden vehicle hesitation, slightly depress the accelerator pedal before disengaging the cruise control.

NOTE

*When the **cruise** rocker switch is released, the cruise control is completely shut off and the cruise speed setting is erased from the cruise control memory.*

IMPORTANT NOTE

If the engine was stopped and the cruise rocker switch was in the on position, the rocker switch must be reset by turning it off then on again in order for the cruise control to be reactivated.



WARNING

Do not use the cruise control when driving speed must be constantly adjusted, such as in heavy traffic or on winding, icy, snow-covered or slippery roads, or on gravel roads.



WARNING

Do not put the transmission in the neutral (n) position while driving with cruise control. This may cause the engine to over-speed and result in a loss of driving control.

PREVOST AWARE - ADAPTIVE CRUISE BRAKING

Prevost AWARE Adaptive Cruise Braking (ACB) is an optional cruise control that not only maintains the set speed, but will also intervene, as needed, to help the driver maintain a set following distance behind the forward vehicle by reducing speed as necessary. As soon as the forward vehicle is at a safe distance, the coach will accelerate back to the cruise set speed.

NOTE

The following paragraphs briefly sum up the information concerning the operation and function of the ACB. Before driving the vehicle, be certain that you have read and that you fully understand each and every step of the driving and handling information found in Bendix Wingman ACB Active Cruise with Braking Operator's Manual. The driver should fully understand all the audible alerts and visual indicators that the system provides. Bendix Wingman ACB Active Cruise with Braking Operator's Manual (available on Prevost web site and included on the Technical Publications USB key) will assist in explaining what each of them means and what actions the driver may be required to take to avoid potential collisions.



WARNING

Even with ACB, the driver must remain alert, react appropriately and in a timely manner, and use good driving practices. Ultimate responsibility for the safe operation of the vehicle remains with the driver at all times.

Be certain that you have read all safety warnings found in Bendix Wingman ACB Active Cruise with Braking Operator's Manual.

The driver will benefit all the audible and visual warnings that the system provides whether or not ACB is turned on. In addition to the audible and visual warnings, when the ACB is turned on and a cruise speed is set, the driver benefits from active interventions like engine throttle reduction, retarder or engine brake application and service brakes application to help maintain a set following distance.



WARNING

Adaptive Cruise Braking must be used only in the same conditions that are normally recommended for ordinary cruise control. Refer to "Regular Cruise Control" paragraph.

Turning the ACB system on

Activation of the adaptive cruise braking is similar to the regular cruise control activation. Press the CRUISE rocker switch to the ON position, accelerate the vehicle to the desired cruising speed and then, press the SET button. ACB is now engaged with the set following distance and driver warnings features. Whenever the cruise control is engaged, the ACB is also engaged. You cannot engage the cruise control without also using the ACB features.

Turning off the ACB system

You can turn off the ACB system, simply by applying service brakes, setting the CRUISE rocker switch to the OFF position or pressing the cruise control CANCEL button on the steering wheel.

NOTE

Whenever the service brakes are applied by intervention of the ACB or by the driver, normal cruise will automatically be cancelled. The driver must resume or set the cruise mode in order for the vehicle to throttle up.

Maintaining a set following distance

Using a radar sensor mounted to the front bumper, the ACB system measures the distance between the coach and the forward vehicle and intervenes to help maintain a safe set following distance behind the vehicle. This feature engages automatically once the driver turns on and sets cruise speed.

Following distance refers to the time gap, measured in seconds, between the coach and the vehicle ahead. The actual physical distance between the coach and the vehicle ahead will vary based on your set cruise speed; although the set time gap remains the same for all set cruise speeds. Prevost's default set time gap is 1.7 seconds.

With cruise control engaged and a cruise speed set, you are maintaining a set following distance between the coach and the forward vehicle:

- **If the vehicle in front of the coach slows down** below your cruise control set speed, the system will progressively intervene as follows, in this order:
 - 1) reduce the engine throttle;
 - 2) apply the engine brake or transmission retarder;
 - 3) apply about 30% of the service brakes available braking power in an attempt to maintain the set following distance.

The driver must apply additional braking power when required, to avoid collision or to maintain a safe distance from the vehicle ahead.

NOTE

If the ACB is actively decelerating or braking the coach in an attempt to maintain the set following distance at the moment when the driver cancels the ACB system, the ACB system will continue deceleration or braking intervention until a safe following distance is established, then will cancel.

Even though the cruise control doesn't operate at speeds below 30 mph (50 km/h), the ACB system will continue deceleration or braking intervention in an attempt to maintain the set following distance if the coach speed reduces to less than 30 mph (50 km/h).

- If the vehicle ahead slows below your cruise control's set speed, but then accelerates away, and the ACB system did not need to use the service brakes as it managed the intervention, the coach will automatically accelerate back to the original cruise control set speed, and again maintain a set following distance behind the forward vehicle.

NOTE
 The maximum radar range is approximately 500 feet (150 meters). Rain, snow, fog, ice and other severe weather conditions may affect the performance of the ACB system and shorten radar range.

NOTE
 As part of your pre-trip vehicle inspection, check to see that there is no mud, snow, ice build-up or other obstruction in front of the radar sensor. You should inspect the radar sensor mounting and remove any obstruction that may impair the sensor functioning.

Driver warnings

Before using the ACB, the driver should fully understand all the audible and visual warnings that the system provides. Any audible warning (beeping or tone) means that your vehicle is too close from the vehicle ahead.

DASHBOARD TELLTALE

When ACB is turned on and a cruise speed is set, if the forward vehicle is detected (in range) by the radar, the FORWARD VEHICLE DETECTED telltale light on the dashboard will illuminate. This is an indication to the driver that the forward vehicle is being tracked, that the ACB is actively managing the distance between the coach and the vehicle ahead and that the ACB system may automatically intervene to maintain the set following distance.



FORWARD VEHICLE DETECTED telltale light

There are three types of warnings with this telltale light:

- Green: The forward vehicle is detected (in range).

- Flashing red: Collision alert. The forward vehicle is too close to follow safely or a metallic stationary object such as a stopped or stalled vehicle in your lane of travel is detected. The driver must intervene to avoid a collision.
- Solid red: ACB system malfunction. The ACB system and the alert functions are not available.

SPEEDOMETER LEDs

With the cruise control engaged and a cruise speed set, a green LED illuminates above the cruise control set speed on the speedometer.

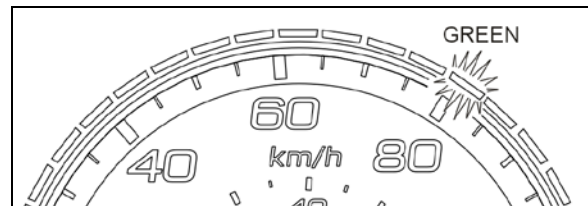

THE CRUISE SET SPEED IS 80 km/h

With a cruise speed set, the vehicle ahead slows moderately. The system will display to the driver the approximate speed of the vehicle ahead with yellow LEDs above the speedometer.

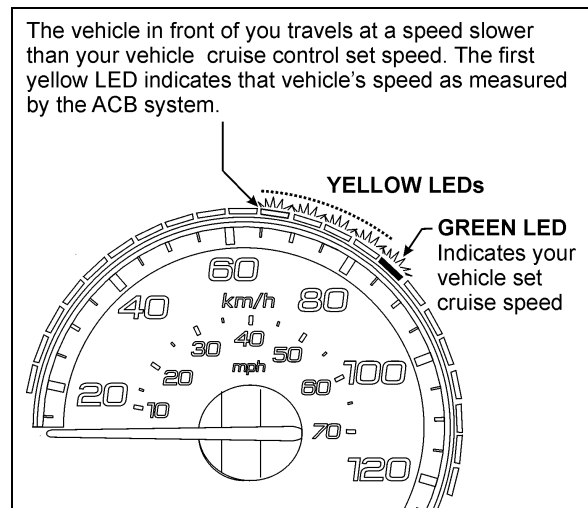

EXAMPLE OF THE SPEEDOMETER LED DISPLAY WHEN THE FORWARD VEHICLE IS SLOWER WHILE THE COACH TRAVELS WITH THE ACB CRUISE CONTROL ON AND SET

06729_3

4-14 Controls and Instruments

FOLLOWING DISTANCE ALERT (FDA)

Following Distance Alert provides both audible and visual warnings whenever the distance between the coach and the forward vehicle is less than the set distance and getting closer. Once the audible warning is given, the driver must increase the distance between the coach and the vehicle ahead until the audible warning stops or maneuver clear of the forward vehicle.



WARNING

Following Distance Alert is always active whenever the coach is moving to a speed greater than 37 mph (60 km/h), whether or not ACB is turned on. Active interventions of ACB to maintain safe following distance (throttle reduction, engine brake/retarder application, service brakes application) are only operational when the ACB is engaged with a cruise speed set.

IMPACT ALERT

The Impact Alert warning is the most severe warning issued by the ACB system. This alert indicates that the driver must take immediate evasive action by applying more braking power and/or steering clear of the vehicle ahead to avoid a potential collision.

The Impact Alert is also applicable to stationary metallic objects such as stopped or stalled vehicles. This alert provides a warning given up to 3.0 seconds before a potential collision with a stationary metallic object in the coach's lane of travel. The driver can either slow down or maneuver in an attempt to avoid the object. The Impact Alert will only warn and will not actively decelerate or brake the coach when approaching stationary objects.



WARNING



Impact Alerts are always operational when the vehicle is running, whether or not ACB is turned on. Active interventions of ACB to maintain safe following distance (throttle reduction, engine brake/retarder application, service brakes application) are only operational when the ACB is engaged with a cruise speed set.

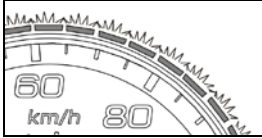
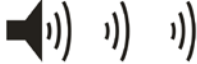

BRAKE OVERUSE WARNING

ACB provides a warning when the system is intervening and using the service brakes excessively. Overuse of the foundation brakes can lead to the brakes overheating and a potential loss of braking performance from brake fade. For example, the use of ACB on downhill runs may cause this alert to be activated. It is recommended that ACB be disengaged on downhill grades. The driver should use appropriate gearing and brake techniques, and not rely on ACB, on downhill grades.

If the driver does not respond to the Brake Overuse Warning after a brief delay, the ACB will switch off.

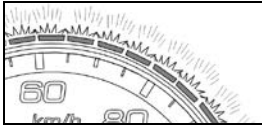
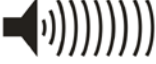
FOLLOWING DISTANCE ALERT	
CONDITION	The Following Distance Alert feature is only available when the coach speed is greater than 37 mph (60 km/h), whether or not ACB is engaged.
	The forward vehicle is slowing down and the distance between your vehicle the coach and the forward vehicle is less than the set distance
ACTIONS BY ACB SYSTEM	<p>"Distance Alert" pop-up message appears on the DID</p>  <p>The speedometer LEDs illuminate in red</p>  <p>If the vehicles remain to close from each other for more than 15 seconds, an audible warning will sound (beeping)</p> 

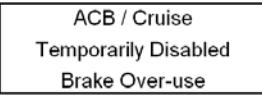
IMPACT ALERT	
SITUATION	ACB system detects a risk of collision with forward moving vehicle or a stationary metallic object in your lane of travel.
ACTIONS BY ACB SYSTEM	<p>On the dashboard, the Forward Vehicle Detected telltale flashes in red</p>  <p>"Impact Alert" pop-up message appears on the DID</p>  <p>The speedometer LEDs flash in red</p>  <p>An audible warning will sound (continuous modulating tone)</p> 

BRAKE OVERUSE WARNING	
SITUATION	ACB system is using the service brakes excessively to maintain the set following distance (for example, the use of ACB on long, steep downhill runs). Excessive application of the service brakes can cause the brakes to overheat resulting in increasing stopping distances.
ACTIONS BY ACB SYSTEM	<p>After a brief delay, the ACB system will stop functioning and be disabled.</p> <p>On the dashboard, the Forward Vehicle Detected telltale illuminates in red</p>  <p>"ACB/Cruise Temporarily Disabled Brake Over-use" pop-up message appears on the DID</p>  <p>"ACB Not Available" pictogram appears on the DID status line</p> 

4-16 Controls and Instruments

SELF-DIAGNOSTIC AT START-UP

Initiate the self-diagnostic as follows:

- The engine must be running since at least 15 seconds with parking brake applied.
- Trip the CRUISE rocker switch located on the lateral control panel from OFF to ON position.

The following sequence will begin:

1. Pop-up message “Impact Alert” will show in the DID;
2. The speedometer LEDs will flash in red;
3. FORWARD VEHICLE DETECTED telltale will flash in red;
4. The Impact Alert audible alarm will sound.

At the end of the self-diagnostic sequence, pop-up message « ACB SELF CHECK OK » will show on the DID if the system functions properly or « ACB SELF CHECK NOT OK » if a fault condition is detected.

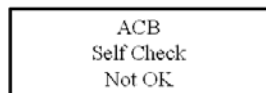
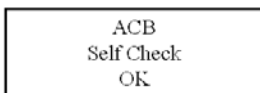

SYSTEM MALFUNCTION

In case of system malfunction, visual warnings will illuminate in the instrument cluster or the driver information display to warn the driver that the ACB is disabled. In that situation, the Impact Alert and Distance Alert functions are not available.

If the ACB is not available, the FORWARD VEHICLE DETECTED telltale light will illuminate in red and will stay on and “ACB NOT AVAILABLE” pictogram will appear on the DID status line.



FORWARD VEHICLE DETECTED telltale light



ACB NOT AVAILABLE pictogram

For proper functioning of the system, the radar must be perfectly aligned and not blocked. If a radar fault condition is detected, one of the following pop-up messages will show in the DID.

ACB RADAR MISALIGNMENT

ACB RADAR FAULT

ACB RADAR DATA LINK FAILURE

ACB RADAR BLOCKED

TIRE PRESSURE MONITORING SYSTEM (TPMS)

This system is a sensing device designed to identify and display tire operating data and activate an alert or warning when pressure or temperature irregularities are detected.

NOTE

It is the responsibility of the driver to react promptly and with discretion to alerts and warnings. Abnormal tire inflation pressures should be corrected at the earliest opportunity.

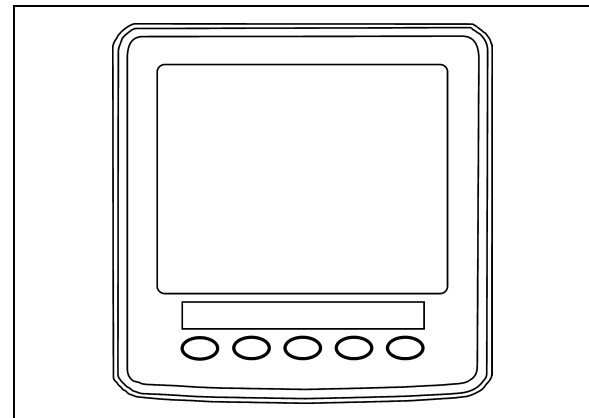

TPMS DISPLAY

06711

TPMS Display

The TPMS display knows where the sensors are located. It receives the raw temperature and pressure readings from the TPMS receiver, it reads several signals from the vehicle and does the calculation required to generate the various screens.

When no readings have been received for a tire location or when the received data corresponds to a parameter range defined as unavailable, then the reading is considered as not available and appears as two dash lines “ _ _ ”.

The TPMS display is initially configured to define how many axles and running tires are present on the vehicle. For current Prevost vehicle models, there are two axle / tire configurations. These configurations are:

Config 1: Axle 1 (Front) Two tires, Axle 2 (Drive) 4 tires, Axle 3 (Tag) 2 tires.

Config 2: Axle 1 (Front) Two tires, Axle 2 (Drive) 2 tires (super Singles), Axle 3 (Tag) 2 tires.

The TPMS display is also configured with several other parameters, including threshold levels for the alarms.

The TPMS display power supply turns OFF when the ignition key is switched OFF.

Operation

The system will monitor all vehicle tires (6 or 8) plus the spare tire when a spare is supplied.

NOTE
SOME VEHICLE MODELS DO NOT COME WITH A SPARE TIRE.

There are two configurations of vehicle tires to be supported. One configuration (the most common) consists of 8 tires total: two tires on the front axle, 4 tires on the drive axle and 2 tires on tag axle. All screen figures shown in this document relates to this vehicle configuration. The second tire configuration consist of 6 tires total: 2 tires on the front axle, 2 tires on the drive axle (super single tires) and 2 tires on the tag axle. The vehicle tire configuration is selected with a parameter (Refer to chapter « SAFETY FEATURES AND EQUIPMENT » for more information). When the display is configured for 6 tires, the drive axle tires appears as one large tire on both side instead of twin tires as illustrated in this document and there is one reading appearing on each side instead of two as illustrated in this document.

Start-up

When turning the ignition switch to ON, the screen shown below appears on the TPMS Display. Dash lines are displayed meaning that no pressure data have been received by the display.

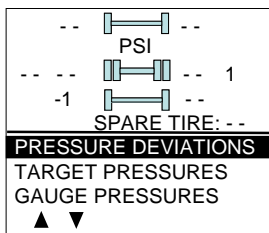
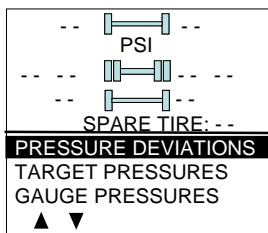

As illustrated, the pressure readings will appear replacing the dash lines as the TPMS display starts to receive pressure data from the TPMS receiver. It can take 1 minute to get all pressure readings updated since the sensors transmit at a one minute interval.

The user can flip through the menus.

Pre-Trip Check

When one of the preconditions defined to start the pre-trip check is met, the TPMS display enters into a pre-trip check routine and the screen shown below appears. The preconditions to initiate the pre-trip are: Park brake removed Or No activity on the display menu keys for a defined time (Key pressed timeout). After a pre-trip, the display is in a “drive” mode with bottom menu replaced by the alarm status. The display remains in this mode until one of the following occurs: A menu key is touched while the park brake is applied, or the park brake does a transition from released to park brake applied.

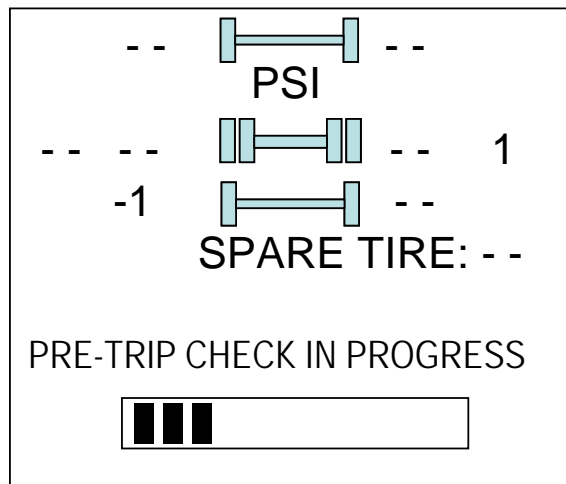

During the pre-trip check, the pressure readings for the different wheels become all available.

The pre-trip check ends, either when the pressure readings have been received for all running wheels or the pre-trip check maximum time has elapsed. It was selected to provide sufficient time for all wheel sensors to wake-up and send a first reading.

The pre-trip check is aborted and the bottom menu reappears if the park brake was active and the user press one of the menu keys.

Upon completion of the pre-trip check, the TPMS display will come up with one of the screens shown hereafter:

4-18 Controls and Instruments

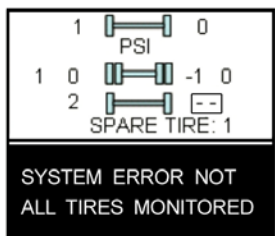
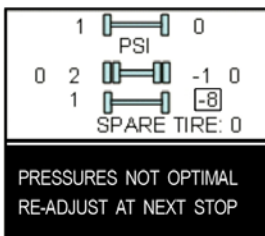
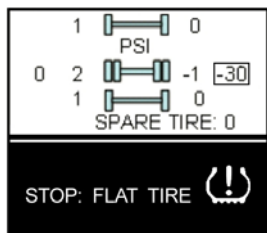
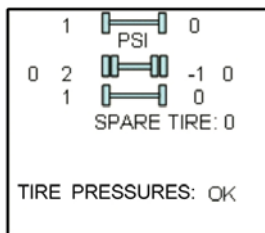

A rectangle around each pressure / temperature reading of the tires that have an issue is blinking to draw the attention to the defective tires.

In the case of multiple errors at the same time, the highest priority error is displayed at the bottom. "Flat Tire" has the highest priority followed by "High Temperature", "Not all tires monitored" and "Tire pressure not Optimal".

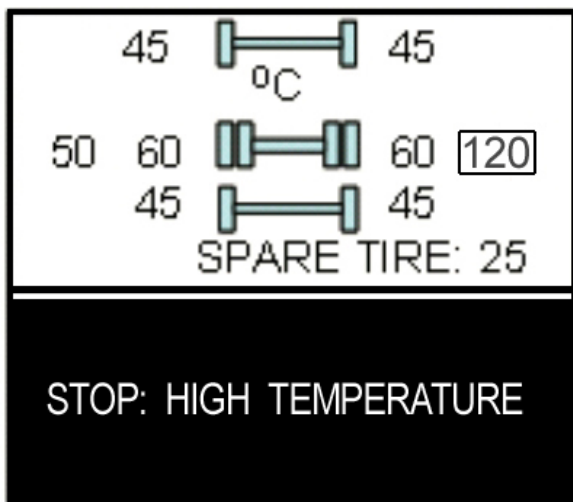

To get the driver's attention to the alarms, the bottom section of the screen where the alarm message appears will blink to reverse contrast at the following rate: 0.7 sec normal contrast, 0.3 sec reverse contrast. Pressing any key will acknowledge the alarms that are considered as non-critical and stop the blinking of these alarms message for the remaining of the trip. The non-critical alarms are: "Pressure not optimal" and "Not all tires monitored". The "flat tires" and "high temperature" alarms are critical and will keep blinking even when a key is pressed. If a different alarm occurs, blinking will start again.

The blinking rectangle around the pressure /temperature readings is not impacted by the acknowledgement and keeps blinking until the error condition disappears.

The spare tire does not contribute to alarms and so never blinks.

On the road, the TPMS display shows one of the 5 previous screens.

In the event of a temperature alarm, the display switches automatically to temperature readings.

The driver can also press any of the menu keys to momentarily switch the display to temperature readings. In this case, the temperature reading appears for 15 seconds and the display returns to pressure.

The switching to temperature by pressing a key does not take place if there is an acknowledgeable alarm active, since in this case pressing the key does acknowledge the alarm.

The switching to temperature does not take place either if there is an alarm of Temperature or Flat Tire.

The switching to temperature works when the bottom message indicates either: Tire Pressure OK, Pressure Not Optimal non flashing or not all tires monitored non flashing. When the switch is done to temperature readings, the bottom portion of the screen is not affected and still shows the status message.

NOTE

High temperature is not likely to occur during the pre-trip.

The pressure and temperature readings are continuously updated with the displayed readings of the wheel having issues blinking. The bottom line message is automatically updated to the highest priority alarm prevailing. There is a hysteresis on the alarm levels to assure that the error conditions do not flicker ON and OFF.

On the occurrence of an alarm, a beep will sound. The alarm beep could be turned OFF in the alarm settings menu.

Spare tire:

The spare tire is monitored but it is not taken into account when setting the bottom alarm messages. This is to prevent unnecessary alarms that would otherwise occur, if for example, the spare tire is removed from a vehicle.

The user will have the possibility to check the pressure of the spare tire by accessing the TPMS display menu. For vehicles that have no spare tires, the title "spare tire" will still appear on the screens but the pressure will remain with two dash lines at all time.

Post Trip Operation

When parking the vehicle (park brake applied), the TPMS display keep the drive mode display active. The driver can press any keys to get the bottom lines showing the status information replaced with the menus.

The pressure readings are still displayed and updated as new readings are received and the readings are blinking if not within the optimum pressure range.

From this point the user can scroll through the menus to get more detailed information and inflate / deflate the tires to bring them back to their optimum target pressures. Scrolling through these menus is also available prior to departure.

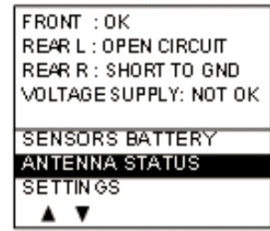
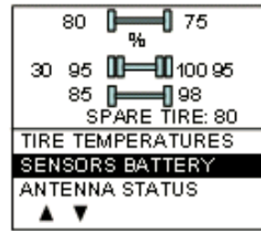
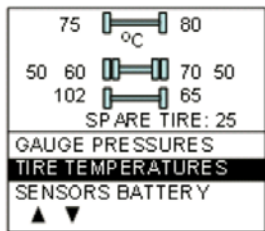
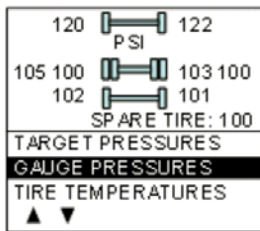
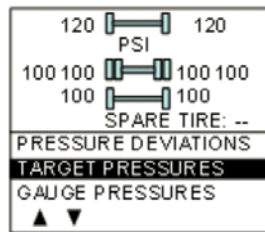
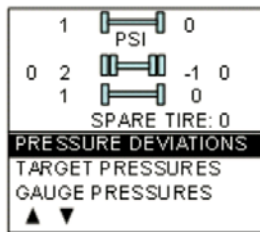

The display remains in this mode with the menus appearing at the bottom until the pre-trip check sequence starts again.

Scrolling down below the Battery life menu will show the Settings menu. Highlighting the Settings and pressing OK allows entering the settings menu. Refer to chapter "SAFETY FEATURES AND EQUIPMENT" for more information on "SETTINGS MENU".

Refer to chapter "Appendix G" for TPMS Troubleshooting Guide.

Highlighting the Exit menu and pressing OK exits the settings and come back to the pressure display mode.

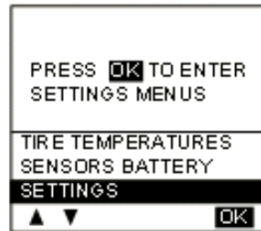

DASHBOARD

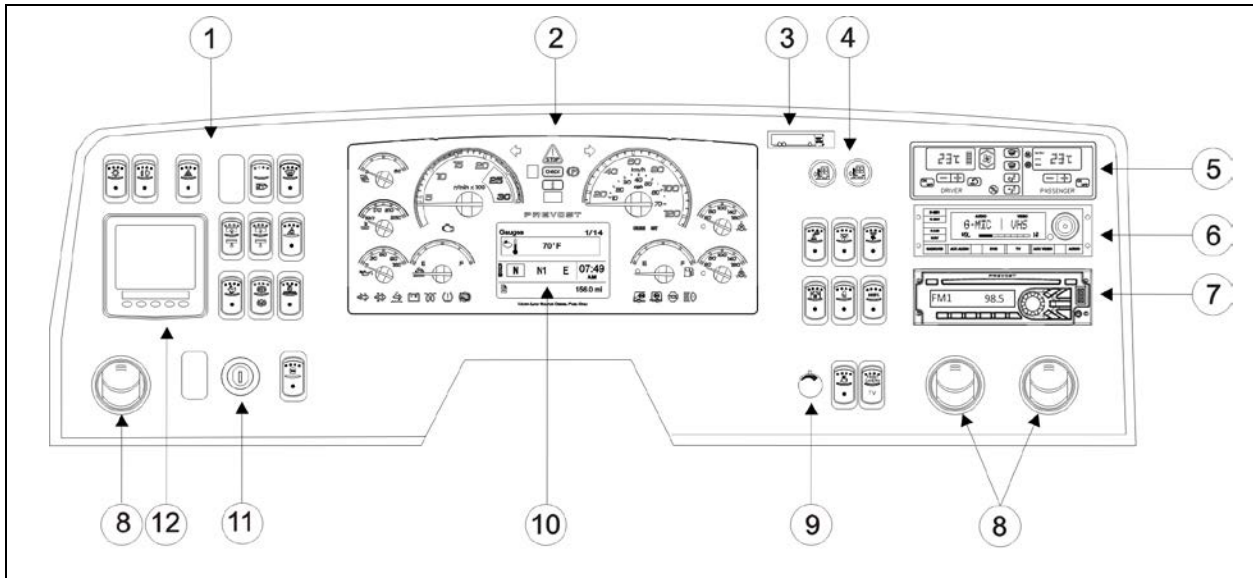

DASHBOARD

06761_3

1. L. H. Dashboard Panel
2. Instrument Cluster
3. Vehicle Clearance Information
4. R. H. Dashboard Panel
5. HVAC Control Unit
6. Audio-video Selector Panel VSS-05
7. AM/FM CD Radio
8. Air Vents
9. Brightness Control
10. Diver Information Display (DID)
11. Ignition Switch
12. Tire Pressure Monitoring System (TPMS) Display

CONTROL SWITCHES

High quality laser-engraved switches are used to control many of the features of the vehicle. Many switches have an embedded indicator LED to inform the driver at a glance which features are active. Some switches' LED will turn *OFF* after a short while when the engine is running. This is normal and is designed to reduce glare when driving. The functions still operate even if the LED is *OFF*. If the switches are still *ON* when the engine is turned *OFF*, the LEDs will illuminate to warn the driver to turn them *OFF*. Switches are described in the order they appear, from left to right, top to bottom.

L. H. DASHBOARD PANEL

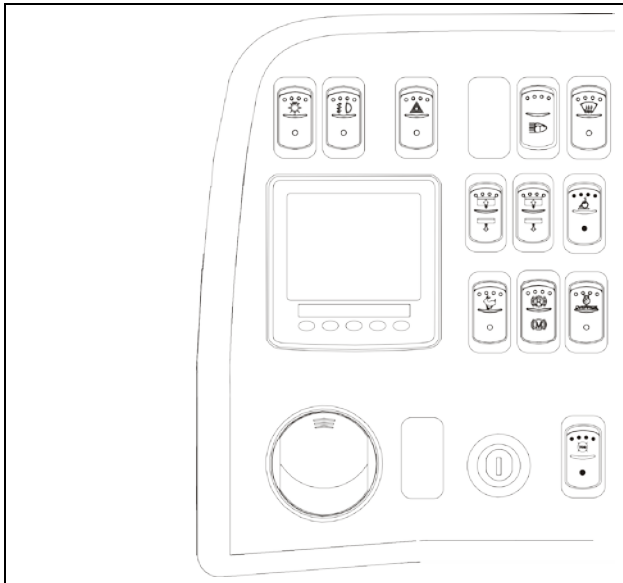

The L.H. dashboard panel includes controls for the operation of the coach; it also includes the ignition switch and an adjustable air vent.

L. H. DASHBOARD PANEL

06762_1

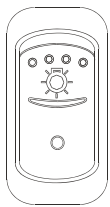

06254

Headlights and Exterior Lighting

Off position – Daytime running lights only

Press this rocker switch to turn on the following lights:

First position – Front parking lights, clearance lights, tail lights, license plate lights and marker lights.

Second position - Push down fully to turn *ON* the headlights, the controls and instrument lights and all lights from first position.

NOTE

Daytime running lights will be automatically cancelled when the exterior lighting switch is fully depressed (second position).

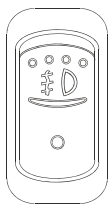

06255

Fog Lights (Optional)

Optional halogen fog lights provide better visibility in fog and precipitation. They improve close range visibility and provide added safety.

4-22 Controls and Instruments

NOTE

Some states and provinces restrict the use of fog lights. Verify local state or provincial regulations before using.



06256

Hazard Warning Flashers

Press the rocker switch to make turn signal lights flash at once. The dashboard telltale lights will flash when the hazard warning flashers are ON.

Once the hazard warning flashers are activated, the ignition switch can be turned to the OFF position. The hazard warning flashers will stay activated and will prevent the vehicle systems to fall into "sleep mode".

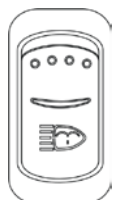

06616

Headlights washer

Momentarily press this rocker switch downwards to spray the headlights washer fluid. Each pressing of this switch produces two successive jets.



CAUTION

Do not operate the washer mechanism if the washer fluid reservoir is empty. This may damage the washer fluid pumps.

Windshield Upper Section De-icing (option)

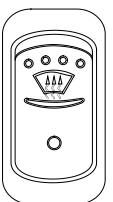

06259

The coach may be equipped with a defrosting system in the upper windshield section. Press the rocker switch to activate the blower in order to clear fog, frost or thin ice from either side of the upper windshield.

The upper windshield defrosting is automatically activated when the outside temperature is lower than 39°F (4°C), the driver's side HVAC control unit is turned on and fan speed is higher than zero. After automatic activation of the upper windshield defrosting, the upper defroster unit can be turned off by cycling this switch to the ON position and then to the OFF position.

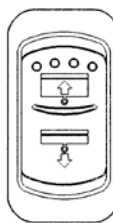

06268

Left and Right Sunshades

Two independent switches are provided, press and hold to lower or raise left or right sunshade.

Note

Dash and steering wheel controls for the sunshades work in parallel and the driver can use them based on its own preference. However, if both set of controls are pressed at the same time, the dash controls will have priority and the steering wheel controls will be deactivated until the ignition is turned off and on again.



CAUTION

Do not attempt to raise or lower these shades manually. Damage to the electric motor or roller mechanism could result.

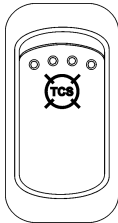

06758

Traction Control System Mud/Snow Mode

On certain road conditions, it may be useful to retard the intervention of the traction control system TCS during vehicle acceleration. The Mud/Snow function allows greater engine power and more wheel spin during TCS operation. This function may be helpful to set the vehicle in motion on iced road for example.

Press the Mud/Snow switch to turn on this function. The TCS icon blinks slowly in the DID when the TCS Mud/Snow mode is active. Always remember to turn the Mud/Snow feature off when driving on a firm road surface.

A new ignition cycle or a second pressing of the Mud/Snow switch will turn this function off.

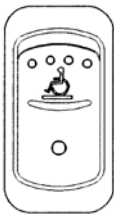

06268

Wheelchair Lift (Optional)

Activate the optional wheelchair lift by pressing down on the rocker switch. Refer to “Other Features” section and to wheelchair lift system’s Operator’s Manual for operating instructions.

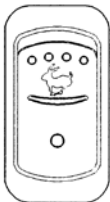

06264

Fast Idle

For extended idling periods, run the engine at fast idle. Press down the rocker switch to engage fast idle. This increases the engine speed to approximately 1,000 rpm. Return to normal idle before driving or when stopping engine.



CAUTION

Reduce the engine to normal idle before shutting the engine off.

NOTE

If the parking brake is released and/or the transmission is engaged with the engine running at fast idle, the engine will return to normal idle and remain there as long as the parking brake is not applied and/or transmission is not placed in neutral (n).

The engine will return to fast idle once the parking brake is applied or neutral (n) selected.

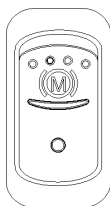

Engine Brake (Optional)

The vehicle's engine brake is by default set to automatic (AUTO (A) mode). On vehicles equipped with this switch, it is possible to disable the engine brake (OFF mode).

From OFF or AUTO mode, the driver can switch directly to Engine Brake LOW (1) or Engine Brake HIGH (2) mode by using the buttons on the steering wheel. Refer to "Transmission Retarder" & "Engine Brake" in Section 5 *Other Features*.

06703 The switch will have to be pressed again to return to AUTO (A) mode (cycling the ignition will have the same effect).

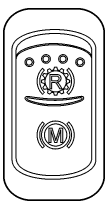

Engine Brake / Transmission Retarder (Optional)

Use this switch to select between the transmission retarder and the engine brake when using the vehicle speed retarding device switches on the steering wheel. Both systems cannot be in function at the same time. This rocker switch will be found on the dashboard only if the vehicle is equipped with both systems. Refer to "Transmission Retarder" heading in this chapter. Refer also to "Transmission Retarder" & "Engine Brake" in "OTHER FEATURES" chapter.

06703



Engine Stop Override (with Automatic Fire Detection and Suppression System)

Press the Engine Stop Override switch on the dashboard or the Delay Engine Stop switch on the AFSS protection panel to delay the engine shutdown and extinguisher discharge by an additional 15 seconds.

06265



CAUTION

Use this function if you are not prepared to bring the vehicle to a safe stop (i.e. on a railroad track, in intersection).

This switch is functional only if the vehicle is equipped with the Automatic Fire Detection and Suppression System.



06571

Driver Controlled Differential Lock (DCDL) (Optional with Meritor Drive Axle)

Press the rocker switch to lock or unlock differential action. Refer to "Other Features" chapter for the complete operating instructions.



CAUTION

- Engage DCDL only under poor road surface conditions.
- DCDL will not engage and will disengage in speed higher than 5 mph.
- Do not lock DCDL when one or more wheels are slipping, spinning or loosing traction. You can damage the drive axle.
- Using the rocker switch, unlock DCDL when the need for improved traction has passed otherwise it will reengage automatically as speed gets below 5 mph. Over a prolonged period, this situation will increase tire wear and stress to the vehicle.
- Do not engage during downhill operation.

R. H. DASHBOARD PANEL

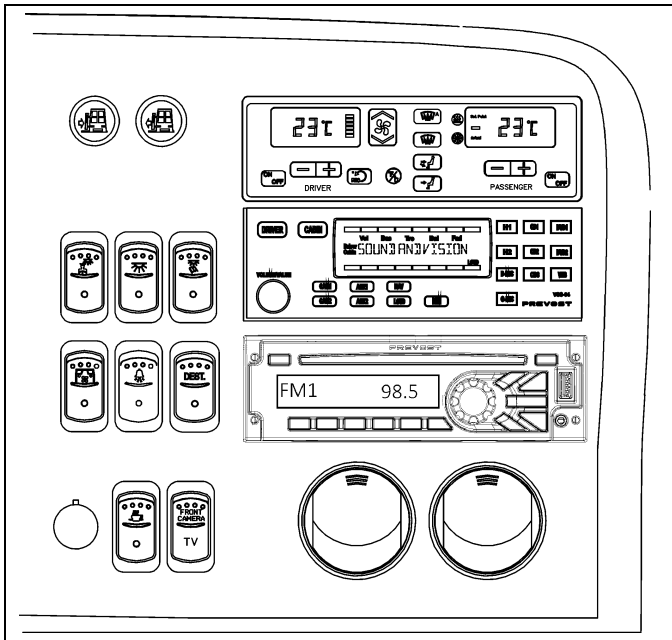

The HVAC control module as well as the cluster dimmer switch, interior lighting control switches, entrance door operating buttons as well as miscellaneous control switches and air vents are located on the R.H. dashboard panel.

R. H. DASHBOARD PANEL

06707_2



Entrance Door Operating Buttons

Press and hold the L.H. button to open the door and the R.H. button to close the door.

06464

Releasing the button at any time will immediately stop door movement.



WARNING

The door mechanism has no automatic safety protection to avoid injury to bystanders. The driver is responsible for the safe operation of the door.

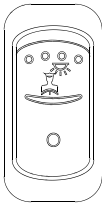

06244

Driver's Area Lighting

Press the rocker switch to illuminate the ceiling lights in the driver's area as needed.

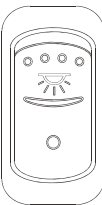

06239

Interior Lighting

Press this rocker switch to the first position to illuminate the aisle fluorescent lighting. Press down the second position to gradually illuminate the in-station reading lights to 80% of their intensity regardless if they were turned off individually by passengers. Lights will also turn OFF gradually.



CAUTION

To avoid running down the batteries when the engine is off, turn off the lights or connect the optional battery charger to a 110 - 120 volt AC power supply.

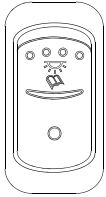

06240

Reading Lights

This switch powers the reading light circuit enabling passengers to operate their personal reading lights. Refer to "Coach Interior" chapter.

Turning the key or ignition lever to the accessory position "ACC" when the reading lights are on will activate the lights to full intensity, providing a clear view over the entire cabin area.

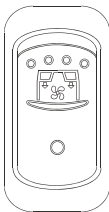

06245

Passenger Overhead Air Registers

Press the switch to the first position to set the fans to low speed. Press the switch to the second position to set the fans to high speed.

If equipped with the optional air conditioning in the overhead compartments, activating the fans also engages the A/C compressor.

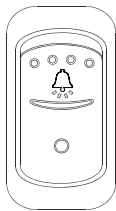

06243

Stop / Service Chime (Optional)

Press this switch to enable the stop / service chime. When depressed, the service buttons illuminate even when the chime circuit is not enabled.



06262

Destination Sign (Optional)

Press the rocker switch to illuminate the destination sign.



06249

Brightness Control

Adjusts the brightness of the dashboard instruments and switches.

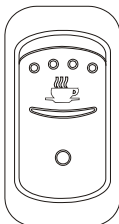

06241

Galley (Optional)

This switch activates the galley's electrical circuit.

HVAC CONTROL UNIT



The vehicle is slightly pressurized by the central HVAC system to prevent dust and moisture from entering. Air flow and controls divide the vehicle into two areas: driver's area with defroster and passengers' area.

Fresh air is fed in each area and has a separate return air and discharge air duct.

NOTE
 To operate the air conditioning system when stationary, run engine at fast idle. When the system is running, keep windows and door closed.

To prevent battery run-down, the central A/C and heating systems will not operate if the charging system is not working properly.

When the A/C system is running, park at least 4 feet (1,5 m) from other vehicles or buildings to allow sufficient air flow through the condenser core.

Separate driver and passenger heating, ventilation and air conditioning controls are located on this panel. To operate, the vehicle's engine must be running.

The driver's and the passengers' units may be turned ON by pressing  button.

Also, the driver's HVAC section turns on automatically at starting of the engine and uses the settings that were kept in memory before turning off of the system.

The A/C compressor starts automatically when the two following conditions are satisfied:

1. The outside temperature is above 32°F (0°C).
2. The passenger's area temperature has reached 7°F (4°C) under the set point.

All parameters set before turning the system OFF will be kept in memory for the next power ON.

The HVAC module performs a self-diagnosis every time it is turned ON. Codes are shown on displays or flashed on control buttons. Refer to "Maintenance Manual" for more information on the diagnostic codes.

Heating Mode Indicator



22131

This red LED illuminates when system is heating.

Cooling Mode Indicator



22134

This green LED illuminates when the system is cooling (when the compressor clutch is engaged).

Fan Speed



22135

The driver's fan has six speeds. Increase speed by pressing on the upper portion of the button, decrease by pressing on the lower portion.

Recirculate



22138

Closes or opens the driver's and passenger's section fresh air damper.

A red LED in the top right corner of the button illuminates when air is recirculated. Use for faster driver's section heating.

This feature is automatically cancelled when defogging is activated.

Driver's section temperature setting



22303

The temperature displayed on the driver's side HVAC control unit is the temperature set point.

To increase the temperature set point, press on the "+" sign, to decrease the temperature set point, press on the "-" sign. Temperature range is between 60°F and 82°F (16°C to 28°C). On the driver's side only, asking for a temperature set point above 82°F (28°C) will keep the coolant valve open and "FUL" will be displayed.

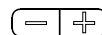

22132

In case of interior temperature sender unit failure, the coolant valve will remain open and two dashes "--" will be displayed.



WARNING

Warm temperatures may cause drowsiness and affect alertness while driving. Keep the temperature comfortable but not too high.

Passenger's section temperature setting

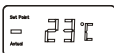

22304

The temperature displayed on the passenger's side HVAC control unit is the actual temperature in the passenger's area.

To increase or decrease the temperature set point in the passenger's area, press on the "+" or the "-" sign. Pressing these buttons will flash the displayed set point and the word "SET" will highlight. Temperature range is between 60°F and 82°F (16°C to 28°C).



22132

In case of interior temperature sender unit failure, the coolant valve will remain open and two dashes "--" will be displayed. The driver can nevertheless control the temperature by adjusting the temperature set point above 72°F (22°C) to heat and below 72°F (22° C) to cool.

NOTE

Upon starting, if the outside temperature is above 32°F (0°C) and then drops below 32°F (0°C), the compressor will keep running up to a temperature of 15°F (-9°C) to prevent condensation from forming on the windows.

Windshield Defogger



22305

Upon pressing this button, the dashboard damper sends air only to the lower windshield. The fan is turned on to maximum speed, the fresh air damper opens completely (REC off) and the driver set point is increased to 4°F (2°C) over the passenger's section set point.



22139

The dashboard damper sends air only to the lower windshield when activated. The footwell damper is closed also but the fan speed can be reduced or increased.

Panel and Footwell



The dashboard damper sends air to

22137 the panel vents and footwell.

Panel



Air is sent to panel registers. The footwell damper is closed.

Temperature Degree Selector



22133



Toggles the HVAC control unit temperature units between Fahrenheit and Celsius. The driver's section must be on. Also toggles the outside temperature units displayed on the telltale panel.

AUDIO-VIDEO SELECTOR FOR THE PASSENGER'S AREA



The VSS-05 Video and Sound Selector enables the driver to select audio, audio/video and video source with settings of volume level, bass, treble, etc. for the passenger's area only. The DVD player, TV tuner, P.A. system and auxiliary audio or video sources are controlled with this unit.

TURNING POWER ON AND OFF

Press  button to turn on the unit.
Press  button again to turn off the unit.

SETTING OF VOLUME/ BASS/ TREBLE/ BALANCE/ LOUDNESS

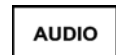

Press audio button repeatedly to choose the desired mode. Each press changes the modes as follows:



Turn volume knob until the desired sound is obtained in each mode. The final setting will apply to all audio sources for the passenger's area. If no button is pressed within 8 seconds after selecting BASS, TREB, BAL and LOUD modes, the unit automatically sets in the VOL

mode. The volume value adjust from 0 (complete mute) to 40 (maximum).

SELECTION OF AUDIO OR AUDIO/VIDEO SOURCE

RADIO/CD Press RADIO/CD button to select the dashboard radio as current audio source for the passenger's area. Pressing this button will also permit to listen to the CD inserted in the dashboard radio.

AUDIO IN Press AUDIO IN button to select an auxiliary audio input as current audio source. AUDIO IN RCA connections are located at the back of the VSS-05 unit.

DVD Press DVD button to select the in dash DVD player as current audio/video source.

TV If an optional TV tuner is installed, press TV button to select it as current audio/video source.

VIDEO IN Press VIDEO IN button to select an auxiliary video input as current audio/video source.

NOTE
<i>If CAM or NAV is already activated, DVD, TV or VIDEO IN cannot be selected and displayed.</i>

OPERATION OF THE OPTIONAL AUDIO-VIDEO MODESTY PANEL

On some vehicles, it is possible to connect and display on the main monitor a laptop or other audio-video equipment (DVD player, gaming console) from an optional audio-video modesty panel located behind the driver's seat.

To do so, connect the laptop to the modesty DB9 connector (9 pins, blue connector), select Video IN on the Video and Sound Selector and turn on the laptop presentation mode.

Devices using RCA connectors (DVD, gaming console) can also be used by connecting them to the 3 modesty RCA connectors and selecting the Video and Sound Selector TV mode.

4-30 Controls and Instruments

OPERATION OF THE PANORAMIC VIEW CAMERA

CAM

1. Press CAM button to select the optional panoramic view camera signal. The video section of the vss-05 lcd panel will show "CAM". The video monitors turn on automatically.
2. Press CAM button again to turn off the panoramic view camera and return to previous audio/video source.

DISPLAY OF THE GPS NAVIGATION GUIDANCE SCREEN

NAV

Not applicable

NOTE

When CAM or NAV is selected, the previously selected audio source remains active.

OPERATION OF THE DRIVER MICROPHONE

D-MIC

1. Press D-MIC button to turn on the driver microphone. The audio section of the lcd panel will show "D-MIC" and a gong sound can be heard.
2. Turn volume knob to adjust microphone level.
3. Press D-MIC button again to turn off the driver microphone.

OPERATION OF THE GUIDE MICROPHONE

G-MIC

1. Press G-MIC button to turn on the guide microphone. The audio section of the lcd panel will show "G-MIC" and a gong sound can be heard.
2. Turn volume knob to adjust microphone level.
3. Press G-MIC button again to turn off the guide microphone.

NOTE

The driver and guide microphones can be turned on only by turning the switch on the microphone to on.

If both the driver and guide microphone are activated, the driver microphone has priority and the guide microphone is muted.

BACKGROUND VOLUME ADJUSTMENT

When a microphone is activated, the current audio source volume will reduce to a certain level which has been set at the factory. To adjust this level, proceed as follows:

- 1- Press and hold AUDIO button then press AUDIO IN button. The LCD panel will show "BACK GROUND".
- 2- Turn the volume knob to adjust the background level.
- 3- Press any button to save the setting. If no button is pressed within 8 seconds, the unit automatically saves the setting and exits this mode.

GONG SOUND LEVEL

A gong will sound in the passenger's area upon activating of the microphone. This gong will also sound when a passenger activates the service bell. The gong sound level can be adjusted as follows:

- 1- Press and hold AUDIO button then press VIDEO IN button. The LCD panel will show "GONG PASS".
- 2- Turn the volume knob to adjust the gong level.
- 3- Press any button to save the setting. If no button is pressed within 8 seconds, the unit automatically saves the setting and exits this mode.

NOTE

While maintaining the service bell gong active, the gong sound heard upon activation of the microphones can be disabled. To do so,

- 1- *Press and hold audio button then press G-MIC button. The lcd panel will show "GONG-MIC-ON" or "GONG-MIC OFF".*
- 2- *Turn the volume knob clockwise to activate the microphones gong sound. Turn the volume knob counterclockwise to deactivate the microphones gong sound.*

USING THE VSS-05 REMOTE CONTROL



1.  Press this button to turn on the unit.
Press this button again to turn off the unit.
2. R/CD, AU IN, DVD, TV, VI IN Press one of these buttons to select the relevant audio or audio/video source.

3. DMIC

Press DMIC button to turn on the driver microphone.

Press DMIC button again to turn off the driver microphone.

4. GMIC

Press GMIC button to turn on the guide microphone.

Press GMIC button again to turn off the guide microphone.

5. CAM

Press CAM button to select the optional panoramic view camera signal.

Press CAM button again to turn off the panoramic view camera.

6. NAV

Press NAV button to display the optional gps navigation system guidance screen (not applicable).

7. BAS, BAL, TRE, LOUD

Press one of these buttons to select bass, balance, treble and loudness mode.

8. +, -

Press these buttons to increase or decrease the value for bass, balance, treble and loudness mode.

NOTE
Point the remote control in direction of the VSS-05. Remote control battery replacement. Use CR2025 lithium battery.

DASHBOARD RADIO/MP3/IPOD/CD PLAYER

Select from several sources of entertainment for the driver's area such as AM, FM, WX weather band, Satellite radio services and Bluetooth (phone calls). Play a CD inserted in the radio's CD slot or listen to a MP3 device or iPod through this unit. The complete radio operating

instructions manual is included in Technical Publication box.



1. Storing Radio Station Presets

- Tune the desire frequency, and then long press any of the Preset (1-6) buttons until the radio produces a beep.

Tuning Radio Station Presets

- Short press any of the Preset (1-6) buttons.

2. Play/Pause

- Press to pause/unpause Media.

3. Browse

- Press to Navigate on the device and select a specific song or play context (Applicable to USB sticks, CD MP3 discs and iPods).

4. Clock/Alarm

- Press during Alarm activation to cancel the Alarm.

5. RPT (Repeat)

- Press to repeat current track. Press again to stop repeat.

6. RDM (Random)

- Press to play the tracks randomly. Press again to stop random mode.

7. ESC (Escape)

- Press to exit one Menu Level.
- While on Bluetooth (if equipped): Press to reject or to end a Call.

8. DSP (Display)

- If vehicle Ignition is ON:
 - Press to Change Source Display Views.

4-32 Controls and Instruments

- Press for more than 3 seconds to show the Clock for a short time.
- If vehicle Ignition is OFF:
 - Press to turn on the Radio and show the clock for a few seconds.

9. SCAN/ASCN (Scan/Autoscan)

- Scans stations/CD tracks/MP3/WMA files and folders and in tuner, stores strongest stations to presets.

10. PREV (Previous/Reverse)

- Press to select previous track or station.
- Press and hold for fast reverse or Tune Down.

11. Auxiliary port

- 3.5 jack stereo (iPod/MP3).

12. USB port

- iPod/MP3 players

13. Eject

- Press to eject CD

14. NEXT

- Press to select next track or station.
- Press and hold for fast forward or Tune Up.

15. SRC/PWR (Source/Power)

- Press to turn Radio ON
- Press to switch to FM->AM->WX weather band->SXM satellite-> CD->USB/iPod-> Rear/Front AUX-> Bluetooth.
- Press and hold to turn radio OFF.
- With the ignition off, pressing the button will turn on the receiver and it will turn off after one hour (timer).

16. Rotary knob

- Press for less than 3 seconds to display Audio Control Menu.
- Press for more than 3 seconds to Show the User Menu.
- Rotate to Increase/decrease Volume or during a Menu for Navigation.
- Press while in a Menu to confirm the selected action.

17. CD slot

- Insert/Remove CD

NOTE

Using phone when driving is not recommended. For this reason, there are no microphones installed on the radio at the factory.

NOTE

The driver speakers are controlled from the dashboard radio volume knob while the passenger's area speakers are controlled from the VSS-05 Sound Selector volume knob.

See the owner manual for more information about how to use the radio. This manual is available on the technical Publications web site at <https://techpub.prevostcar.com/en/>. Select Supplier Publication tab and select Delphi in the list of supplier's name for a faster search.

AIR VENTS

Three adjustable driver air vents in the dashboard and one near the door feed air to the driver's compartment. Use the HVAC control panel to set air temperature and fan speed.

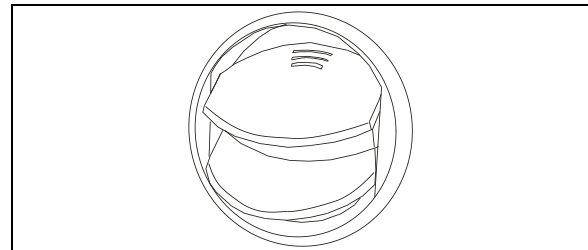

AIR VENT

INSTRUMENT CLUSTER

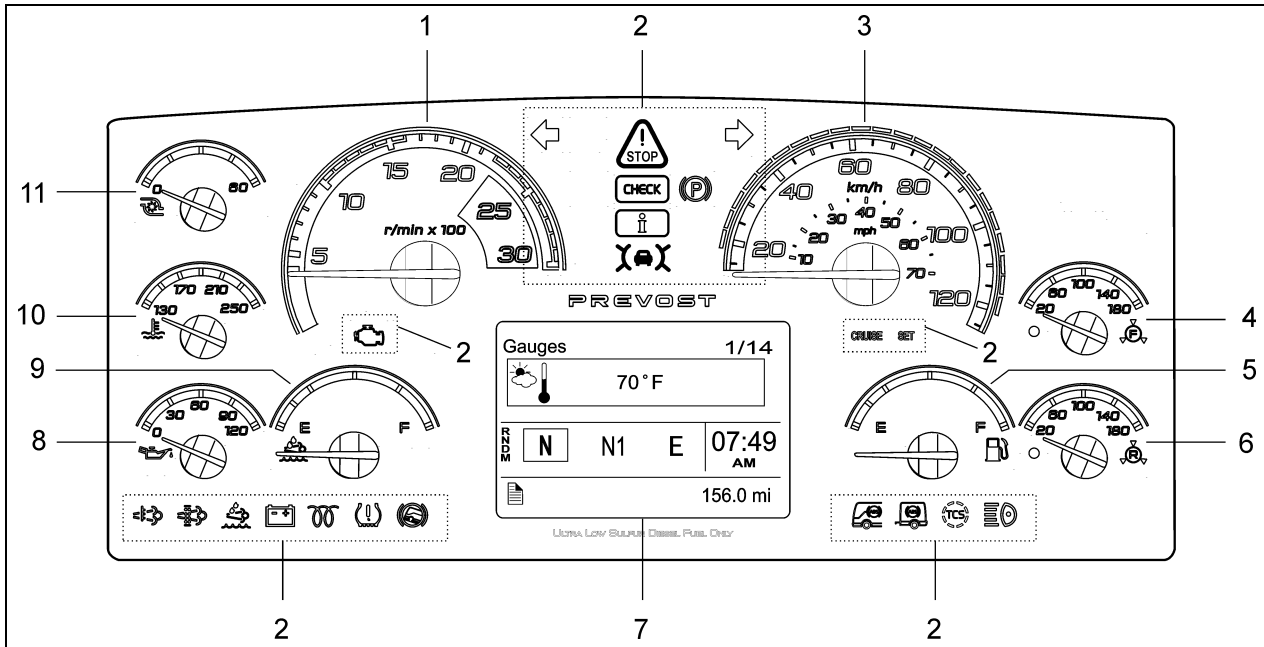

06727

- | | |
|---|---|
| <ul style="list-style-type: none"> 1. Tachometer 2. Telltale lights 3. Speedometer 4. Front brake air pressure (secondary) 5. Fuel level 6. Rear brake air pressure (primary) | <ul style="list-style-type: none"> 7. Driver Information Display (DID) 8. Oil pressure indicator 9. DEF level (Diesel Exhaust Fluid) indicator 10. Engine coolant temperature 11. Turbo boost pressure |
|---|---|

The instrument cluster includes the analog instruments. It also presents two devices to communicate information to the driver, the telltale lights and the Driver Information Display (DID).

Indications and warnings are presented according to three levels of attention required:

LEVEL A. THE TELLTALE LIGHTS

The highest level of attention. The telltale lights are temporary and exceptional; they present information critical to safety or vehicle integrity.

LEVEL B. POP-UP MESSAGES

The second level of attention. Pop-up messages appear in the Driver Information Display DID without the driver's intervention and

acknowledgement. Pop-up messages present supplemental information to the driver.

LEVEL C. THE STATUS LINE

The lowest level of attention. The status line monitors certain systems and gives feedback to the driver concerning current actions and functions.

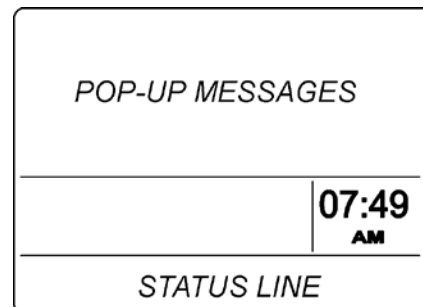

06742

ANALOG INDICATORS

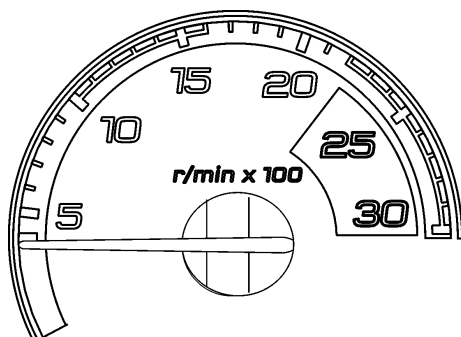

06728

TACHOMETER (RPM X 100)

Indicates the operating speed of the engine in hundreds of revolutions per minute. The tachometer serves as a guide for gear shifting and helps to prevent engine over-speeding when driving downhill with the engine brake operating. Use the green field for normal driving (1000 to 1600 rpm).

	<p>CAUTION</p> <p>Never allow the engine to go into the red field. This could lead to severe engine damage.</p>
---	--

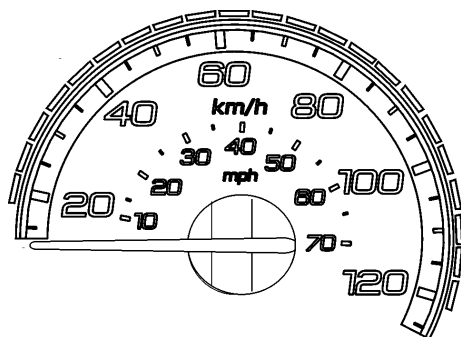

06729

SPEEDOMETER (MPH, KM/H)

Indicates the vehicle speed in miles per hour (mph) and kilometers per hour (km/h). The LEDs above the instrument work in conjunction with AWARE Adaptive Cruise Braking (ACB) system. Refer to “Prevost AWARE Adaptive Cruise Braking” paragraph.

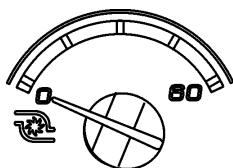

06730

TURBO BOOST PRESSURE (PSI)

Indicates the turbo boost pressure in psi. This pressure should be the same at a given engine temperature, speed, and load. An unusual reading could indicate an engine failure.

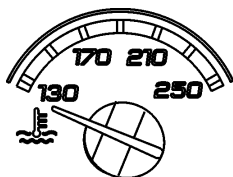

06731

ENGINE COOLANT TEMPERATURE (°F)

Indicates the operating temperature of the engine coolant in °f. The normal reading should be between 170°f and 222°f (80°c to 106°c).

The temperature limit is dependent on the electronic program for the engine model. When coolant temperature is excessive, the stop telltale light turns on, an audible alarm sounds and a pop-up message appears on the DID. The engine protection

system will automatically derate and stop the engine in 30 seconds. Stop at the first safe place where the problem can be checked.

If the temperature remains below or exceeds the normal temperature range, the cooling system should be checked for problems.



STOP TELLTALE LIGHT

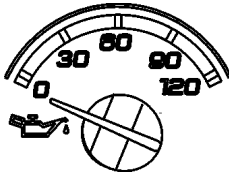

06732

ENGINE OIL PRESSURE (psi)

Indicates the engine oil pressure in psi. When the oil pressure is too low, the stop telltale light turns on, an audible alarm sounds and a message appears on the DID. The engine protection system will automatically derate and stop the engine in 30 seconds. Bring the vehicle to a safe stop where the problem can be checked.



STOP TELLTALE LIGHT



OIL PRESSURE PICTOGRAM



WARNING

Failure to take necessary action when the stop telltale light is on can ultimately result in automatic engine derate and shutdown.

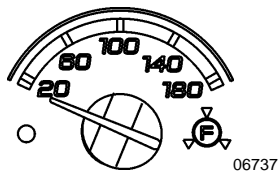

Front Brake Air Pressure Gauge (Secondary System)

Indicates the front brake air system pressure in psi. The normal operating pressure is from 122 to 140 psi.

The **low air pressure** indicator LED on the gauge and the **STOP** telltale light illuminates when the front brake air system (secondary) pressure drops below 85 psi. An audible alarm will sound.



STOP telltale light

	<p>WARNING</p>
<p>The driver is responsible for monitoring the pressure as part of a regular sweep of the instruments.</p> <p>If the pressure drops in the secondary system but remains normal in the primary system, the front axle service brakes will not function but the drive and tag axle service brakes will operate normally, although if there is a leak in any pneumatic system (Sec/Pri/Park/Acc), the primary system might eventually lose its air pressure as well, depending on the nature and size of the leak. In the event of any air pressure loss in any system, the driver should pull to the side of the road as soon as can be safely done and investigate the situation.</p> <p>Do not drive the coach when the brake air pressure is low.</p>	

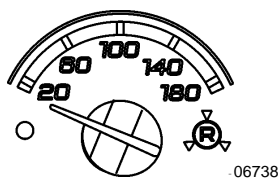

Rear Brake Air Pressure Gauge (Primary System)

Indicates the rear brake air system pressure in psi. The normal operating pressure is from 122 to 140 psi.

The **low air pressure** indicator LED on the gauge and the **STOP** telltale light illuminates when the rear brake air system pressure drops below 85 psi. An audible alarm will sound.



STOP telltale light

	<p>WARNING</p>
<p>The driver is responsible for monitoring the pressure as part of a regular sweep of the instruments.</p> <p>In the event of a pressure loss in the primary brake system, the drive and tag axle service brakes will not function normally. It is critical to bring the coach to a safe stop as quickly as possible.</p>	

If there is sufficient pressure in the secondary brake system, modulated spring brake pressure (using the park brake chambers) will be used to apply the drive axle brakes, proportional to the braking pressure on the front axle. It must be noted this is an emergency situation and a significant amount of secondary air pressure is lost with each apply/release cycle. The spring brake modulation will only function two or three times, depending on the amount of secondary air pressure that was on hand when the primary brake pressure was lost.

Once the secondary air pressure drops below 60 psig, the park spring brakes are fully applied and cannot be released until pressure is restored.

Do not drive the coach when the brake air pressure is low.

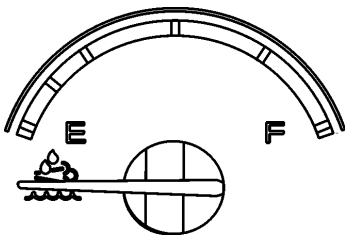

06735

DEF level

Indicates the amount of DEF (diesel exhaust fluid) remaining in the DEF tank. The DEF tank is considered as being full when it contains 16 gallons (60 liters) of DEF. DEF consumption will be approximately 2% of the diesel fuel consumed.



CAUTION

DEF will begin to crystallize and freeze at 12°F (-11°C). DEF expands by approximately 7% when frozen. In order to permit DEF expansion without causing damages to the DEF tank, do not fill the DEF tank with more than 16 gallons (60 liters).

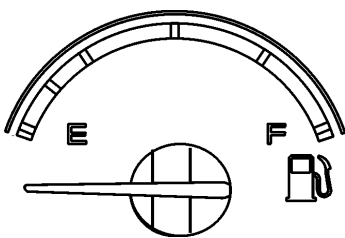

06736

Fuel Level

Indicates the amount of fuel remaining in the fuel tank. At the beginning of the red area, there is approximately 48 gallons (182 liters) left in the tank.

NOTE

A pop-up message will appear in the DID informing that there is only 24 gallons (92 liters) left in the fuel tank.

TELLTALE LIGHTS

The telltale lights illuminate during 5 seconds at the start of every ignition cycle as a light bulb check.



STOP

Indicates that a serious problem has been detected. Immediately park the coach in a safe place and stop the engine. This telltale light may be accompanied with a message in the DID and a diagnostic troubleshooting code will be stored to ease identification of the problem. **WARNING:** Failure to take necessary action when the STOP telltale light is on can ultimately result in automatic engine derate and shutdown.



CHECK

Indicates that a problem has been detected and must be checked at the next stop. This telltale light may be accompanied with a message in the DID and a diagnostic troubleshooting code will be stored to ease identification of the problem.



FORWARD VEHICLE DETECTED – ADAPTIVE CRUISE BRAKING

When the ACB is engaged with a cruise speed set and the forward vehicle is in range, the FORWARD VEHICLE DETECTED telltale light illuminates, indicating the ACB system is actively tracking the forward vehicle.

GREEN: The vehicle ahead of you is detected by the radar.

FLASHING RED: Impact alert. The vehicle ahead of you is too close. The driver must take immediate evasive action by applying more braking power and/or steering clear of the vehicle ahead to avoid a potential collision.

RED: System malfunctions. The Adaptive Cruise Braking is not available.



INFORMATION

This telltale light illuminates when there is a new information message or an abnormal status is detected by the electronic control unit. A pictogram, text or both are shown in the DID in addition to the info telltale light. Make sure the indicated fault is checked at the next stop.



TURN SIGNAL INDICATORS

Flashes when the right or left turn signals are activated. Signal right and left turns by operating the multi-function lever. See “Steering Column Controls” in this chapter.

NOTE

The turn signals are automatically activated when the vehicle is backing up.



PARKING BRAKE OR EMERGENCY BRAKE APPLIED

Illuminates when the emergency/parking brake is applied. The control valve is located on the L.H. control panel. An audible alert will sound if ignition is turned to off and the parking brake is not engaged.



AFTERTREATMENT SYSTEM MALFUNCTION (MALFUNCTION INDICATOR LAMP)

Indicates a failure of an emission control device. May illuminate at the same time as the CHECK amber warning light. The lamp will go out after 3 completed ignition on-ride-ignition off cycles. Vehicle can be driven to end of shift. Call for service.

CRUISE

CRUISE CONTROL

Indicates that the cruise control is enabled.

SET

CRUISE CONTROL SET SPEED

Indicates that a cruising speed is set and stored in the memory.



HIGH EXHAUST SYSTEM TEMPERATURE (HEST)

Illuminates to notify the driver of potentially hazardous exhaust gas temperature at the exhaust system diffuser.

06740_A



WARNING

During regeneration, exhaust temperature may reach up to 1200°f (650°c) at the particulate filter. When parking the vehicle, if this telltale light is illuminating, make sure that the exhaust system diffuser is away from people or any flammable materials, vapors or structures.



DPF REGENERATION REQUEST

Illuminates to notify the driver that a manual stationary regeneration will be required soon. Refer to "Exhaust Aftertreatment System" paragraph in Other Features chapter.

06740_B



06740_C

Low DEF level

Illuminates when there is less than 2.6 gallons (10 liters) of DEF left in the tank.



CAUTION

This telltale light starts flashing when there is only 2.5 liters (0.6 gallons) left in the tank.

If the vehicle is kept in operation with an empty DEF tank, and engine derate will eventually occur, limiting the speed to 5 mph.



06740_D

CHARGING SYSTEM WARNING LIGHT

Indicates a malfunction of the charging system or a low battery voltage condition.

NOTE

To identify if an alternator is defective (1=lower alternator, 2=upper alternator), perform a system diagnostic using the Driver Information Display DIAGNOSTICS menu. Select VIEW ACTIVE FAULTS and then ELECTRICAL SYSTEM. Scroll through the active faults. The electrical system active faults will appear. A diagnostic message indicating "alternator 1" or "alternator 2" with failure mode "open circuit" will come in sight.



06740_E

INTAKE AIR PREHEATER ON – WAIT BEFORE STARTING

Illuminates when the intake air preheater element is in function. Wait until this telltale light has turned off before starting the engine. For more information on this feature, refer to paragraph "Cold Weather Starting" in Starting And Stopping Procedures chapter.



06740_F

FLAT TIRE (WITH OPTIONAL TIRE PRESSURE MONITORING SYSTEM)

Illuminates when a tire pressure is 25% below the target tire pressure.



06740_G

HILL START ASSIST

Indicates a malfunction of the hill start assist function. This function might not be available.



06740_H

ANTILOCK BRAKE SYSTEM (ABS)

Illuminates when the ABS is not available or when the ABS is malfunctioning. Since the ABS system does not operate at less than 4 mph (7 km/h), the indicator will remain illuminated until the coach reaches that speed. Refer to Other Features chapter.



06740_I

TRAILER ANTILOCK BRAKE SYSTEM (ABS)

Illuminates when the trailer ABS is not available or when the trailer ABS is malfunctioning.



06740_AA

ESC - TRACTION CONTROL SYSTEM

At vehicle ignition, the ESC telltale lamp illuminates for approximately 3 seconds and then turns off. If it remains on steadily (not flashing) after ignition, or if it illuminates steadily while you are driving, the ESC system may not be fully functional or their operation may be completely disabled. If this happens, your vehicle will still have normal service braking can still be driven, but without the benefits of the ESC system.

Flashes quickly when ESC intervenes to reduce risk of loss of control.



06740_K

HIGH BEAM

Illuminates when the high beams are selected. High and low beams are selected with the multi-function lever. Refer to “Steering Column Controls” paragraph in this chapter.

STOP, CHECK AND INFORMATION TELLTALE LIGHTS

STOP, CHECK and INFORMATION telltale lights illuminate automatically to draw the attention of the driver and their associated messages are displayed in the DID. More than one message (see “Acknowledging Messages” below) can be active at the same time. A displayed message can be replaced by a new message provided the new message has a higher priority. Only fault codes that have a direct impact on vehicle operation are displayed. All fault codes are stored in the appropriate ECU for access by service technicians.

STOP Telltale light

In the event of a serious fault, the red STOP telltale light comes on and an audible alarm will sound if the engine is running. An illuminated stop message light indicates a serious problem has been detected, and the driver must respond immediately to the problem.



When illuminating, this telltale light means the vehicle must be safely pulled off the road and stopped. In some instances, the engine must be switched off immediately.



WARNING

Failure to stop and take necessary action when the stop telltale light is on can result in automatic engine derate and shutdown.

In some cases preventive action may be taken by the engine ECU to protect the engine. For further details, refer to “Engine Protection System” in *Starting and Stopping Procedures*.

CHECK Telltale light

This telltale light means that a fault or an abnormal operating condition has been detected. The vehicle must be checked at the next stop.

4-42 Controls and Instruments

CHECK

If the CHECK telltale light illuminates, an associated message is displayed in the DID. Always pay attention to the associated messages (see “Acknowledging Messages” below).

INFORMATION Telltale light

The INFO indicator light comes on when there is a new information message or an abnormal status is detected by the electronic control unit. A pictogram or text or both are shown in the DID in addition to the INFO telltale light (see “Acknowledging Messages” below).



Acknowledging Messages

A fault message associated to a STOP, CHECK or INFORMATION telltale light must be acknowledged by pressing the ESCAPE or ENTER button after which the display returns to the same status that existed before the fault occurred. All messages can be acknowledged. Acknowledged but inactive messages are displayed again when the ignition key is turned to the START position or they can be read in the DID menu. Refer to *Other Features* for more information on the DID menus.

DRIVER INFORMATION DISPLAY

The DID (Driver Information Display) is located in the center of the instrument cluster. It displays digital gauges, main menus and sub-menus that provide necessary and important information to the driver. The information available to the driver depends on vehicle configuration, and whether the vehicle is in operation or parked. For the list of the available menus and sub-menus, refer to “Driver Information Display Menus” in *Other Features* chapter.

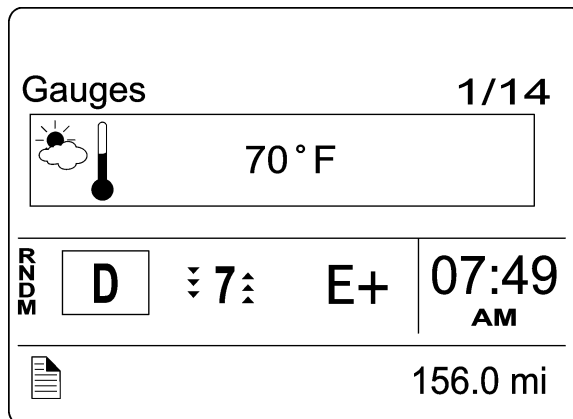

06746

The outside air temperature, fuel flow and the odometer (Allison transmission) or the current gear position (transmission I-Shift) are part of the default display. You can replace the default display by your selection of favorite gauges using the Driver Information Display sub-menu Favorite Display Setting. Refer to *Other Features* chapter for more information.

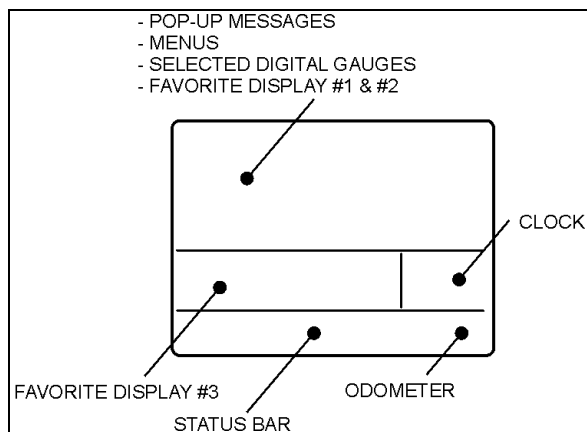

06742

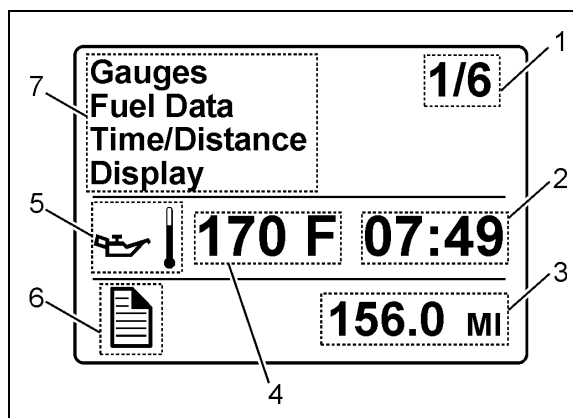

06743

1. Indicates first of six available menus (varies by menu)
2. Clock
3. Odometer
4. Value or data (in this example, the engine oil temperature)
5. Pictogram relevant to the displayed value or data
6. Status bar active pictogram
7. Messages or available menus

7. Press the ESCAPE button to return to the previous field or to cancel a setting or operation.

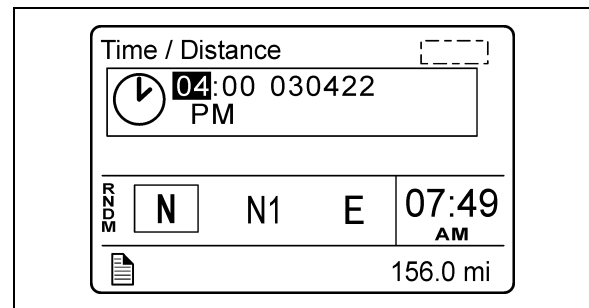

06743

Selecting a menu

Menus are placed in a cascade arrangement. Use the steering wheel controls buttons to scroll through them.

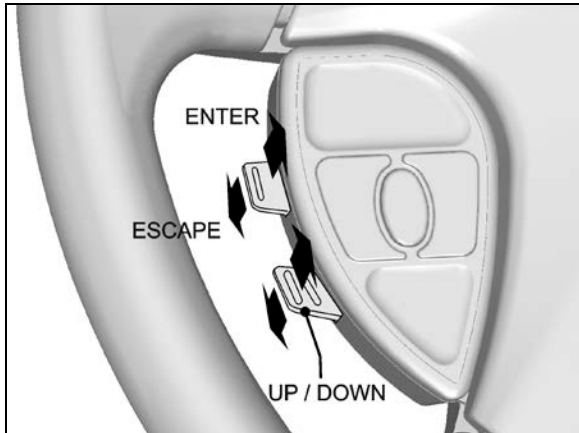

14069_3

To select a menu:

1. Press the ENTER or ESCAPE button to display the list of available menus.
2. Use the UP/DOWN button to scroll up or down through the menus.
3. Use the ENTER button to open a menu.
4. Use the ESCAPE button to return to the previous menu or display or to cancel a setting or operation.

To change settings

To change a setting, like the clock for example:

5. Use the UP/DOWN button to increase or decrease the numerical value of the selected field.
6. Use the ENTER button to confirm your choice and to move to the next field.

Scrolling through the menus without using the steering wheel buttons

In case of failure of the steering wheel buttons, it is still possible to gain access to the menus or acknowledge the pop-up messages to return to the default display.

This alternate mode is possible only if the steering wheel buttons are faulty.

To enable the alternate mode:

1. Apply the parking brake;
2. Depress and hold the service brake pedal.

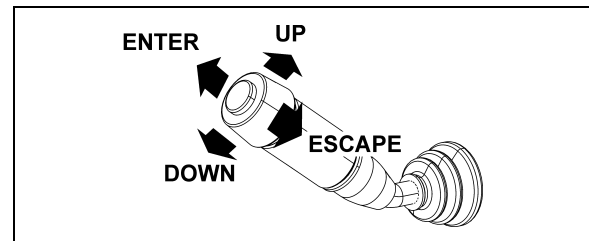

MULTI-FUNCTION LEVER

In alternate mode, use the multi-function lever as follows:







- Move the lever up = UP
- Move the lever down = DOWN
- Push the lever away from you = ENTER
- Pull the lever towards you = ESCAPE

PICTOGRAMS DISPLAYED ON THE DRIVER INFORMATION DISPLAY (DID)

NOTE

In certain situations, the pictogram displayed represents a system or a function of the vehicle. A particular pictogram may be displayed with different messages. In that situation, it is very important to pay attention to the message displayed with the pictogram.

Warning pictograms, pop-up message pictograms, verifications and information pictograms

DRIVER INFORMATION DISPLAY “GAUGES” MENU PICTOGRAMS	
PICTOGRAM	Description
	Engine oil temperature
	Outside air temperature
	A/c compressor pressure This pictogram is displayed with A/C compressor suction pressure value (low side) and discharge pressure value (high side).
	Accessories air pressure Normal pressure should be between 122 and 140 psi
	Voltmeter This pictogram is displayed with both the 12-volt and 24-volt electrical system current voltage value. When the engine is running, the 24-volt electrical system voltage value should be between 26,5 et 28,0 volts.
	Battery State Of Charge Displays the level of charge for the 12v and 24v battery banks
	Transmission oil temperature



Current gear position (i-shift transmission)

Indicate the current transmission gear position on the Volvo i-shift transmission.

R= reverse

N = neutral

D= drive

M= manual mode

POP-UP MESSAGES

PICTOGRAM Description



High engine oil temperature



Engine coolant temperature



Engine oil pressure



Intake air preheater failure



Engine temperature too low for Volvo engine brake (VEB) operation



High transmission oil temperature

This pictogram indicates that the transmission oil temperature is too high. Turn the transmission retarder off to allow the oil to cool down.



Allison transmission– oil or filter replacement required

This pictogram may be displayed with many different messages. Pay attention to the displayed message which can advise that the transmission oil or filter change is necessary. Refer to appendix C for more information on the Allison transmission prognostic features (oil life monitor, filter life monitor, transmission health monitor).



Trailer braking system low air pressure / trailer parking brake

This pictogram appears when the trailer emergency/parking brake is unexpectedly applied as when the vehicle is moving and a parking brake air line rupture happens.



Low brake or ABS air pressure



TCS traction control system and electronic stability control

At vehicle ignition, the TCS icon appears for approximately 2 seconds and then disappears.

06740_AA

If it remains on steadily (not flashing) after ignition, or if it is on steadily while you are driving, the TCS system may not be fully functional or the operation may be completely disabled. If this happens, your vehicle will still have normal service braking and it still can be driven, although without the benefits of the TCS system.

Flashes slowly when TCS Mud/Snow mode is turned on using the Mud/Snow switch.

Flashes quickly when TCS intervenes to reduce risk of loss of control.



A/C system pressure high

This pictogram indicates that the a/c system pressure is too high. If the a/c pressure is too high, the compressor clutch is disengaged, but the fan remains activated.

NOTE

When outside temperature is high, it is possible and normal for that pictogram to appear.



A/C system pressure low

This pictogram indicates that the A/C system pressure is too low. If the A/C pressure is too low, the compressor clutch disengages and the fan stops.

NOTE

When outside temperature is low, it is possible and normal for that pictogram to appear.



Compressor/air dryer fault

This pictogram indicates that a risk of water in the pneumatic system has been detected due to a compressor or air dryer related problem. Possible causes are:

- *Compressor is used at an unusual (high) rate.*

A fault with the air system has been detected.

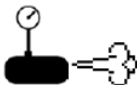

Air leakage

This pictogram indicates that an air leak has been detected in the pneumatic system.



Battery voltage warning

This pictogram indicates that the battery voltage is too high, too low or the 12V/24V battery arrangement is not equalized.

The value low or high is displayed at the right of the pictogram to indicate if the voltage is too low or too high.

NOTE

This pictogram will illuminate for a few seconds after the engine is started because of the voltage drop when the starter is engaged.

NOTE

This pictogram may appear as a reminder to connect the battery charger if the ignition switch is left in the "ON" position *for twenty minutes* with engine not running and parking brake set.

NOTE

To identify the battery problem (too high, too low or not equalized voltage), using the DID menus, perform a system diagnostic by selecting DIAGNOSTIC, VIEW ACTIVE FAULTS, ELECTRICAL SYSTEM and see the fault messages.

NOTE

To prevent discharge of the batteries when the engine is not running, some functions are automatically switched off if the batteries voltage drops below 24.0 volts for more than 30 seconds. Set the ignition key to the OFF position and then turn the ignition key to the ON position to reactivate the functions for a period of 30 seconds before they switch off again.

NOTE

If the battery equalizer indicator illuminates, make sure that the battery equalizer circuit breakers are reset before requesting breakdown assistance. Wait 15 minutes after setting breakers to allow batteries to equalize. The breakers are located on the rear junction panel, on the engine compartment R.H. side.



Engine door ajar

This pictogram indicates that the engine compartment door is ajar.



Emergency window open

This pictogram indicates that an emergency window is open or unlocked.



Baggage compartment door ajar

This pictogram indicates that one or more baggage bay doors are ajar.



Low windshield washer or headlights washer fluid level

Illuminates when the windshield washer or the headlight washer fluid level is low. The washer fluid containers are located inside the front service compartment.



WARNING

Do not drive without sufficient washer fluid.



Wheelchair lift

This pictogram indicates that the wheelchair lift system is enabled and the wheelchair access door or the lift compartment door is open. It is necessary to stow the wheelchair lift, close the doors and set the wheelchair lift system enable switch to the off position to permit release of the parking brake.



Lavatory occupied

This pictogram indicates that the lavatory compartment is occupied. This pictogram will appear only when the engine is shut down in order to advise the driver of the presence of a passenger in the lavatory compartment during a stop.



Lavatory compartment emergency call

If the vehicle is moving, this pictogram indicates that a passenger has activated the lavatory compartment emergency call button.



Differential lock (option)

This pictogram indicates that the differential action is locked.



Freezing conditions

This pictogram appears when the temperature is in the range between 0°C and 2°C (32°F and 35°F), when the road is most slippery.



Fuel level

This pictogram appears when approximately 24 US gallons (92 liters) of fuel remains in the tank. Refuel as soon as possible.



Automatic traction control

This pictogram appears when the automatic traction control system intervenes to prevent excess wheel spin during acceleration.



Parking brake applied



DPF regeneration



High exhaust gas temperature

This pictogram appears to notify the driver of potentially hazardous exhaust gas temperature at the dpf outlet.

	<p>WARNING</p>
<p>During regeneration, exhaust temperature may reach up to 1200°F (650°C) at the particulate filter. When parking the vehicle, if this pictogram is displayed, make sure that the DPF outlet diffuser is away from people or any flammable materials, vapors or structures.</p>	



Fuel economy

This pictogram is displayed with fuel consumption value of the vehicle. Proper units for the displayed value are written under the pictogram: liters/100km, km/liter, mpg, liters/hour.



Part of trip made using “free” electricity

Percentage besides this pictogram represents percentage of trip made with electricity generated when braking or decelerating.



Leg fuel consumption

This pictogram is displayed with the value for the fuel consumption for the current leg.



Trip data

Function of the DID’s “Time/Distance” menu. Refer to “Driver Information Display Menus” in *Other Features* chapter.



Estimated time of arrival

Function of the DID’s “Time/Distance” menu. Refer to “Driver Information Display Menus” in *Other Features* chapter.



Fuel filter/water separator

Indicates that the draining the fuel Filter/Water separator is required. See *Care And Maintenance* chapter.



Raised tag axle

This pictogram appears if the vehicle speed exceeds 12 mph (20 km/h) while the tag axle is raised.



Low buoy

This pictogram appears if the vehicle speed exceeds 12 mph (20 km/h) while the front suspension of the vehicle or the entire vehicle suspension is lowered.



Cooling fans low voltage

This pictogram indicates that battery voltage is too low for proper fan operation.



FIRE IN ENGINE COMPARTMENT

This pictogram appears if a fire is detected in the engine compartment while the vehicle is on the road. An audible alarm informs the driver when a fire is detected. In case of fire detection when parked (parking brake applied, engine running or not), the electric horn is activated to alert the driver. Refer to *Safety Features And Equipment* Chapter.



WARNING

In case of a fire, stop the vehicle immediately, stop the engine and evacuate the vehicle.

NOTE

It is possible to cancel an alarm while on the road. To do so, stop the vehicle. , perform this ignition switch (key) sequence.

- From the **ON** position,
- Turn to **OFF**, return to **ON** and **START** vehicle within 2 seconds.

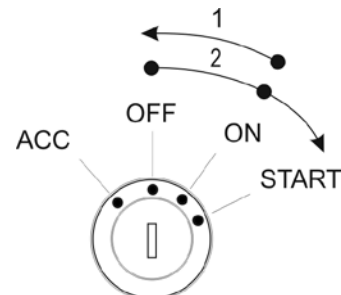

NOTE

To stop the electric horn alarm when parked, cycle the ignition between the on and off position twice within 3 seconds.

Status Line Pictograms

PICTOGRAM	DESCRIPTION
	MESSAGE ACTIVE
	ALARM CLOCK ACTIVATED
	RAISED TAG AXLE
	KNEELING/FRONT SUSPENSION HI-BUOY ACTIVE This pictogram appears if the vehicle speed exceeds 12 mph (20 km/h) while the front suspension of the vehicle (kneeling – solid ON pictogram) or the entire vehicle suspension is lowered (low buoy – blinking pictogram).
	BAGGAGE COMPARTMENTS LOCKED Confirm that all the baggage compartment doors are locked.
	BAGGAGE COMPARTMENTS UNLOCKED Indicates that at least one baggage compartment door is unlocked.
	ADAPTIVE CRUISE BRAKING (ACB) NOT AVAILABLE Indicates that the adaptive cruise braking system is disabled.
	ENGINE BRAKE Engine brake is disabled (OFF mode).
	ENGINE BRAKE Indicates that the engine brake is in the AUTO mode. When using this mode, the engine brake is activated when pressing on the brake pedal. The engine brake is by default set to AUTO mode when the vehicle ignition switch is cycled from OFF to ON position.
	ENGINE BRAKE – ENGINE BRAKE LOW (1) AND ENGINE BRAKE HIGH (2) Confirm which engine braking power is selected with the steering wheel control buttons.
	ALLISON TRANSMISSION RETARDER Confirm that the Allison transmission retarder is off.

Status Line Pictograms Contd.

	<p>ALLISON TRANSMISSION RETARDER – BRAKING LEVEL 0, 1, 2, 3, 4, 5, 6</p> <p>Confirm the retarder hand lever position. Each position corresponds to a given braking level. Refer to “transmission retarder” heading in this chapter.</p>
---	--

VEHICLE CLEARANCE INFORMATION

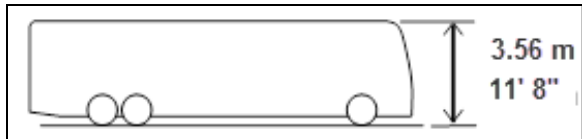

Safe vehicle clearance height is 11'8" (3.56 m).

 <p>CAUTION</p>	<p>Vehicle clearance is higher when the ventilation hatch is open, hi-buoy is selected or if additional equipment is installed on the roof.</p>
---	---

STEERING COLUMN CONTROLS

Many of the most frequently used controls are conveniently placed on the steering column or the steering wheel, just like a passenger car. The multi-function lever is located on the left side of the steering wheel while the optional transmission retarder lever is located on the right side of the steering wheel. Switches for the electric horn and the air horn are located directly on the steering wheel.

MULTI-FUNCTION LEVER

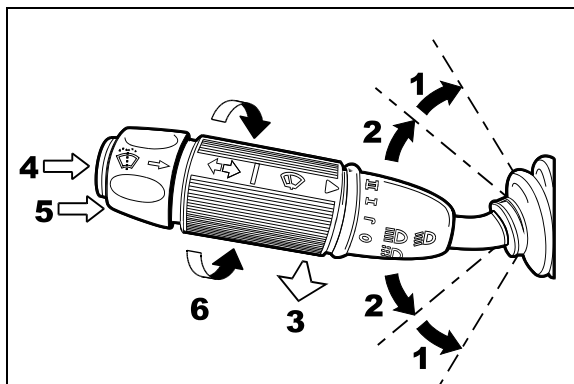

MULTI-FUNCTION LEVER 23133

The multi-function lever is used to operate the following:

Turn Signal (1)

Move the lever all the way up until it locks in position to signal a right turn. Move the lever all the way down until it locks in position to signal a left turn. The lever automatically returns to the horizontal OFF position once the turn is completed.

Lane Change Signal (2)

Move the lever part way to the catch position and hold until the lane change maneuver is completed. The lever will spring back into the OFF position once released.

Headlight Beam Toggle Switch (3)

Toggle between high and low beams by pulling the lever up towards you. To flash the headlights, pull the lever up halfway. The lever will spring back into normal position once released.

Courtesy Blinkers (4)

Clearance and parking lights can be flashed by pressing the button located on the lever tip.

Windshield Washer Control (5)

Push the external ring at the end of the lever toward the steering column to activate the windshield washers. The wipers come ON and continue wiping for a few seconds after the ring is released.

 <p>WARNING</p>	<p>Before using the windshield washers in cold weather, heat the windshield with the defroster to prevent icing and reduced visibility.</p>
---	---

 <p>CAUTION</p>	<p>To avoid damaging the pump mechanism, do not use the windshield washer when the fluid level is very low or empty.</p>
---	--

Windshield Wipers (6)

Turn the lever counterclockwise to activate the windshield wipers. The first position activates the wipers intermittently. The second position is the slow speed and the third position is for high speed wiping.



CAUTION

To avoid scratching the windshield, do not operate the wipers when the windshield is dry. To avoid damaging the wiper motor, free wiper blades that may be frozen to the windshield before operating the wipers.

STEERING WHEEL CONTROLS

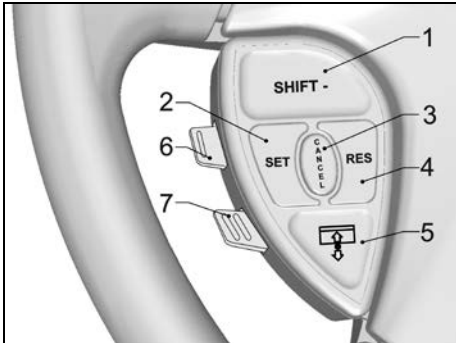

LEFT STEERING WHEEL CONTROLS

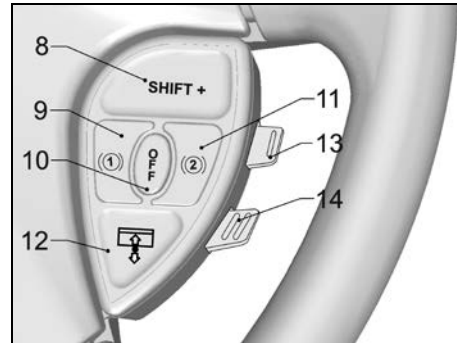

RIGHT STEERING WHEEL CONTROLS

THE STEERING WHEEL CONTROLS INCLUDE THE FOLLOWING FUNCTIONS:

1, 8 SHIFT DOWN, SHIFT UP (I-SHIFT TRANSMISSION)

Use these buttons to shift down or shift up manually the transmission range as would do the “-” & “+” keys on the i-shift gear selector keypad.

2 SET (CRUISE CONTROL)

For the cruise control operating instructions, refer to “cruise control” paragraph in this chapter.

3 CANCEL (CRUISE CONTROL)

For the cruise control operating instructions, refer to “cruise control” paragraph in this chapter.

4 RESUME (CRUISE CONTROL)

For the cruise control operating instructions, refer to “cruise control” paragraph in this chapter.

5, 12 LEFT SUNSHADE, RIGHT SUNSHADE

Press and hold the button to lower the left or right sunshade. Press twice rapidly and hold the button to raise the left or right sunshade.



CAUTION

Do not attempt to raise or lower these shades manually. Damage to electric motor or roller mechanism could result.

6 ESCAPE/ENTER (DRIVER INFORMATION DISPLAY)

Enter: lift this button briefly.

Escape: press briefly on this button.

7 UP/DOWN (DRIVER INFORMATION DISPLAY)

Use this button to scroll up or down through the menus.

9 RETARDER / ENGINE BRAKE LOW (1)

If the vehicle is equipped with a transmission retarder, press this button to enable the transmission retarder. Afterwards, operate the transmission retarder with the hand lever mounted on the steering wheel or the brake pedal. For more information about the operation of this system, refer to “transmission retarder” heading in this chapter.

On vehicles equipped with an engine brake, the engine brake provides two levels of braking power. Press this button for low engine braking power (about 50 % of full braking power). Refer to Section 5 *Other Features* for more information about the engine brake operation and AUTO (A) mode.

10 RETARDER / ENGINE BRAKE OFF

Press this button to cancel operation of the transmission retarder.

On vehicles equipped with engine brake, this button is a momentary switch that will cancel the Engine Brake LOW (1) or Engine Brake HIGH (2) mode and switch the engine brake to AUTO (A) mode. On vehicles so equipped, an engine brake switch located in the dashboard can be used to cancel completely (OFF mode) the engine brake.

NOTE

Engine brake is safe to use in any road conditions including adverse conditions.
--

11 RETARDER / ENGINE BRAKE HIGH (2)

If your vehicle is equipped with a transmission retarder, this button has the same effect than the retarder/engine brake LOW (1) button.

On vehicles equipped with engine brake, pressing this button will permit full application of engine brake (100 % of braking power). Refer to Section 5 *Other Features* for more information concerning the engine brake operation and AUTO (A) mode.

13 VOLUME (DASHBOARD RADIO)

Use this button to increase or decrease the dashboard radio (driver's radio) volume.

14 SEEK (DASHBOARD RADIO)

Use this button to seek up or down for a radio station.

HORNS

The electric horn (city horn) and air horn (highway horn) are operated from the steering wheel center pad. Use the Horn Selector switch located on the lateral control panel to select the appropriate horn type.

NOTE
 When the vehicle is stationary, the electric horn will sound to inform the driver that a fire is detected in the engine compartment.

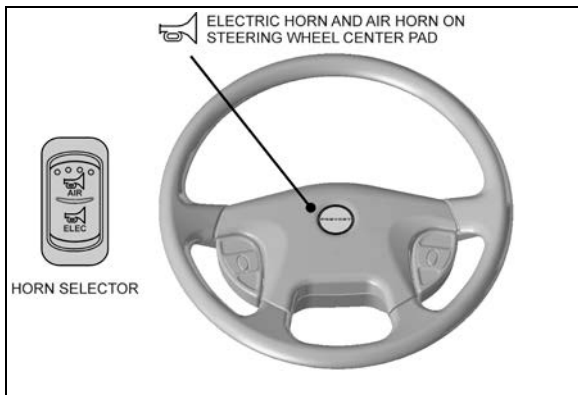

STEERING WHEEL

14068_1

TRANSMISSION RETARDER

The transmission retarder is available only with the Allison transmission.

The retarder can be operated using a hand lever mounted on the steering wheel column or using the service brake pedal.

To use the transmission retarder, it must be activated first by pressing one of the two Retarder/Engine Brake buttons on the steering wheel.

Operating the Retarder Using the Hand Lever

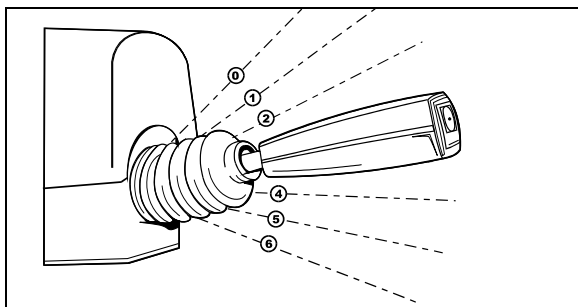

RETARDER HAND LEVER

07043

With the retarder enabled and the accelerator pedal released, move the output retarder lever clockwise from the first to the sixth position. The braking level for each position is as follows:

Position	Braking level (up to)
Initial ①	Varies with brake pedal
①	16%
②	33%
③	49%
④	71%
⑤	89%
⑥	100%

NOTE
 The output retarder lever is located on the right side of the steering column.

Operating the Retarder Using the Brake Pedal

With the retarder enabled, the accelerator pedal released and the output retarder lever in the initial position ①, depressing the brake pedal will engage both the service brake and the transmission retarder. This is referred to as retarder-brake blending. The further the pedal is depressed, the more total braking power is provided. Refer to "OTHER FEATURES" chapter for further information about the transmission retarder.

NOTE
 If the wheels start to lock up on slippery roads, the output retarder will automatically deactivate until the wheels start to turn.

FOOT-OPERATED CONTROLS

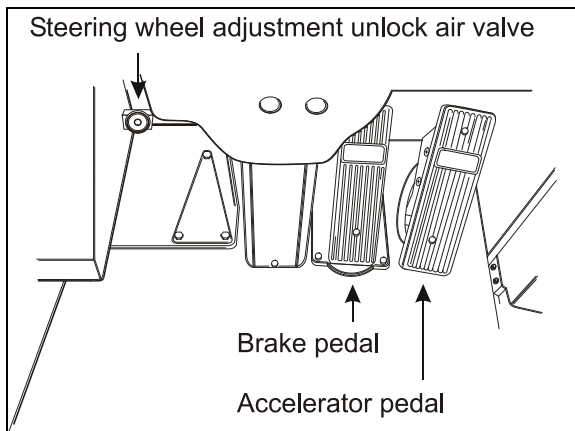

FOOT-OPERATED CONTROLS

00023A

BRAKE PEDAL

The coach is equipped with a dual braking system. The front brakes operate from a different air pressure source from the drive and tag axle brakes. The dual braking system becomes a modulated emergency system if a pressure drop occurs in the primary brake system.

Service brakes are applied by depressing the brake pedal. Braking increases with the amount of pressure applied to the foot pedal. Refer to Other Features chapter under Antilock Braking System. When the brake pedal is depressed, the brake lights turn *ON* automatically.

For safe and effective braking, the air system pressure should reach at least 122 psi in both the primary and secondary circuits. A warning light and an audible alert will sound when the air pressure in either the primary or the secondary circuits drops below 85 psi. If this occurs, stop the coach; determine the cause of the pressure loss before proceeding. The brake pedal can be used in conjunction with the transmission retarder. Refer to Transmission Output Retarder in this chapter.



DANGER

Immediately report any brake system problem to your company or directly to the nearest Prevest or Prevest-approved service center.

Do not "fan" or "pump" the brake pedal. This practice does not increase brake system effectiveness but rather reduces system air pressure thereby causing reduced braking effectiveness.



CAUTION

"Riding" the brake by resting one's foot on the brake pedal when not braking can cause abnormally high brake temperature, can damage and cause premature wear of brake components and reduce brake effectiveness.

ACCELERATOR PEDAL

Controls engine RPM as needed.

Allison Transmission

The transmission is fully automatic: Proper ranges should be automatically selected according to driving speeds to improve vehicle performance and control. The speed ratio of the power converter changes automatically as vehicle speed increases and direct-drive goes in and out as necessary. The speed ratio is modulated by vehicle speed and accelerator pedal position. You will find the complete transmission operation instructions and driving tips in the **Allison 5th Generation Bus Series Operator's Manual** included in your vehicle's publication box.

OPERATION

When a button is depressed on the transmission control pad, the corresponding letter or number is displayed indicating the transmission is ready to operate in the selected range. If the transmission control module (TCM) detects a serious problem in the transmission, the CHECK telltale lights on the dashboard.

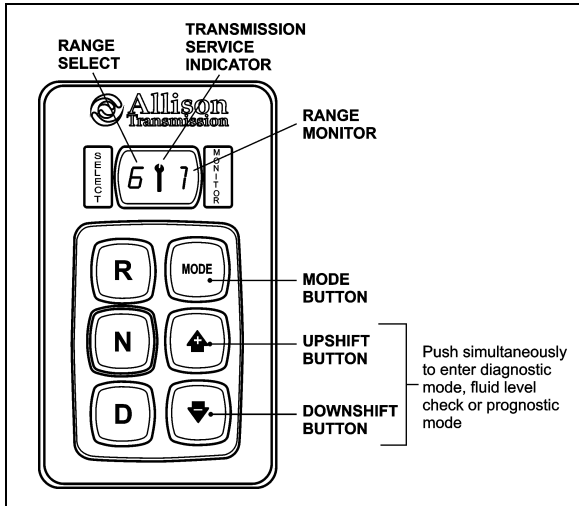

ALLISON PUSHBUTTON SHIFT SELECTOR 07142

PUSHBUTTON SHIFT SELECTOR

The pushbutton shift selector has the following elements:

R: Press to select Reverse gear.

N: Press to select Neutral.

D: Press to select Drive. The highest forward range available will appear in the digital display window under SELECT. The transmission will start out in the lowest available forward range, displayed under MONITOR, and advance automatically to the highest range.

▲ ▼ : Press respectively the ▲ (Upshift) or ▼ (Downshift) arrow button when in DRIVE to request the next higher or lower range. One press changes gears by one range. If the button is held down, the selection will scroll up or down until the button is released or until the highest or lowest possible range is selected. Protection mechanisms inhibit selecting ranges that are not appropriate for the current speed or which may damage driveline components.

MODE: Pressing the MODE button allows the driver to activate the secondary shift schedule that has been programmed into the TCM unit.

PRIMARY AND SECONDARY SHIFT SCHEDULES

The **primary shift schedule** is the default mode at starting of the engine and is typically specified to accommodate normal vehicle operation. The transmission controller automatically selects between ECONOMY and PERFORMANCE shift strategy, based on the vehicle actual load and the grade on which the vehicle is operating. This is called Load Based Shift Scheduling (LBSS). This can produce improved overall vehicle fuel economy while still enabling high productivity when the vehicle is loaded.

In the **secondary shift schedule**, only the ECONOMY shift strategy is available. No switching is done between shift strategies. The secondary shift mode is available only if selected by the driver, using the MODE button. When the secondary mode is activated, "MODE" illuminates on the display.

NOTE

*When the diagnostic display mode has been entered, the MODE button is used to view and toggle through diagnostic code information. Refer to appendix C for more details about **diagnostic code display procedure** and **fluid level check** using the pushbutton shift selector.*

TRANSMISSION SERVICE INDICATOR

ⓘ: This indicator will be illuminated upon the detection of a service issue relating to clutch, filter or fluid life. The appearance of the indicator (lit steadily, flashing, etc.) varies for each of the conditions monitored by the system. Refer to appendix C for more details about **diagnostic code display procedure, fluid level check or prognostic features** (Oil Life Monitor, Filter Life Monitor and Transmission Health Monitor) using the pushbutton shift selector.

Illuminated at startup for a bulb check, this indicator will then be turned off if no service conditions exist.

DESCRIPTION OF AVAILABLE RANGES

R (Reverse)

Press the «R» button to select reverse. Completely stop the vehicle and let the engine return to idle before shifting from forward range «D» to reverse «R» or from reverse to forward range. The reverse warning signal will be activated when this range is selected.

N (Neutral)

Use this position to start engine. Select «N» (Neutral) when checking vehicle accessories and for extended periods of engine idle operation; parking brake must then be applied. The pushbutton shift selector automatically select «N» (Neutral) when the ignition switch is turned ON.

NOTE
The automatic transmission does not have a park «P» position. Select «N» (Neutral) and apply parking brake when the vehicle is left unattended. An audible alert will sound if the engine is stopped and the parking brake is not applied.

 **WARNING**
 Before leaving driver's seat, always put the transmission in NEUTRAL and apply parking brake.

 **WARNING**
 The vehicle service brakes or park brake must be applied whenever NEUTRAL is selected to prevent unexpected vehicle movement.

 **CAUTION**
 Diesel engines should not be idled for extended periods at "slow" idle. For extended idling, engine should run at "fast" idle.

 **CAUTION**
 Do not allow your vehicle to "coast" in neutral «N». This practice can result in transmission damage. Also, no engine braking is available in neutral.

D (Drive)

Use this position for all normal driving conditions. After touching this pad, the vehicle will start in first or second range and will automatically upshift to a higher range as output speed increases. As the vehicle slows down, output speed decreases, the transmission automatically downshifts to the correct range. If a locked brake or a slick surface condition should occur, the TCM (Transmission Control Module) will command converter operation (disconnect lockup) and inhibit downshifts for a period of time or until normal wheel speed has been restored.

IMPORTANT NOTE
Brake pedal must be applied when selecting «D» (Drive) otherwise the transmission will stay in «N» (Neutral).

NOTE
The transmission should normally be allowed to shift by itself, but manual shifting can be done as described below.

1 (First range)

Select this range when pulling through mud and snow, when speed control is needed for driving up or down steep grades or when maneuvering in tight spaces. This range also provides maximum driving torque and engine braking power or retarder braking effect. In the lower ranges (1, 2, 3 and 4), the transmission will not upshift above the highest gear selected unless engine overspeed is detected.

2 (Second range)

Select this range when operating in heavy and congested traffic. The transmission will start in first and automatically upshift to second. When slowing, the transmission will automatically downshift to first range. Low ranges provide progressively greater engine and retarder braking power (the lower the range, the greater the engine and retarder braking effect).

3, 4 (Third and fourth ranges)

Select these ranges when driving on moderate grades or when load and traffic conditions limit speed.



WARNING

Service brake should not be used to control the speed of vehicle on long, steep descents. Instead, lower transmission ranges should be used (in conjunction with output retarder. Refer to "Engine Brake" and "Transmission Retarder" headings in Section 5 *Other Features* for details regarding both systems. This procedure keeps service brake cool and ready for emergency stopping.



CAUTION

When descending in lower ranges, care must be taken that engine speed does not exceed 2,450 rpm.

VOLVO I-SHIFT TRANSMISSION

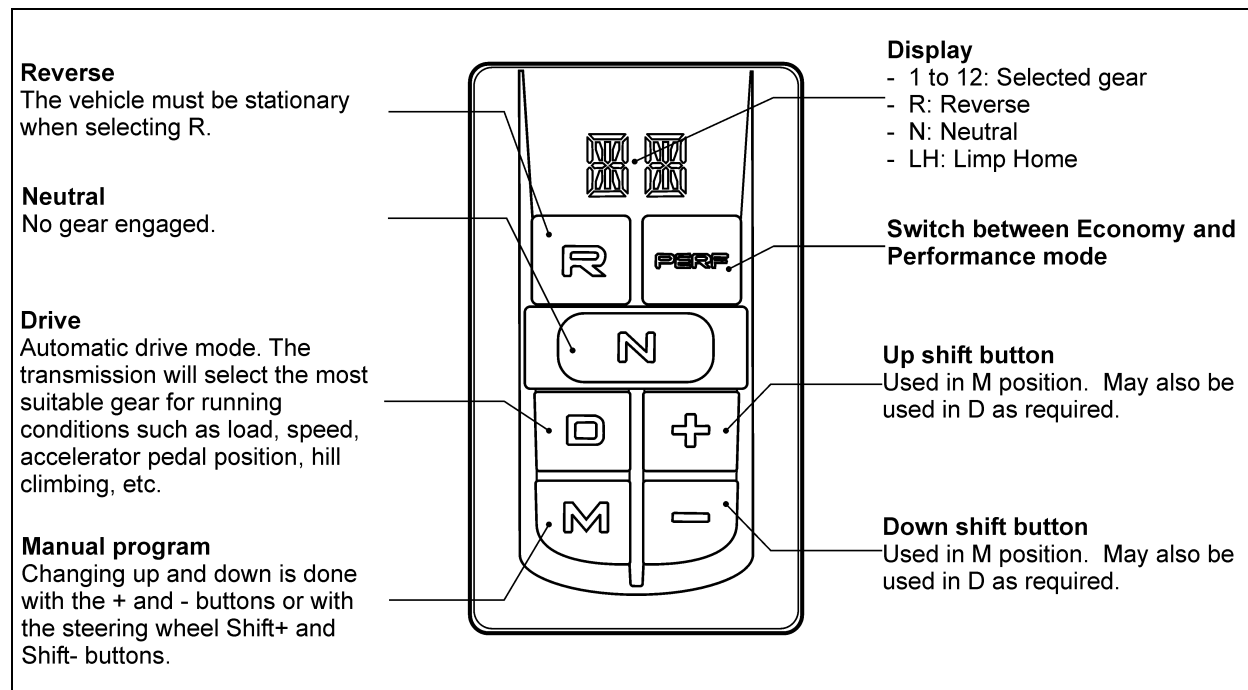

I-SHIFT PUSHBUTTON SELECTOR

07145

I-Shift transmission is an automated gearbox with 12 forward gears and 2 reverse gears. The clutch operation and gear shifting are fully automatically so that the driver can concentrate on the traffic.

DISPLAY

Status of the I-Shift transmission is shown on the Driver Information Display (DID). Displayed information is position, selected gear and driving mode.

PUSHBUTTON SHIFT SELECTOR

The pushbutton shift selector has four gear positions: R, N, D and M.

R= Reverse

N= Neutral

D= Drive

M= Manual program

It is not possible to shift neither directly from R position to D or M position nor from D or M position to R position. N position must be selected first. If the driver executes such gear shifts, the transmission will shift automatically to N position.

R ⇔ N ⇔ D or M

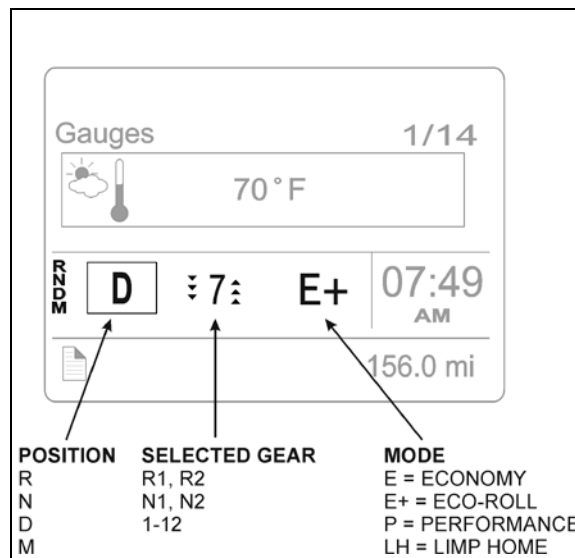

I-SHIFT PUSHBUTTON SELECTOR

07145

ACCELERATOR PEDAL

When changing gear, the accelerator pedal should not be released. The system will govern the clutch, gearbox and engine speed. The system selects the gear and the point in time for gear changing for optimum driving performance based on accelerator pedal position, road inclination, etc.

ECONOMY AND PERFORMANCE MODE

When the engine is started, the transmission is in Economy mode. The transmission automatically selects shift points and engine parameters to maximize fuel economy. Economy mode is primarily used when driving under normal conditions.

The Performance mode gives driveability the highest priority for optimum driving in traffic condition and gradeability.

NOTE
Operating the vehicle in Performance mode for extended periods can result in a loss of fuel economy.

ECO-ROLL MODE (FREEWHEEL FUNCTION)

Eco-Roll reduces fuel consumption by automatically disengaging the driveline when the engine is not needed to maintain vehicle speed. When Eco-Roll is active, the engine speed is temporarily reduced to idle. Eco-Roll can be used during normal driving with the accelerator pedal or while in cruise control mode.



Eco-Roll is only available when the engine brake is in Auto mode (A). First, set the dashboard Engine Brake switch to the ON position.

When Eco-Roll is enabled, the DID shows E+. When Eco-Roll intervenes, the selected gear displayed in the DID (7–12) will change momentarily to N1 or N2.

Eco-Roll disengages as soon as the brake pedal or the accelerator pedal is depressed, but it remains available. To disable Eco-Roll, set the dashboard Engine Brake switch to the OFF

position. Eco-Roll is not available when the Engine Brake Low (1) or Engine Brake High (2) modes are selected.

When Eco-Roll is enabled, it activates automatically, but only when the following conditions exist:

- Accelerator pedal is released.
- Service brake is released.
- Engine brake is in Auto mode (A).
- Transmission pushbutton shift selector is in the D position
- Transmission is operating in the Economy mode.
- Vehicle is operating on a downhill or uphill grade not greater than 2%.
- Selected gear is greater than 6.
- Brake cruise set speed is greater than 3 mph (5 km/h) above cruise set-speed.
- Vehicle speed is less than 78 mph (125 km/h).
- Electronic Stability Control (ESC) and antilock brake system (ABS) are not active.
- Exhaust Aftertreatment System regeneration is not active.

LIMP HOME MODE

Limp home is an emergency mode that can be engaged if a fault has occurred in the gearbox that prevents the vehicle from being driven in automatic, manual or reverse modes.

NOTE
Limp Home mode should only be used for moving short distances.

To activate the Limp Home mode:

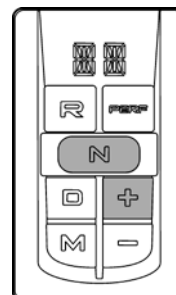

- Simultaneously press **N** and **+** buttons. Activating can only be done while the vehicle is stationary.
- Select **M** position or **R** position as required.

4-62 Controls and Instruments

The driver can select gears for forward driving or for reversing using the + and – button when position **M** (manual program) or **R** (reverse) is selected.

The following gears are available:

Forward driving - 1, 3 & 5

Reverse driving - R1

To select the reverse driving in Limp Home mode, simply select position R. Gear changing can only be done while the vehicle is stationary.

To Deactivate the Limp Home Mode

The Limp Home Mode will be deactivated when the ignition is turned off.

STARTING AND STOPPING

Starting

The pushbutton shift selector must be in the N position or the engine will not start. If the pushbutton shift selector is not in neutral, a starter protection message will appear in the DID along with the INFORMATION telltale and an audible warning.

If there is not enough air pressure in the I-Shift air tank, a low air supply message will appear in the DID along with the INFORMATION telltale light and an audible warning. Start the engine and allow the air pressure to build in the tank. Wait until the message and the telltale light turn off before attempting to shift the transmission into gear.

The brake pedal must be pressed down when passing from the N position to another position otherwise pressing the buttons will have no effects.

Stopping

When parking the vehicle, always apply the parking brake and place the pushbutton shift selector to the N position. Make sure the parking brake is holding the vehicle before leaving the driver position. Failure to do so can result in unexpected vehicle movement and can cause serious personal injury or death.

When the vehicle is stopped:

1. Apply the parking brake.

2. Select the N position on the pushbutton shift selector.
3. Turn off the engine.

STARTING THE VEHICLE UPHILL AND DOWNHILL

Hilly Operating Conditions

When starting the vehicle on an uphill slope:

1. Press the brake pedal.
2. Select the D position on pushbutton shift selector. The driver can use the – button to select a lower start gear if wanted.
3. Quickly move your foot from the brake pedal and completely depress the accelerator pedal.



CAUTION

Always use the brakes to hold the vehicle stationary on an uphill stop. Never hold the vehicle stationary on an uphill slope using the accelerator pedal. The clutch could overheat, which could cause it to breakdown.

The I-Shift transmission clutch is a dry disc type, with **no torque converter**. Never allow the clutch to slip in a too high gear when starting the vehicle. If the clutch overheats, a high clutch load message or clutch protection active message will appear in the DID along with the CHECK telltale light and an audible warning.



DANGER

The vehicle can roll when stopped on a hill or grade, or when the vehicle is starting from a stop on a hill or grade. Always use the brakes to hold the vehicle stationary on a hill or grade. Failure to do so can result in serious personal injury or death.

Hill Start Assist

Hill Start Assist provides anti-roll assistance during the transition from standing still to starting on a grade. The brake system maintains pressure in the brake chambers for 3 seconds after the service brake pedal is released, which

allows time to the driver to move is foot from the brake pedal to the accelerator pedal.

Hill Start Assist is only intended to temporarily hold the vehicle on a grade before the vehicle is put into motion. The vehicle brake must be applied, independent of HILL START ASSIST, to hold the vehicle on a grade for an extended period of time.

When available, Hill Start Assist is enabled at starting of the engine. The Hill Start Assist telltale light in the instrument cluster will blink to indicate that the feature is temporarily disabled. If a Hill Start Assist fault occurs, the Hill Start Assist telltale light in the instrument cluster will illuminate and the feature is permanently unavailable until the fault is repaired.

When Hill Start Assist is enabled, it activates automatically, but only when the following conditions exist:

- Vehicle speed is zero.
- Vehicle is on an incline or decline greater than 2%.
- Shift selector is in the D position on an incline or R position on a decline.
- Service brake is applied.
- ESC (Electronic Stability Control) is functioning normally.
- There has been no ESC activity in the preceding stops.

When the service brake pedal is released, the brakes are applied for approximately 3 seconds or until the accelerator pedal is depressed, whichever occurs first.

 WARNING
<p>Always apply parking brake before leaving driver's seat. The driver must not leave the vehicle when the engine is running and a gear is selected.</p>

DRIVING

The most efficient way to operate the vehicle is to use the automatic drive program, which is the D position on the pushbutton shift selector. Gear changing is automatic and the driver can concentrate on the road ahead.

<p><i>NOTE</i></p> <p>When driving in automatic drive mode (position D), the engine brake control should be in the Auto mode  to maximize the integration of the transmission and brake system according to Eco-Roll mode. This means optimum performance and fuel economy at all times.</p>
--

D Position

With the pushbutton shift selector in the D position, the transmission will automatically upshift and downshift as necessary to maintain the desired vehicle speed for the current driving conditions.

At starting of the vehicle, the gearbox selects between gear 1-6 the most suitable start gear with respect to weight and road's gradient. The driver can select a pulling away gear different than the one selected by using the + and - buttons.

When the vehicle is moving in automatic drive mode, the driver can intervene manually, while maintaining the accelerator pedal depressed, by selecting a higher or lower gear using the + and - buttons. The arrows in the display show how many gears are available to change up or down.

Whenever gear changing is not desired while in automatic drive mode, change the pushbutton shift selector from D to M. No further gear changes will be carried out and the current gear will remain engaged.

 CAUTION
<p>There is a risk of over-revving the engine when the transmission is locked in a gear. Damage to the engine may occur. To lock the transmission in the current gear, change the pushbutton shift selector from the D position to the M position. This function can be used for all 12 forward gears. To return to the automatic drive mode, set the pushbutton shift selector back to the D position.</p>

M Position

It is possible to drive the vehicle with full manual gear changing or take over from the automatic gear changing system whenever required. Gear changing is done by first selecting the manual position M.

4-64 Controls and Instruments

In manual shift mode, the driver use the + and – buttons to select gears.

The transmission will not automatically change gears as the driving conditions change. The current gear is displayed in the DID along with the up and down arrows. The number of available upshifts and downshifts will change as driving conditions change.

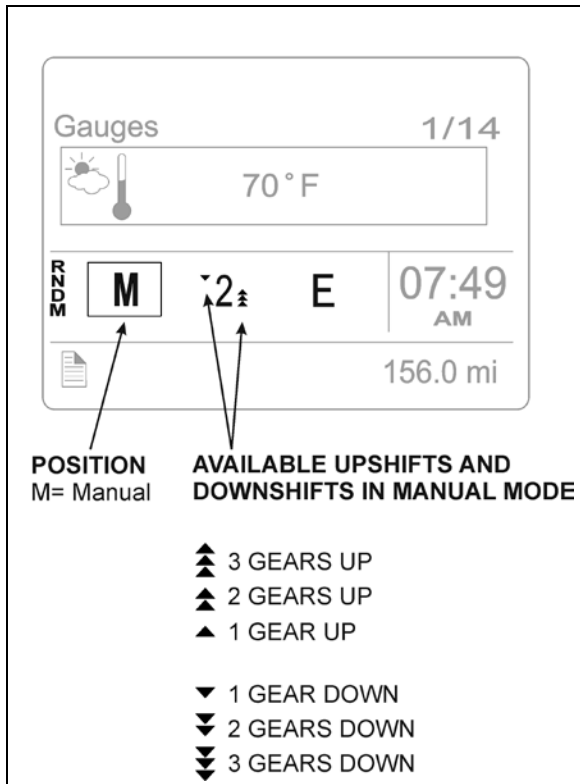

When changing a gear, the accelerator pedal should not be released.



CAUTION

Starting in a too high gear exposes the clutch to high levels of wear.



CAUTION

The driver must avoid over-revving the engine.

R Position

The system will select R2 automatically when the pushbutton shift selector is set to R, but if wanted, the driver can select R1 as reverse gear manually using the – button. During reverse, it is possible to shift between gear R1 and R2 using the + and – buttons.

TOWING RECOMMENDATIONS



CAUTION

When towing the vehicle, the transmission output shaft must not be allowed to spin or turn. If the vehicle is towed with the drive wheels still in contact with the road surface, the vehicle axle shafts or driveline must be removed or disconnected. Do not attempt to push or pull-start the vehicle.



CAUTION

Make sure axle shafts or driveshaft are installed correctly after towing. Tighten axle shaft and driveshaft nuts to the correct torque settings. Do not invert shafts.

EXHAUST AFTERTREATMENT SYSTEM.....	4
FILTRATION AND REGENERATION UNIT	4
Passive regeneration	4
Active regeneration	4
Stationary (parked) regeneration	4
Initiating a Stationary (Parked) Regeneration	7
Voluntary Interruption of a Stationary Regeneration	7
SELECTIVE CATALYTIC REDUCTION UNIT	8
DIESEL EXHAUST FLUID (DEF)	8
Diesel Exhaust Fluid (DEF) Consumption	8
SELECTIVE CATALYTIC REDUCTION – DRIVER WARNING AND INDUCEMENT	9
DEF TANK LEVEL DRIVER WARNING AND INDUCEMENT.....	10
DEF QUALITY DRIVER WARNING AND INDUCEMENT.....	11
SCR SYSTEM TAMPERING DRIVER WARNING AND INDUCEMENT	12
DRIVER INFORMATION DISPLAY (DID) MENUS	13
DRIVING MODE MENUS	14
GAUGES	14
FUEL DATA	15
TIME/DISTANCE	16
PREVOST LIAISON (OPTION)	17
VEHICLE MESSAGES	17
NON-DRIVING/STATIONARY MODE MENUS	18
DISPLAY SETTINGS	18
DIAGNOSTICS.....	19
PRE-TRIP ASSISTANT (OPTION).....	20
DATA LOG	22
AFTERTREATMENT.....	23
PASSWORD	24
INTELLIGENT SLEEP MODE (ISM).....	25
TRANSMISSION RETARDER.....	25
ENGINE BRAKE	25
VOLVO ENGINE BRAKE (VEB).....	26
CRUISE CONTROL AND ENGINE BRAKE	26
ANTILOCK BRAKING SYSTEM (ABS), TRACTION CONTROL SYSTEM (TCS), ELECTRONIC STABILITY CONTROL (ESC)	27
ANTILOCK BRAKING SYSTEM (ABS).....	27
TRACTION CONTROL SYSTEM (TCS).....	27
ELECTRONIC STABILITY CONTROL (ESC)	27

5-2 Other Features

DRIVER CONTROLLED DIFFERENTIAL LOCK (DCDL)	28
OPERATION TIPS	28
LOCKING THE DCDL.....	28
UNLOCKING THE DCDL	29
KNEELING SYSTEM	29
HI-BUOY	29
LOW-BUOY	29
RETRACTABLE TAG AXLE	30
TAG AXLE UNLOADING	30
ENGINE COOLANT HEATER	30
SWITCHING THE HEATER ON	30
SWITCHING THE HEATER OFF	31
COOLANT HEATER TIMER	31
Timer A: Operating instructions	31
Viewing the Time (Ignition ON)	32
PREHEATER TROUBLESHOOTING AND MAINTENANCE.....	35
WHEELCHAIR LIFT SYSTEM	36
INTRODUCTION	36
OVERVIEW	36
Major lift components.....	36
OPERATING INSTRUCTIONS	38
Safety Precaution.....	38
Hand-Held Control Pendant and Motion.....	39
PLATFORM POSITION WITH INTERMEDIATE HEIGHT (OPTIONAL FEATURE)	39
MANUAL LIFT OPERATION.....	42
To Manually Deploy the Platform.....	43
To Manually Raise the Platform	44
To Manually Lower the Platform	45
To manually stow the platform	46
SEATS RECONFIGURATION	48
WHEELCHAIR RESTRAINT SYSTEMS	48
4-POINT SECUREMENT WITH FLOOR ANCHORAGE.....	48
Wheelchair Occupant Restraint.....	49
4-POINT SECUREMENT WITH ANCHORAGE TO PASSENGERS SEAT PEDESTALS	49
Wheelchair Occupant Restraint.....	50
WHEELCHAIR LIFT SYSTEM - THRESHOLD WARNING SYSTEM (TWS) ADJUSTMENT	50
ADJUST AIMING OF ACOUSTIC SENSOR BEAM.....	50
TEST AIM OF ACOUSTIC SENSOR BEAM	51
ADJUST ACOUSTIC SENSOR TIMING	51
WHEELCHAIR LIFT REMOVAL FOR STORING OR MAINTENANCE PURPOSES	51

WHEELCHAIR LIFT INSTALLATION..... 52

EXHAUST AFTERTREATMENT SYSTEM

The exhaust aftertreatment system consists of two units, the filtration and regeneration unit and the selective catalytic reduction SCR unit.

FILTRATION AND REGENERATION UNIT

The aftertreatment system primary function is to capture and oxidize (regenerate) the particulate matter (soot) in the engine exhaust gases and to reduce NO_x. To achieve this goal, the exhaust aftertreatment system is split into two main sections: the exhaust gases first enter the **Diesel Oxidation Catalyst (DOC)** and **Diesel Particulate Filter (DPF)** assembly to capture and regenerate the soot on a regular or passive basis, then the exhaust gases flow through the **catalytic converter** to reduce NO_x to minimum level. Through constant monitoring of the exhaust gas temperature and the system back pressure, EMS is able to manage regeneration.

Passive regeneration

Passive regeneration is the process by which the particulate matter is oxidized due to the heat generated by the engine internal combustion process. During normal highway operation, exhaust temperatures alone are usually high enough to oxidize accumulating soot. In low ambient temperatures, however, or in some stop-and-go applications, the system needs a little help to regenerate, or clean itself. This process is called "active" regeneration.

Active regeneration

Active regeneration is necessary when the engine internal combustion process alone does not generate enough heat. A dosing system injects a mist of diesel fuel into the exhaust system to increase and maintain the aftertreatment system temperature. Exhaust temperature must be above 572°F (300°C) to initiate the oxidation catalyst, which in turn oxidizes the injected diesel fuel molecules to achieve up to 1200°F (650°C) exhaust temperature at the particulate filter. This process of active regeneration takes place







during the normal operation cycle of the vehicle without charges in performance or control for the operator. EPA2010 compliant Volvo engines produce less soot, so less active or stationary regeneration will be required.

Stationary (parked) regeneration

In a small number of specific engine duty cycles, engine control module may not be capable of completing an active regeneration. In these situations, the operator will be notified that a stationary or parked regeneration may be required. A DPF telltale light will illuminate indicating the need for user interaction. The lamp gives the operator a grace period to allow this process to take place at a time when most convenient for the operator. This process requires the vehicle to be parked while a driver or maintenance technician initiates the regeneration process using the DID menus. Once initiated, the stationary regeneration process will be complete in about 45 minutes.

The driver will be notified of the need for a stationary regeneration (parked) by illumination of the DPF REGENERATION telltale light.

Diesel particulate filter clogging sequence – Instrument cluster telltale light

<p>LEVEL 1</p>	 solid	<p>REGENERATION NEEDED</p> <p><i>Diesel particulate filter is becoming full</i></p> <p><i>The DPF REGENERATION telltale light illuminates to notify the driver that a stationary regeneration (parked) will be required soon. When this lamp is lit, initiate stationary regeneration process at an appropriate time of day. THERE IS NO URGENCY AT THIS LEVEL.</i></p>
<p>LEVEL 2</p>	 flashing	<p>REGENERATION REQUIRED</p> <p><i>Diesel particulate filter full</i></p> <p><i>If no DPF regeneration occurs after the initial DPF REGENERATION telltale light illumination, the lamp will begin blinking and a stationary regeneration should be initiated as soon as possible in order to prevent from entering into Level 3.</i></p>
<p>LEVEL 3</p>	 flashing + 	<p>ATD SERVICE REQUIRED</p> <p>ENGINE DERATE ACTIVE</p> <p><i>Diesel particulate filter overfull</i></p> <p><i>If the flashing DPF REGENERATION telltale light is still ignored, the CHECK telltale light will illuminate. In that situation, engine performance is limited. Perform a parked regeneration IMMEDIATELY to avoid further derate and prevent from entering into Level 4.</i></p>
<p>LEVEL 4</p>	 flashing +  + 	<p>ATD SERVICE REQUIRED</p> <p>ENGINE SHUTDOWN ACTIVE</p> <p><i>A serious engine problem has occurred. The DPF may be over its maximum capacity.</i></p> <p><i>If a stationary regeneration is still not initiated, a standard Engine Protection Shutdown sequence will occur. All of the following dashboard lamps will be present:</i></p> <ul style="list-style-type: none"> • <i>Blinking DPF REGENERATION telltale light;</i> • <i>Solid CHECK telltale light;</i> • <i>Solid STOP telltale light.</i> <p><i>Once engine derate and/or shutdown sequence is completed, a stationary regeneration must occur to continue vehicle operation. If the driver continues to operate the vehicle without regeneration, additional measures will be taken to protect the engine and ATD from damage, up to and including engine shutdown. Parked regeneration might no longer be possible</i></p> <p>-----</p> <p><i>If engine protection has been initiated and forces the engine to shutdown, you <u>can</u> immediately <u>re-start</u> the engine and perform the necessary steps in order to initiate a stationary regeneration.</i></p> <p style="text-align: center;"><u>Find and solve the cause of the shutdown</u></p>

Initiating a Stationary (Parked) Regeneration

NOTE
 At starting of the engine, if a stationary regeneration is required, the engine coolant temperature must reach 140°F (60°C) before any stationary regeneration may be initiated and completed. Permit the engine to idle for a short while or drive the vehicle until engine temperature increases sufficiently.

 **WARNING**
 Do not initiate a stationary regeneration in a closed area like a garage. Stationary regenerations must be undertaken outdoors only.

 **WARNING**
 During stationary regeneration, exhaust temperature may reach up to 1200°F (650°C) at the particulate filter. Before initiating stationary regeneration, make sure that the DPF outlet diffuser is clear of objects and that no one is working near the DPF outlet diffuser.

 **WARNING**
 Hot surfaces. Keep yourself clear of all hot Aftertreatment Device components, particularly during and after active or stationary regeneration. Hot surfaces can cause serious burns.

NOTE
STATIONARY REGENERATION
 This process requires the vehicle to be parked while the driver or a maintenance technician initiates the regeneration process.

The DPF REGENERATION telltale light illuminates to notify the driver of the need and urgency of a manual stationary regeneration.



DPF REGENERATION telltale light

If stationary regeneration is not performed, this telltale light will blink, indicating that a stationary regeneration is required immediately. If stationary regeneration is still not performed,

“engine power derate and shutdown” sequence may occur as per level 1 to level 4 sequence.

To initiate a stationary regeneration:

- Park the vehicle in a clear area, vehicle speed must be 0 mph (0 km/h);
- Engine must be on normal idle and fully warmed up (coolant temperature above 140°F/60°C);
- Apply parking brakes and set the transmission to neutral (N).
- Press the DID ENTER button and then get to the DID Aftertreatment menu. Select sub-menu Request Parked REGEN and press ENTER button to confirm and initiate regeneration.

The regeneration will begin. Turn off the air conditioning to reduce engine load. The engine idling speed will increase to 1600 rpm. Once the regeneration is completed, the engine speed will return to normal idle.

Voluntary Interruption of a Stationary Regeneration

It is possible to interrupt a stationary regeneration at all time. To do so, get to the DID's Aftertreatment menu, select Cancel REGEN and press ENTER button to confirm. You can stop regeneration simply by releasing the parking brake. Use this procedure in order to move the vehicle in a safe area only.

If regeneration is interrupted, it is very important to reinitiate the regeneration as soon as possible.

 **CAUTION**
 If an active regeneration is stopped repeatedly, the vehicle may need to be taken to a service facility. The service facility will use a service tool to manually initiate the regeneration. Moreover, the interruption of active regeneration should not be considered as a normal practice. Some components of the aftertreatment system might be damaged in the long term.

SELECTIVE CATALYTIC REDUCTION UNIT

Selective Catalytic Reduction (SCR) is a technology that uses Diesel Exhaust Fluid (DEF) and a catalytic converter to reduce nitrogen oxides (NOx) emissions.

SCR is an exhaust aftertreatment system that injects small amount of DEF into the exhaust gas between the DPF and the selective reduction catalytic converter. DEF turns to ammonia and carbon dioxide when heated. The exhaust stream then passes over a catalyst, the ammonia reacts with the NOx to form nitrogen and water vapor.

The basic elements of the SCR system consist of a 15.9 gallons (60 liters) DEF tank complete with pump, lines and heating system, a dosing injector, a catalytic converter and the control and monitoring system.

DIESEL EXHAUST FLUID (DEF)

When handling DEF solution, keep electrical connectors properly connected or well encapsulated, otherwise there is a risk that the DEF will cause oxidation that cannot be removed. Water or compressed air will not help, since DEF quickly oxidizes certain metals. If a disconnected connector comes into contact with the DEF solution, it must be replaced immediately to prevent the DEF solution from creeping further into the copper wiring, which takes place at a speed of about 2.4 in (60 mm) per hour.

 CAUTION
<p>Diesel Exhaust Fluid (DEF) is a nontoxic aqueous solution of urea (32.5%) and ultra-pure water (67.5%). Urea is a compound of nitrogen that turns to ammonia when heated. The fluid is non-flammable, and is not dangerous when handled as recommended. However, it is highly corrosive to certain metals, especially copper and brass.</p> <p>When detaching hoses and components, do not spill DEF on disconnected or unsealed connectors. If DEF is spilled on a disconnected or unsealed connector, the connector must be removed immediately and replaced.</p>

Things to know about spilt diesel exhaust fluid (DEF):

- If urea solution comes into contact with the skin, rinse with plenty of water and remove contaminated clothing.
- If urea solution comes into contact with the eyes rinse for several minutes and call for medical help if necessary.
- If inhaled breathe fresh air and call for medical help if necessary.
- Do not allow the DEF solution to come into contact with other chemicals.
- The DEF solution is not flammable. If the DEF solution is exposed to high temperatures, it breaks down into ammonia and carbon dioxide.
- The DEF solution is highly corrosive to certain metals, including copper and aluminum.
- If the DEF solution is spilled onto the vehicle, wipe off the excess and rinse with water. Spilled DEF solution can form concentrated white crystals on the vehicle. Rinse off these crystals with water.

 WARNING
<p>DEF spilt onto hot components will quickly vaporize. Turn your face away!</p>

 CAUTION
<p>DEF freezing and expansion</p> <p>DEF will begin to crystallize and freeze at 12°F (-11°C). DEF expands by approximately 7% when frozen. During freezing weather, do not store a DEF container on the coach unless it is designed to allow for expansion.</p> <p>Make sure the DEF container is not completely full. DEF expansion may split an inappropriate container, causing a spill and corrosion as a result.</p>

Diesel Exhaust Fluid (DEF) Consumption











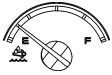



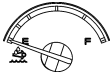

DEF consumption is related to fuel consumption. In order to meet EPA2010 requirements, DEF tanks are sized so one refill will be necessary every two refill of the fuel tank.

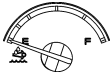



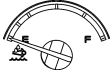



SELECTIVE CATALYTIC REDUCTION – DRIVER WARNING AND INDUCEMENT

SCR system components must not be removed, altered or modified in any way. In order to protect the SCR system from tampering, inducement measures will occur if the following states are detected:









- Disconnection of DEF tank level sensor
- Blocked DEF line or dosing valve
- Disconnection of DEF dosing valve
- Disconnection of DEF pump
- Disconnection of SCR wiring harness
- Disconnection of NOx sensor
- Disconnected exhaust temperature sensor
- Disconnected DEF temperature sensor
- Disconnected DEF quality sensor

5-10 Other Features

DEF TANK LEVEL DRIVER WARNING AND INDUCEMENT				
Conditions / Triggers		DEF Tank LOW LEVEL Indicator, DID Message and audible warning		Inducement
1	Normal DEF tank level sensor reads between 100% and 12%		None	None
2	Low DEF tank warning DEF tank level sensor reads between 12% and 0.1%	  solid	DEF TANK LEVEL LOW REFILL DEF SOON TO PREVENT ENGINE DERATE    3 cycles of 2 beeps	Warning message
3	DEF tank near empty DEF tank level sensor reads less than 0.1%	  blinking	DEF TANK EMPTY REFILL DEF AT NEXT STOP TO AVOID 5 MPH LIMIT ENGINE IN DERATE    3 cycles of 2 beeps	Engine torque reduction of 25%
4	DEF tank empty and one (1) hour of operation in engine derate mode	  blinking	DEF TANK EMPTY 5 MPH (8KM/H) LIMIT NEXT 20MIN VEHICLE STOP    3 cycles of 2 beeps	Engine torque reduction of 40%
5	DEF tank empty and either <ol style="list-style-type: none"> Diesel fuel refueling done with a fuel level sensor reading increase of 15%, or more Vehicle stationary (speed=0) for 20 minutes with engine off or at idle 	  blinking	REFILL DEF TANK VEHICLE SPEED LIMITED TO 5 MPH (8 KM/H)    continuous cycle of 2 beeps	Vehicle road speed limited (RSL) to 5 mph (8 km/h) <i>Note: The vehicle has to be stationary before 5 mph (8 km/h) road speed limit becomes active</i>

DEF QUALITY DRIVER WARNING AND INDUCEMENT				
Conditions / Triggers		Amber Warning Light & Did Message And Audible Warning		Inducement
1	Good DEF quality	None		None
2	Poor DEF quality detected	 solid	POOR DEF QUALITY DETECTED SERVICE DEF SYSTEM AT NEXT STOP ))) 3 cycles of 2 beeps	Warning message Engine will derate 25% in < 60 mins
3	Poor DEF quality detected and one (1) hour of operation with active diagnostic troubleshooting code	 solid	POOR DEF QUALITY DETECTED ENGINE IN DERATE 5 MPH (8KM/H) LIMIT IN < XXX MINS ))) 3 cycles of 2 beeps	Engine derated 25% Engine will derate 40% in <240 mins
4	Poor DEF quality detected and four (4) hours of operation with active diagnostic troubleshooting code	 solid	SERVICE DEF 5 MPH (8KM/H) LIMIT NEXT 20MIN VEHICLE STOP ))) 3 cycles of 2 beeps	Engine derated 40% 5 mph (8km/h) limit after next 20 min vehicle stop
5	Poor DEF quality detected Diesel fuel refueling done with a fuel level sensor increase of 15% or more or Vehicle stationary (speed=0) for 20 minutes with engine off or at idle or Key cycle trigger	 solid	SERVICE DEF VEHICLE SPEED LIMITED TO 5 MPH (8 KM/H) )))))))) continuous cycle of 2 beeps	Service DEF Vehicle road speed limited (RSL) to 5 mph (8 km/h) <i>Note: The vehicle has to be stationary before 5 mph (8 km/h) road speed limit becomes active</i>

5-12 Other Features

SCR SYSTEM TAMPERING DRIVER WARNING AND INDUCEMENT				
Conditions / Triggers		Amber Warning Light, Did Message And Audible Warning		Inducement
1	Normal No diagnostic troubleshooting code active	None		None
2	SCR system tampering diagnostic troubleshooting code confirmed	 solid	SCR SYSTEM FAULT SERVICE SYSTEM AT NEXT STOP  3 cycles of 2 beeps	Warning message
3	Reached one (1) hour of operation with active SCR system tampering diagnostic troubleshooting code confirmed	 solid	SCR SYSTEM FAULT ENGINE IN DERATE 5 MPH (8KM/H) LIMIT IN < XXX MINS  3 cycles of 2 beeps	Engine torque reduction of 25%
4	Reached four (4) hours of operation with active SCR system tampering diagnostic troubleshooting code confirmed	 solid	SCR SYSTEM FAULT REPAIR NEEDED 5 MPH (8KM/H) LIMIT NEXT 20MIN VEHICLE STOP  3 cycles of 2 beeps	Engine torque reduction of 40%
5	Diesel fuel refueling done with a fuel level sensor increase of 15% or more	 solid	SCR SYSTEM FAULT VEHICLE SPEED LIMITED TO 5 MPH (8 KM/H)  continuous cycle of 2 beeps	Vehicle road speed limited (RSL) to 5 mph (8 km/h)

DRIVER INFORMATION DISPLAY (DID) MENUS

There are Driving and Non-Driving menus. Several sub-menus are password-protected while the vehicle is parked. The Non-Driving menu is accessible only when the vehicle is parked.

DRIVING MODE MENUS	NON-DRIVING/STATIONARY MODE MENUS
Gauges <ol style="list-style-type: none"> 1. Current Gear Position (I-Shift) 2. Outside Temperature 3. Engine Oil Temperature 4. Transmission Fluid Temperature 5. Prevost Liaison Compass 6. Accessories Air Pressure 7. A/C Compressor Pressure 8. Battery Voltage 9. Allison Transmission Oil Life 10. Battery State Of Charge 11. Electric Cooling Fan Status 	Display Settings <ol style="list-style-type: none"> 1. Language 2. Units 3. Time/Date 4. Favorite Display Setting 5. Display Light 6. Change Password
Fuel Data <ol style="list-style-type: none"> 1. Fuel Flow / ECO % 2. Trip Fuel Used 3. Distance to Empty 	Diagnostics <ol style="list-style-type: none"> 1. View Active Faults 2. View Inactive Faults 3. Cluster Self Test 4. Part Number 5. Reset Inactive Faults 6. Vehicle Tests
Time-Distance <ol style="list-style-type: none"> 1. Time and Date 2. Alarm Clock 3. Trip Odometer 1 and 2 4. Average Trip Speed 5. Estimated Time of Arrival (ETA) 	Pre-Trip Assistance <ol style="list-style-type: none"> 1. Exterior Light Inspection 2. Air Leakage Monitor
Prevost Liaison <ol style="list-style-type: none"> 1. Read Message 2. Send Message 3. Other Info 	Datalog <ol style="list-style-type: none"> 1. Vehicle ID 2. Total Data 3. Trip Data 4. Reset Trip Data
Vehicle Messages	Aftertreatment <ol style="list-style-type: none"> 1. Request Parked REGEN 2. ATS Status 3. Cancel REGEN
Reset Trip Data	Password <ol style="list-style-type: none"> 1. Enter Password

DRIVING MODE MENUS

GAUGES

There are several gauges in this menu. The gauges are used to view current status of important functions in the vehicle.

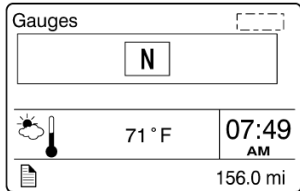

- 1. Current Gear Position (I-Shift transmission only)**
Indicates the current gear position selected on the I-Shift transmission.
D= drive
N= neutral
R= reverse
M= manual

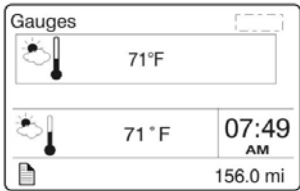

- 2. Outside Temperature**

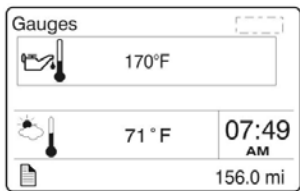

- 3. Engine Oil Temperature**
Selecting this gauge will display the engine oil temperature.

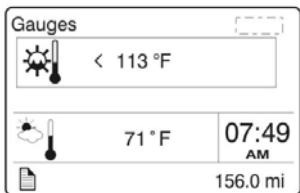

- 4. Transmission Fluid Temperature**

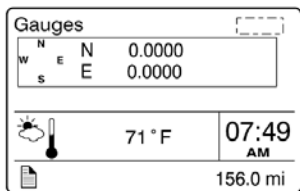

- 5. Prevost Liaison Compass**

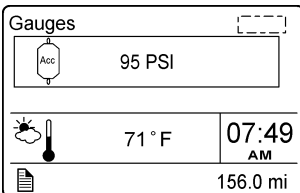

- 6. Accessories Air Pressure**

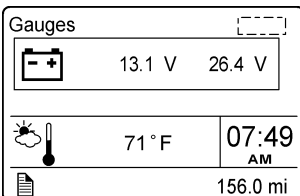

- 7. Battery Voltage**
Displays current 12-volts and 24-volts systems voltage.

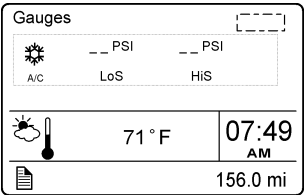

8. A/C Compressor Pressure

Displays the A/C compressor suction pressure value (LoS=low side) and discharge pressure value (HiS=high side).

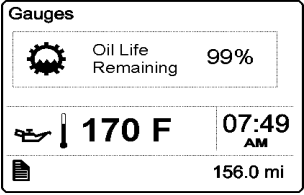

9. Allison Transmission Oil Life

Displays the percentage of the calculated remaining life of the transmission oil. New oil is displayed as 99%. Refer to Appendix C for more details.

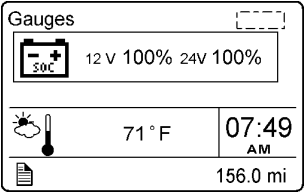

10. Battery State Of Charge

Displays the state of charge of the 12-volt and 24-volt systems, expressed in percentage.

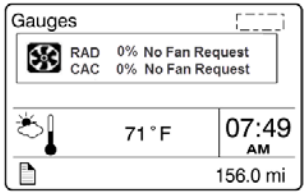

11. Electric Cooling Fan Status

Displays the speed and the state of both Charge Air Cooler and radiator cooling fans, expressed in percentage from 0 to 100%.

FUEL DATA

The Fuel Data menu provides information on the fuel consumption of the vehicle in various situations. For example, how much fuel has been used, how much fuel is remaining before refueling the vehicle.

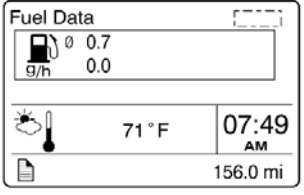

1. Fuel Flow (gph)

The lower numerical value indicates the instantaneous fuel consumption. In this menu, you can reset the upper numerical value which is the average fuel consumption. To reset, hold ENTER button for 1 second.

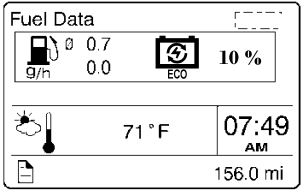

Displays the percentage of trip made on regenerated electricity.

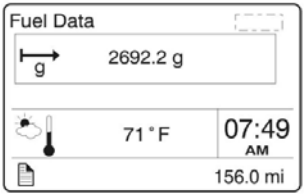

2. Trip Fuel Used

Indicates the total fuel consumption (gallons/liters) since the last reset. Note: You should use Reset function before each new trip.

You can reset the fuel consumption value in this menu. To reset, hold ENTER button for 1 second.

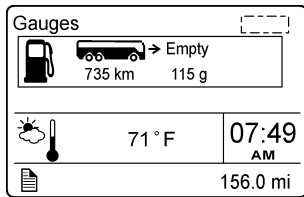

3. Distance to Empty

The left numerical value indicates the distance that can be traveled with the quantity of fuel that remains in the tank as indicated by the right numerical value.

TIME/DISTANCE

The time and date can be set in the Time/Distance menu. The alarm clock can also be set from this menu. Following the alarm clock menu is the Trip Odometer 1 and 2 selection, which allows the operator to see the distance travelled since the last reset. Average trip speed is also shown. By specifying the distance to your destination, the vehicle can calculate the estimated time of arrival (ETA).

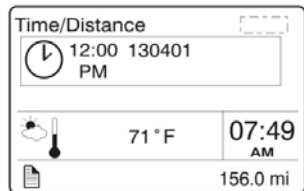

1. Time And Date

Adjust time and date with this menu. The instrument cluster has its own internal battery, so the date and date setting is keep in memory even if the vehicle's battery is disconnected.

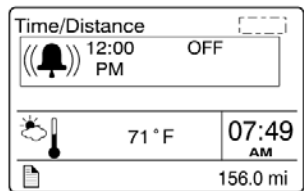

2. Alarm Clock

Use this function to program and activate an alarm on the instrument cluster clock. When the alarm clock goes off, a warning signal is sounded. The alarm shuts off after 60 seconds or if the ESCAPE button is depressed.

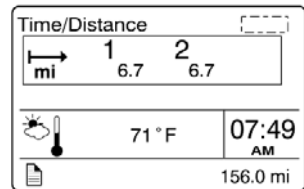

3. Trip Odometer 1 and 2

Allows the operator to see the distance travelled since the last reset. You can reset the trip odometer 1 or 2 in this menu. To reset, depress ENTER button, use UP/DOWN button to select between odometer 1 or 2 and then hold ENTER button for 1 second.

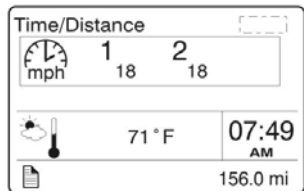

4. Average Trip Speed

This function displays the average speed for the current travel. The average trip speed is calculated as the distance traveled divided by the time the engine has been running (since the last reset). Two average trip speeds can be measured, corresponding to leg 1 and leg 2. Use Reset function before each new travel to start new measurements.

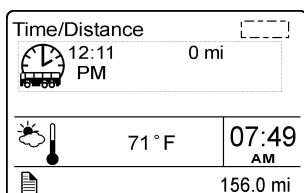

5. Estimated Time of Arrival (ETA)

This function will display the estimated time of arrival if the distance to be traveled is entered first, in this menu. To set distance to be traveled, press ENTER and enter the distance left to drive in mile or km using ENTER and UP/DOWN buttons.

PREVOST LIAISON (OPTION)

The Prevost Liaison system provides cellular communication between the driver and the fleet operator. The driver can send and receive short text messages, which are visible through the Driver Information Display.

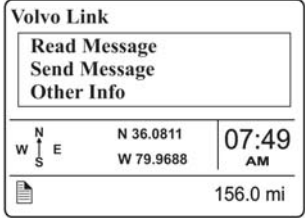

The following menus are available:

- 1. Read Message**
 - Quick Response (only available if there is a message available)
- 2. Send Message**
 - Driver & Equipment
 - Dispatch Messages
 - Free Text
- 3. Other Info**
 - Comm Liaison Info
 - Mailbox Info
 - GPS Info
 - INI Info
 - Configuration Info

VEHICLE MESSAGES

Use this function to consult the vehicle active messages that were previously displayed as pop-up messages and then acknowledged. When consulting a message, the corresponding STOP, CHECK or INFORMATION warning light will illuminate. Scroll through the messages using the up/down button. Press ESC button to return to main menu.

RESET TRIP DATA

When the Reset Trip Data menu is open, pressing and holding down the Enter button for more than 1 second resets the functions listed below. This function will permit to the system to calculate new value from the point of resetting.

- Trip Fuel Used
- Average Trip Speed

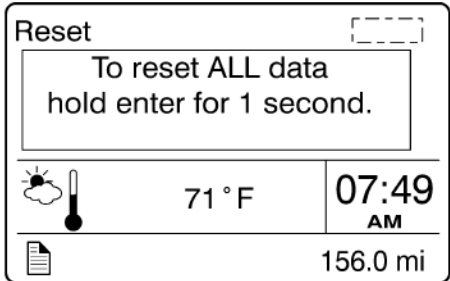

NON-DRIVING/STATIONARY MODE MENUS

DISPLAY SETTINGS

The Display Settings menu is used to change languages and units. The password, time and date can also be changed. The backlight and contrast of the display screen can be adjusted.

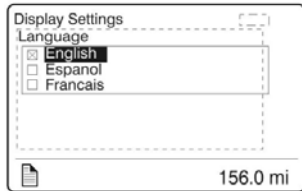

1. Language

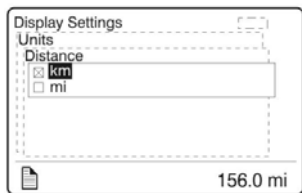

2. Units

Use this function to select desired unit formats for:

- Distance (miles or km);
- Fuel consumption (km/l, l/100km, mpg US or IMP);
- Temperature (°C or °F).

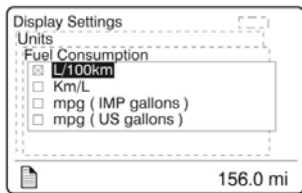

3. Time/Date

Select the time and date format (am, pm, 24h) using this function.

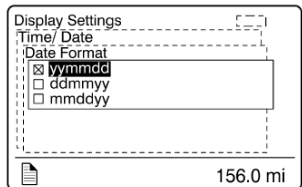

4. Favorite Display Setting

Use this menu to select your favorite display gauges 1, 2 and 3 and replace the default gauges. On vehicles provided with the I-Shift transmission, Favorite Display Gauge 3 cannot be edited as it is kept for display of the transmission status.

Example: You wish to display the engine oil temperature at the Gauge 1 position.

1. Use UP/DOWN button until Gauge 1 position is selected.
2. Press ENTER button to confirm.

Use UP/DOWN button to scroll through the available gauges. When the engine oil temperature gauge is displayed, press ENTER button to confirm (repeat steps 1-3 to change Gauge 2 and Gauge 3 if needed).

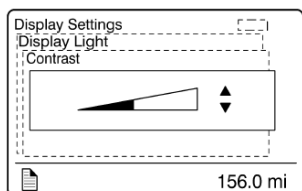

5. Display Light

The Display Light menu has three sub-menus:

- Contrast

Adjust the contrast with the UP/DOWN button and press ENTER button to confirm.

- Backlight

In this menu, the display lighting can be adjusted relative to other instrument lighting with the UP/DOWN button.

- Night/Day

Use the Night/Day menu to choose a dark background with light text and images or a light background with dark text and images. Press ENTER button to toggle between Night and Day.

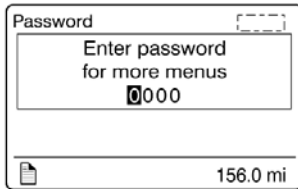

6. Change Password

Use this menu to change the current password. This menu is only accessible if the correct password is entered. The default password is 0000.

1. Mark which password is to be changed with the display UP/DOWN button.
2. Confirm with ENTER button.
3. Set the first digit with the UP/DOWN button.
4. Step to the next digit using ENTER button.
5. Step backwards with ESC button.

DIAGNOSTICS

The Diagnostics menu enables fault tracing on the control units in the vehicle to check for faults. Instrument tests are available to check the telltales, gauges, display and speaker. The part number of a control unit can be identified in the part number menu.

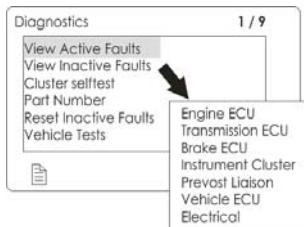

1. View Active Faults

A list of the control units on the vehicle is displayed. Use this function to check for active faults on specific control units.

2. View Inactive Faults

Use this function to check for inactive faults on specific control units.

3. Cluster Selftest

Use this menu to check proper functioning of the following components:

- Telltale lights
- Analog gauges
- Display
- Speakers

The following table describes the available tests. To cancel a test, press the ESC button).

Telltale lights test	Telltales illuminate for approximately five seconds. Press the Esc button to cancel the test.
----------------------	---

Analog gauges	The indicators move forwards and backwards between the end positions. They do not show any particular value. This is just a check to confirm that the indicators move, and to make sure the operators are working. Press the Esc button to cancel the test.
Display test	The entire display lights up until the Esc button is pressed.
Speaker Test	A sound is emitted through the speakers. Press the Esc button to cancel the test.

4. Part Number

A list of the control units on the vehicle with their part numbers is displayed in the Part Number menu.

5. Reset Inactive Faults

Use this menu to delete an inactive fault for a particular control unit. Note: it is not possible to delete inactive faults of the Engine ECU.

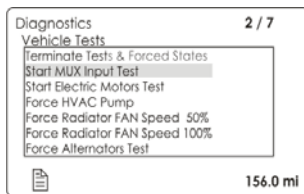

6. Vehicle Tests

Use this menu to perform tests on several components and systems:

- dashboard switches (Mux Input Test)
- electric motors, valve and pump contactors (Electric Motors Test)

In case of overheating of the engine due to a malfunction of the radiator fan you can force activation of the fan using ACTIVATE RADIATOR FAN SPEED 50% or 100%.

The DID status line will show TEST to confirm that one of the test modes is active. To cancel an active test, turn the ignition switch to the OFF position or press ESCAPE button, select TERMINATE TESTS & FORCED STATES submenu and then press ENTER button twice. “TEST” will disappear from the DID status line.

For further information concerning these functions, refer to section 06: Electrical, under “Available Test Modes” and “Limp-home Modes” paragraph of the Maintenance Manual.

PRE-TRIP ASSISTANT (OPTION)

The Pre-Trip Assistance option is a tool to assist the driver in completing the pre-trip inspection of the vehicle. This option is not a substitute for a complete pre-trip inspection. If any system of the vehicle does not pass inspection, the error must be corrected before operating the vehicle. The available pre-trip tests include the Exterior Light Inspection check, and the Air Leakage check.

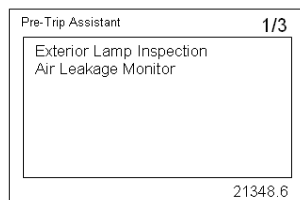

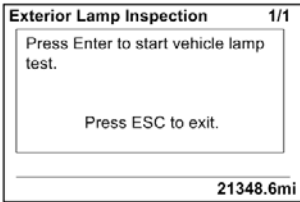

1. Exterior Light Inspection

The Exterior Light Inspection function turns on all the exterior lights simultaneously. This allows the operator to start the test, exit the vehicle and do a visual check that all exterior lights function properly. Press ESCAPE button to end the test and turn off all the exterior lights.

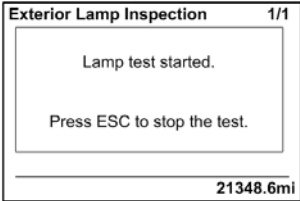

2. Air leakage Monitor

The Air Leakage check allows the driver to accurately measure the amount of air pressure drop in the front and rear brake air systems. After selecting this test from the DID, you are prompted to apply the service brake for 60 seconds. After applying and holding the service brake for 60 seconds, the DID will display the amount of pressure drop in the brake system.

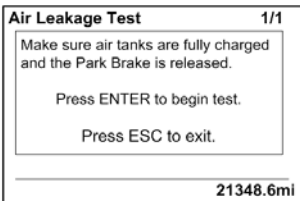

Before starting the test through the DID, complete the following:

- a. Chock the wheels to prevent the vehicle from rolling.
- b. Start the engine and check that the brake systems air pressure is greater than 100 psi.
- c. Turn engine off.
- d. Release the parking and service brakes and allow the system to settle (air gauge needle stops moving).
- e. Press the ENTER button to start the test.
- f. If the air tanks pressure is too low to perform the test (pressure must be greater than 100 psi), the following messages will appear.
- g. You must press and hold brake pedal for 60 seconds, as instructed.
- h. Once the brake pressure test is completed the pressure leak test results are displayed.

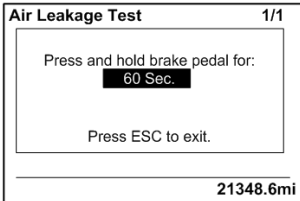
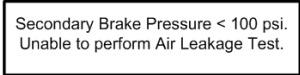
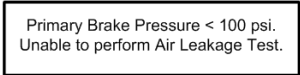

Pressure Leak Test Results			
Tank	Before	After	Drop
F	127	127	0
R	129	129	0

(1)VEC 2044.6mi

DATA LOG

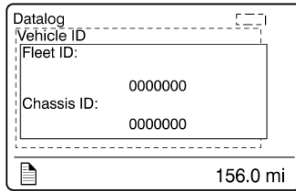

1. Vehicle ID

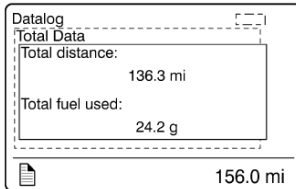

2. Total Data

Total Data menu indicates the accumulated engine values that have been logged during the lifetime of the engine ECU.

Available information:

- Total distance traveled
- Total fuel used
- Total engine hours
- Total idle time
- Total PTO hours
- total engine revolutions

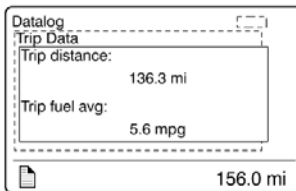

3. Trip Data

This menu displays the trip information listed below. This function must be reset before each measurement (before each new trip or leg) using the Reset Trip Data menu.

Available information for the trip or leg is:

- Trip distance (miles or km)
- Trip fuel average (mpg, liter/100km; km/liter)
- Trip fuel used (gallons or liters)
- Trip duration on cruise control (hours)
- Trip duration with engine rpm greater than economy rpm (hours)
- Trip duration while engine rpm is greater than the desire maximum rpm RPM Limit set in Fleet Limits sub-menu (hours)
- Trip fuel used with engine rpm greater than the economy rpm (gallons/liters)
- Trip average speed (mph, km/h)
- Trip duration with speed greater than the maximum desired speed as set in Fleet Limits sub-menu (hours)
- Trip engine hours
- Trip duration on engine idle (hours)
- Trip fuel used while in engine idle (gallons, liters)

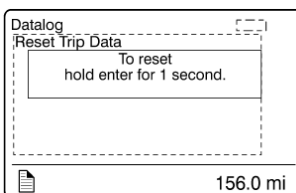

4. Reset Trip Data

This menu can only be accessed if the correct password has been entered. Use this function to reset measurements of the Trip Data menu before each new trip or leg.

AFTERTREATMENT

This menu permits to the driver to initiate a stationary regeneration, to check the status of the aftertreatment system and to interrupt regeneration.

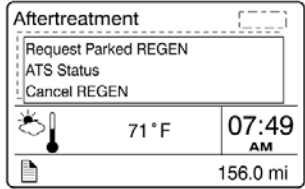

1. Request Parked REGEN

Use this function to initiate a stationary (parked) regeneration.

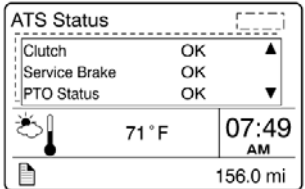

2. ATS Status

The Aftertreatment status sub-menus provide information about the conditions required for performing regeneration. The status can be OK (regeneration allowed), CHECK (regeneration not allowed) or N/A (not applicable). When ATS Status is selected, the following sub-menus are available.

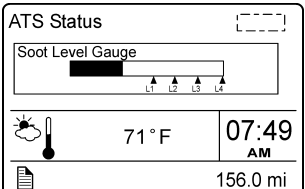
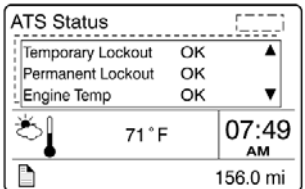
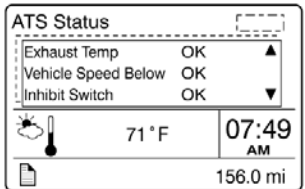
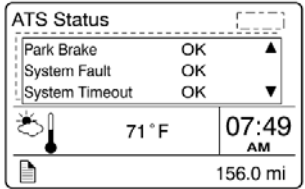
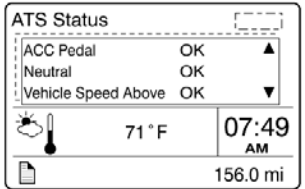

Soot Level Gauge

From the ATS Status sub-menu, you can view the soot level for the Aftertreatment system. When the soot level is high, regeneration is necessary. L1, L2, L3 and L4 under the scale correspond to Level 1 up to Level 4 (see Diesel particulate filter clogging sequence – Engine indicator lamp).



3. Cancel REGEN

From the Aftertreatment main menu, you can cancel a REGEN cycle.

PASSWORD

Certain functions are password-protected. These passwords give the user access to all password-protected functions. The default password is 0000.

1. Password

The following menus are password-protected and marked with a key symbol in the menus:

- Change Password
- Fleet ID
- Reset Trip Data
- Fault Diagnostics
- Inactive Faults

INTELLIGENT SLEEP MODE (ISM)

The ISM is a battery-saving feature designed to monitor the battery State Of Charge (SOC). The ISM will automatically change the vehicle electrical system from normal functional state to sleep mode if the battery SOC falls below 65%.

Once the vehicle has entered into sleep mode, the only actions needed to put the vehicle back into its normal functional state are:

- To cycle the ignition key from OFF to ON;
or
- To open the entrance door;
or
- To turn on the hazard lights.

The ISM forces the vehicle to go into sleep mode if all the following conditions are met:

1. The engine is not running;
2. The parking brake is applied
3. The ignition switch is at the ON, ACC positions or at the OFF position but the 15 minutes “wake up” period after engine shutdown is not expired.
4. The battery state of charge of 12V or 24V system falls below 65%.

The red ALTERNATOR telltale will illuminate 30 seconds before activation of the sleep mode.



TRANSMISSION RETARDER

The transmission retarder is an optional device that helps to reduce the speed of a vehicle. It improves vehicle control, increases driving safety and permits more economical operation. The retarder provides slowing power when it is most needed, such as when descending mountain roads, in stop-and-go traffic and on crowded freeways.

The transmission retarder is a vehicle-slowng device, not a vehicle-stopping device. It is not a substitute for the service braking system. The service brake must be used to bring the vehicle to a complete stop.

The retarder is provided with control buttons on the steering wheel and a lever on the steering column (refer to “CONTROLS AND INSTRUMENTS” chapter).

NOTE

Extended use will raise the temperature of the transmission fluid.

The retarder helps reduce speed on grades without using the vehicle's conventional service braking system. This virtually eliminates brake overheating and reduces the risk of a runaway vehicle. A retarder greatly increases the service life of brake pads and discs, resulting in reduced brake maintenance costs.

NOTE

The stoplights automatically illuminate when the vehicle is slowing down after application of the transmission retarder.

NOTE

For vehicles equipped with the Antilock Braking System (ABS), as the wheels start to lock up on slippery roads, the output retarder automatically deactivates until the wheels roll freely.

ENGINE BRAKE



WARNING

A vehicle speed retarding device (such as engine brake) is not intended to replace the service brake systems on your vehicle nor intended to bring your vehicle to a stop. A vehicle speed retarding device is only intended to reduce the speed of your vehicle under certain conditions.

Several types of engine brake can be installed or are standard on certain engines. All are used to reduce wear on the vehicle brake linings.



WARNING

When descending significant grades, use the service brake as little as possible. If the engine does not slow the vehicle to a safe speed, apply service brake and shift to a lower range. Let the engine (and engine brake) slow the vehicle. Keep brakes cool and ready for emergency stopping.

VOLVO ENGINE BRAKE (VEB)

On vehicles equipped with the Volvo Engine Brake (VEB), the engine brake mode is by default, set to the AUTO mode (A) at vehicle start-up.

When running in AUTO (A) mode, the engine brake is gradually applied to 100% of the braking power when the driver *pushes the brake pedal*. Since AUTO (A) mode will not reduce vehicle momentum unless the brakes are applied, it will have no impact on fuel consumption.

The driver can also choose two other modes using the steering wheel switches; Engine brake LOW (1) and engine brake HIGH (2).

When set to the engine brake LOW (1) mode, 50% of the engine brake power will be applied when the driver *releases the accelerator pedal*. Using engine brake HIGH (2) will apply 100% of the braking power.

It must be noted that since engine brake LOW (1) and engine brake HIGH (2) will reduce vehicle speed upon release of the throttle pedal, they may negatively impact fuel consumption if used for extended periods of time.

On vehicles equipped with an engine brake switch, it is possible to deactivate the engine brake (OFF mode). To do so, the driver must press the engine brake switch located on the left side of the dashboard.

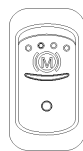

Engine Brake Switch

NOTE
When using engine brake LOW (1) or HIGH (2) mode, pressing the steering switch OFF button will switch back to the default AUTO (A) mode.

DRIVER PEDALS	ENGINE BRAKE MODE	ENGINE BRAKE FORCE
---------------	-------------------	--------------------





ANY POSITION		0%
ACCELERATOR PEDAL RELEASED		0%
BRAKE PEDAL PUSHED		100%
ACCELERATOR PEDAL RELEASED		50%
		100%

ENGINE BRAKE FORCE APPLIED ACCORDING TO SELECTED MODE AND DRIVER PEDAL POSITION.

NOTE
Engine brake is safe to use in any road conditions including adverse conditions.

CRUISE CONTROL AND ENGINE BRAKE

When cruise control is enabled by the driver, the engine brake mode is forced to AUTO (A) mode and the engine brake will progressively engage up to 100% if the selected cruise speed is exceeded by approximately 2 Km/h (1.25 mph). Manually switching to engine brake LOW (1) or HIGH (2) using the steering switches will deactivate the cruise control.

CRUISE CONTROL & SPEED	ENGINE BRAKE MODE	ENGINE BRAKE FORCE
 + CRUISE SPEED SET + 2 Km/h		0%
		UP TO 100%
		N/A
		N/A

ENGINE BRAKE FORCE APPLIED WITH CRUISE CONTROL

NOTE

On vehicles equipped with the Allison transmission, if cruise control is enabled, the current engine brake mode is saved in the vehicle computer (MCM) memory and the engine brake mode is set to Auto mode (A). When the cruise control is disabled, the engine brake mode changes back to the mode saved in the MCM memory.

ANTILOCK BRAKING SYSTEM (ABS), TRACTION CONTROL SYSTEM (TCS), ELECTRONIC STABILITY CONTROL (ESC)

ANTILOCK BRAKING SYSTEM (ABS)

The purpose of the Antilock Braking System (ABS) is to maintain vehicle stability and control during braking and to minimize the stopping distance in any road condition.

On slippery roads and more generally in emergency situations, over-braking frequently induces wheel locking. Wheel locking greatly increases breaking distance on any road

surface. Locked wheels also impede directional control and cause severe tire abrasion. An antilock braking system provides maximum braking performance while maintaining adequate control on slippery roads.

The basis of ABS is constant monitoring of wheel parameters during braking. Sensors on each wheel of the front, drive and tag axles constantly measure wheel speed during braking. This information is transmitted to a six-channel electronic processor which senses when any wheel is about to lock. Modulating valves quickly adjust brake pressure (up to 5 times every second) to prevent wheel lock. Each wheel is therefore controlled according to the available grip.

In this way, the vehicle is brought to a stop in the shortest possible time while remaining stable and under the driver's control.



WARNING

Vehicles following ABS-equipped vehicles may not be able to brake as fast on slippery roads.

TRACTION CONTROL SYSTEM (TCS)

TCS controls wheel spin during vehicle acceleration to improve traction.

- The TCS system will intervene automatically and apply braking pressure to a spinning wheel transferring engine power to the other drive wheel that have better traction. This feature is active only at speeds below 25 mph (40 km/h).
- If all of the drive wheels begin to spin, the TCS system will reduce engine throttle to improve traction at all of the drive wheels.

If drive wheels begin to lose traction during acceleration, TCS will engage automatically to assist the driver in accelerating the vehicle. The TCS icon in the DID will flash rapidly to let you know whenever TCS is actively functioning.

ELECTRONIC STABILITY CONTROL (ESC)

The ESC stability system is an optional feature for ABS-equipped vehicles that reduces the risk of rollovers and loss of control. The ESC system

features include the RSP Roll Stability Program and Yaw Control.

The RSP system counteracts the tendency of a vehicle to tip over while changing direction (typically, while turning).

To reduce the risk of rollover, the RSP system detects potential rollover conditions and slows the vehicle both by reducing engine throttle (and hence, engine torque) and by applying service brakes as needed at the appropriate wheels.

 WARNING
<p>During an RSP system intervention, the vehicle automatically decelerates. The RSP system can slow the vehicle with or without you applying the brake pedal, and even when you are applying the throttle.</p>

During an RSP system intervention, you can always use your service brake pedal to increase the braking pressure that will be applied. However, if you were to apply less braking pressure than needed or even if you release the brake pedal entirely during an intervention, the RSP system will continue to apply the necessary amount of braking pressure automatically to the appropriate wheels to mitigate a potential rollover.

Yaw Control is a feature that reduces the risk of loss of control. If a vehicle's tires start to slide during a turn, Yaw Control counteracts the tendency of that vehicle to spin (or yaw), thereby reducing the risk of loss of control. Many factors, including road conditions, load distribution and driving behavior, can contribute to the development of a spin.

 WARNING
<p>In the case where a vehicle equipped with the ESC system pulls a trailer, the latter must be equipped with ABS.</p>

 CAUTION
<p>Even with ESC-equipped vehicles, the driver remains responsible for ensuring vehicle stability during operation.</p>

<p><i>NOTE</i></p>
<p>For further details, consult "Bendix ABS Operator's Manual".</p>

DRIVER CONTROLLED DIFFERENTIAL LOCK (DCDL)

<p><i>NOTE</i></p>
<p>The DCDL system is not available on vehicles equipped with a ZF A-132 drive axle.</p>

By actuating the electric switch, the driver can lock or unlock differential action.

The purpose of the DCDL is to provide maximum vehicle traction and control on unfavorable road surfaces. When the DCDL is actuated, a clutch collar completely locks the differential case, gearing, and axle shafts together. This feature maximizes traction to both wheels. The lock position will also protect against spinout damage to the differential. The DCDL should not be actuated when favorable road conditions exist.

OPERATION TIPS

1. The DCDL can be locked or unlocked if the vehicle is standing still or moving at a constant low speed when the wheels are not spinning, slipping, or losing traction.
2. When the DCDL is locked, operate the vehicle at low speeds. DCDL will not engage and will disengage in speed higher than 5 MPH (8 km/h).
3. When the DCDL is locked, the vehicle's turning radius will increase. This condition is called "understeer." The driver must use caution, good judgment and drive at low speeds when operating the vehicle with the DCDL locked.
4. Always unlock the DCDL as soon as the need for maximum traction has passed and the vehicle is traveling on a good road.
5. Do not lock the DCDL when the wheels are slipping or losing traction, or damage to the axle can result.
6. Do not lock the DCDL when the vehicle is traveling down steep grades, or potential loss of vehicle stability could occur.

LOCKING THE DCDL

When encountering poor road conditions where maximum traction is needed, follow the recommended procedures:

1. Without the wheels spinning, slipping or losing traction, flip the DCDL control switch to the "LOCK" position while maintaining a constant vehicle speed.
2. Let up momentarily on the accelerator to relieve torque on the gearing, allowing the DCDL to lock.
3. When the DCDL is fully locked, the vehicle will have an "understeer" condition when making turns. Proceed cautiously over poor road conditions.

UNLOCKING THE DCDL

When the vehicle can safely operate and driving conditions have improved, disengage the DCDL following the recommended procedures:

1. Flip the control switch to the "UNLOCK" position, when the vehicle is stopped or when traveling at low speed while the wheels are not spinning, slipping or losing traction.
2. Let up momentarily on the accelerator to relieve torque on the gearing, allowing the DCDL to unlock.
3. Resume driving at normal speed using good driving judgment.

KNEELING SYSTEM

This system lowers the front end, enabling passengers to get on and off the coach without any difficulty.

To operate:

1. Stop the coach and apply the parking brake;
2. Set the transmission to neutral (N);
3. Push down the kneeling rocker switch located on the L.H. control panel (Refer to "Controls & Instruments" chapter).

A status line pictogram will appear on the DID to indicate that the front of the coach is being lowered.

To raise the front of the coach to its normal height:

1. Push up the kneeling rocker switch. The front end will rapidly rise up.



CAUTION

Avoid parking the coach too close to the sidewalk or to other obstacles which could damage the coach during kneeling.

NOTE

Kneeling is disabled when the entrance door is open.

HI-BUOY

The coach may be equipped with the optional front Hi-Buoy or full Hi-Buoy. The front Hi-Buoy system has the same functions as front kneeling. In addition it enables passengers to get on or off the coach easily by raising the front end about 4 inches (100 mm), which may prove useful when the dock is higher than usual. The front Hi-Buoy is combined with front kneeling to increase flexibility of the system. Refer to "Controls & Instruments" chapter.

The full Hi-Buoy system raises the whole coach about 4 inches (100 mm). It can be used to enable passengers to get on or off the coach easily, and to safely travel roads with high obstacles. Refer to "Controls & Instruments" chapter.

NOTE

The Hi-Buoy system does not operate when the coach is traveling over 5 mph (8 km/h). Consequently, the driver cannot inadvertently operate the Hi-Buoy system at higher speeds.

LOW-BUOY

This system lowers the coach about 4 inches (100 mm). It enables the coach to drive through underpasses where the height is less than 12 feet (3.7 m).

Low-Buoy operation is controlled by a valve located on the L.H. control panel. The valve can be switched to either LOW-BUOY or NORMAL positions. A warning light on the dashboard will indicate that the coach is being lowered. Refer to "Controls & Instruments" chapter.



CAUTION

Avoid parking too close to the curb or other obstacles that could damage the coach during low-buoy operation.

NOTE

The Low-Buoy cannot be activated when the coach is traveling over 5 mph (8 km/h). Consequently, the driver cannot inadvertently operate the Low-Buoy system at higher speeds.

RETRACTABLE TAG AXLE

The tag axle is controlled by a valve located on the lateral control panel. The valve can be switched to either the WHEELS UP or WHEELS DOWN position. The axle will be raised or lowered by air pressure according to the valve position. Refer to "Controls & Instruments" chapter.

The tag axle service brakes operate only when the tag axle is in the WHEELS DOWN position. Never lower the tag axle while the coach is moving. When the tag axle is in the WHEELS UP position, the corresponding indicator light will illuminate. The indicator light will start flashing and an audible alarm will sound to warn the driver if the vehicle speed exceeds 12 mph (20 km/h) with tag axle raised. The tag axle can be raised in tight maneuvering areas like in a parking lot or to make it easier to turn a short corner. The tag axle shortens the wheelbase and allows tighter turning. Raising the tag axle transfers extra weight and additional traction to the drive wheels providing improved control on slippery roads.



CAUTION

Do not use tag axle in raised position for an extended period. Raising tag axle increases load on the drive axle, suspension and tires.

Do not drive vehicle with tag axle raised when speed is exceeding 12 mph (20 km/h).

In order to prevent damage to the suspension, always raise the tag axle before lifting the coach.

TAG AXLE UNLOADING

To reduce the turning radius, the air springs pressure will be automatically reduced by 75% when the coach is moving at speed lower than 5 mph (8 km/h) and with more than 1½ turn from the steering.

ENGINE COOLANT HEATER

This optional auxiliary heating system is used for preheating and retaining the heat of water-cooled engines. It can be used before startup to ease starting and to provide rapid operation of the interior heating system. It can also be used with the engine running to maintain coolant heat and interior temperature.

The heater operates independently of the engine. It is connected to the cooling system, heating circuits and to the vehicle's fuel and electrical system.



WARNING

The coolant heating system uses the same fuel as the engine. Do not operate in a closed building or while refueling. Operate only in a well ventilated area.

SWITCHING THE HEATER ON

The timer light illuminates when the heater is switched ON. Air is forced in to flush out the combustion chamber of residual gases and the water circulation pump begins operating. The fuel metering pump delivers fuel in precise amounts to the combustion chamber, where fuel and combustion air form a combustible mixture which is ignited by the ignition unit.

Once the flame sensor has signaled to the control unit that combustion has taken place, the ignition unit is switched OFF. The dashboard telltale light will illuminate to indicate when the burner is ON.

Hot combustion gases are diverted at the end of the flame pipe and are then forced through the indirect heating surfaces of the heat exchanger. The heat exchanger transfers the heat to the coolant water passing through the heat exchanger.

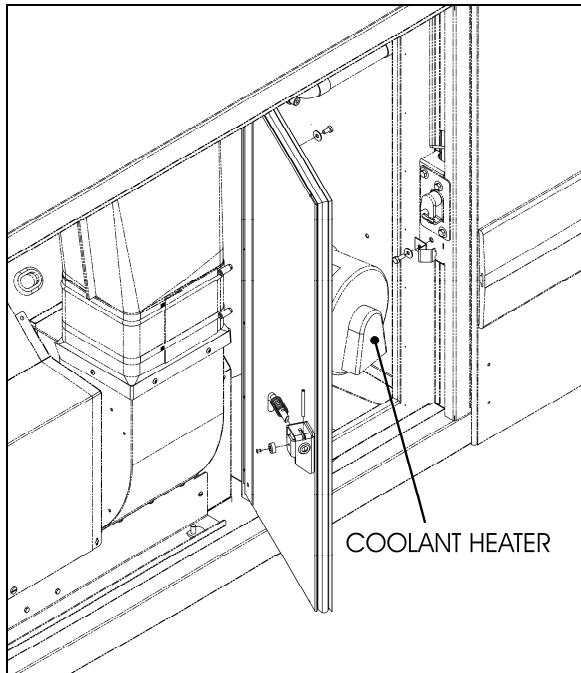

LOCATION OF PREHEATER

18607

The heater is thermostatically controlled and operates intermittently (i.e., the switched-on time of the burner varies depending on the heat requirement). The water temperature is controlled by the built-in water thermostat.

The water circulation pump remains in operation as long as the heater is operating, even during the regulated intervals and during the delayed cut-out of the heater. The pump can also be operated independently of the heater by means of an appropriate circuit. The heater can be switched *ON* at any time (i.e., during the delayed cut-out period). Ignition takes place after the delayed cut-out time expires.

SWITCHING THE HEATER OFF

The fuel supply is interrupted when the heater is switched *OFF*. This causes the flame to go out and a delayed cut-out of 2.5 minutes begins. The circulating combustion air flushes the remaining combustion gases out of the chamber and cools off the heated parts on the exhaust side of the heat exchanger. The water circulation pump continues to transfer the latent heat present in the heat exchanger, thus preventing hot spots. Once the delayed cut-out time expires, both the combustion air blower and the water circulation pump switch *OFF* automatically. A cut-out will automatically take place in case of heater failure. Refer to

Technical Information chapter for additional information.

COOLANT HEATER TIMER

The timer, located on L.H. control panel is used to program the starting and stopping time of the preheating system and to give Fault Codes. The system indicator light, located on the timer, illuminates when the system is functional. Your vehicle is equipped with timer A or timer B.

Timer A: Operating instructions

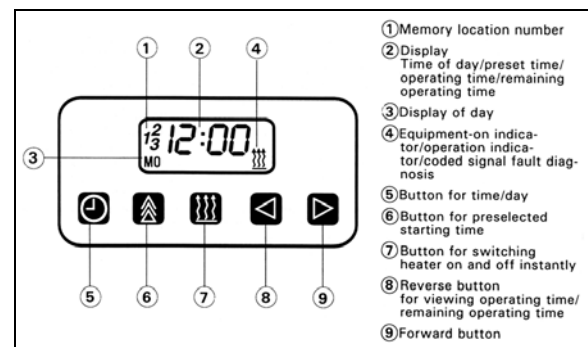

TIMER

22223

These instructions refer to the Valeo timer illustrated above.

Remaining Operating Time

The remaining operating time refers to the period of time the heater still continues to remain in operation. It may be changed while the heater is in operation.

Setting the Digital Timer

After the power has been connected, all symbols on the digital display are flashing. The time of the day and the day of the week must be set.

All flashing symbols of the timer can be set by means of the Forward (9) or Reverse (8) buttons.

When buttons (8) and (9) are pressed for more than 2 seconds, the quick digit advance mode is activated.

Setting the Time and Day of the Week

1. Press button (5) for more than 2 seconds (time display flashes).
2. Press (8) or (9) button to set the time of day.

3. Wait 5 seconds. The time of day is stored (day of week flashes).
4. Press (8) or (9) button to set the correct day of week.
5. Wait 5 seconds. The day of week is stored.

Viewing the Time (Ignition ON)

Continuous display of current time and day of the week.

Viewing the Time (Ignition OFF)

Briefly press button (5) to display current time and day for 5 seconds.

Switching Heater ON (Instant Heating) With Ignition ON:

Press button (7). Heater is switched on (continuous operation) and continues to operate until button (7) is pressed again or ignition is switched off.

NOTE

If the ignition is switched off while heater is in operation, the remaining operating time of 15 minutes flashes on the display and the heater will continue to operate for this period of time.

Switching Heater ON (Instant Heating) With Ignition OFF:

Press button (7). Heater is switched on for preset operating time (the factory-set heater operating duration is 60 minutes)

Switching Heater OFF

Press button (7). The heater starts its after-run cycle and switches off thereafter.

Presetting Starting Time

1. Press button (6). Memory location number flashes.

NOTE

By repeatedly pressing button (6), starting time 2 or 3 can be preset.

2. Press button (8) or (9) until correct startup time is set.
3. Wait 5 seconds. Preset starting time is stored and day of week flashes.
4. Press button (8) or (9) to select the correct startup day of week.

5. Wait 5 seconds. The startup day of week is stored.

The number of memory location remains on the display. The timer is now in the programmed mode and will switch the heater on at the preset time.

NOTE

We recommend that memory locations 1 and 2 be used for presetting times within 24 hours of setting the timer. Memory location 3 can be used for a starting time within the next 7 days of setting the timer.

Recalling Preset Times

Press (6) repeatedly until the desired memory location number and preset time are displayed.

Canceling Preset Time

Press button (6) repeatedly until no more memory location number is visible on the display.

Setting Operating Time

1. With heater off, press button (8). Operating time flashes.
2. Press button (8) or (9) to set the operating time (between 1 and 120 minutes)
3. Wait 5 seconds. Operating time is stored.

The heater remains in operation for the preset time (except for continuous operation).

Setting the Remaining Operating Time

1. With heater in operation, press button (8). Remaining operating time flashes.
2. Set remaining time with button (8) or (9).
3. Wait 5 seconds. Remaining operating time is stored.

9. Push selection button (3) or (6) to switch between 12h and 24h modes. The display shows **HH 12** or **HH 24**.
10. Push enter button (5) to confirm mode.

Timer B: Operating instructions

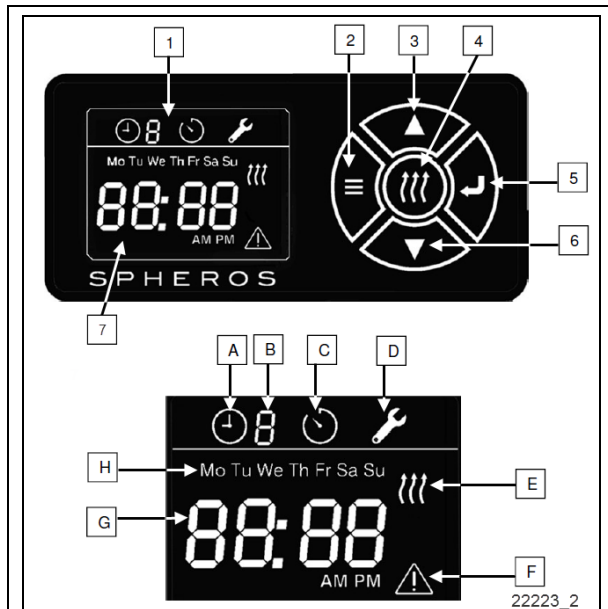

FIGURE 1: PREHEATER TIMER

1. Menu row	A. Preselection time
2. Menu-button	B. Active/deactivate starting
3. Selection UP	C. Operating time
4. Instant heating	D. Setting sign
5. Enter	E. Preheater on
6. Selection DOWN	F. Error
7. Display	G. Time
	H. Day

These instructions refer to the timer illustrated in Figure 1. They are the same instructions provided in the Valeo instruction booklet, provided with your vehicle.

SET TIME AND DAY

Select 12h or 24h mode

6. Push menu-button (2) to show menu row at the top of the display (1).
7. Push selection button (3) or (6) until setting sign (D) is blinking.
8. Push enter button (5) to open hour mode options.

Set time and day with 24h mode selected



1. Display shows.
2. Push selection button (3) or (6) until you get the right day of the week.
3. Push enter button (5) to confirm day.
4. Push selection button (3) or (6) to adjust hours.
5. Push enter button (5) to confirm hours.
6. Push selection button (3) or (6) to adjust minutes.
7. Push enter button (5) to confirm minutes and to return to standard display.

Set time and day with 12h mode selected

1. Display shows.
2. Push selection button (3) or (6) until you get the right day of the week.
3. Push enter button (5) to confirm day.
4. Push selection button (3) or (6) to adjust hours.
5. Push enter button (5) to confirm hours.
6. Push selection button (3) or (6) to adjust minutes.
7. Push enter button (5) to confirm minutes: Display shows **AM**.
8. Push selection button (3) or (6) to switch between **AM** and **PM**.
9. Push enter button (5) to confirm and return to standard display.

ADJUST OPERATING TIME

The operating time is the period, when the preheater is ON through pushing the instant heating button or after activating a starting time.

1. Push menu-button (2) to show menu row at the top of the display (1). 
2. Push selection button (3) or (6) until setting sign (C) is blinking. 
3. Push enter button (5) to show the adjusted operating time.
4. Push selection button (3) or (6) to adjust the operating time.
5. Push enter button (5) to confirm the operating time and to show standard display.

ADJUST REMAINING TIME



The remaining time is the period, when the preheater remains ON after ignition is switched OFF.

If the ignition is switched OFF while the preheater is ON, the remaining time can be adjusted.

1. Push selection button (3) or (6) to adjust remaining time.
2. Push enter button (5) to confirm.

Preheater stops automatically after remaining time is over. The remaining time will not be saved. It has to be adjusted and confirmed every further time. If the remaining time is not confirmed within 10 seconds, the preheater stops.

SET A STARTING TIME

1. Push menu-button (2) to show menu row at the top of the display (1). 
2. Push selection button (3) or (6) until setting sign (A) is blinking. 
3. Push enter button (5) to make starting time number to appear. 
4. Push selection button (3) or (6) to browse the starting time numbers.
5. Push enter button (5) to choose the starting time you wish to setup: display shows day and time and next step day can be adjusted.
6. Push selection button (3) or (6) to adjust day.

7. Push enter button (5) to confirm day.
8. Push selection button (3) or (6) to adjust hours.
9. Push enter button (5) to confirm hours.
10. Push selection button (3) or (6) to adjust minutes.
11. Push enter button (5) to confirm minutes: standard display appears.

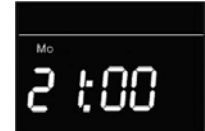

Only in 12h-mode after adjustment of time:

12. Push selection button (3) or (6) to switch between AM and PM.
13. Push enter button (5) to confirm: standard display appears.

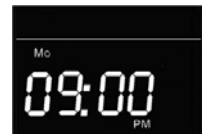



NOTE

Seven starting times are available for a period of seven days, but only one starting time can be active.

For safety reasons a starting time can only be activated for the same or next day.





Activation for Sunday and Monday is possible on Friday; activation for Monday is possible on Saturday.

ACTIVATE STARTING TIME



1. Push menu-button (2) to show menu row at the top of the display (1). 
2. Push selection button (3) or (6) until activate start sign (B) is blinking. 
3. Push enter button (5) to confirm.
4. Push selection button (3) or (6) to browse starting times (programmed days and times appear in the display according to the starting time number).
5. Push enter button (5) to activate the chosen starting time: activated starting time and the chosen number appear in the display.



DEACTIVATE STARTING TIME

1. Push menu-button (2) to show menu row at the top of the display (1). 
2. Push selection button (3) or (6) until deactivate start sign (B) is blinking. 
3. Push enter button (5) to confirm.
4. Push selection button (3) or (6) until sign  and sign  appear in the display.
5. Push enter button (5) to confirm.

START/STOP INSTANT HEATING

1. To start preheater, push instant heating button (4) when ignition is ON; sign is blinking. 
2. If the preheater runs well, the sign stops blinking and appears permanently in the display.
3. To stop preheater, push instant heating button (4). 

OPERATING TIME WITH INSTANT HEATING

1. Push instant heating button (4) when ignition is OFF: operating time value appears in the display.
2. Push selection button (3) or (6) to adjust operating time.
3. Push enter button (5) to confirm: Sign  appears and the preheater will operate for the adjusted time.

<i>NOTE</i>
Date and time have to be adjusted in the settings before using instant heating.

Operational Failure Symptoms via Fault/Flash code

On preheaters equipped with a fault diagnosis system using coded light signals, the equipment-on indicator/operation indicator flashes. Refer to the following table.

PREHEATER TROUBLESHOOTING AND MAINTENANCE

Refer to the Valeo manual for more information.

<i>NOTE</i>
If there are no preheater faults, the preheater will go through a normal start cycle and regulate based on thermostat setting.

<i>NOTE</i>
Switch on the preheating system briefly about once a month, even during the warm season.

 CAUTION
To avoid running down the batteries, do not turn on the preheating system for more than one hour before starting the engine.

 WARNING
The preheating system uses the same fuel as the engine. Do not operate in a building or while refueling. Operate only in a well-ventilated area.

<i>NOTE</i>
<i>If there are no heater faults, the heater will go through a normal start cycle and regulate based on thermostat setting.</i>

WHEELCHAIR LIFT SYSTEM

It is important to passenger safety that the lift operator be familiar with the operating instructions. Read and understand the RICON Mirage F9TF F9TH Wheelchair lift Operator Manual before attempting to use the wheelchair lift. The instructions below are a quick reference only and not a replacement to the information provided by RICON.

*Watch the **Prevost Wheelchair Lift Instruction video** on Prevost's YouTube channel. To do so, type "Prevost Coach – YouTube" on your web browser and then select the proper link. Once on Prevost channel, select "Video" tab and then look for the video entitled "Prevost Wheelchair Instruction".*

INTRODUCTION

Safe and easy access to the coach is provided by the Ricon Mirage F9TF and F9TH Public Use wheelchair lifts. The Mirage F9TF or F9TH is a dedicated entry model, which is intended for installation in a vehicle baggage compartment.

An electric-motor driven hydraulic pump provides a maximum platform lifting capacity of 660 pounds (300 kilograms) for Mirage Model F9TF and 800 pounds (363 kilograms) for Mirage Model F9TH.

A trained attendant or the vehicle operator operates the lift. For a boarding passenger, the operator uses control switches to withdraw the platform from the vehicle (deploy) and lower it to ground level. The passenger is placed on the platform and then lifted to floor height. After the passenger enters the vehicle, the operator lowers the platform and retracts it back into the vehicle (stow). For an exiting passenger, the operator withdraws the platform from the vehicle (deploy) and raises it to floor height. The passenger is placed on the platform and then lowered to the ground. The passenger departs, and the operator returns the platform to the stowed position in the vehicle.

One individual can manually operate the lift when normal power is not present. A manual release mechanism is provided to ease the task of pulling the platform out of its enclosure. The hydraulic pump assembly includes a manually operated back-up pump to raise the platform, and a pressure release valve to lower it. The front platform rollstop, normally power operated, has a manual override knob for back-up use.

OVERVIEW

Major lift components

Left, Right, Front, Rear	Reference points from outside vehicle looking inward at lift.
Bridgeplate	Plate bridges gap between platform and vehicle floor when platform is at floor level. Acts as barrier during up and down platform motions to prevent wheelchair from rolling off rear of platform.
Carriage	Part of traveling frame that is mounted on rollers; moves on rails located inside enclosure. Supports lifting frame and platform.
Controller	Receives electrical input signals from pendant and lift sensors and sends control signals to lift electrical and hydraulic components.
Control pendant	Hand-held device used to control platform motions.
Cycle counter	Located on rear frame of carriage. Visible when platform is fully deployed. It records number of times platform has moved from floor to ground and back to floor.
Deployment system	Located within carriage. Employs an electric gear-motor to propel platform out of enclosure, or pull it back into enclosure.
Enclosure	Travelling frame housing that is rigidly attached to vehicle chassis.
Fluid reservoir	Container holds hydraulic fluid that is used by hydraulic system.
Folding handrail	(left and right) Provides a handhold for standing passenger (standee).

Front rollstop	Front barrier prevents wheelchair from inadvertently rolling off platform during platform movement.
Handrail release button	(left and right) Locks handrail in vertical position. Must be pushed inward to release handrail.
Hydraulic cylinder	Located within carriage and connected to lifting frame. Receives pressurized fluid from hydraulic pump to lift platform.
Hydraulic pump assembly	Electro-hydraulic unit provides hydraulic pressure used to raise platform. Also mounts components for manual operation.
Lifting frame	Assembly is hinged to front of carriage and to center of platform; raised by single hydraulic cylinder attached to carriage.
Manual pump handle	Used to manually operate hydraulic backup pump and pressure release valve when electrical power is not available. Also used to rotate platform release shafts.
Platform	Curbed area where passenger resides while being raised to vehicle or lowered to ground.
Platform release shaft	(left and right) Used during manual operation of lift. Disengages platform from enclosure to facilitate manual deployment. Engage and rotate either shaft with manual pump handle.
Pull box	Houses electrical termination points to lift, and a hydraulic line disconnect point. Also accepts input harness from control pendant.
Rollstop control knob	Provides manual control of rollstop if electrical power is not available.
Safety belt	Safety restraint belt that spans between handrails to help confine passenger to platform area.
Stow Lock	Safety lock retains platform when in stowed position (retracted); releases when stow lock lever is raised.
Travelling frame	(not shown as unit) Assembly comprised of carriage, lifting frame, and platform.

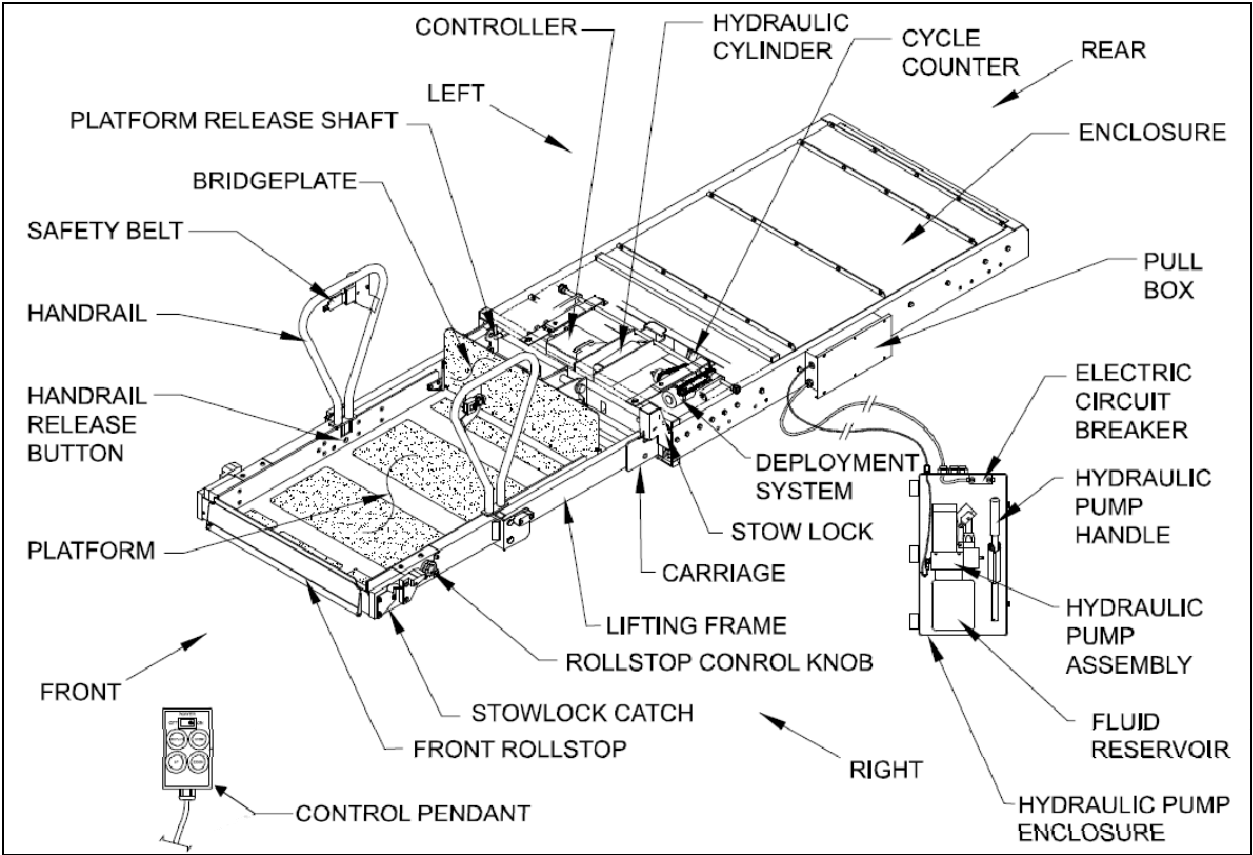

GENERAL SAFETY PRECAUTIONS

- To avoid injury, always exercise caution when operating and be certain that hands, feet, legs, and clothing are not in the path of product movement.
- Read and thoroughly understand the operating instructions before attempting to operate the wheelchair ramp.
- Inspect product before each use. If unsafe conditions, unusual noises or movements, do not operate lift until the problem is corrected.
- Stand clear of doors and platform and keep others clear during operation.

OPERATING INSTRUCTIONS

Safety Precaution

- To operate the wheelchair lift, the coach must be parked on a flat and level surface, with the parking brake applied.
- Inspect the lift before each use as described in the RICON Operator Manual **32DF9T15** under paragraph "Pre-Operation Lift Inspection". If any unsafe condition exists, or if unusual noises or movements are noticed, DO NOT use and contact an authorized RICON dealer for repair.
- Read and comply with all warning labels and symbols affixed to the wheelchair lift.
- Wheelchair occupant should face outward when entering or exiting vehicle.
- Do not back onto platform when exiting vehicle. FACE OUTWARD, and verify that platform is at the same height as floor. Check that front rollstop is up and locked.
- The front rollstop is intended to prevent slow, unintentional, rolling off of platform.
- The front rollstop is not intended to stop a quick moving wheelchair. A quick moving wheelchair could tip if the small front wheels collide with the rollstop. Also, the large rear wheels of a quick moving wheelchair could roll over the rollstop. Possible injury to the occupant might occur in either case.
- Verify that wheelchair fits safely on platform; it must not extend beyond edges or interfere with operation of rollstop.
- Do not operate with a load in excess of 660 lbs (300 kg) for Mirage Model F9TF and 800 pounds (363 kilograms) for Mirage Model F9TH.
- Keep arms, legs, and clothing away from moving lift parts.
- The lift is intended for one wheelchair and its occupant, or one standee. Do not overload lift.
- Keep others clear while operating lift.
- Do not allow an untrained person to operate lift.
- Do not allow anyone to stand on bridgeplate. A bent bridgeplate can interfere with the platform as it raises and lowers.
- Lock wheelchair brakes before raising or lowering platform (power chair users should turn off power and set brake).
- Use great care in wet conditions; the wheelchair brakes are less effective if its tires or the platform are wet.
- Do not leave deployed platform unattended. Return to stowed position after use.

Hand-Held Control Pendant and Motion

The lift is operated with a hand-held, hard-wired remote-control pendant. Turn on the POWER ENABLE switch and then control each lift motion by pressing an appropriate button.

The POWER ENABLE switch provides power to the pendant and thereby enables the lift. When turned on, the power switch and each button illuminate.

Pressing the DEPLOY/OUT button extends the platform from the lift storage compartment, and pressing the STOW button retracts the platform back into the storage compartment. Pressing the DOWN button lowers the platform towards the ground, and pressing the UP button raises the platform towards the vehicle floor.

A button must be held depressed until the motion is completed. Movement of the platform can be halted at any time by releasing the button.



HAND-HELD CONTROL PENDANT

MOTION		DESCRIPTION
	DEPLOY / OUT	Platform extends out of vehicle, or deploys.
	DOWN	Platform lowers from present height towards ground; front rollstop lowers when platform contacts ground
	UP	Platform rises from present height towards vehicle floor; rollstop rises before platform leaves ground.
	STOW / IN	Platform retracts into vehicle, or stows.

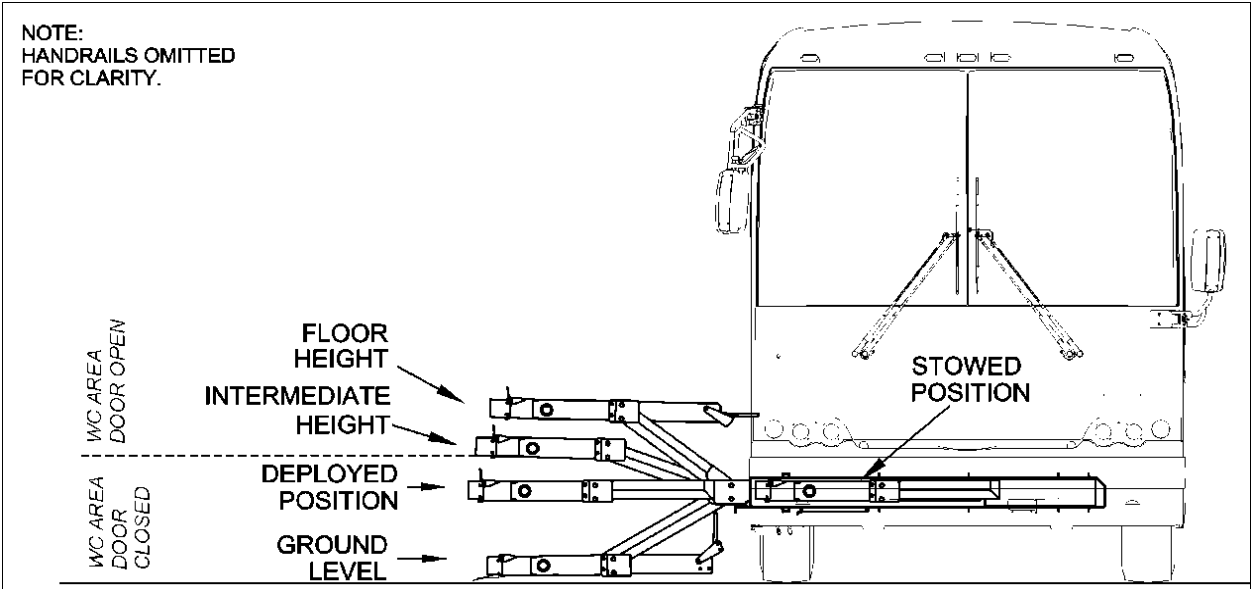

PLATFORM POSITION WITH INTERMEDIATE HEIGHT (OPTIONAL FEATURE)

Normal Lift Operation – To Enter Vehicle

- Before operating lift, be certain vehicle is safely parked on a level area away from traffic. Provide at least 10 feet (3 meters) space for lift operation and passenger boarding.
- The lift operator must take special care to ensure that area is clear before deploying platform. Be certain there are no obstacles beneath platform.
- Open lift compartment door completely.

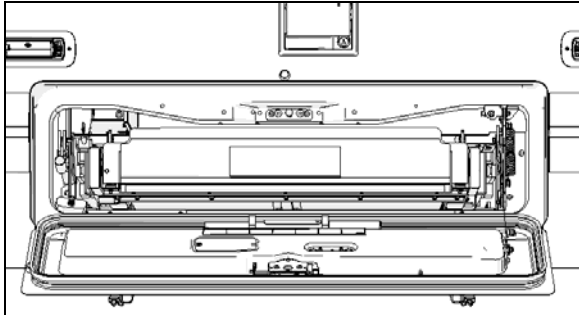

X3 SERIES SHOWN

- Open sliding door directly above lift compartment. This does not apply to models that stop upward platform movement prior to reaching floor level. The sliding door on these models is opened after the platform reaches **intermediate height** (refer to Figure 3).
- The vehicle and lift are equipped with a safety interlock system (i.e. transmission into neutral, parking brake applied). Be certain that it is in the proper mode before attempting to operate lift. The lift will not operate until this feature has been properly engaged.
- Supply power to the wheelchair lift system first by depressing the wheelchair lift activation switch located on the dashboard.

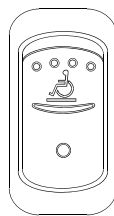

WHEELCHAIR LIFT ACTIVATION SWITCH

NOTE

Whenever the wheelchair lift activation switch is in the ON position, an interlock system prevents releasing of the parking brake and a transmission inhibit feature prevents gear selection when either the lift compartment door or the sliding door is open.

- Enable lift control pendant by turning on POWER switch located on pendant.
- A person that uses the wheelchair lift while standing (does not require mobility aid equipment) is referred to in this manual as a Standee.

1. **ACTIVATE INTERLOCK:** Make sure parking brake is set and transmission is in neutral.
2. **DEPLOY PLATFORM:** Press and hold DEPLOY/OUT button until platform is fully deployed. **NOTE:** Platform cannot be moved up or down unless platform is fully extended.
3. **RAISE HANDRAILS:** Lift right handrail to vertical and push firmly down into its socket. Repeat for left handrail. Verify that both handrails are latched in place by attempting to pull upward on them.
4. **BUCKLE SAFETY BELT (to enable lift controller):** Insert belt tongue into buckle and listen for audible “click” then tug belt to confirm belt is securely fastened.

NOTE

The safety belt acts as a safety device and it prevents raising or lowering the lift when not buckled.

5. **LOWER PLATFORM:** Press and hold DOWN button until platform stops at ground level and rollstop opens completely.
6. **BUCKLE SAFETY BELT.**
7. **BOARD PLATFORM:** Position wheelchair in center of platform, facing outward and advise occupant to lock wheelchair brakes. Power must be turned off on electric-powered wheelchairs.

NOTE: *Standee must stand near the center of the platform, facing in the direction of travel (into vehicle), and firmly grasp handrails. Do not stand on bridgeplate.*

8. **BUCKLE SAFETY BELT (to enable lift controller):** Insert belt tongue into buckle and listen for audible “click” then tug belt to confirm belt is securely fastened.

NOTE: *The next two steps apply only to F9TF/F9TH models that stop upward platform movement at an intermediate level. Other models continue at step 11.*

9. **PARTIALLY RAISE PLATFORM:** Press and hold UP button until platform stops at intermediate height.
10. **OPEN SLIDING DOOR:** Fully open vehicle sliding door located above lift. The lift operator, or attendant should do this.
11. **RAISE PLATFORM:** Press and hold UP button until platform stops at floor height and bridgeplate lowers onto vehicle floor.



WARNING

Verify that rear edge of bridgeplate lies flat on floor along its entire edge and does not create a tripping hazard.

12. **EXIT PLATFORM:** Advise passenger to carefully enter vehicle.
13. **BUCKLE SAFETY BELT.**
14. **LOWER HANDRAILS:** Press release button at base of handrail and lift the left handrail upward out of its socket. Lower handrail to platform. Repeat for right handrail.
15. **STOW PLATFORM:** Press and hold STOW/IN button. Close sliding door at intermediate height. Press and hold STOW/IN button until platform reaches STOW height and then fully retracts into vehicle.

NOTE: *Do not use DOWN button to lower platform partway prior to stowing, and then complete the stowing process by using IN button. This method may not properly stow platform.*

16. **CLOSE DOOR.** Close the lift compartment door.

Normal Lift Operation – To Exit Vehicle

1. **ACTIVATE INTERLOCK:** Make sure parking brake is set and transmission is in neutral.
2. **DEPLOY PLATFORM:** Press and hold DEPLOY/OUT button until platform is fully deployed.
3. **RAISE HANDRAILS:** Lift right handrail to vertical and push firmly down into its socket. Repeat for left handrail. Verify that both handrails are latched in place by attempting to pull upward on them.
4. **BUCKLE SAFETY BELT (to enable lift controller):** Insert belt tongue into buckle and listen for audible “click” then tug belt to confirm belt is securely fastened.

NOTE: The next two steps apply only to F9TF/F9TH models that stop upward platform movement at an intermediate level. Other models continue at step 7.

5. **PARTIALLY RAISE PLATFORM:** Press and hold UP button until platform stops at intermediate height.
6. **OPEN SLIDING DOOR:** Fully open vehicle sliding door located above lift. The lift operator, or attendant should do this.
7. **RAISE PLATFORM:** Press and hold UP button until platform stops at floor height and bridgeplate lowers onto vehicle floor.



WARNING

Verify that rear edge of bridgeplate lies flat on floor along its entire edge and does not create a tripping hazard.

8. **BOARD PLATFORM:** Position wheelchair in center of platform, facing outward and advise occupant to lock wheelchair brakes. Power must be turned off on electric-powered wheelchairs.

NOTE: Standee must stand near the center of the platform, facing in the direction of travel (into vehicle), and firmly grasp handrails. Do not stand on bridgeplate.

9. **LOWER PLATFORM:** Press and hold DOWN button until platform stops at ground level and rollstop opens completely.
10. **UNBUCKLE SAFETY BELT.**
11. **EXIT PLATFORM:** Carefully assist passenger off of platform.
12. **LOWER HANDRAILS:** Press release button at base of handrail and lift the left handrail upward out of its socket. Lower handrail to platform. Repeat for right handrail.
13. **STOW PLATFORM:** Press and hold IN button until platform reaches STOW height and then fully retracts into vehicle.

MANUAL LIFT OPERATION

The lift can be operated manually if it loses electrical power. The following sections describe important safety preparations to be followed before using the lift, and operating procedures to deploy, raise, lower, and stow the lift. Ricon recommends that manual operation be used only to exit from vehicle, not to enter vehicle.

Preparation

- Park vehicle on a level surface, away from traffic. Allow sufficient space for lift operation and passenger boarding.

- The operator must summon assistance to move vehicle to a safe operating area if a breakdown situation exists and vehicle cannot be moved under its own power.
- Check to be certain obstacles are not in path of platform movement.
- Open vehicle doors by hand and secure.
- Caution people in vicinity that platform is about to deploy.
- Follow the "Safety Precautions ".

Manual lift controls

Manual operation components used are a hydraulic backup pump and pump handle, platform release mechanism, and a rollstop control knob.

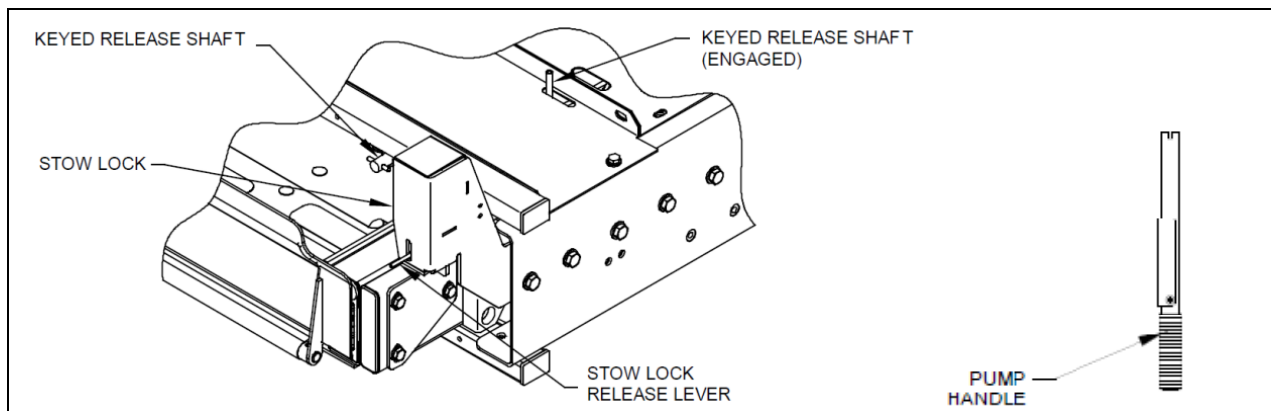

MANUAL LIFT CONTROLS

To Manually Deploy the Platform

1. Fully open sliding door and lift compartment door. Ensure that there are no obstacles in the path of the lift.
2. Take the manual backup pump handle secured inside the manual pump box (H3 Series) or attached to the inner side of the lift compartment door (X3 Series).
3. Engage either keyed release shaft with the pump handle.

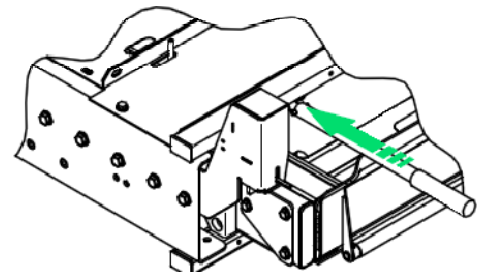
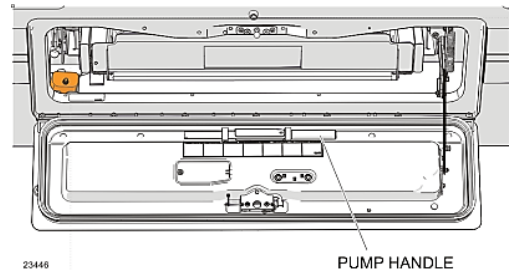

5-44 Other Features

4. Rotate the keyed release shaft $\frac{1}{4}$ -turn (as indicated on adjacent decal) while lifting stow lock lever simultaneously.

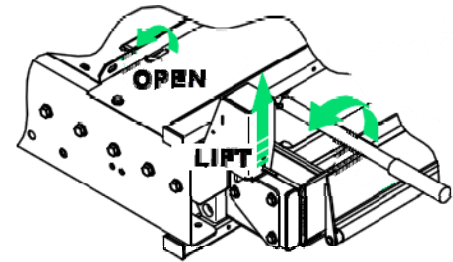
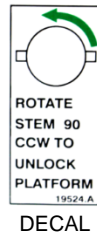

5. Grasp the top edge of the front rollstop with two hands and pull firmly. The platform moves smoothly after an initial resistance. Pull platform straight out to the end of its travel.

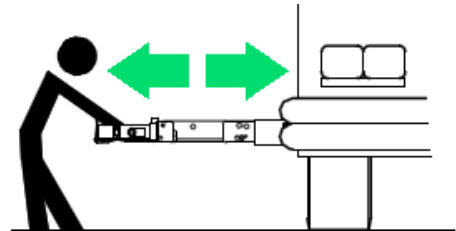

CAUTION

Ensure that release shaft re-engages and locks when platform is fully extended. If release shaft does not engage, use manual pump handle and turn $\frac{1}{4}$ -turn (direction opposite to orientation shown on adjacent decal) to re-engage release shaft.

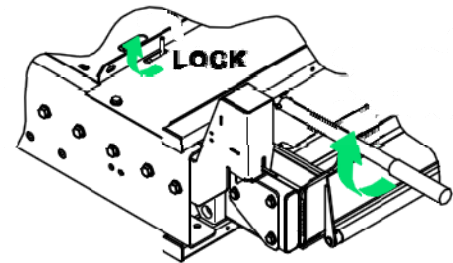

6. Lift right handrail to vertical and push firmly down into its socket. Repeat for left handrail.

To Manually Raise the Platform

1. Verify that rollstop is up (closed). Pull rollstop control knob out and rotate fully clockwise, if it isn't up.

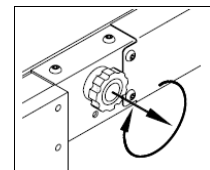
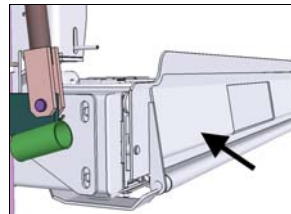

2. Close the backup pump release valve by pushing the actuating rod (A) DOWN (release valve should already be closed).

NOTE: pumping the handle raises the platform when the release valve is closed).

3. Insert pump handle into backup pump socket (B), then pump handle to raise the platform to the floor level.
4. Position wheelchair in center of platform, facing outward, and advise occupant to lock wheelchair brakes. Power must be turned off on electric-powered wheelchairs.

NOTE: Standee must stand near the center of the platform, facing in the direction of travel (into vehicle), and firmly grasp handrails. Do not stand on bridgeplate.

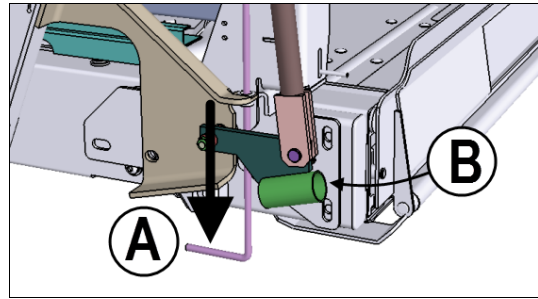

To Manually Lower the Platform

1. Verify that rollstop is up (closed). Pull rollstop control knob out and rotate fully clockwise, if it isn't up.

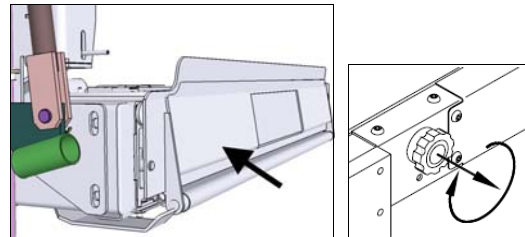

2. Slowly pull the manual backup pump release valve actuating rod (A) UP until the platform begins to lower (opening the release valve lowers platform).

3. Allow the platform to reach ground level.

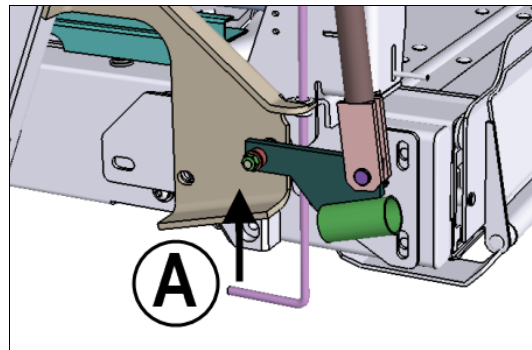

4. Pull rollstop control knob out and rotate fully counterclockwise. Rollstop must lie flat on ground.

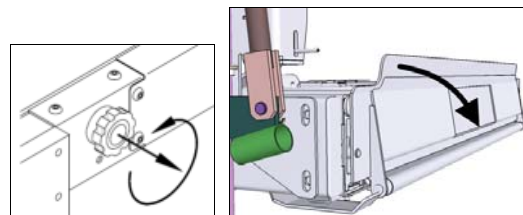

- Carefully assist passenger off of platform.
- Push the backup pump release valve actuating rod back DOWN until lightly-snug.

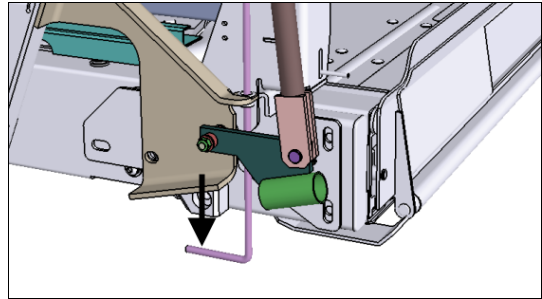

To manually stow the platform

- Verify that the backup pump release valve is closed (actuating rod (A) pushed DOWN).

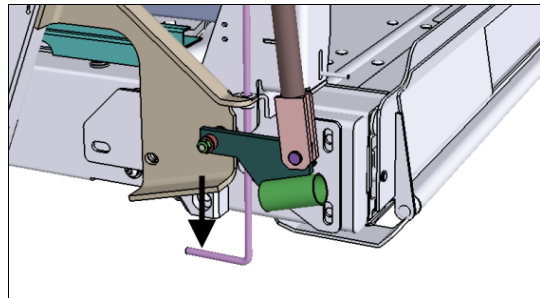

- Raise the platform to stow height; position the top surface of the platform lifting frame arm at the same height as the top surface of the carriage. If the exact height cannot be obtained, a slightly low platform is preferred to slightly high. This alignment eliminates interference between the platform and enclosure when pushing the platform into the enclosure.

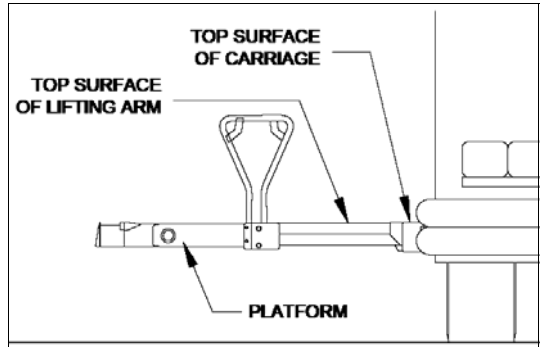

- Verify that rollstop is up (closed). Pull rollstop control knob out and rotate fully clockwise, if it isn't up.

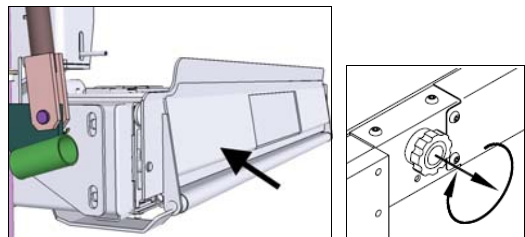

- Lift the left handrail upward out of its socket. Lower handrail to platform. Repeat for right handrail.

	<h2>CAUTION</h2>
<p>An able-bodied person must stow the platform. Use caution and avoid injury.</p>	

- Engage either keyed release shaft with the pump handle.
- Rotate the shaft ¼-turn (as indicated on adjacent decal).

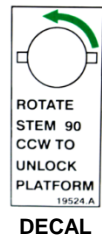
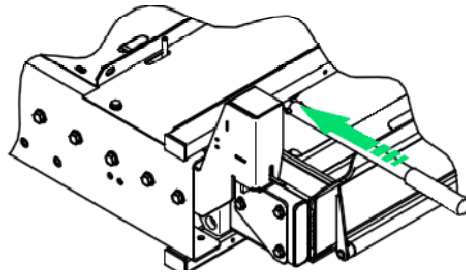

- Grasp the top edge of the rollstop, or the handrails, with two hands and push firmly. The platform moves smoothly after an initial resistance. Push platform in fully.

	<h2>CAUTION</h2>
<p>The platform must lock in place when fully stowed. Check platform retention by attempting to pull platform outward; it must not move.</p>	

- If platform does not lock, rotate either platform release shaft ¼-turn (direction opposite to orientation shown on adjacent decal) to re-engage (lock) release shaft. Platform must be fully stowed before rotating shaft.
- Verify that stow lock striker is engaged and platform is securely stowed.

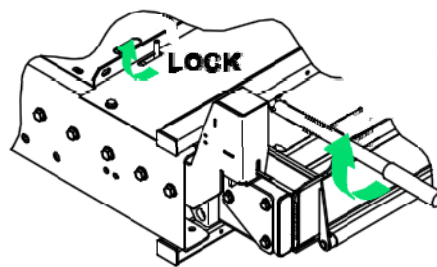

SEATS RECONFIGURATION

To accommodate a wheelchair, one row of seats must be folded and two rows must be folded and slid away. Seats may be folded on both sides of the coach to make room for a second wheelchair.

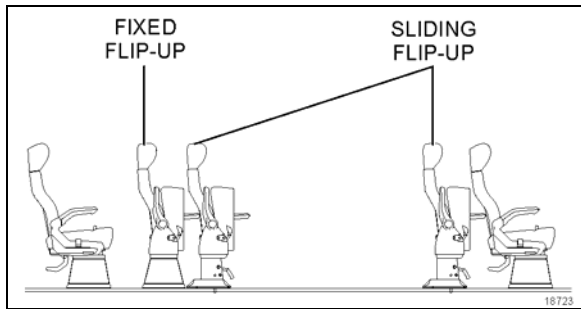

POSSIBLE SEATING ARRANGEMENT

Electrical wheelchair or tri-wheeler may require moving the sliding seats on both sides of the coach to allow enough turnaround space.

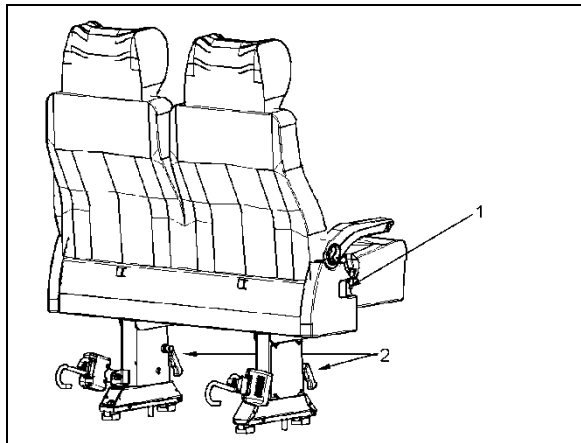

FOLDING AND SLIDING SEATS

To fold a set of seats, raise the seat back then lift up the seat cushion (pull on lever 1). To slide a row of seats, remove the black covers from the floor tracks. Pull the lever 2 while sliding the seat along the track.

WHEELCHAIR RESTRAINT SYSTEMS

Two types of wheelchair restraint systems may be found, depending on the type of seats:

1. 4-point wheelchair and occupant securement with floor anchorage.

2. 4-point wheelchair and occupant securement with anchorage to passengers seat pedestals.

Refer to Q'Straint publications included in the wheelchair restraint plastic pouches for further details.

4-POINT SECUREMENT WITH FLOOR ANCHORAGE

This securement system includes:

- 4 wheelchair tiedown retractors to secure wheelchair to vehicle floor.
- Occupant securements: lap and shoulder belts that integrate to the rear wheelchair restraints.
- Floor anchorages; installed on the vehicle floor.

Two complete sets of wheelchair restraints are kept in plastic pouches and stowed in an overhead compartment. To secure each wheelchair, four tiedown retractors must be used (at all four corners).

Two of the four tiedown retractors have attaching pins to secure the occupant's lap belt. They must be placed at the rear of the wheelchair. Each tiedown retractor slots into a mounting floor pocket.

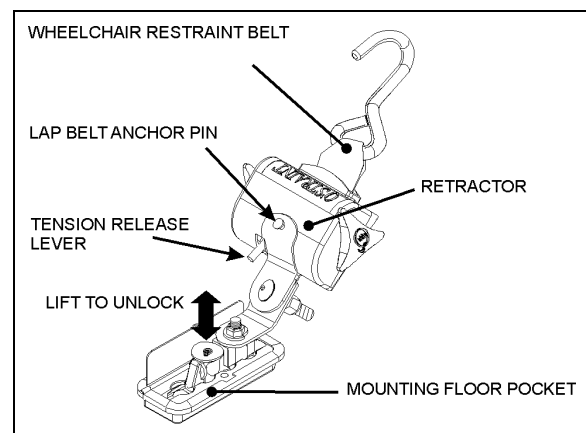

WHEELCHAIR ANCHORAGE SYSTEMS

23266

To anchor the retractors, lift the floor pocket cover, push in the retractor anchor then slide it until it locks in place. Hook one wheelchair restraint belt to each corner of the wheelchair frame (**not the wheels**) and allow the retractors to tension the belts.

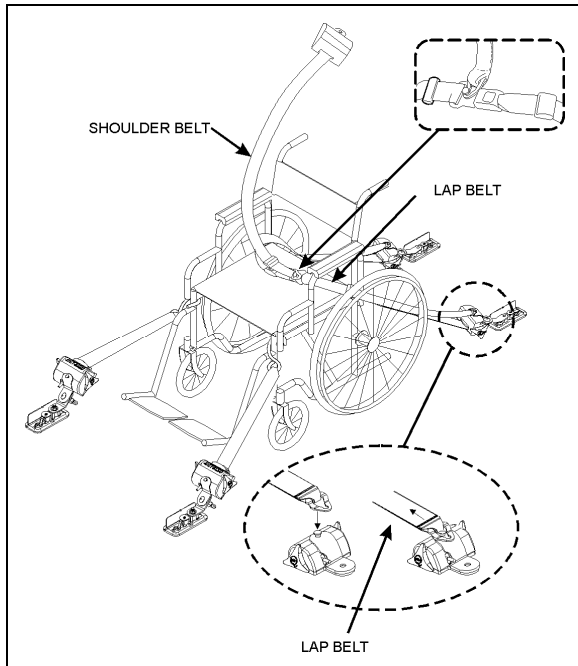

WHEELCHAIR RESTRAINTS AND ACCESSORIES

Use the blue webbing loops whenever the wheelchair restraint belt hook cannot reach a stiff member of the wheelchair chassis.

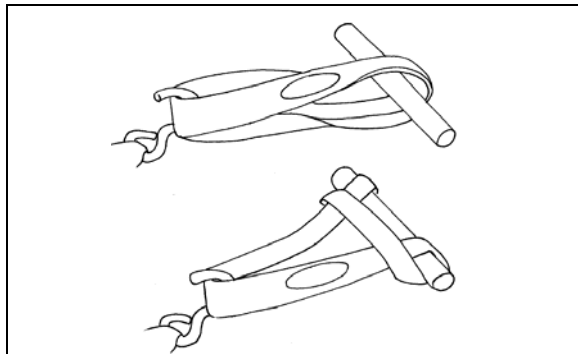

TYPICAL USE OF THE BLUE WEBBING LOOPS

To remove the restraint belts, release tension in the locking mechanism by tightening the belt slightly more with the retractor knob before pushing down the tension release lever found on the retractor. Unhook the wheelchair and allow the belts to retract. Guide the belts in, making sure they remain untwisted as they retract.

Release the anchor by lifting the lock pin then sliding out and up the anchor from the floor pocket. Close the lid to prevent dirt from entering the pocket cavity.



WARNING

Do not let restraint belts or occupant safety belts rub against sharp edges. Do not bleach or dry clean.

Wheelchair Occupant Restraint

Secure the wheelchair occupant in the following manner:

Fix the lap belt to the pins on the retractors of the rear restraint belts. Adjust the lap belt so it sits snug across the hips. Make sure that you place the lap belt buckle on the center aisle side. Fasten the shoulder belt to the pin on the lap belt buckle. A retractor adjusts shoulder belt length automatically.



WARNING

A snug fit with the lap belt positioned low on the hips is necessary to maximize safety. The belt should not be worn or twisted. Avoid pinching the belt and/or hardware. Do not wear over rigid or breakable objects such as eyeglasses, pens or keys as these may cause injuries.



CAUTION

The safety belt buckle provided with the red release button must always be located on the center aisle side.

To release the belts, unfasten the shoulder belt then press the red release button found on the lap belt buckle.

4-POINT SECUREMENT WITH ANCHORAGE TO PASSENGERS SEAT PEDESTALS

This securement system includes:

- 4 wheelchair restraint belts and retractors with anchorage to passengers seat pedestals.
- Occupant securements: lap and shoulder belt.

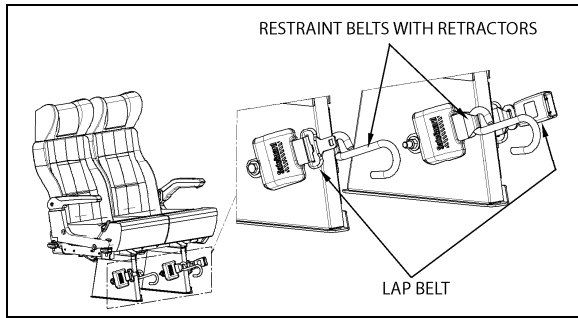

WHEELCHAIR AND OCCUPANT RESTRAINT SYSTEM

To secure the wheelchair, four restraint belts must be used (at all four corners). Hook one wheelchair restraint belt to each corner of the wheelchair frame (**not the wheels**) and allow the retractors to tension the belts.

To remove the restraint belts, push down on the tension release lever found on the retractor. Unhook the wheelchair and allow the belts to retract. Guide the belts in, making sure they remain untwisted as they retract.

Wheelchair Occupant Restraint

Secure the wheelchair occupant in the following manner:

Fasten and adjust the lap belts so it sits snug across the hips. Make sure that you place the lap belt buckle on the center aisle side. Fasten the shoulder belt by inserting the lap belt tab into the shoulder belt buckle. A retractor adjusts shoulder belt length automatically.

	<p>WARNING</p>
<p>A snug fit with the lap belt positioned low on the hips is necessary to maximize safety. The belt should not be worn or twisted. Avoid pinching the belt and/or hardware. Do not wear over rigid or breakable objects such as eyeglasses, pens or keys as these may cause injuries.</p>	

	<p>CAUTION</p>
<p>The safety belt buckle provided with the red release button must always be located on the center aisle side.</p>	

To unfasten the belts, press the red release button on the shoulder belt buckle first and then unfasten the lap belt by pressing the red release button on the lap belt buckle.

WHEELCHAIR LIFT SYSTEM - THRESHOLD WARNING SYSTEM (TWS) ADJUSTMENT

There are three verifications to perform; 1) Adjust Aiming of Acoustic Sensor Beam, 2) Test Aim of Acoustic Sensor Beam, and 3) Adjust Acoustic Sensor Timing.

Adjustment of the sensor timing is done at the factory and should not need to be repeated in the field. Readjustment should only be considered if the sensor aiming could not be adjusted to ignore both the wheelchair in the aisle and the platform during its normal movement.

ADJUST AIMING OF ACOUSTIC SENSOR BEAM

1. Place wheelchair with passenger in center aisle of coach, pointed at doorway where Threshold Warning System (TWS) is installed. The TWS should not detect a wheelchair and passenger when they are located this far from doorway.

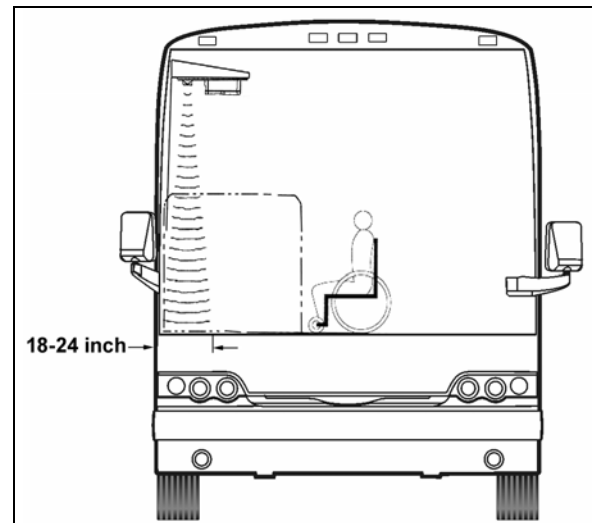

TWS AREA 23371

2. Turn power to lift on (LED on TWS module will light steady) and indicator light on the control device illuminates. If wheelchair and passenger are detected by acoustic sensors the LED will flash, the buzzer will sound and the module red light will flash. If this occurs it is necessary to adjust aiming of sensors.
3. Turn sensor angle adjustment screw clockwise to move direction of beam away

from center aisle and towards doorway. Stop adjustment when LED ceases to flash.

distance of 4½ feet below module. Sheet must be facing sensors.

NOTE
Only in rare instances will adjustment be needed in the counterclockwise direction.

4. Move centerline of small wheels of wheelchair (with passenger) to within 24 inches of doorway and repeat aiming procedure in previous step.

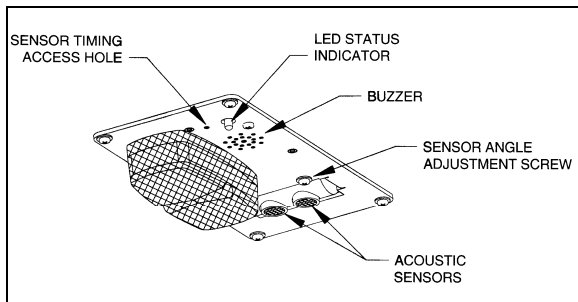

TWS MODULE DETAIL 23368

TEST AIM OF ACOUSTIC SENSOR BEAM

1. Move wheelchair and passenger slowly towards doorway. TWS should detect wheelchair and passenger (LED will flash, buzzer will sound and the module red light will flash) when centerline of front wheels is between 18 and 24 inches from doorway.
2. Open vehicle access door above lift. Lower platform to ground and place wheelchair and passenger at rear of platform. Rollstop (rear barrier) should be up. Raise platform to floor level. This normal platform motion with wheelchair and passenger aboard should not actuate TWS. If LED does flash (buzzer will also sound and module red light will flash), turn sensor adjustment screw slightly counterclockwise.

NOTE
If an adjustment is made, repeat the previous step where wheelchair is between 18 and 24 inches from doorway.

ADJUST ACOUSTIC SENSOR TIMING

1. Support a flat sheet of cardboard, or similar material, directly beneath TWS module at a

NOTE
Before proceeding, visually inspect sensors to verify that they are pointing directly at floor, or nearly, and are not pointing off at an extreme angle.

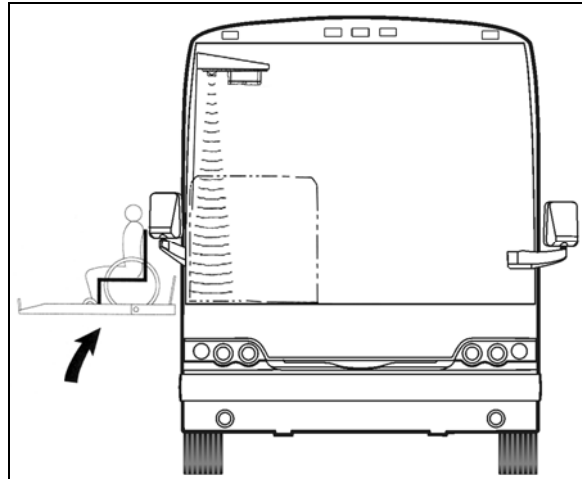

CHECKING NORMAL PLATFORM POSITION 23372

2. Note the sensor timing access hole. This hole provides access to a plunger-actuated switch that sets the sensor timing. Insert a 1/16-inch diameter wire-like object into the access hole and press the plunger inward. The LED will flash momentarily while the module establishes the distance and then remain on steady. Release the plunger when the LED ceases to flash.

NOTE
It is important that objects, such as your body, tools, seats, etc, do not interfere with the beam while the adjustment is being made.

WHEELCHAIR LIFT REMOVAL FOR STORING OR MAINTENANCE PURPOSES

1. Disconnect connector located at compartment ceiling.
2. Remove 4 fixing bolts located inside compartment, on each side of platform.
3. Grasp the platform and pull firmly, sustaining a constant pull so that the

5-52 Other Features

platform slides onto the rails until the carriage come in contact with the stops.

4. Secure the first two telescopic legs onto the platform.

NOTE

There are two telescopic legs for each platform side. The proper side is indicated onto the telescopic leg.

5. Turn telescopic leg crank to raise the carriage to be able to clear the stops.

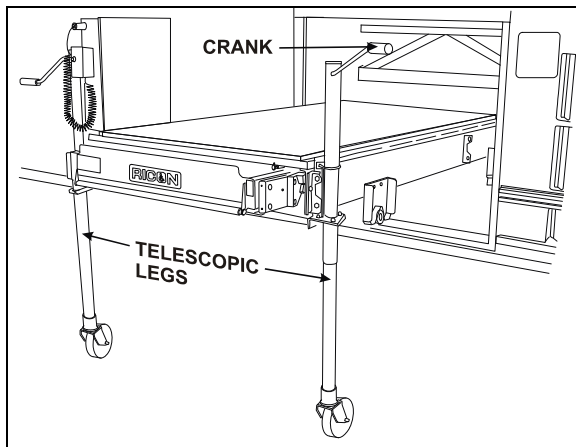

INSTALLATION OF TELESCOPIC LEGS 23333

6. Pull the platform until the rear carriage hit against the stops.
7. Secure the two rear telescopic legs onto the platform then turn telescopic leg crank to be able to clear the stops.
8. Remove platform completely.
9. Lower the platform to minimum height using the telescopic leg cranks before moving it.



WARNING

For better stability, keep the platform at minimum height when moving.



WARNING

Never deploy the platform from enclosure while standing on the telescopic legs.



WARNING

Telescopic legs were designed to support and move the platform only, do not use as a work table.



WARNING

Before moving platform, make sure that floor is level and free of obstacles.

WHEELCHAIR LIFT INSTALLATION

1. Raise the platform to proper level.
2. Insert the platform so that the rear carriage clears the stops.
3. Turn telescopic leg crank until the carriage comes in contact with the rails.
4. Remove the two rear telescopic legs from the platform.
5. Insert the platform until the front carriage clears the stops.
6. Lower the front of the platform.
7. Remove the two front telescopic legs from the platform.
8. Push firmly and make sure that the platform manual release shafts have turned to lock the platform.
9. Secure the 4 fixing bolts located inside compartment, on each side of platform. **Apply a torque of 60 lbf-ft.**
10. Reconnect connector located at compartment ceiling.



WARNING

When re-inserting platform into compartment, make sure that carriage wheels are properly aligned over the L. H. side triangular rail before removing telescopic legs.

Starting and Stopping Procedures 6-1

STARTING THE ENGINE	2
STARTING FROM THE DRIVER'S SEAT	2
<i>Stopping the Engine</i>	2
STARTING FROM THE ENGINE COMPARTMENT	3
<i>Stopping the Engine</i>	3
COLD WEATHER STARTING	4
JUMP STARTING	4
ENGINE PROTECTION SYSTEM	5
AUTOMATIC ENGINE SHUTDOWN	5
IDLE SHUTDOWN TIMER	6
ENGINE BLOCK HEATER.....	7
ENGINE WARM-UP	7
ALLISON TRANSMISSION WARM-UP	7
STARTING THE VEHICLE AFTER A FIRE ALARM.....	7

STARTING THE ENGINE

In normal circumstances, the engine should be started from the driver's seat. However, a rear-start panel in the engine compartment permits starting the engine from that location, mainly for maintenance purposes.

STARTING FROM THE DRIVER'S SEAT

- Make sure the starter selector switch located in the engine compartment is set to the *ENABLE* position and that the main electrical shut-off switch (master cut-out) located on the rear electrical panel is set to the ON position.
- Apply the spring-loaded parking brake by pulling the parking brake control button all the way up;
- Place transmission in neutral;
- Turn ignition key to START position (refer to Controls and Instruments chapter), release the key after the engine starts.
- Brake pedal must be applied when selecting Drive (D) otherwise the transmission will stay in neutral (N).



CAUTION

Do not engage starter for more than 15 seconds at a time. If engine does not start within 15 seconds, release ignition key and let starter cool for one minute before attempting to restart.



CAUTION

Do not press accelerator pedal before starting. This could result in an electronic control unit fault and degrade the fuel system control.



CAUTION

Special precautions are necessary with turbocharged engines to avoid possible turbine damage. After starting, run the engine at normal idle for two minutes to allow lubricating oil to reach the turbocharger then run the engine at fast idle. Let oil pressure reach normal operating range before driving.

NOTE

If engine does not start, return key to OFF position before attempting to restart.

NOTE

If the accelerator pedal is depressed before starting, release and wait 30 seconds before attempting to restart.

Stopping the Engine

- Apply parking brake and place transmission in neutral (N);
- Allow engine to idle for at least two minutes before shutting engine OFF. This insures that the turbine speed drops and allows time for the engine exhaust gas temperature to drop to about 300°F (150°C);
- Shut off all electrical loads;
- Turn the ignition key to the OFF position.



CAUTION

Do not shut OFF engine when running above normal idle.



CAUTION

Set the main electrical shut-off switch (master cut-out) to the OFF position after parking and when left unattended for an extended period of time.

STARTING FROM THE ENGINE COMPARTMENT

Push buttons to start and stop the engine from inside the engine compartment are located on the R.H. side of engine compartment.

DANGER

Apply parking brake and place transmission in neutral (N) before starting engine from inside the engine compartment.

1. Set the main electrical shut-off switch and ignition to the ON position;



MAIN ELECTRICAL SHUT-OFF SWITCH

DANGER

Do not wear loose clothing when working near engine. Stand clear of rotating components.

2. Press the engine **rear start push button** to start the engine from engine compartment

When servicing the engine, push the **engine stop/ignition interlock button** to prevent the engine from being started from the dashboard ignition switch or the rear start push button.

Once servicing is done, twist and pull the button to allow normal engine start.

CAUTION

Refer to cautions in “Starting From The Driver’s Seat” in this chapter

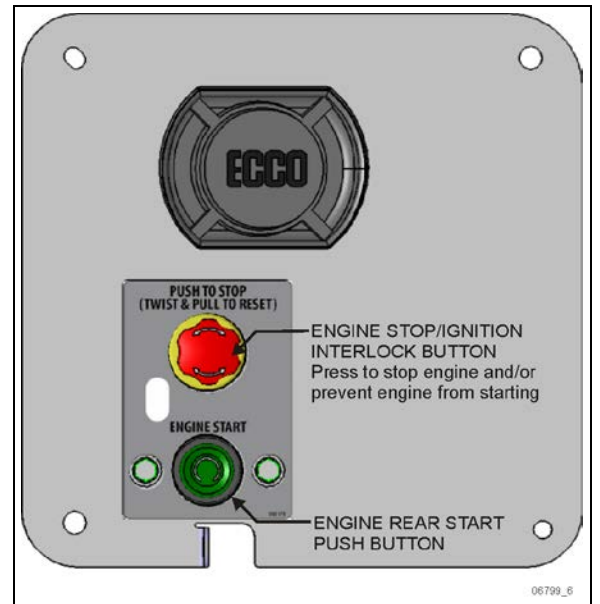

REAR START PANEL

DANGER

Rotating shafts can be dangerous. You can snag cloths, skin, hair, hands, etc. This can cause a serious injury or death. Do not work on a shaft (with or without a guard) when the engine is running.

Stopping the Engine

Press the engine stop/ignition interlock button while the engine is running to stop the engine from the engine compartment.

6-4 Starting and Stopping Procedures

COLD WEATHER STARTING

When starting a cold engine, the intake air should be warmed up by the intake air preheater. Turn the ignition switch to the ON position. The preheater will not engage at coolant temperature above 54°F (12°C). If the coolant temperature is below 54°F (12°C), the preheater will engage and will light the preheater telltale between 0 and 50 seconds, depending on the engine coolant temperature. Wait before the preheater telltale has turned off before starting the engine.



Intake Air Preheater Telltale

If necessary, once the engine has started, the preheater will reengage (post heating) for the same length of time as the preheat time.



WARNING

Volvo D13 Engine

This engine is equipped with an intake air preheater. **Never** use ether or other combustible starting aid fluid. Introduction of ether or similar starting aids could cause a fire or explosion resulting in severe property damage, serious personal injury or death.

JUMP STARTING

In order to avoid damage to solid-state electrical components, it is important that jumper (booster) cables be used correctly and only in emergencies. **To jump start, use another 24 volt DC, negative grounded, power source.** Use only jumper cables rated at 500 cranking amperes.



DANGER

Injury, explosion, battery acid damage or charging system overload may result if these jump starting procedures are not precisely followed.



WARNING

Wear eye protection and remove rings, metal

jewelry and watches with metal bands.



DANGER

The gases given off by batteries while jump starting are explosive. Do not smoke near batteries.



DANGER

The battery could rupture or explode if jump started when the run-down battery fluid is frozen or if the battery fluid level is low. Check condition of run-down battery before attempting to jump start.



CAUTION

Do not let the two vehicles touch. Keep a walk-through distance between the two vehicles. Make sure positive (red) and negative (black) jumper cable clamps do not touch.



WARNING

Before attempting to jump start, make sure the parking brake is applied and the transmission is in neutral (N). Turn off all lights, heaters and other electrical accessories.



CAUTION

Choose a donor vehicle which produces comparable amperage as your vehicle.

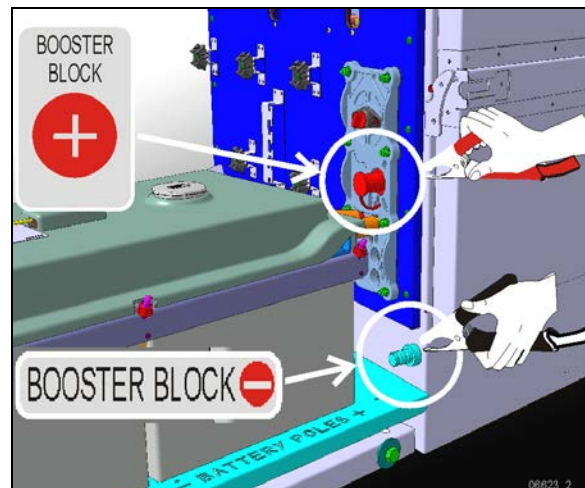

BOOSTER BLOCK LOCATION

06623

NOTE

Jumper cables must be rated at 500 cranking amperes. If jumper cable length is 20 feet (6 m) or less, use 2/0 (AWG) gauge wires. If cable length is between 20 to 30 feet (6 to 9 m), use 3/0 (AWG) gauge wires.

To jump start, proceed as follows:

1. Remove the protective cap from the booster block terminal located in the R.H. side engine compartment;
2. If the good battery is in another vehicle, that donor vehicle's engine must be shut OFF before connecting. Shut off all electrical equipment on both vehicles.
3. Connect one end of the red jumper cable to the **positive (+) post** of the donor vehicle battery (or booster power source).
4. Connect the other end of the red jumper cable to the **positive (+) terminal** on the booster block;
5. Connect one end of the black jumper cable to the **negative (-) post** on the donor vehicle battery (or booster power source);
6. Connect the other end of the black jumper cable to the **negative (-) terminal** on the booster block;
7. Start the engine of the donor vehicle and increase the engine rpm speed slightly and maintain at that level for approximately 5 minutes to recharge dead batteries and then, shut the engine off;
8. Start the vehicle with the dead battery;
9. Disconnect the jumper cables in reverse order given in steps 2 through 5;
10. Install protective cap on the booster block terminal.

ENGINE PROTECTION SYSTEM

The engine protection will automatically derate or stop the engine when certain engine conditions reach a critical stage.

In the event of a serious fault, the red STOP telltale light comes on and an audible alarm will sound if the engine is running.



An illuminated STOP telltale light indicates a serious problem has been detected, and the driver must respond immediately to the problem. The vehicle must be safely pulled off the road and stopped. In some instances, the engine must be switched off immediately.

AUTOMATIC ENGINE SHUTDOWN

Prior to an actual automatic shutdown, the engine will automatically derate, go to idle, and then stop as the vehicle speed gets below 2 mph (3 km/h).

The engine shutdown protection will automatically derate and stop the engine when one or more of the conditions listed below reaches a critical point:

- High engine coolant temperature
- High engine oil temperature
- Low engine oil pressure
- High crankcase pressure (rate of change)

After the automatic engine shutdown sequence, the engine may be restarted. To do so, turn the ignition switch to the OFF position during 7 seconds and then turn it back to ON. However, it will only operate for 30 seconds unless the problem is resolved.

Use this function sparingly and in order to move the vehicle to a safe parking place only. Excessive use may result in severe engine damage.

**WARNING**

Failure to take necessary action when the STOP telltale light is on can ultimately result in automatic engine derate and shutdown.

IDLE SHUTDOWN TIMER

The optional idle shutdown timer is programmed to shut down the engine after a specific engine idling time. The idling time cannot be changed by the driver but can be changed with the use of a laptop computer and Premium Tech Tool. In this case, the engine idling time can be set from 30 seconds up to 1 hour.

The engine will shut down at the set time under the following conditions:

- Vehicle speed is 0;
- Engine is running at normal idle speed;
- Engine coolant temperature above 120°F (49°C);
- Temperature inside vehicle is between 59°F (15°C) and 81°F (27°C);
- Parking brake applied;
- Transmission into neutral (N);
- Wheelchair lift system not in use;

Pressing the fuel pedal will prevent engine shutdown and restart countdown.

ENGINE BLOCK HEATER

The vehicle may be equipped with an engine immersion-type electric block heater to assist cold weather starting. A connector is on the rear pillar of the curb-side engine compartment door frame. Using an extension cord, connect to a 110 - 120 VAC outlet.

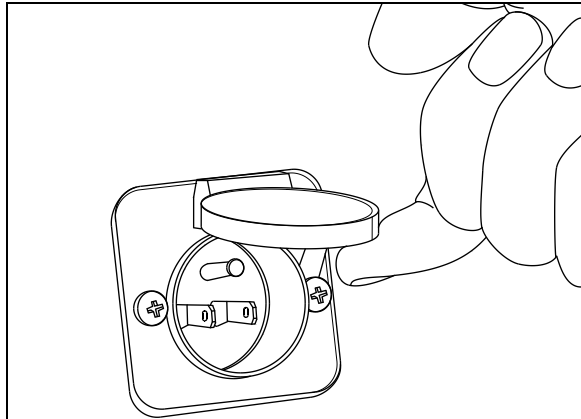

110-120 VOLTS CONNECTOR

06390



CAUTION

Connect only to a 110-120 VAC power source. Use only grounded (three prongs) extension cords with a minimum rated capacity of 15 amps. Disconnect the extension cord before starting. Before driving, make sure the extension cord is disconnected and the engine compartment door is closed.

ENGINE WARM-UP

After starting the engine, keep the parking brake applied and let the engine run at normal idle for two minutes to allow lubricating oil to reach the turbocharger. Increase engine speed to fast idle, using the FAST IDLE switch located on the dashboard for five minutes, without loading the engine. Monitor the gauges and indicator lights to make sure all conditions are normal. If an abnormal condition is observed, stop the engine immediately and have the condition corrected.



DANGER

Never let the engine run in an enclosed, non-ventilated area. Engine exhaust fumes contain dangerous gases which can be fatal if inhaled. Before warming up the engine, open the door(s) or move the vehicle outside.

NOTE

The engine will reach normal operating temperature shortly after driving. Avoid driving at full throttle until engine coolant temperature reaches 140°F (60°C).

ALLISON TRANSMISSION WARM-UP

When the transmission temperature falls below -20°F (-29°C), the CHECK TRANS telltale light illuminates after the engine is started, and a reminder tone will sound. In this case, the transmission will be locked in neutral (N) until the transmission temperature rises above -20°F (-29°C) and the CHECK TRANS telltale light goes out. The transmission will only operate in first or reverse gears until it reaches normal operating temperature.

STARTING THE VEHICLE AFTER A FIRE ALARM

The vehicle may be started after a fire alarm without resetting the system. Refer to section 7 SAFETY FEATURES AND EQUIPMENT under "Fire suppression system (AFSS)" for the complete procedure.

Safety Features and Equipment 7-1

EMERGENCY EXITS	2
SIDE WINDOWS	2
ROOF HATCH.....	2
EMERGENCY ENTRANCE DOOR OPENING	3
EMERGENCY EQUIPMENT	5
FIRE EXTINGUISHERS (2 OPTIONS).....	5
FIRST-AID KIT	5
FIRE HATCHET	5
WARNING REFLECTORS	5
JACK / TOOLS	5
SPARE PARTS KIT.....	6
FIRE SUPPRESSION SYSTEM (AFSS)	6
TIRE PRESSURE MONITORING SYSTEM (TPMS)	7
LIMP-HOME BELT	11
SPARE WHEEL	12
CHANGING A WHEEL	12
SUPER SINGLE TIRE REPLACEMENT	13
JACKING POINTS	14
HYDRAULIC JACK.....	14
TOWING THE VEHICLE	16
LIFTING AND TOWING	16
TOWING WITHOUT LIFTING.....	18
VOLVO I-SHIFT ALTERNATE TOWING MODE	18
DAYTIME RUNNING LIGHTS	19
FOG LIGHTS	19
COMPARTMENT LIGHTING	19
MUD FLAPS AND SPLASH GUARDS	19
BACK-UP CAMERA	20
BACK-UP ALARM	20
ESSENTIAL FUNCTIONS TO OPERATE THE VEHICLE (BASIC LIMP-HOME FUNCTIONS)	20
AVAILABLE FUNCTIONS.....	20

7-2 Safety Features and Equipment

EMERGENCY EXITS

Locate and learn how to use all possible emergency exits. It is good practice to inform passengers of the location of exits and how to use them in case of an emergency.

SIDE WINDOWS

Some side windows can be opened from the inside for emergency exit. A decal located on the bottom of each passenger window indicates the location of the nearest emergency exit. Also, blue lights close to the wall in the overhead storage compartments illuminate the emergency exit decals. These lights illuminate when the general lighting switch is on.

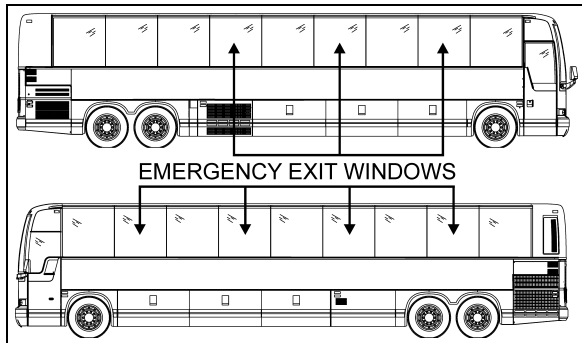

EMERGENCY EXIT WINDOWS (X3-45)

18617

To open a side window emergency exit, tilt up the release bar and push the bottom of the window outwards, as illustrated below. The window is hinged from the top and will not fall out.

A telltale light on the dashboard illuminates when a window is opened. Refer to Controls and Instruments chapter for more information.

To close the window, tilt up the release bar and pull the window back. Push down the release bar to lock shut.

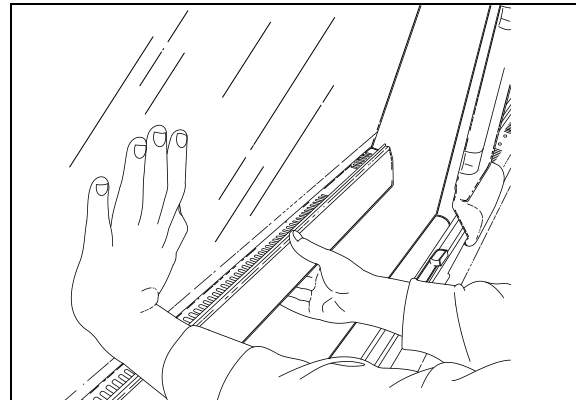

SIDE WINDOW EMERGENCY EXIT

18391

ROOF HATCH

A roof ventilation hatch, designed to be opened by occupants may be installed in the roof at the rear of the vehicle. Another optional roof hatch may be located in the front of the vehicle. The hatches can serve as emergency exits. In case of an emergency, push the ventilation hatch upwards (1). Turn knob ¼ turn (arrow pointing "TO EXIT") and then push knob to release the hatch (2). Push the escape hatch outwards (3). A decal with operating instructions is located on the hatch.

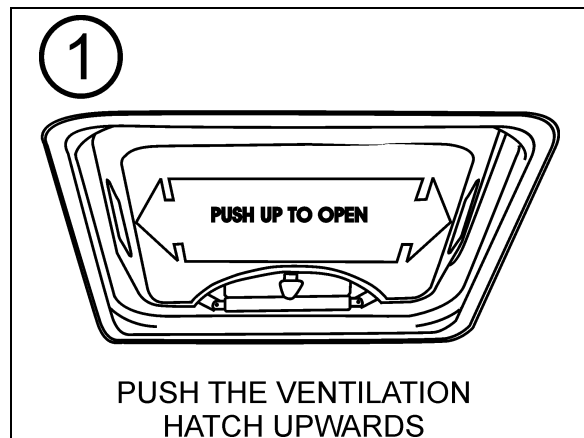

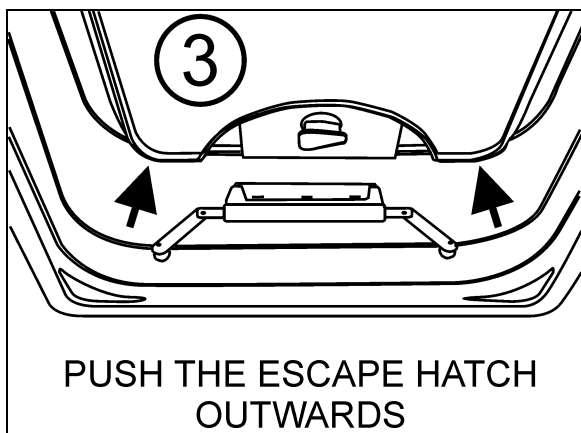
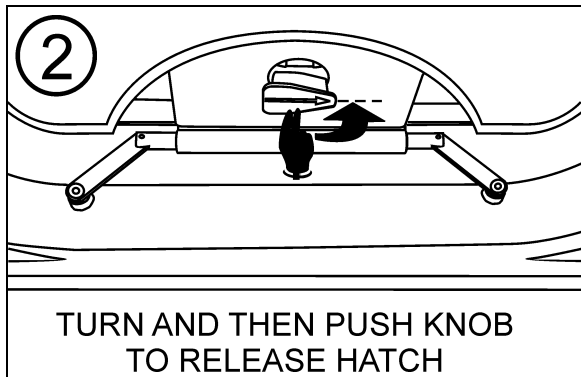

EMERGENCY ROOF ESCAPE OPENING

NOTE

In the event of ventilation blower motor failure, the roof hatch may be used to aid ventilation by pushing the hatch upwards.



CAUTION

Be aware of reduced vehicle overhead clearance when driving under overpasses with the roof hatch open.

To latch escape hatch after use, vent arms must be pushed upright in FULL OPEN VENT position. Insert edge firmly between the two sections of the bracket and then return knob to original position (arrow pointing "LATCHED") to lock the hatch. Finally, pull the hatch in to closed position, one side at a time.

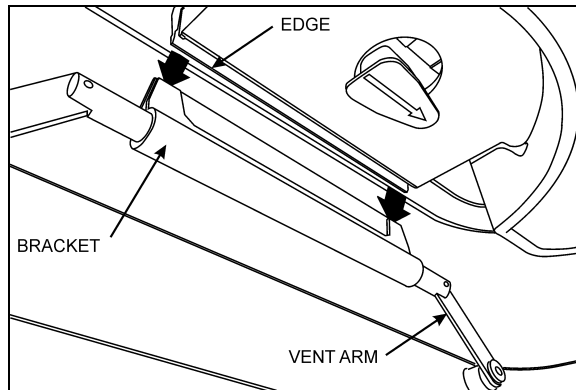

ROOF ESCAPE LATCHING

EMERGENCY ENTRANCE DOOR OPENING

An unlatch air valve located on the front wall, close to the entrance door allows emergency depletion of the door and latching cylinders. Another unlatch valve is located in the front service compartment and allows opening the door from the outside. To open the door in an emergency situation, first turn the unlatch valve in the direction of the arrows and push (or pull) the door open. To close the door after emergency opening, return the valve to its initial position, open the door using the door cylinder, then close the door normally.

NOTE

To be able to open the entrance door in an emergency situation, the entrance door must first be unlocked using the key or locking lever before unlatching the door from the outside or the inside.

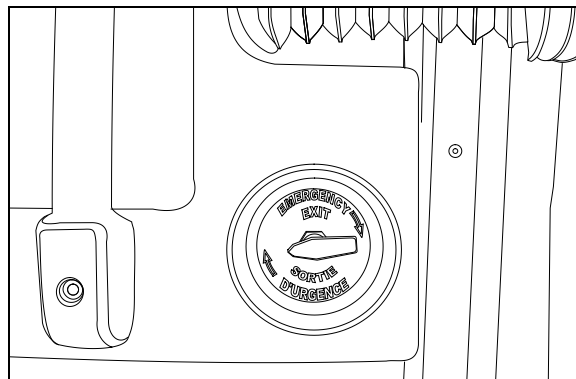

INTERIOR UNLATCH AIR VALVE

7-4 Safety Features and Equipment

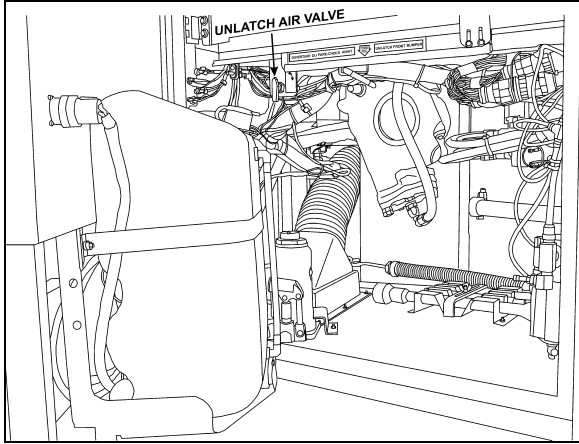

UNLATCH AIR VALVE LOCATION

12209

EMERGENCY EQUIPMENT

The coach is equipped with numerous safety features and equipment. Verify the equipment regularly and keep on-hand and in good condition at all times. Following is the enumeration and description of safety equipment found on board.

FIRE EXTINGUISHERS (2 OPTIONS)

Fire extinguishers can be found at different locations in the coach according to the owner's choice.

Under the first row seats

Depending on selected options, two fire extinguishers may be located under the first row seats. A decal at the bottom of each of the trapezoidal windows in the first row indicates the location of fire extinguishers. Instructions for use are found on the extinguishers.

 WARNING
<p>Make sure you know how to operate the fire extinguishers in case of an emergency.</p>

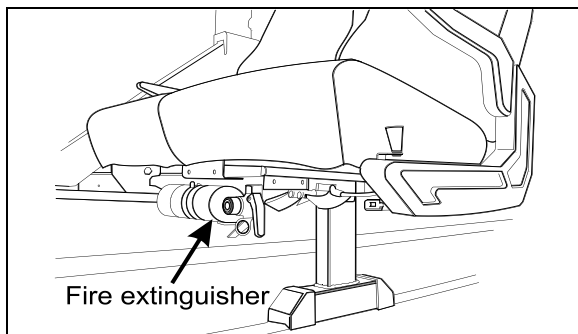

FIRE EXTINGUISHER UNDER FIRST ROW SEAT 23136

In an overhead compartment

An optional fire extinguisher can be located in an overhead compartment. A decal on the door of the compartment confirms the presence of a fire extinguisher.



A DECAL INDICATES THAT A FIRE HATCHET, A FIRE EXTINGUISHER AND A FIRST-AID KIT ARE LOCATED IN THIS OVERHEAD COMPARTMENT

FIRST-AID KIT

The optional first-aid kit is stored in the first curb-side overhead storage compartment. A white cross over red background decal identifies the kit.

FIRE HATCHET

An optional fire hatchet may be installed in the first curb-side overhead storage compartment.

WARNING REFLECTORS

A kit containing three triangular reflectors is provided to warn other drivers on the road in case of a breakdown. The kit is located at the ceiling of the first baggage compartment, on the R.H. side. The reflectors provide visible warning of an emergency situation. The three reflectors should be placed as indicated on the box cover. These reflectors comply with FMVSS 125 (Federal Motor Vehicle Safety Standards).

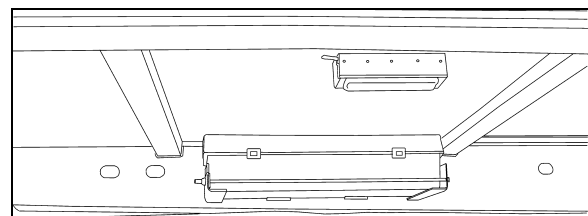

WARNING REFLECTORS LOCATION 23376

JACK / TOOLS

A kit for jacking up the vehicle and changing wheels is stored in the front service compartment. The kit includes a:

7-6 Safety Features and Equipment

- 12 ton bottle jack;
- Wheel nut wrench and lever.

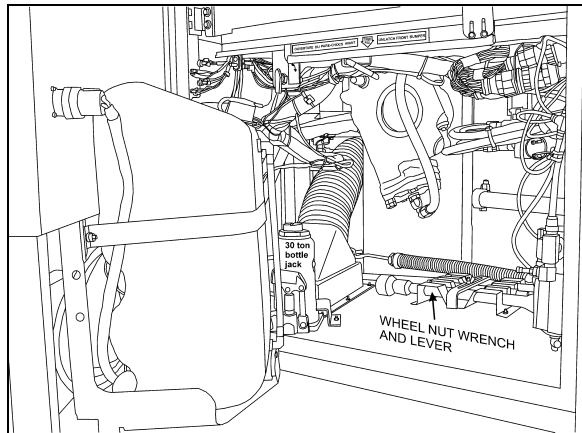

JACK/TOOLS LOCATION

23377

SPARE PARTS KIT

The vehicle may be equipped with a spare parts kit (optional). The kit contains parts such as bulbs, circuit breakers, belts, etc. The spare parts kit is stored in the first baggage compartment.

FIRE SUPPRESSION SYSTEM (AFSS)

The coach may be equipped with the optional Automatic Fire Detection and Suppression System (AFSS).

System operation

When a fire is detected inside the engine compartment, the system sends a fire alarm signal to the **Protection Panel** located in the Driver's area near the lateral control panel. The **Protection Panel** immediately turns on the fire "ALARM" lamp and sounds the audio alarm. After a 15-second time delay the engine is automatically shut down. The fire extinguisher is discharged simultaneously with engine shutdown.

NOTE

The **Manual Activation Switch** is used when immediate discharge of the fire extinguisher and engine shutdown is desired.

NOTE

The **Protection Panel** continuously monitors system integrity and displays the information via the "SYSTEM OK" and fire "TROUBLE" indicators.

Operational sequence (fire)

1. A fire detector or linear thermal detector detects a fire in the engine compartment and sends a signal to the **Protection Panel** in the driver's area.
2. The fire "ALARM" lamp on the **Protection Panel** will illuminate solid red and an audible alarm will sound.
3. The operator shall bring the vehicle to a safe stop.
4. The system automatically shuts down the vehicle engine and discharges the extinguisher into the engine compartment 15 seconds after the fire alarm starts unless advanced or delayed by the operator.
 - If the operator presses the **Manual Activation Switch**, all delays will terminate and the engine shutdown and extinguisher discharge will occur immediately.
 - If the operator presses and releases the **Delay Engine Stop** switch once, the engine shutdown and extinguisher discharge will be delayed by an additional 15 seconds.



WARNING

The engine will stop 15 seconds after the fire alarm starts. The operator must be prepared to bring the vehicle to a safe stop as soon as the alarm sounds. Steering may become difficult after engine shutdown. If more time is required, the "DELAY ENGINE STOP" switch may be pressed and released for an additional 15 second delay.



WARNING

The extinguisher discharge may cause an obscuring cloud behind and near the vehicle.

5. The red fire “ALARM” lamp and audible alarm will stay on. The yellow fire “TROUBLE” lamp will also be on indicating a discharged extinguisher.
6. The system must be reset and the fire extinguisher removed and replaced in accordance with the System Reset portion of the Kidde Dual Spectrum Operation & Maintenance Manual.

Starting the Vehicle after a Fire Alarm

The vehicle may be started after a fire alarm without resetting the system. Refer to ignition switch sequence below. This will not reset the system, rather it will instruct the vehicle’s multiplex system to ignore vehicle interface outputs from the Protection Panel. This feature is intended to be used only in emergency situations that require the vehicle to be restarted and moved a short distance prior to system reset. It should not be performed if the cause of the fire has not been clearly identified and corrected.

To start the vehicle, perform this ignition switch (key) sequence.

- From the **ON** position,
- Turn to **OFF**, return to **ON and START** vehicle within 2 seconds.

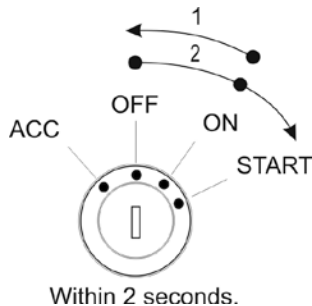

TIRE PRESSURE MONITORING SYSTEM (TPMS)

The coach may be equipped with the optional Tire Pressure Monitoring System (TPMS).

Description

System includes the following elements:

- Special tire valves;

- RF sensor inside each tire, fixed to the valve;
- 3 antennas to receive the sensors RF signal (one in the front spare tire compartment, one above the L.H. side rear wheels and one above the R.H. side rear wheels);
- A TPMS receiver connected to the antennas and located in the front electrical compartment, above the CECM;
- A TPMS display built in the L.H. dashboard panel;
- A “FLAT TIRE” telltale panel indicator.

The section of the special tire valves located inside the tire is dome-shaped to allow fixing the sensor.

Sensors provide continuous tire pressure and temperature reading.

The normal sensor battery lifespan is 5 years. The remaining lifespan is displayed as a percentage in the TPMS display.

7-8 Safety Features and Equipment

NOTE

It is recommended to check the remaining battery lifespan when changing the tires in order to replace the sensors at the same time if they are due for replacement before the next change.

The sensor's fixation screw to the valve can only be used once because the threads are powder-coated to lock the sensor in place and prevent unfastening.

The telltale panel indicator illuminates for 3 seconds when the ignition switch is turned ON to check the display operation and the communication between the display and the vehicle multiplex system. This confirms the communication between the TPMS display and CECM.

Settings Menu

- Set Wheel ID

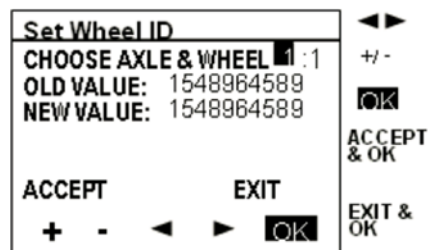
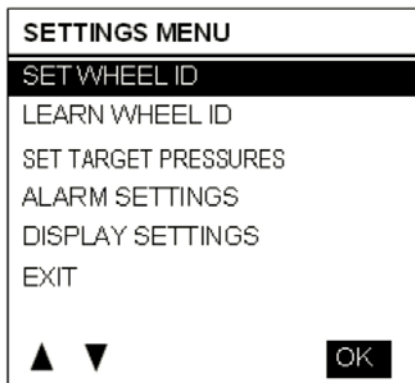

- Learn Wheel ID

This menu allows learning new wheel sensors ID. The user can learn only one wheel, several wheels or all wheels of the vehicle. The sequence automatically jumps to the next wheel such that a user can initiate all wheels without

having to come back to the display between each wheel.

The display uses a pressure change as the criteria to recognize which wheel sensor the operator wants to get assigned to a given location. The amount of pressure change required is established at 2 PSI.

A pressure change of about 3 PSI is needed to wake up a sensor and then an extra amount of pressure change of 2 PSI is needed to trigger the display. The operator has to create a pressure change by at least 6 PSI and then wait for the display to recognize the pressure change. The wait time correspond to the sensor sampling rate.

When entering the menu, the axle 1, wheel 1 is selected by default as a starting point for the learning. The user can select another axle with +/- , move the cursor to the wheel number with the right arrow and select another wheel with the +/- or move the cursor down to the start learning button.

After the start learning button is selected, the display stores the first transmission it gets from each sensor ID into the "initial pressure" for that sensor ID. Then it compares each subsequent pressures received for that sensor ID with the initial one and when the comparison shows a delta pressure exceeding the defined level required, this sensor ID is assigned to the selected tire location.

Once a wheel ID has been assigned, the display increments the number of wheels done and it moves to the next axle/wheel in the sequence, waiting for another sensor to come up with a pressure change. Within one learning session, the display remembers which sensor has been assigned and it will not assign it twice.

The sequence increments the display of the next wheel on the same axle, counting wheels from left to right, and then moves to the next axle counting axles from front to rear.

Navigate
Increase, decrease digits
Navigate forward
Overwrite "OLD VALUE"; with changes in "NEW VALUE" (sets current)
Cancel changes in Progress and exit menu

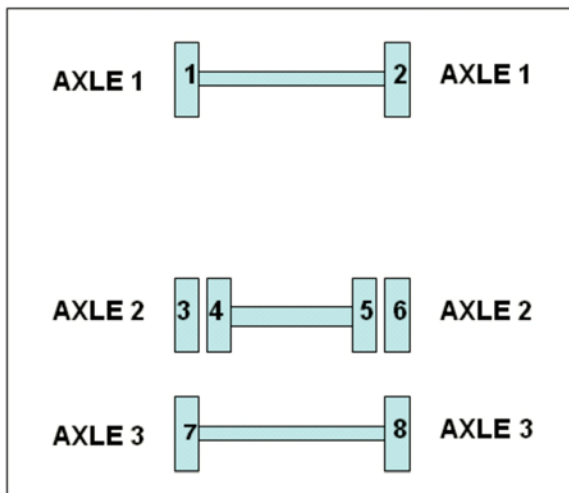

It activates the next wheel parameter each time a wheel is done. This setting is integrated with the vehicle electronic, activating an audible signal on the vehicle, thus providing a feedback to the user that he can move on to the next wheel.

The spare Tire can be done by selecting the axle/wheel “spare” which is internally encoded to 15:1.

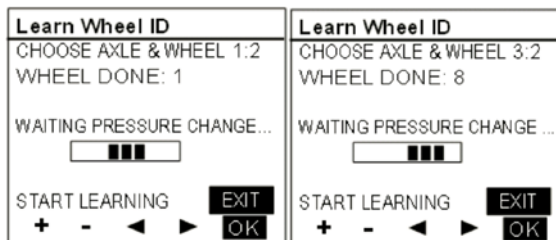
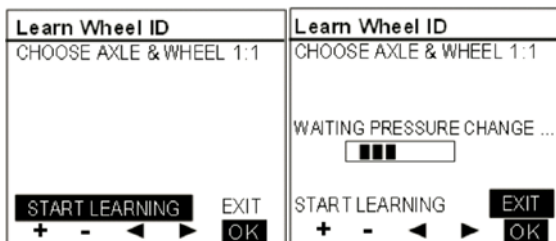
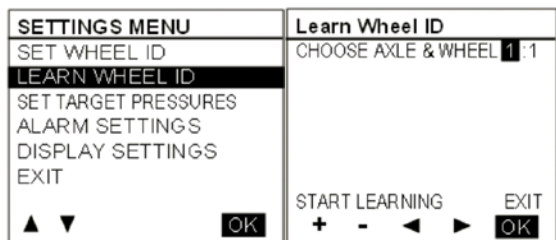

• Set Target Pressures

This menu allows the end user to fine tune the target pressure setting, taking account for the specific operating conditions (cold weather

operation or unloaded operation). The end user can readjust the target pressure within +30% and -20% of the factory set target pressure but not outside this range.

The factory set target pressure is always kept in permanent memory into the TPMS display and cannot be edited by the end user.

When the user sets a new target value, the selection can't be made outside the valid range.



• Alarm Settings

When selecting the *Alarm Settings* Menu, a sub menu containing Pressure Alarm and Temperature Alarm appears.

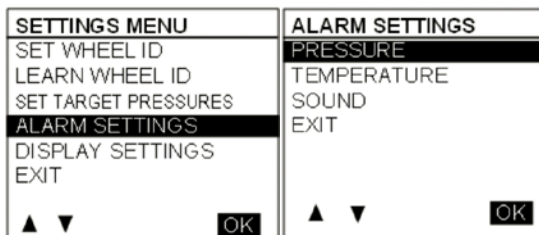

When selecting *Pressure*, the following pressure alarm screen appears. A similar screen is displayed for temperature settings. The cursor can be moved to highlight the data beside “NEW VALUE” and the “ACCEPT / EXIT” option. +/- allows increasing or decreasing the “NEW VALUE” data. Pressure alarm changes are done by steps of 1 PSI, in the range from 5 to 20 PSI. Temperature alarm is done by steps of 5°F (2°C) in the range from 150 to 180 °F (64 to 82 °C). Pressing OK with “ACCEPT” highlighted applies changes and exits to the previous menu, while pressing OK while the “EXIT” option is highlighted exits without changes.

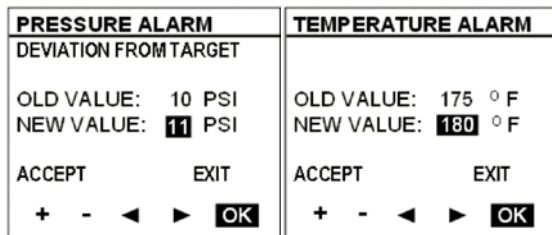

7-10 Safety Features and Equipment

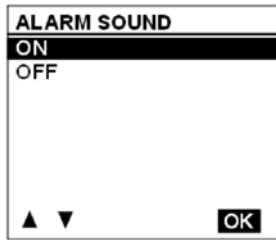

- Display Settings

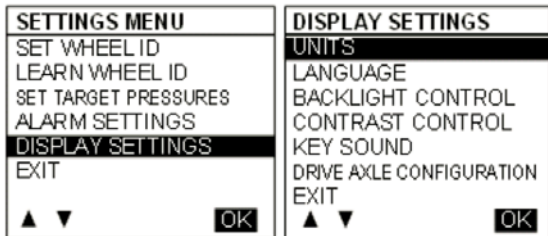

- Units
- Language

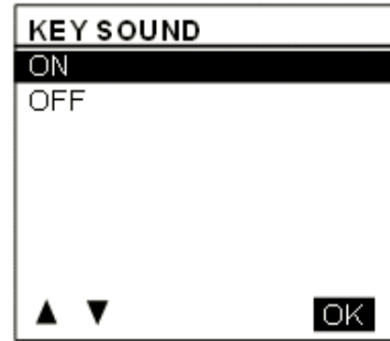
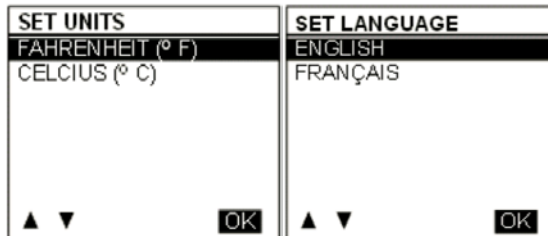

- Tire / Axle Configuration

Pressing the up / down arrows allows to select the option of 2 or 4 tires, which are the choices for the drive axle on the vehicle.

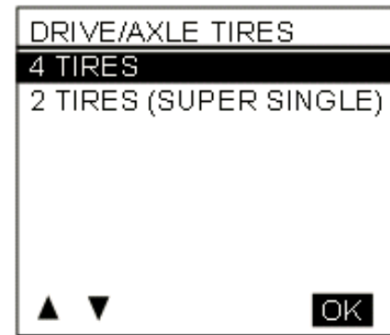

Refer to "Appendix G" for Troubleshooting Guide on Tire Pressure Monitoring System (TPMS).

- Backlight Intensity

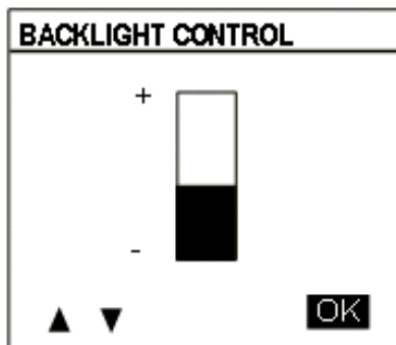

- Key Sound

Turns ON/OFF the sound of keys each time they are pressed.

LIMP-HOME BELT

In case of mechanical failure of the lower alternator, install the limp-home belt on the upper alternator. The installation of the belt allows the coach to be driven to a repair facility after only minor manipulations.

NOTE

Because of the arrangement of the alternators and the belt tensioner, a limp-home belt on the lower alternator is not possible.

Lower alternator failure:

1. Raise the belt tensioner. Use a breaker bar with a $\frac{3}{4}$ inch drive to rotate the tensioner pulley upward and relieve alternator belt tension. Remove belt;
2. Install the limp-home drive belt on the drive and top alternator pulleys first;
3. Complete installation of the limp-home belt as shown hereafter;
4. Slide the belt on the idler pulley;
5. Gently release the belt tensioner.

NOTE

To prevent the batteries from being discharged, the HVAC system will turn OFF automatically if the battery state of charge falls below 50%.

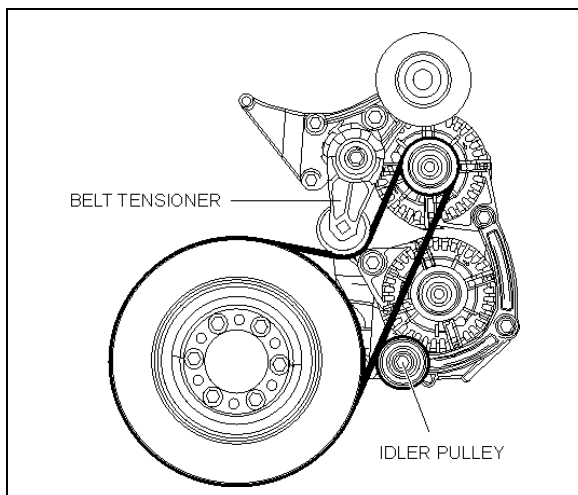

LIMP-HOME BELT ON TOP ALTERNATOR

01194

7-12 Safety Features and Equipment

SPARE WHEEL

The spare wheel and tire is located in a compartment behind the reclining front bumper.

In case of a flat tire:

- Turn ON the hazard flashers;
- Bring the coach to a stop on the side of the road;
- Apply the parking brake;
- Make sure the coach is parked safely away from traffic;
- Set up the triangular reflectors in accordance with applicable highway regulations.

CHANGING A WHEEL

To access the spare wheel, lower the front reclining bumper.

To do so, pull on the release handle located in the front electrical and service compartment.

The bumper will lower gradually. When closing the compartment, be sure the bumper is firmly in place.

NOTE

The bumper is equipped with spring hinges to allow handling by one person.

To remove the spare wheel from the compartment:

1. Loosen the screw holding the tire in place (see image).
2. Remove the wave pin and the clevis pin.
3. Pull the spare wheel out of the compartment using the strap.

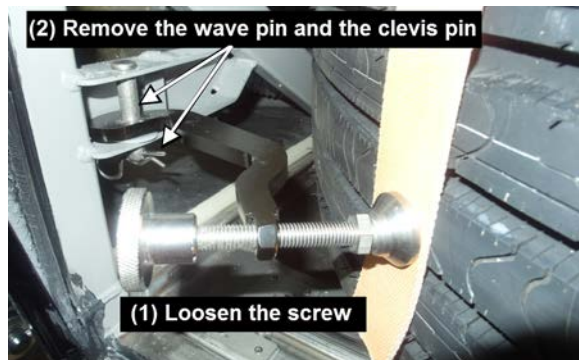

REMOVING THE SPARE WHEEL

13038

Installation of the spare wheel

NOTE

The jack and tools are located in the first baggage compartment.

1. Loosen the wheel nuts about one turn;
2. Raise the vehicle by the closest jacking point (See Jacking Points in this chapter);
3. Remove the wheel nuts and remove the wheel;
4. Mount the spare wheel over the studs, being careful not to damage the stud threads;
5. Screw in the wheel nuts according to the sequence shown in the following figure and tighten slightly more and repeat the sequence a few times to position the wheel correctly. Once tightening induces wheel spin, lower the coach for final tightening;
6. Tighten the nuts progressively in the sequence shown. Final tightening should be done using a torque wrench. Dry tightening torque is 450 – 500 lbf-ft (610 – 680 Nm) for steel as well as for aluminum wheels.



TIGHTENING SEQUENCE

13018

NOTE

Periodically check the spare tire inflation pressure. Tire pressure should be the maximum pressure specified in the chart.

NOTE

Periodically check that the spare is securely fastened in its compartment.



CAUTION

Before driving, be sure the flat tire, track, jack and tools are securely reinstalled in their respective compartments.



CAUTION

Check that the bumper is securely closed shut before driving.

SUPER SINGLE TIRE REPLACEMENT

Increase tire pressure to 125 PSI if you are using the supplied 365/70 R 22.5 spare tire to replace a super single tire on the drive axle.

In this particular configuration, spare wheel is for temporary use only.



WARNING

- Spare tire pressure should be increased to 125 PSI.
- Do not exceed 80km/h (50 MPH)
- Repair and re-install original super-single wheel and tire **as soon as possible**.
- While the spare tire is installed, avoid sharp turns, sudden acceleration and braking.

NOTE

The jack and tools are located in the front service compartment.



WARNING

Before driving, be sure the flat tire, track, jack and tools are securely reinstalled in their respective compartments. Check that the bumper is securely closed shut before driving.

JACKING POINTS

Twelve jacking points are located on the vehicle; three are located on each side of the frame and two are located under each axle. Refer to the following illustrations for the location of jacking points.

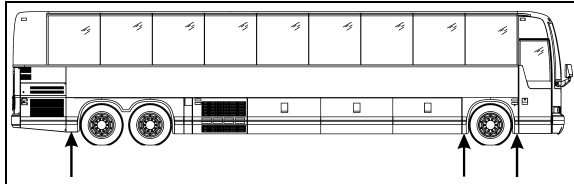

JACKING POINTS ON FRAME

18618

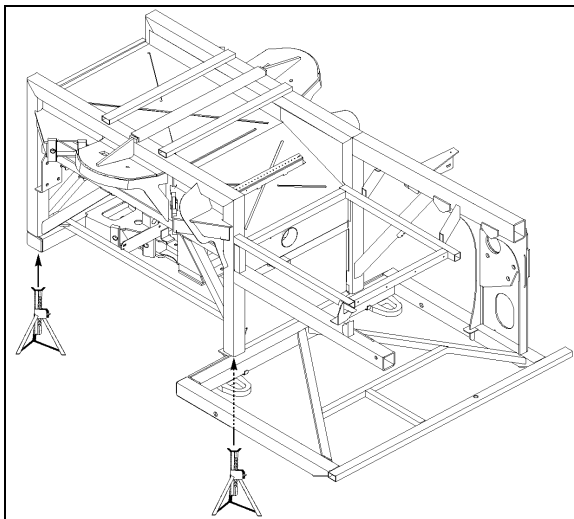

FRONT END JACKING POINTS

18592

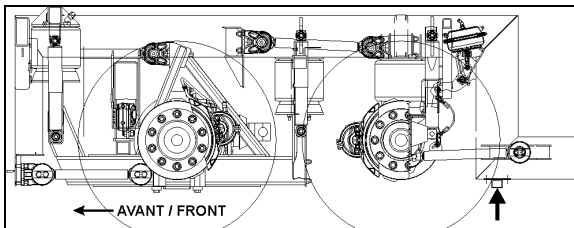

REAR END JACKING POINTS

18593



WARNING

The suspension of the vehicle must be in the normal ride position before jacking.

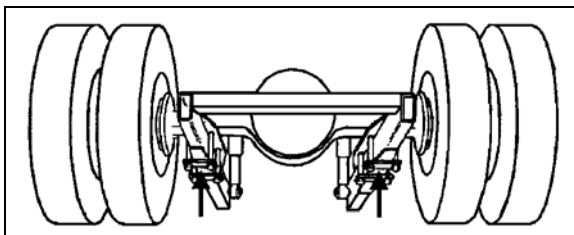

JACKING POINTS ON DRIVE AXLE

11005

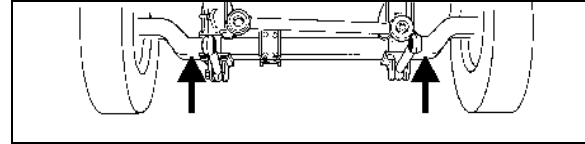

JACKING POINTS ON FRONT AXLE

10005

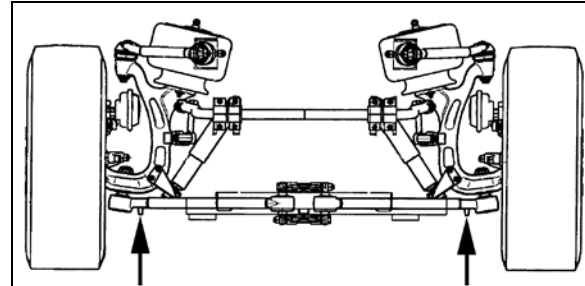

JACKING POINTS ON IND. FRONT SUSPENSION

16139



WARNING

Always unload or retract the tag axle before jacking the vehicle from the front and drive axle jacking points to prevent damage to suspension components.

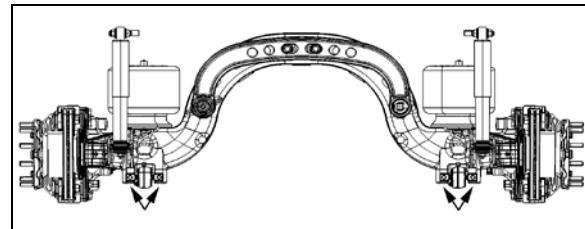

JACKING POINTS ON TAG AXLE

11029



WARNING

The jacking points on the tag axle must be used for raising the tag axle only.

Several kinds of hydraulic jacks can be used. Only jack at the specified jacking points. Jack must support the following capacities:

Front axle: 20,000 lb (9 100 kg);

Drive axle: 40,000 lb (18 200 kg).

HYDRAULIC JACK

To raise: turn release valve clockwise. Insert handle in socket and raise by pumping.

To lower: remove handle and turn the release valve slowly counterclockwise.

Always keep ram and extension screw retracted when jack is not in use.

Service: Check oil level when jack fails to raise to full height. Lower ram completely with release valve open and jack in upright position, remove filler plug and refill to level of filler hole with hydraulic jack oil. **Never use brake fluid.**



DANGER

Jack is intended for lifting only. Do not get under the vehicle or load for any reason unless it is properly supported with safety stands and securely blocked.



DANGER

Do not load jack above rated capacity. Prevent "side loading", make sure load is centered on ram. Do not push or tilt load off jack.

7-16 Safety Features and Equipment

TOWING THE VEHICLE

The vehicle can be transported on a low bed semi-trailer of adequate gross axle weight capacity. When transporting a vehicle in this manner, apply parking brake and shut down the engine. Block all wheels and secure vehicle with tie-downs. Check that overall height will clear obstacles on the route to follow, and obtain required permits.

The vehicle can also be towed by lifting the front axle or by towing from the front with all wheels on the ground. These two methods are described below under their respective headings. Whatever the method used, the vehicle should be towed by truck operators authorized and experienced in towing highway coaches.

Observe normal precautions including, but not limited to, the ones listed below when towing the vehicle:

- Make sure the parking brake is released before towing.
- Do not allow passengers to ride onboard the towed vehicle.
- Tow the vehicle at a safe speed as dictated by road and weather conditions.
- Accelerate and decelerate slowly and cautiously.



WARNING

Do not carry passengers while the coach is being towed.



CAUTION

Never tow the vehicle from the rear, as this will cause serious damage to the chassis and engine cradle. In case of damage to the drive train components, use a low bed semi-trailer to support the rear end.

LIFTING AND TOWING

The towed vehicle must be lifted from the front end only. The tow truck must be equipped with

the proper lifting equipment to reach under the front axle or the front tow eyes since no other lifting points are recommended. Lifting and towing from any other point are unauthorized as it may cause serious damage to the structure. Do not unload or raise the tag axle when lifting and towing to prevent overloading the drive axle.

1. Remove both drive axle shafts to prevent damage to the transmission. Plug axle tube to prevent oil loss. Refer to Rockwell's "Maintenance manual no.5" annexed at the end of Section 11: Rear Axle of the maintenance manual.



CAUTION

Transmission lubrication is inadequate when towing. With automatic, semi-automatic or manual transmission, the axle shafts or driveshaft must be disconnected to avoid serious damage to the transmission. Do not attempt to push or pull-start the coach.

2. If required, raise the front of the coach then install wooden blocks underneath front tires to allow lifting equipment to reach under the front axle.



Tow eyes as lifting point

- a) Use the tow eyes fixed to the vehicle frame between the front axle and the front bumper.

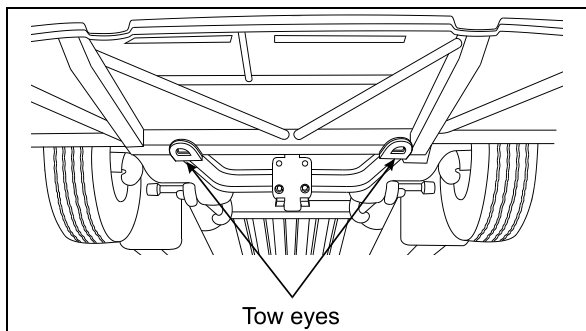

TOW EYES UNDER VEHICLE 18401

- b) Install axle forks onto tow bar, position axle forks around beam and into tow eyes.



ADEQUATELY SECURE THE TOW EYES TO THE TOW TRUCK LIFTING ATTACHMENT WITH CHAINS



AXLE FORK

Front axle as lifting point

- a) Use axle forks and lift the vehicle from under the front axle, and adequately secure the axle onto the tow truck lifting attachment with chains.



LIFTING FROM UNDER THE FRONT AXLE

- 3. Operate the engine when towing to maintain brake system air pressure. If the engine cannot be operated, connect an external air pressure line from the tow truck to the emergency air system fill valve or coupling located close to the engine air filter. The accessories air tank fill valve in the front service compartment does not supply air pressure to the brake system. The air pressure must be a minimum of 75 psi (520 kPa), and the line should be attached to the air line with a clip-on chuck.



EMERGENCY AIR SYSTEM FILL VALVE AND COUPLING

- 4. Observe safety precautions when towing.



CAUTION

Do not tow the vehicle without external air pressure applied to the emergency fill valve if the engine does not operate. Without brake system air pressure, the brakes may apply automatically if system air drops below 40 psi (275 kPa). If failure prevents releasing the parking brakes with air pressure, disengage the parking brakes mechanically.

7-18 Safety Features and Equipment



CAUTION

Make sure a safe distance is kept between the front of the coach and the tow truck. This space ensures that coach does not suffer damages when being towed.



CAUTION

Make sure axle shafts or driveshaft are installed correctly after towing. Tighten axle shaft and driveshaft nuts to the correct torque settings. Do not invert shafts.

TOWING WITHOUT LIFTING



CAUTION

When towing vehicle without lifting, use only a tow truck with a solid link tow bar and related equipment. All other means of towing are unauthorized. Tow only from the front of the vehicle.

1. Remove both drive axle shafts to prevent damage to the transmission. Plug axle tube to prevent oil loss. Refer to Rockwell's "Maintenance manual no.5" annexed at the end of Section 11: Rear Axle of the maintenance manual.



CAUTION

Transmission lubrication is inadequate when towing. With automatic, semi-automatic or manual transmission, the axle shafts or driveshaft must be disconnected to avoid serious damage to the transmission. Do not attempt to push or pull-start the coach.

2. Operate the engine when towing to maintain brake system air pressure. If the engine cannot be operated, connect an external air pressure line from the tow truck to the emergency fill valve in the engine R.H. side compartment. The emergency fill valve in the front service compartment does not supply air pressure to the brake system. The air pressure must be a minimum of 75 psi (520 kPa), and the line should be attached to the air line with a clip-on chuck.



CAUTION

Do not tow the vehicle without external air pressure applied to the emergency fill valve if the engine does not operate. Without brake system air pressure, the brakes may apply automatically if system air drops below 40 psi (275 kPa). If failure prevents releasing the parking brakes with air pressure, disengage the parking brakes mechanically.

3. Position the tow truck so that the tow bar contacts the front bumper of the vehicle.
4. Attach the tow truck chains only in the tow eyes of the vehicle and take up all the slack.
5. Use a safety chain as applicable.
6. Observe safety precautions when towing.

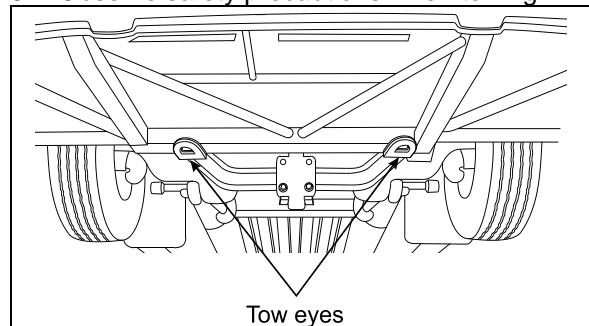

TOW EYES UNDER VEHICLE

18401



CAUTION

Make sure axle shafts or driveshaft are installed correctly after towing. Tighten axle shaft and driveshaft nuts to the correct torque settings. Do not invert shafts.

VOLVO I-SHIFT ALTERNATE TOWING MODE

If the standard towing procedure can't be followed due to road condition or local road

regulations (tunnels, bridges, etc), follow the alternate procedure described below.

 CAUTION
<p>This procedure applies only to coaches with D series Volvo I-Shift transmissions (AMT-D) provided with alternate towing mode software.</p> <p>Forward towing only! <u>Reverse towing (backing-up)</u> is not allowed with this procedure or damage to the gearbox will occur.</p>

 CAUTION
<p>This procedure should not be used in replacement of the standard towing procedure.</p> <p>This procedure does not have any indicator, therefore, if any of the steps below are not fulfilled, transmission damage may occur.</p>

Applying the procedure will allow tow mode to be activated and vehicle to be towed without the removal of the driveshaft for whatever distance the vehicle needs to be towed.

Towing gear **3 HR** will be engaged if conditions below are fulfilled in the following sequence:

- A. Ignition key must be in the "ON" position
- B. Engine not running
- C. Adequate air pressure to the gearbox/
Vehicle must have electrical power
- D. Shift pad must be in neutral
- E. Vehicle must be towed **FORWARD** only

DAYTIME RUNNING LIGHTS

The inner lamps only also called high beams illuminate automatically when the engine is started and the parking brake is released to serve as daytime running lights. The daytime running lights provide added safety by making the traveling vehicle more visible to other drivers during the day.

The daytime running lights system turns the headlights on when:

- Engine is running;
- Parking brake is released;

- The exterior lighting switch is set to the OFF position or pressed to the first position.

 WARNING
<p>Do not drive with only the daytime running lights at night because the tail and marker lights are not turned on in that situation and the high beams can blind other drivers. For night driving, turn ON the headlights by depressing the exterior lighting rocker switch to the second position.</p>

FOG LIGHTS

Optional halogen fog lights are available. They provide better visibility in fog and precipitation. They improve visibility immediately in front of the vehicle. They also provide added safety.

<i>NOTE</i>
<p><i>Some states or provinces may restrict the use of fog lights. Verify local state or provincial regulations before using.</i></p>

COMPARTMENT LIGHTING

Baggage compartments and front service compartment lights are automatically turned ON when the corresponding compartment door is opened. A pictogram will appear on the status bar of the Driver Information Display (DID) when the baggage compartment door is open.

MUD FLAPS AND SPLASH GUARDS

Mud flaps are installed behind each front and tag axle wheel in order to minimize dirt on the lower panels of the vehicle and prevent stones and debris from being thrown at vehicles traveling behind the vehicle. Mud flaps are also installed on front of each front axle wheel to reduce water splash on rear-view mirrors. Splash guards may be installed behind each dual wheel of the drive axle to prevent stone projectiles from being thrown at the tag axle wheels.

BACK-UP CAMERA

An optional back-up camera is available which provides the driver with visual assistance when backing-up. The monitor may be mounted on the left side pillar. It switches *ON* automatically when the transmission is in the reverse (R) range.

BACK-UP ALARM

The back-up alarm alerts pedestrians and other drivers when the vehicle is being backed-up. Take extra precautions whenever backing-up. If necessary, use a guide to provide directions when backing-up. Both the alarm and optional camera are automatically activated when the transmission is put in the reverse (R) range.

ESSENTIAL FUNCTIONS TO OPERATE THE VEHICLE (BASIC LIMP-HOME FUNCTIONS)

Even with a defective CECM (Chassis Electronic Control Module) or a CAN network problem, essential base functions are maintained to rear start the vehicle from the engine compartment and drive in a secure manner.

AVAILABLE FUNCTIONS

- Startup: Turn on the ignition in the driver's area and rear start the vehicle from the engine compartment,
- Opening the door: Functions normally,
- Closing the door: Manually pull on the door and it will lock automatically,
- Windshield wipers: Wipers functions at 1st speed only,
- Headlights: Low beams only,
- Directional signals: Rear and front only,
- Stoplights: 2 upper stoplights + high-mounted stoplight are functional,
- HVAC: Functional with set point fixed at 70°F (22°C), evaporator and condenser fixed at speed 1, defroster fixed at speed 4.



CAUTION

The following directives must be followed.

- Never connect a battery charger when the ignition is at the ON position on a vehicle with a CAN defective or certain functions will start up by themselves,
- Disconnect the charger before starting the vehicle, if not the default functions will not activate,
- If the default mode does not activate, try to turn the ignition OFF while ensuring that no charger is connected and then restart the vehicle.

CLEANING.....	3
SEAT UPHOLSTERY	3
PLASTIC AND VINYL.....	4
WINDOWS.....	4
STAINLESS STEEL	4
HIGH PRESSURE LAMINATE	4
CARPET.....	4
RUBBER COMPONENTS	4
FLOOR CLEANING.....	4
EXTERIOR SURFACES.....	4
WINDSHIELD.....	5
LAVATORY MAINTENANCE	5
FILLING THE SUMP TANK.....	5
DRAINING THE SUMP TANK	5
FLUID LEVEL VERIFICATION.....	6
ENGINE OIL LEVEL.....	6
TRANSMISSION OIL LEVEL	7
POWER STEERING FLUID LEVEL	8
DRIVE AXLE WHEEL BEARING OIL LEVEL	9
FRONT AND TAG AXLE WHEEL HUBS	9
COOLANT FLUID LEVEL.....	9
WINDSHIELD WASHER & HEADLIGHTS WASHER RESERVOIRS	10
OTHER VERIFICATIONS.....	10
AIR TANK PURGE	10
FIRE EXTINGUISHER (S).....	11
PRIMARY FUEL FILTER.....	11
A/C COMPRESSOR BELTS	11
ALTERNATOR DRIVE BELTS	12
BACK-UP CAMERA	12
AIR FILTER RESTRICTION INDICATOR	12
A/C AND HEATING SYSTEM AIR FILTERS.....	12
HOSE INSPECTION	13
LUBRICATION	14
WHEELS AND TIRES	14
WHEEL BEARINGS.....	15
SERVICE BRAKE TEST.....	15
PARKING BRAKE TEST	15
EXTERIOR LIGHTING VERIFICATION	16
FIRST SERVICE ON NEW VEHICLE.....	18

8-2 Care and Maintenance

ENGINE OIL.....	18
COOLANT SYSTEM FILTER	18
GENERAL RECOMMENDATIONS	18
WALK-AROUND INSPECTION (BEFORE EVERY TRIP).....	21

CLEANING

The cleaning information provided in this section is regarded as recommended cleaning practices. Cleaning results may vary depending on the condition of the stain. Always clean stains promptly for best results.

NOTE

Use only approved cleaning products such as Prevost A.P.C., all purpose cleaner (Prevost # 683664). Never use stain protection products on new fabrics. To prevent permanent staining of fabrics, clean stains soon after they occur. Incorrect treatment of stains can worsen them. Get help from a cleaning specialist to remove stubborn stains.



CAUTION

Custom fabrics and materials may require different cleaning and maintenance practices. Consult your supplier.

SEAT UPHOLSTERY

Firmly beat the fabric with a blunt object, such as a wooden paddle, to release dust and dirt. Vacuum the seat fabric in the direction of the stitching using an upholstery nozzle.

NOTE

The abrasive nature of dirt and grit will reduce upholstery life expectancy. Vacuum regularly.

Removal Of Stains And Marks

Depending on the nature of the stain, apply one of the two methods explained below to remove stains and marks on wool plush.

Method One:

1. Apply a nonflammable solvent to stained area with a clean, white absorbent rag;
2. Clean stain by starting at the outer edges of the stain and working in toward the center;
3. Blot affected area frequently with a clean, dry absorbent cloth to prevent stain rings caused by excess solvent.



WARNING

Use solvents in a well ventilated area. Open all windows and doors.

Method Two

1. Wet the stain with a solution of household detergent and lukewarm water. Do not soak the stain;
2. Rub the stain with a damp cloth;
3. Rinse cloth after each application.



CAUTION

Do not use soap, soap powder, ammonia, soda, bleach or cleaning products containing any of these compounds.

Beverage Stains

Remove beverage stains by following method one. If stain persists, repeat method one using methylated spirits instead of solvent.

Alcoholic Beverage Stains

Remove alcoholic beverage stains by wetting the stain with water, then cleaning following method two.

Burns

Scrape burnt area using a knife or razor blade then clean following method two. Consult an upholstery specialist when dealing with extensive burns.

Cosmetic Stains

Remove stains left by cosmetics by following method one then method two.

Ink Stains

Remove ink stains following method two. If stain persists, apply a warm oxalic acid solution. Rinse with water.

Blood, Urine Or Vomit Stains

Remove such stains by following method two.

Copying Ink - Ball-Point Pen Ink

Treat with methylated spirits, blotting frequently to avoid spreading stain, followed by method two.

8-4 Care and Maintenance

Marking Ink (Felt-tip Pens)

Treat with Methyl-Ethyl-Ketone (MEK) followed by method two.

Oil, Grease And Paint

Remove excess using a knife. Treat with method one followed by method two. If stain persists, repeat procedure.

Rust Stains

Remove rust stains by following method two. Apply a warm oxalic acid solution to stained area. Rinse with water.

Tar

Soften tar with benzene, then treat using method one followed by method two.

Chewing Gum

Soften gum with cyclohexane. Carefully scrape off stains using a sharp knife or razor blade.

PLASTIC AND VINYL

Clean plastic and vinyl trim using a clean damp cloth or sponge. For vinyl trim marks, use a lukewarm all purpose cleaner or a mild saddle soap. Remove water spots and soap traces using a clean damp cloth or sponge. Dry with a clean soft cloth.

Remove grease, tar or oil stains with a clean cloth or sponge and an all purpose or solvent-type vinyl cleaner.

Apply a colorless vinyl or leather protective product to maintain the luster and pliability of the plastic or vinyl surface.

WINDOWS

Clean the inside of the windows with a solution of one part vinegar to ten parts water.

STAINLESS STEEL

Use a stainless steel cleaner and follow the manufacturer's instructions. Stainless steel cleaning solution may be ordered from Prevost Car Inc. quoting part number 68-0356.

HIGH PRESSURE LAMINATE

Remove stains on laminated surfaces with a household detergent, methylated spirits or

mineral turps. Clean with a mild liquid abrasive and water solution if stain persists.

CARPET

Vacuum carpets regularly to prolong carpet life.

RUBBER COMPONENTS

Use only pure water or glycerin to clean stains on rubber components.



CAUTION

Never use solvents on rubber components.

FLOOR CLEANING

Clean vinyl floors with a quality nonionic detergent cleaner. Follow the manufacturer's recommendations for cleaning.

Remove any excess detergent solution using a wet/dry vacuum or mop. Rinse floor with a solution of one part Clorox to ten parts warm water.

Polish dry floor using a high-speed buffer and a smooth red 3-M polishing pad.

Mop floor periodically with a solution of 5 per cent Clorox in warm water.

NOTE

For custom or special floor covering materials, consult the manufacturer or your converter for information on how to clean and maintain these types of floors.

EXTERIOR SURFACES

Frequent washing and waxing of the vehicle exterior will help protect the finish and luster. The paint finish is attacked by the abrasive effects of airborne particles and corrosive pollutants.

Before washing the exterior of the vehicle, close the fresh air dampers using the "REC" button located on HVAC control panel and on the air intake duct in the evaporator compartment. Install keyhole protectors to prevent water from penetrating. Rinse vehicle with water to remove all loose dirt. Wash vehicle using a quality brand car wash soap. Follow manufacturer's recommendations for cleaning. Rinse well with water.

The vehicle exterior should be cleaned, waxed and buffed when water droplets no longer form on the painted surfaces.

 CAUTION
Hot water can damage paint. Keep water cool or lukewarm.

 CAUTION
<ul style="list-style-type: none"> • Make sure cleaning solutions are not harmful to painted surfaces. Read the manufacturer's instructions before using. • Do not spray water jet directly into fresh air inlet dampers.

To prevent corrosion, remove caked-on dirt and road salt from the vehicle underbody using a high pressure water jet. Clean wheel housings, bumpers, muffler, tailpipe and brackets.

Carry out corrosion prevention cleaning at least twice a year. Spray underneath of the vehicle and let soak before cleaning. Let engine and exhaust system cool down before cleaning.

Tar Or Oil

Remove tar or oil as soon as possible with an approved automotive tar and oil remover or turpentine. Thoroughly clean area with car wash soap and water. Let dry, then wax.

Insects

Remove insect stains as soon as possible with lukewarm soap and water or insect remover.

Tree Sap

Remove tree sap or bird droppings with lukewarm soap and water. Do not allow to harden.

WINDSHIELD

To prevent windshield wiper streaking, keep silicone sprays away from windshield. Remove road film and wax build-up from windows with lukewarm soap and water or with an alcohol-based cleaning agent. If a chamois is used to dry and polish glass, use it exclusively for that purpose.

Wiper Blades

To avoid tearing frozen wiper blades, loosen them before removing. Remove and clean wiper blades periodically with an alcohol-based cleaning solution. Clean wiper blades using a sponge or soft cloth.

LAVATORY MAINTENANCE

Flush water in the lavatory is recirculated from the sump tank. When the sump tank water is too soiled to be recirculated, the driver can dump it into a suitable dump location.

Routine draining and filling of lavatory tanks should be performed by maintenance personnel only, and should be done before parking the coach overnight in freezing temperature.

FILLING THE SUMP TANK

Open the sump tank overflow valve (A) and connect a fresh water supply hose to the toilet sump tank fill connection (D). The sump tank is full when water starts flowing through the clear fill process overflow tube (C). Close sump tank overflow valve (A) when the tank is full and drain fresh water fill tube using drain valve (B) to avoid ice damage during cold weather operation.

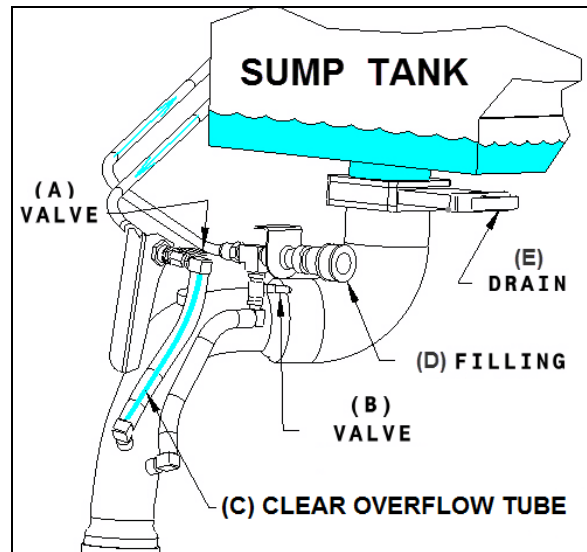

DRAINING THE SUMP TANK

When recirculating water in the toilet is soiled, drain sump tank. Pull the drain slide valve handle (E) and allow contents to drain. Flush tank with clean water. To close, push the slide valve (E) back into closed position.

8-6 Care and Maintenance



CAUTION

Lavatory tanks should be serviced only at suitably equipped stations.

NOTE

It is unlawful to dump sump tank contents in any location other than those designated as such.

When a thorough tank draining is required, clean sump tank by repeating the draining and filling operations several times. Close valves and drop in a packet of commercial toilet deodorant (Prevost part #900329) in toilet before starting final filling of the sump tank.



WARNING

The toilet deodorant contains compounds which can be very irritating to skin. Use rubber gloves when handling and then clean toilet seat.



CAUTION

When cold weather is expected, sump tank must be drained if the coach is parked overnight or for an extended period of time.

NOTE

Due to the heat it produces, there is less risk of freezing in the tanks when the engine is operating.

NOTE

New coaches are delivered with the sump tank empty. Fill with water before putting the coach in service.

FLUID LEVEL VERIFICATION

Periodic inspection of oil and fluids levels is the most economical and easiest way to help your vehicle perform at its best. Rigorous oil level inspection and replacement will greatly help minimize expensive and unscheduled repairs.

ENGINE OIL LEVEL

Check engine oil level when engine is still warm and with vehicle parked on a level surface. Shut **OFF** engine and wait at least 10 minutes for oil

to drain into oil pan before checking. Check engine oil level daily or before each trip. Add oil as required. Do not overfill. Remove dipstick, wipe clean and fully reinsert to ensure an accurate reading. Remove dipstick and check engine oil level.

Do not let the oil level fall below the marking on the dipstick. **Do not** overfill so the level is above the upper marking on the dipstick. Add oil through the oil filler pipe as required in order to maintain level within the safe range

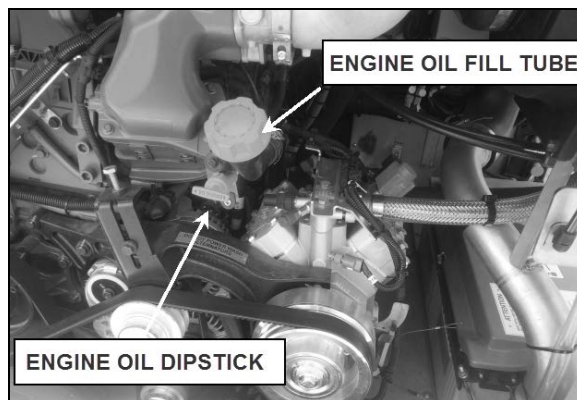

ENGINE OIL DIPSTICK - VOLVO D13 ENGINE 01192_2

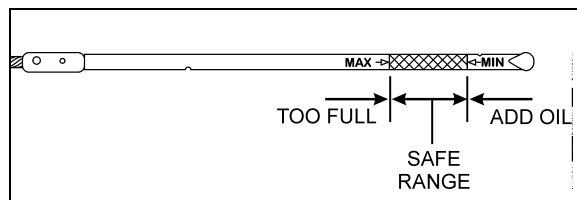

VOLVO D13 ENGINE OIL LEVEL DIPSTICK 01195

TRANSMISSION OIL LEVEL**DANGER**

To prevent personal injury, do not service transmission wearing loose clothing. Stand clear of the engine and rotating components while checking the oil level.

**CAUTION**

Do not mix fluid types or brands because of possible incompatibility.

**CAUTION**

Use clean fluid and containers when filling transmission. Never use containers that have contained water or anti-freeze (Glycol).

Allison Automatic Transmission Oil Level

Transmission fluid level may be checked using dipstick or transmission control pad display. For more information on how to use the shift selector display to check the transmission oil level, refer to Appendix C under "Allison transmission oil level check using the pushbutton shift selector" in this manual.

The transmission fluid level dipstick is accessible through the engine compartment rear door and is located on the left side of the engine.

To check the transmission fluid level, a "cold check" and a "hot check" must be performed. A cold check must be made when the transmission fluid is between 60°F and 120°F (16°C and 50°C).

NOTE

Perform the cold check first to verify the transmission fluid level before performing the hot check.

To prevent dirt and foreign matter from entering the transmission, clean the end of the oil fill tube before removing dipstick. To remove dipstick, unscrew filler cap approximately three turns and pull out dipstick.



ENGINE L. H. SIDE

01189_2

- **Cold Check**

Run the engine until the transmission fluid temperature is between 60°F and 120°F (16°C and 50°C). With the engine idling, make sure the parking brake is applied and the transmission is in neutral (N). Remove and wipe the dipstick with a clean cloth. Check oil level. If the oil level is within the COLD RUN band, the oil level is correct and a hot check can be performed. If the oil level is on or below the lower line of the COLD RUN band, add oil until the level lies within the COLD RUN band. If the oil level is above the COLD RUN band, drain oil until the level is within the band.

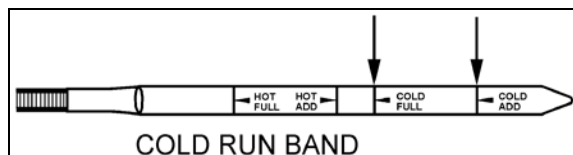

TRANSMISSION FLUID LEVEL DIPSTICK (TYPICAL) 07050

**CAUTION**

The oil level rises as oil temperature rises. Do not add oil above the "cold run" band before the transmission reaches 180°F to 220°F (82°C to 104°C).

- **Hot Check**

Make sure the transmission fluid temperature is between 180°F and 220°F (82°C and 104°C) before performing the hot check. Run the engine between 1,000 and 1,200 RPM for approximately one minute to purge air from the system. With the engine idling and the parking brake applied, shift transmission from forward (D) to reverse (R) and back into neutral (N) to fill clutch cavities with oil. Remove and clean dipstick, then check

8-8 Care and Maintenance

oil level. If the oil level is on or under the lower HOT RUN line, add just enough oil to bring up the level to the middle of the HOT RUN band.

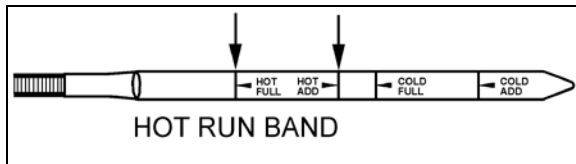

TRANSMISSION FLUID LEVEL DIPSTICK (TYPICAL) 07049

Replace dipstick and tighten the filler tube cap until the rubber seal is correctly seated.



CAUTION

Do not overfill transmission fluid reservoir. Severe damage may result.

I-Shift Transmission Oil Level

Check the transmission oil level at each service interval. Park the vehicle on a level surface. Check the oil level through the sight glass on the side of the transmission. Add oil as necessary. Only use VOLVO-approved synthetic transmission oil in the I-Shift transmission. Refer to section 24 of the Maintenance Manual for more information about oils approved by Volvo;

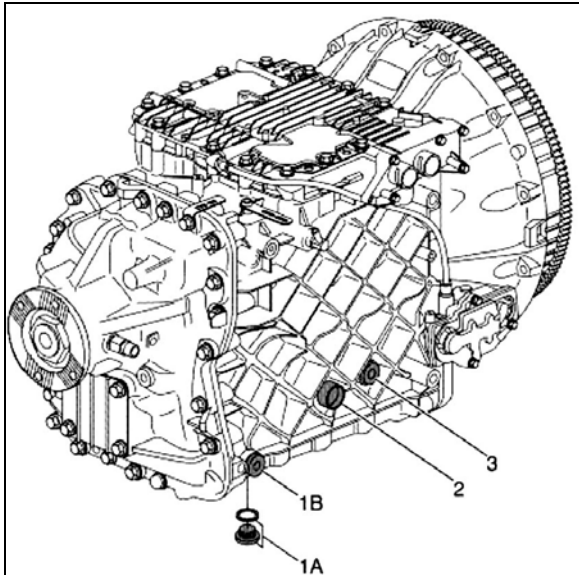

I-SHIFT TRANSMISSION OIL CHANGE

- Vehicle should be on horizontal ground when oil is changed;
- Do not check oil level straight after a journey (incorrect measurement). Undertake the check once the transmission oil has cooled down (lower than 104°F or 40 °C);

- Check oil level using transmission sight glass (2) ;

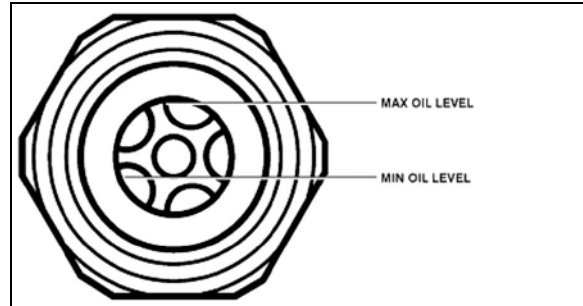

FIGURE 1: SIGHT GLASS FOR CHECKING OIL LEVEL

- Add oil through the oil filling point if necessary (3) ;
- Torque tighten fill plug to 26±4 Lb-Ft (35±5 Nm).

POWER STEERING FLUID LEVEL

The coach is equipped with a power steering system. The hydraulic fluid tank is located in the engine compartment behind the engine air intake pipe and above the alternators.

Check fluid level as follows:

1. Stop engine, open engine compartment doors and place rear start switch to *OFF* position;
2. Unscrew and remove the dipstick located on top of the fluid tank and wipe with a clean rag;
3. Replace dipstick in tank, then remove to check fluid level;
4. Add hydraulic fluid until it reaches the *FULL* mark on the dipstick;
5. Replace and tighten dipstick;
6. Place engine rear start switch to *NORMAL* position. Close engine compartment doors.

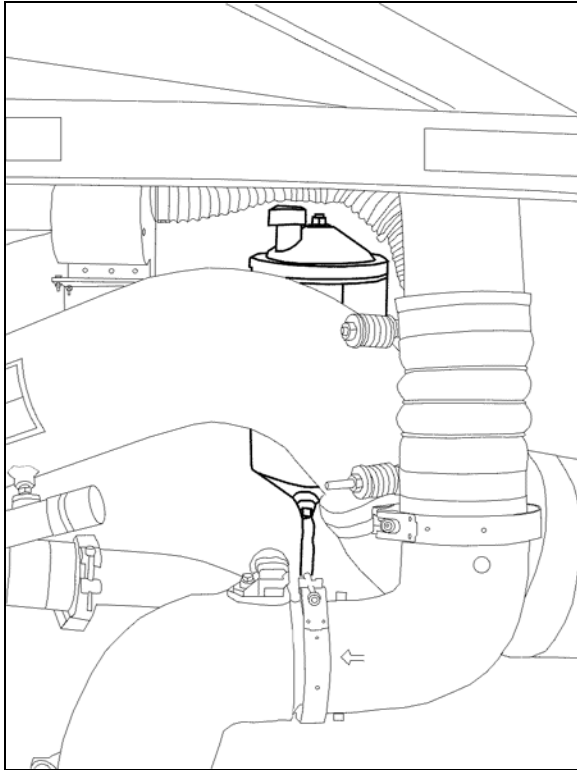

ENGINE COMPARTMENT

14059_1

DRIVE AXLE WHEEL BEARING OIL LEVEL

Drive axle wheel bearings are lubricated by the differential oil. Maintain differential oil at correct level to ensure adequate lubrication of drive axle wheel bearings at all times.

FRONT AND TAG AXLE WHEEL HUBS

The unitized hub bearings used on the NDS range of axles, are non-serviceable items. Bearings are pre-adjusted, lubricated and have seals fitted as part of the manufacturing process. The bearings are greased for life and there is no need or facility for re-lubrication.

COOLANT FLUID LEVEL

The coolant system has two tanks; the surge tank (A) and the recovery tank (B).

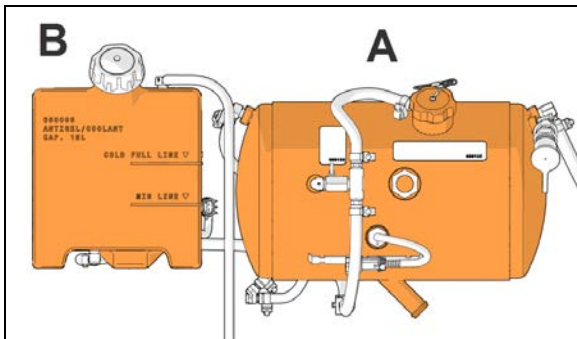

Check the coolant level into the recovery tank (B) when the engine is cold (room or ambient temperature).

- If the coolant level into the recovery tank is lower than the MIN LINE, use the recovery tank filler cap to add coolant until reaching the FULL LINE.

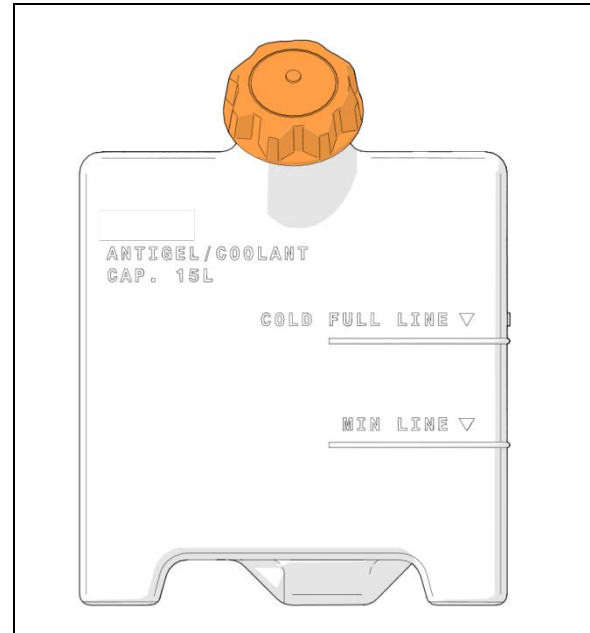

Fill the recovery tank with the same 50/50 water-antifreeze mixture already in the cooling system. **Do not** mix two different types of coolant. Refer to the Maintenance Manual for proper coolant type specifications or see the label affixed near the coolant surge tank on the vehicle.

Level switches

Both tanks are equipped with a level switch. A message (pictogram) will appear on the cluster according to which switch is activated.

The table below shows the pictograms and the description.

PICTOGRAM	DESCRIPTION
CHECK ENGINE COOLANT LEVEL AT NEXT STOP	Low engine coolant level Warns the driver that the engine coolant level has reached the recovery tank low level switch. Add coolant whenever possible. Use recovery tank filler cap.

8-10 Care and Maintenance

ENGINE COOLANT LEVEL CRITICALLY LOW	Critically low coolant level Warns the driver that the engine coolant level has reached the surge tank low level switch. Stop and add coolant. Use recovery tank filler cap.
--	---

Level from the level switches does not match with the level lines on the recovery tank.

 **WARNING**

Allow engine to cool down before adding coolant. There is no pressure into the recovery tank. If necessary, use the valve attached to the surge tank to release the pressure into the surge tank and the cooling system. Close the valve after releasing the pressure.

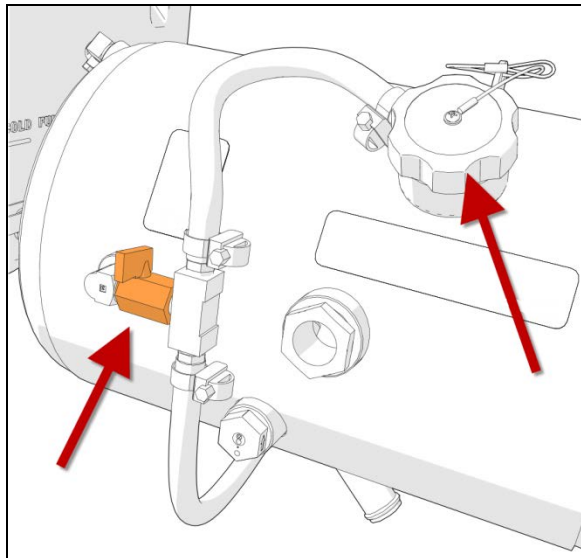

WINDSHIELD WASHER & HEADLIGHTS WASHER RESERVOIRS

The windshield washer reservoir and headlights washer reservoir are located in the front service compartment door. The windshield washer reservoir has a capacity of 5.3 US gallons (20 liters) while the headlights washer reservoir has a capacity of 2.6 US gallons (10 liters). Check fluid level regularly.

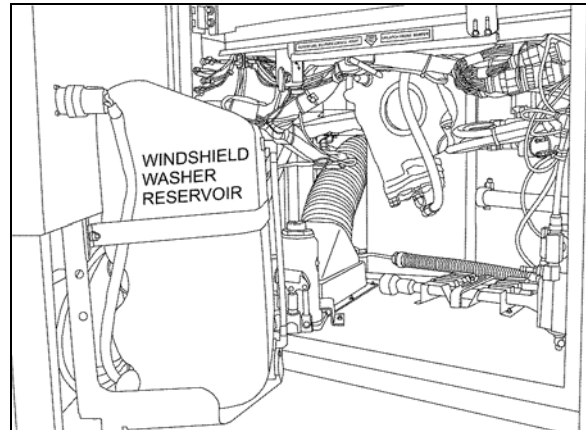

WINDSHIELD WASHER RESERVOIR

18619

The windshield spray jets are located on the windshield wipers and are angled to spray towards the center of the windshield.

Adjust the headlights washer nozzles according to the instructions found in section 23 of the maintenance manual. You may use water or windshield washer fluid as well.

 **CAUTION**

During cold weather days, use windshield washer fluid suitable for freezing temperature only.

OTHER VERIFICATIONS

It is good practice to regularly inspect the vehicle for signs of component wear and to perform safety and maintenance routines.

AIR TANK PURGE

The vehicle is equipped with many air tanks. Purge the accessory air tank before each trip. The accessory air tank drain cock is accessible from the front service compartment.

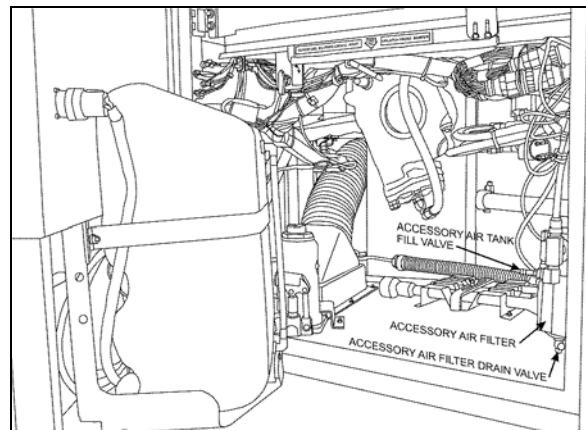

FRONT SERVICE COMPARTMENT

12210

The wet, primary, secondary and optional air tanks must be purged at every oil change or at least every 12,500 miles (20 000 km). They are equipped with a drain cock underneath the tank. Drain tanks by turning cocks counterclockwise. Refer to the "Lubrication and Service Check Point Chart" in this chapter for tank locations.

FIRE EXTINGUISHER (S)

Inspect fire extinguishers monthly to insure operation in emergency situations.

On extinguishers with a pressure gauge, the needle should be in the green or *NORMAL* range. Refill or replace extinguisher if pressure is below normal;

Check that seal on handle is intact;

Check that hose nozzle is in good condition and the nozzle is free of obstructions;

Keep fire extinguishers clean.

PRIMARY FUEL FILTER

A primary fuel filter is installed on the engine. This filter may consist of a filter cartridge with a drain valve at the bottom, or a filter cartridge, a water separation bowl and may have a fuel heater built in. It is used to prevent water from entering the fuel system. The primary fuel filter should be drained periodically or when the telltale light on the dashboard illuminates if equipped with this system. To drain water, loosen the drain valve below the separator. Close the drain valve when finished.

The optional Fuel Pro 382 diesel fuel filter system consists of a permanently mounted fuel processor, a replaceable filter element, a filter element cover and collar and a fluid filter base assembly. This system is installed between the fuel tank and the fuel pump and replaces the primary fuel filter. The filter serves as a water separator as well as a fuel filter. To drain, turn ¼ turn the drain valve below filter, close when water has been flushed out.

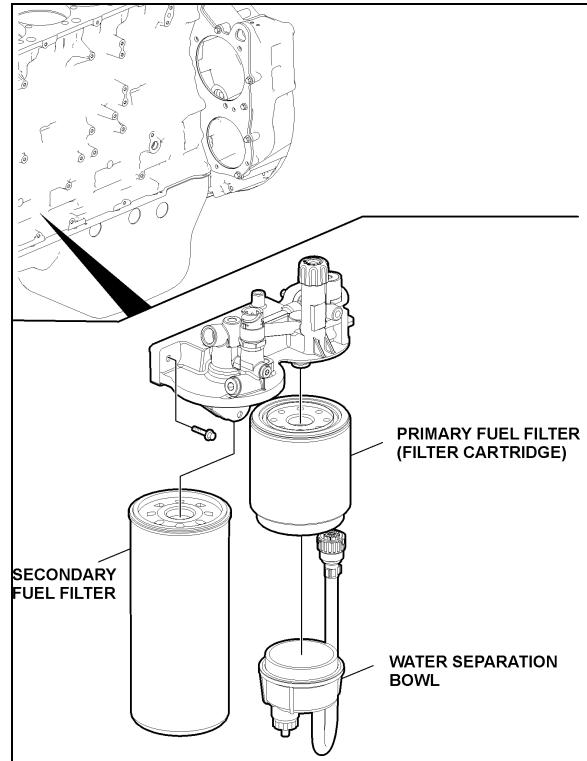

FUEL FILTERS WITH VOLVO D13 ENGINE 03085

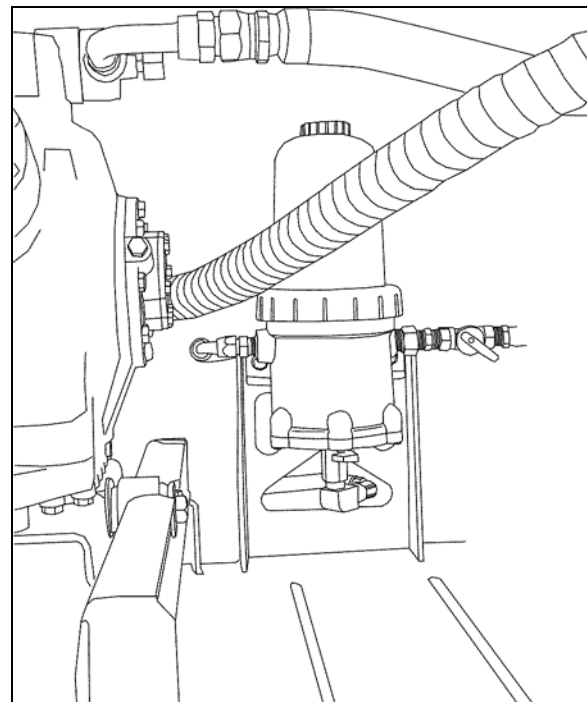

DAVCO FUEL PRO 382 INSTALLATION 03062

A/C COMPRESSOR BELTS

The air conditioning compressor is driven by two V-belts.

8-12 Care and Maintenance

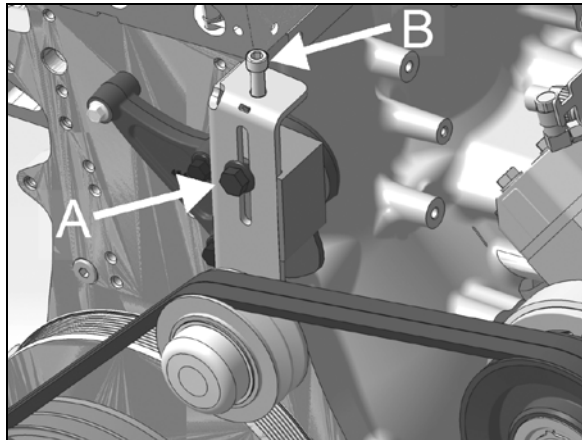

BELT TENSIONER

Belt tensioning is applied through the tensioner adjustment screw B. Loosen lock bolt A prior adjustment. Tighten lock bolt A to 43 lbf-ft once completed.

Belt tension should be within the following values:

New belts: 90-100 lbs.

Used belts: 75-85 lbs.

Check belt tension using a belt strand tension gauge.

- Once adjustment completed, allow the engine to run for about ten minutes. Check belt tension and adjust if needed.
- Do not treat belts with any compounds. Keep belts dry.
- Periodically inspect belt and pulleys for wear or damage;

ALTERNATOR DRIVE BELTS

These belts have automatic belt tensioner to keep the correct tension without adjustment.

BACK-UP CAMERA

The optional back-up camera is located on the rear cap. To clean the camera's protective glass, spray with soapy water. Wipe with a clean damp rag or wiper blade.



WARNING

To avoid injury, do not clean camera with transmission in reverse (R). Shut off engine and apply parking brake before cleaning.



CAUTION

To prevent scratches to the camera protective glass, do not wipe with dry rag. Use a clean damp rag.

AIR FILTER RESTRICTION INDICATOR

A filter restriction indicator (optional) is used to monitor the vacuum level between the air filter and engine. A red marker is displayed when the air filter is clogged. Replace the air filter when a red marker is displayed or after a maximum of two years. Reset by pressing on the indicator's extremity.

The filter restriction indicator is located on the engine air intake duct

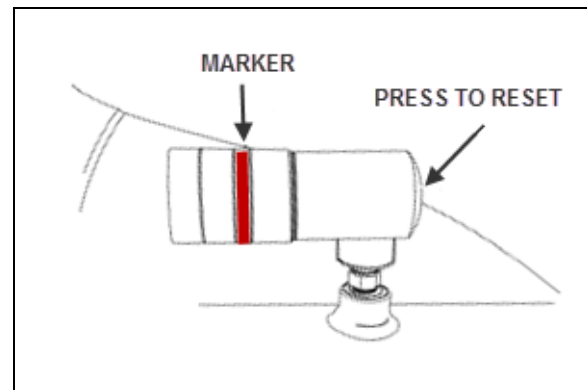

AIR FILTER RESTRICTION INDICATOR

01052_2

A/C AND HEATING SYSTEM AIR FILTERS

For maximum air conditioning and heating system efficiency, air filters should be inspected and cleaned as required in maintenance schedule to ensure proper ventilation of the evaporator and heating radiator cores. To clean filters, back flush with water, then dry with air.



CAUTION

Do not use high pressure water jet to avoid damaging filter.



CAUTION

Be sure not to reverse filter upon installation.

Driver's Area Air Filter

The driver HVAC system's air filter is located behind the dashboard R.H. side and it can be removed for cleaning or replacement. To gain access to the A/C filter, unscrew the grill located at the top step of the entrance door steps, remove the plastic cover holding the filter and slide out the air filter.

NOTE
If the windshield is continuously fogged, check that the driver's air filter is not clogged.

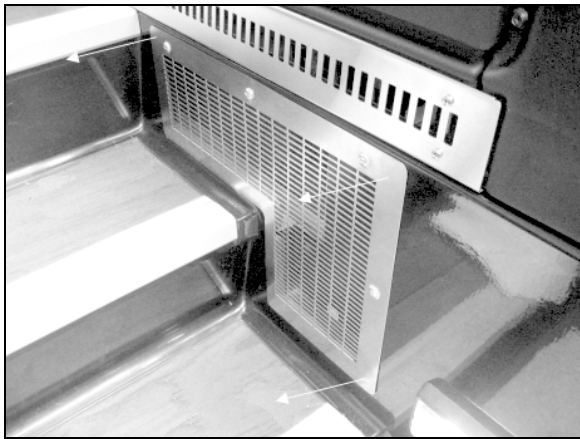

DRIVER'S AREA AIR FILTER GRILL REMOVAL



REMOVING DRIVER'S SECTION AIR FILTER

PASSENGERS AREA AIR FILTER

The central HVAC system's air filter is located in the evaporator compartment on driver's side of the vehicle. To access, open the evaporator compartment. An access panel labeled "AIR FILTER" is located above the evaporator and heating coils. It is held shut by quarter-turn screws. Slide out the filters for maintenance purposes.



PASSENGERS AREA AIR FILTER REMOVAL 22306

CAUTION
 Be sure not to install filter in inverted position.

Air Filters in the Overhead Compartments

Remove, clean or replace the air filter located behind each overhead baggage compartment fan. Slide the filter in and out using the tab fixed on the side of the filter.

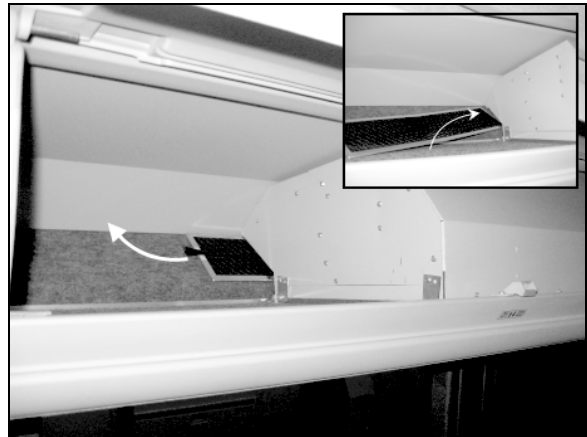

OVERHEAD COMPARTMENT FAN AIR FILTER

HOSE INSPECTION

Inspect hoses for leaks regularly to ensure efficient, economical and safe operation of the engine and related equipment. Carefully inspect all fittings, clamps and ties. To prevent chafing, make sure hoses are not touching shafts, couplings, heated surfaces, sharp edges or other parts. Since hose clamps and ties can vibrate loose or fail over time, inspect frequently and tighten or replace as necessary.

Correct leaking hoses immediately. Failure to correct leaks can cause severe damage to the equipment, as well as increase operating costs

8-14 Care and Maintenance

due to lost fluids. Treat fuel and oil leaks as an immediate fire hazard.



WARNING

Personal injury and property damage may result from fire caused by leaking flammable fluids.

Hose Service Life

Hoses have a limited service life. Thoroughly inspect hoses annually. Look for surface damage or indications of twisted, worn, crimped, cracked or leaking lines. Replace damaged hoses immediately.

Hoses should be replaced during major overhaul or after a maximum of seven years service. Be certain replacement hoses match the original equipment manufacturer's specifications.

LUBRICATION

Grease all lubrication points during scheduled maintenance. For heavy loads or extended use, lubricate more often. Refer to the Maintenance Manual, section 24 for information on lubrication.

WHEELS AND TIRES

Check for loose wheel nuts. Inspect all types of rims for cracks. Cracks can appear in many places but typically radiate out from where a load is applied. Both aluminum alloy and steel wheel nuts should be tightened to 450 to 500 foot-pounds (610 to 680 N.m.) torque.

Keep the tires inflated to the recommended inflation pressure to prolong tire life and for safety.

NOTE

Recommended tire inflation pressures are given in the "Coach Final Record", placed in the technical publications package supplied with the vehicle. The cold tire inflation pressures are on the Department of Transport certification plate located on the L.H. console besides the driver's seat. When special tires are installed by Prevost on a new vehicle, a special tire inflation chart is added next to the certification plate.

**WARNING**

Do not exceed maximum inflation pressure. Incorrect tire pressure increases tire wear and could lead to loss of driving control because of reduced road handling. Check tire pressure regularly.

- Vehicles equipped with BERU TPMS

On vehicles equipped with the Beru Tire Pressure Monitoring System (TPMS), it is better to use the TPMS display as the primary reference to judge when tire pressure need adjustment.

The TPMS presents pressure readings of each tire as a +/- deviation from the wanted target.

If a tire reads within +/- 3 PSI no adjustment is needed.

If a tire reads -4 PSI and below, re-inflate by the marked amount.

If a tire reads +4 PSI and above, deflate by the marked amount.

Relying on the TPMS system is better than relying on a hand gage since the TPMS is temperature compensated and remain accurate no matter if the tires are cold or hot.

Tires take up to 3 hours to get down to ambient temperature after a ride. A common mistake consist of checking pressure while the tires have not fully cooled down which leads into under-inflated tires. Relying on the TPMS eliminate this mistake.

Running tires at optimal pressure reduce tire wear, improve safety and fuel economy.

NOTE

It is more accurate to use the TPMS display to set the tire pressures than a pressure gauge.

WHEEL BEARINGS

Check wheel bearing cover for overheating (especially after using the service brakes) during fuel stops by touching the wheel bearing cover.

**WARNING**

If replacement tires are different from those described on the certification plate, pressure must be adjusted as requested in the Tire and Rim Association Manual.

SERVICE BRAKE TEST

Check for correct pressure build-up. Stop engine and check pressure gauge. Pressure loss should not exceed 3 psi/min (21 kPa/min) with engine stopped and without brake pedal applied. Air loss should not exceed 7 psi/min (48 kPa/min) with engine stopped and brake pedal fully applied.

A convenient way to proceed to the service brake test is with the use of the DID menu "Air Leakage Monitor". For more information, refer to "Driver Information Display (DID) Menus" in Section 5 *Other Features*.

PARKING BRAKE TEST

Release parking/emergency brake. Pump service brake pedal until air pressure drops to 65 psi (448 kPa). Make sure the warning buzzer operates and that the emergency brakes apply (the control valve knob lifts up). Allow air pressure to reach 95 psi (655 kPa) before releasing parking brake.

Driving the vehicle while the parking brake is applied should not be possible.

EXTERIOR LIGHTING VERIFICATION

Exterior Lighting Test Mode

This useful function allows quick verification of the vehicle exterior lights.

Activating the test mode:

When the vehicle is stationary (parking brake applied), pull up the multi-function lever 3 times within 3 seconds to activate the test mode. This test can be done when the engine is not running providing that the battery charge is sufficient (above 24.0 volts).

The telltale panel alarm emits a sound each second to remind that the test mode is in progress.

NOTE

You can also initiate and stop the exterior lighting test mode with the use of the DID menu "Exterior Lamp Inspection". For more information, refer to "Driver Information Display (DID) Menus" in Section 5 Other Features.

Stopping the test mode:

To stop the test mode, pull up the multi-function lever once or turn the ignition OFF or remove the parking brake.

NOTE

The test mode is useful to check the operation of the multiplex outputs and the exterior lights. It doesn't test the functionality of the commands related to the exterior lighting. For a complete testing, the directional signal commands, the headlights commands and the brake pedal have to be checked before. Once these commands tested, activate the test mode to check the exterior lighting.

Using the test mode:

First, test the functionality of the commands related to the exterior lighting:

- Activate the right directional signal and check that the corresponding cluster telltale light illuminates.
- Activate the left directional signal and check that the corresponding cluster telltale light illuminates.
- Activate the hazard warning flashers and check that the corresponding cluster telltale lights illuminate.
- Press the headlights rocker switch in first position and confirm that the instrument panel illuminates. Press the headlights rocker switch in second position and confirm that the headlights illuminate.
- Turn on the high beams and check that the corresponding cluster telltale light illuminates.

Once these commands tested, activate the test mode to check the exterior lighting by pulling up the multi-function lever 3 times within 3 seconds.

Go to the front of the vehicle and check the lights:

- Left and right directional signals.
- Identification lights and clearance lights.
- Low beams.
- High beams.

Left side and right side of the vehicle:

- Directional signals.
- Marker lights.

Rear of the vehicle:

- Directional signals.
- Identification lights and clearance lights.
- Stoplights and taillights.
- Back-up lights.

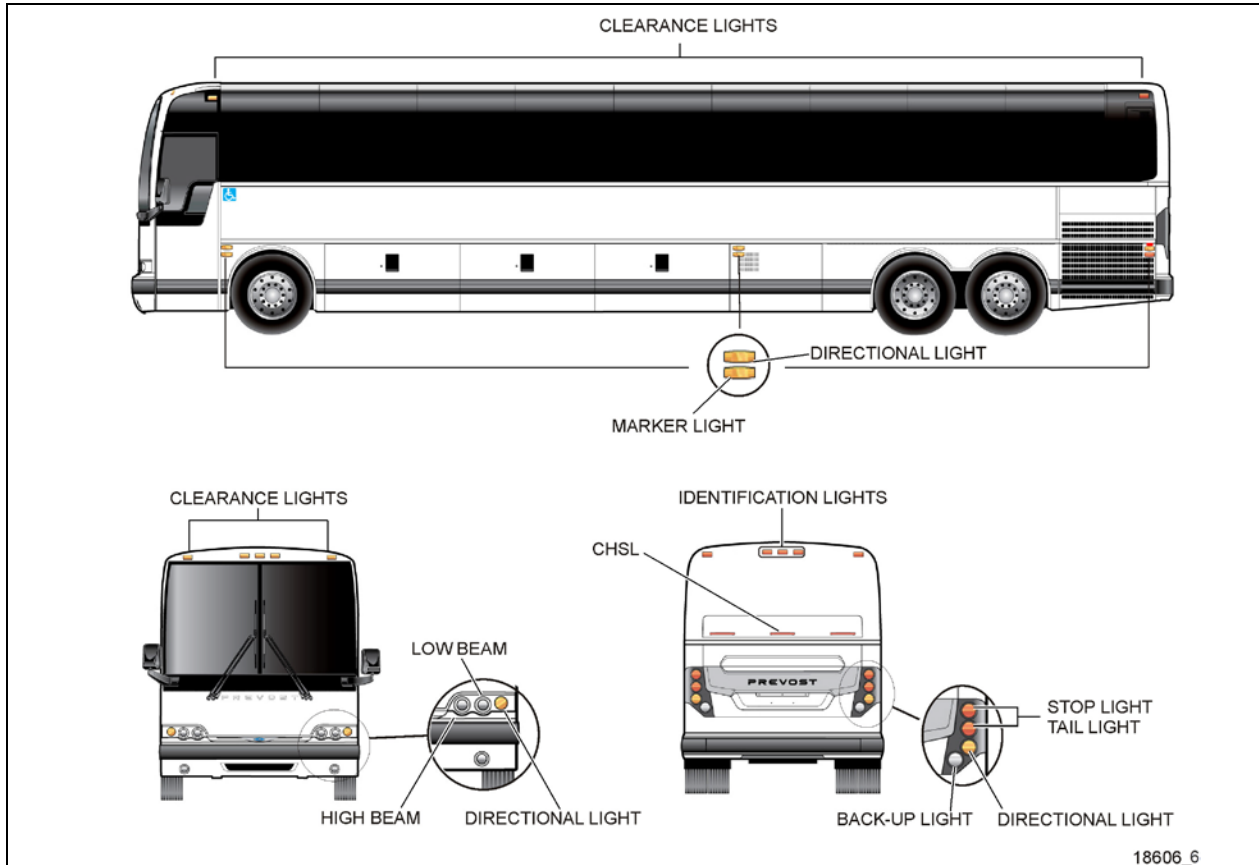

18606 6

EXTERIOR LIGHTING

8-18 Care and Maintenance

FIRST SERVICE ON NEW VEHICLE

NOTE

Refer to Maintenance Manual for precise service schedule.

ENGINE OIL

Preliminary oil change is not required since the engine has been test-run at the factory. Change oil and filter as specified in Section 24 of the Maintenance Manual.

COOLANT SYSTEM FILTER

The coolant system filter is designed to recover the soldering residues trapped inside the coolant lines during their initial assembly. Clean filter after first 3,000 miles (5 000 km) and then every 50,000 miles (80 000 km). Refer to the Maintenance Manual under section 05: Cooling System.

NOTE

If soldering has been performed on cooling system, clean filter after 3,000 miles (5 000 km).

GENERAL RECOMMENDATIONS

- Understand basic principles of vehicle operation;
- Always maintain the vehicle in good running condition;
- Do not drive with low fuel. If the fuel tank runs dry, the engine will not start until the air is bled from the fuel system. Refer to "Maintenance Manual" for more information;
- Allow engine to run for at least two minutes at normal idle before shutting *OFF*;
- Engine should be at idle when shifting from neutral (N) to forward (D) or from neutral (N) to reverse (R);
- The automatic transmission does not have a park (P) position. Place transmission in neutral (N) position and apply parking brake when the vehicle is stopped. A warning buzzer will sound if the engine is stopped and the parking brake has not been applied when foot pressure is removed from the brake pedal;

- Always follow the procedures described in this manual;
- Unless stated otherwise, shut *OFF* the engine before performing all servicing, lubrication and maintenance tasks;
- Do not attempt to push or pull-start the coach;
- The vehicle may be damaged if towed with the axle shafts or driveshaft connected;
- Depending of the options selected, two chemical fire extinguishers are under the first row of passenger seats or one extinguisher is in the first curb-side overhead compartment. In case of fire, immediately evacuate all occupants. Occupant safety is the first priority. Do not attempt to extinguish the fire if there is immediate danger or risk for personal injury;
- When driving on ice and snow, accelerate and decelerate gradually;



WARNING

Report all problems affecting passenger or driver safety to a Prevest service center or an authorized service center. Have problems corrected immediately.

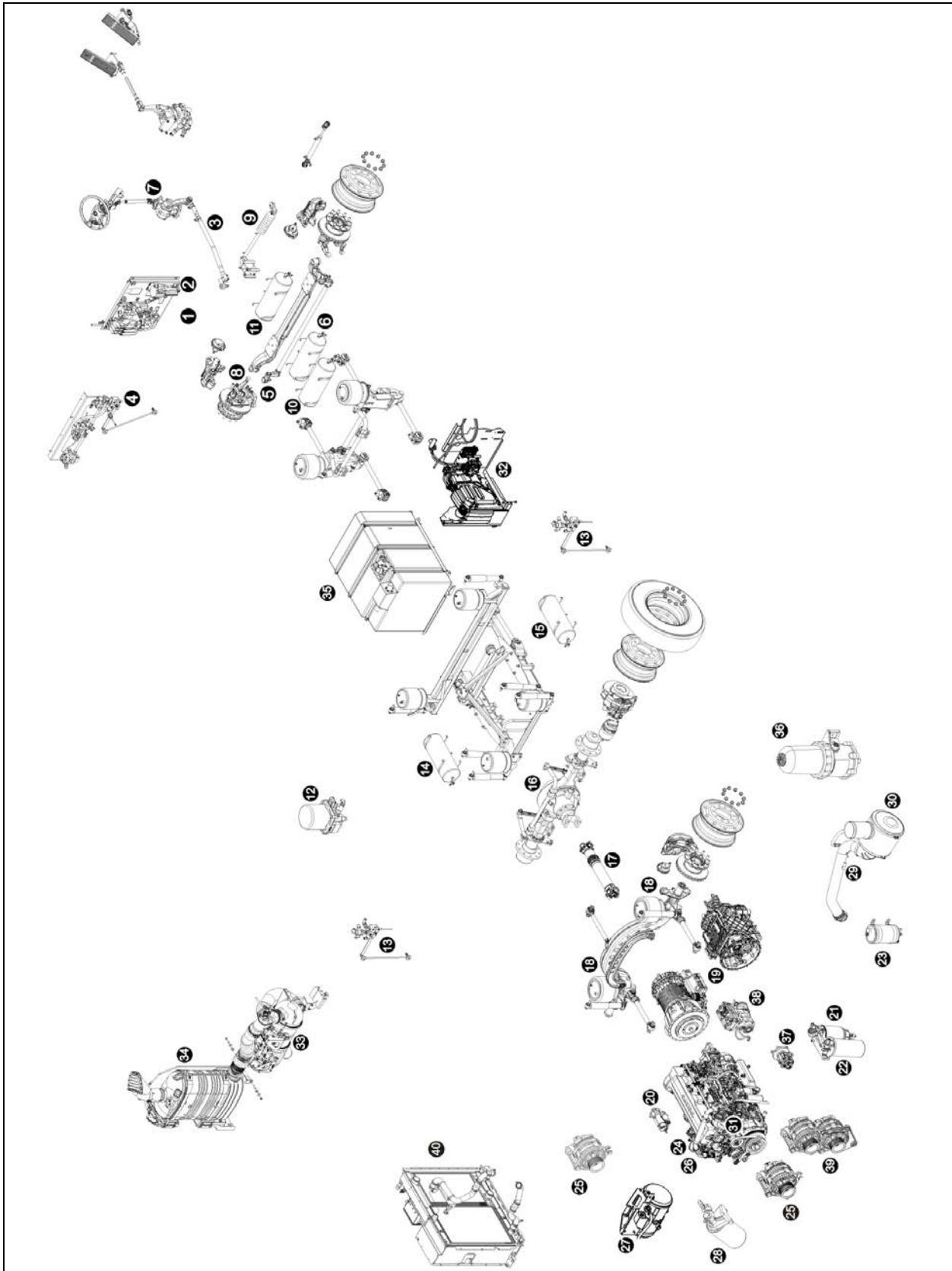

COMPONENTS IDENTIFICATION (COMPONENTS REPRESENTATION MAY DIFFER SLIGHTLY FROM ACTUAL VEHICLE)

8-20 Care and Maintenance

- | | | | |
|----|---------------------------------|----|---|
| 1 | Accessories air tank drain cock | 21 | Primary fuel filter |
| 2 | Accessories air filter | 22 | Secondary fuel filter |
| 3 | Steering drag link | 23 | Power steering fluid tank |
| 4 | Height control valve (front) | 24 | Engine oil filter |
| 5 | Steering tie rod | 25 | Road Side Alternator |
| 6 | Accessories air tank | 26 | Allison transmission oil dipstick |
| 7 | Steering column U-joints | 27 | Engine coolant surge tank |
| 8 | Steering knuckle pins | 28 | Coolant filter & conditioner |
| 9 | Steering damper cylinder | 29 | Engine air filter restriction indicator |
| 10 | Secondary air tank | 30 | Engine air filter |
| 11 | Kneeling air tank | 31 | Engine oil dipstick and filler tube |
| 12 | Air dryer | 32 | DEF tank |
| 13 | Height control valve (rear) | 33 | Diesel particulate filter |
| 14 | Wet air tank | 34 | SCR catalytic converter |
| 15 | Primary air tank | 35 | Diesel fuel tank |
| 16 | Differential | 36 | Davco Fuel Pro 382 fuel filter |
| 17 | Propeller shaft | 37 | Power steering pump |
| 18 | Tag axle lever pivot | 38 | Air compressor |
| 19 | Transmission | 39 | Curb Side Alternators |
| 20 | Starter | 40 | Cooling Assembly (Radiator & CAC) |

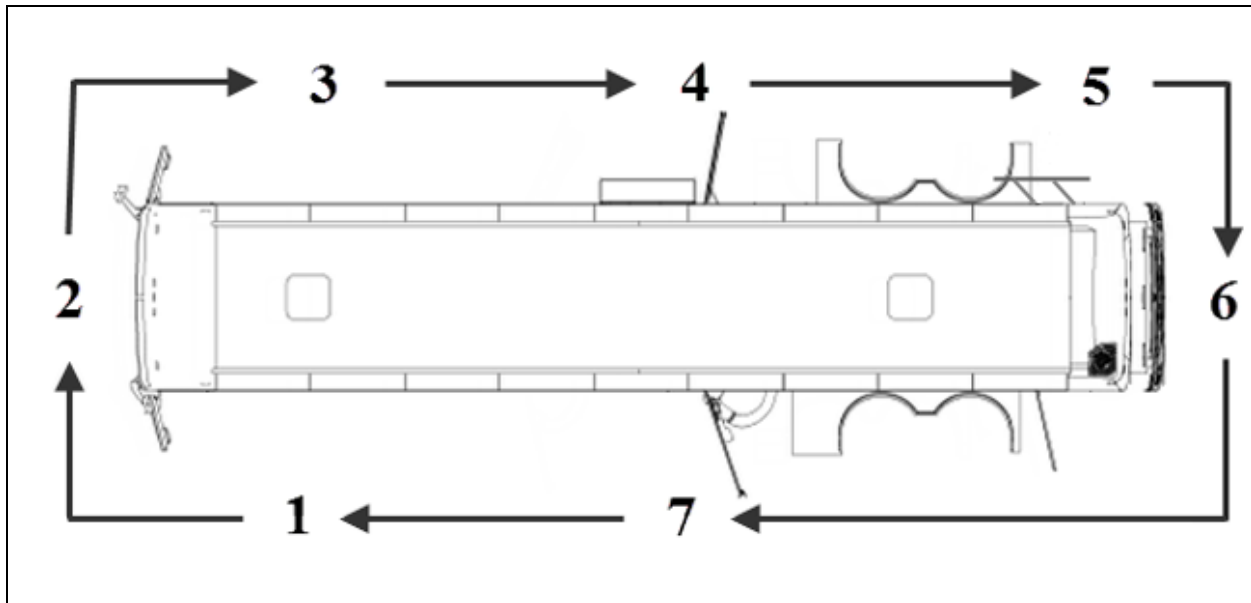
WALK-AROUND INSPECTION (BEFORE EVERY TRIP)**NOTE**

Inspect the coach in a circular manner as shown in the illustration.

Approaching the Coach

- Check under the coach for oil, fuel, coolant leaks or other signs of damage.
- Check exterior body surfaces for signs of breaks or damage.

Preparation

- Drain accumulated water from accessories air tanks.
- Close air tank drain valves.
- Start the engine and let the air pressure build up to normal. Stop engine.
- Switch on hazard warning flashers.
- Make sure parking brakes are applied.

Step 1: Front Left Side of the Coach

- Check condition of wheel rim. Especially look for cracks, missing nuts, bent or broken studs.
- Check condition of tire: properly inflated, no serious cuts, bulges, tread wear or any signs of misalignment; valve stem not touching wheel or rim; valve cap in place.

- Check windshield and headlights washer reservoir fluid level and add if necessary.

Step 2: Front of the Coach

- Check for damage and clean if dirty.
- Check windshield wiper arms for proper spring tension.
- Check wiper blades for any damage, “dead” rubber and attachment to arm.
- Check to see that there is no mud, snow, ice build-up or other obstruction in front of the ACB radar sensor, if applicable.
- Check clearance and identification lights, they should be clean, operating and of the proper color. Refer to “Exterior Lighting Verification” in Care and Maintenance chapter.
- Turn on headlights. High and low beams should be operating and lenses clean. If equipped, check fog lights. Refer to “Exterior Lighting Verification” in Care and Maintenance chapter.
- Left and right front turn signal lights clean, operating and proper color. Refer

8-22 Care and Maintenance

to “Exterior Lighting Verification” in Care and Maintenance chapter.

Step 3: Front Right Side of the Coach

- Check condition of wheel rim. Especially look for cracks, missing nuts, bent or broken studs.
- Check condition of tire: properly inflated, no serious cuts, bulges, tread wear or any signs of misalignment; valve stem not touching wheel or rim; valve cap in place.

Step 4: Rear Right Side of the Coach

- Check condition of wheels and rims. Especially look for cracks, missing nuts, bent or broken studs.
- Check that baggage and service compartment doors are properly closed.
- Check condition of tires: properly inflated, no serious cuts, bulges, tread wear or any signs of misalignment; valve stems not touching wheels or rims; valve caps in place and no objects stuck between the wheels.

Step 5: Engine Compartment Right Side Area

- Check engine and surrounding areas for coolant, oil and fuel leaks.
- Check fuel/filter water separator and drain if necessary. Check for leaks.
- Check wiring harness for signs of damage.

Step 6: Engine Compartment

- Check engine and surrounding areas for coolant, oil and fuel leaks.
- Check wiring harness for signs of damage.
- Check condition of drive belts.
- Check engine crankcase oil level, add if necessary.
- Check Allison transmission fluid level (can also be checked from push-button shift selector), add if necessary.
- Check power steering reservoir fluid level, add if necessary.

- Check coolant surge tank fluid level, add if necessary.
- Check air cleaner restriction indicator, replace air cleaner when red signal locks in full view.
- Check stop light, tail light, directional signal light and back-up light assembly; operating, clean and proper color. Refer to “Exterior Lighting Verification” in Care and Maintenance chapter.

Step 7: Rear Left Side of the Coach

- Check condition of wheels and rims. Especially look for cracks, missing nuts, bent or broken studs.
- Check that baggage and service compartment doors are properly closed.
- If so equipped, check coolant heater system for fuel leaks.
- Check condition of tires: properly inflated, no serious cuts, bulges, tread wear or any signs of misalignment; valve stems not touching wheels or rims; valve caps in place and no objects stuck between the wheels.

Inside the Coach

- Check for proper operation of the entrance door.
- Check steps; clean them if there is any substance that makes them slippery, which makes coach entry/exit hazardous.
- Check that emergency exit windows and roof escape hatches can be opened then close all windows and hatches securely.
- Verify proper operation of windshield wiper/washer.
- Adjust and clean mirrors for adequate rear view vision.
- Start engine and check for proper operation of all gauges and indicator lights.
- Check for proper operation of electric and air horns and back-up alarm.
- Perform a brake test. Check both primary and secondary pressure gauges.

DIMENSIONS AND WEIGHTS	4
CAPACITIES	4
FUEL TYPE	4
BIODIESEL FUELS.....	4
WHEELS AND TIRES	5
RECOMMENDED TIRE INFLATION PRESSURE AT MAXIMUM COLD LOAD	5
BELTS	5
VOLVO D13 ENGINE	5
ALLISON TRANSMISSION	6
VOLVO I-SHIFT TRANSMISSION	6
PROPELLER SHAFT	6
BRAKES	6
BRAKE CHAMBER EFFECTIVE AREA.....	6
AIR SYSTEM	6
ANTILOCK BRAKING SYSTEM (ABS)	6
TROUBLESHOOTING AND TESTING	6
AUTOMATIC TRACTION CONTROL (ATC) – ELECTRONIC STABILITY PROGRAM (ESP)	6
STEERING	7
ELECTRICAL SYSTEM	7
SUSPENSION	7
I-BEAM AXLE FRONT SUSPENSION (OPTION).....	7
INDEPENDENT FRONT SUSPENSION.....	7
DRIVE AXLE (ALL)	7
TAG AXLE.....	7
ALIGNMENT SPECIFICATIONS	8
COOLING SYSTEM	8
FUEL SYSTEM	8
EXHAUST SYSTEM	9
HEATING AND AIR CONDITIONING	9
OIL SPECIFICATIONS	9
ENGINE	9
ALLISON TRANSMISSION.....	9
I-SHIFT TRANSMISSION	9
DIFFERENTIAL.....	9
POWER STEERING RESERVOIR	10
PRE-HEATING SYSTEM	10
PLATES AND CERTIFICATION	10
SAFETY CERTIFICATION.....	11
DOT CERTIFICATION PLATE.....	11
VEHICLE IDENTIFICATION NUMBER (VIN)	11
COACH FINAL RECORD	12

9-2 Technical Information

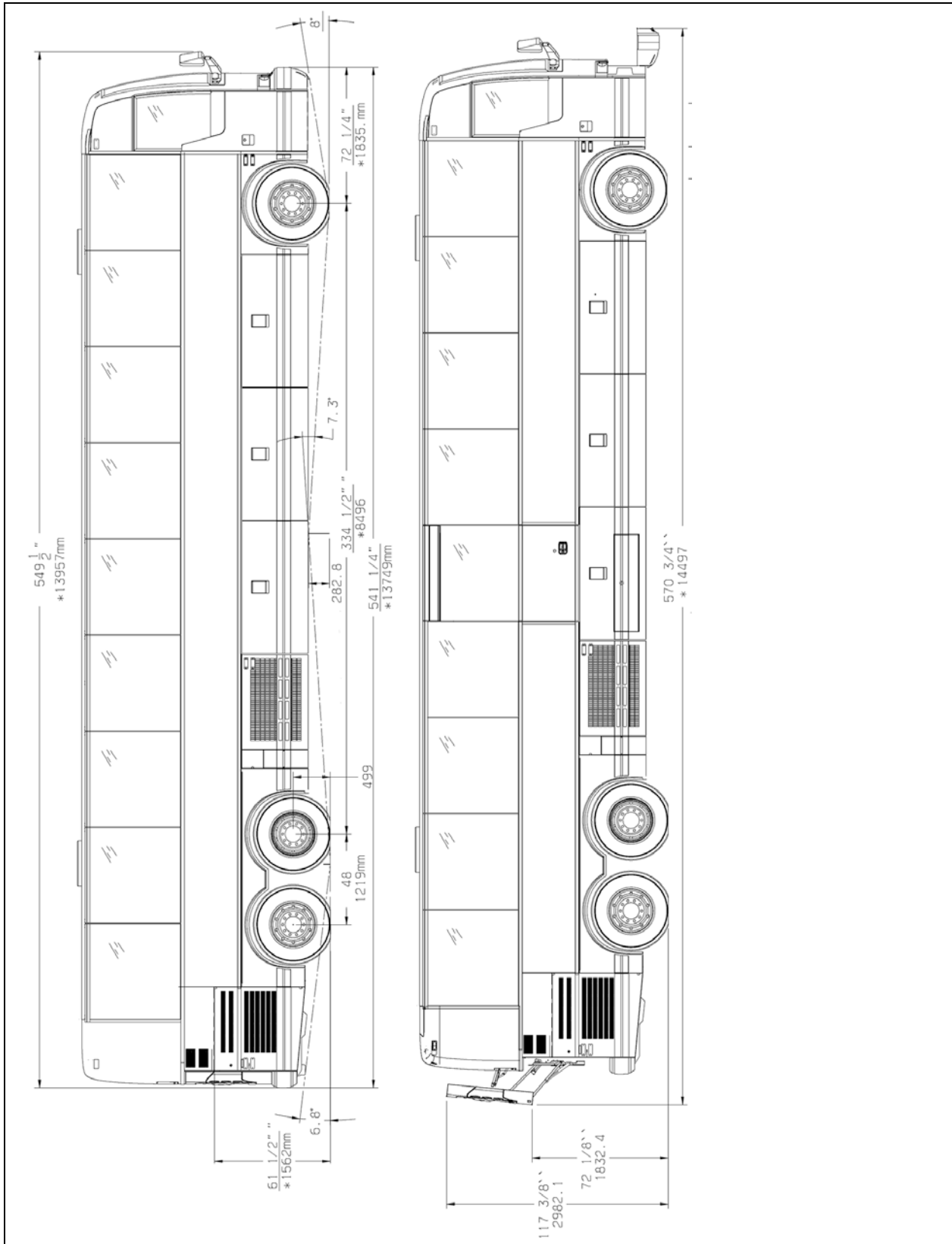

X3-45 OVERALL DIMENSIONS (SIDE ELEVATION)

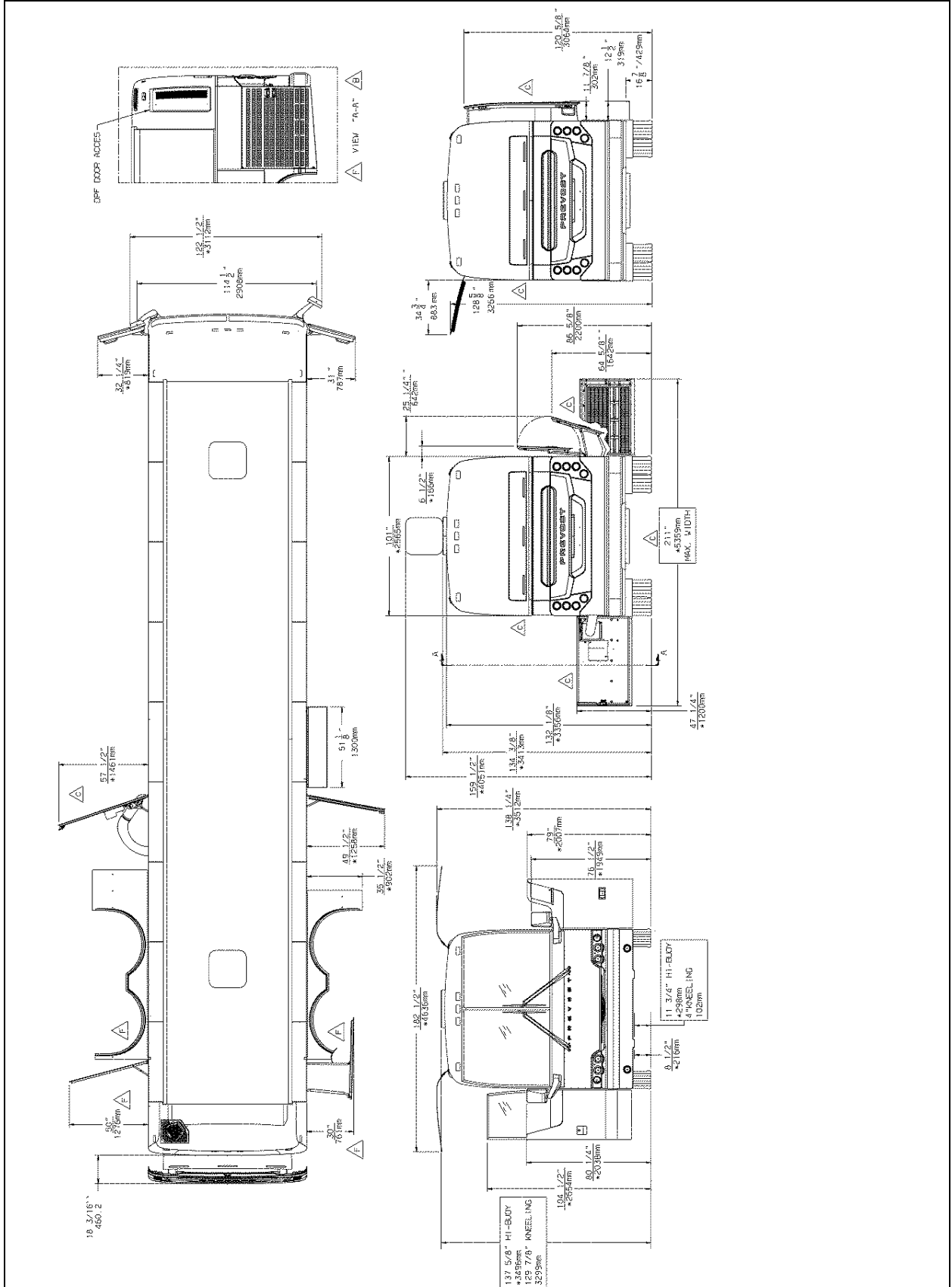

X3-45 OVERALL DIMENSIONS (TOP, FRONT AND REAR VIEWS)

9-4 Technical Information

DIMENSIONS AND WEIGHTS	X3-45
Overall length (including bumpers)	45' (13,7 m)
Overall width	102" (2,59 m)
Overall height (hatch open)	140" (3,56 m)
Wheelbase (center of front axle to center of drive axle)	334½" (8496 mm)
Floor height from ground	48 1/2" (1,23 m)
Ground clearance	11" (280 mm)
Step height from ground	15" (380 mm)
Step height (other steps)	7" (178 mm)
Headroom	80" (2,03 m)
Entrance door opening width	30" (762 mm)
Front overhang	72¼" (1836 mm)
Rear overhang	107 1/2" (2.20 m)
Front track	85.9" (2,18 m)
Drive track	76.7" (1,95 m)
Rear track (Tag axle)	83.6" (2,12 m)
Turning circle radius (I-Beam Axle)	47'-3" (14.4 m)
Turning circle radius (independent suspension)	43'-9" (13.3 m)
Curb weight	37 300 lb (16 916 kg)
Gross Vehicle Weight Rating (G.V.W.R.)	53 000 lb (24 040 kg)
Front axle Gross Axle Weight Rating (G.A.W.R.)	16 500 lb (7 500 kg)
Drive axle (G.A.W.R.)	22 500 lb (10 206 kg)
Tag axle (G.A.W.R.)	14 000 lb (6 350 kg)

The Gross Vehicle Weight Rating (G.V.W.R.) and the Gross Axle Weight Rating (G.A.W.R.) for front drive and tag axles are listed on a certification plate located on the L.H. control panel in driver's section.

CAPACITIES	X3-45
Volvo D13 Engine oil (refill volume with filter change)	40 U.S. qrts (38 l)
Fuel tank (legal capacity equal to 95% of volume)	203 U.S. gal. (768 l)

CAPACITIES	X3-45
Diesel Exhaust fluid tank (DEF)	16 gall. U.S. (60 l)
Cooling system (excluding heating syst.)	17.4 U.S. gal. (66 l)
Allison Automatic Transmission (does not include external circuit)	6 U.S. gallons (23 l) 6.9 U.S. gallons (26 l) with retarder
I-Shift Transmission	16 U.S. qts (15 l)
Differential oil	20 U.S. qts (18,7 l) Meritor Axle 19 U.S. qts (18 l) ZF A-132 Axle
Power steering reservoir	4.0 U.S. qts (3,8 l)
A/C compressor oil	2.6 U.S. qts (2,5 l)
Windshield washer reservoir	5.3 U.S. gal. (20 l)
Refrigerant	24.1 lb (11 kg)
Toilet sump tank	17 US gal. (65 liters)

FUEL TYPE

Diesel engines for 2007 and later model year vehicles are designed to operate only with **Ultra Low Sulfur Diesel** (ULSD) fuel, which can contain no more than 15 ppm sulfur.



CAUTION

ULSD fuel is necessary to avoid fouling the engine's Exhaust Aftertreatment System. Use of fuel other than ULSD will reduce the efficiency and durability of the engine.

BIODIESEL FUELS

Biodiesel with up to a maximum of 20% biofuel (B20) may be used and will not affect the manufacturer's mechanical warranty as to engine and emissions system related components. The biofuel used in the various blends must conform to ASTM D6751; therefore B1 to B5 blends conforming to ASTM D975 and B6 to B20 blends conforming to ASTM D7467. Also, any engine performance problem related to the use of biodiesel fuel would not be recognized nor considered as Volvo or Prevest's responsibility.

However, Volvo engines are certified to comply with U.S. EPA and California emissions

standards based upon the use of *test fuels* with specifications established by these regulatory agencies.

Alternative fuels, including biodiesel, that are not substantially similar to the required *test fuels* may adversely affect engine emissions compliance. As a result, Volvo does not warrant the engine will conform to applicable Federal or California emissions limits when operated on biodiesel or other alternative fuels that are not substantially similar to specified test fuels used for certification.

Additional maintenance is required and is covered in the maintenance manual "Fuel system" section.

WHEELS AND TIRES

- Accuride steel wheels9" X 22½"
- Alcoa aluminum forged wheels9" X 22½"
- Except inner drive axle (steel).....8¼" X 22½"
- Alcoa aluminum forged wheels (for super single tire) 14" X 22½"
- Tires 315/80 R22.5 load range "L"
- Tires 365/70 R22.5 load range "L"
- Tires (super single) 455/55 R22.5 load range "L"

RECOMMENDED TIRE INFLATION PRESSURE AT MAXIMUM COLD LOAD

The recommended tire inflation pressures are given in the applicable documents supplied with the vehicle. In addition, minimum cold tire inflation pressures are listed on the Department of Transport (DOT) certification plate, affixed on the left wall near the driver's seat.

Vehicle equipped with TPMS: The TPMS target pressures are factory set to equal the prevailing tire pressure at delivery time. When tire pressures are increased to account for higher vehicle weight, the TPMS set point need to be increased accordingly.

CAUTION

These tire pressures are established in accordance with the maximum allowable load on each axle. A lower pressure is recommended if the axle load is less than the above specifications. Weigh vehicle fully loaded and pressurize according to tire manufacturer's recommendations. For non

standard tire and wheel specifications, see Prevost tire pressure tabulation in "Coach Final Record".

WARNING

Special tire selection may lower maximum allowable speed limit, even below posted speed limit. For maximum safety, check with tire manufacturer.

BELTS

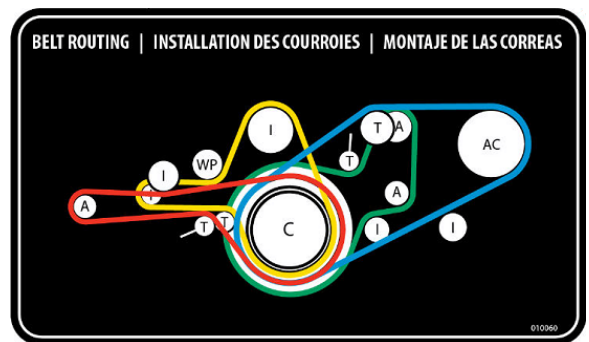

A: Alternator	I: Idler	T: Tensioner
C: Crank	WP: Water pump	AC: A/C compressor

Belt application	Type	Qty
A/C system Bitzer 4NFCY compressor	V Belt BX71	2
Alternator (twin Bosch, curb side)	Multi-V-8 Rib 8PK1575	1
Alternator (emergency)	Multi-V-8 Rib 8PK1512	1
Alternator (single, driver side)	Multi-V-10 Rib 10PK1695	1
Coolant pump	Multi-V-10 Rib 10PK1512	1

NOTE

Belts specifications may vary. For proper belt selection, always consult your vehicle Coach Final Record.

VOLVO D13 ENGINE

Type: 4 cycles / inline six cylinders
 Displacement: 12.8 liters, SOHC, 4 valves per cylinder
 Power435 HP
 Torque..... 1700 lbf-ft @ 1100 rpm
 Recommended cruise speed range 1300-1500rpm
 Full dress, dry weight 2519 lb

ALLISON TRANSMISSION

Allison B500 (B500R with the optional output retarder) electronically controlled six speed automatic transmission.

Gear Ratios

1 st	3.510
2 nd	1.906
3 rd	1.429
4 th	1.000
5 th	0.737
6 th	0.639
Reverse	4.801
Converter	1.9
Differential ratio	3.91
Differential ratio (optional)	3.58
Differential ratio (ZF A-132 axle)	3.54

VOLVO I-SHIFT TRANSMISSION

Technologically advanced twelve speed automated mechanical transmission

Gear Ratios

1 st	14.94
2 nd	11.73
3 rd	9.04
4 th	7.09
5 th	5.54
6 th	4.35
7 th	3.44
8 th	2.70
9 th	2.08
10 th	1.63
11 th	1.27
12 th	1.00
Reverse 1 st	17.48
Reverse 2 nd	13.73
Differential ratio	2.50
Maximum input torque.....	1850 Lb-Ft (2500 Nm)

PROPELLER SHAFT

Hayes-Dana SPL250 type tubular shafts, provided with heavy-duty universal joints.

BRAKES

The features of the braking system include a dual system where the front and rear circuits are completely independent from each other. The brakes are air operated disc type brakes. The emergency/parking brakes are located on the

drive. To ensure a constant running clearance between pads and disc, the brakes are equipped with a non-wearing, automatic adjuster mechanism.

BRAKE CHAMBER EFFECTIVE AREA

Front axle	24 in ²
Drive axle	24/24 in ² (service / emergency)
Tag axle	16 in ² (service)

AIR SYSTEM

Compressed air is provided by a twin cylinder, 31.8 cfm Wabco, gear-driven, water-cooled and engine oil lubricated air compressor.

ANTILOCK BRAKING SYSTEM (ABS)

The antilock braking system has one Electronic Control Unit (ECU) controlling a 6-sensor/5-modulator (6s/5m) system. A wheel slip sensor is mounted at each wheel.

The Electronic Control Module (ECM) is maintenance free. Its operating voltage is 24 ± 6 volts DC. The thermal operating range for the ECM is from -40 to 167°F (-40 to 75°C).

The solenoid control valves are maintenance free. Their operating voltage is 24 (+4.8, -2.4) volts DC. The rated current draw is 1.65 amps. The thermal operating range of the solenoid control valves is from -40 to 176°F (-40 to 80°C).

TROUBLESHOOTING AND TESTING

For troubleshooting and testing of the vehicle's anti-lock braking system, refer to Meritor WABCO Maintenance Manual: "Anti-Lock Brake Systems For Trucks, Tractors and Buses" or use the dashboard Driver Information Display (DID).

AUTOMATIC TRACTION CONTROL (ATC) – ELECTRONIC STABILITY PROGRAM (ESP)

In addition to the ABS function, vehicle may be equipped with an advanced model of Bendix EC-60 controller to provide an **Automatic Traction Control (ATC)** feature. Bendix ATC can improve vehicle traction during acceleration, and lateral stability while accelerating through curves. ATC utilizes **Engine Torque Limiting (ETL)** where the ECU communicates with the engine's controller and/or **Differential Braking (DB)** where individual wheel brake applications are used to improve vehicle traction.

The EC-60 advanced model controller also provides ABS-based stability features referred to as **ESP® Electronic Stability Program**.

Refer to Maintenance Manual, Section 12: Brake and Air System for more information on this system.

	<h2>CAUTION</h2>
<p>Even with ESP-equipped vehicles, the driver remains responsible for ensuring vehicle stability during operation.</p>	

	<h2>DANGER</h2>
<p>ESP may reduce the vehicle speed automatically.</p> <p>ESP can make the vehicle decelerate automatically. ESP can slow the vehicle with or without the operator applying the brake, and even when the throttle is being applied.</p>	

STEERING

- ZF 8098 integral hydraulic assisted steering gear;
- Variable assistance in function of speed is optional.
- Volvo hydraulic pump gear driven from engine drive.
- Hydraulic reservoir and dipstick accessible from engine compartment.
- System pressure: 2175 psi (150 bars).
- Steering wheel diameter 20". Tilt steering wheel and telescopic steering column; pneumatically locked with foot operated switch for adjustment.
- Number of turns: 5¾.
- Outside turning radius: See Dimensions and Weight.

ELECTRICAL SYSTEM

- 24-volt, negative ground;
- 12-volt exterior lighting;
- Three 28 volts, 150 amp, self-regulated, belt-driven, air-cooled HD 10 Bosch alternators;

- Four 12 Volts, group 31 AGM type batteries connected in series/parallel. Each one has a reserve capacity of 200 minutes and a cold cranking capacity of 800 amps.
- 100 amp battery equalizer.

SUSPENSION

Goodyear rolling lobe type air springs (bellows) are used throughout.

I-BEAM AXLE FRONT SUSPENSION (OPTION)

- 2 Bellows (12"); for a G.A.W.R. of 16,500 lb;
- 2 Shock absorbers;
- 4 Radius rods;
- 1 Transverse radius rod;
- 1 Height control valve.
- 1 sway bar (1¾" diameter).

INDEPENDENT FRONT SUSPENSION

- 2 Bellows (12") for a G.A.W.R. of 16,500 lb;
- 2 Shock absorbers;
- 2 Upper A-arms;
- 2 Lower A-arms;
- 2 Torque rods;
- 2 Steering Levers;
- 1 Height control valve;
- 1 sway bar (1¾" diameter).

DRIVE AXLE (ALL)

- 4 Bellows (11");
- 4 Shock absorbers;
- 3 Radius rods;
- 1 Panhard rod;
- 2 Height control valves.

TAG AXLE

- 2 Bellows (11");
- 2 Shock absorbers;
- 3 Radius rods;
- 1 Panhard rod.

ALIGNMENT SPECIFICATIONS

Use static wheel alignment systems which work with angle measurements only, such as Josam or Hunter systems. Static alignment specifications are listed in the following tables:

I-BEAM AXLE FRONT AXLE			
	Minimum value	Nominal value	Maximum value
Right camber	-0.25°	0.125°	0.375°
Left camber	-0.25°	0.125°	0.375°
Right caster	2.0°	2.75°	3.5°
Left caster	2.0°	2.75°	3.5°
Total toe	0.04°	0.06°	0.08°

INDEPENDENT FRONT SUSPENSION			
	Minimum value	Nominal value	Maximum value
Right camber	0.0°	0.150°	0.30°
Left camber	0.0°	0.150°	0.30°
Right caster	2.35°	2.6°	2.85°
Left caster	2.35°	2.6°	2.85°
Total toe	0.04°	0.06°	0.08°

DRIVE AXLE MERITOR			
	Minimum value	Nominal value	Maximum value
Thrust angle	±0.11°		
Total toe	0.18° toe-in	0°	0.18° toe-out

DRIVE AXLE ZF A-132			
	Minimum value	Nominal value	Maximum value
Thrust angle	±0.11°		
Total toe	0.15° toe-in	0°	0.15° toe-out

TAG AXLE			
	Minimum value	Nominal value	Maximum value
Thrust angle*	-0.02°	0	0.02°
Total toe	0.08° toe-in	0°	0.02° toe-out

(*) Use the drive axle as reference

COOLING SYSTEM

- Extra capacity, Aluminum radiator and aluminum charge air cooler arranged side by side.
- 24V ECU controlled electrical cooling fans, total of eight, six over radiator side and two on charge air cooler.
- Rubber insulated from the body.
- Expansion tank above radiator and remote mounted.
- System pressure 14 psi.
- 185° F thermostat.
- Full system capacity 22.5 US gal (85 l).
- Coolant filter.

FUEL SYSTEM

Polyethylene 208 US gallons/787 liters fuel tank centrally located.

Equipped with:

- Anti-spill device.
- Safety filler cap on right side of coach.
- Pressure relief valve.
- Electric fuel gauge.
- Low level signal at 26 US gallons/98.4 liters.
- Primary filter 25 microns (standard).
- Primary fuel filter with electrical water indicator (Volvo D13).
- Fuel pro 382 filter available as an option as a primary filter.
- Secondary filter 3 to 5 microns.
- Shut-off valve on fuel supply line.
- Provided with filling access on the right side of the coach.

EXHAUST SYSTEM

One all stainless steel exhaust aftertreatment system including:

- Catalytic converter to reduce NOx.
- FleetGuard assembly made of a DOC (Diesel Oxidation Catalyst and a DPF (Diesel Particulate Filter). Noise, vibration and heat insulated. This assembly is mounted to the bus structure and is accessible through an exterior access door.
- Tail pipe diffuser and rain deviation device.
- Exhaust pipe with Insulation and a flexible section.
- Exhaust to rear rooftop left hand corner.
- Diesel exhaust fluid (DEF) tank (60 liters) and injection system.

HEATING AND AIR CONDITIONING

Two air conditioning systems using the same compressor are available: the large capacity (central) A/C and an optional overhead compartment A/C. The large capacity A/C provides adequate capacity of conditioned and filtered air for all climatic conditions. Fresh air is drawn into the system from the left (driver's) side of the vehicle. Return air is taken from the middle of the vehicle. The driver's heater and defogger are controlled separately from the central unit. An air mixture selector enables air to be drawn into the system from outside the vehicle or recirculated.

The optional overhead compartment A/C is used to cool air delivered from registers in the passenger overhead compartments.

CENTRAL A/C	
Air conditioning capacity	9 tons
Refrigerant type	134A
Heating capacity	152 000 Btu/h
Air flow, main A/C	2 600 cfm (73,6 m ³ /min)
Air flow, overhead compartment, opt.	450 cfm (12,7 m ³ /min)

COMPRESSOR (for central A/C)	
Number of cylinders	4
Operating speed	500 to 3500 rpm
Oil capacity	2.6 U.S. qts (2,5 l)
Approved oil	Bitzer BSE55 (POE)

NOTE
<i>The above oils are suitable for use with reciprocating compressors using refrigerant R-134a and with evaporator temperatures above -40°F (-40°C).</i>

OIL SPECIFICATIONS

ENGINE

For the Volvo D13M engine, we recommend using SAE 10W-30 "Volvo Premium Motor Oil VDS-4.5" or other Volvo Approved VDS-4.5 oils.

Volvo VDS-4.5 oils exceed API service category CK-4 oils.

ALLISON TRANSMISSION

Allison Transmission recommends the following fluids:

- Castrol TranSynd™ or TES-295 specification equivalent fluid;
- TES-389 specification equivalent fluid.

I-SHIFT TRANSMISSION

Only use VOLVO-approved synthetic transmission oil in the I-Shift transmission. Refer to section 24 of the Maintenance Manual for more information about oils approved by Volvo;

DIFFERENTIAL

Multigrade gear oil meeting MIL-PRF-2105E: 85W-140 is recommended for use in the Meritor drive axle. This lubricant performs well over a broad temperature range, providing good gear and bearing protection in a variety of climates. If temperature drops below 10°F (-12°C), 80W-90 should be used, and below -15°F (-26°C), 75W-90 should be used. In extreme conditions or for better performance, full synthetic gear oil should be used. For vehicles equipped with the ZF A-132 drive axle, use Chevron Multigear oil

9-10 Technical Information

80W-90 (ZF lubricant class 12M) or refer to ZF List of lubricants TE-ML 12 for other approved lubricants.

POWER STEERING RESERVOIR

Use Automatic Transmission Fluid (ATF) Dexron-II-E or Dexron-III for this system.

PRE-HEATING SYSTEM

Depending on options chosen, a coolant heater may be installed on the coolant circuit. The heater can be used as a pre-heater or as an auxiliary heat source.

Only the Valeo 104,000 Btu preheater is available. The heater is controlled by a programmable timer. See Other Features chapter for information on how to use the timer.

VALEO		
Model	Thermo 300	
Heating output	104,000 Btu/hr (30 kW)	
Fuel type	Same as engine	
Fuel consumption	4.8 US qts/hr (4.5 l/hr)	
Rated voltage	24 V DC	
Operating voltage	20-28 V DC	
Electric power consumption without water pump	110 watts	
Dimensions	(L)	24.01 (610 mm)
Inch (mm)	(W)	9.69 (246 mm)
	(H)	8.66 (220 mm)
Weight	lb (kg)	41.88 (19)

PLATES AND CERTIFICATION

The main components of the vehicle such as engine, transmission, axles and chassis are identified by different serial numbers. It may be necessary to locate these numbers for warranty purposes.

The engine data plate is located on the rocker cover. The engine serial and model number and a list of the optional engine equipment are written on this plate. Refer to this information when ordering replacement parts. Also the engine data plate certifies that the engine conforms to federal and any state exhaust emissions regulations.

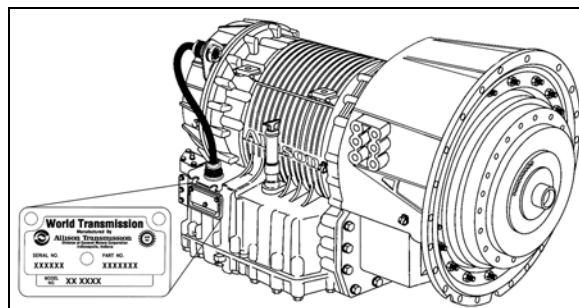

ALLISON TRANSMISSION

07076

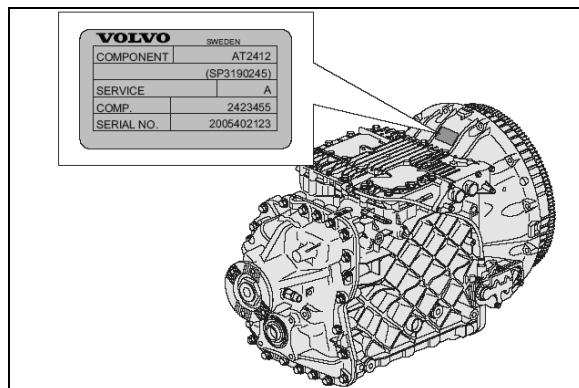

I-SHIFT TRANSMISSION

00040

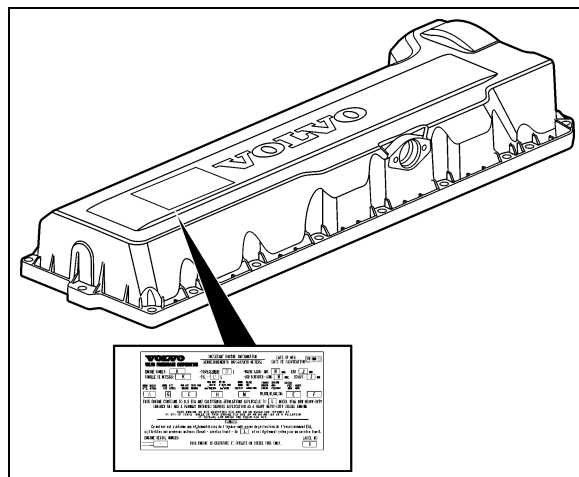

VOLVO D13 ENGINE DATA PLATE

00052

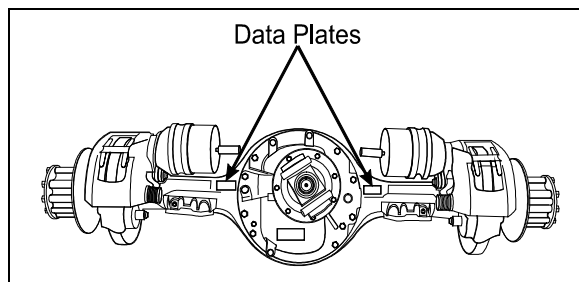

MERITOR DRIVE AXLE

00007

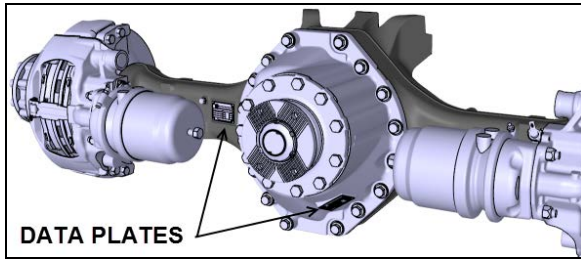

DATA PLATES
ZF A-132 DRIVE AXLE

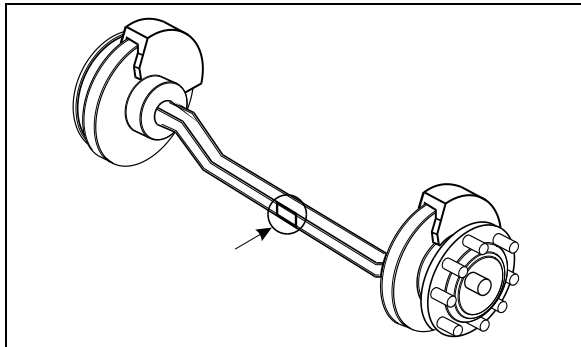

I-BEAM FRONT AXLE 00008

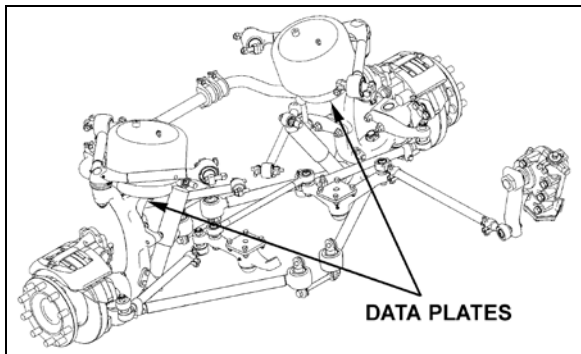

INDEPENDENT FRONT SUSPENSION 16136

SAFETY CERTIFICATION

- Vehicle components meet specifications and standards as follows:
- Material and parts conform to ASTM and/or SAE standards in effect at the time of manufacture.
- All factory-installed interior materials meet FMVSS 302 for fire resistance.
- Certified according to Provincial, State and Federal Safety standards (Canadian and US) BMCSS, FMVSS and CMVSS.
- Other applicable certification labels are affixed to the component.

DOT CERTIFICATION PLATE

This certifies that vehicles manufactured by Prevost comply with all Federal Motor Vehicle Safety Standards at the time of manufacture. Information such as date of manufacture, model year, gross vehicle weight rating, tire types and inflation pressure is also etched on this plate. The DOT Certification plate is affixed to L.H. control panel.

		PREVOST			
MANUFACTURED BY : PREVOST FABRIQUE PAR : STE-CLAIRE, QUE.		DATE OF MFG. DATE DE FAB.			
G.V.W.R. : 24040 KG. (53000 LBS). P.N.B.V. :				COLD INFLATION PRESS./ FROID KPA (PSI)	
AXLES/ ESSELX	G.A.W.R./ P.N.B.E.	TIRES/ PNEUS	RIMS/ JANTES	SINGLE OR DUAL SIMPLE OU DOUBLE	
	KG (LBS)			KPA (PSI)	
FRONT: AVANT:	7484 (16500)	315/80R22.5 (J)	22.5X9	827 (120)	S
INT. DIFF.:	10206 (22500)	315/80R22.5 (J)	22.5X9	621 (90)	D
REAR: TANDEM:	6350 (14000)	315/80R22.5 (J)	22.5X9	689 (100)	S
THIS VEHICLE CONFORMS TO ALL APPLICABLE U.S. FEDERAL MOTOR VEHICLE SAFETY STANDARDS IN EFFECT ON THE DATE OF MANUFACTURE SHOWN ABOVE.					
VEHICLE IDENTIFICATION NO. NO. IDENTIFICATION VEHICULE					
		TYPE: BUS B/A		#405405	

DOT CERTIFICATION PLATE 00016

VEHICLE IDENTIFICATION NUMBER (VIN)

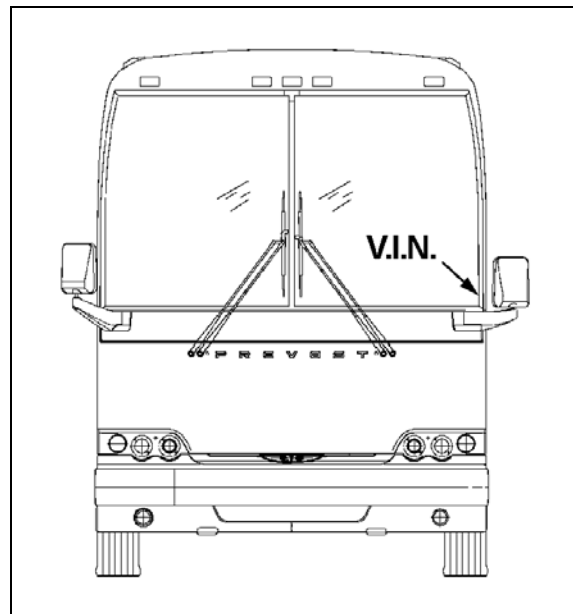

VEHICLE IDENTIFICATION NUMBER 00044

The Vehicle Identification Number is stamped on a plate located on the windshield frame pillar (driver's side). The VIN is visible from the outside of the vehicle. Make sure the correct vehicle identification number is given when ordering replacement parts. Using the VIN when ordering parts will facilitate processing.

9-12 Technical Information

NOTE

Record the VIN in the vehicle documentation and keep with company records. The VIN will normally be used for vehicle registration, service reference needs and for obtaining vehicle insurance coverage.

COACH FINAL RECORD

The Coach Final Record is a record of all data pertaining to the assembly of the vehicle. This record is shipped to the new customer via a courier company. Retain this record in the company records office for reference and safe-keeping.

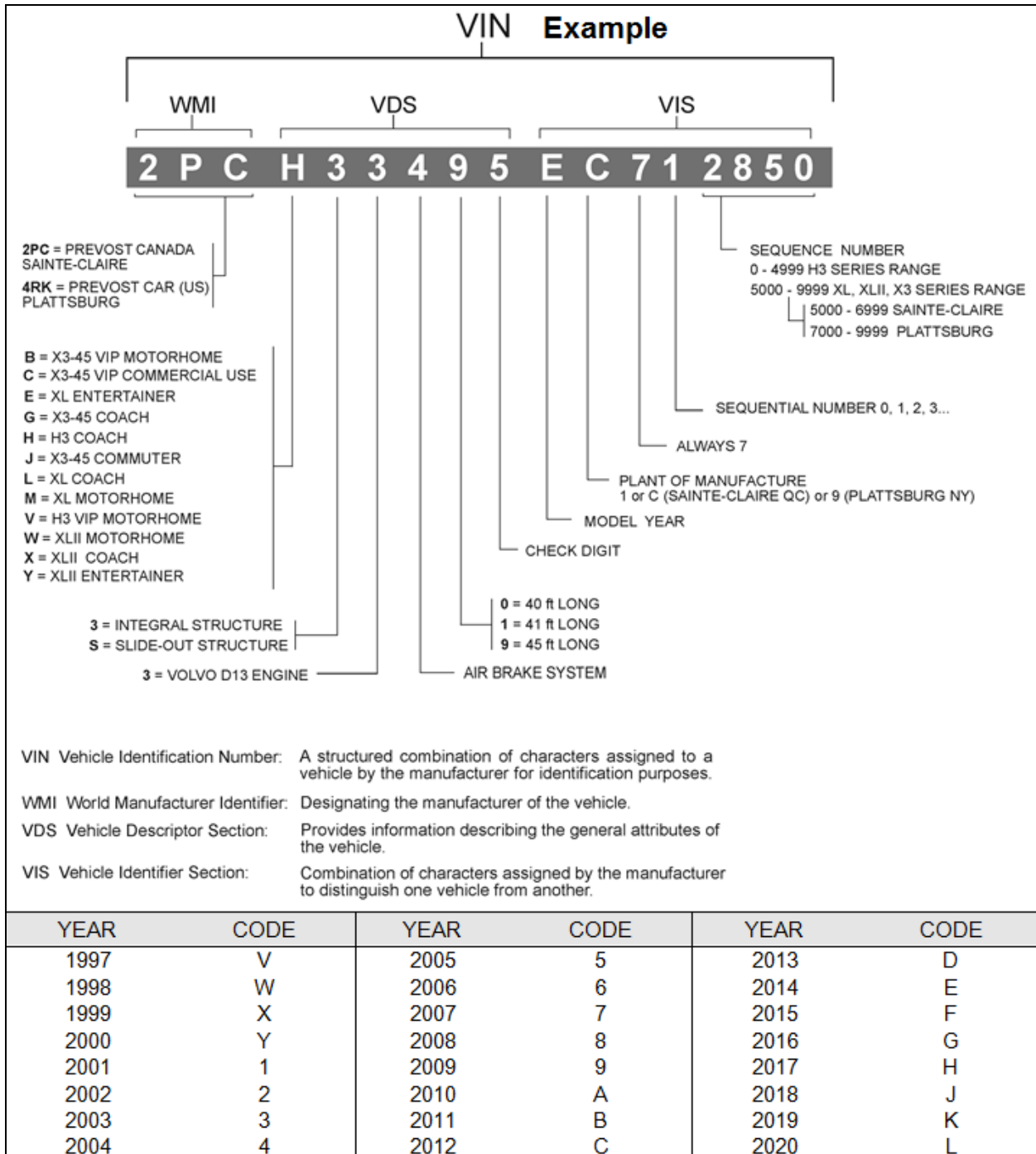

ABBREVIATION	DESCRIPTION
ABS	Antilock Brake System / Système de freinage antiblocage
A/C	Air Conditioning / Air climatisé
AFSS	Automatic Fire Suppression System / Système automatique de détection et d'extinction des incendies
ATC	Automatic Traction Control (Bendix) / Système d'antidérapage automatique
CECM	Chassis Electronic Control Module
CVC	Chauffage, Ventilation et Climatisation / heating, ventilation and air conditioning HVAC
DCDL	Driver Controlled Differential Lock / Verrouillage du différentiel
DDR	Diagnostic Data Reader
DEF	Diesel Exhaust Fluid / Fluide d'échappement diesel FED
DEL	Diode Électroluminescente / Light Emitting Diode LED
DID	Driver Information Display / Écran d'affichage du panneau des instruments
D-MIC	Driver Microphone / Microphone du conducteur
DPF	Diesel Particulate Filter / Filtre à particules
DTC	Diagnostic Troubleshooting Code / Code d'anomalie
DUFS	Diesel Ultra Faible en Soufre / Ultra Low Sulfur Diesel ULSD
ECM	Electronic Control Module / Unité de commande électronique
ECU	Electronic Control Unit / Unité de commande électronique
EECU	Engine Electronic Control Unit / Unité de commande électronique du moteur
EGR	Exhaust Gas Recirculation / Recirculation des gaz d'échappement
ESC	Electronic Stability Control / Dispositif électronique de contrôle de la stabilité
ESC	Escape / Échap
ESP	Electronic Stability Program (Bendix) / Dispositif électronique de contrôle de la stabilité
E+	Eco-Roll
FAP	Filtre À Particules / Diesel Particulate Filter DPF
FDA	Following Distance Alert / Alerte de distance
FED	Fluide d'Échappement Diesel / Diesel exhaust fluid DEF
GECU	Gear selector Electronic Control Unit / Unité de commande électronique du sélecteur de vitesses
G-MIC	Guide Microphone / Microphone du guide
HVAC	Heating, Ventilation and Air Conditioning / Chauffage, Ventilation et Climatisation CVC
IA	Impact Alert / Alerte de collision
IFS	Independent Front Suspension / suspension avant indépendante
LED	Light Emitting Diode / diode électroluminescente DEL
MPH	Miles Per Hour / Milles à l'heure
PPT	Premium Tech Tool
PTO	Power Take Off / Prise de pouvoir
PRIME	Power Recovery by Intelligent Management of Energy
SCR	Selective Catalytic Reduction / Réduction catalytique sélective
TCM	Transmission Control Module / Module de commande de la transmission
TCS	Traction Control System / Dispositif d'antipatinage
TECU	Transmission Electronic Control Unit / Unité de commande électronique de la transmission
TPMS	Tire Pressure Monitoring System / Système de surveillance de la pression des pneus
TWS	Threshold Warning System / Système avertisseur du seuil de porte
ULSD	Ultra Low Sulfur Diesel / Diesel Ultra Faible en Soufre DUFS
VCADS	Outil informatisé de diagnostic
VEB	Volvo Engine Brake / Frein moteur Volvo
VECF	Vehicle Electrical Center Front
VECR	Vehicle Electrical Center Rear
VECU	Vehicle Electronic Control Unit / Unité de commande électronique du véhicule
VSS	Video and Sound Selector / Sélecteur audio-vidéo
WCL	Wheelchair Lift / Système d'élévation de fauteuils roulants

Appendix A 1

SERVICE LITERATURE	2
NOTICE	3
DECLARATION OF THE MANUFACTURING DEFECTS TO THE GOVERNMENT OF THE UNITED STATES.....	3
DECLARATION OF THE MANUFACTURING DEFECTS TO THE CANADIAN GOVERNMENT	3
DECLARATION OF THE MANUFACTURING DEFECTS TO PREVOST	3

2 Appendix A

SERVICE LITERATURE

Visit our web site at www.prevostcar.com for on-line product information and technical publications!

Additional copies of the following service literature are available on request and at low cost. These can be helpful to mechanics and drivers alike.

- * **Maintenance Manual**
- * **Operator's Manual**
- * **Parts Manual**
- * **Service Center Directory**

You have three possibilities to order service literature:

1. By phone with this toll free number 1-800-463-8876
2. By email at:
 - a. prevostparts.commandes@volvo.com (Canada)
 - b. function.prevostparts.orders@volvo.com (USA)
3. By mail at :

PREVOST PARTS

2955-A Watt Street
Sainte-Foy, (Quebec)
Canada G1X 3W1

Specify the complete vehicle serial number (VIN). Allow 30 days for delivery

NOTICE

DECLARATION OF THE MANUFACTURING DEFECTS TO THE GOVERNMENT OF THE UNITED STATES

If you believe that your vehicle has defect which could cause a crash or could cause injury or death, you should immediately inform the National Highway Traffic Safety Administration (NHTSA) in addition to notifying Prevest.

If NHTSA receives similar complaints, it may open an investigation, and if it finds that a safety defect exists in a group of vehicles, it may order a recall and remedy campaign.

However, NHTSA cannot become involved in individual problems between you, your dealer, or Prevest Car Inc.

To contact NHTSA you may either call the Auto Safety Hotline toll-free at **1-800-424-9393** (or **366-0123** in Washington, D.C. area) or write to:

**NHTSA
U.S. Department of transportation
Washington, D.C. 20590.**

You can also obtain other information about motor vehicle safety from the Hotline.

DECLARATION OF THE MANUFACTURING DEFECTS TO THE CANADIAN GOVERNMENT

If you live in Canada, and if you believe that your vehicle has a safety defect, you should immediately inform Transport Canada and Prevest. You may write to:

**Transport Canada
Box 8880
Ottawa, Ontario, K1G 3J2**

DECLARATION OF THE MANUFACTURING DEFECTS TO PREVOST.

In addition to notify the NHTSA (or Transport Canada), please contact Prevest at **1-418-831-2046**. Or you may write to:

**Prevest
After-sales service department
850 Olivier Road,
Saint-Nicolas (Quebec)
Canada, G7A 2N1**

Troubleshooting

Problem/Symptom	Probable Causes	Actions
Vehicle does not Start	<p>The Engine Stop pushbutton located on the rear start panel is depressed</p> <p>Main electrical shut-off switch is in the OFF position</p>	<ol style="list-style-type: none"> 1. Twist and pull the Engine Stop pushbutton to place it in normal operating position, check that the main electrical shut-off switch is in the ON position and retry cranking from the ignition switch 2. Start the vehicle from the engine compartment using the rear start button
	<p>DL0 (BBUS MUX) network problem (Multiplex)</p> <p>Module AE52 not powered or is defective</p> <p>Engine ECM does not receive the ignition signal</p> <p>Engine ECM is not powered</p>	<p>If the vehicle does not start from the rear:</p> <ol style="list-style-type: none"> 1. Verify that module AE52 is powered: <ol style="list-style-type: none"> a) Check the SYSTEM DIAGNOSTIC menu of Driver Information Display (DID). Select FAULT DIAGNOSTIC and ELECTRICAL SYSTEM. The message “No Response ModA52, Active”, indicates a power problem on the module or a DL0 (BBUS MUX) network problem. b) Check / reset circuit breaker CB5 c) Check / replace fuse F65 d) Probe gray connector on module to see if it is powered. 2. Verify that the engine ECM is powered and gets the ignition signal <ol style="list-style-type: none"> a) Check / reset circuit breaker CB8 Check / replace fuse F74 b) Check / reset circuit breaker CB2 Check / replace fuse F78

2 Appendix B – Troubleshooting Guide for Multiplex Vehicles

Problem/Symptom	Probable Causes	Actions
<p>None of the Multiplexed functions are operating, including the basic limp-home functions (door opening, flashers, wipers in speed 1)</p> <p>“FLIP REAR BREAKER TO INITIATE I/O MODULES PROGRAMMING” pop-up message appears in the DID</p> <p><i>Note: The sunshades are still functioning since these are not multiplexed</i></p>	<p>The program version in the MCM is different than the program in the I/O modules and the MCM is forcing all I/O modules to stay inactive</p>	<ol style="list-style-type: none"> Engage the auto-programming of the I/O modules: Turn the ignition key to the ON position, trip and reset circuit breaker CB6. The DID indicates "MUX AUTOPROGRAMMING I/O MODULE PLEASE WAIT" until the reprogramming is complete.
<p>Many secondary functions (not essential for driving) not functioning (interior lighting, driver's area lighting, wiper speed 2 and intermittent).</p> <p>Marker lights and clearance lights are turned ON when setting ignition to the ON position.</p>	<p>The MCM module does not receive 24 V power.</p> <p>The DL0 (BBUS MUX) network is not working. It could be caused by a short on the network, an open circuit, a problem with the MCM or the MCM being disconnected from the network.</p>	<ol style="list-style-type: none"> Check / reset circuit breaker CB6. Check / replace fuse F1 Operate in limp-home mode by starting the vehicle from the engine compartment (REAR START). All functions essential to drive are available <p>To close and lock the door, pull the door manually up to its closed position and it will lock by itself. The door opening button is still functioning</p>
<p>No temperature control in the passenger area</p> <p>Passenger temperature display indicates two dashes "--"</p>	<p>Problem with the temperature sensor located in the evaporator compartment air intake or the sensor wiring</p>	<p>Instruct the driver to manually control the temperature by playing with the passenger set point. Set above 22°C (72°F) to heat and below 22° C (72°F) to cool</p>

Problem/Symptom	Probable Causes	Actions
<p>Entrance door does not open nor close using the control buttons</p> <p>Defroster fan not functioning</p> <p>Windshield wipers not functioning in speed 1 or intermittent</p>	<p>Module AE47 is not powered or is faulty</p>	<ol style="list-style-type: none"> 1. Check the SYSTEM DIAGNOSTIC menu of Driver Information Display (DID). Select FAULT DIAGNOSTIC and ELECTRICAL SYSTEM. The message "No Response ModA47, Active" indicates a power problem on the module. (A DL0 (BBUS MUX) network problem would show the same message but doesn't produce these symptoms). 2. Check / reset circuit breaker CB1 3. Check / replace fuse F45 4. Probe gray connector on module to see if it is powered. 5. Use the air release valves near the entrance door and in the front service compartment to lock / unlock the door
<p>Windshield wipers not functioning in speed 1 or intermittent</p>	<p>No power on R27</p>	<p>Check CB48 (VECF)</p>
<p>HVAC condenser fans not functioning in speed 1</p>	<p>Circuit breaker CB7 tripped</p>	<p>Check / reset circuit breaker CB7</p>
<p>HVAC condenser fans not functioning in speed 2</p>	<p>Circuit breaker CB7 tripped</p>	<p>Check / reset circuit breaker CB7 Check / replace fuse F135</p>
<p>Windshield washer not functioning</p> <p>Windshield upper section de-icing system not functioning</p>	<p>Module AE44 is not powered or is faulty</p>	<ol style="list-style-type: none"> 1. Check the SYSTEM DIAGNOSTIC menu of Driver Information Display (DID). Select FAULT DIAGNOSTIC and ELECTRICAL SYSTEM. The message "No Response ModA44, Active" indicates a power problem on the module. (A DL0 (BBUS MUX) network problem would show the same message but doesn't produce these symptoms). 2. Check / reset circuit breaker CB1 3. Check / replace fuse F44 4. Probe gray connector on module to see if it is powered.

4 Appendix B – Troubleshooting Guide for Multiplex Vehicles

Problem/Symptom	Probable Causes	Actions
Defroster fan is functioning but no heat or cooling available in the driver area.	Module AE47 is not powered or is faulty	<ol style="list-style-type: none"> 1. Check the SYSTEM DIAGNOSTIC menu of Driver Information Display (DID). Select FAULT DIAGNOSTIC and ELECTRICAL SYSTEM. The message “No Response ModA47, Active” indicates a power problem on the module. (A DL0 (BBUS MUX) network problem would show the same message but doesn't produce these symptoms). 2. Check / reset circuit breaker CB1 3. Check / replace fuse F45 4. Probe gray connector on module to see if it is powered.
<p>Low beam headlamps and front flasher on left side not functioning</p> <p>Electric horn not functioning</p>	Module AE46 is not powered or is faulty	<ol style="list-style-type: none"> 1. Check the SYSTEM DIAGNOSTIC menu of Driver Information Display (DID). Select FAULT DIAGNOSTIC and ELECTRICAL SYSTEM. The message “No Response ModA46, Active” indicates a power problem on the module. (A DL0 (BBUS MUX) network problem would show the same message but doesn't produce these symptoms). 2. Check / reset circuit breaker CB10 3. Check / replace fuse F19 4. Probe gray connector on module to see if it is powered.
Low beam headlamps and flasher on right side not functioning	Module AE48 is not powered or is faulty	<ol style="list-style-type: none"> 1. Check the SYSTEM DIAGNOSTIC menu of Driver Information Display (DID). Select FAULT DIAGNOSTIC and ELECTRICAL SYSTEM. The message “No Response ModA48, Active” indicates a power problem on the module. (A DL0 (BBUS MUX) network problem would show the same message but doesn't produce these symptoms). 2. Check / reset circuit breaker CB10 3. Check / replace fuse F21 4. Probe gray connector on module to see if it is powered.

Problem/Symptom	Probable Causes	Actions
<p>Rear flashers not functioning</p> <p>Stoplights and center stoplights not functioning</p>	<p>Module AE51 is not powered or is faulty</p>	<ol style="list-style-type: none"> 1. Check the SYSTEM DIAGNOSTIC menu of Driver Information Display (DID). Select FAULT DIAGNOSTIC and ELECTRICAL SYSTEM. The message “No Response ModA51, Active” indicates a power problem on the module. (A DL0 (BBUS MUX) network problem would show the same message but doesn't produce this symptom). 2. Check / reset circuit breaker CB8 3. Check / replace fuse F107 4. Probe gray connector on module to see if it is powered.
<p>Engine is overheating and radiator fans do not engage</p>	<p>Module AE52 or AE49 is not powered or is faulty</p>	<ol style="list-style-type: none"> 1. Check the SYSTEM DIAGNOSTIC menu of Driver Information Display (DID). Select FAULT DIAGNOSTIC and ELECTRICAL SYSTEM. The message “No Response ModA52/ModA49, Active” indicates a power problem on the module. (A DL0 (BBUS MUX) network problem would show the same message but doesn't produce this symptom). 2. Check circuit breaker CB5 3. Check / replace fuse F133, F134 4. CB201-CB208
<p>The A/C compressor clutch does not engage</p>	<p>Module AE54 (or AE52) is not powered or is faulty</p>	<ol style="list-style-type: none"> 5. Check the SYSTEM DIAGNOSTIC menu of Driver Information Display (DID). Select FAULT DIAGNOSTIC and ELECTRICAL SYSTEM. The message “No Response ModA54, Active” indicates a power problem on the module. (A DL0 (BBUS MUX) network problem would show the same message but doesn't produce this symptom). 6. Check / reset circuit breaker CB5 7. Check / replace fuse F135 8. Probe gray connector on module to see if it is powered.

6 Appendix B – Troubleshooting Guide for Multiplex Vehicles

Problem/Symptom	Probable Causes	Actions
Evaporator fan not functioning	Circuit breaker CB3 tripped Module AE54 is not powered or is faulty	<ol style="list-style-type: none"> 1. Check circuit breaker CB3 2. Check relay R12 3. Check the SYSTEM DIAGNOSTIC menu of Driver Information Display (DID). Select FAULT DIAGNOSTIC and ELECTRICAL SYSTEM. The message “No Response ModA54, Active” indicates a power problem on the module. (A DLO (BBUS MUX) network problem would show the same message but doesn't produce this symptom). 4. Check / reset circuit breaker CB5 5. Check / replace fuse F135 6. Probe gray connector on module to see if it is powered.
HVAC condenser fans not functioning in speed 1	Module AE54 is not powered or is faulty	<ol style="list-style-type: none"> 1. Check the SYSTEM DIAGNOSTIC menu of Driver Information Display (DID). Select FAULT DIAGNOSTIC and ELECTRICAL SYSTEM. The message “No Response ModA54, Active” indicates a power problem on the module. (A DLO (BBUS MUX) network problem would show the same message but doesn't produce this symptom). 2. Check / reset circuit breaker CB5 3. Check / replace fuse F135 4. Check / replace fuse F141-F144 5. Probe gray connector on module to see if it is powered.
Sound system not functioning	Circuit breaker CB11 tripped	<ol style="list-style-type: none"> 1. Check CB11 2. Check / replace fuse F148, F200
Fire alarm telltale light and audible alarm always ON and there is no fire or high temperature in the engine compartment	Short-circuited fire sensor or defective sensor	Prior to start the vehicle, cycle the ignition key to the ON position, OFF position and then ON position again and then start the vehicle. This will deactivate the fire alarm function. This has to be repeated each time the vehicle is re-started
The vehicle is parked and the electrical horn is activated to indicate a fire in the engine compartment but there is no fire	Short-circuited fire sensor or defective sensor	Cycle the ignition key between the ON and OFF position twice within 3 seconds. This will deactivate the fire alarm function. This has to be repeated each time the vehicle is parked

Problem/Symptom	Probable Causes	Actions
A single light, a group of LED lights or another function of the vehicle is not functioning	The multiplex outputs are protected in current by an internal "soft-fuse". When an output is shorted, it turns OFF and stays OFF until the "soft-fuse" is reset	Turn the ignition key to the OFF position and turn to the ON position again. This resets all "soft –fuses"
No backlighting in the instrument cluster	Circuit breaker CB10 is tripped or fuse F10/F29 blown	<p>Check circuit breaker CB2, CB10</p> <p>Check / replace fuse F10, F29</p> <p>Check / replace relay R22, R23</p>
The radiator/CAC fans do not function and the engine is overheating		<p>You can manually engage the radiator/CAC fans half speed (50%) or full speed (100%).</p> <ol style="list-style-type: none"> 1. On the Driver Information Display, select DIAGNOSTICS menu. Select VEHICLE TESTS submenu and then ACTIVATE RADIATOR FAN SPEED 50% or ACTIVATE RADIATOR FAN SPEED 100%. 2. The DID status line will show TEST to confirm the forced activation of the radiator fans. To cancel, turn the ignition switch to the OFF position or press ESCAPE button, select STOP TEST submenu and then press ENTER button twice. TEST will disappear from the DID status line.

APPENDIX C

ALLISON TRANSMISSION 5TH GENERATION OIL LEVEL CHECK USING THE PUSHBUTTON SHIFT SELECTOR	2
CONTROL SYSTEM PROGNOSTICS	2
NORMAL PROGNOSTICS INDICATION AT ENGINE START	3
OIL LIFE MONITOR	3
FILTER LIFE MONITOR	4
TRANSMISSION HEALTH MONITOR	5
DIAGNOSTIC TROUBLESHOOTING CODES (DTC) — ALLISON 5TH GENERATION CONTROLS	7
DIAGNOSTIC TROUBLESHOOTING CODES (DTC) OVERVIEW	7
USING SHIFT SELECTOR FOR ACCESSING DIAGNOSTICS INFORMATION	7
DIAGNOSTIC CODE DISPLAY AND CLEARING PROCEDURE.....	7
DIAGNOSTIC TROUBLE CODE RESPONSE	8
DIAGNOSTIC TROUBLESHOOTING CODES (DTC) LIST - ALLISON 5 TH GENERATION CONTROLS.....	9

2 APPENDIX C – Allison Transmission’s Other Features

ALLISON TRANSMISSION 5TH GENERATION OIL LEVEL CHECK USING THE PUSHBUTTON SHIFT SELECTOR

The oil level sensor (OLS) is standard in your transmission. With the OLS and Allison 5th generation shift selector, you can get a more accurate electronic fluid level check than with a dipstick.

Oil level codes are obtained as follows:

1. Park vehicle on a level surface, select «N» (neutral) on the pushbutton shift selector and apply parking brake.
2. Wait for at least 2 minutes to allow the oil to settle;
3. Press simultaneously the ▲ (Upshift) and ▼ (Downshift) arrow buttons once.
4. Oil level codes are displayed once the following parameters are met :
 - **The vehicle has been stationary for approximately 2 minutes to allow the oil to settle;**
 - **Engine at idle;**
 - **Oil at normal operating temperature, between 104°F (40°C) and 220°F (104°C);**
 - **Transmission in «N» (Neutral);**
 - **Transmission output shaft stopped;**
 - **Oil level sensor present and working.**

5. Correct fluid level is displayed as shown.



6. Low fluid level is displayed as shown. The number indicates the number of quarts of fluid the transmission requires.



7. High fluid level condition with the number of quarts in excess is displayed as shown.



NOTE

Confirm a low fluid level condition by making a manual fluid level check.

8. To exit the Oil Level Display Mode, press any range button «R», «N» or «D» at any time.

NOTE

Note that the quantities LO 4 and HI 3 are the largest values displayed and that the actual variation in oil level may exceed these numbers.

If the fluid level check cannot be completed, an Invalid for Display fault is reported. Refer to table below to review the codes and conditions.

CODE	CAUSE OF FAULT CODE
SETTLING OK	Settling time too short
ENG RPM TOO LOW	Engine speed (rpm) too low
ENG RPM TOO HIGH	Engine speed (rpm) too high
MUST BE IN NEU	N (Neutral) must be selected
OIL TEMP TOO LOW	Sump fluid temperature too low
OIL TEMP TOO HIGH	Sump fluid temperature too high
VEH SPD TOO HI	Output shaft speed
SENSOR FAILED	Sensor failure

CONTROL SYSTEM PROGNOSTICS

The transmission control system includes the provision for the user to monitor various transmission operating parameters. Transmission operating parameters monitored by the prognostics feature are:

- Oil Life Monitor
- Filter Life Monitor
- Transmission Health Monitor

NOTE

*The prognostics package requires the use of **TranSynd™** or an Allison approved **TES295 or TES389 licensed fluid** in the transmission and **Allison High Capacity filters**. If any other fluids or filters are used, Prognostic mode **must be disabled**. Prognostic information will not be accurate with any other fluids or filters and could result in missed maintenance activities resulting in transmission damage.*

Refer to TES 295 or TES389 Approved Fluids list, found under the Service/Fluids heading on the home page of the Allison Transmission web site.

www.allisontransmission.com

When a specified threshold is detected for any of the serviceable conditions, the TRANSMISSION SERVICE indicator **↑** is illuminated to alert the operator. Failure to attend to the service condition and reset the TRANSMISSION SERVICE indicator within a defined operating period will result in illumination of the CHECK light with associated message in the DID, indicating the increased probability that the service condition will develop into a more serious condition.

To access the Prognostic Mode functions, simultaneously press the **▲** (Upshift) and **▼** (Downshift) arrow buttons repeatedly. See the reference table at the end of this section.

NORMAL PROGNOSTICS INDICATION AT ENGINE START

- A system bulb check illuminates the TRANSMISSION SERVICE indicator **↑** approximately 0.5 seconds.
- If Prognostics features are enabled, the TRANSMISSION SERVICE indicator **↑** illuminates again for 3 seconds after the bulb check. If Prognostics features are disabled, the TRANSMISSION SERVICE indicator **↑** does not illuminate again after the bulb check.

OIL LIFE MONITOR

The display message denotes the calculated remaining life of the transmission fluid. This value is based on the established life for the required baseline fluid, and then is continuously adjusted for cumulative

effects of such operating parameters as operating time, retarder operation, output shaft revolutions and shift frequency.

Display

The display is a two-digit number, denoting percentage of the fluid life which remains. New fluid is displayed as 99%.

The TRANSMISSION SERVICE indicator **↑** will be illuminated, denoting a required change of transmission fluid, when the remaining fluid life reaches approximately 1 %. The indicator will be lit steadily upon each initialization of the TCM, and will remain on steady for approximately 2 minutes after the first selection of “D” (drive) range each time, until service is performed and the indicator is reset.

Failure to perform maintenance and reset the TRANSMISSION SERVICE indicator within a defined period will result in the illumination of the CHECK light with associated message in the DID and diagnostic code P0897 Transmission Fluid Deteriorated.

Reset

The TRANSMISSION SERVICE indicator can be reset by a message over the SAE J1939 communication interface, with the Allison DOC™ for PC diagnostic program, or by depressing and holding the MODE button for ten (10) seconds while the Oil Life Monitor function is displayed. It may also be reset by selecting N-D-N-D-N-R-N on the shift selector, pausing briefly (less than 3 seconds) between each selector movement, with the ignition on and the engine not running. The TRANSMISSION SERVICE indicator illuminates briefly following a reset to acknowledge the reset was successful.

Setting Fluid Type for Prognostics

The fluid type can be programmed if the specific calibration allows it. The operator can do the following:

With the engine off and the ignition on, perform the following sequence on the selector, N-R-N-D-N-R-N-D-N-D-N.

The TRANSMISSION SERVICE indicator flashes if TES389 is the current setting and illuminates solidly if TES295 is the current setting. To change the transmission fluid type, wait 5 seconds after entering transmission fluid

4 APPENDIX C – Allison Transmission’s Other Features

type mode and perform the following sequences to select the proper transmission type:

N-R-N to select TES295

N-D-N to select TES389

The selector exits 30 seconds after entering transmission fluid type mode or the ignition may be turned off to exit earlier. Only one transmission fluid type selection may be made after entering transmission fluid type mode. All other attempt will be ignored. Transmission fluid type mode needs to be entered again if the wrong type of fluid is selected.



CAUTION

Verify prognostics fluid type setting matches transmission fluid type. Oil Life Monitor notifications will be inaccurate when mismatched. This could result in transmission damage from running a TES389 fluid too long or cause shortened TES295 fluid changes to occur.



CAUTION

Required calendar-based oil & filter change intervals (based on month) still apply because Oil Life Monitor function cannot measure time while ignition power is OFF.

If the Oil Life Monitor function has not indicated the need for a fluid change before 60 months have passed when using TES295 fluid type or before 24 months have passed when using TES389 fluid type, it will be necessary to change the fluid and filters per calendar requirements and reset the system.

FILTER LIFE MONITOR

This feature provides an alert when the transmission’s fluid filters need to be replaced. It helps extend filter change intervals to reduce routine maintenance downtime while providing maximum protection for the transmission.

The filter life indicator pressure switch signals the transmission control module when fluid exiting the main filter drops below a predetermined pressure. Both the main and lube filters **must be** changed when the TRANSMISSION SERVICE indicator  shows the main filter should be changed.



Filter Change Notification

The TRANSMISSION SERVICE indicator  will flash for 2 minutes after the first selection of “D” (drive) range. Once the Filter Monitor mode has been accessed via the shift selector, the "OIL FILTER OK" or "REPLACE FILTERS" message is displayed in the selector display window. An acceptable filter life status is displayed as "OIL FILTER OK". An unacceptable filter life status is displayed as "REPLACE FILTERS".

Once the programmed threshold for maximum filter pressure drop has been observed and verified, the diagnostic code P088A Transmission Filter Maintenance Alert will be recorded to indicate that the filter has reached the end of its designed life. At the next initialization of the TCM, the TRANSMISSION SERVICE indicator  will flash for 2 minutes after the first selection of “D” (drive) range. Thereafter, the indicator will illuminate and flash upon each TCM initialization, continuing to flash for 2 minutes after the first selection of a drive range each time, until service is performed and the indicator is reset.

Failure to perform maintenance and reset the monitor after a calibration-defined number of warnings will result in the illumination of the CHECK light with associated message in the DID and diagnostic code P088B will be recorded to indicate a highly deteriorated filter.

Read and Reset Filter Life Monitor from Selector

To enter the filter life monitor, press simultaneously the  (Upshift) and  (Downshift) arrows three times. An acceptable filter life status is displayed as "OIL FILTER OK". An unacceptable filter life status is displayed as "REPLACE FILTERS".

The feature will **reset** automatically when the main fluid filter has been changed and the pressure drop across the filter no longer exceeds the threshold value. A manual reset can be performed by depressing and holding the MODE button for ten (10) seconds while the Filter Life Monitor function is displayed. It may also be reset by selecting N-R-N-R-N-D-N on the shift selector, pausing briefly (less than 3 seconds) between each selector movement, with the ignition on and the engine not running. The TRANSMISSION SERVICE indicator  illuminates briefly following a reset to acknowledge the reset was successful.

TRANSMISSION HEALTH MONITOR

This prognostic feature determines clutch life status of the transmission’s clutches and alerts you when clutch maintenance is required. The clutch life status is determined by monitoring changes and the calculated running clearance of the transmission clutches.

Clutch Maintenance Notification



The transmission health monitor feature determines when clutch maintenance is needed. If any of the clutches (except lockup) reaches a remaining life of approximately 10% or if any of the clutch running clearances exceeds a maximum value, then the TRANSMISSION SERVICE indicator is steadily illuminated from just after ignition on until ignition is turned off. Thereafter, the indicator will be lit upon each initialization of the TCM, and will remain on steady during all vehicle operation until service is performed and the indicator is reset. If the transmission health monitor mode has been accessed via the shift selector, a “TRANS HEALTH OK” or “TRANS HEALTH LO” is displayed. An acceptable clutch life status is displayed as “TRANS HEALTH OK”. An unacceptable clutch life status is displayed as “TRANS HEALTH LO”.

Read and Reset Transmission Health Monitor from Selector

To enter the transmission health monitor, press simultaneously the ▲ (Upshift) and ▼ (Downshift) arrows four times. An acceptable clutch life status is displayed as “TRANS HEALTH OK”. An unacceptable filter life status is displayed as “TRANS HEALTH LO”.

The feature will **reset** automatically upon elimination of the clutch clearance condition which initiated it. The indicator can also be manually reset using the Allison DOC™ for PC diagnostics program if necessary.

6 APPENDIX C – Allison Transmission’s Other Features

 (Upshift) &  (Downshift) arrow buttons pressed simultaneously *	Description	Message	
1 st press	Allison transmission oil level check		
2 nd press	Oil Life Monitor Oil life remaining will range from 99% down to 00%	" O " Some number from 9 to 0	" M " Some number from 9 to 0
3 rd press	Filter Life Monitor Present life of filter is acceptable Present life of filter is unacceptable	" F " OIL FILTER OK REPLACE FILTERS	" M "
4 th press	Transmission Health Monitor Shows " TRANS HEALTH OK " until remaining life of one or more of the clutch(es) wear enough so that the programming changes One or more of the clutches have worn enough to change the program	" T " TRANS HEALTH OK TRANS HEALTH LO	" M "
5 th press	Display of diagnostic codes		

* With the engine off and ignition on.

DIAGNOSTIC TROUBLESHOOTING CODES (DTC) — ALLISON 5TH GENERATION CONTROLS

DIAGNOSTIC TROUBLESHOOTING CODES (DTC) OVERVIEW

Diagnostic features are provided with the transmission control system to assist in troubleshooting of malfunctions and/or the monitoring of specific operating parameters. When a control system malfunction is detected, a series of Diagnostic Trouble Codes (DTCs) are used to identify and clarify the nature of the malfunction. These DTCs are each named by a 5 character alphanumeric string that refers to a diagnostic algorithm running pass/fail tests to help identify a malfunction in the transmission or vehicle operation. Most DTCs have some kind of diagnostic response that the operator notices, such as an illuminated CHECK light, selector display change, lock in range, or inhibit shifts condition.

DTCs are logged in the Transmission Control Module (TCM) memory by severity and by their active/inactive status with the most severe and active codes listed first. A maximum of five DTCs (numbered d1- d5) from most recent to oldest may be read from the shift selector. As DTCs are added, the oldest inactive DTC (historic) is dropped from the list. If all DTCs are active, the DTC with the lowest priority is dropped from the list.

An active code is any code that is current in the TCM decision-making process and has failed the DTC test(s) associated with that specific diagnostic algorithm. Historical codes, which are by definition inactive, are codes that are no longer failing their algorithm but are retained in the TCM in order to help the technician analyze possible causes and provide them direction if the vehicle is brought in before they are cleared from the queue.

DTCs can be cleared manually by the operator or they clear automatically from last (d5) to first (d1) in the queue after a number of engine starts, without becoming active again.

USING SHIFT SELECTOR FOR ACCESSING DIAGNOSTICS INFORMATION

DTCs can be displayed on the display portion of the shift selector. A DTC is either active or historic. An active DTC is a DTC that is current in the TCM decision-making process. Historic DTCs are retained in the TCM memory and do not necessarily affect the TCM decision-making process.

Display Sequence

Up to five DTCs may be displayed one at a time from the selector once the diagnostic display mode has been initiated by the operator. Each DTC is 5 characters in length. The DTC status active or inactive is shown below the DTC.



Shows active DTC P0730

The operator presses the MODE button to read the next DTC in the queue (if any) or requests to exit diagnostics mode. The diagnostics mode times out and returns the selector to normal operating mode after approximately 10 minutes of operator inactivity.

DIAGNOSTIC CODE DISPLAY AND CLEARING PROCEDURE

Diagnostic codes can be read and cleared by two methods:

- Using an Allison DOC™ diagnostic tool. For specific instructions on how to use an Allison DOC™ diagnostic tool, refer to the User Guide.
- Using the pushbutton shift selector.

8 Appendix C – Allison Diagnostic Troubleshooting Codes

To begin the diagnostic process:

1. Bring the vehicle to a stop at a safe location.
2. Apply the parking brake.

To display stored codes:

1. Simultaneously press the ▲ (Upshift) and ▼ (Downshift) arrow buttons five times (Prognostics enabled) to access the Diagnostic Display Mode. With Prognostics disabled, press the ▲ (Upshift) and ▼ (Downshift) arrow buttons twice.
2. Press the MODE button to read the next code in the queue, if any.

To clear all active stored codes:

While in Diagnostic Mode, clear all active codes by pressing and holding the MODE button for approximately three seconds until the MODE message flashes. Release the MODE button. The MODE message should not remain illuminated if the active DTC shown in the display has cleared.

While in Diagnostic Mode, press and hold the MODE button for 10 seconds to clear both active codes and inactive codes. The MODE message flashes a second time indicating all codes are cleared from the queue.

Exiting Diagnostic Mode

Exit the diagnostic mode by one of the following methods:

1. Press simultaneously the ▲ (Upshift) and ▼ (Downshift) arrow buttons at the same time on the pushbutton shift selector.
2. Press any range button «D», «N» or «R» on the pushbutton shift selector.
3. After approximately 10 minutes of inactivity at the pushbutton shift selector, the diagnostic mode automatically exits and returns to normal operating mode.
4. Turn off power to the TCM (shut off the engine using the ignition key).

NOTE

Be sure to record all codes displayed before they are cleared. This is essential for troubleshooting.

NOTE

If clearing a code while locked in a «D» (Drive) or «R» (Reverse) position (fail-to-range), the transmission will still be in «D» (Drive) or «R» (Reverse) when the clearing procedure is completed. «N» (Neutral) must be manually selected.

DIAGNOSTIC TROUBLE CODE RESPONSE

The electronic control system is programmed to inform the operator of a problem with the transmission system via the CHECK light and shift selector display while it automatically takes action to protect the operator, vehicle, and transmission. When the Transmission Control Module (TCM) flags a Diagnostic Trouble Code (DTC) as active, the TCM may take a combination of diagnostic responses as listed in the table below.

CATEGORY OF RESPONSE	ACTIONS TAKEN
DNS - <u>Do Not Shift</u>	Release lock up (LU) clutch and inhibit lock up operation. Inhibit shifts from the current attained range. Turn on the CHECK light. Display the current attained range in the MONITOR window of the shift selector. Blank the SELECT window of the shift selector. Ignore any range selection inputs from the shift selector.
SOL OFF - <u>SOLenoid OFF</u>	All solenoids are commanded off, resulting in hydraulic default operation of the transmission – PCS1 & PCS2 are on hydraulically when off electrically.
RPR - Return to Previous Range	When the speed sensor ratio or PS1 tests do not pass, the TCM commands the same range as commanded before the shift.
NNC - Neutral No Clutches	When certain speed sensor ratio or PS1 tests do not pass, the TCM a neutral condition with no clutches applied.
DNA - <u>Do Not Adapt</u>	The TCM stops adaptive shift control while the code is active.

DIAGNOSTIC TROUBLESHOOTING CODES (DTC) LIST - ALLISON 5TH GENERATION CONTROLS

DTC	Description	CHECK Light	Inhibited Operation Description
C1312	Retarder Request Sensor Failed Low	No	May inhibit retarder operation if not using J1939 datalink
C1313	Retarder Request Sensor Failed High	No	May inhibit retarder operation if not using J1939 datalink
P0122	Pedal Position Sensor Circuit Low Voltage	No	Use default throttle values. Freezes shift adapts.
P0123	Pedal Position Sensor Circuit High Voltage	No	Use default throttle values. Freezes shift adapts.
P0218	Transmission Fluid Over Temperature	Yes	Use default sump temp
P0562	System Voltage Low	No	Inhibit TCC Operation, DNA
P0602	TCM Not Programmed	Yes	Lock in Neutral
P0604	Control module random access memory (RAM)	Yes	Lock in Neutral
P0614	Torque Control Data Mismatch - ECM/TCM	Yes	Allows operation only in reverse and second range.
P0634	TCM Internal Temperature Too High	Yes	SOL OFF (hydraulic default)
P0642	Sensor Reference Voltage "A" Circuit Low	Yes	Default sensor data used
P0643	Sensor Reference Voltage "A" Circuit High	Yes	Default sensor data used
P0657	Actuator Supply Circuit Voltage 1 Open (HSD 1)	Yes	SOL OFF, DNA, Inhibit TCC operation, Inhibit main modulation
P0658	Actuator Supply Voltage 1 (HSD1) Low	Yes	DNS, SOL OFF (hydraulic default)
P0659	Actuator Supply Voltage 1 (HSD1) High	Yes	DNS, SOL OFF (hydraulic default)
P0703	Brake Switch Circuit Malfunction	No	No Neutral to Drive shifts for refuse packer. TCM inhibits retarder operation if a TPS code is also active.
P0708	Transmission Range Sensor Circuit High Input	Yes	Ignore defective strip selector inputs
P070C	Transmission Fluid Level Sensor Circuit – Low Input	No	None

10 Appendix C – Allison Diagnostic Troubleshooting Codes

DTC	Description	CHECK Light	Inhibited Operation Description
P070D	Transmission Fluid Level Sensor Circuit – High Input	No	None
P0712	Transmission Fluid Temperature Sensor Circuit Low Input	Yes	Use default sump temp
P0713	Transmission Fluid Temperature Sensor Circuit High Input	Yes	Use default sump temp
P0715	Turbine Shaft Speed Sensor Circuit	Yes	DNS, Lock in current range
P0716	Turbine Shaft Speed Sensor Circuit Performance	Yes	DNS, Lock in current range
P0717	Turbine Shaft Speed Sensor Circuit No Signal	Yes	DNS, Lock in current range
P071A	RELS Input Failed On	Yes	Inhibit RELS operation
P071D	General Purpose Input Fault	Yes	None
P0720	Output Shaft Speed Sensor Circuit	Yes	DNS, Lock in current range
P0721	Output Shaft Speed Sensor Circuit Performance	Yes	DNS, Lock in current range
P0722	Output Speed Sensor Circuit No Signal	Yes	DNS, Lock in current range
P0725	Engine Speed Sensor Circuit	No	Default to turbine speed
P0726	Engine Speed Sensor Circuit Performance	No	Default to turbine speed
P0727	Engine Speed Sensor Circuit No Signal	No	Default to turbine speed
P0729	Incorrect 6 th Gear Ratio	Yes	DNS, Attempt 5 th , then 3 rd
P0731	Incorrect 1 st Gear ratio	Yes	DNS, Attempt 2 nd , then 5 th
P0732	Incorrect 2 nd Gear ratio	Yes	DNS, Attempt 3 rd , then 5 th
P0733	Incorrect 3 rd Gear ratio	Yes	DNS, Attempt 4 th , then 6 th
P0734	Incorrect 4 th Gear ratio	Yes	DNS, Attempt 5 th , then 3 rd
P0735	Incorrect 5 th Gear ratio	Yes	DNS, Attempt 6 th , then 3 rd , then 2 nd
P0736	Incorrect Reverse Gear ratio	Yes	DNS, Lock in Neutral
P0741	Torque Converter Clutch System Stuck Off	Yes	None
P0752	Shift Solenoid 1 Valve Performance-Stuck On	Yes	DNS
P0776	Pressure Control Solenoid (PCS) 2 Stuck Off	Yes	DNS, RPR
P0777	Pressure Control Solenoid 2 Stuck On	Yes	DNS, RPR
P0796	Pressure Control Solenoid 3 Stuck Off	Yes	DNS, RPR
P0797	Pressure Control Solenoid 3 Stuck On	Yes	DNS, RPR
P0842	Transmission Fluid Pressure Switch 1 Circuit Low	Yes	DNS, Lock in current range
P0843	Transmission Fluid Pressure Switch 1 Circuit High	Yes	DNS, Lock in current range
P0847	Transmission Fluid Pressure Switch 2 Circuit Low	Yes	None
P0848	Transmission Fluid Pressure Switch 2 Circuit High	Yes	None
P088A	Transmission Fluid Filter Maintenance Alert	No	None
P088B	Transmission Fluid Filter Maintenance Required	No	None
P0880	TCM Power Input Signal	No	None
P0881	TCM Power Input Signal Performance	No	None
P0882	TCM Power Input Signal Low	Yes	DNS, SOL OFF (hydraulic default)
P0883	TCM Power Input Signal High	No	None
P0894	Unexpected Mechanical Gear Disengagement	Yes	DNS, Lock in first
P0897	Transmission Fluid Deteriorated	No	None
P0960	Main Pressure Modulator Solenoid Control Circuit Open	Yes	None
P0962	Main Pressure Modulator Solenoid Control Circuit Low	Yes	DNS, SOL OFF (hydraulic default)
P0963	Main Pressure Modulator Solenoid Control Circuit High	Yes	None
P0964	Pressure Control Solenoid 2 (PCS2) Control Circuit Open	Yes	DNS, SOL OFF (hydraulic default)
P0966	Pressure Control Solenoid 2 (PCS2) Control Circuit Low	Yes	DNS, SOL OFF (hydraulic default)

DTC	Description	CHECK Light	Inhibited Operation Description
P0967	Pressure Control Solenoid 2 (PCS2) Control Circuit High	Yes	DNS, SOL OFF (hydraulic default)
P0968	Pressure Control Solenoid 3 (PCS3) Control Circuit Open	Yes	DNS, SOL OFF (hydraulic default)
P0970	Pressure Control Solenoid 3 (PCS3) Control Circuit Low	Yes	DNS, SOL OFF (hydraulic default)
P0971	Pressure Control Solenoid 3 (PCS3) Control Circuit High	Yes	DNS, SOL OFF (hydraulic default)
P0973	Shift Solenoid 1 (SS1) Control Circuit Low	Yes	DNS, SOL OFF (hydraulic default)
P0974	Shift Solenoid 1 (SS1) Control Circuit High	Yes	DNS, SOL OFF (hydraulic default)
P0976	Shift Solenoid 2 (SS2) Control Circuit Low	Yes	7-speed: Allow 2 through 6, N, R Inhibit TCC operation
P0977	Shift Solenoid 2 (SS2) Control Circuit High	Yes	7-speed: Allow 2 through 6, N, R
P097A	Shift Solenoid 1 (SS1) Control Circuit Open	Yes	Lock in range
P097B	Shift Solenoid 2 (SS2) Control Circuit Open	Yes	7-speed: Allow 2 through 6, N, R
P0989	Retarder Pressure Sensor Circuit Low	No	None
P0990	Retarder Pressure Sensor Circuit High	No	None
P1739	Incorrect Low Gear Ratio	Yes	Command 2 nd and allow shifts 2 through 6, N, R
P1790	Gear Shift Module 1 Calibrated Invalid	Yes	Shift selector language or units incorrect
P1791	Gear Shift Module 2 Calibrated Invalid	Yes	Shift selector language or units incorrect
P1891	Throttle Position Sensor PWM Signal Low	No	Use default throttle values
P1892	Throttle Position Sensor PWM Signal High	No	Use default throttle values
P2184	Engine Coolant Temperature Sensor 2 Circuit Low Input	No	Use default engine coolant values
P2185	Engine Coolant Temperature Sensor 2 Circuit High Input	No	Use default engine coolant values
P2637	Torque Management Feedback Signal (A)	Yes	Inhibit SEM
P2641	Torque Management Feedback Signal (B)	Yes	Inhibit LRTP
P2669	Actuator Supply Circuit Voltage 2 Open (HSD2)	Yes	SOL OFF, Inhibit TCC operation, Inhibit Main modulation, ONA
P2670	Actuator Supply Voltage 2 (HSD2) Low	Yes	DNS, SOL OFF (hydraulic default)
P2671	Actuator Supply Voltage 2 (HSD2) High	Yes	DNS, SOL OFF (hydraulic default)
P2684	Actuator Supply Circuit Voltage 3 Open (HSD3)	Yes	SOL OFF, Inhibit TCC operation, Inhibit Main modulation, ONA
P2685	Actuator Supply Voltage 3 (HSD3) Low	Yes	DNS, SOL OFF (hydraulic default)
P2686	Actuator Supply Voltage 3 (HSD3) High	Yes	DNS, SOL OFF (hydraulic default)
P2714	Pressure Control Solenoid 4 (PCS4) Stuck Off	Yes	DNS, RPR
P2715	Pressure Control Solenoid 4 (PCS4) Stuck On	Yes	DNS, SOL OFF (hydraulic default)
P2718	Pressure Control Solenoid 4 (PCS4) Control Circuit Open	Yes	DNS, SOL OFF (hydraulic default)
P2720	Pressure Control Solenoid 4 (PCS4) Control Circuit Low	Yes	DNS, SOL OFF (hydraulic default)
P2721	Pressure Control Solenoid 4 (PCS4) Control Circuit High	Yes	DNS, SOL OFF (hydraulic default)
P2723	Pressure Control Solenoid 1 (PCS1) Stuck Off	Yes	DNS, RPR
P2724	Pressure Control Solenoid 1 (PCS1) Stuck On	Yes	DNS, RPR
P2727	Pressure Control Solenoid 1 (PCS1) Control Circuit Open	Yes	DNS, SOL OFF (hydraulic default)
P2729	Pressure Control Solenoid 1 (PCS1) Control Circuit Low	Yes	DNS, SOL OFF (hydraulic default)
P2730	Pressure Control Solenoid 1 (PCS1) Control Circuit High	Yes	DNS, SOL OFF (hydraulic default)
P2736	Pressure Control Solenoid 5 (PCS5) Control Circuit Open	Yes	Inhibit retarder operation
P2738	Pressure Control Solenoid 5 (PCS5) Control Circuit Low	Yes	Allow 2 through 6, N, R. Inhibit retarder and TCC operation
P2739	Pressure Control Solenoid 5 (PCS5) Control Circuit High	Yes	Inhibit retarder operation

12 Appendix C – Allison Diagnostic Troubleshooting Codes

DTC	Description	CHECK Light	Inhibited Operation Description
P273F	Retarder Oil Temperature Sensor Over Temperature Condition	No	None
P2742	Retarder Oil Temperature Sensor Circuit – Low	No	Use default retarder temp values
P2743	Retarder Oil Temperature Sensor Circuit – High	No	Use default retarder temp values
P2761	TCC PCS Control Circuit Open	Yes	Inhibit TCC operation
P2763	TCC PCS Control Circuit High	Yes	Inhibit TCC operation
P2764	TCC PCS Control Circuit Low	Yes	7-speed: Allow 2 through 6, N, R. Inhibit TCC operation
P2789	Transmission Clutch Life Expired (Clutch Adaptive Learning at Limit)	No	None
P2793	Gear Shift Direction Circuit	Yes	Ignores PWM input from shift selector
P2808	Pressure Control Solenoid 6 (PCS6) Stuck Off	Yes	DNS, RPR
P2809	Pressure Control Solenoid 6 (PCS6) Stuck On	Yes	DNS, RPR
P2812	Pressure Control Solenoid 6 (PCS6) Control Circuit Open	Yes	DNS, SOL OFF (hydraulic default)
P2814	Pressure Control Solenoid 6 (PCS6) Control Circuit Low	Yes	DNS, SOL OFF (hydraulic default)
P2815	Pressure Control Solenoid 6 (PCS6) Control Circuit High	Yes	DNS, SOL OFF (hydraulic default)
U0073	CAN Communication Bus 1 Off	No	Use default values
U0074	CAN Communication Bus 2 Off	No	Use default values
U0100	Lost Communications with ECM A	Yes	Use default values
U0103	Lost Communication with Gear Shift Module (Shift Selector) 1	Yes	Maintain range selected, observe gear shift direction circuit
U0291	Lost Communication with Gear Shift Module (Shift Selector) 2	Yes	Maintain range selected, observe gear shift direction circuit
U0304	Incompatible Gear Shift Module 1 (Shift Selector)	Yes	Ignore shift selector inputs
U0333	Incompatible Gear Shift Module 2 (Shift Selector)	Yes	Ignore shift selector inputs
U0404	Invalid Data Received From Gear Shift Module (Shift Selector) 1	Yes	Maintain range selected, observe gear shift direction circuit
U0592	Invalid Data Received From Gear Shift Module (Shift Selector) 2	Yes	Maintain range selected, observe gear shift direction circuit

OPERATIONAL FAILURE SYMPTOMS VIA FAULT/FLASH CODE

The following table lists the possible faults which can be read by flashing code off of an appropriate timer, the equipment-on indicator /operation indicator flashes.

Failure Symptom	Probable Cause	Check and Correct
1X Flash (F 01) No combustion after completion of start up sequence.	- Fuel system - Combustion air - Electronic ignition	- Fuel level - Type of fuel being used - Fuel filter - Fuel line connections (air bubbles in fuel lines) - Fuel nozzle plugged - Air intake or exhaust, restricted or plugged - Incorrect electrode gap
2X Flashes (F 02) Flame out during burner operation no restart possible	- Fuel supply (shortage of fuel)	- Restriction in the fuel system - Fuel filter - Fuel line connections (air bubbles in fuel lines) - Type of fuel being used
3X Flashes (F 03) Low voltage for more than 20 seconds	- Electrical system	- Load test batteries - Corrosion at connections - Loose connections
4X Flashes (F 04) Flame detector recognizes false flame signal during pre-start or shut-down cycle	- Defective flame detector	- Replace flame detector
5X Flashes (F 05) Flame detector	- Wiring - Defective flame detector	- Damaged wiring, open or short circuit - Replace flame detector
6X Flashes (F 06) Temperature sensor	- Wiring - Defective temperature sensor	- Damaged wiring, open or short circuit - Replace temperature sensor
7X Flashes (F 07) Fuel solenoid valve	- Wiring - Defective solenoid valve	- Damaged or corroded wiring, open or short circuit - Replace solenoid valve
8X Flashes (F 08) Combustion air fan motor	- Wiring - Wrong RPM - Defective combustion air fan motor	- Damaged wiring, open or short circuit - Replace combustion air fan - Replace combustion air fan
9X Flashes (F 09) Circulation pump motor	- Wiring - Defective circulation pump motor	- Damaged wiring, open or short circuit - Replace circulation pump motor
10X Flashes (F 10) Temperature limiter	- Overheat condition - Coolant flow - Wiring - Defective temperature limiter	- Reset temperature limiter - Coolant level or flow restriction - Air trapped in coolant circuit - Damaged or corroded wiring, open or short circuit - Replace temperature limiter
11X Flashes (F 11) Electronic ignition coil	- Wiring - Defective electronic ignition coil	- Damaged wiring, open or short circuit - Replace electronic ignition coil
12X Flashes (F 12) Heater lock out	- 3 repeated faults/flame-outs or 5 repeated start attempts	- Reinitialize control unit by switching heater on and disconnecting power.

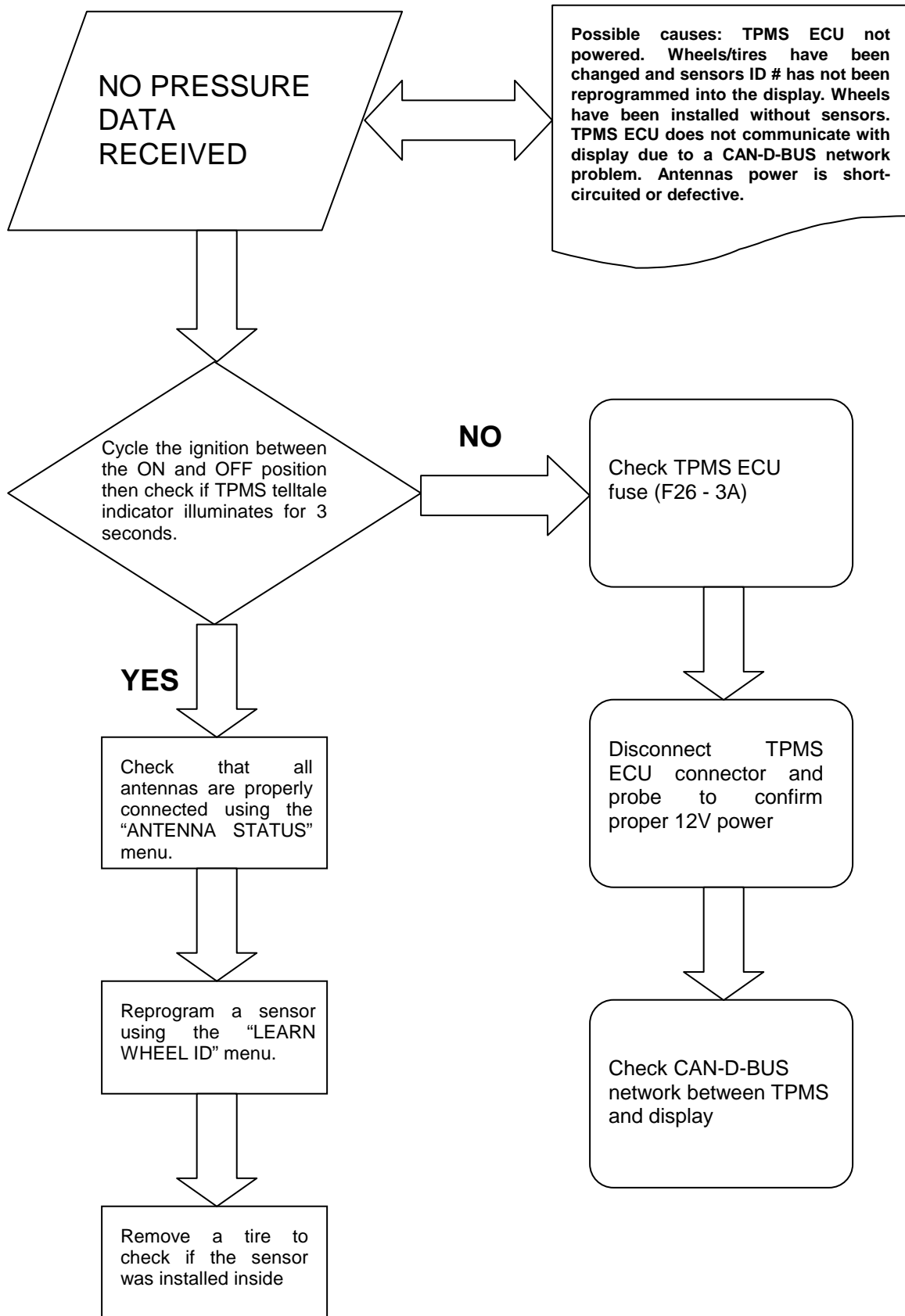

2 Appendix E – TPMS Troubleshooting Guide

