



**PREVOST.**

Prevost Vehicles – All Series

# **MAINTENANCE MANUAL**

PA-1621



# **MAINTENANCE MANUAL**

H3-41, H3-45, H3-45 VIP  
X3-45, X3-45 VIP

**PA1621**

Revision 04

# PA1621

## Featuring:

- H series new electrical architecture
- H Series electric cooling fans.

## This manual is applicable from the following vehicles:

- K-0185 (H Series)
- H-6180 (X Series CAN)
- H-7417 (X-Series US)

## Including the following individual vehicles:

- J-0086
- J-0124
- H-7386
- H-7395

REV	FROM V.I.N.	DESCRIPTION	ISSUED
00		Initial release	Jan 2017
01	K-0185	H Series electric cooling fans H series new electrical architecture OBD18 & ABS 8	Jan 2018
02	J-6318 (X-series) K-0295 (H-series) Incl: J-0113, J-0155	Section 26a <u>H3-45VIP</u> Slide-Out, General revision. New seal and mechanical update.	Mar 2018
03	J-6313 (X-Series) J-7315 (Commuter)	X Series Coolant Recovery tank X Series Commuter info added	June 2018
04	K-6440 (X-Series) K-7608 (Commuter) K-0605 (H-Series)	OBD19	February 2019

## CRITICAL EMISSION-RELATED MAINTENANCE

### Source of parts and repair:

A repair shop or person of the owner's choosing must maintain, replace, or repair emission control devices and systems per manufacturer's recommendations.

### Replacement of tires that are GHG certified:

The original equipment tires installed on this vehicle at the factory were certified to the U.S. EPA Greenhouse Gas (GHG) and **National Highway Traffic Safety Administration (NHTSA)** Fuel Efficiency regulations. Replacement of these tires should be with a tire of equal or lower rolling resistance levels (TRRL or Crr). Please consult your tire supplier(s) for appropriate replacement tires.

### Maintaining a GHG certified tire:

In order to maintain the certified rolling resistance of the tires which optimize fuel economy, the maintenance procedures provide by the tire manufacturer must be followed.



## CONTENTS

<b>SECTION CHANGE LOG .....</b>	<b>2</b>
<b>1. FOREWORD .....</b>	<b>3</b>
<b>2. SCHEMATICS .....</b>	<b>3</b>
<b>3. SAFETY NOTICE.....</b>	<b>3</b>
<b>3.1 DATA PLATES AND CERTIFICATIONS.....</b>	<b>4</b>
3.1.1 <i>Engine</i> .....	4
3.1.2 <i>Transmission</i> .....	4
3.1.3 <i>Drive Axle</i> .....	4
3.1.4 <i>Front Axles</i> .....	4
3.1.5 <i>Coach Final Record</i> .....	5
3.1.6 <i>Safety Certification</i> .....	5
3.1.7 <i>DOT Certification Label</i> .....	5
3.1.8 <i>Fuel Tank Label</i> .....	5
3.1.9 <i>EPA Engine Label</i> .....	5
3.1.10 <i>Vehicle Identification Number (VIN)</i> .....	5
<b>4. FASTENER.....</b>	<b>8</b>
4.1 FASTENER STRENGTH IDENTIFICATION .....	8
4.2 STANDARD TORQUE SPECIFICATIONS .....	9
4.2.1 <i>SAE</i> .....	9
4.2.2 <i>Metric</i> .....	11
4.3 SELF-LOCKING FASTENERS .....	13
4.4 RECOMMENDATIONS FOR REUSE .....	13
4.5 SIX LOBED SOCKET HEAD .....	14
4.6 HOSE CLAMP TORQUE .....	17
<b>5. WELDING PROCESS.....</b>	<b>18</b>
5.1 STEEL – STEEL WELDING .....	18
5.2 STEEL WITH STAINLESS STEEL OR STAINLESS STEEL WITH STAINLESS STEEL WELDING .....	18
5.3 STEEL - STAINLESS STEEL WELDING .....	19

**SECTION CHANGE LOG**

DESCRIPTION		DATE
1	UPDATED FIGURE 6: I-Beam axle	Oct 2018
2		
3		
4		
5		
6		



## 1. FOREWORD

This manual includes procedures for diagnosis, service, maintenance and repair for components of all series of Prevost coaches and motorhomes listed on the front cover. This manual should be kept in a handy place for ready reference by the technician. If properly used, it will meet the needs of the technician and owner.

Information provided in Section 1 through 26 pertains to standard equipment items, systems and components as well as the most commonly used optional equipment and special equipment offered on the vehicle models covered by this manual. At the beginning of each section: a Table of Contents gives the page number on which each subject begins.

Vehicle operating information is provided in a separate Operator's Manual for coaches or Owner's Manual. Audio/Video system operator instructions are also included in a separate manual.

More specific information on engine, transmission and other systems or components operating, maintenance, and overhaul information is contained in the applicable service manual published by the OEM. Parts information may be contained in the applicable OEM parts catalog or service manual published by the OEM. All information, illustrations and specifications contained in this manual are based on the latest product information available at the time of publication approval. The right is reserved to make product changes at any time without notice.

### **NOTE**

*Illustrations in this manual are used for reference only and may differ slightly from the actual vehicle, however, key components addressed in the manual are represented as accurately as possible.*

Prevost occasionally sends Maintenance Information, Warranty Bulletins, Safety Recalls or other literature to update users with the latest service procedures. They are issued, when required, to supplement or supersede information in this manual. Update sheet should be filled out and bulletins should be filed at the end of their respective section for future reference.

## 2. SCHEMATICS

Vehicle pneumatic and electrical schematics can be found in your technical publications box. Refer to those schematics for detailed circuit information and diagnosis.

## 3. SAFETY NOTICE

This maintenance manual has been prepared in order to assist skilled mechanics in the efficient repair and maintenance of PREVOST vehicles.

This manual covers only the procedures as of manufacturing date.

Safety features may be impaired if other than genuine PREVOST parts are installed.

Torque wrench tightening specifications must be strictly observed. Locking devices must be installed or replaced by new ones, where specified. If the efficiency of a locking device is impaired, it must be replaced.

This manual emphasizes particular information outlined by the wording and symbols:



### **DANGER**

Directs the operator's attention to unsafe practices which could result in serious personal injury or death.



### **WARNING**

Directs the operator's attention to unsafe practices which could result in serious personal injury or severe damage to the vehicle.



### **CAUTION**

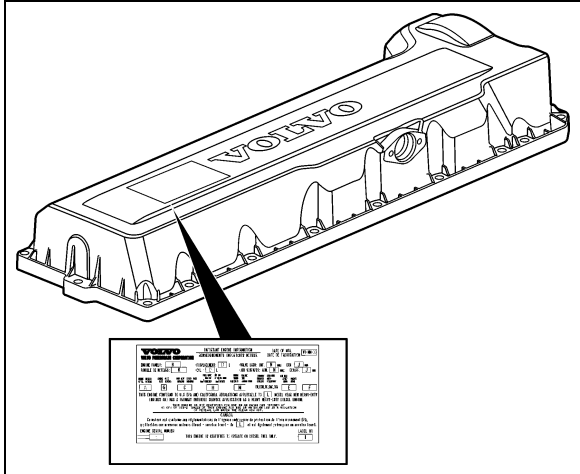
Directs the operator's attention to unsafe practices where personal injury is not likely but damage to vehicle components could occur.

**NOTE**  
*Indicates supplementary information essential to the proper operation of the vehicle. Although, the mere reading of such information does not eliminate the hazard, understanding of the information will promote its correct use.*

**3.1 DATA PLATES AND CERTIFICATIONS**

Delay and confusion can be avoided by placing the complete vehicle identification number of the vehicle and the serial numbers of the engine on parts orders and correspondence. Also, the transmission, axles, power steering pump chassis and other major components are identified by serial numbers.

**3.1.1 Engine**



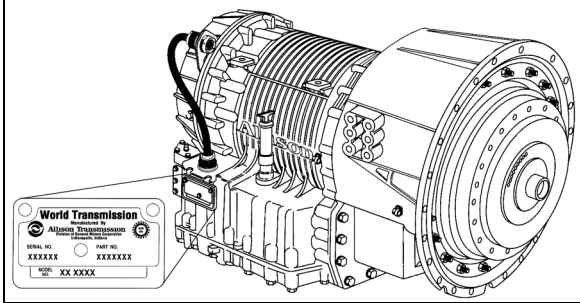
**FIGURE 1: VOLVO D13 ENGINE DATA PLATE** 00052

Volvo D13 engine serial and model numbers are stamped on the cylinder head. Also, the engine data plate certifies that the engine conforms to federal and any state exhaust emission regulations. It gives the operating conditions under which certification was made (Figure 1).

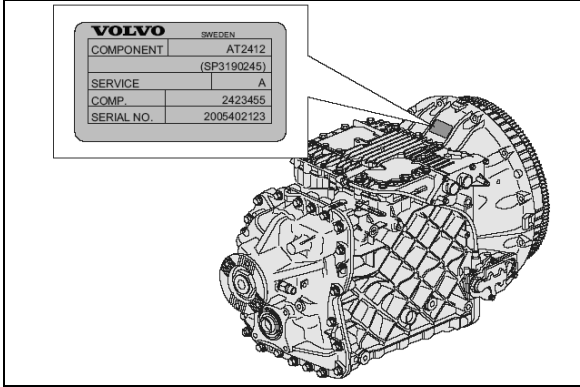
**3.1.2 Transmission**

The transmission identification plate is located on the oil level dipstick side of the transmission Allison (World) (Figure 2) or on transmission I-Shift (Figure 3). The identification plate shows the transmission serial number, part number

(assembly number), and model number. Use all three numbers when ordering parts.

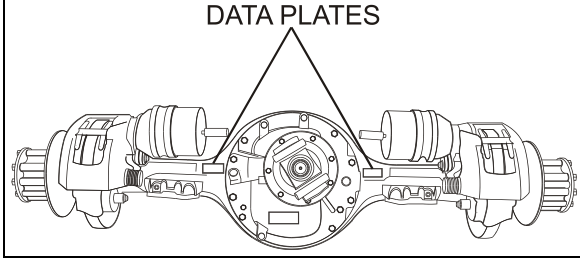


**FIGURE 2: ALLISON TRANSMISSION** 07076



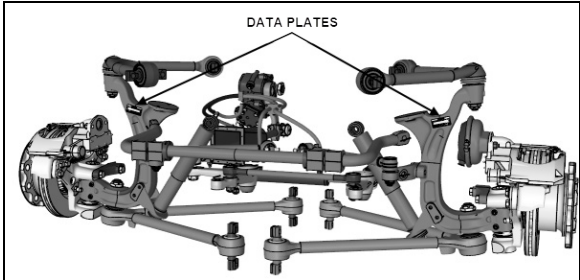
**FIGURE 3: I-SHIFT TRANSMISSION**

**3.1.3 Drive Axle**



**FIGURE 4: DATA PLATE LOCATION** 00007

**3.1.4 Front Axles**



**FIGURE 5: IFS TYPICAL DATA PLATE LOCATION** 16136

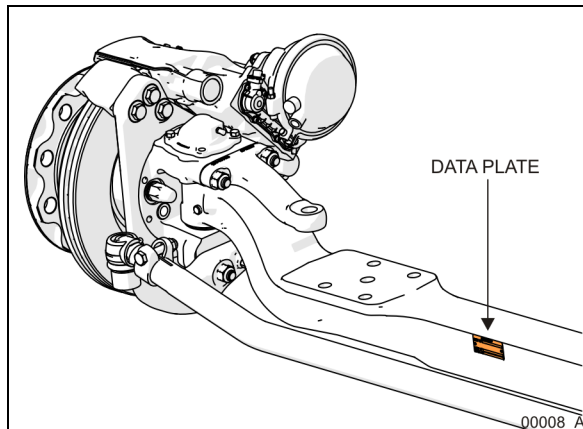


FIGURE 6: I-BEAM AXLE DATA PLATE

### 3.1.5 Coach Final Record

The Coach Final Record is a record of all data pertaining to the assembly of the vehicle. This record is given to the new customer on the vehicle delivery. Retain this record in the company records office for reference and safe-keeping.

### 3.1.6 Safety Certification

Vehicle components meet specifications and standards as follows:

- Material and parts conform to ASTM and/or SAE standards in effect at the time of manufacture.
- All factory-installed interior materials meet FMVSS 302 for fire resistance.
- Certified according to Provincial, State and Federal Safety standards (Canadian and US) BMCSS, FMVSS, and CMVSS.

Other applicable certification labels are affixed to the component.

### 3.1.7 DOT Certification Label

This certifies that vehicles manufactured by PrevoSt Car Inc., comply with all Federal Motor Vehicle Safety Standards at the time of manufacture. Information such as date of manufacture, model year, gross vehicle weight rating, tire types and inflation pressure is also etched on this plate. The DOT Certification plate is affixed behind the driver's seat.

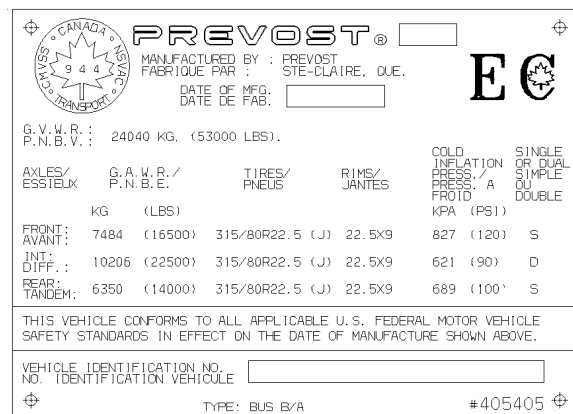


FIGURE 7: DOT CERTIFICATION PLATE

00016

### 3.1.8 Fuel Tank Label

The fuel tank label is molded on the side of the fuel tank. To read this label, unscrew the fuel tank access panel nuts located at the left in the condenser compartment.

### 3.1.9 EPA Engine Label

The exhaust emission certification label affixed in the engine compartment certifies that the engine conforms to federal and any state exhaust emission regulations (Figure 8). It gives the operating conditions under which certification was made.

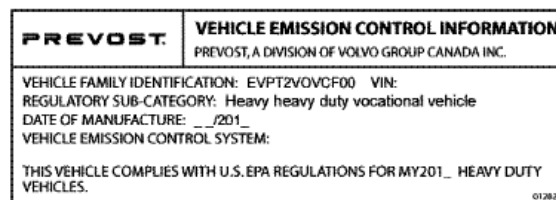


FIGURE 8: EMISSION CONTROL LABEL

23229

### 3.1.10 Vehicle Identification Number (VIN)

The seventeen digit vehicle identification number (VIN) is located on a plate (Figure 9) located on the windshield frame pillar (driver's side). The VIN is visible from the outside of the vehicle. Make sure the correct vehicle identification number is given when ordering replacement parts. Using the VIN when ordering parts will facilitate processing.

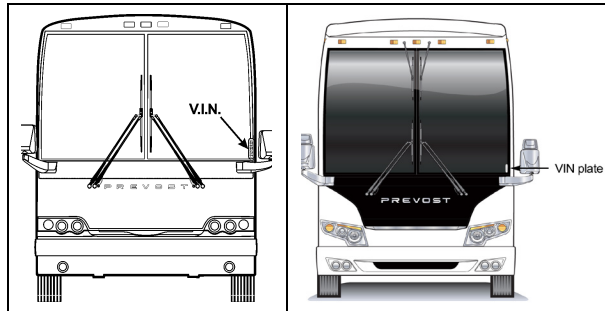


FIGURE 9: VEHICLE I.D.

00048

***NOTE***

*Record the VIN in the vehicle documentation and keep with company records. The VIN will normally be used for vehicle registration and for obtaining vehicle insurance coverage.*

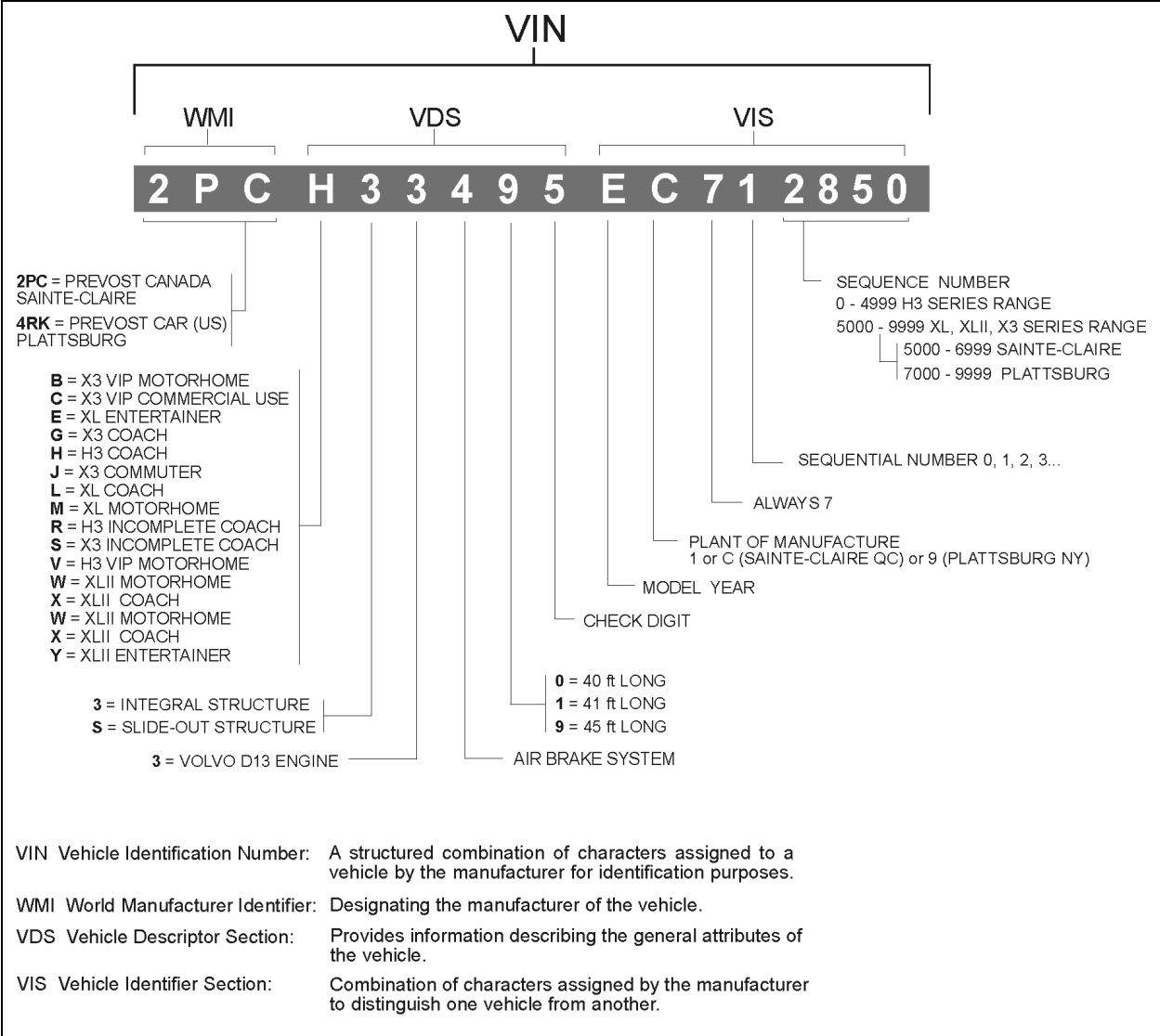


FIGURE 10: VEHICLE IDENTIFICATION NUMBER

00057\_5

YEAR	CODE	YEAR	CODE	YEAR	CODE
1997	V	2005	5	2013	D
1998	W	2006	6	2014	E
1999	X	2007	7	2015	F
2000	Y	2008	8	2016	G
2001	1	2009	9	2017	H
2002	2	2010	A	2018	J
2003	3	2011	B	2019	K
2004	4	2012	C	2020	L

4. FASTENER

4.1 FASTENER STRENGTH IDENTIFICATION

Most commonly used metric fastener strength property classes are 9.8 and 10.9 with the class identification embossed on the head of each bolt. Customary (inch) strength classes range from grade 2 to 8 with radial line identification embossed on each bolt head actual grade (i.e., a grade 7 bolt will have 5 embossed radial lines on the bolt head). Some metric nuts will be marked with single digit strength identification numbers on the nut face. Figure 12 shows the different strength markings.

When replacing metric fasteners, be careful to use fasteners of the same or greater strength than the original fasteners (the same number marking or higher). It is also important to select replacement fasteners of the correct size. Correct replacement fasteners are available through the parts division. Some metric fasteners available in after-market parts sources were designed to metric standards of countries other than the United States and may be of a lower strength, may not have the numbered head marking system, and may be of a different thread pitch.

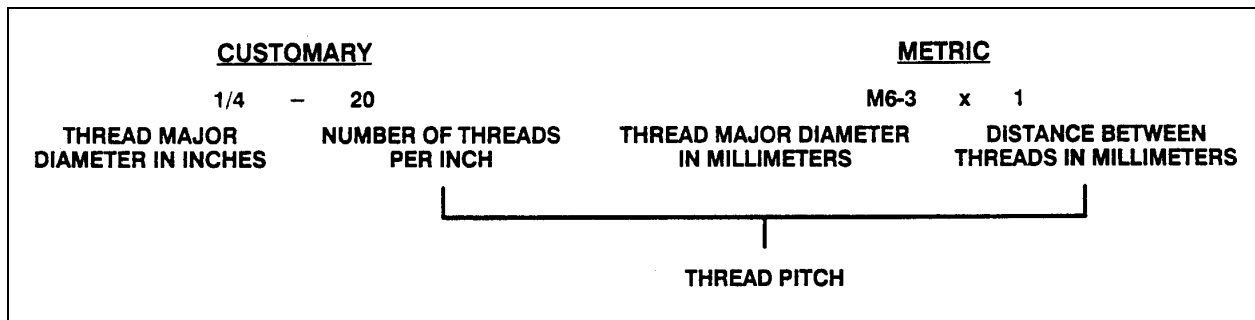


FIGURE 11: THREAD NOTATION

00002

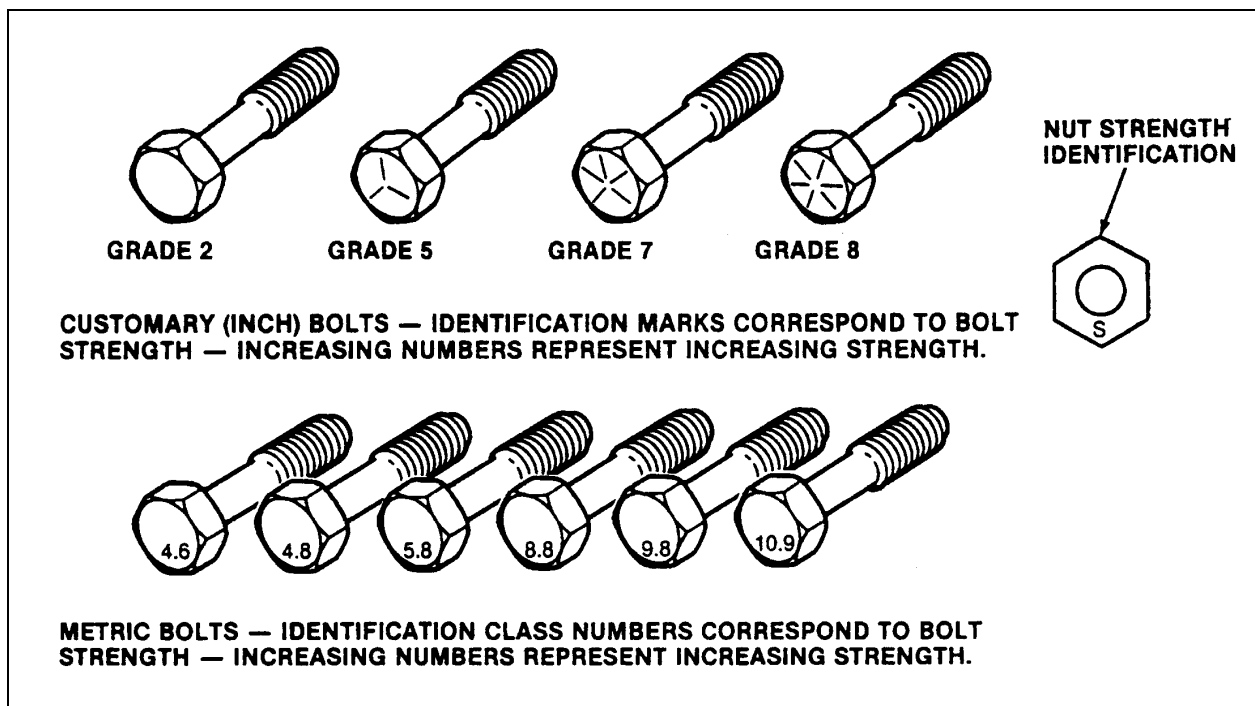


FIGURE 12: BOLT STRENGTH MARKINGS

00003

The metric fasteners used on the coach are designed to new standards and may not yet be manufactured by some non-domestic fastener suppliers. In general, except for special applications, the common sizes and pitches are:

M 8 X 1.25;  
M 10 X 1.5;  
M 12 X 1.75;  
M 14 X 2;

## 4.2 STANDARD TORQUE SPECIFICATIONS

The following table lists the standard tightening torques for bolts and nuts, relating tightening torque to thread diameter. Use the following table as a general guide for tightening torques. Use this table only for the bolts and nuts which do not require a specific torque value. All of the values are for use with dry solvent-cleaned threads.

### 4.2.1 SAE

TYPE	DESCRIPTION	THREAD	GRADE	RECOMMENDED TORQUE
				Tolerance: ±10%
SAE	1/4-20	unc	5	96 lb-in (11 Nm)
SAE	1/4-20	unc	8	135 lb-in (15 Nm)
SAE	1/4-28	unf	5	106 lb-in (12 Nm)
SAE	1/4-28	unf	8	149 lb-in (17 Nm)
SAE	5/16-18	unc	5	188 lb-in (21 Nm)
SAE	5/16-18	unc	8	266 lb-in (30 Nm)
SAE	5/16-24	unf	2	131 lb-in (15 Nm)
SAE	5/16-24	unf	5	202 lb-in (23 Nm)
SAE	5/16-24	unf	8	286 lb-in (32 Nm)
SAE	3/8-16	unc	5	27 lb-ft (37 Nm)
SAE	3/8-16	unc	8	38 lb-ft (52 Nm)
SAE	3/8-24	unf	5	30 lb-ft (41 Nm)
SAE	3/8-24	unf	8	42 lb-ft (57 Nm)
SAE	7/16-14	unc	5	43 lb-ft (58 Nm)
SAE	7/16-14	unc	8	60 lb-ft (81 Nm)
SAE	7/16-20	unf	5	46 lb-ft (62 Nm)
SAE	7/16-20	unf	8	65 lb-ft (88 Nm)
SAE	1/2-13	unc	5	65 lb-ft (88 Nm)
SAE	1/2-13	unc	8	92 lb-ft (125 Nm)
SAE	1/2-20	unf	5	71 lb-ft (96 Nm)
SAE	1/2-20	unf	8	100 lb-ft (136 Nm)

**SECTION 00 : GENERAL INFORMATION**

TYPE	DESCRIPTION	THREAD	GRADE	RECOMMENDED TORQUE
				Tolerance: $\pm 10\%$
SAE	9/16-12	unc	5	94 lb-ft (127 Nm)
SAE	9/16-12	unc	8	132 lb-ft (179 Nm)
SAE	9/16-18	unf	5	101 lb-ft (137 Nm)
SAE	9/16-18	unf	8	143 lb-ft (194 Nm)
SAE	5/8-11	unc	5	130 lb-ft (176 Nm)
SAE	5/8-11	unc	8	184 lb-ft (249 Nm)
SAE	5/8-18	unf	5	142 lb-ft (193 Nm)
SAE	5/8-18	unf	8	200 lb-ft (271 Nm)
SAE	3/4-10	unc	5	228 lb-ft (309 Nm)
SAE	3/4-10	unc	8	321 lb-ft (435 Nm)
SAE	3/4-16	unf	5	245 lb-ft (332 Nm)
SAE	3/4-16	unf	8	346 lb-ft (469 Nm)
SAE	7/8-9	unc	5	368 lb-ft (499 Nm)
SAE	7/8-9	unc	8	519 lb-ft (704 Nm)
SAE	7/8-14	unf	5	392 lb-ft (531 Nm)
SAE	7/8-14	unf	8	554 lb-ft (751 Nm)

SAE	A2-70 (NSS-SS)
DESCRIPTION COARSE THREAD	RECOMMENDED TIGHTENING (LB-FT) Tolerance: $\pm 10\%$
	DRY
8-32	21
10-32	34
1/4-20	77
5/16-18	152
DESCRIPTION COARSE THREAD	RECOMMENDED TIGHTENING (LB-FT) Tolerance: $\pm 10\%$
	DRY
3/8-16	22
7/16-14	34
1/2-13	53



## 4.2.2 Metric

TYPE	DESCRIPTION	THREAD	GRADE	RECOMMENDED TORQUE, ±10% lb-ft (dry) otherwise specified Tolerance: ±10%
METRIC	M6 X 1		nut 8 / screw 8.8	7 lb-ft (10 Nm)
METRIC	M6 X 1		nut 10 / screw 10.9	10 lb-ft (13 Nm)
METRIC	M6 X 1		nut 12 / screw 12.9	12 lb-ft (16 Nm)
METRIC	M8 X 1.25		nut 8 / screw 8.8	17 lb-ft (23 Nm)
METRIC	M8 X 1.25		nut 10 / screw 10.9	24 lb-ft (32 Nm)
METRIC	M8 X 1.25		nut 12 / screw 12.9	28 lb-ft (38 Nm)
METRIC	M10 X 1.5		nut 8 / screw 8.8	35 lb-ft (47 Nm)
METRIC	M10 X 1.5		nut 10 / screw 10.9	48 lb-ft (65 Nm)
METRIC	M10 X 1.5		nut 12 / screw 12.9	56 lb-ft (76 Nm)
METRIC	M12 X 1.75		nut 8 / screw 8.8	59 lb-ft (80 Nm)
METRIC	M12 X 1.75		nut 10 / screw 10.9	82 lb-ft (111 Nm)
METRIC	M12 X 1.75		nut 12 / screw 12.9	96 lb-ft (130 Nm)
METRIC	M14 X 2		nut 8 / screw 8.8	94 lb-ft (128 Nm)
METRIC	M14 X 2		nut 10 / screw 10.9	130 lb-ft (176 Nm)
METRIC	M14 X 2		nut 12 / screw 12.9	152 lb-ft (206 Nm)
METRIC	M16 X 2		nut 8 / screw 8.8	143 lb-ft (194 Nm)
METRIC	M16 X 2		nut 10 / screw 10.9	198 lb-ft (268 Nm)
METRIC	M16 X 2		nut 12 / screw 12.9	231 lb-ft (314 Nm)
METRIC	M16 X 1.5		nut 10 / screw 10.9	206 lb-ft (279 Nm)
METRIC	M16 X 1.5		nut 12 / screw 12.9	241 lb-ft (326 Nm)
METRIC	M20 X 2.5		nut 8 / screw 8.8	280 lb-ft (379 Nm)
METRIC	M20 X 2.5		nut 10 / screw 10.9	387 lb-ft (524 Nm)
METRIC	M20 X 2.5		nut 12 / screw 12.9	452 lb-ft (613 Nm)
METRIC	M20 X 1.5		nut 10 / screw 10.9	415 lb-ft (563 Nm)
METRIC	M20 X 1.5		nut 12 / screw 12.9	485 lb-ft (658 Nm)
METRIC	M22 X 2.5		nut 8 / screw 8.8	373 lb-ft (506 Nm)
METRIC	M22 X 2.5		nut 10 / screw 10.9	516 lb-ft (700 Nm)
METRIC	M22 X 2.5		nut 12 / screw 12.9	604 lb-ft (818 Nm)
METRIC	M24 X 3		nut 8 / screw 8.8	481 lb-ft (652 Nm)
METRIC	M24 X 3		nut 10 / screw 10.9	665 lb-ft (902 Nm)

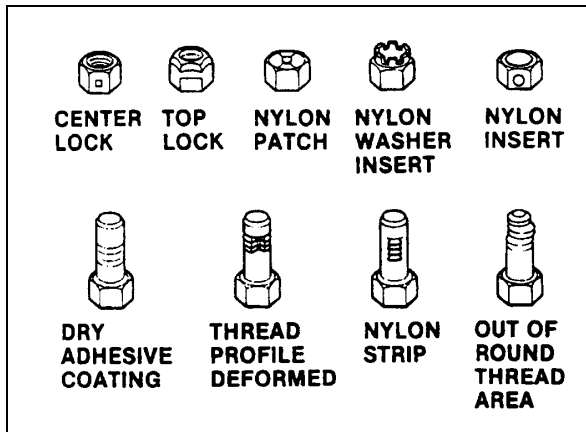
**SECTION 00 : GENERAL INFORMATION**

TYPE	DESCRIPTION	THREAD	GRADE	RECOMMENDED TORQUE, ±10% lb-ft (dry) otherwise specified Tolerance: ±10%
METRIC	M24 X 3		nut 12 / screw 12.9	777 lb-ft (1054 Nm)

METRIC: STAINLESS NUT A2-70 AND STAINLESS SCREW A2-70 (NSS-SS)		
DESCRIPTION	RECOMMENDED TIGHTENING Tolerance: ±10% (N-M) DRY	RECOMMENDED TIGHTENING Tolerance: ±10% (LB-IN) DRY
M4 X 0.7	2.3	20
M5 X 0.8	4.4	39
M6 X 1	7.7	68
DESCRIPTION	RECOMMENDED TIGHTENING Tolerance: ±10% (N-M) DRY	RECOMMENDED TIGHTENING Tolerance: ±10% (LB-FT) DRY
M8 X 1.25	18.6	13.7
M10 X 1.5	37.3	27.5
M12 X 1.75	63.8	47.0

**4.3 SELF-LOCKING FASTENERS**

A self-locking fastener is designed with an interference fit between the nut and bolt threads. This is most often accomplished by distortion of the top thread of an all-metal nut or bolt or by using a nylon patch on the threads. A nylon insert or the use of adhesives may also be used as a method of interference between nut and bolt threads (Figure 13).



**FIGURE 13: SELF-LOCKING FASTENERS** 00004

- a) Clean dirt and other foreign matter from the fastener;
- b) Inspect the fastener to ensure there is no crack, elongation, or other sign of fatigue or over tightening. If there is any doubt, replace with a new self-locking fastener of equal or greater strength;
- c) Assemble parts and hand start fastener;
- d) Observe that, before the fastener seats, it develops torque per the chart in the following table. If there is any doubt, replace with a new self-locking fastener of equal or greater strength;
- e) Tighten the fastener to the torque specified in the applicable section of this manual;

Fasteners which are rusty or damaged should be replaced with new ones of equal or greater strength

**4.4 RECOMMENDATIONS FOR REUSE**

Clean, rust-free self-locking fasteners may be reused as follows:

<b>SELF-LOCKING TORQUE CHART BEFORE FASTENER SEATS</b>									
<b>METRIC</b>		6 & 6.3	8	10	12	14	16	20	
NUTS AND ALL-METAL BOLTS	Nm	0.4	0.8	1.4	2.2	3.0	4.2	7.0	
	lb-in	4.0	7.0	12	18	25	35	57	
ADHESIVE OR NYLON COATED BOLTS	Nm	0.4	0.6	1.2	1.6	2.4	3.4	5.6	
	lb-in	4.0	5.0	10	14	20	28	46	
<b>US STANDARD</b>		¼	5/16	3/8	7/16	½	9/16	5/8	¾
NUTS AND ALL-METAL BOLTS	Nm	0.4	0.6	1.4	1.8	2.4	3.2	4.2	6.2
	lb-in	4.0	5.0	12	15	20	27	35	51
ADHESIVE OR NYLON COATED BOLTS	Nm	0.4	0.6	1.0	1.4	1.8	2.6	3.4	5.2
	lb-in	4.0	5.0	9.0	12	15	22	28	43

#### 4.5 SIX LOBED SOCKET HEAD

Six lobed socket head (Torx) fasteners are used in some applications on vehicles covered in this manual. The tools designed for these fasteners are available commercially. However, in some cases, if the correct tool is not available, a hex socket head wrench may be used.

Multiply	by	to get equivalent number of:	Multiply	by	to get equivalent number of:
<b>LENGTH</b>					
Inch	25.4	millimeters (mm)	Foot/sec <sup>2</sup>	0.305	meter/sec <sup>2</sup> (m/s <sup>2</sup> )
Foot	0.305	meters (m)	Inch/sec <sup>2</sup>	0.026	meter/sec <sup>2</sup>
Yard	0.914	meters	<b>TORQUE</b>		
Mile	1.609	kilometers (km)	Pound-inch	0.113	newton-meters (N·m)
Inch <sup>2</sup>	<b>AREA</b>		Pound-foot	1.35	newton-meters
Foot <sup>2</sup>	645.2	millimeters <sup>2</sup> (mm <sup>2</sup> )	<b>POWER</b>		
Yard <sup>2</sup>	6.45	centimeters <sup>2</sup> (cm <sup>2</sup> )	Horsepower	0.746	kilowatts (kW)
	0.093	meters <sup>2</sup> (m <sup>2</sup> )	<b>PRESSURE OR STRESS</b>		
	0.836	meters <sup>2</sup>	Inches of water	0.249	kilopascals (kPa)
			Pounds/sq. in.	6.895	kilopascals
<b>VOLUME</b>					
Inch <sup>3</sup>	16	mm <sup>3</sup>	<b>ENERGY OR WORK</b>		
Quart	387.0	cm <sup>3</sup>	BTU	1	055.0 joules (J)
Gallon	16.387	liters (l)	Foot-pound	1.356	joules
Yard <sup>3</sup>	0.016	liters	kilowatt-hour	3	600 000.0 joules (J = one W's)
	0.946	liters	or 3.6 x 10 <sup>6</sup>		
	3.785	meters <sup>3</sup> (m <sup>3</sup> )	<b>LIGHT</b>		
	0.765		Foot candle	1.076	lumens/meter <sup>2</sup> (lm/m <sup>2</sup> )
<b>MASS</b>					
Pound	0.453	kilograms (kg)	<b>VELOCITY</b>		
Ton	907.18	kilograms (kg)	Miles/hour	1.609	kilometers/hr (km/h)
Ton	0.907	ton (t)	<b>TEMPERATURE</b>		
<b>FORCE</b>					
Kilogram	9.807	newtons (N)	$(^{\circ}\text{F} - 32) \div 1.8$		
Ounce	0.278	newtons			
Pound	4.448	newtons			

FIGURE 14: METRIC - US STANDARD CONVERSION TABLE

00005

## DECIMAL AND METRIC EQUIVALENTS

FRACTIONS	DECIMAL IN.	METRIC MM	FRACTIONS	DECIMAL IN.	METRIC MM
1/64	.015625	.39688	33/64	.515625	13.09687
1/32	.03125	.79375	17/32	.53125	13.49375
3/64	.046875	1.19062	35/64	.546875	13.89062
1/16	.0625	1.58750	9/16	.5625	14.28750
5/64	.078125	1.98437	37/64	.578125	14.68437
3/32	.09375	2.38125	19/32	.59375	15.08125
7/64	.109375	2.77812	39/64	.609375	15.47812
1/8	.125	3.1750	5/8	.625	15.87500
9/64	.140625	3.57187	41/64	.640625	16.27187
5/32	.15625	3.96875	21/32	.65625	16.66875
11/64	.171875	4.36562	43/64	.671875	17.06562
3/16	.1875	4.76250	11/16	.6875	17.46250
13/64	.203125	5.15937	45/64	.703125	17.85937
7/32	.21875	5.55625	23/32	.71875	18.25625
15/64	.234375	5.95312	47/64	.734375	18.65312
1/4	.250	6.35000	3/4	.750	19.05000
17/64	.265625	6.74687	49/64	.765625	19.44687
9/32	.28125	7.14375	25/32	.78125	19.84375
19/64	.296875	7.54062	51/64	.796875	20.24062
5/16	.3125	7.93750	13/16	.8125	20.63750
21/64	.328125	8.33437	53/64	.828125	21.03437
11/32	.34375	8.73125	27/32	.84375	21.43125
23/64	.359375	9.12812	55/64	.859375	21.82812
3/8	.375	9.52500	7/8	.875	22.22500
25/64	.390625	9.92187	57/64	.890625	22.62187
13/32	.40625	10.31875	29/32	.90625	23.01875
27/64	.421875	10.71562	59/64	.921875	23.41562
7/16	.4375	11.11250	15/16	.9375	23.81250
29/64	.453125	11.50937	61/64	.953125	24.20937
15/32	.46875	11.90625	31/32	.96875	24.60625
31/64	.484375	12.30312	63/64	.984375	25.00312
1/2	.500	12.70000	1	1.00	25.40000

FIGURE 15: CONVERSION CHART

00006

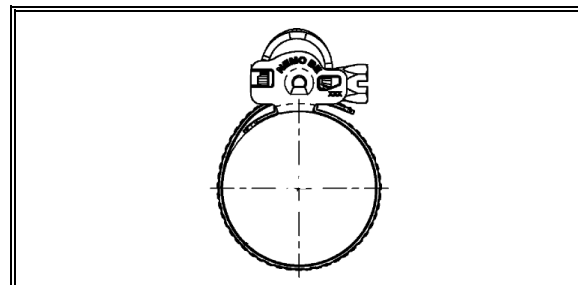
## 4.6 HOSE CLAMP TORQUE

<b>ENGLISH:</b>		<b>HOSE CLAMP</b>
<b>DESCRIPTION CONSTANT TORQUE</b>	<b>RECOMMENDED TIGHTENING (LB-IN)</b>	
		<b>DRY</b>
3/8 Hex		90-110

<b>ENGLISH:</b>		<b>HOSE CLAMP (WAVE SEAL AND BREEZE)</b>
<b>DESCRIPTION CONSTANT TORQUE</b>	<b>RECOMMENDED TIGHTENING (LB-IN)</b>	
		<b>DRY</b>
5/16 Hex		55-65



<b>METRIC:</b>		<b>HOSE CLAMP (CAILLAU)</b>
	<b>RECOMMENDED TIGHTENING (LB-IN)</b>	
		<b>DRY</b>
7 mm Hex		30±2.2

**CAUTION**

Cover electronic control components and wiring to protect from hot sparks, etc.

**CAUTION**

Position welding machine ground clamp as close as possible to the work. Ensure that the welding machine ground return clamp is well secured and makes a good electrical contact with a large metallic area of the chassis located as close as possible to the welding point.

**CAUTION**

Do not use TIG welding process on the vehicle. This high frequency current process can seriously damage the electronic components.

Refer to *Multiplex Modules Disconnection Procedure Prior to Welding* annexed at the end of this section.

## 5. WELDING PROCESS

### 5.1 STEEL – STEEL WELDING



#### CAUTION

Before welding, perform multiplex modules disconnection procedure.

#### NOTE

*Welding surfaces must be free of scale, slag, rust, paint, grease, humidity or other foreign material that would render welding impossible.*



#### DANGER

Only a qualified and experienced person must do welding.

- FCAW (Flux Cored Arc Welding) process ;
- Electrode wire conforms to A5.20 AWS (American Welding Society) specifications ;
- E4801T-9-CH, type electrode wire with 0,045" diameter (1,14 mm) ;

Material Thickness	Voltage	Current	Wire Feed Rate	Shielding Gas
1/8" to 1/2"	26 ± 2 volts	260 Amps	450 ipm approx.	75% argon – 25% CO2 or 100% CO2

If necessary and with great care to prevent perforating the material, it is possible to use a conventional electric arc welding machine according to the following specifications:

- SMAW (Shielded Metal-Arc Welding) process ;
- Welding rod conforms to A5.1 of AWS (American Welding Society) specifications; E 7018 type welding rod with 1/8" diameter (3,2 mm).
- Current: 100 amperes to 150 amperes; optimum at 120 amps.

It is important to grind weld bead starts and stops and also to grind arc strikes from surfaces.

### 5.2 STEEL WITH STAINLESS STEEL OR STAINLESS STEEL WITH STAINLESS STEEL WELDING



#### CAUTION

Before welding, perform multiplex modules disconnection procedure.

#### NOTE

*Welding surfaces must be free of scale, slag, rust, paint, grease, humidity or other foreign material that would render welding impossible.*



#### DANGER

Only a qualified and experienced person must do welding.

- GMAW (Gas Metal-Arc Welding) process;
- Welding wire conforms to AWS (American Welding Standards) A5.9 specifications;
- 308LSi type welding wire with 0.035" diameter (0,9 mm);



## 5.3 STEEL - STAINLESS STEEL WELDING

Steel Thickness	SS Thickness	Voltage	Current	Wire Feed Rate	Shielding Gas
Less than 1/8"	Any type	20±1.5 volts	130±15 Amps	290 ipm approx.	90% He, 7.5% Ar, 2.5% CO2
1/8" and more	Any type	22±1.5 volts	160±15 Amps	330 ipm approx.	90% He, 7.5% Ar, 2.5% CO2

**STAINLESS STEEL - STAINLESS STEEL WELDING**

SS Thickness	Voltage	Current	Wire Feed Rate	Shielding Gas
Any type	20 ± 1.5 volts	130 ± 15 Amps	290 ipm approx.	90% He – 7.5% Ar, 2.5% CO2

If necessary and with great care to prevent perforating the material, it is possible to use a conventional electric arc welding machine according to the following specifications:

- SMAW (Shield Metal-Arc Welding) process;
- Welding rod conforms to AWS (American Welding Standards) A5.4 specifications; 308L-17 type welding rod with 3/32" diameter (2,4 mm);
- Current: - 50 amperes to 90 amperes, optimum at 60 amperes.

It is important to grind weld bead starts and stops and also to grind arc strikes from surfaces.



## MULTIPLEX MODULES DISCONNECTION PROCEDURE PRIOR TO WELDING

JANUARY 2018

### Table of contents

1. COMMUTERS .....	2
2. H3 SERIES - WITH NEW ELECTRICAL ARCHITECTURE .....	5
3. X3 SERIES - WITH NEW ELECTRICAL ARCHITECTURE .....	7

<b>Material:</b>	N/A
<b>Equipment(s):</b>	Phillips-head screwdriver Ratchet handle 3/8" socket Electric tape Long nose pliers
<b>Reference schematics:</b>	N/A
<b>Safety rules:</b>	- Wear safety goggles - Set the battery master switch to the OFF position first
<b>Recommendations:</b>	<b>This procedure should be performed by qualified personnel only.</b>

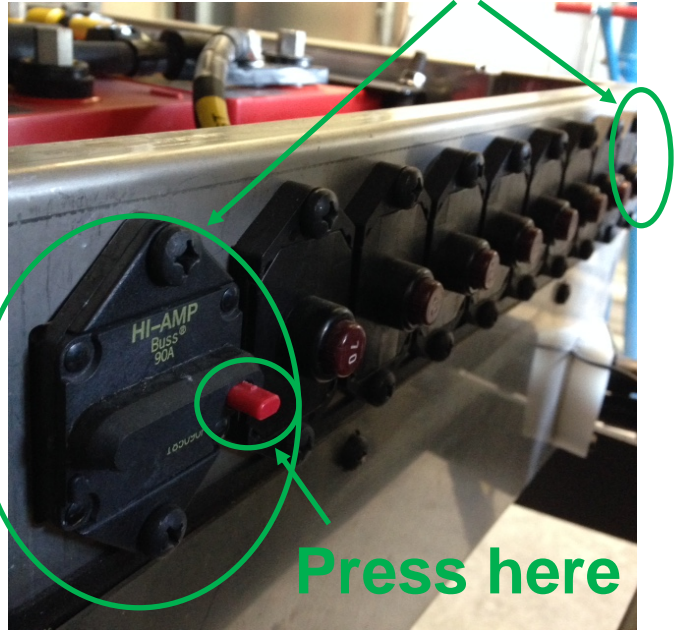
## 1. COMMUTERS

### Disconnection prior to welding

- 1 Switch ignition OFF  
Switch Master cut-out OFF



- 2 Open the 2 circuit breakers (each end)



- 3 Disconnect both electronic grounds  
Use insulating tape to make sure that cables don't touch each other or the vehicle body

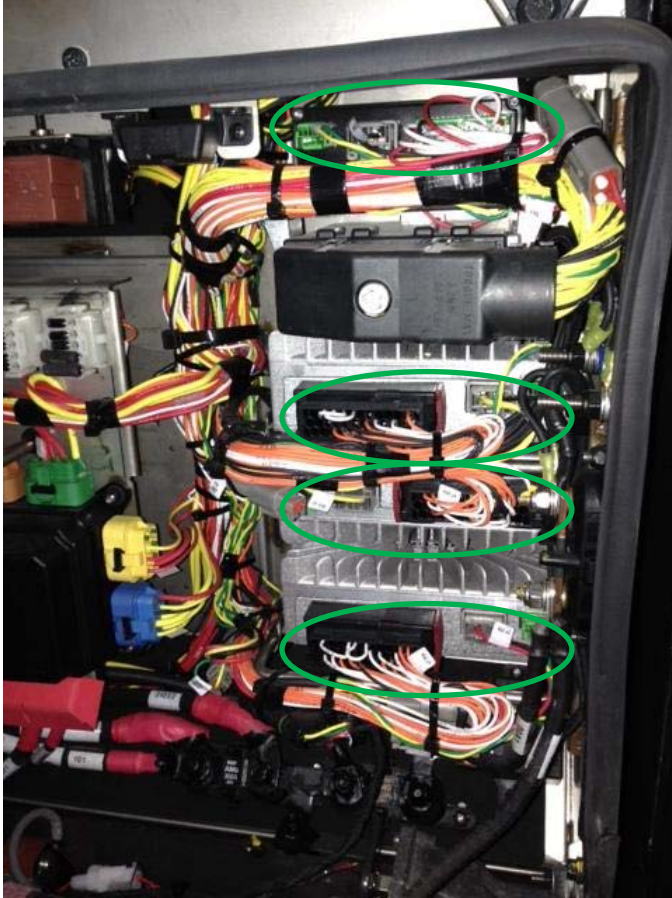


- 4 Disconnect C397 and C355

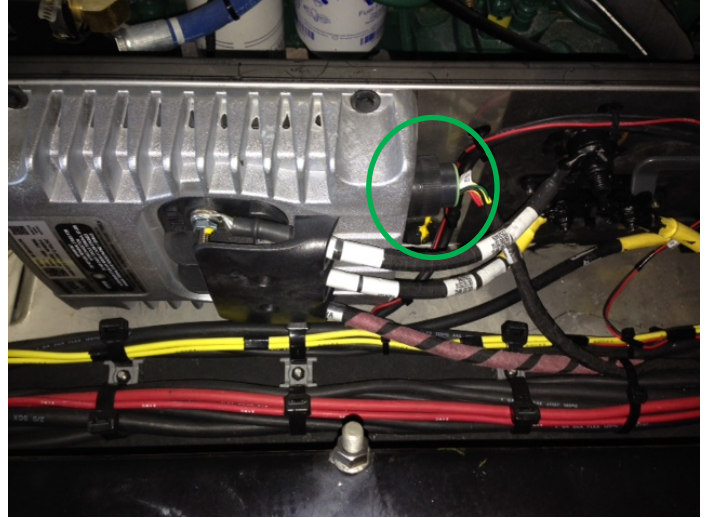


**Disconnection prior to welding**

5 Disconnect all the connectors from the I/O-A and I/O-B modules in rear junction box

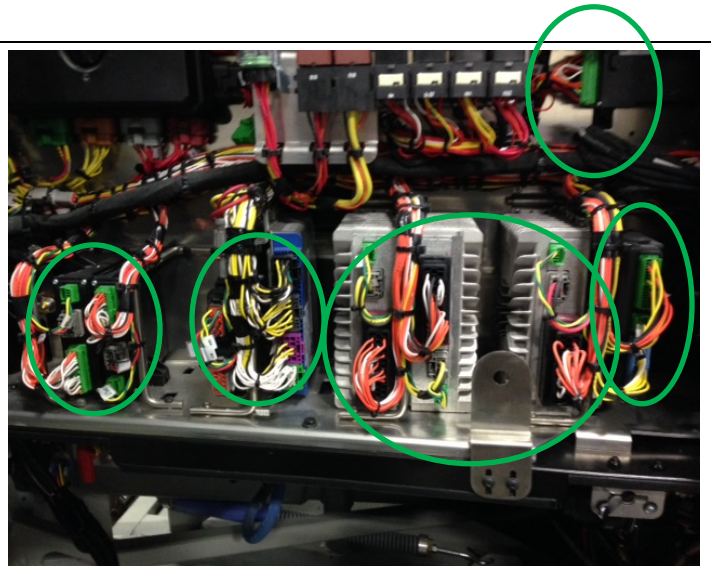


6 Disconnect the control connector from the battery equalizer



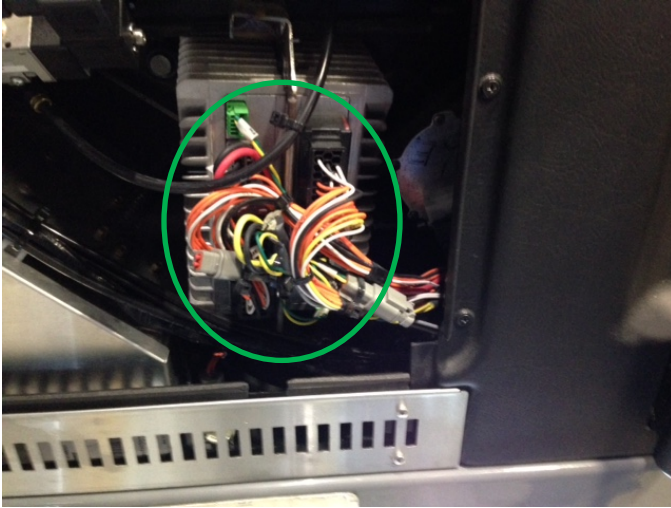
7 In the front junction box  
Disconnect all the connectors from :

- I/O-A modules
- I/O-B modules
- Vancso Gateway
- ABS module
- VECU
- MCM

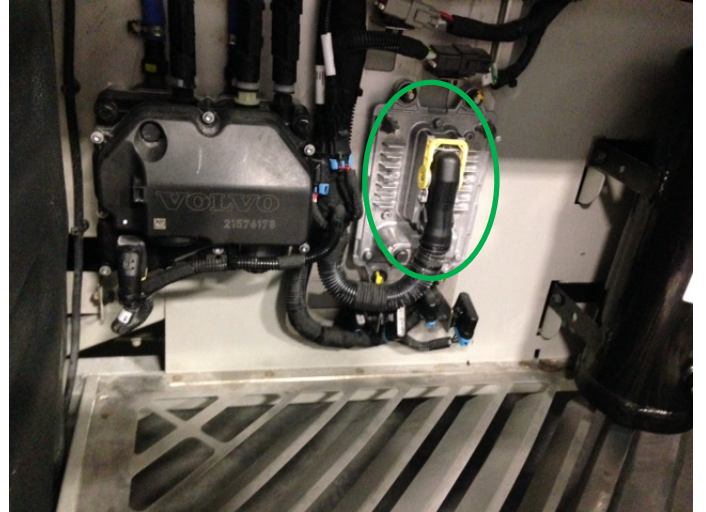


**Disconnection prior to welding**

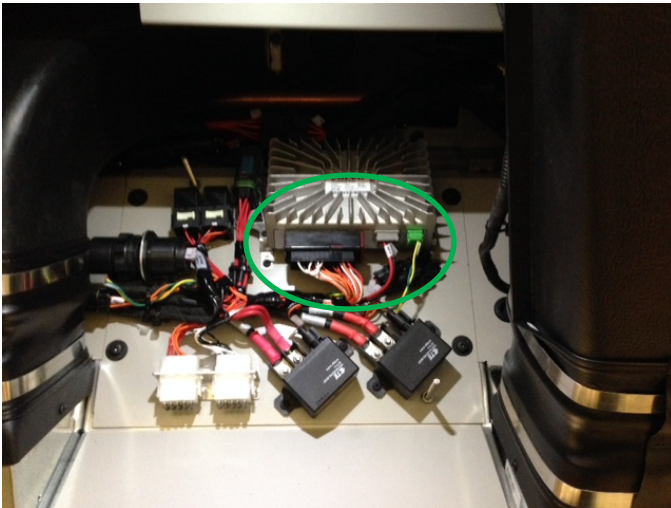
- 8 Behind the right console panel  
Disconnect all the connectors from the I/O-B modules



- 9 In the condensor compartment  
Disconnect the ACM connector (A137A)



- 10 In the evaporator compartment  
Disconnect all the connectors from I/O-B module



- 11 The vehicle is now ready for welding

Make sure that the welding ground is as close as possible of the welding point and the contact is perfect.

- 12 When the welding is done  
Reconnect all the modules

Make sure that all the connectors are perfectly connected with the locking tabs well engaged.

## 2. H3 SERIES - with New Electrical Architecture



### CAUTION

Cover electronic control components and wiring to protect from hot sparks, etc.



### CAUTION

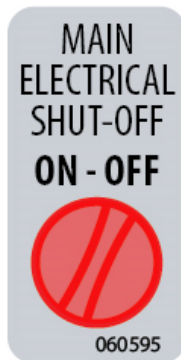
Do not use TIG welding process on the vehicle. This high frequency current process can seriously damage the electronic components.

## Disconnection prior to welding

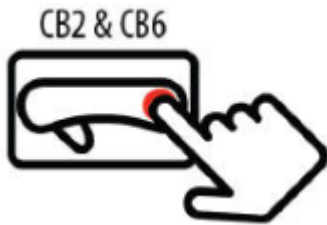
PRECAUTIONS TO BE OBSERVED BEFORE ARC WELDING TO MINIMIZE THE RISK OF MAJOR AND COSTLY DAMAGES CAUSED TO THE VEHICLE ELECTRONIC COMPONENTS



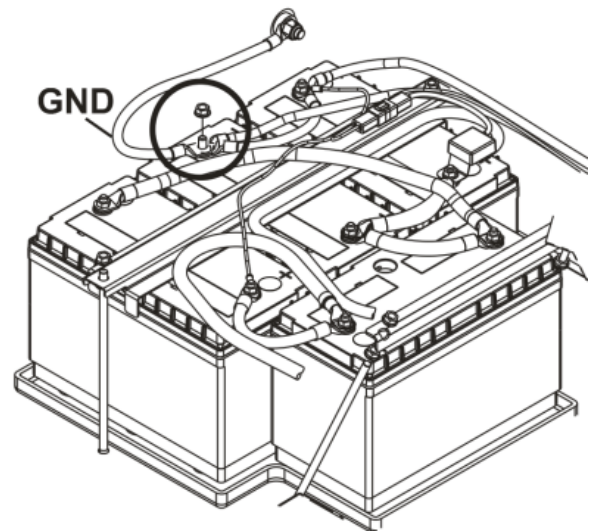
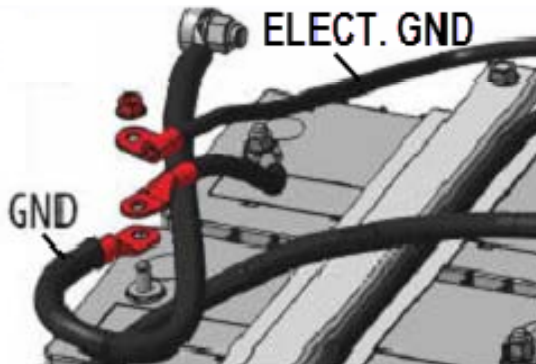
1. Turn the ignition switch to the OFF position.
2. Set the main electrical shut-off switch to the OFF position.



3. Trip circuit breakers CB2 & CB6.



4. Disconnect the chassis ground cable "00" (GND) from the appropriate battery post (figure on your right).



**CAUTION**

*Position welding machine ground clamp as close as possible to the work. Ensure that the welding machine ground return clamp is well secured and makes a good electrical contact with a large metallic area of the chassis located as close as possible to the welding point.*

5. Once the welding works completed, perform the previous steps in reverse order. Torque the ground cable nut according to specifications found in Section 06 Electrical.



### 3. X3 SERIES - with New Electrical Architecture



#### CAUTION

Cover electronic control components and wiring to protect from hot sparks, etc.



#### CAUTION

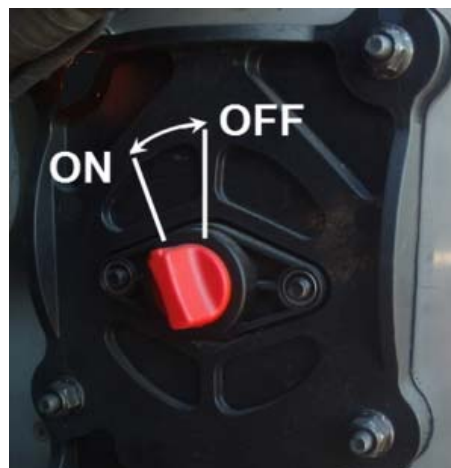
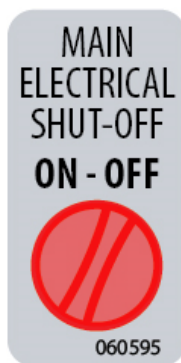
Do not use TIG welding process on the vehicle. This high frequency current process can seriously damage the electronic components.

## Disconnection prior to welding

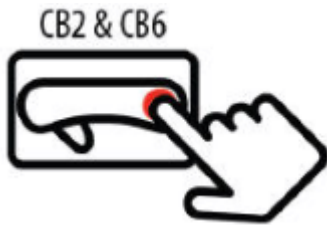
PRECAUTIONS TO BE OBSERVED BEFORE ARC WELDING TO MINIMIZE THE RISK OF MAJOR AND COSTLY DAMAGES CAUSED TO THE VEHICLE ELECTRONIC COMPONENTS



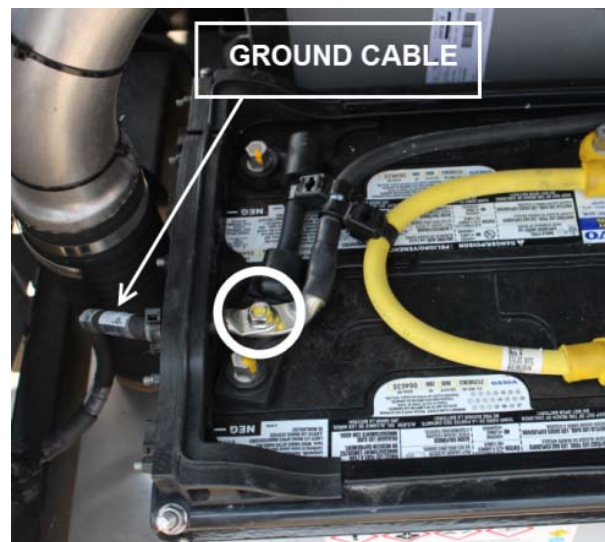
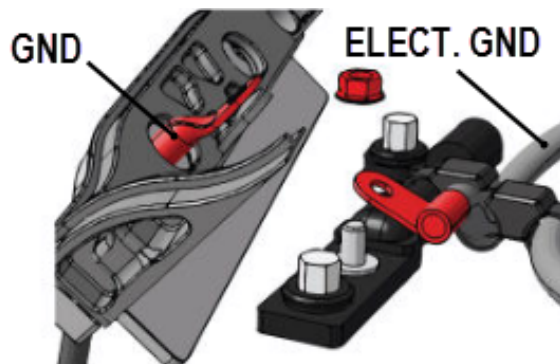
1. Turn the ignition switch to the OFF position.
2. Set the main electrical shut-off switch to the OFF position.



3. Trip circuit breakers CB2 & CB6.



4. Disconnect the chassis ground cable "00" (GND) from the appropriate battery post (figure on your right).



### CAUTION

*Position welding machine ground clamp as close as possible to the work. Ensure that the welding machine ground return clamp is well secured and makes a good electrical contact with a large metallic area of the chassis located as close as possible to the welding point.*

5. Once the welding works completed, perform the previous steps in reverse order. Torque the ground cable nut according to specifications found in Section 06 Electrical.