

SECTION 4

DRIVER'S AREA OVERVIEW	4
KEYS	5
EXTERIOR COMPARTMENT KEY	5
DRIVER'S PERSONAL COMPARTMENT KEY	5
UTILITY COMPARTMENT KEY	5
PAPER TOWEL DISPENSER KEY	5
AUDIO-VIDEO EQUIPMENT COMPARTMENT KEY	5
LAVATORY DOOR KEY	5
IGNITION SWITCH	5
ACCESSORIES	6
OFF	6
ON	6
START	6
FOOT-OPERATED CONTROLS	7
BRAKE PEDAL	7
ACCELERATOR PEDAL	7
STEERING WHEEL ADJUSTMENT UNLOCK AIR VALVE	7
STEERING COLUMN CONTROLS	8
MULTI-FUNCTION LEVER	8
STEERING WHEEL CONTROLS	9
HORNS	11
TRANSMISSION RETARDER	11
LATERAL CONTROL PANEL	12
TRANSMISSION CONTROL PAD	12
CONTROL SWITCHES	12
MIRROR CONTROLS	13
TAG AXLE CONTROL VALVE	14
PARKING BRAKE CONTROL VALVE	14
COOLANT HEATER TIMER (OPTION)	14
LOW-BUOY CONTROL VALVE (OPTION)	14
UTILITY COMPARTMENT & 12V POWER OUTLET	14
EMERGENCY/PARKING BRAKES OVERRULE CONTROL VALVE	15
DASHBOARD	16
CONTROL SWITCHES	17
L.H. DASHBOARD PANEL	17
R.H. DASHBOARD PANEL	20
HVAC CONTROL UNIT	22
AUDIO-VIDEO SELECTOR PANEL FOR THE PASSENGER'S AREA	24
OPERATION OF THE OPTIONAL AUDIO-VIDEO MODESTY PANEL	25

4-2 Controls and Instruments

DASHBOARD RADIO/MP3/IPOD/CD PLAYER	26
AIR REGISTERS	28
INSTRUMENT CLUSTER	29
DRIVER INFORMATION LEVELS	30
ANALOG INDICATORS	31
TELLTALE LIGHTS	35
STOP, CHECK AND INFORMATION TELLTALE LIGHTS	38
DRIVER INFORMATION DISPLAY	39
PICTOGRAMS DISPLAYED ON THE DRIVER INFORMATION DISPLAY (DID)	41
BACK-UP CAMERA AND MONITOR	50
SCENIC VIEWING SYSTEM CAMERA	50
ON BOARD DIAGNOSTIC TOOL RECEPTACLE	50
AUTOMATIC FIRE DETECTION AND SUPPRESSION SYSTEM (AFSS)	50
PROTECTION PANEL	50
CRUISE CONTROL	50
TURNING THE SYSTEM ON	51
SETTING A CRUISING SPEED	51
PREVOST AWARE ADAPTIVE CRUISE BRAKING	52
TURNING THE ACB SYSTEM ON	53
TURNING OFF THE ACB SYSTEM	53
MAINTAINING A SET FOLLOWING DISTANCE	53
DRIVER WARNINGS	54
DASHBOARD TELLTALE	54
SPEEDOMETER LED	54
FOLLOWING DISTANCE ALERT (FDA)	54
IMPACT ALERT	55
BRAKE OVERUSE WARNING	55
FOLLOWING DISTANCE ALERT	56
IMPACT ALERT	56
BRAKE OVERUSE WARNING	56
SELF-DIAGNOSTIC AT START-UP	57
SYSTEM MALFUNCTION	57
TIRE PRESSURE MONITORING SYSTEMS (TPMS)	57
SYSTEM MALFUNCTION	57
TPMS-LITE VERSION	57
ON-SCREEN TPMS VERSION	58
ALLISON TRANSMISSION	61
OPERATION	61
PUSHBUTTON SHIFT SELECTOR	61
PRIMARY AND SECONDARY SHIFT SCHEDULES	62
TRANSMISSION SERVICE INDICATOR	62

DESCRIPTION OF AVAILABLE RANGES	62
VOLVO I-SHIFT TRANSMISSION	64
PUSHBUTTON SHIFT SELECTOR	65
DISPLAY	65
ACCELERATOR PEDAL	65
ECONOMY AND PERFORMANCE MODE	65
ECO-ROLL MODE (FREEWHEEL FUNCTION)	65
LIMP HOME MODE	66
STARTING AND STOPPING	66
STARTING THE VEHICLE UPHILL AND DOWNHILL	66
DRIVING	67
TOWING RECOMMENDATIONS	69

4-4 Controls and Instruments

DRIVER'S AREA OVERVIEW

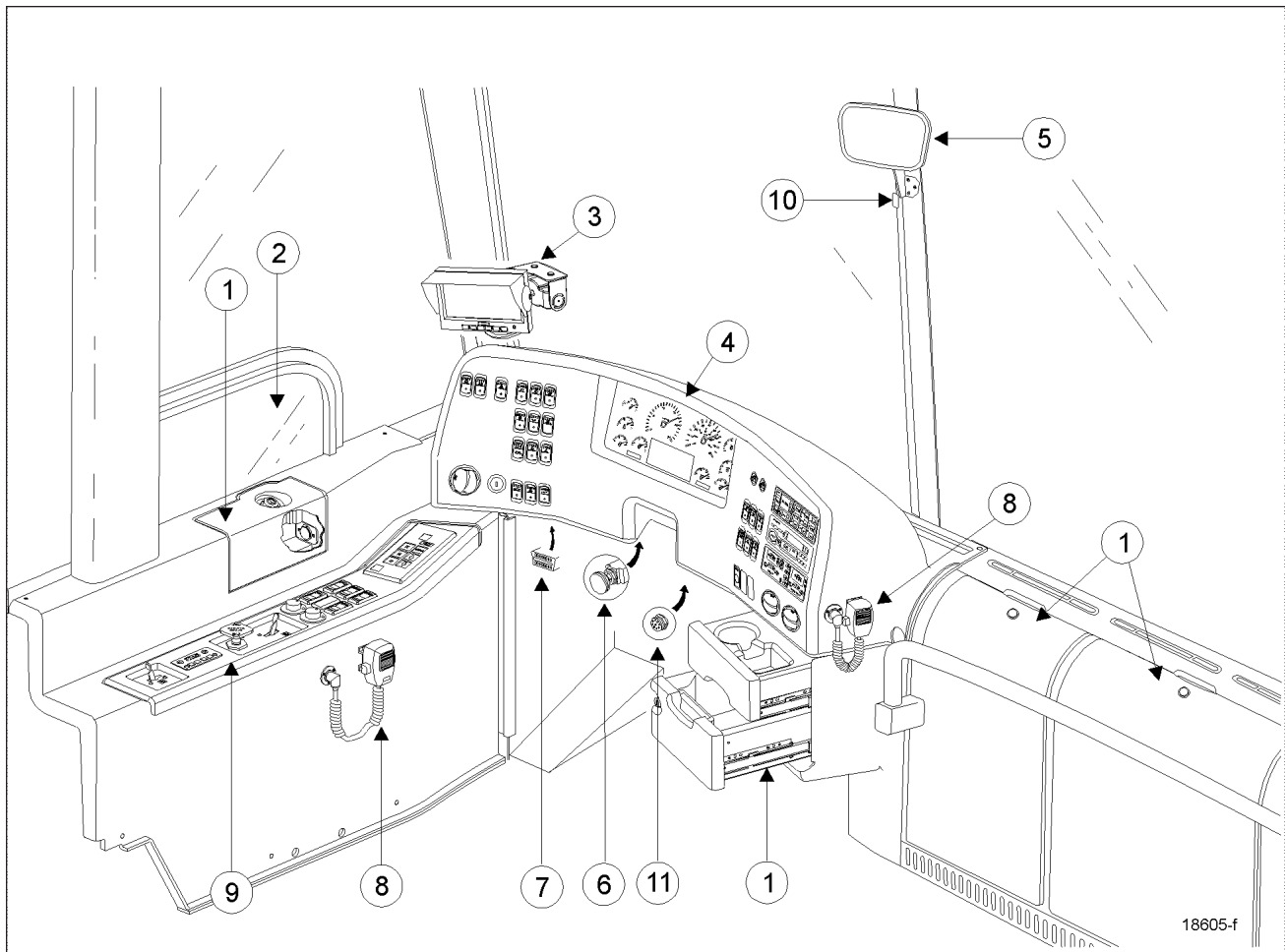

DRIVER'S AREA

1. Utility compartments
2. Driver's power window
3. Back-up camera monitor and panoramic view camera
4. Dashboard
5. Mirror
6. Foot-operated steering wheel adjustment knob
7. Diagnostic tool receptacle (OBD)
8. Microphone
9. Lateral control panel
10. DVD player remote control IR sensor
11. Electronic Logging Device Connection (ELD)

KEYS

Depending on options, up to nine different keys are provided with the coach.

EXTERIOR COMPARTMENT KEY

Use this key to lock or unlock the entrance door, the baggage compartments doors, the electrical and service compartment doors, the fuel filler access doors and the lavatory door.

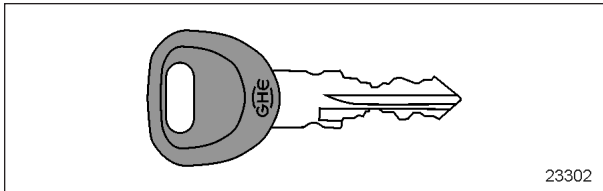

NOTE

It is also possible to lock/unlock the baggage compartment doors from the inside by means of the baggage compartment-locking system switch located on the lateral control panel.

DRIVER'S PERSONAL COMPARTMENT KEY

Use this key to lock or unlock the driver's personal compartment, accessible through the stairway wall.

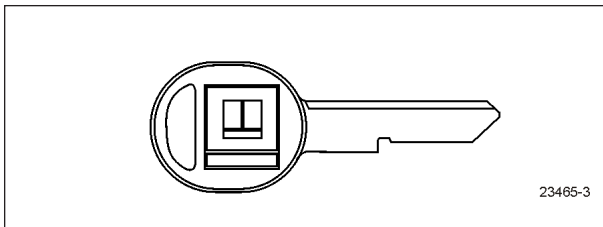

UTILITY COMPARTMENT KEY

This key locks or unlocks the utility compartments and the utility drawers on and around the dashboard.

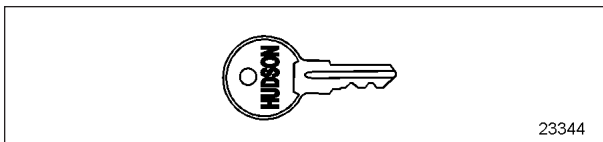

PAPER TOWEL DISPENSER KEY

This key opens the paper towel dispenser in the lavatory.

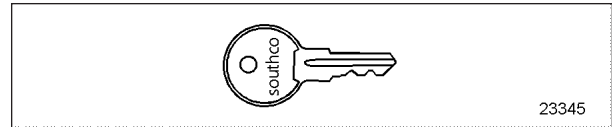

NOTE

The optional moist towel dispenser uses a different key.

AUDIO-VIDEO EQUIPMENT COMPARTMENT KEY

Use this key to lock or unlock the overhead compartment containing the audio-video equipment.

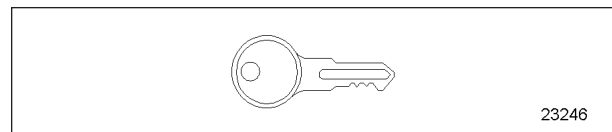

LAVATORY DOOR KEY

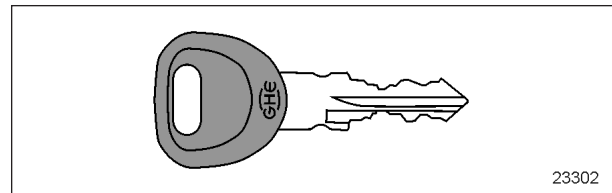

Use this key to lock or unlock the lavatory.

IGNITION SWITCH

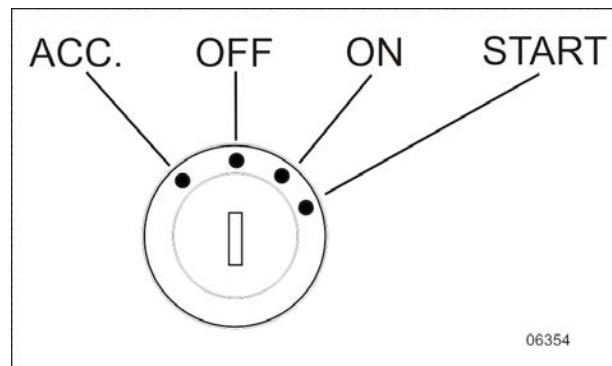

IGNITION SWITCH KEY POSITIONS

The ignition switch is located on the lower left side of the dashboard. With the battery master switch activated, turn the ignition key counterclockwise to the ACC position to activate the electrical circuits.

4-6 Controls and Instruments

To start the engine, turn the key clockwise to the START position, and then release it. The key will set to ON position.

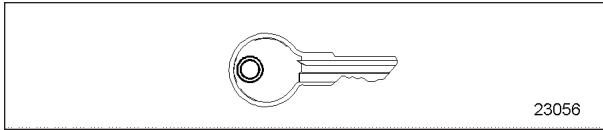

IGNITION KEY

Coaches may also be equipped with an ignition lever instead of an ignition key.

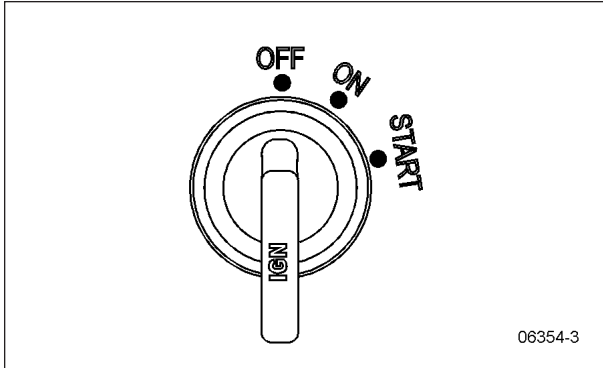

IGNITION SWITCH LEVER POSITIONS

CAUTION

When the vehicle is parked overnight or for an extended period of time, the battery master switch (ignition switch) should be set to the OFF position.

NOTE

When the battery master switch (ignition switch) is set to the OFF position, all electrical supply from the batteries is cut off, with the exception of battery equalizer check module, ECM ignition and power supply, Allison TCM or I-Shift transmission ECU, auxiliary coolant heater timer, coolant heater and water recirculating pump, power-verter, fire alarm and entrance door.

The ignition switch doubles as the battery master switch. Any position other than OFF activates the electrical circuits.

The ignition switch is located on the lower left side of the dashboard. It has four positions:

ACCESSORIES

To operate the accessories only, turn the ignition key counterclockwise to the ACC position.

The electrical circuits are activated when the switch is in this position. The features enabled when the switch is in the ACC position are all those linked directly to the battery such as the radio or entertainment system, exterior and interior lighting.

OFF

In the OFF position, ignition cannot take place. The key can be removed in this position.

The electrical circuits are not activated when the switch is in this position with the exception of the circuits of the accessories connected directly to the batteries and the "wake-up" systems which remains active for about 15 minutes after the ignition is set to the OFF position. Maintain the switch in this position when parked overnight or for an extended period.

ON

To place ignition switch to the ON position, turn the key clockwise to the first position.

The electrical circuits activated are the same than the ACC position, plus the transmission, engine and accessories, ABS system, wipers, level low system, dashboard cluster gauges and buzzers, air horn and air dryer heater are activated when the key is in this position. Do not leave the key in this position unless the engine is running.

START

Turn the key clockwise to the second position and release as soon as the engine starts. The key will return to the ON position. If the engine did not start, return the ignition key to the OFF position before trying to restart the engine.

The ignition switch is equipped with a starter protection which inhibits turning the key to the START position if the key has not previously been turned to the OFF position.

CAUTION

To avoid overheating the starter, do not engage the starter for more than 15 seconds at a time. Allow the starter to cool before trying to restart the engine.

⚠ DANGER

Do not use ether or other combustible starting aid fluid on any engine equipped with an intake air preheater. If the engine is equipped with a preheater, introduction of ether or similar starting aids could cause a fire or explosion resulting in severe property damage, serious personal injury or death.

FOOT-OPERATED CONTROLS

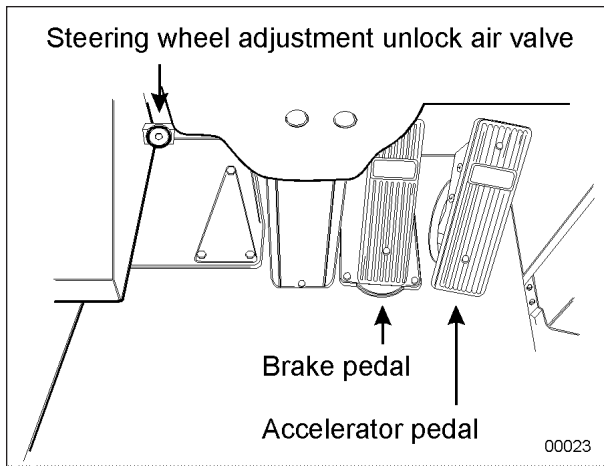

FOOT OPERATED CONTROLS

BRAKE PEDAL

The coach is equipped with a dual braking system. The front brakes operate from a different air source than the drive and tag axle brakes.

The dual braking system becomes a modulated emergency system if a pressure drop occurs in the primary brake system (rear brakes).

Service brakes are applied by depressing the brake pedal. Braking increases with the amount of pressure applied to the foot pedal. Refer to ["ANTILOCK BRAKING SYSTEM \(ABS\)" on page 27](#) in Section 5 Other Features . When the brake pedal is depressed, the brake lights turn on automatically.

For safe and effective braking, the air system pressure should reach at least 95 psi in both the primary and secondary circuits.

A warning light and an audible alert will sound when the air pressure in either the primary or secondary circuit drops below 85 psi. If this occurs, stop the coach; determine the cause of the pressure loss

before proceeding. The brake pedal can be used in conjunction with the transmission retarder. Refer to ["TRANSMISSION RETARDER" on page 11](#) in this section.

⚠ DANGER

Immediately report any brake system problem to your company or directly to the nearest Prevost or Prevost-approved service center.

Do not "fan" or "pump" the brake pedal. This practice does not increase brake system effectiveness but rather reduces system air pressure thereby causing reduced braking effectiveness.

⚠ CAUTION

"Riding" the brake by resting one's foot on the brake pedal when not braking can cause abnormally high brake temperature, can damage and cause premature wear of brake components and reduce brake effectiveness.

ACCELERATOR PEDAL

Controls engine RPM as needed.

⚠ CAUTION

Do not let the engine operate above 2,450 rpm.

STEERING WHEEL ADJUSTMENT UNLOCK AIR VALVE

Push on the valve button with the left foot to unlock the steering wheel for tilt and telescopic adjustment.

⚠ WARNING

Do not adjust the steering wheel while the vehicle is moving. Loss of control could result. Park the vehicle safely and apply parking brake before adjusting.

4-8 Controls and Instruments

STEERING COLUMN CONTROLS

Many of the most frequently used controls are conveniently placed on the steering column or the steering wheel, just like a passenger car. The multi-function lever is located on the left side of the steering wheel while the optional transmission retarder lever is located on the right side of the steering wheel. Switches for the electric horn and the air horn are located directly on the steering wheel.

MULTI-FUNCTION LEVER

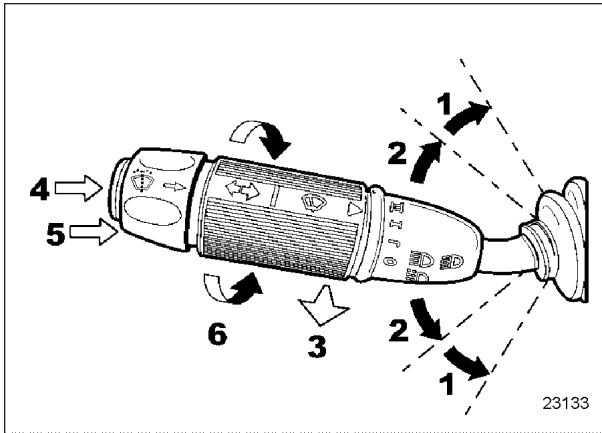

MULTI-FUNCTION LEVER

The multi-function lever is used to operate the following:

(1) Turn Signal

Move the lever all the way up until it locks in position to signal a right turn. Move the lever all the way down until it locks in position to signal a left turn. The lever automatically returns to the horizontal OFF position once the turn is completed.

(2) Lane Change Signal

Move the lever part way to the catch position and hold until the lane change maneuver is completed. The lever will spring back into the OFF position once released.

(3) Headlight Beam Toggle Switch

Toggle between high and low beams by pulling the lever up towards you. To flash the headlights, pull the lever up halfway. The lever will spring back into normal position once released.

(4) Courtesy Blinkers

Clearance and parking lights can be flashed by pressing the button located on the lever tip.

(5) Windshield Washer Control

Push the external ring at the end of the lever towards the steering column to activate the windshield washers. The wipers come On and continue wiping for a few seconds after the ring is released.



WARNING

Before using the windshield washers in cold weather, heat the windshield with the defroster to prevent icing and reduced visibility.



CAUTION

To avoid damaging the pump mechanism, do not use the windshield washer when the fluid level is very low or empty.

(6) Windshield Wipers

Turn the lever counterclockwise to activate the windshield wipers. The first position activates the wipers intermittently. The second position is the slow speed and the third position is for high speed wiping.



CAUTION

To avoid scratching the windshield, do not operate the wipers when the windshield is dry. To avoid damaging the wiper motor, free wiper blades that may be frozen to the windshield before operating the wipers.

STEERING WHEEL CONTROLS

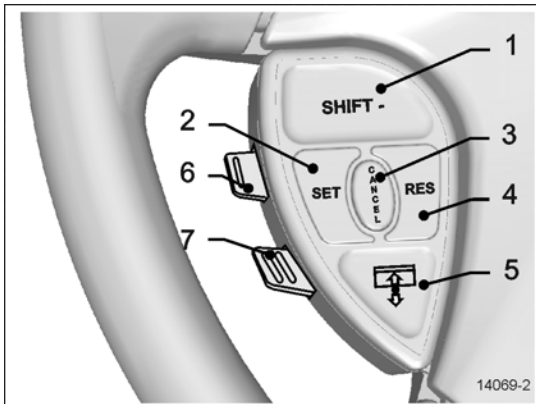

LEFT STEERING WHEEL CONTROLS

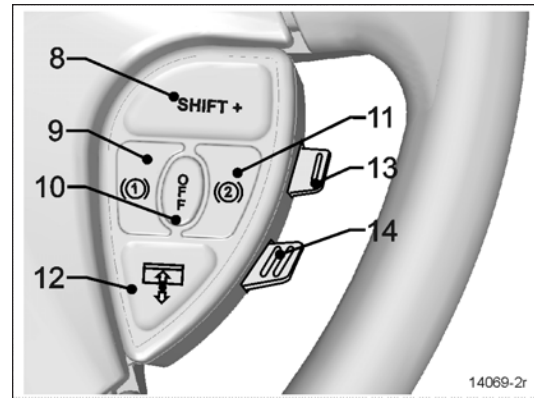

RIGHT STEERING WHEEL CONTROLS

THE STEERING WHEEL CONTROLS INCLUDE THE FOLLOWING FUNCTIONS:

1, 8 Shift Down, Shift Up (I-Shift Transmission Only)

Use these buttons to shift down or shift up manually the transmission range as would do the “-” & “+” keys on the I-Shift gear selector keypad.

2, 3, 4 Set, Cancel, Resume (Cruise Control)

For cruise control operating instructions, refer to [“CRUISE CONTROL” on page 50](#) in this section.

5, 12 Left Sunshade

Press and hold the button to lower the left sunshade. Press twice rapidly and hold the button to raise the left or right sunshade.

	<p>CAUTION</p>
<p>Do not attempt to raise or lower these shades manually. Damage to the electric motor or roller mechanism could result.</p>	

6 Escape/Enter (Driver Information Display)

Enter: Lift this button briefly.

Escape: Press briefly on this button.

7 Up/Down (Driver Information Display)

Use this button to scroll up or down through the menus.

9 Retarder / Engine Brake Low (ⓐ)

If the vehicle is equipped with a transmission retarder, press this button to enable the transmission retarder. Afterwards, operate the transmission retarder with the hand lever mounted on the steering wheel or the brake pedal. For more information about the operation of this system, refer to “transmission retarder” heading in this chapter.

On vehicles equipped with an engine brake, the engine brake provides two levels of braking power. Press this button for low engine braking power (about 50 % of full braking power). Refer to [“VOLVO ENGINE BRAKE \(VEB\)” on page 26](#) in Section 5 Other Features for more information about the engine brake operation and AUTO (ⓐ) mode.

4-10 Controls and Instruments

10 Retarder / Engine Brake Off

Press this button to cancel operation of the transmission retarder.

On vehicles equipped with engine brake, this button is a momentary switch that will cancel the Engine Brake LOW ① or Engine Brake HIGH ② mode and switch the engine brake to AUTO ③ mode. On vehicles so equipped, an engine brake switch located in the dashboard can be used to cancel completely (OFF mode) the engine brake.

NOTE

<i>Engine brake is safe to use in any road conditions including adverse conditions.</i>

11 Retarder / Engine Brake High ②

If your vehicle is equipped with a transmission retarder, this button has the same effect as the retarder/engine brake LOW ① button.

On vehicles equipped with engine brake, pressing this button will permit full application of the engine brake (100 % of braking power). Refer to "[VOLVO ENGINE BRAKE \(VEB\)](#)" on [page 26](#) in Section 5 Other Features for more information concerning the engine brake operation and AUTO ③ mode.

12 Right Sunshade

Press and hold the button to lower the right sunshade. Press twice rapidly and hold the button to raise the left or right sunshade.



CAUTION

Do not attempt to raise or lower these shades manually. Damage to the electric motor or roller mechanism could result.
--

13 Volume (Dashboard Radio)

Use this button to increase or decrease the dashboard radio (driver's radio) volume.

14 Seek (Dashboard Radio)

Use this button to seek up or down for a radio station.

HORNS

The electric horn (city horn) and air horn (highway horn) are operated from the steering wheel center pad. Use the Horn Selector switch located on the lateral control panel to select the appropriate horn type.

NOTE
 When the vehicle is stationary, the electric horn will sound to inform the driver that a fire is detected in the engine compartment.

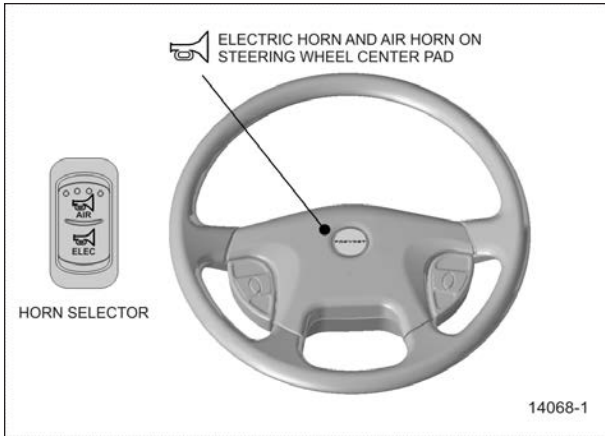

STEERING WHEEL

TRANSMISSION RETARDER

The transmission retarder is available only with the Allison transmission.

The retarder can be operated using a hand lever mounted on the steering wheel column or using the service brake pedal.

To use the transmission retarder, it must be activated first by pressing one of the two Retarder/Engine Brake buttons on the steering wheel.

Operating The Retarder Using The Hand Lever

With the retarder enabled and the accelerator pedal released, move the output retarder lever clockwise from the first to the sixth position. The braking effect occurs as soon as the accelerator pedal is released. The braking level for each position is as follows:

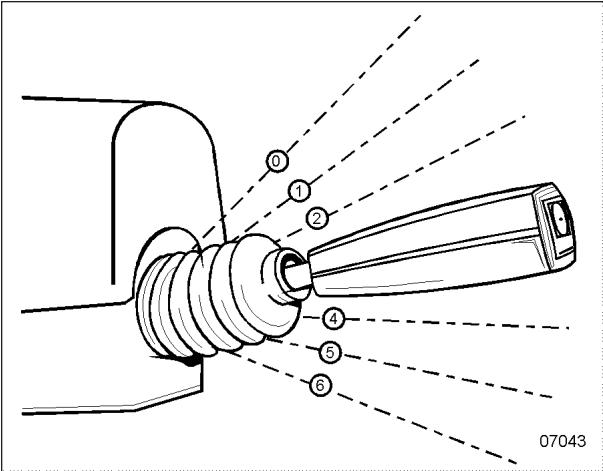

RETARDER HAND LEVER

Position	Braking level (up to)
(0) Initial	Varies with brake pedal position. No effect upon release of the accelerator pedal.
(1)	16%
(2)	33%
(3)	49%
(4)	71%
(5)	89%
(6)	100%

NOTE
 The output retarder lever is located on the right side of the steering column.

Operating The Retarder Using The Brake Pedal

With the retarder enabled, the accelerator pedal released and the output retarder lever in the initial position (0), depressing the brake pedal will engage both the service brake and the transmission retarder. This is referred to as retarder-brake blending. The further the pedal is depressed, the more total braking power is provided. Refer to ["TRANSMISSION RETARDER" on page 25](#) for further information about the transmission retarder.

NOTE
 If the wheels start to lock up on slippery roads, the output retarder will automatically deactivate until the wheels start to turn.

LATERAL CONTROL PANEL

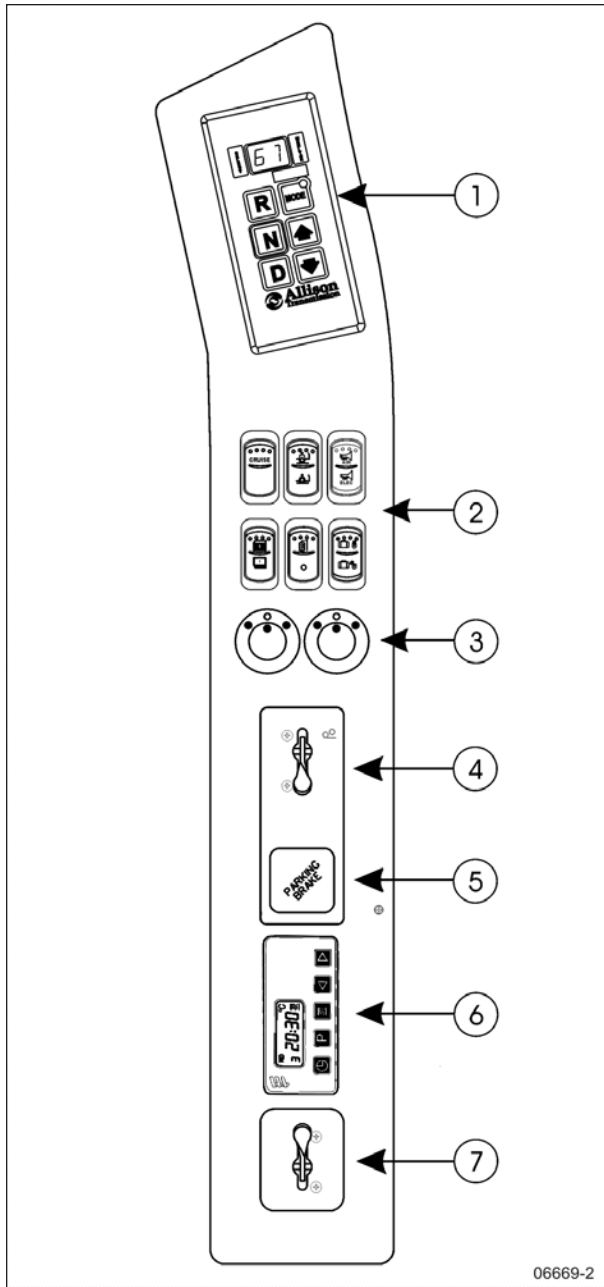

LATERAL CONTROL PANEL (TYPICAL)

1. Transmission control pad
2. Control switches
3. Mirror controls
4. Tag axle control valve
5. Parking brakes control valve
6. Coolant heater timer (option)
7. Low-buoy control valve (option)

TRANSMISSION CONTROL PAD

The Allison or Volvo I-Shift transmission control pad is located on the lateral control panel. Refer to ["ALLISON TRANSMISSION" on page 61](#) or ["VOLVO I-SHIFT TRANSMISSION" on page 64](#) in this chapter for operating instructions and more information.

CONTROL SWITCHES

Cruise Control Switch

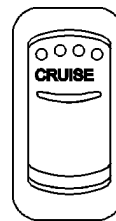

Depress the cruise rocker switch to activate the cruise control. This turns the system on. A led on the switch shows that you can now set the vehicle at a desired cruising speed.

For operation of the cruise control, refer to ["CRUISE CONTROL" on page 50](#) or ["PREVOST AWARE ADAPTIVE CRUISE BRAKING" on page 52](#) in this section.

Kneeling / Front Axle Hi-Buoy (Optional)

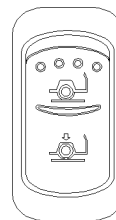

Momentarily press the rocker switch downwards to lower the front end of the coach 4 inches (100 mm). Momentarily press the rocker switch upwards to raise the coach to the normal driving height. Refer to ["HI-BUOY" on page 29](#) and ["KNEELING SYSTEM" on page 29](#) in Section 5 for more information.

Press and hold the rocker switch upwards to raise the front end of the coach 4 inches (100 mm). Release the rocker switch to return the coach to the normal driving height.

NOTE

The parking brakes must be applied to allow the use of the kneeling.

Kneeling / Full Hi-Buoy (Optional)

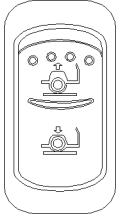

Momentarily press the rocker switch downwards to lower the front end of the coach 4 inches (100 mm). Momentarily press the rocker switch upwards to return the coach to normal driving height. Refer to ["HI-BUOY" on page 29](#) and ["KNEELING SYSTEM" on page 29](#) in Section 5 for more information.

Press and hold the rocker switch upwards to raise the complete suspension of the coach 4 inches (100 mm). Release the rocker switch to return the coach to the normal driving height.

NOTE
The parking brakes must be applied to allow the use of the kneeling.

Horn Selector

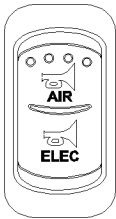

Use this switch to toggle between the air horn and the electric horn when pressing the steering wheel center pad.

Power Window Switch

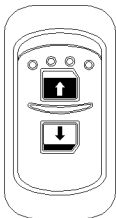

Use this rocker switch to open or close the driver's power window.

CAUTION
 Close power window when parked or leaving the coach unattended.

Outside Rear View Mirror Heat (Optional)

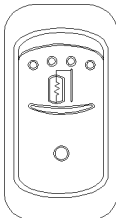

Press this rocker switch to clear fog, frost or thin ice from outside mirrors.

Baggage Compartments Locking System

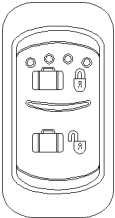

This system enables locking all baggage compartment doors by pressing the switch forward. To unlock, press the switch rearward.

NOTE
Service compartment doors are not linked to the baggage compartment-locking system.

NOTE
Baggage compartment doors must be unlocked using the key first, they can then be unlocked or locked using the baggage compartment-locking system.

MIRROR CONTROLS

Turn the pointer knob counterclockwise for flat mirror adjustment and clockwise for convex mirror adjustment, then use the pointer knob as a joystick to adjust the selected mirror's viewing angle. Adjust the right outside mirror similarly but by using the right side control.

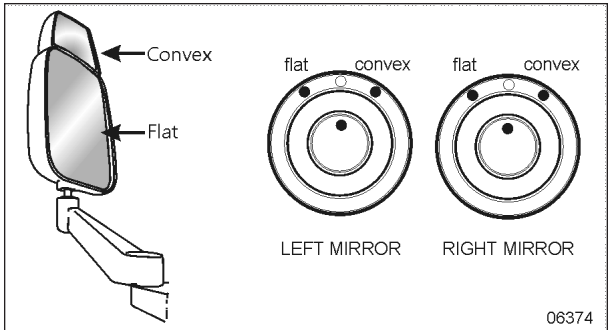

MIRROR CONTROLS

NOTE
If the mirror assemblies on your vehicle do not include convex mirrors, only one mirror control knob will be installed for both mirrors. To operate, turn pointer counterclockwise for L.H. mirror adjustment and clockwise for R.H. mirror adjustment, then use the joystick control to adjust the selected mirror's viewing angle.

4-14 Controls and Instruments

TAG AXLE CONTROL VALVE

Lift the tag axle by pushing the lever forward. Pulling the lever rearward will lower and load the tag axle. Refer to ["RETRACTABLE TAG AXLE" on page 30](#) in Section 5 Other Features for additional information.

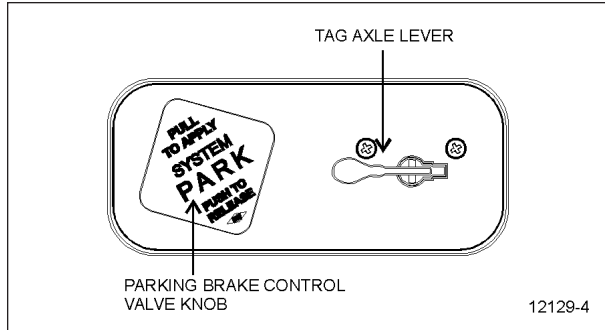

TAG AXLE CONTROL VALVE



Do not drive vehicle with tag axle raised when speed is exceeding 12 mph (20 km/h).

PARKING BRAKE CONTROL VALVE

Spring-loaded parking brakes are applied by lifting the safety cover (if present) and pulling up the control valve knob. Push down to release brakes. Refer to ["EMERGENCY AND PARKING BRAKES" on page 12](#) in Section 7 Safety Features and Equipment.

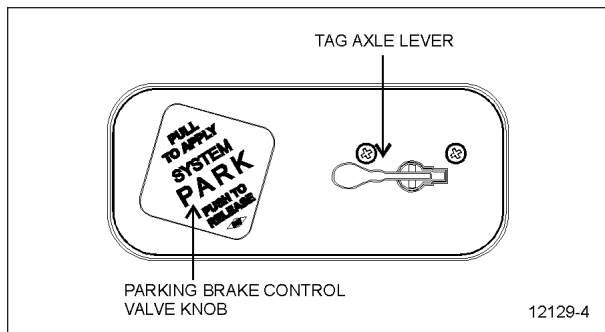

PARKING BRAKE CONTROL VALVE

COOLANT HEATER TIMER (OPTION)

Use the timer to program the start time of the optional engine coolant heater. Refer to ["COOLANT HEATER TIMER" on page 31](#) in Section 5 Other Features and [7 day timer operating instructions](#) for additional information.

LOW-BUOY CONTROL VALVE (OPTION)

Toggle back the control lever to lower the coach by about four inches. Returning the lever to the normal (forward) position raises the vehicle back to its normal height. Refer to ["LOW-BUOY" on page 29](#) in Other Features section for more information.

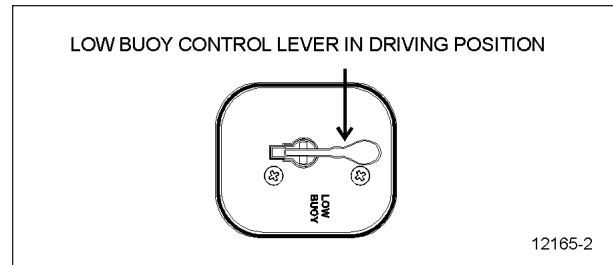

LOW-BUOY CONTROL VALVE



Do not exceed speeds of 5 mph (8 km/h) when activated.

UTILITY COMPARTMENT & 12V POWER OUTLET

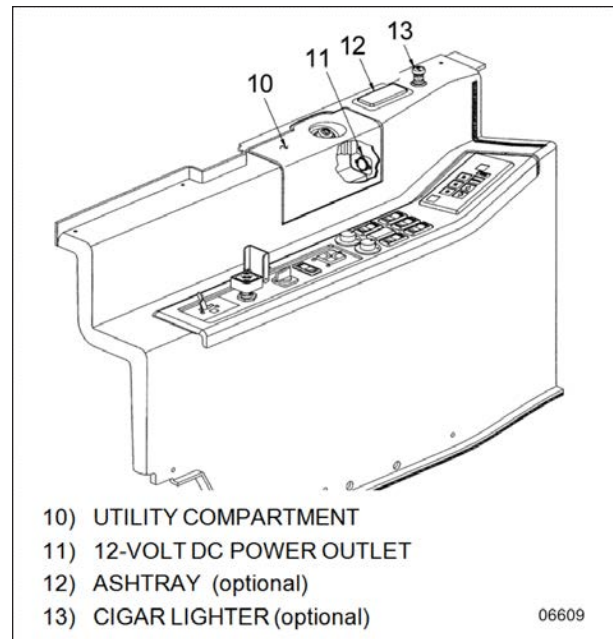

To open the compartment, push down on the lock button and swing the cover open towards the inside of the coach.

A 12-volt DC power outlet is located inside the pocket.

This socket can be used to power small 12-volt DC appliances such as a cellular phone or a vacuum cleaner. The maximum power consumption allowed for appliances plugged in this socket is 130 watts. Make sure appliances are equipped with suitable plugs that will not damage the socket.

EMERGENCY/PARKING BRAKES OVERRULE CONTROL VALVE

The coach may be equipped with the optional parking brake overrule system, which allows the vehicle to be moved to the nearest safe parking area if the spring-loaded emergency brake has automatically applied to the drive axle wheels. To actuate the parking brakes overrule system, push and hold down the control valve located on the lateral control panel.

4-16 Controls and Instruments

DASHBOARD

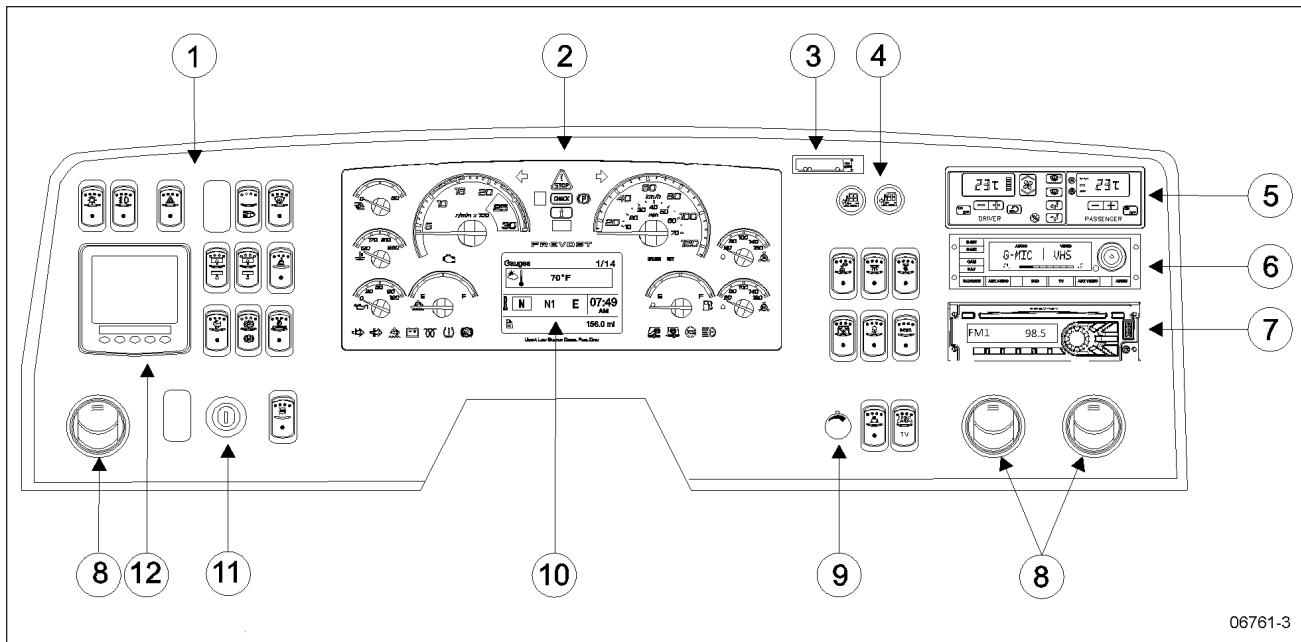

06761-3

DASHBOARD

1. L.H. dashboard panel
2. Instrument cluster
3. Vehicle clearance information
4. R.H. dashboard panel
5. HVAC control unit
6. Audio-video selector panel VSS-05
7. Dashboard radio
8. Air registers
9. Brightness control
10. Driver information display (DID)
11. Ignition switch
12. On-Screen tire pressure monitoring system display

CONTROL SWITCHES

High quality laser-engraved switches are used to control many of the features of the vehicle. Many switches have an embedded indicator LED to inform the driver at a glance which features are active.

On some switches, the indicator LED will turn off after a short while when the engine is running. This is normal and is designed to reduce glare when driving. The functions still operate even if the LED is off. If the switches are still on when the engine is turned off, the LEDs will illuminate to warn the driver to turn them off. Switches are described in the order they appear, from left to right, top to bottom.

L.H. DASHBOARD PANEL

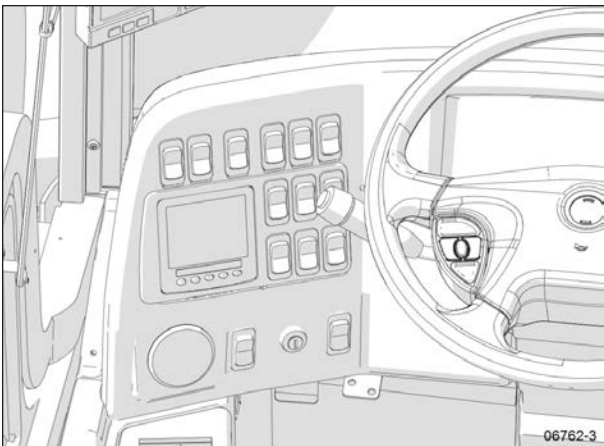

L.H. DASHBOARD PANEL

The L.H. dashboard panel includes controls for the operation of the coach; it also includes the [IGNITION SWITCH](#) and an adjustable air register.

Headlights And Exterior Lighting

OFF position – Daytime running lights only (with engine running).

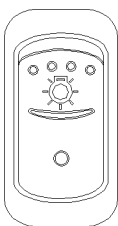

Press this rocker switch to turn on the following lights:

First position – Front parking lights, taillights, clearance lights, marker lights, license plate light.

Second position (push down fully) – the headlights, the controls and instrument lights and all lights from the first position.

NOTE

Daytime running lights will be automatically canceled when the exterior lighting switch is fully depressed (second position).

Fog Lights (Optional)

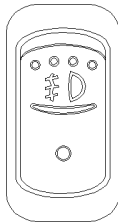

Optional halogen fog lights provide better visibility in fog and precipitation. They improve close range visibility and provide added safety.

NOTE

Some states and provinces restrict the use of fog lights. Verify local state or provincial regulations before using.

Hazard Warning Flashers

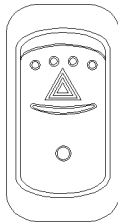

Press the rocker switch to make all turn signal lights flash at once. The dashboard telltale lights will flash when the hazard warning flashers are ON.

Once the hazard warning flashers are activated, the ignition switch can be turned to the OFF position. The hazard warning flashers will stay activated and will prevent the vehicle systems to fall in “sleep mode”.

Upper Windshield Wipers (Optional)

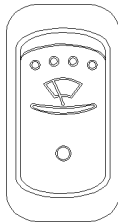

Press the rocker switch to the first position to activate the upper wipers intermittently.

Press to the second position for continuous operation of the upper wipers.

CAUTION

To avoid damaging the wiper blades or scratching the windshield, do not operate the wipers when the windshield is dry. Also, loosen frozen wipers before operating.

NOTE

Lower windshield wipers are activated using the multi- function lever. Refer to ["STEERING COLUMN CONTROLS"](#) on page 8 in this section.

4-18 Controls and Instruments

Upper Windshield Washer (Optional) & Headlights Washer

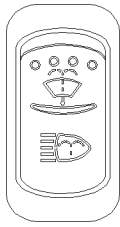

Press this rocker switch upwards to spray the upper windshields with washer fluid. Windshield wipers will automatically come on and stop a few seconds after releasing the switch.

Momentarily press this rocker switch downwards to spray the headlights washer fluid. Each pressing of this switch produces 2 successive jets.



CAUTION

Do not operate the washer mechanism while the washer fluid reservoirs are empty. This may damage the washer fluid pumps.

NOTE

Lower windshield wipers are activated using the multi-function lever. Refer to "[STEERING COLUMN CONTROLS](#)" on page 8 in this section.

Windshield Upper Section Defrosting (Option)

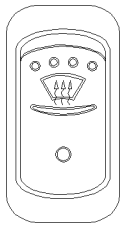

The coach may be equipped with an optional defrosting system in the upper windshield section. Press the rocker switch to activate the blower in order to clear fog, frost or thin ice from either side of the upper windshield.

The upper windshield defrosting is automatically activated when:

1. The outside temperature is lower than 39°F (4°C);
2. The engine temperature is higher than 86°F (30°C);
3. The driver's side HVAC control unit is turned on and the fan speed is higher than zero.

After automatic activation of the upper windshield defrosting, the upper defroster unit can be turned off by cycling this switch to the ON position and then to the OFF position.

Traction Control System Mud/Snow Mode

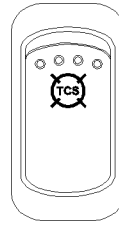

On certain road conditions, it may be useful to retard the intervention of the traction control system TCS during vehicle acceleration. The Mud/Snow function allows greater engine power and more wheel spin during TCS operation. This function may be helpful to set the vehicle in motion on iced roads, for example.

Press the Mod/Snow switch to turn on this function. The TCS icon blinks slowly in the DID when the TCS Mud/Snow mode is active. Always remember to turn the Mud/Snow feature off when driving on a firm road surface.

A new ignition cycle or a second pressing of the Mud/Snow switch will turn this function off.

Wheelchair Lift (Option)

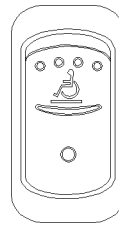

Supply electrical power to the wheelchair lift system by pressing down on the rocker switch. Refer to Other Features for instructions on operating the wheelchair lift.

Fast Idle

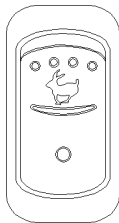

For extended idling periods, run the engine at fast idle. Press down this rocker switch to engage fast idle. This increases the engine speed to approximately 1,000 rpm. Return to normal idle before driving or when stopping the engine.

	CAUTION
<p>If the parking brake is released and/or the transmission is engaged with the engine running at fast idle, the engine will return to normal idle and remain there as long as the parking brake is not applied and/or transmission is not placed in neutral (n).</p> <p>The engine will return to fast idle once the parking brake is applied or neutral (n) selected.</p>	

	CAUTION
<p>Return the engine to normal idle before shutting the engine off.</p>	

Engine Brake (Optional)

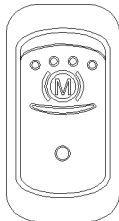

The vehicle's engine brake is by default set to automatic (AUTO (A) mode). On vehicles equipped with this switch, it is possible to disable the engine brake (OFF mode).

From OFF or AUTO mode, the driver can switch directly to Engine Brake LOW (1) or Engine Brake HIGH (2) mode by using the buttons on the steering wheel. Refer to ["TRANSMISSION RETARDER" on page 25](#) & ["ENGINE BRAKE" on page 25](#) in Section 5 Other Features.

The switch will have to be pressed again to return to AUTO (A) mode (cycling the ignition will have the same effect).

Engine Brake / Transmission Retarder

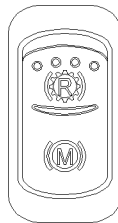

Use this switch to select between the transmission retarder or the engine brake when using the vehicle speed retarding device switches on the steering wheel. Neither system can be in function at the same time. This rocker switch is present on the dashboard, only if the vehicle is equipped with both systems. Refer to ["TRANSMISSION RETARDER" on page 11](#) in this section. Refer also to ["TRANSMISSION RETARDER" on page 25](#) & ["ENGINE BRAKE" on page 25](#) in Section 5 Other Features.

Engine Stop Override (With Automatic Fire Detection And Suppression System)



Press the Engine Stop Override switch on the dashboard or the Delay Engine Stop switch on the AFSS protection panel to delay the engine shutdown and extinguisher discharge by an additional 15 seconds.

	CAUTION
<p>Use this function if you are not prepared to bring the vehicle to a safe stop (i.e. on a railroad track, in intersection).</p>	

This switch is functional only if the vehicle is equipped with the Automatic Fire Detection and Suppression System.

Driver Controlled Differential Lock (Dcdl) (Optional)



Press this rocker switch to lock or unlock differential action. Refer to ["DRIVER CONTROLLED DIFFERENTIAL LOCK \(DCDL\)" on page 28](#) in Section 5 Other Features for the complete operating instructions.

4-20 Controls and Instruments



CAUTION

- Engage DCDL only under poor road surface conditions.
- DCDL will not engage and will disengage in speed higher than 5 mph.
- Do not lock DCDL when one or more wheels are slipping, spinning or losing traction. You can damage the drive axle.
- Using the rocker switch, unlock DCDL when the need for improved traction has passed otherwise it will re-engage automatically as speed gets below 5 mph. Over a prolonged period, this situation will increase tire wear and stress to the vehicle.
- Do not engage during downhill operation.

R.H. DASHBOARD PANEL

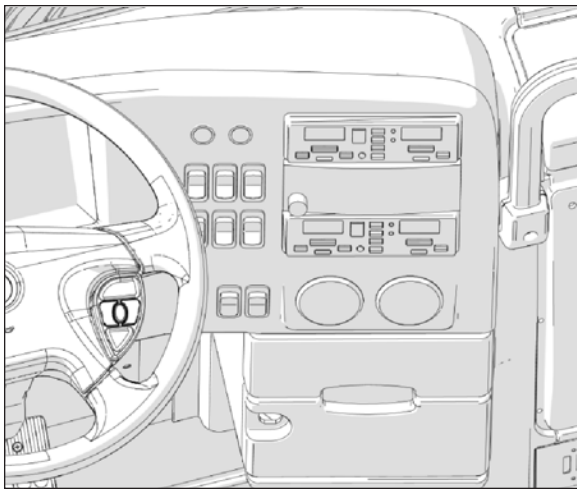

R.H. DASHBOARD PANEL

Controls for passenger entertainment are grouped on the R.H. dashboard panel. The HVAC control module as well as the cluster dimmer switch, miscellaneous control switches and air vents are also located on this side of the dashboard.

Vehicle clearance information may also be affixed in this location.

Vehicle Clearance Information

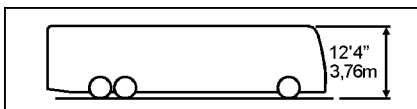

Safe vehicle clearance height is 12'4" (3.76 m).



CAUTION

Vehicle clearance is higher when the ventilation hatch is open (if installed), Hi-Buoy is selected or if additional equipment is installed on the roof.

Door Operating Buttons



CLOSE



OPEN

Press and hold button to open or close the door.

Releasing the button at any time will immediately stop door movement.



WARNING

The door mechanism has no automatic safety protection to avoid injury to bystanders. The driver is responsible for the safe operation of the door.

Driver's Area Lighting

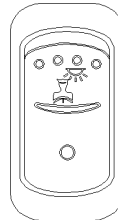

Press this rocker switch to turn on the driver's overhead light as needed.

NOTE

The entrance overhead light and the stepwell lights turn on with the entrance door opening and turn off with door closing. If the entrance door is left opened, these lights will be turned off automatically if the battery voltage drops below 24.0 volts.

Interior Lighting

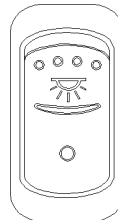

Press this rocker switch to the first position to illuminate the aisle fluorescent lighting. Press down the second position to gradually illuminate the in-station reading lights to 80% of their intensity regardless if they were turned off individually by passengers. Lights will also turn OFF gradually.



CAUTION

To avoid running down the batteries when the engine is off, turn off the lights or connect the optional battery charger to a 110-120-volt AC power supply.

Reading Lights

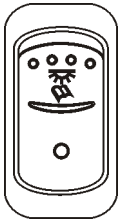

This switch powers the reading light circuit enabling passengers to operate their personal reading lights. Refer to “Coach Interior” chapter.

Turning the key or ignition lever to the accessory position “ACC” when the reading lights are on will activate the lights to full intensity, providing a clear view over the entire cabin area.

Passenger Overhead Air Registers

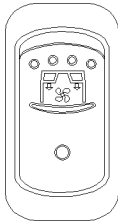

Press this switch to activate the passenger overhead air registers fan.

Stop / Service Chime (Optional)

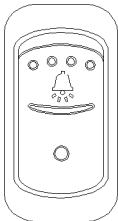

Press this switch to enable the stop/service chime. Even when the chime circuit is disabled, the buttons in the overhead panels will illuminate if depressed by the passengers.

Destination Sign (Optional)



Press this rocker switch to illuminate the destination sign.

Brightness Control

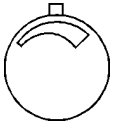

Adjusts the brightness of the dashboard instruments and switches.

Galley

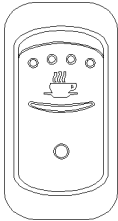

This switch activates the optional galley’s electrical circuit.

4-22 Controls and Instruments

HVAC CONTROL UNIT

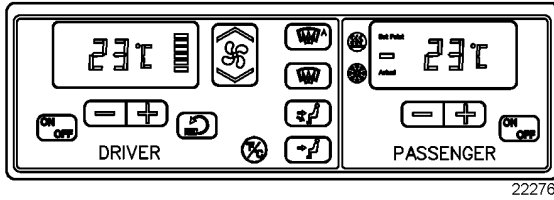

CONTROL UNIT FOR HIGH CAPACITY CENTRAL HVAC SYSTEM

The temperature control in the driver's area is provided directly by the driver section of the HVAC control unit.

Using the Up/Down type switch sets the fan speed. The set speed appears on the display.

The vehicle is slightly pressurized by the HVAC system to prevent dust and moisture from entering.

On high capacity central systems, airflow and controls divide the vehicle into two areas: driver's area with defroster and passengers' area. Fresh air is fed in each area and has a separate return air and discharge air duct.

NOTE

To operate the air conditioning system when stationary, run the engine at fast idle. When the system is running, keep windows and door closed.

To prevent battery run-down, the central A/C and heating systems will not operate if the charging system is not working properly.

When the A/C system is running, park at least 4 feet (1,5 m) from other vehicles or buildings to allow sufficient air flow through the condenser core.

Separate driver and passenger heating, ventilation and air-conditioning controls are located on this panel. To operate, the vehicle's engine must be running.

The units may be turned on by pressing the following button:

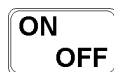

Also, the driver's HVAC section turns on automatically at engine start and uses the settings that were kept in memory before turning off of the system.

The A/C compressor starts automatically when the two following conditions are satisfied:

1. The outside temperature is above 32°F (0°C).
2. The passenger's area temperature has reached 7°F (4°C) under the set point.

NOTE

Upon starting if the outside temperature is above 32°F (0°C) and then drops below 32°F (0°C), the compressor will keep running up to a temperature of 15°F (-9°C) to prevent condensation from forming on the windows.

All parameters set before turning the system Off will be kept in memory for the next power On.

The HVAC module performs a self-diagnosis every time it is turned ON. Codes are shown on displays or flashed on control buttons. Refer to "Maintenance Manual" for more information on the diagnostic codes

Heating Mode Indicator



This red LED illuminates when the system is heating.

Cooling Mode Indicator

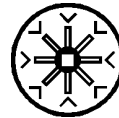

This green LED illuminates when the system is cooling (when the compressor clutch is engaged).

Fan Speed



The driver's fan has six speeds. Increase speed by pressing on the upper portion of the button, decrease by pressing on the lower portion.

Recirculate



Closes or opens both the driver's and passenger's section fresh air damper.

A red LED in the top right corner of the button illuminates when air is recirculated. Use for faster driver's section heating.

This feature is automatically canceled when defogging is activated.

Driver's Section Temperature Setting

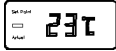

The temperature displayed on the driver's side HVAC control unit is the temperature set point.

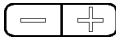

To increase the temperature set point, press the "+" sign, to decrease the temperature set point, press the "-" sign. Temperature range is between 60°F and 82°F (16°C to 28°C). On the driver's side only, asking for a temperature set point above 82°F (28°C) will keep the coolant valve open and "FUL" will be displayed.

In case of interior temperature sender unit failure, the coolant valve will remain open and three lines "---" will be displayed.

WARNING

Warm temperatures may cause drowsiness and affect alertness while driving. Keep the temperature comfortable but not too high.

Passenger's Section Temperature Setting

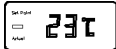

The temperature displayed on the passenger's side HVAC control unit is the actual temperature in the passenger's area.

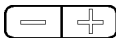

To increase or decrease the temperature set point in the passenger's area, press on the "+" or the "-" sign. Pressing these buttons will flash the displayed set point and the word "SET" will highlight. Temperature range is between 60°F and 82°F (16°C to 28°C).

In case of interior temperature sender unit failure, the coolant valve will remain open and three lines "---" will be displayed. The driver can nevertheless control the temperature by adjusting the temperature set point above 72°F (22°C) to heat and below 72°F (22°C) to cool.

NOTE

Upon starting of the vehicle, when the ambient temperature is very cold and so is the inside of the vehicle, the HVAC control unit will allow a temperature overshoot up to 3° over the passenger's area set point to help warming up of the area because some parts of the vehicle like the seats and the overhead compartments accumulate cold.

Windshield Defogger



Upon pressing this button, the dashboard damper sends air only to the lower windshield. The fan is turned on to maximum speed, the fresh air damper opens completely (REC off) and the driver set point is increased to 4°F (2°C) over the passenger's section set point.



The dashboard damper sends air only to the lower windshield when activated. The footwell damper is also closed but the fan speed can be reduced or increased.

Panel And Footwell



The dashboard damper sends air to the panel vents and footwell.

Panel

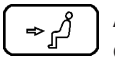

Air is sent to panel registers. The foot damper is closed.

Temperature Degree Selector



Toggles the HVAC control unit temperature units between Fahrenheit and Celsius. The driver's section must be on. Also toggles the outside temperature units displayed on the telltale panel.

4-24 Controls and Instruments

AUDIO-VIDEO SELECTOR PANEL FOR THE PASSENGER'S AREA



23451

The VSS-05 Video and Sound Selector enables the driver to select audio, audio/video and video sources with settings of volume level, bass, treble, etc. for the passenger's area only. The DVD player, media player, microphones and auxiliary audio or video sources are controlled with this unit.

Turning Power On And Off

Press  button to turn on the unit.

Press  button again to turn off the unit.

Setting Of Volume/ Bass/ Treble/ Balance/ Loudness

AUDIO

Press AUDIO button repeatedly to choose the desired mode. Each press changes the modes as follows:

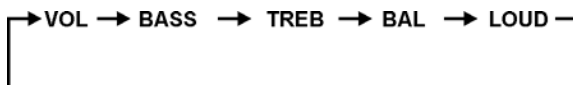

Turn volume knob until the desired sound is obtained in each mode. The final setting will apply to all audio sources for the passenger's area. If no button is pressed within 8 seconds after selecting BASS, TREB, BAL and LOUD modes, the unit automatically sets in the VOL mode. The volume value adjust from 0 (complete mute) to 40 (maximum).

Audio Or Audio/Video Source Selection

RADIO/CD

Press RADIO/CD button to select the dashboard radio as current audio source for the passenger's

area. Pressing this button will also permit to listen to the CD inserted in the dashboard radio.

AUDIO IN

Press AUDIO IN button to select the auxiliary 3.5 mm connection in the modesty panel as current audio source.

DVD

Press DVD button to select DVD Player as current audio/video source.

TV

Press TV button to select the female HDMI cable connection coming from the back of the parcel rack HDMI switch as current audio/video source (standard on H3 Series, optional on X3 Series).

VIDEO IN

Press VIDEO IN button to select an auxiliary video input as current audio/video source.

Press VIDEO IN button to select the optional modesty panel HDMI connection as current audio/video source.

NOTE

If CAM or NAV is already activated, DVD, TV or VIDEO IN cannot be selected and displayed.

Operation Of The Panoramic View Camera

CAM

1. Press CAM button to select the optional panoramic view camera signal. The VIDEO section of the VSS-05 LCD panel will show "CAM". The video monitors turn on automatically.
2. Press CAM button again to turn off the panoramic view camera and return to previous audio/video source.

Display Of The GPS Navigation Guidance Screen

NAV Not applicable

NOTE
When CAM or NAV is selected, the previously selected audio source remains active.

- 1. Press and hold AUDIO button then press AUDIO IN button. The LCD panel will show "BACK GROUND".
2. Turn the volume knob to adjust the background level.
3. Press any button to save the setting. If no button is pressed within 8 seconds, the unit automatically saves the setting and exits this mode.

Operation Of The Driver Microphone

- D-MIC
1. Press D-MIC button to turn on the driver microphone. The audio section of the LCD panel will show "D-MIC" and a gong sound can be heard.
2. Turn volume knob to adjust microphone level.
3. Press D-MIC button again to turn off the driver microphone.

Gong Sound Level

A gong will sound in the passenger's area upon activating of the microphone. This gong will also sound when a passenger activates the service bell. The gong sound level can be adjusted as follows:

- 1. Press and hold AUDIO button then press VIDEO IN button. The LCD panel will show "GONG PASS".
2. Turn the volume knob to adjust the gong level.
3. Press any button to save the setting. If no button is pressed within 8 seconds, the unit automatically saves the setting and exits this mode.

Operation Of The Guide Microphone

- G-MIC
1. Press G-MIC button to turn on the guide microphone. The AUDIO section of the LCD panel will show "G-MIC" and a gong sound can be heard.
2. Turn volume knob to adjust microphone level.
3. Press G-MIC button again to turn off the guide microphone.

NOTE
While maintaining the service bell gong active, the gong sound heard upon activation of the microphones can be disabled. To do so:
• Press and hold AUDIO button then press G-MIC button. The LCD panel will show "GONG MIC ON" or "GONG MIC OFF"
• Turn the volume knob clockwise to activate the microphones gong sound. Turn the volume knob counterclockwise to deactivate the microphones gong sound.

NOTE
If both the driver and guide microphone are activated, the driver microphone has priority and the guide microphone is muted.

Background Volume Adjustment

When a microphone is activated, the current audio source volume will reduce to a certain level which has been set at the factory. To adjust this level, proceed as follows:

OPERATION OF THE OPTIONAL AUDIO-VIDEO MODESTY PANEL

On some vehicles, it is possible to connect and display on the main monitor a laptop (or other HDMI audio-video equipment) from an optional audio-video modesty panel located behind the driver's seat.

4-26 Controls and Instruments

To do so, connect the laptop to the modesty HDMI connector, select Video IN on the Video and Sound Selector and turn on the laptop presentation mode.

Devices using 3.5 mm audio connectors (MP3 players) can also be used by connecting them to the 3.5 modesty connectors and selecting the Audio IN mode. A USB connection is also available to recharge battery operated devices.

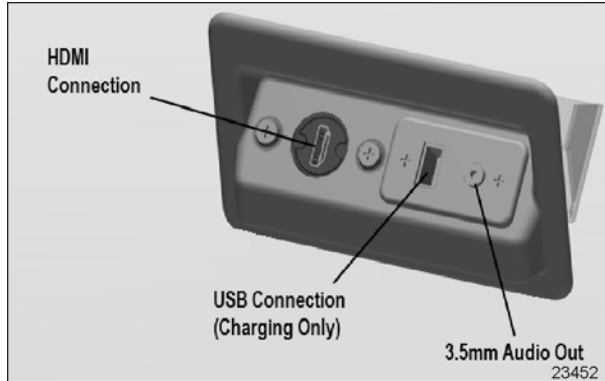

Using The Vss-05 Remote Control



1.

Press this button to turn on the unit. Press this button again to turn off the unit.

2. R/CD, AU IN, DVD, TV, VI IN

Press one of these buttons to select the relevant audio or audio/video source.

3. DMIC

Press dmic button to turn on the driver microphone.

Press dmic button again to turn off the driver microphone.

4. GMIC

Press gmic button to turn on the guide microphone.

Press gmic button again to turn off the guide microphone.

5. CAM

Press cam button to select the optional panoramic view camera signal.

Press cam button again to turn off the panoramic view camera.

6. NAV

Press nav button to display the optional GPS navigation system guidance screen (not applicable).

7. BAS, BAL, TRE, LOUD

Press one of these buttons to select BASS, BALANCE, TREBLE and LOUDNESS mode.

8. +, -

Press these buttons to increase or decrease the value for BASS, BALANCE, TREBLE and LOUDNESS mode.

NOTE

Point the remote control in direction of the VSS-05. Remote control battery replacement. Use CR2025 lithium battery.

DASHBOARD RADIO/MP3/IPOD/CD PLAYER

Select from several sources of entertainment for the driver's area such as AM, FM, WX weather band, Satellite radio services and Bluetooth (phone calls). Play a CD inserted in the radio's CD slot or listen to a MP3 device or iPod through this unit. The complete radio operating instructions manual is included in Technical Publication box.

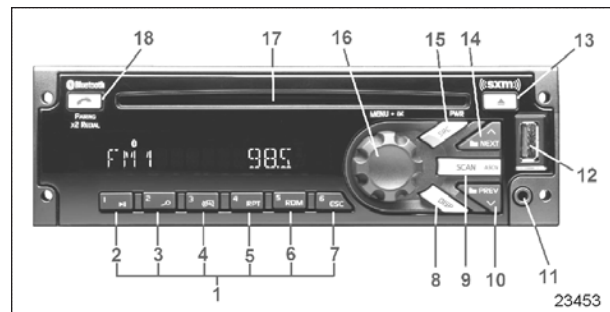

1. Storing Radio Station Presets

- Tune the desire frequency, and then long press any of the Preset (1-6) buttons until the radio produces a beep.

2. Tuning Radio Station Presets

- Short press any of the Preset (1-6) buttons.

3. Play/Pause

- Press to pause/unpause Media.

4. Browse

- Press to Navigate on the device and select a specific song or play context (Applicable to USB sticks, CD MP3 discs and iPods).

5. Clock/Alarm

- Press during Alarm activation to cancel the Alarm.

6. RPT (Repeat)

- Press to repeat current track. Press again to stop repeat.

7. RDM (Random)

- Press to play the tracks randomly. Press again to stop random mode.

8. ESC (Escape)

- Press to exit one Menu Level.
- While on Bluetooth (if equipped): Press to reject or to end a Call.

9. DSP (Display)

- If vehicle Ignition is ON:
 - Press to Change Source Display Views.
 - Press for more than 3 seconds to show the Clock for a short time.
- If vehicle Ignition is OFF:
 - Press to turn on the Radio and show the clock for a few seconds.

10. SCAN/ASCN (Scan/Autoscan)

- Scans stations/CD tracks/MP3/WMA files and folders and in tuner, stores strongest stations to presets.

11. PREV (Previous/Reverse)

- Press to select previous track or station.
- Press and hold for fast reverse or Tune Down.

12. Auxiliary port

- 3.5 jack stereo (iPod/MP3).

13. USB port

- iPod/MP3 players

14. Eject

- Press to eject CD

15. NEXT

- Press to select next track or station.
- Press and hold for fast forward or Tune Up.

16. SRC/PWR (Source/Power)

- Press to turn Radio ON
- Press to switch to FM->AM->WX weather band->SXM satellite-> CD->USB/iPod-> Rear/Front AUX-> Bluetooth.
- Press and hold to turn radio OFF.
- With the ignition off, pressing the button will turn on the receiver and it will turn off after one hour (timer).

17. Rotary knob

- Press for less than 3 seconds to display Audio Control Menu.
- Press for more than 3 seconds to Show the User Menu.
- Rotate to increase/decrease Volume or during a Menu for Navigation.
- Press while in a Menu to confirm the selected action.

18. CD slot

- Insert/Remove CD

<p>NOTE</p> <p><i>Using the microphone while driving is not recommended. For this reason, there are no microphones installed on the radio at the factory.</i></p>
--

<p>NOTE</p> <p><i>The driver speakers are controlled from the dashboard radio volume knob while the passenger's area speakers are controlled from the VSS-05 Sound Selector volume knob.</i></p>

4-28 Controls and Instruments

NOTE

See the owner manual for more information about how to use the radio. This manual is available on the technical publications web site at <https://techpub.prevestcar.com/en/> . Select Supplier Publication tab and select Delphi in the list of supplier names for a faster search.

AIR REGISTERS

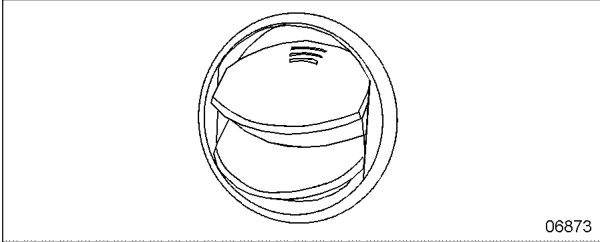

AIR REGISTER

Adjustable air registers feed air to the driver's area. Three are located in the dashboard and one near the door . Use the HVAC control panel to set air temperature and fan speed.

INSTRUMENT CLUSTER

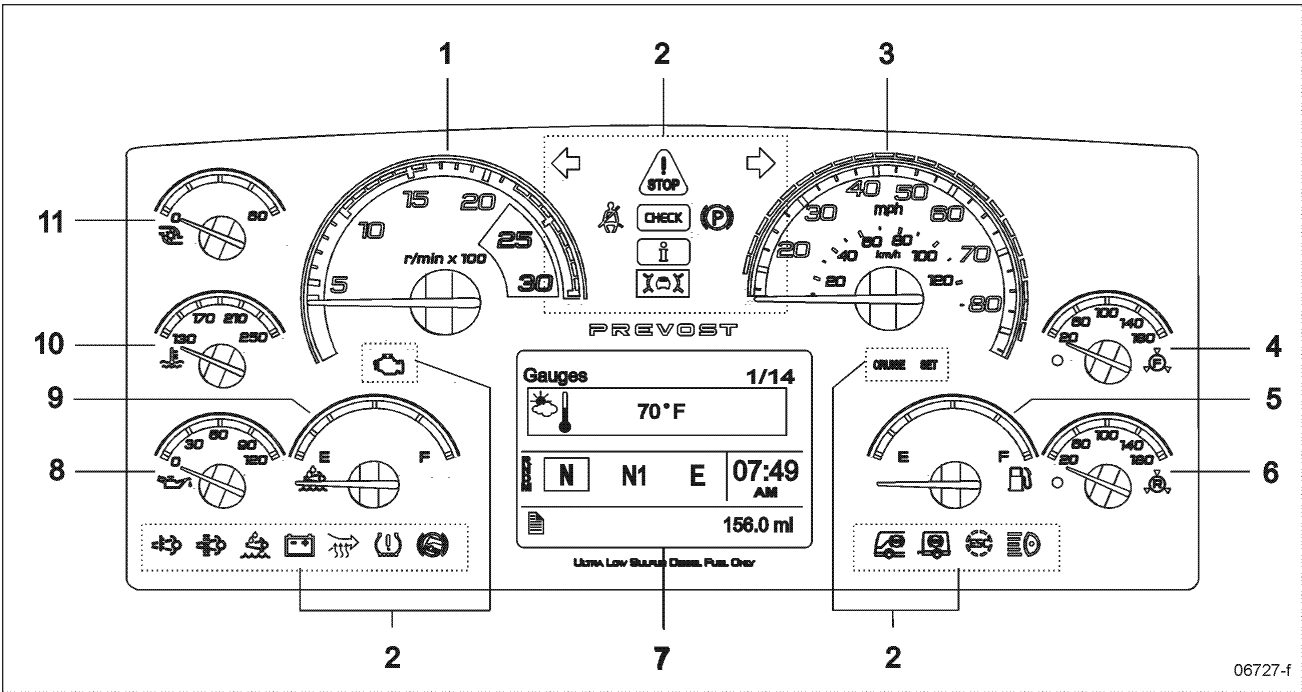

- 1. Tachometer
- 2. Telltale lights
- 3. Speedometer
- 4. Front brake air pressure (secondary)
- 5. Fuel level
- 6. Front brake air pressure (primary)
- 7. Driver Information Display (DID)
- 8. Oil pressure indicator
- 9. DEF (Diesel Exhaust Fluid) level indicator
- 10. Engine coolant temperature
- 11. Turbo boost pressure

4-30 Controls and Instruments

DRIVER INFORMATION LEVELS

The instrument cluster includes the analog instruments. It also presents two devices to communicate information to the driver, the telltale lights and the Driver Information Display (DID).

Indications and warnings are presented according to three levels of attention required:

FIRST LEVEL - TELLTALE LIGHTS

Telltale lights are temporary and exceptional; they present information critical to safety or vehicle integrity.

SECOND LEVEL - POP-UP MESSAGES

Pop-up messages appear in the Driver Information Display DID without the driver's intervention and acknowledgment. Pop-up messages present supplemental information to the driver.

THIRD LEVEL- THE STATUS LINE

The status line monitors certain systems and gives feedback to the driver concerning current actions and functions.

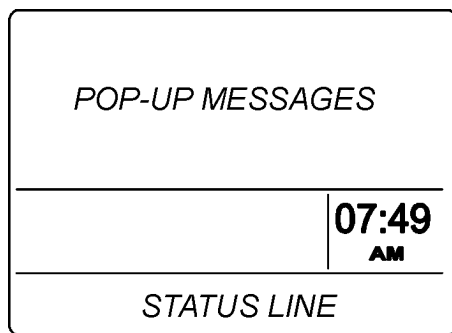

06742b

ANALOG INDICATORS

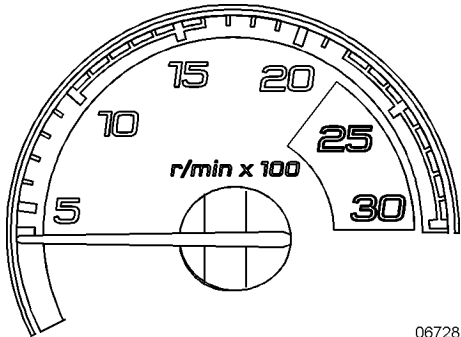

06728

Tachometer (Rpm X 100)

Indicates the operating speed of the engine in hundreds of revolutions per minute. The tachometer serves as a guide for gear shifting and helps to prevent engine over-speeding when driving downhill with the engine brake operating. Use the green range for normal driving (1000 to 1600 RPM).

 CAUTION
Never allow the engine to go into the red range. This could lead to severe engine damage.

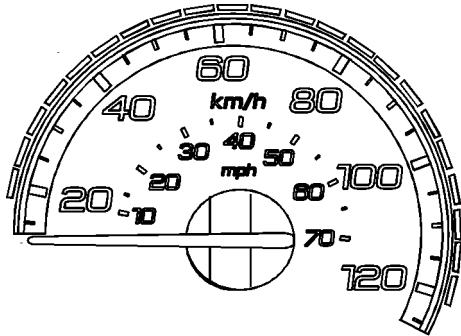

06729

Speedometer (MPH, Km/h)

Indicates the vehicle speed in miles per hour (mph) and kilometers per hour (km/h). The LEDs above the instrument work in conjunction with AWARE Adaptive Cruise Braking (ACB) system. Refer to "Prevost Aware Adaptive Cruise Braking" paragraph for further details.

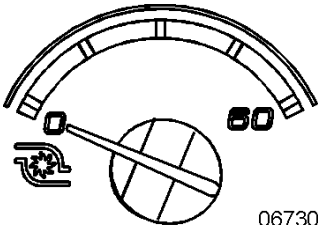

06730

Turbo Boost Pressure (psi)

Indicates the turbo boost pressure in psi. This pressure should be the same at a given engine temperature, speed, and load. An unusual reading could indicate an engine failure.

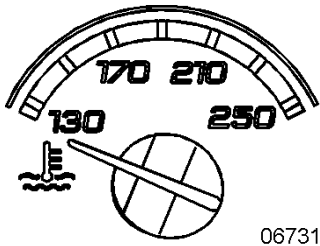

Engine Coolant Temperature (°F)

Indicates the operating temperature of the engine coolant in °F. The normal reading should be between 170°F and 222°F (80°C to 106°C).

The temperature limit is dependent on the electronic program for the engine model. When coolant temperature is excessive, the STOP telltale light turns on, an audible alarm sounds and a pop-up message appears on the DID. The engine protection system will automatically derate and stop the engine in 30 seconds. Stop at the first safe place where the problem can be checked.

If the temperature remains below or exceeds the normal temperature range, the cooling system should be checked for problems.



STOP telltale light

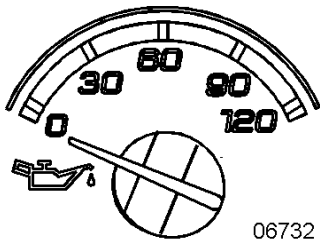

Engine Oil Pressure (psi)

Indicates the engine oil pressure in psi. When the oil pressure is too low, the STOP telltale light turns on, an audible alarm sounds and a message appears on the DID. The engine protection system will automatically derate and stop the engine in 30 seconds. Bring the vehicle to a safe stop where the problem can be checked.



STOP telltale light



OIL PRESSURE Pictogram

CAUTION

Failure to take necessary action when the STOP telltale light is on can ultimately result in automatic engine derate and shutdown.

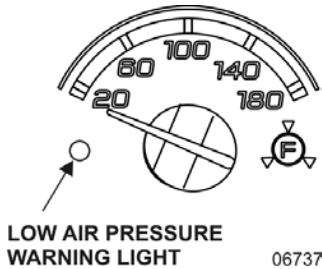

Front Brake Air Pressure Gage (Secondary System)

Indicates the front brake air system pressure in psi. The normal operating pressure is from 122 to 140 psi.

The low air pressure indicator LED on the gage and the STOP telltale light illuminate when the front brake air system (secondary) pressure drops below 85 psi. An audible alarm will sound.



STOP telltale light

 WARNING
<p>The driver is responsible for monitoring the pressure as part of a regular sweep of the instruments.</p> <p>If the pressure drops in the secondary system but remains normal in the primary system, the front axle service brakes will not function but the drive and tag axle service brakes will operate normally, although if there is a leak in any pneumatic system (Sec/Pri/Park/Acc), the primary system might eventually lose its air pressure as well, depending on the nature and size of the leak. In the event of any air pressure loss in any system, the driver should pull to the side of the road as soon as can be safely done and investigate the situation.</p> <p>Do not drive the coach when the brake air pressure is low.</p>

4-34 Controls and Instruments



Rear Brake Air Pressure Gage (Primary System)

Indicates the rear brake air system pressure in psi. The normal operating pressure is from 122 to 140 psi.

The low air pressure indicator LED on the gage and the STOP telltale light illuminate when the rear brake air system pressure drops below 85 psi. An audible alarm will sound.



STOP telltale light

WARNING

The driver is responsible for monitoring the pressure as part of a regular sweep of the instruments.

In the event of a pressure loss in the primary brake system, the drive and tag axle service brakes will not function normally. It is critical to bring the coach to a safe stop as quickly as possible.

If there is sufficient pressure in the secondary brake system, modulated spring brake pressure (using the park brake chambers) will be used to apply the drive axle brakes, proportional to the braking pressure on the front axle. It must be noted this is an emergency and a significant amount of secondary air pressure is lost with each apply/release cycle. The spring brake modulation will only function two or three times, depending on the amount of secondary air pressure that was on hand when the primary brake pressure was lost.

Once the secondary air pressure drops below 60 psig, the park spring brakes are fully applied and cannot be released until pressure is restored.

Do not drive the coach when the brake air pressure is low.

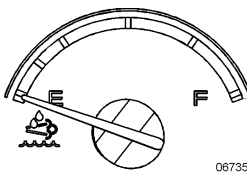

DEF Level

Indicates the amount of DEF (Diesel Exhaust Fluid) remaining in the DEF tank. The DEF tank is considered as being full when it contains 16 gallons (60 liters) of DEF. DEF consumption will be approximately 2% of the diesel fuel consumed.

CAUTION

DEF – Do not overfill

If an automatic nozzle is used for filling diesel exhaust fluid (DEF), do not add further DEF after the nozzle has automatically shut off flow a first time.

If such nozzle is not available, use the DEF level gage on the instrument panel to control the quantity during filling.

Diesel exhaust fluid DEF will begin to crystallize and freeze at 12°F (-11°C) and expand by 7% when frozen. To allow expansion without damaging the DEF tank, do not fill the tank with more than 16 gallons (60 liters).

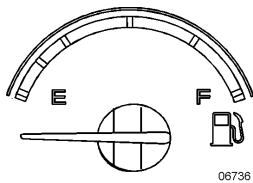

Fuel Level

Indicates the amount of fuel remaining in the fuel tank. At the beginning of the red area, there is approximately 48 gallons (182 liters) left in the tank.

NOTE
A pop-up message will appear in the DID informing that there is only 24 gallons (92 liters) left in the fuel tank.

TELLTALE LIGHTS

The telltale lights illuminate for 5 seconds at the start of every ignition cycle as a light bulb check.



Stop

Indicates that a serious problem has been detected. Immediately park the coach in a safe place and stop the engine. This telltale light may be accompanied with a message in the DID and a diagnostic troubleshooting code will be stored to ease identification of the problem.

 **WARNING**
Failure to take necessary action when the STOP telltale light is on can ultimately result in automatic engine derate and shutdown.



Check

Indicates that a problem has been detected and must be checked at the next stop. This telltale light may be accompanied with a message in the DID and a diagnostic troubleshooting code will be stored to ease identification of the problem.



Forward Vehicle Detected – Adaptive Cruise Braking

When the ACB is engaged with a cruise speed set and the forward vehicle is in range, the FORWARD VEHICLE DETECTED telltale light illuminates, indicating the ACB system is actively tracking the forward vehicle.

GREEN: The vehicle ahead of you is detected by the radar.

FLASHING RED: Impact alert. The vehicle ahead of you is too close. The driver must take immediate evasive action by applying more braking power and/or steering clear of the vehicle ahead to avoid a potential collision.

RED: System malfunctions. The Adaptive Cruise Braking is not available.



Information

This telltale light illuminates when there is a new information message or an abnormal status is detected by the electronic control unit. A pictogram, text or both are shown in the DID in addition to the INFO telltale light. Make sure the indicated fault is checked at the next stop.

4-36 Controls and Instruments



Turn Signal Indicators

Flashes when the right or left turn signals are activated. Signal right and left turns by operating the multi-function lever. See "[MULTI-FUNCTION LEVER](#)" on page 8 in this section.

NOTE

The turn signals are automatically activated when the vehicle is backing up.



Parking Brake Or Emergency Brake Applied

Illuminates when the emergency/parking brake is applied. The control valve is located on the L.H. control panel. An audible alert will sound if ignition is turned to Off and the parking brake is not engaged.



Driver's Seat Belt Reminder Light And Warning Buzzer

When equipped with a seat belt buckle switch, warns the driver to fasten his/her seat belt.



Aftertreatment System Malfunction (Malfunction Indicator Lamp)

Indicates a failure of an emission control device. May illuminate at the same time as the CHECK amber warning light. The lamp will go out after 3 completed ignition on-ride-ignition off cycles. Vehicle can be driven to end of the shift. Call for service.

CRUISE

Cruise Control

Indicates that the cruise control is enabled.

SET

Cruise Control Set Speed

Indicates that a cruising speed is set and stored in the memory.



High Exhaust System Temperature (HEST)

Illuminates to notify the driver of potentially hazardous exhaust gas temperature at the exhaust system diffuser.



WARNING

During regeneration, exhaust temperature may reach up to 1200°F (650°C) at the particulate filter. When parking the vehicle, if this telltale light is illuminating, make sure that the exhaust system diffuser is away from people or any flammable materials, vapors or structures.



DPF Regeneration Request

Illuminates to notify the driver that a manual stationary regeneration will be required soon. Refer to "[STATIONARY \(PARKED\) REGENERATION](#)" on page 3 in Section 5 Other Features.



Def Tank Low Level Indicator

Illuminates when there is less than 2.6 gallons (10 liters) of DEF left in the tank.



CAUTION

If the vehicle is kept in operation with an empty DEF tank, engine derate will eventually occur, limiting the speed to 5 mph.



Charging System Warning Light

Indicates a malfunction of the charging system or a low battery voltage condition.

NOTE

To identify if an alternator is defective (1=lower alternator, 2=upper alternator), perform a system diagnostic using the Driver Information Display DIAGNOSTICS menu. Select VIEW ACTIVE FAULTS and then ELECTRICAL SYSTEM. Scroll through the active faults. The electrical system active faults will appear. A diagnostic message indicating “alternator 1” or “alternator 2” with failure mode “open circuit” will come in sight.



Intake Air Preheater On – Wait Before Starting

Illuminates when the intake air preheater element is in function. Wait until this telltale light has turned off before starting the engine. For more information, refer to ["COLD WEATHER STARTING" on page 6](#) in Section 6 Starting and Stopping Procedures.



Tire Pressure Warning

Note: with optional TPMS.

Turns on to indicate either a low tire pressure or high tire temperature. Refer to ["TIRE PRESSURE MONITORING SYSTEMS \(TPMS\)" on page 57](#) in this section for further details.



Hill Start Assist

Indicates a malfunction of the Hill Start Assist function. This function might not be available.



Antilock Brake System (ABS)

Illuminates when the ABS is not available or when the ABS is malfunctioning. Since the ABS system does not operate at less than 4 mph (7 km/h), the indicator will remain illuminated until the coach reaches that speed. Refer to ["ANTILOCK BRAKING SYSTEM \(ABS\)" on page 27](#) in Section 5 Other Features.



Trailer Antilock Brake System (ABS)

Illuminates when the trailer ABS is not available or when the trailer ABS is malfunctioning.



Esc - Electronic Stability Control

At vehicle ignition, the ESC telltale lamp illuminates for approximately 3 seconds and then turns off. If it remains on steadily (not flashing) after ignition, or if it illuminates steadily while you are driving, the ESC system may not be fully functional or their operation may be completely disabled. If this happens, your vehicle will still have normal service braking and can still be driven, but without the benefits of the ESC system.

Flashes quickly when ESC intervenes to reduce risk of loss of control.



High Beam

Illuminates when the high beams are selected. High and low beams are selected with the multi-function lever. Refer to ["MULTI-FUNCTION LEVER" on page 8](#) in this section.

4-38 Controls and Instruments

STOP, CHECK AND INFORMATION TELLTALE LIGHTS

STOP, CHECK and INFORMATION telltale lights illuminate automatically to draw the attention of the driver and their associated messages are displayed in the DID. More than one message (see “Acknowledging Messages” below) can be active at the same time. A displayed message can be replaced by a new message provided the new message has a higher priority. Only fault codes that have a direct impact on vehicle operation are displayed. All fault codes are stored in the appropriate ECU for access by service technicians.

Stop Telltale Light

In the event of a serious fault, the red STOP telltale light comes on and an audible alarm will sound if the engine is running. An illuminated stop message light indicates a serious problem has been detected, and the driver must respond immediately to the problem.



When illuminating, this telltale light means the vehicle must be safely pulled off the road and stopped. In some instances, the engine must be switched off immediately.



WARNING

Failure to stop and take necessary action when the STOP telltale light is on can result in an automatic engine derate and shutdown.

In some cases preventive action may be taken by the engine ECU to protect the engine. For further details, refer to ["ENGINE PROTECTION SYSTEM" on page 7](#) in Starting and Stopping Procedures.

Check Telltale Light

This telltale light means that a fault or an abnormal operating condition has been detected. The vehicle must be checked at the next stop.



If the CHECK telltale light illuminates, an associated message is displayed in the DID. Always pay attention to the associated messages (see “Acknowledging Messages” below).

Information Telltale Light

The INFO indicator light comes on when there is a new information message or an abnormal status is detected by the electronic control unit. A pictogram or text or both are shown in the DID in addition to the INFO telltale light (see “Acknowledging Messages” below).

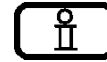

Acknowledging Messages

A fault message associated to a STOP, CHECK or INFORMATION telltale light must be acknowledged by pressing the ESCAPE or ENTER button after which the display returns to the same status that existed before the fault occurred. All messages can be acknowledged. Acknowledgement of pop-up messages and warnings stops the audible warning.

Acknowledged but inactive messages are displayed again when the ignition key is turned to the START position or they can be read in the DID menu. Refer to Other Features for more information on the DID menus.

DRIVER INFORMATION DISPLAY

The DID (Driver Information Display) is located in the center of the instrument cluster. It displays digital gages, main menus and submenus that provide necessary and important information to the driver. The information available to the driver depends on vehicle configuration, and whether the vehicle is in operation or parked. For the list of the available menus and submenus, refer to ["DRIVER INFORMATION DISPLAY \(DID\) MENUS " on page 11](#) in Section 5 Other Features.

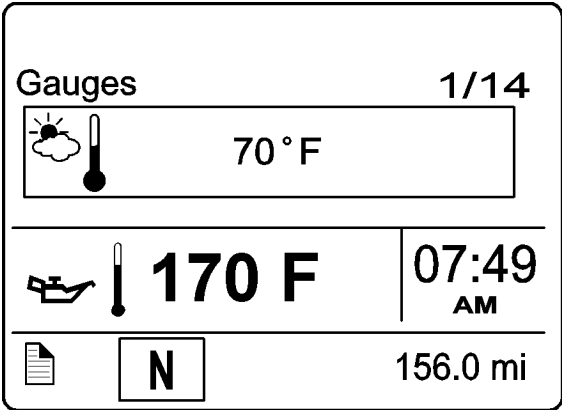

06746

The outside air temperature, fuel flow and the odometer (Allison transmission) or the current gear position (transmission I-Shift) are part of the default display. You can replace the default display by your selection of favorite gages using the Driver Information Display submenu Favorite Display Setting. Refer to ["DRIVER INFORMATION DISPLAY \(DID\) MENUS " on page 11](#) in Section 5 Other Features for more information.

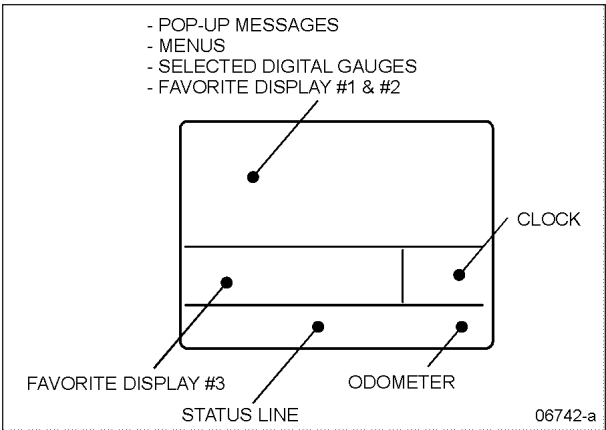

06742-a

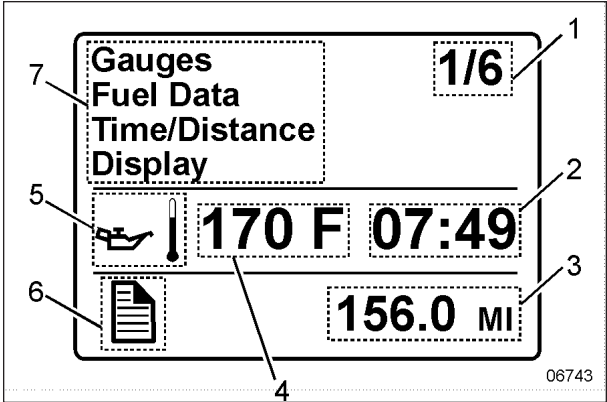

06743

1. Indicates first of six available menus (varies by menu)
2. Clock
3. Odometer
4. Value or data (in this example, the engine oil temperature)
5. Pictogram relevant to the displayed value or data
6. Status bar active pictogram
7. Messages or available menus

Selecting A Menu

Menus are placed in a cascade arrangement. Use the steering wheel controls buttons to scroll through them.

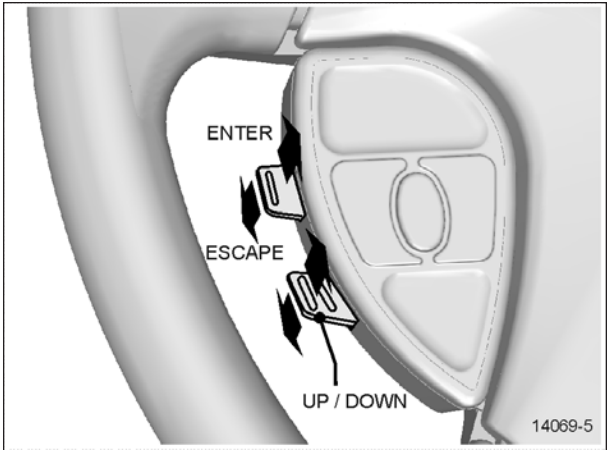

14069-5

To select a menu:

1. Press the ENTER or ESCAPE button to display the list of available menus.

4-40 Controls and Instruments

2. Use the UP/DOWN button to scroll up or down through the menus.
3. Use the ENTER button to open a menu.
4. Use the ESCAPE button to return to the previous menu or display or to cancel a setting or operation.

To Change Settings

To change a setting, like the clock:

1. Use the UP/DOWN button to increase or decrease the numerical value of the selected range.
2. Use the ENTER button to confirm your choice and to move to the next field.
3. Press the ESCAPE button to return to the previous field or to cancel a setting or operation.

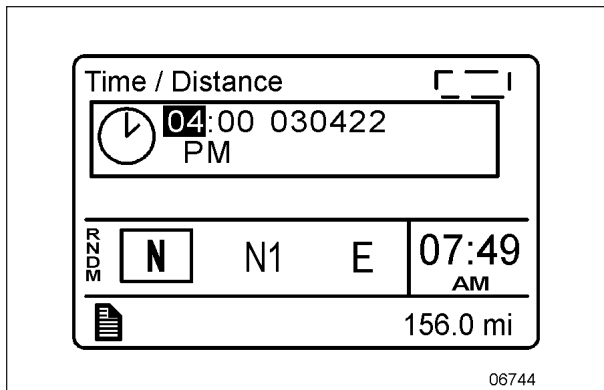

Scrolling Through The Menus Without Using The Steering Wheel Buttons

In case of failure of the steering wheel buttons, it is still possible to gain access to the menus or acknowledge the pop-up messages to return to the default display.

This alternate mode is possible only if the steering wheel buttons are faulty.

To enable the alternate mode:

1. Apply the parking brake;
2. Depress and hold the service brake pedal.

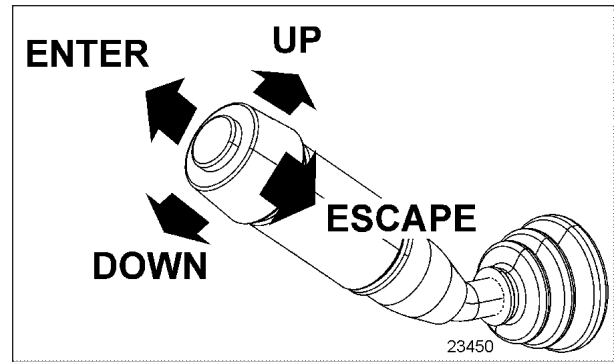

MULTI-FUNCTION LEVER







In alternate mode, use the multi-function lever as follows:

- Move the lever up = UP
- Move the lever down = DOWN
- Push the lever away from you = ENTER
- Pull the lever towards you = ESCAPE

PICTOGRAMS DISPLAYED ON THE DRIVER INFORMATION DISPLAY (DID)

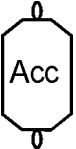
NOTE
In certain situations, the pictogram displayed represents a system or a function of the vehicle. A particular pictogram may be displayed with different messages. In that situation, it is very important to pay attention to the message displayed with the pictogram.









DRIVER INFORMATION DISPLAY “GAUGES” MENU PICTOGRAMS

“GAUGES” MENU PICTOGRAMS	
PICTOGRAM	DESCRIPTION
	Engine oil temperature
	Outside Air Temperature
	A/C Compressor Pressure This pictogram is displayed with A/C compressor suction pressure value (Low Side) and discharge pressure value (High Side).
	Accessories Air Pressure Normal pressure should be between 122 and 140 psi.
	Voltmeter This pictogram is displayed with both the 12-volt and 24-volt electrical system current voltage value. When the engine is running, the 24-volt electrical system voltage value should be between 26,5 and 28,0 volts.
	Transmission Oil Temperature
	Current Gear Position (I-Shift Transmission) Indicate the current transmission gear position on the Volvo I-Shift transmission. R= reverse N = neutral D= drive M= manual mode
	Battery State of Charge This pictogram is displayed with the state of charge (%) of the 12-volt and 24-volt battery banks.

4-42 Controls and Instruments

POP-UP MESSAGES

Acknowledge messages by pressing the escape (ESC) button on the steering wheel. Acknowledgement of pop-up messages and warnings stops the audible warning.

Pop-up Pictograms	
PICTOGRAM	DESCRIPTION
	High Engine Oil Temperature
	Engine Coolant Temperature
CHECK ENGINE COOLANT LEVEL AT NEXT STOP	Low engine coolant level Warns the driver that the engine coolant level has reached the recovery tank low level switch. Add coolant whenever possible.
ENGINE COOLANT LEVEL CRITICALLY LOW	Critically low coolant level Warns the driver that the engine coolant level has reached the surge tank low level switch. Stop and add coolant.
	Engine Oil Pressure
	Engine Temperature Too Low for Volvo Engine Brake (VEB) Operation
	High Transmission Oil Temperature This pictogram indicates that the transmission oil temperature is too high. Turn the transmission retarder off to allow the oil to cool down.
	Allison Transmission– Oil or Filter Replacement Required This pictogram may be displayed with many different messages. Pay attention to the displayed message which can advise that the transmission oil or filter change is necessary. Refer to Appendix C for more information on the Allison transmission prognostic features (oil life monitor, filter life monitor, transmission health monitor).
	Trailer Braking System Low Air Pressure / Trailer Parking Brake This pictogram appears when the trailer emergency/parking brake is unexpectedly applied as when the vehicle is moving and a parking brake air line rupture happens.
	Low Brake Air Pressure The message associated to this pictogram is “Low System Brake Air”. Warns the driver that the brake air system pressure of the primary or/and secondary system has decreased below 85 psig. Do not drive the coach when the brake air pressure is low.

Pop-up Pictograms



TCS traction control system and electronic stability control

At vehicle ignition, the TCS icon appears for approximately 2 seconds and then disappears.

If it remains on steadily (not flashing) after ignition, or if it is on steadily while you are driving, the TCS system may not be fully functional or the operation may be completely disabled. If this happens, your vehicle will still have normal service braking and it still can be driven, although without the benefits of the TCS system.

Flashes slowly when TCS Mud/Snow mode is turned on using the Mud/Snow switch.

Flashes quickly when TCS intervenes to reduce risk of loss of control.



A/C System Pressure High

This pictogram indicates that the A/C system pressure is too high. If the A/C pressure is too high, the compressor clutch is disengaged, but the fan remains activated.

NOTE
<i>When outside temperature is high, it is possible and normal for that pictogram to appear.</i>



A/C System Pressure Low

This pictogram indicates that the A/C system pressure is too low. If the A/C pressure is too low, the compressor clutch disengages and the fan stops.

NOTE
<i>When outside temperature is low, it is possible and normal for that pictogram to appear.</i>



Compressor/air dryer fault

This pictogram indicates that a risk of water in the pneumatic system has been detected due to a compressor or air dryer related problems. Possible causes are:

- Compressor is used at an unusual (high) rate.
- A fault with the air system has been detected.

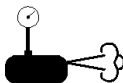

Air leakage

This pictogram indicates that an air leak has been detected in the pneumatic system.

Pop-up Pictograms



Battery Voltage Warning

This pictogram indicates that the battery voltage is too high, too low or the 12 volt / 24-volt battery arrangement is not equalized.

The value LOW or HIGH is displayed at the right of the pictogram to indicate if the voltage is too low or too high.

NOTE

This pictogram will illuminate for a few seconds after the engine is started because of the voltage drop when the starter is engaged.

NOTE

This pictogram may appear as a reminder to connect the battery charger if the ignition switch is left in the "ON" position for twenty minutes with the engine not running and parking brake set.

NOTE

To identify the battery problem (too high, too low or not equalized voltage), using the DID menus, perform a system diagnostic by selecting DIAGNOSTIC, VIEW ACTIVE FAULTS, ELECTRICAL SYSTEM and see the fault messages.

NOTE

To prevent discharge of the batteries when the engine is not running, some functions are automatically switched off if the battery voltage drops below 24.0 volts for more than 30 seconds. Set the ignition key to the OFF position and then turn the ignition key to the ON position to reactivate the functions for a period of 30 seconds before they switch off again.

NOTE

If the battery equalizer indicator illuminates, make sure that the battery equalizer circuit breakers are reset before requesting breakdown assistance. Wait 15 minutes after setting breakers to allow batteries to equalize. The breakers are located in the main power compartment.



Engine Door Ajar

This pictogram indicates that the engine compartment door is ajar.



Emergency window open

This pictogram indicates that an emergency window is open or unlocked.



Baggage Compartment Door Ajar

This pictogram indicates that one or more baggage bay doors are ajar.

Pop-up Pictograms



Low Windshield Washer or Headlights Washer Fluid Level

Illuminates when the windshield washer or the headlight washer fluid level is low. The washer fluid containers are located inside the front service compartment.



WARNING

Do not drive without sufficient washer fluid.



Wheelchair lift

This pictogram indicates that the wheelchair lift system is enabled and the wheelchair access door or the lift compartment door is open. It is necessary to stow the wheelchair lift, close the doors and set the wheelchair lift system enable switch to the OFF position to permit release of the parking brake.



Lavatory Occupied

This pictogram indicates that the lavatory compartment is occupied. This pictogram will appear only when the engine is shut down in order to advise the driver of the presence of a passenger in the lavatory compartment during a stop.



Lavatory compartment emergency call

If the vehicle is moving, this pictogram indicates that a passenger has activated the lavatory compartment emergency call button.



Differential lock (option)

This pictogram indicates that the differential action is locked.



Freezing conditions

This pictogram appears when the temperature is in the range between 0°C and 2°C (32°F et 35°F), when the road is most slippery.



Fuel level

This pictogram appears when approximately 24 US gallons (92 liters) of fuel remains in the tank. Refuel as soon as possible.



Automatic traction control

This pictogram appears when the automatic traction control system intervenes to prevent excess wheel spin during acceleration.



Parking brake applied



DPF regeneration

Pop-up Pictograms



High exhaust gas temperature

This pictogram appears to notify the driver of potentially hazardous exhaust gas temperature at the DPF outlet.



WARNING

During regeneration, exhaust temperature may reach up to 1200°F (650°C) at the particulate filter. When parking the vehicle, if this pictogram is displayed, make sure that the DPF outlet diffuser is away from people or any flammable materials, vapors or structures.



Fuel Economy

This pictogram is displayed with fuel consumption value of the vehicle. Proper units for the displayed value are written under the pictogram: liters/100 km, km/liter, mpg, and liters/hour.



Percentage of Trip Made Using Regenerated Electricity

This pictogram is displayed with the percentage of trip done with electricity produced with engine negative torque (braking, deceleration).



Leg Fuel Consumption

This pictogram is displayed with the value for the fuel consumption for the current leg.



Trip Data

Function of the DID's "Time/Distance" menu. Refer to ["DRIVER INFORMATION DISPLAY \(DID\) MENUS"](#) on page 11 in Section 5 Other Features.



Estimated Time of Arrival

Function of the DID's "Time/Distance" menu. Refer to ["DRIVER INFORMATION DISPLAY \(DID\) MENUS"](#) on page 11 in Section 5 Other Features.



Fuel Filter/Water Separator

Indicates that draining of the fuel filter/water separator is required. See ["PRIMARY FUEL FILTER"](#) on page 13 in Section 8 Care And Maintenance.



Raised tag axle

This pictogram appears if the vehicle speed exceeds 12 mph (20 km/h) while the tag axle is raised.



Cooling fans low voltage

This pictogram indicates that battery voltage is too low for proper fan operation.



Low buoy & Kneeling

This pictogram appears if the vehicle speed exceeds 12 mph (20 km/h) while the front suspension of the vehicle or the entire vehicle suspension is lowered.

Pop-up Pictograms



Fire in engine compartment

This pictogram appears if a fire is detected in the engine compartment while the vehicle is on the road. An audible alarm informs the driver when a fire is detected. In case of fire detection when parked (parking brake applied, engine running or not), the electric horn is activated to alert the driver. Refer to "[AUTOMATIC FIRE SUPPRESSION SYSTEM \(AFSS\)](#)" on page 5 in Section 7 Safety Features and Equipment.



WARNING

In case of a fire, stop the vehicle immediately, stop the engine and evacuate the vehicle.

NOTE

It is possible to cancel an alarm while on the road. To do so, stop the vehicle and perform this ignition switch (key) sequence.

From the ON position, turn to OFF, return to ON and START the vehicle within two seconds.

To stop the electric horn alarm when parked, cycle the ignition between the ON and OFF position twice within 3 seconds.

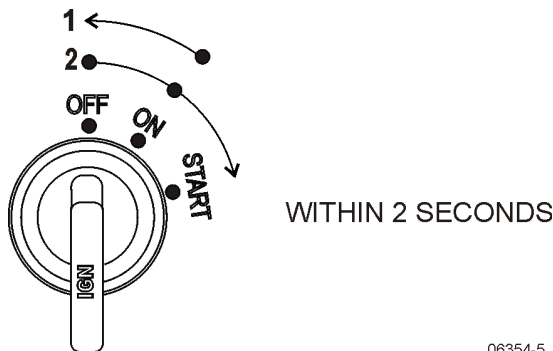

06354-5

NOTE













To stop the electric horn alarm when parked, cycle the ignition between the on and off position twice within 3 seconds.

For the location of the extinguisher, refer to "[FIRE EXTINGUISHERS](#)" on page 4 in Section 7 Safety Features And Equipment.

4-48 Controls and Instruments

STATUS LINE PICTOGRAMS

These pictograms will appear in the status line of the DID.

Status Line Pictograms	
PICTOGRAM	DESCRIPTION
	Message Active
	Alarm Clock Activated
	Raised Tag Axle
	Kneeling/Front Suspension Hi-Buoy Active This pictogram appears if the vehicle speed exceeds 12 mph (20 km/h) while the front suspension of the vehicle (kneeling – solid ON pictogram) or the entire vehicle suspension is lowered (low buoy – blinking pictogram).
	Baggage Compartments Locked Confirms that all the baggage compartment doors are locked.
	Baggage Compartments Unlocked Indicates that at least one baggage compartment door is unlocked.
	Adaptive Cruise Braking (ACB) Not Available Indicates that the Adaptive Cruise Braking system is disabled.
	Engine Brake Engine brake is disabled (OFF mode).
	Engine Brake - Auto Mode Indicates that the engine brake is in the AUTO mode. When using this mode, the engine brake is activated when pressing on the brake pedal. The engine brake is by default set to AUTO mode when the vehicle ignition switch is cycled from OFF to ON position.
	Low Brake Air Pressure Warns the driver that the brake air system pressure of the primary or/and secondary system has decreased below 85 psig. Do not drive the coach when the brake air pressure is low.
	Engine Brake – Engine Brake Low (1) And Engine Brake High (2) Confirms which engine braking power is selected with the steering wheel control buttons.
	Allison Transmission Retarder Confirms that the Allison transmission retarder is off.

Status Line Pictograms

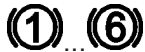

Allison Transmission Retarder – Braking Level 0, 1, 2, 3, 4, 5, 6

Confirms the retarder hand lever position. Each position corresponds to a given braking level. Refer to ["TRANSMISSION RETARDER" on page 11](#) in this section.

TEST

Vehicle Test

Confirms that one of the vehicle test modes is active. For further information about the available test modes, refer to ["DIAGNOSTICS MENU" on page 18](#) in *Section 5 Other Features*.

4-50 Controls and Instruments

BACK-UP CAMERA AND MONITOR

An optional back-up camera is available which provides the driver with visual assistance when backing-up.

The monitor is mounted on the windshield L.H. side pillar and switches ON automatically when the transmission is in the reverse (R) range.

SCENIC VIEWING SYSTEM CAMERA

The optional scenic viewing system enables the passengers to view the road ahead of the vehicle. The camera is mounted above the back-up camera monitor and the system is switched ON using the dashboard mounted FRONT CAMERA/TV switch.

ON BOARD DIAGNOSTIC TOOL RECEPTACLE

To ease troubleshooting, you can connect a diagnostic tool through the OBD receptacle to access recorded data. The OBD receptacle is located under the dashboard, on the left side.

AUTOMATIC FIRE DETECTION AND SUPPRESSION SYSTEM (AFSS)

PROTECTION PANEL

The protection panel displays the current system status. The protection panel contains "SYSTEM OK", fire "ALARM" and "TROUBLE" lamps, the audio alarm, the "TEST/RESET" switch, and the "ALARM SILENCE" switch.

The "SYSTEM OK" lamp indicates power is on the system and that there is no trouble conditions present. The "TROUBLE" lamp blinks if there is a fault in the detection circuitry and illuminates solid if there is a fault in the extinguishing circuitry. When the "TROUBLE" lamp is on, the "SYSTEM OK" lamp will be off and the audible alarm will sound intermittently. The "SYSTEM OK" lamp will flash when the system is low on battery power. Depressing the "TEST/RESET" switch tests the protection panel lamps and audio alarm. The "ALARM SILENCE" switch will disable the audio alarm.

When a fire detector automatically detects a fire, the fire "ALARM" lamp and audio alarm activate. When

the Manual Activation Switch is activated, the fire "ALARM" lamp blinks and the audio alarm activates. The lamp will blink until power is cycled to the system.

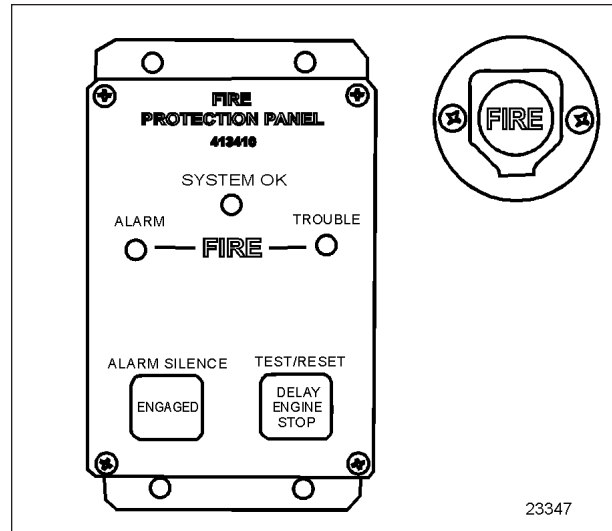

AFSS PROTECTION PANEL & MANUAL ACTIVATION SWITCH

Manual Activation Switch

The manual activation switch allows immediate system activation (extinguisher discharge and engine shutdown) by the driver at any time. Activation of the switch is accomplished by twisting and pulling the tamper seal to remove, lifting the cover and pressing the red "FIRE" button for more than half a second. After the manual activation switch has been activated, the protection panel will blink the fire "ALARM" indicator until power has been cycled to the system.

Refer to ["AUTOMATIC FIRE SUPPRESSION SYSTEM \(AFSS\)" on page 5](#) in *Section 7 Safety Features and Equipment* for more information.

CRUISE CONTROL

The cruise control allows you to cruise the vehicle at a desired speed over 30 mph (50 km/h) without having to use the accelerator pedal.

TURNING THE SYSTEM ON

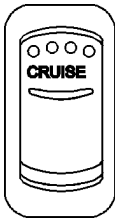

To operate the cruise control, press the CRUISE rocker switch located on the lateral control panel to the ON position. This turns the system on. The dashboard telltale turns on; you can now set the vehicle at a desired cruising speed. To turn off the system, press the rocker switch to the OFF position.

NOTE
The cruise switch and RESUME button do not operate at speeds below 30 mph (50 km/h).

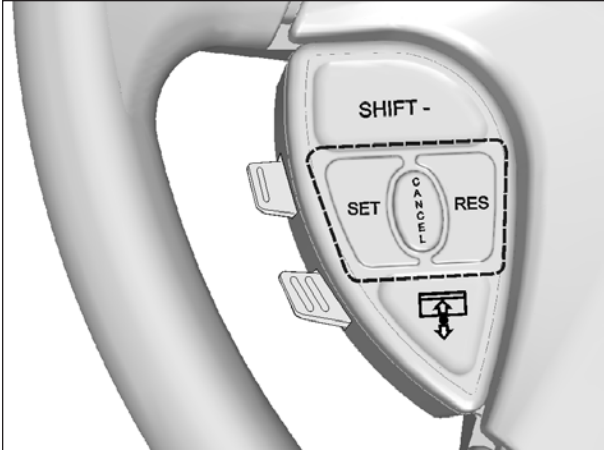

CRUISE CONTROL BUTTONS

SETTING A CRUISING SPEED

Accelerate the vehicle to the desired cruising speed using the accelerator pedal. Press and release the SET button then remove foot from the accelerator pedal. This will set the vehicle cruise speed and store it in memory. The set speed will appear in the driver information display.

Increasing Set Speed

The vehicle cruise speed setting can be increased by one of the following methods.

- 1. Accelerate using the accelerator pedal until the desired cruising speed is reached. Press and release the SET button.

or

- 2. Press and hold the RES (RESUME) button until the desired cruising speed is reached.

When the RES button is released, the new cruising speed will be stored in the cruise control memory.

or

- 3. When driving with cruise control, each time the RES button is momentarily depressed, the cruising set speed is raised by 1 mph (2 km/h).

NOTE
When driving with cruise control, the vehicle can still be accelerated by depressing the accelerator pedal in the usual manner. Once the accelerator pedal is released, the vehicle will return to the previously set cruising speed.

Decreasing Set Speed

The vehicle cruise speed setting can be decreased by one of the following methods.

- 1. Press and hold the SET button until the desired cruising speed is reached. When the SET button is released, the new cruising speed will be stored in the cruise control memory.

or

- 2. Each brief pressing of the SET button will decrease set cruising speed by 1 mph (2 km/h).

or

- 3. Slightly apply the service brake and when desired cruise speed is reached, press and release the SET button.

Canceling The Set Speed

You can cancel the set cruising speed by:

- 1. Pressing momentarily the CANCEL button;
- 2. Depressing the brake pedal.

Automatic Cruise Control Cancellation

The set speed is automatically canceled in any of the following situations:

- The windshield wipers are operating in low or high speed;

4-52 Controls and Instruments

- The actual vehicle speed falls below 30 mph (50 km/h).

Resuming Set Speed

If the set speed is canceled by pressing the CANCEL button or depressing the brake pedal, pressing the RES (RESUME) button will restore the speed set prior to cancellation, providing that your speed is above 30 mph (50 km/h).

NOTE

When driving downhill with the cruise control on and set, the engine brake or the transmission retarder engage automatically (if previously activated) when the selected cruise speed is exceeded by approximately:

- 4 mph (7 km/h) with the engine brake activated;
- 0.6 mph (1 km/h) with the transmission retarder activated.

The engine brake or the transmission retarder is then disengaged when speed has returned near to selected cruise speed.

The engine brake will provide low braking power or high braking power depending on which of the two steering wheel engine brake control buttons is activated;

① = Engine Brake Low

② = Engine Brake High

The transmission retarder maximum braking level is determined by the retarder hand lever position on the steering wheel.

NOTE

To avoid sudden vehicle hesitation, slightly depress the accelerator pedal before disengaging the cruise control.

NOTE

When the CRUISE rocker switch is released, the cruise control is completely shut off and the cruise speed setting is erased from the cruise control memory.

NOTE

If the engine was stopped and the CRUISE rocker switch was in the ON position, the rocker switch must be reset by turning it OFF then ON again in order for the cruise control to be reactivated.



WARNING

Do not use the cruise control when driving speed must be constantly adjusted, such as in heavy traffic or on icy, snow-covered or slippery roads, or on gravel roads.



WARNING

Do not put the transmission in the neutral (N) position while driving with cruise control. This may cause the engine to over-speed and result in a loss of driving control.

PREVOST AWARE • ADAPTIVE CRUISE BRAKING

Prevost AWARE Adaptive Cruise Braking (ACB) is an optional cruise control that not only maintains the set speed, but will also intervene, as needed, to help the driver maintain a set following distance behind the forward vehicle by reducing speed as necessary. As soon as the forward vehicle is at a safe distance, the coach will accelerate back to the cruise set speed.

NOTE

The following paragraphs briefly sum up the information concerning the operation and function of the ACB. Before driving the vehicle, be certain that you have read and that you fully understand each and every step of the driving and handling information found in Bendix Wingman ACB Active Cruise with Braking Operator's Manual. The driver should fully understand all the audible alerts and visual indicators that the system provides. Bendix Wingman ACB Active Cruise with Braking Operator's Manual (available on Prevost web site and included on the Technical Publications CD) will assist in explaining what each of them means and what actions the driver may be required to take to avoid potential collisions.

 **WARNING**

Even with ACB, the driver must remain alert, react appropriately and in a timely manner, and use good driving practices. Ultimate responsibility for the safe operation of the vehicle remains with the driver at all times.

Be certain that you have read all safety warnings found in Bendix Wingman ACB Active Cruise with Braking Operator’s Manual.

The driver will benefit all the audible and visual warnings that the system provides whether or not ACB is turned on. In addition to the audible and visual warnings, when the ACB is turned on and a cruise speed is set, the driver benefits from active interventions like engine throttle reduction, engine brake application and service brake application to help maintain a set following distance.

 **WARNING**

Adaptive Cruise Braking must be used only in the same conditions that are normally recommended for ordinary cruise control. Refer to “Regular Cruise Control” paragraph.

TURNING THE ACB SYSTEM ON

Activation of the adaptive cruise braking is similar to the regular cruise control activation. Press the CRUISE rocker switch to the ON position, accelerate the vehicle to the desired cruising speed and then, press the SET button. ACB is now engaged with the set following distance and driver warning features. Whenever the cruise control is engaged, the ACB is also engaged. You cannot use the cruise control without the ACB features.

TURNING OFF THE ACB SYSTEM

You can turn off the ACB system, simply by applying service brakes, setting the CRUISE rocker switch to the OFF position or pressing the cruise control CANCEL button on the steering wheel.

NOTE

Whenever the service brakes are applied by intervention of the ACB or by the driver, normal cruise will automatically be canceled. The driver must resume or set the cruise mode in order for the vehicle to throttle up.

MAINTAINING A SET FOLLOWING DISTANCE

Using a radar sensor mounted to the front bumper, the ACB system measures the distance between the coach and the forward vehicle and intervenes to help maintain a safe set following distance behind the vehicle. This feature engages automatically once the driver turns on and sets cruise speed.

Following distance refers to the time gap, measured in seconds, between the coach and the vehicle ahead. The actual physical distance between the coach and the vehicle ahead will vary based on your set cruise speed; although the set time gap remains the same for all set cruise speeds. Prevost’s default set time gap is 1.7 seconds.

With cruise control engaged and a cruise speed set, you are maintaining a set following distance between the coach and the forward vehicle:

- If the vehicle in front of the coach slows down below your cruise control set speed, the system will progressively intervene as follows, in this order:
 1. Reduce the engine throttle;
 2. Apply the engine brake;
 3. Apply about 30% of the service brakes available braking power in an attempt to maintain the set following distance.

The driver must apply additional braking power when required, to avoid collision or to maintain a safe distance from the vehicle ahead.

NOTE

If the ACB is actively decelerating or braking the coach in an attempt to maintain the set following distance at the moment when the driver cancels the ACB system, the ACB system will continue deceleration or braking intervention until a safe following distance is established, then will cancel.

Even though the cruise control doesn’t operate at speeds below 30 mph (50 km/h), the ACB system will continue deceleration or braking intervention in an attempt to maintain the set following distance if the coach speed reduces to less than 30 mph (50 km/h).

- If the vehicle ahead slows below your cruise control’s set speed, but then accelerates away, and the ACB system did not need to use the service brakes as it managed the

4-54 Controls and Instruments

intervention, the coach will automatically accelerate back to the original cruise control set speed, and again maintain a set following distance behind the forward vehicle.

NOTE

The maximum radar range is approximately 500 feet (150 meters). Rain, snow, fog, ice and other severe weather conditions may affect the performance of the ACB system and shorten radar range.

NOTE

As part of your pre-trip vehicle inspection, check to see that there is no mud, snow, ice build-up or other obstruction in front of the radar sensor. You should inspect the radar sensor mounting and remove any obstruction that may impair the sensor functioning.

DRIVER WARNINGS

Before using the ACB, the driver should fully understand all the audible and visual warnings that the system provides. Any audible warning (beeping or tone) means that your vehicle is too close from the vehicle ahead.

DASHBOARD TELLTALE

When ACB is turned on and a cruise speed is set, if the forward vehicle is detected (in range) by the radar, the FORWARD VEHICLE DETECTED telltale light on the dashboard will illuminate. This is an indication to the driver that the forward vehicle is being tracked, that the ACB is actively managing the distance between the coach and the vehicle ahead and that the ACB system may automatically intervene to maintain the set following distance.



FORWARD VEHICLE DETECTED telltale light

There are three types of warnings with this telltale light:

- Green: The forward vehicle is detected (in range).
- Flashing red: Collision alert. The forward vehicle is too close to follow safely or a metallic stationary object such as a stopped or stalled vehicle in your lane of travel is

detected. The driver must intervene to avoid a collision.

- Solid red: ACB system malfunction. The ACB system and the alert functions are not available.

SPEEDOMETER LED

With the cruise control engaged and a cruise speed set, a green LED illuminates above the cruise control set speed on the speedometer.

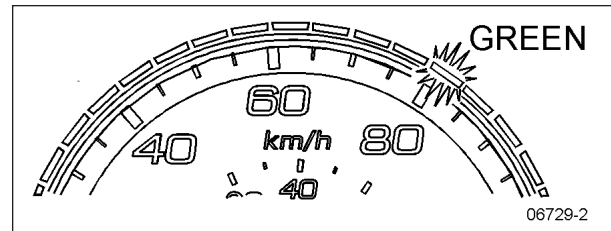

THE CRUISE SET SPEED IS 80 KM/H

With a cruise speed set, the vehicle ahead slows moderately. The system will display to the driver the approximate speed of the vehicle ahead with yellow LEDs above the speedometer.

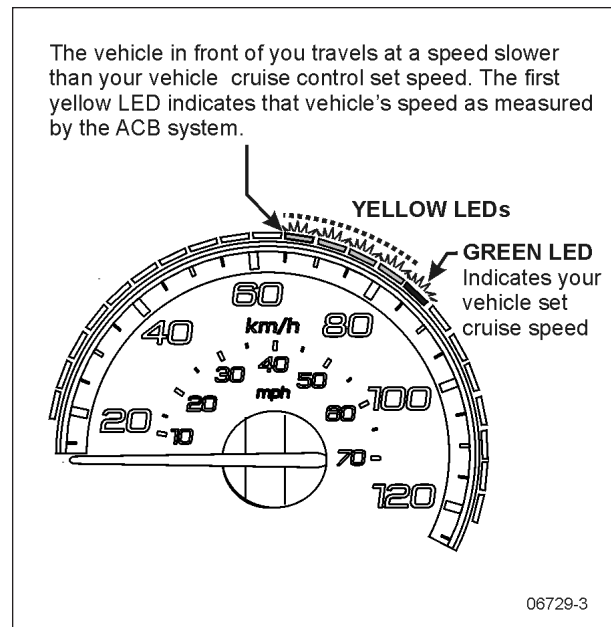

EXAMPLE OF THE SPEEDOMETER LED DISPLAY WHEN THE FORWARD VEHICLE IS SLOWER WHILE THE COACH TRAVELS WITH THE ACB CRUISE CONTROL ON AND SET

FOLLOWING DISTANCE ALERT (FDA)

Following Distance Alert provides both audible and visual warnings whenever the distance between the

coach and the forward vehicle is less than the set distance and getting closer. Once the audible warning is given, the driver must increase the distance between the coach and the vehicle ahead until the audible warning stops or maneuver clear of the forward vehicle.

 WARNING
Following Distance Alert is always active whenever the coach is moving to a speed greater than 37 mph (60 km/h), whether or not ACB is turned on. Active interventions of ACB to maintain safe following distance (throttle reduction, engine brake application, service brakes application) are only operational when the ACB is engaged with a cruise speed set.

the use of ACB on downhill runs may cause this alert to be activated. It is recommended that ACB be disengaged on downhill grades. The driver should use appropriate gearing and brake techniques, and not rely on ACB, on downhill grades.

If the driver does not respond to the Brake Overuse Warning after a brief delay, the ACB will switch off.

IMPACT ALERT

The Impact Alert warning is the most severe warning issued by the ACB system. This alert indicates that the driver must take immediate evasive action by applying more braking power and/or steering clear of the vehicle ahead to avoid a potential collision.

The Impact Alert is also applicable to stationary metallic objects, such as stalled vehicles. This alert provides a warning given up to 3.0 seconds before a potential collision with a stationary metallic object in the coach’s lane of travel. The driver can either slow down or maneuver in an attempt to avoid the object. The Impact Alert will only warn and will not actively decelerate or brake the coach when approaching stationary objects.



 WARNING
Impact Alerts are always operational when the vehicle is running whether or not ACB is turned on. Active interventions of ACB to maintain safe following distance (throttle reduction, engine brake application, service brake application) are only operational when the ACB is engaged with a cruise speed set.

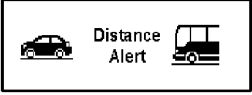
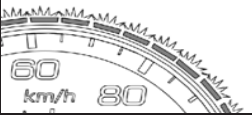
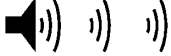

BRAKE OVERUSE WARNING

ACB provides a warning when the system is intervening and using the service brakes excessively. Overuse of the foundation brakes can lead to the brakes overheating and a potential loss of braking performance from brake fade. For example,

4-56 Controls and Instruments

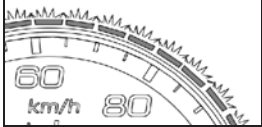
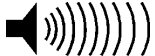
FOLLOWING DISTANCE ALERT	
CONDITION	The Following Distance Alert feature is only available when the coach speed is greater than 37 mph (60 km/h), whether or not ACB is engaged.
	The forward vehicle is slowing down and the distance between your vehicle the coach and the forward vehicle is less than the set distance.
ACTIONS BY ACB SYSTEM	<p>“Distance Alert” pop-up message appears on the DID</p>  <p>The speedometer LEDs illuminate in red</p>  <p>If the vehicles remain too close from each other for more than 15 seconds, an audible warning will sound (beeping)</p> 

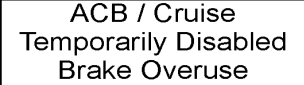
IMPACT ALERT	
SITUATION	ACB system detects a risk of collision with a forward-moving vehicle or a stationary metallic object in your lane of travel.
ACTIONS BY ACB SYSTEM	<p>On the dashboard, the Forward Vehicle Detected telltale flashes in red</p>  <p>“Impact Alert” pop-up message appears on the DID</p>  <p>The speedometer LEDs flash in red</p>  <p>An audible warning will sound (continuous modulating tone)</p> 

BRAKE OVERUSE WARNING	
SITUATION	ACB system is using the service brakes excessively to maintain the set following distance (for example, the use of ACB on long, steep downhill runs). Excessive application of the service brakes can cause the brakes to overheat resulting in increasing stopping distances.
ACTIONS BY ACB SYSTEM	<p>After a brief delay, the ACB system will stop functioning and be disabled.</p> <p>On the dashboard, the Forward Vehicle Detected telltale illuminates in red</p>  <p>“ACB/Cruise Temporarily Disabled Brake Overuse” pop-up message appears on the DID</p>  <p>“ACB Not Available” pictogram appears on the DID status line</p> 

SELF-DIAGNOSTIC AT START-UP

Initiate the self-diagnostic as follows:

- The engine must be running since at least 15 seconds with the parking brake applied.
- Trip the CRUISE rocker switch located on the lateral control panel from OFF to ON position.

The following sequence will begin:

1. Pop-up message “Impact Alert” will show in the DID;
2. The speedometer LEDs will flash in red;
3. FORWARD VEHICLE DETECTED telltale will flash in red;
4. The Impact Alert audible alarm will sound.

At the end of the self-diagnostic sequence, pop-up message « ACB SELF-CHECK OK » will show on the DID if the system functions properly or « ACB SELF-CHECK NOT OK » if a fault condition is detected.

ACB Self Check NOT OK	ACB Self Check OK
-----------------------------	-------------------------

SYSTEM MALFUNCTION

In case of system malfunction, visual warnings will illuminate in the instrument cluster or the driver information display to warn the driver that the ACB is disabled. In that situation, the Impact Alert and Distance Alert functions are not available.

If the ACB is not available, the FORWARD VEHICLE DETECTED telltale light will illuminate in red and will stay on and “ACB NOT AVAILABLE” pictogram will appear on the DID status line.



FORWARD VEHICLE DETECTED telltale light



ACB NOT AVAILABLE pictogram

For proper functioning of the system, the radar must be perfectly aligned and not blocked. If a radar fault

condition is detected, one of the following pop-up messages will show in the DID.

- ACB RADAR MISALIGNMENT
- ACB RADAR FAULT
- ACB RADAR DATA LINK FAILURE
- ACB RADAR BLOCKED

TIRE PRESSURE MONITORING SYSTEMS (TPMS)

Two versions of tire pressure monitoring system are available in option, TPMS-Lite and the On-Screen TPMS

SYSTEM MALFUNCTION

In case of system malfunction, the following warning pop-up message will show on the DID to warn the driver that the TPMS might be disabled or unreliable. Refer to Appendix D TPMS Troubleshooting Guide for further details.

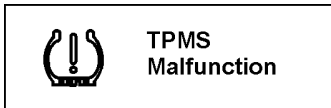

TPMS-LITE VERSION

TPMS-Lite provides the safety and convenience of a TPMS in a discreet way. Low pressure and high temperature warning thresholds are factory set. This system has no dedicated display.

Instrument Cluster Alarms And Warnings

Visual and audible warnings turn on to indicate either a low tire pressure or high tire temperature through three different warning conditions:

1- LOW TIRE PRESSURE WARNING



Indicates that tire pressure has reached a critical threshold. This alarm will trigger if a tire pressure falls below 40 psig. **Stop the vehicle as soon as possible.**

2- HIGH TIRE TEMPERATURE WARNING

4-58 Controls and Instruments

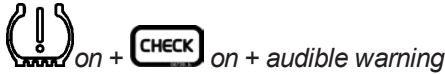

on + **CHECK** on + audible warning

A high temperature warning will trigger if a tire temperature rises above 194°F (90°C). **You should stop the vehicle as soon as possible and check your tires.**

3- HIGH TEMPERATURE ALARM

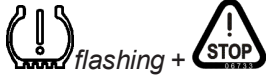

flashing + **STOP** on + audible alarm

Indicates a critically high tire temperature. A high temperature alarm will trigger if a tire temperature rises above 212°F (100°C). **Stop the vehicle as soon as possible.**

ON-SCREEN TPMS VERSION

This system is a sensing device designed to identify and display tire operating data and activate an alert or warning when pressure or temperature irregularities are detected.

NOTE

It is the responsibility of the driver to react promptly and with discretion to alerts and warnings. Abnormal tire inflation pressures should be corrected at the earliest opportunity.

Instrument Cluster Alarms And Warnings

Visual and audible warnings turn on to indicate either a low tire pressure or high tire temperature through two different warning conditions:

1- LOW TIRE PRESSURE WARNING



on + **CHECK** on + audible warning

Indicates a low tire pressure. Refer to the dedicated display to determine whether the warning condition is critical or not.

2- HIGH TIRE TEMPERATURE WARNING



flashing + **CHECK** on + audible warning

A high temperature warning will trigger if a tire temperature rises above 194°F (90°C). **You should stop the vehicle as soon as possible and check your tires.**

Dedicated Display

The TPMS display knows where the sensors are located. It receives the raw temperature and pressure readings from the TPMS receiver, it reads several signals from the vehicle and does the calculation required to generate the various screens.

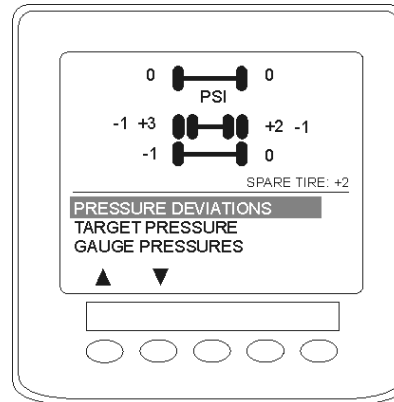

ON-SCREEN TPMS DEDICATED DISPLAY

When no readings have been received for a tire location or when the received data correspond to a parameter range defined as unavailable, then the reading is considered as not available and appears as two dash lines “_ _”.

The TPMS display is initially configured to define how many axles and running tires are present on the vehicle. For current Prevost vehicle models, there are two axles / tire configurations. These configurations are:

CONFIGURATION 1: Axle 1 (Front) Two tires, Axle 2 (Drive) 4 tires, Axle 3 (Tag) 2 tires.

CONFIGURATION 2: Axle 1 (Front) Two tires, Axle 2 (Drive) 2 tires (super Singles), Axle 3 (Tag) 2 tires.

The TPMS display is also configured with several other parameters, including threshold levels for the alarms.

The TPMS display turns OFF when the ignition key is switched OFF.

Operation

The system will monitor all vehicle tires (6 or 8) plus the spare tire when a spare is supplied.

NOTE

Some vehicle models do not come with a spare tire.

There are two configurations of vehicle tires to be supported. One configuration (the most common) consists of 8 tires total: two tires on the front axle, 4 tires on the drive axle and 2 tires on tag axle. All screen figures shown in this document relates to this vehicle configuration. The second tire configuration consist of 6 tires total: 2 tires on the front axle, 2 tires on the drive axle (super single tires) and 2 tires on the tag axle. The vehicle tire configuration is selected with a parameter (Refer to ["TIRE PRESSURE MONITORING SYSTEM" on page 6](#) in Section 7 Safety Features and Equipment for more information). When the display is configured for 6 tires, the drive axle tires appears as one large tire on both side instead of twin tires as illustrated in this document and there is one reading appearing on each side instead of two as illustrated in this document.

Start-up

When the ignition switch is turned to ON, the following screen appears on the TPMS Display. Dash lines are displayed meaning that no pressure data have been received by the display.

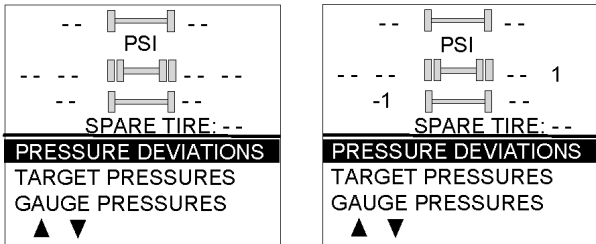

23455

As illustrated, the pressure readings will appear replacing the dash lines as the TPMS display starts to receive pressure data from the TPMS receiver. It can take 1 minute to get all pressure readings updated since the sensors transmit at a one-minute interval. The user can flip through the menus.

Pre-Trip Check

When one of the preconditions defined to start the pre-trip check is met, the TPM display enters into a pre-trip check routine and the screen shown below appears. The preconditions to initiate the pre-trip are: Park brake removed Or No activity on the display menu keys for a defined time (Key pressed timeout). After a pre-trip, the display is in a "drive" mode with bottom menu replaced by the alarm status. The display remains in this mode until one of the following occurs: A menu key is touched while the park brake is applied, or the park brake does a transition from released to park brake applied.

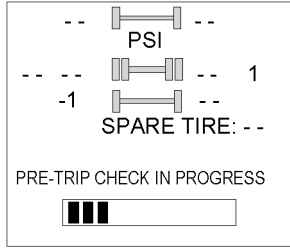

23456

During the pre-trip check, the pressure readings for the different wheels become all available.

The pre-trip check ends, either when: the pressure readings have been received for all running wheels or the pre-trip check maximum time has elapsed. It was selected to provide sufficient time for all wheel sensors to wake-up and send a first reading.

The pre-trip check is aborted and the bottom menu reappears if the park brake was active and the user press one of the menu keys.

Upon completion of the pre-trip check, the TPMS display will come up with one of the following screens:

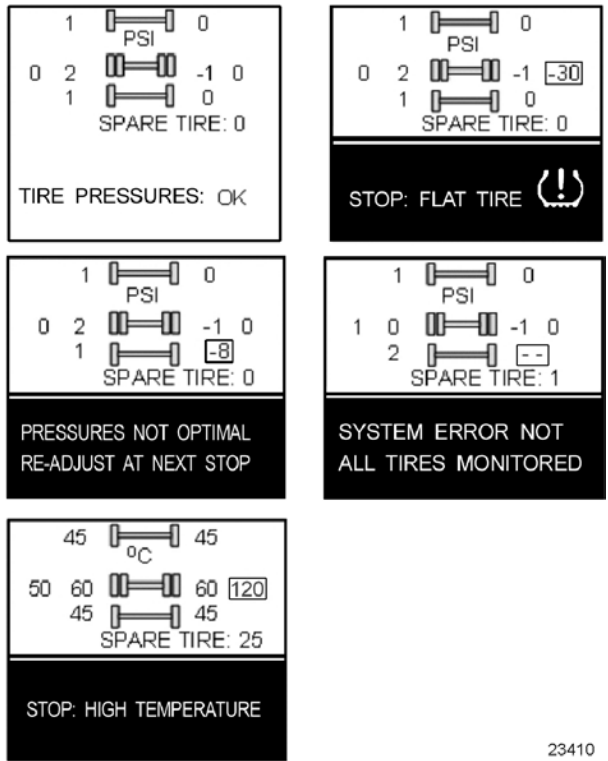

23410

A rectangle around each pressure and temperature reading of the tires that have an issue is blinking to draw the attention to the defective tires.

In the case of multiple errors at the same time, the highest priority error is displayed at the bottom. "Flat Tire" has the highest priority followed by "High

4-60 Controls and Instruments

Temperature”, “Not all tires monitored” and “Tire pressure not Optimal”.

To get the driver’s attention to the alarms, the bottom section of the screen where the alarm message appears will blink to reverse contrast. Pressing any key will acknowledge the alarms that are considered as non-critical and stop the blinking of these alarms message for the remaining of the trip. The non-critical alarms are: “Pressure not optimal” and “Not all tires monitored”. The “flat tires” and “high temperature” alarms are critical and will keep blinking even when a key is pressed. If a different alarm occurs, blinking will start again. The blinking rectangle around the pressure/temperature readings is not impacted by the acknowledgement and keeps blinking until the error condition disappears.

The spare tire does not contribute to alarms and so never blinks.

On the road, the TPMS display shows one of the 5 previous screens.

In the event of a temperature alarm, the display switches automatically to temperature readings.

The driver can also press any of the menu keys to momentary switch the display to temperature readings. In this case, the temperature reading appears for 15 seconds and the display returns to pressure.

The switching to temperature by pressing a key does not take place if there is an acknowledgeable alarm active, since in this case pressing the key does acknowledge the alarm.

The switching to temperature does not take place either if there is an alarm of Temperature or Flat Tire.

The switching to temperature works when the bottom message indicates either: Tire Pressure OK, Pressure Not Optimal non flashing or not all tires monitored non flashing. When the switch is done to temperature readings, the bottom portion of the screen is not affected and still shows the status message.

NOTE

<i>High temperature is not likely to occur during the pre-trip.</i>

The pressure and temperature readings are continuously updated with the displayed readings of the wheel having issues blinking. The bottom line message is automatically updated to the highest priority alarm prevailing.

On the occurrence of an alarm, a beep will sound. The alarm beep could be turned OFF in the alarm settings menu.

Spare Tire

The spare tire is monitored but it is not taken into account when setting the bottom alarm messages. This is to prevent unnecessary alarms that would otherwise occur, if for example, the spare tire is removed from a vehicle.

The user will have the possibility to check the pressure of the spare tire by accessing the TPMS display menu. For vehicles that have no spare tires, the title “spare tire” will still appear on the screens but the pressure will remain with two dash lines at all time.

Post Trip Operation

When parking the vehicle (park brake applied), the TPMS display keep the drive mode display active. The driver can press any keys to get the bottom lines showing the status information replaced with the menus.

The pressure readings are still displayed and updated as new readings are received and the readings are blinking if not within the optimum pressure range.

From this point the user can scroll through the menus to get more detailed information and inflate or deflate the tires to bring them back to their optimum target pressures. Scrolling through these menus is also available prior to departure.

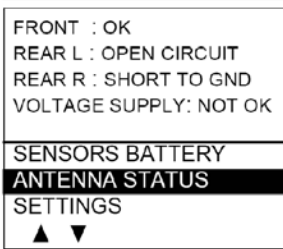
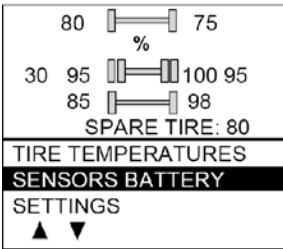
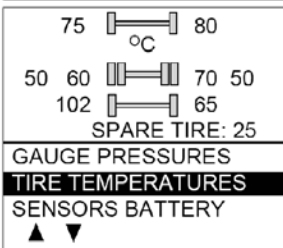
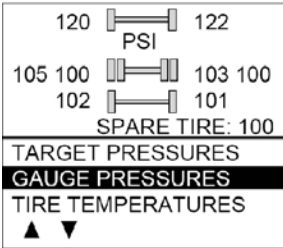
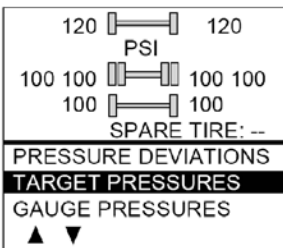
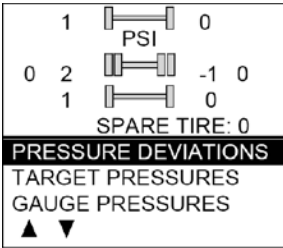

23411

The display remains in this mode with the menus appearing at the bottom until the pre-trip check sequence starts again.

Scrolling down below the Battery life menu will show the Settings menu. Highlighting the Settings and pressing OK allows entering the settings menu. Refer to *"Setting The On-Screen TPMS" on page 7* in Section 7 Safety Features and Equipment for more information.

Highlighting the Exit menu and pressing OK exits the settings and come back to the pressure display mode.

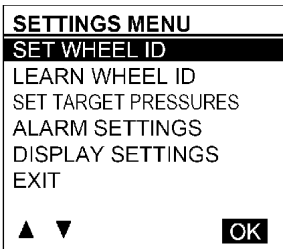
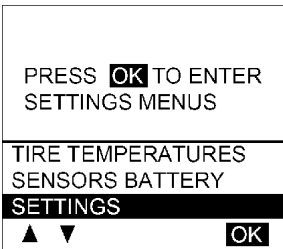

23411-2

ALLISON TRANSMISSION

The transmission is fully automatic: Proper ranges should be automatically selected according to driving speeds to improve vehicle performance and control. The speed ratio of the power converter changes

automatically as vehicle speed increases and direct-drive goes in and out as necessary. The speed ratio is modulated by vehicle speed and accelerator pedal position. You will find the complete transmission operation instructions and driving tips in the [Allison 5th Generation Bus Series Operator's Manual](#) available on the Prevost Technical Publication web site.

OPERATION

When a button is depressed on the transmission control pad, the corresponding letter or number is displayed indicating the transmission is ready to operate in the selected range. If the transmission control module (TCM) detects a serious problem in the transmission, the CHECK telltale lights on the dashboard.

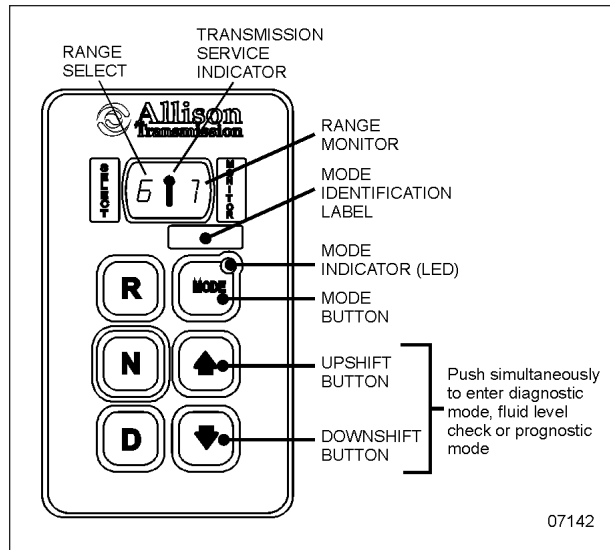

ALLISON PUSHBUTTON SHIFT SELECTOR

PUSHBUTTON SHIFT SELECTOR

The pushbutton shift selector has the following elements:

R: Press to select Reverse gear.

N: Press to select Neutral.

D: Press to select Drive. The highest forward range available will appear in the digital display window under SELECT. The transmission will start out in the lowest available forward range, displayed under MONITOR, and advance automatically to the highest range.

4-62 Controls and Instruments

↑ ↓ : Press respectively the ↑ (Upshift) or ↓ (Downshift) arrow button when in DRIVE to request the next higher or lower range. One press changes gears by one range. If the button is held down, the selection will scroll up or down until the button is released or until the highest or lowest possible range is selected. Protection mechanisms inhibit selecting ranges that are not appropriate for the current speed or which may damage driveline components.

MODE: Pressing the MODE button allows the driver to activate the secondary shift schedule that has been programmed into the TCM unit.

PRIMARY AND SECONDARY SHIFT SCHEDULES

The primary shift schedule is the default mode at starting of the engine and is typically specified to accommodate normal vehicle operation. The transmission controller automatically selects between ECONOMY and PERFORMANCE shift strategy, based on the vehicle actual load and the grade on which the vehicle is operating. This is called Load Based Shift Scheduling (LBSS). This can produce improved overall vehicle fuel economy while still enabling high productivity when the vehicle is loaded.

In the secondary shift schedule, only the ECONOMY shift strategy is available. No switching is done between shift strategies. The secondary shift mode is available only if selected by the driver, using the MODE button. When the secondary mode is activated, "MODE" illuminates on the display.

NOTE

When the diagnostic display mode has been entered, the MODE button is used to view and toggle through diagnostic code information. Refer to appendix C for more details about diagnostic code display procedure and fluid level check using the pushbutton shift selector.

TRANSMISSION SERVICE INDICATOR

ⓘ: This indicator will be illuminated upon the detection of a service issue relating to clutch, filter or fluid life. The appearance of the indicator (lit steadily, flashing, etc.) varies for each of the conditions monitored by the system. Refer to appendix C for more details about diagnostic code display procedure, fluid level check or prognostic features

(Oil Life Monitor, Filter Life Monitor and Transmission Health Monitor) using the pushbutton shift selector.

Illuminated at startup for a bulb check, this indicator will then be turned off if no service conditions exist.

DESCRIPTION OF AVAILABLE RANGES

R (Reverse)

Press the «R» button to select reverse. Completely stop the vehicle and let the engine return idle before shifting from forward range «D» to reverse «R» or from reverse to forward range. The reverse warning signal will be activated when this range is selected.

N (Neutral)

Use this position to start the engine. Select «N» (Neutral) when checking vehicle accessories and for extended periods of engine idle operation; parking brake must then be applied. The pushbutton shift selector automatically select «N» (Neutral) when the ignition switch is turned On.

NOTE

The automatic transmission does not have a park «P» position. Select «N» (Neutral) and apply parking brake when the vehicle is left unattended. An audible alert will sound if the engine is stopped and the parking brake is not applied.



WARNING

Before leaving driver's seat, always put the transmission in NEUTRAL and apply parking brake.



WARNING

The vehicle service brakes or park brake must be applied whenever NEUTRAL is selected to prevent unexpected vehicle movement.



CAUTION

Diesel engines should not be idled for extended periods at "slow" idle. For extended idling, engine should run at "fast" idle.

 **CAUTION**

Do not allow your vehicle to "coast" in neutral «N». This practice can result in transmission damage. Also, no engine braking is available in neutral.

D (Drive)

Use this position for all normal driving conditions. After touching this pad, the vehicle will start in first or second range and will automatically upshift to a higher range as output speed increases. As the vehicle slows down, output speed decreases, the transmission automatically downshifts to the correct range. If a locked brake or a slick surface condition should occur, the TCM (Transmission Control Module) will command converter operation (disconnect lockup) and inhibit downshift for a period of time or until normal wheel speed has been restored.

NOTE

IMPORTANT: Brake pedal must be applied when selecting «D» (Drive) otherwise the transmission will stay in «N» (Neutral).

NOTE

The transmission should normally be allowed to shift by itself, but manual shifting can be done as described below.

1 (First Range)

Select this range when pulling through mud and snow, when speed control is needed for driving up or down steep grades or when maneuvering in tight spaces. This range also provides maximum driving torque and engine braking power or retarder braking effect. In the lower ranges (1, 2, 3 and 4), the transmission will not upshift above the highest gear selected unless engine overspeed is detected.

2 (Second Range)

Select this range when operating in heavy and congested traffic. The transmission will start in first and automatically upshift to second. When slowing, the transmission will automatically downshift to first range. Low ranges provide progressively greater engine and retarder braking power (the lower the range, the greater the engine and retarder braking effect).

3, 4 (Third And Fourth Ranges)

Select these ranges when driving on moderate grades or when load and traffic conditions limit speed.

 **WARNING**

Service brake should not be used to control the speed of the vehicle on long, steep descents. Instead, lower transmission ranges should be used in conjunction with the output retarder. Refer to "[ENGINE BRAKE](#)" on [page 25](#) and "[TRANSMISSION RETARDER](#)" on [page 25](#) in Section 5 Other Features for details regarding both systems. This procedure keeps service brake cool and ready for emergency stopping.

 **CAUTION**

When descending in lower ranges, care must be taken that engine speed does not exceed 2,450 rpm.

4-64 Controls and Instruments

VOLVO I-SHIFT TRANSMISSION

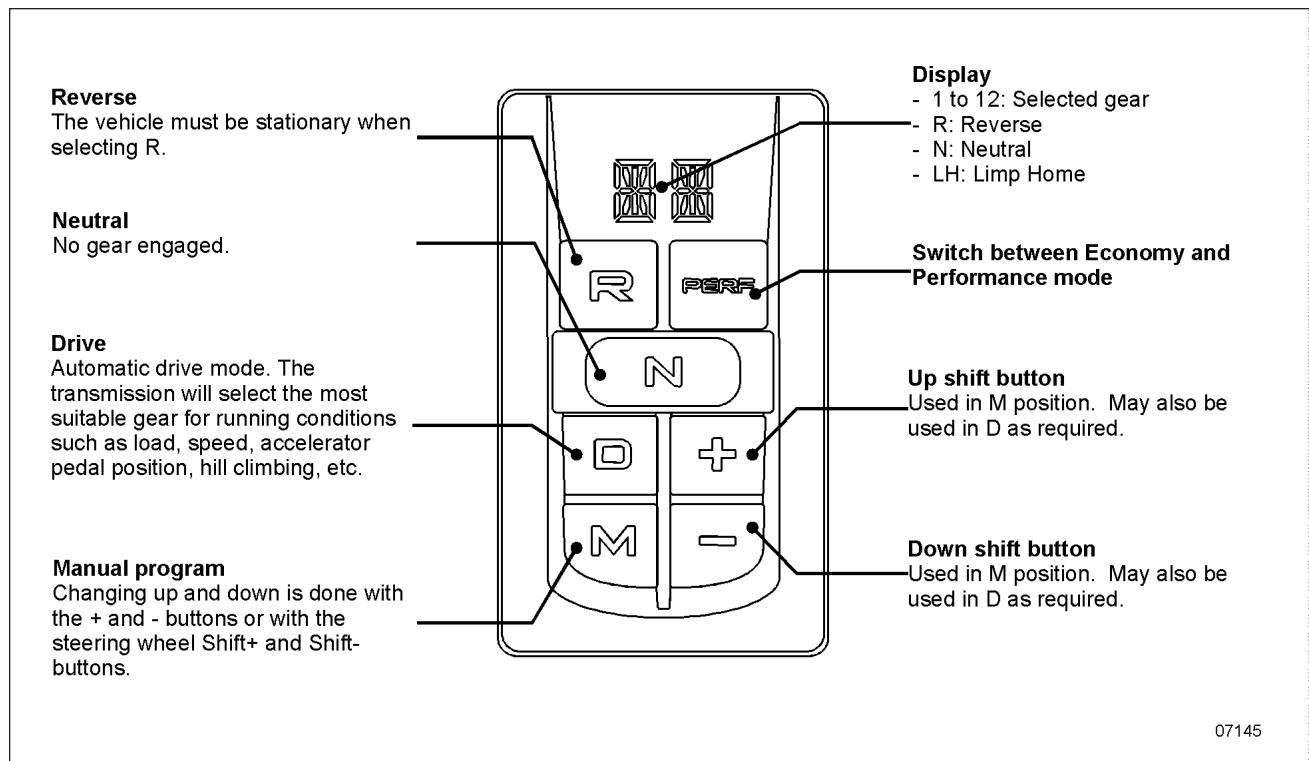

I-SHIFT PUSHBUTTON SELECTOR

The I-Shift transmission is an automated gearbox with 12 forward gears and 2 reverse gears. The clutch operation and gear shifting are fully automatic so that the driver can concentrate on the traffic.

PUSHBUTTON SHIFT SELECTOR

The pushbutton shift selector has four gear positions: R, N, D and M.

- R= Reverse
- N= Neutral
- D= Drive
- M= Manual program

It is not possible to shift either directly from R position to D or M position nor from D or M position to R position. N position must be selected first. If the driver executes such gear shifts, the transmission will shift automatically to N position.

R ⇔ N ⇔ D or M

DISPLAY

Status of the I-Shift transmission is shown on the Driver Information Display (DID). Displayed information is position, selected gear and driving mode.

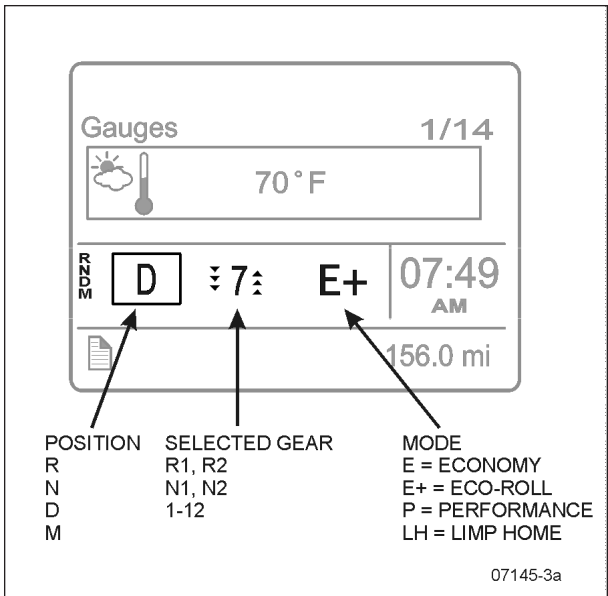

I-SHIFT PUSH BUTTON SELECTOR

ACCELERATOR PEDAL

When changing gear, the accelerator pedal should not be released. The system will govern the clutch, gearbox and engine speed. The system selects the gear and the point in time for gear changing for optimum driving performance based on the accelerator pedal position, road inclination, etc.

ECONOMY AND PERFORMANCE MODE

When the engine is started, the transmission is in Economy mode. The transmission automatically selects shift points and engine parameters to maximize fuel economy. Economy mode is primarily used when driving under normal conditions.

The Performance mode gives driveability the highest priority for optimum driving in traffic condition and gradeability.

NOTE
Operating the vehicle in Performance mode for extended periods can result in a loss of fuel economy.

ECO-ROLL MODE (FREEWHEEL FUNCTION)

Eco-Roll reduces fuel consumption by automatically disengaging the driveline when the engine is not needed to maintain vehicle speed. When Eco-Roll is active, the engine speed is temporarily reduced to idle. Eco-Roll can be used during normal driving with the accelerator pedal or while in cruise control mode.

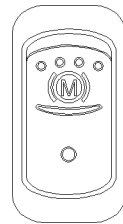

Eco-Roll is only available when the engine brake is in Auto mode (A). First, set the dashboard Engine Brake switch to the ON position.

When Eco-Roll is enabled, the DID shows E+. When Eco-Roll intervenes, the selected gear displayed in the DID (7–12) will change momentarily to N1 or N2.

Eco-Roll disengages as soon as the brake pedal or the accelerator pedal is depressed, but it remains available. To disable Eco-Roll, set the dashboard Engine Brake switch to the OFF position. Eco-Roll is not available when the Engine Brake Low (1) or Engine Brake High (2) modes are selected.

When Eco-Roll is enabled, it activates automatically, but only when the following conditions exist:

- Accelerator pedal is released.
- Service brake is released.
- Engine brake is in Auto mode (A).

4-66 Controls and Instruments

- Transmission pushbutton shift selector is in the D position
- Transmission is operating in the Economy mode.
- Vehicle is operating on a downhill or uphill grade not greater than 2%.
- Selected gear is greater than 6.
- Brake cruise set speed is greater than 3 mph (5 km/h) above cruise set-speed.
- Vehicle speed is less than 78 mph (125 km/h).
- Electronic Stability Control (ESC) and antilock brake system (ABS) are not active.
- Exhaust Aftertreatment System regeneration is not active.

LIMP HOME MODE

Limp home is an emergency mode that can be engaged if a fault has occurred in the gearbox that prevents the vehicle from being driven in automatic, manual or reverse modes.

NOTE

Limp Home mode should only be used for moving short distances.

To Activate The Limp Home Mode

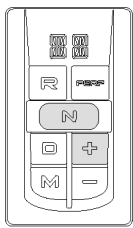

- Simultaneously press **N** and **+** buttons. Activating can only be done while the vehicle is stationary.
- Select **M** position or **R** position as required.

The driver can select gears for forward driving or for reversing using the **+** and **-** button when position **M** (manual program) or **R** (reverse) is selected.

The following gears are available:

Forward driving - 1, 3 & 5

Reverse driving - R1

To select the reverse driving in Limp Home mode, simply select position **R**. Gear changing can only be done while the vehicle is stationary.

To Deactivate The Limp Home Mode

The Limp Home Mode will be deactivated when the ignition is turned off.

STARTING AND STOPPING

Closely follow the procedures below to start and stop the vehicle.

Starting

The pushbutton shift selector must be in the N position or the engine will not start. If the pushbutton shift selector is not in neutral, a starter protection message will appear in the DID along with the Information telltale and an audible warning.

If there is not enough air pressure in the I-Shift air tank, a low air supply message will appear in the DID along with the Information telltale light and an audible warning. Start the engine and allow the air pressure to build in the tank. Wait until the message and the telltale light turn off before attempting to shift the transmission into gear.

The brake pedal must be pressed down when passing from the N position to another position otherwise pressing the buttons will have no effects.

Stopping

When parking the vehicle, always apply the parking brake and place the pushbutton shift selector to the N position. Make sure the parking brake is holding the vehicle before leaving the driver position. Failure to do so can result in unexpected vehicle movement and can cause serious personal injury or death.

When the vehicle is stopped:

1. Apply the parking brake.
2. Select the N position on the pushbutton shift selector.
3. Turn off the engine.

STARTING THE VEHICLE UPHILL AND DOWNHILL

Hilly Operating Conditions

When starting the vehicle on an uphill slope:

1. Press the brake pedal.

2. Select the D position on pushbutton shift selector. The driver can use the – button to select a lower start gear if wanted.
3. Quickly move your foot from the brake pedal and completely depress the accelerator pedal.



CAUTION

Always use the brakes to hold the vehicle stationary on an uphill stop. Never hold the vehicle stationary on an uphill slope using the accelerator pedal. The clutch could overheat, which could cause it to break down.

The I-Shift transmission clutch is a dry disc type, with no torque converter. Never allow the clutch to slip in too high a gear when starting the vehicle. If the clutch overheats, a high clutch load message or clutch protection active message will appear in the DID along with the Check telltale light and an audible warning.



DANGER

The vehicle can roll when stopped on a hill or grade, or when the vehicle is starting from a stop on a hill or grade. Always use the brakes to hold the vehicle stationary on a hill or grade. Failure to do so can result in serious personal injury or death.

Hill Start Assist

Hill Start Assist provides anti-roll assistance during the transition from standing still to starting on a grade. The brake system maintains pressure in the brake chambers for 3 seconds after the service brake pedal is released, which allows time for the driver to move his foot from the brake pedal to the accelerator pedal.

Hill Start Assist is only intended to temporarily hold the vehicle on a grade before the vehicle is put into motion. The vehicle brake must be applied, independent of Hill Start Assist, to hold the vehicle on a grade for an extended period of time.

When available, Hill Start Assist is enabled at starting of the engine. The Hill Start Assist telltale light in the instrument cluster will blink to indicate that the feature is temporarily disabled. If a Hill Start Assist fault occurs, the Hill Start Assist telltale light in the instrument cluster will illuminate and the feature is permanently unavailable until the fault is repaired.

When Hill Start Assist is enabled, it activates automatically, but only when the following conditions exist:

- Vehicle speed is zero.
- Vehicle is on an incline or decline greater than 2%.
- Shift selector is in the D position on an incline or R position on a decline.
- Service brake is applied.
- ESC (Electronic Stability Control) is functioning normally.
- There has been no ESC activity in the preceding stops.

When the service brake pedal is released, the brakes are applied for approximately 3 seconds or until the accelerator pedal is depressed, whichever occurs first.



WARNING

Always apply parking brake before leaving driver's seat. The driver must not leave the vehicle when the engine is running and a gear is selected.

DRIVING

The most efficient way to operate the vehicle is to use the automatic drive program, which is the D position on the pushbutton shift selector. Gear changing is automatic and the driver can concentrate on the road ahead.

NOTE

When driving in automatic drive mode (position D), the engine brake control should be in the Auto mode  to maximize the integration of the transmission and brake system according to Eco-Roll mode. This means optimum performance and fuel economy at all times.

D Position

With the pushbutton shift selector in the D position, the transmission will automatically upshift and downshift as necessary to maintain the desired vehicle speed for the current driving conditions.

At starting of the vehicle, the gearbox selects between gear 1-6 the most suitable start gear with respect to weight and road's gradient. The driver can

4-68 Controls and Instruments

select a pulling away gear different than the one selected by using the + and - buttons.

When the vehicle is moving in automatic drive mode, the driver can intervene manually, while maintaining the accelerator pedal depressed, by selecting a higher or lower gear using the + and - buttons. The arrows in the display show how many gears are available to change up or down.

Whenever gear changing is not desired while in automatic drive mode, change the pushbutton shift selector from D to M. No further gear changes will be carried out and the current gear will remain engaged.



CAUTION

There is a risk of over-revving the engine when the transmission is locked in a gear. Damage to the engine may occur. To lock the transmission in the current gear, change the pushbutton shift selector from the D position to the M position. This function can be used for all 12 forward gears. To return to the automatic drive mode, set the pushbutton shift selector back to the D position.

M Position

It is possible to drive the vehicle with full manual gear changing or take over from the automatic gear changing system whenever required. Gear changing is done by first selecting the manual position M.

In manual shift mode, the driver use the + and - buttons to select gears.

The transmission will not automatically change gears as the driving conditions change. The current gear is displayed in the DID along with the up and down arrows. The number of available upshifts and downshifts will change as driving conditions change.

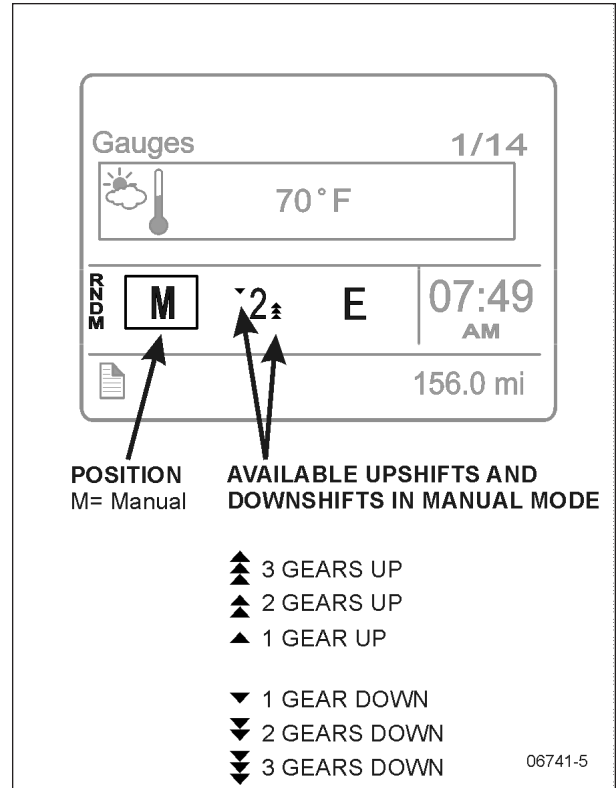

When changing a gear, the accelerator pedal should not be released.



CAUTION

Starting in too high a gear exposes the clutch to high levels of wear.



CAUTION

The driver must avoid over-revving the engine.

R Position

The system will select R2 automatically when the pushbutton shift selector is set to R, but if wanted, the driver can select R1 as reverse gear manually using the - button. During reverse, it is possible to shift between gear R1 and R2 using the + and - buttons.

TOWING RECOMMENDATIONS



CAUTION

When towing the vehicle, the transmission output shaft must not be allowed to spin or turn. If the vehicle is towed with the drive wheels still in contact with the road surface, the vehicle axle shafts or driveline must be removed or disconnected. Do not attempt to push or pull-start the vehicle.

Failure to disconnect the driveshaft, remove the drive axle shafts or lift the drive wheels off the ground before towing will cause serious damage to transmission.

Non-compliance with the above requirements will void warranty.



CAUTION

Make sure axle shafts or driveshaft are installed correctly after towing. Tighten axle shaft and driveshaft nuts to the correct torque settings. Do not invert shafts.

