

## **SECTION 4            CONTROLS AND INSTRUMENTS**

<b>KEYS.....</b>	<b>3</b>
ENTRANCE DOOR AND EXTERIOR COMPARTMENT DOORS KEY .....	3
<b>IGNITION SWITCH .....</b>	<b>3</b>
<b>T-KEY.....</b>	<b>3</b>
<b>LATERAL CONTROL PANEL .....</b>	<b>5</b>
TRANSMISSION CONTROL PAD (1) .....	5
CONTROL SWITCHES (2) .....	5
<i>Back-Up Alarm Cancel Switch</i> .....	5
<i>Kneeling</i> .....	5
<i>Power Window Switch</i> .....	5
<i>Entrance Door Interlock Cancel Switch</i> .....	6
MIRROR CONTROLS (3).....	6
PARKING BRAKES CONTROL VALVE (4).....	6
EMERGENCY/PARKING BRAKES OVERRULE CONTROL VALVE (BRAKE RELEASE) (5).....	6
<b>OBD DIAGNOSTIC TOOL RECEPTACLE .....</b>	<b>6</b>
<b>DASHBOARD.....</b>	<b>7</b>
CONTROL SWITCHES .....	8
L. H. DASHBOARD PANEL.....	8
R. H. DASHBOARD PANEL .....	11
DRIVER'S HVAC CONTROL UNIT .....	13
<i>Passenger's section temperature setting</i> .....	14
AIR VENTS.....	15
ELECTRONIC DESTINATION SIGN.....	15
<b>INSTRUMENT CLUSTER.....</b>	<b>16</b>
ANALOG INDICATORS.....	17
TELLTALE LIGHTS .....	20
STOP, CHECK AND INFORMATION TELLTALE LIGHTS .....	23
<i>STOP Telltale Light</i> .....	23
<i>CHECK Telltale Light</i> .....	23
ACKNOWLEDGING MESSAGES .....	23
DRIVER INFORMATION DISPLAY .....	23
<i>Selecting a menu</i> .....	24
<i>To change settings</i> .....	24
PICTOGRAMS DISPLAYED ON THE DRIVER INFORMATION DISPLAY (DID).....	25
<i>Warning pictograms, pop-up message pictograms, verifications and information pictograms</i> .....	25
<i>Status Line Pictograms</i> .....	29
<b>HORN.....</b>	<b>30</b>
<b>FOOT-OPERATED CONTROLS.....</b>	<b>30</b>
HEADLIGHT BEAM TOGGLE SWITCH .....	30
LEFT TURN SIGNAL SWITCH .....	30
RIGHT TURN SIGNAL SWITCH.....	30
ELECTRIC HORN .....	30
BRAKE PEDAL.....	30
ACCELERATOR PEDAL .....	31
<b>ALLISON AUTOMATIC TRANSMISSION .....</b>	<b>31</b>

## 4-2 CONTROLS AND INSTRUMENTS

---

OPERATION .....	31
PUSHBUTTON SHIFT SELECTOR .....	31
PRIMARY AND SECONDARY SHIFT MODES .....	31
DESCRIPTION OF AVAILABLE RANGES .....	32
<i>R (Reverse)</i> .....	32
<i>N (Neutral)</i> .....	32
<i>D (Drive)</i> .....	32

## KEYS

### ENTRANCE DOOR AND EXTERIOR COMPARTMENT DOORS KEY

Use this key to lock or unlock the entrance door, the baggage compartment doors and the driver's overhead compartment.

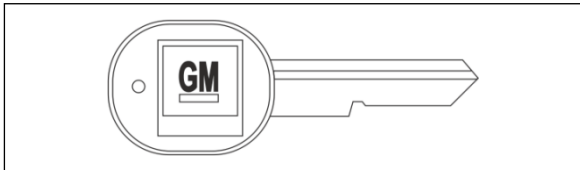

### IGNITION SWITCH

Vehicles are equipped with an ignition lever instead of an ignition key. Use the ignition lever to activate the electrical circuit by turning it to the ON position.

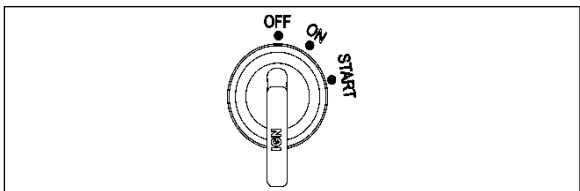

IGNITION SWITCH POSITIONS

06354

For further details, refer to STARTING AND STOPPING PROCEDURES section in this manual.

### T-KEY

Use this key to lock or unlock the engine RH compartment door and to have access to the handle that opens the engine compartment door. Also, this key locks and unlocks the electrical and service compartment door and the inverter access hatch at the rear end wall of the vehicle.



## 4-4 CONTROLS AND INSTRUMENTS

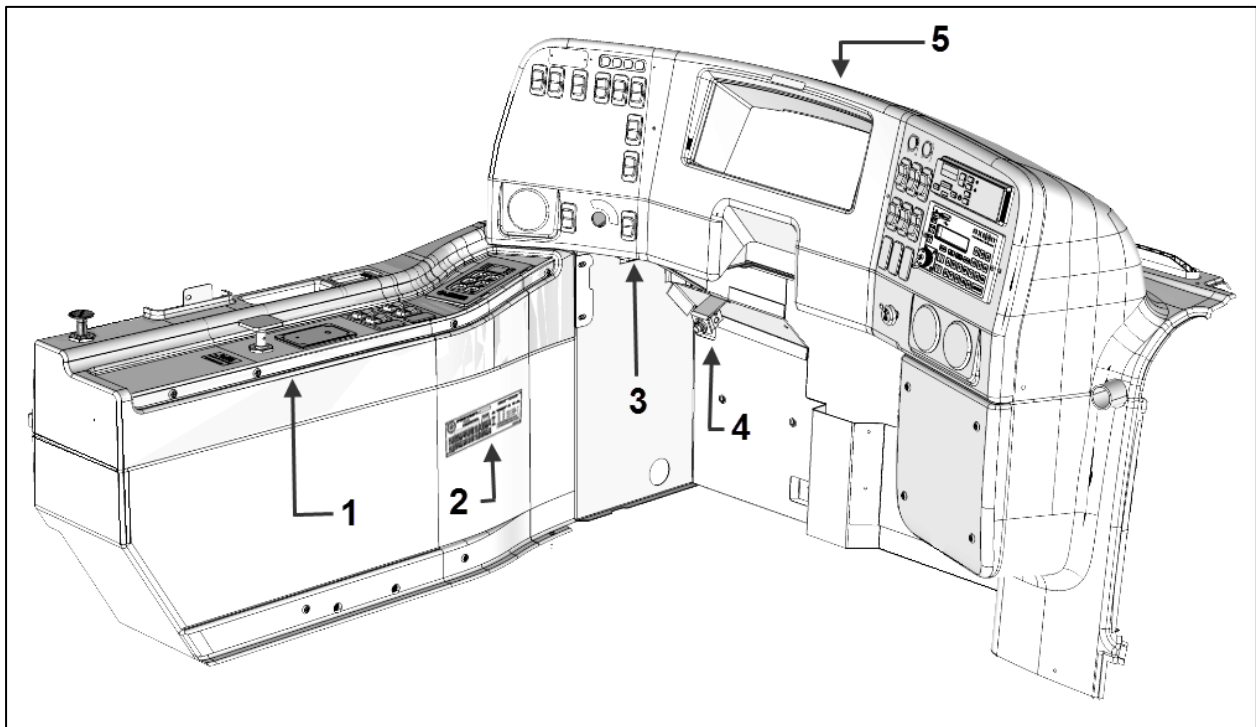

DRIVER'S SECTION

18671\_3

1. Lateral control panel
2. DOT certification plate
3. Diagnostic tool receptacle (OBD)
4. Foot operated steering wheel adjustment unlock air valve
5. Dashboard

LATERAL CONTROL PANEL

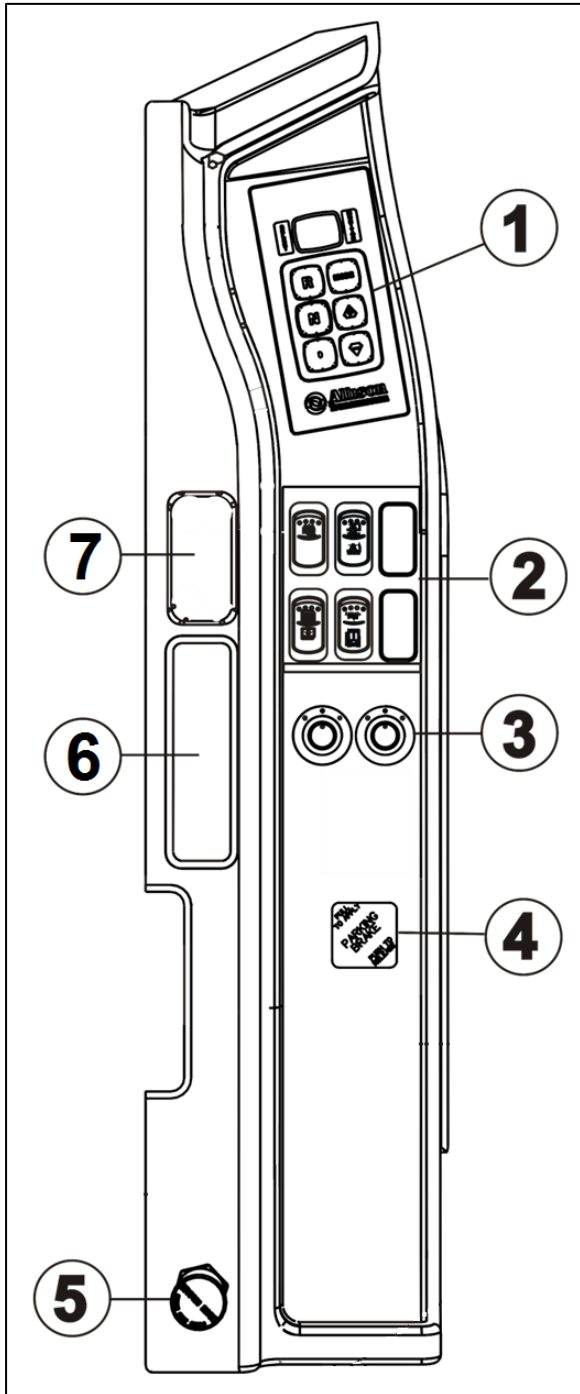

LATERAL CONTROL PANEL

06704\_2

- 1. Transmission control pad
- 2. Control switches
- 3. Mirrors controls
- 4. Parking brakes control valve
- 5. Emergency Parking Brakes Overrule

- 6. Utility Compartment
- 7. Utility Compartment

TRANSMISSION CONTROL PAD (1)

The Allison transmission control pad is located on the lateral control panel. Refer to "Automatic Transmission" in this section for operating instructions and more information.

CONTROL SWITCHES (2)

Back-Up Alarm Cancel Switch

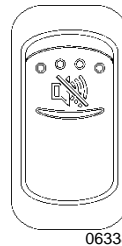

Use this rocker switch to cancel the back-up alarm.

**NOTE:** Normal operation resumes after leaving reverse gear.

Kneeling

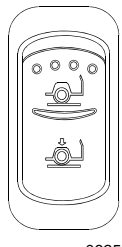

Momentarily press the rocker switch downwards to lower the front end of the vehicle. Momentarily press the rocker switch upwards to raise the vehicle to the normal driving height. Refer to OTHER FEATURES section for more information.

**NOTE**

*This vehicle is equipped with an interlock system which automatically applies the parking brake when the kneeling system is activated.*

Power Window Switch

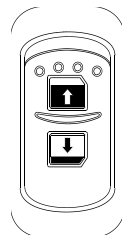

Use this rocker switch to open or close the driver's power window.



**CAUTION**

Close power window when parked or leaving the vehicle unattended.

## 4-6 CONTROLS AND INSTRUMENTS

### Entrance Door Interlock Cancel Switch

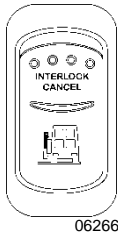

06266

This switch enables moving the vehicle while the entrance door is open for maintenance purposes or in case of emergency.



### DANGER

Unless absolutely necessary, always apply parking brakes before canceling entrance door interlock

### MIRROR CONTROLS (3)

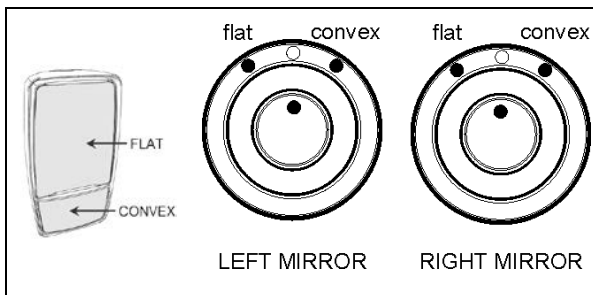

MIRROR CONTROLS

06374

Turn left pointer knob counterclockwise for flat mirror adjustments and to the right for convex mirror adjustments, then use the joystick control to adjust the selected mirror's viewing angles. Adjust the right outside mirror similarly but by using the right side control.

### PARKING BRAKES CONTROL VALVE (4)

Spring-applied parking brakes are applied by pulling up the control valve knob. Push down to release brakes. Refer to SAFETY FEATURES AND EQUIPMENT section.



PARKING BRAKE CONTROL VALVE

12129\_3

### EMERGENCY/PARKING BRAKES OVERRULE CONTROL VALVE (BRAKE RELEASE) (5)

The coach may be equipped with the optional parking brake overrule system, which allows the vehicle to be moved to the nearest safe parking area if the spring-applied emergency brake has automatically applied to the drive axle wheels. To actuate the parking brakes overrule system, push and hold down the control valve located on the lateral control panel.

### OBD DIAGNOSTIC TOOL RECEPTACLE

To ease troubleshooting, you can connect a diagnostic tool through the OBD receptacle to access recorded data. The OBD receptacle is located under the dashboard, on the left side.

### AUTOMATIC FIRE DETECTION AND SUPPRESSION SYSTEM (AFSS)

Refer to SAFETY FEATURES AND EQUIPMENT for more information on *Kidde Dual Spectrum* Automatic Fire detection and Suppression System (AFSS).

DASHBOARD

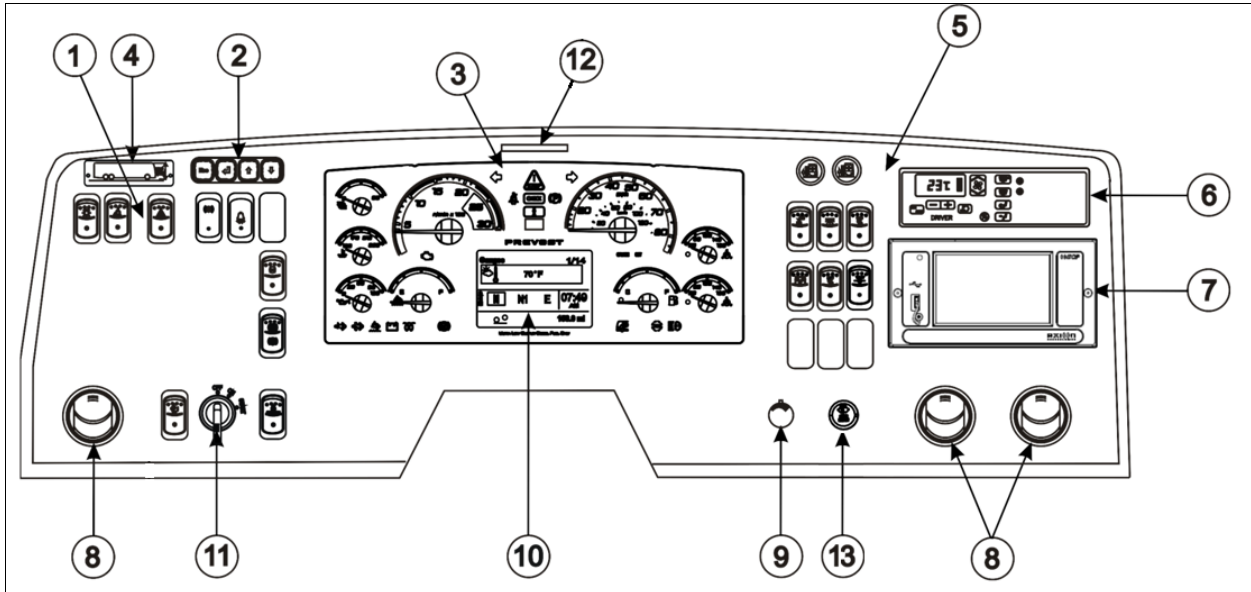

DASHBOARD

06761\_1

1. L. H. Dashboard Panel
2. Driver Information Display (DID) Keyboard
3. Instrument Cluster
4. Vehicle Clearance Information
5. R. H. Dashboard Panel
6. HVAC Control Unit
7. Electronic Destination Sign Central Control Unit
8. Air Vents
9. Brightness Control
10. DID (Driver Information Display)
11. Ignition Switch (Lever)
12. Minimum Operating Air Pressure Warning Tag
13. Wipers

## 4-8 CONTROLS AND INSTRUMENTS

### CONTROL SWITCHES

Many switches are equipped with a LED indicator to inform the driver at a glance which features are active. Switches are described in the order they appear, from left to right, top to bottom.

#### L. H. DASHBOARD PANEL

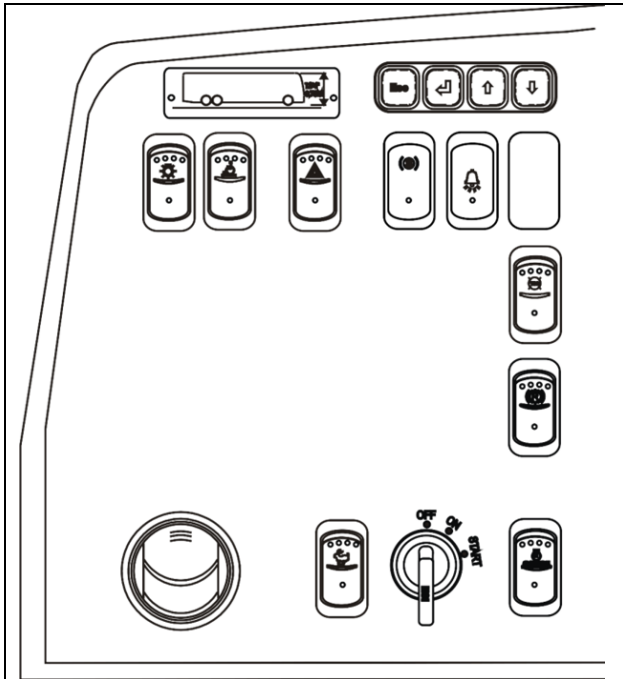

L. H. DASHBOARD PANEL

06762\_1

The L.H. dashboard panel includes controls for the operation of the vehicle; it also includes the ignition switch, radio control and an adjustable air vent.

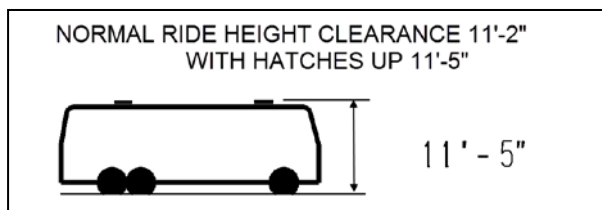

Vehicle height information with hatches up and down.



### WARNING

Vehicle clearance is higher when the ventilation hatch is open or if additional equipment is installed on the roof.

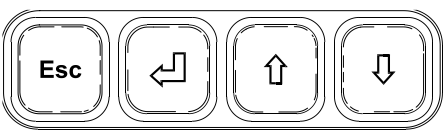

06399

#### Driver Information Display (DID)

This standard feature gathers stores and displays important information about the vehicle's operation on a display screen on the lower center portion of the cluster. Refer to "Driver Information Display" in OTHER FEATURES section for a description of how to set up and operate the Driver Information Display.



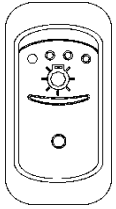

06254

### Headlights and Exterior Lighting

**Off position** – Daytime running lights only

Press this rocker switch to turn on the following lights:

**First position** – Front parking lights, clearance lights, tail lights, license plate lights and marker lights.

**Second position** - Push down fully to turn *ON* the headlights, the controls and instrument lights and all lights from first position.

#### NOTE

*Daytime running lights will be automatically canceled when the exterior lighting switch is fully depressed (second position).*

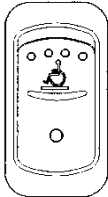

06268

### Wheelchair Lift Power Switch

Activate the optional wheelchair lift by pressing down on the rocker switch. Refer to OTHER FEATURES section and to wheelchair lift system's Operator's Manual for operating instructions.

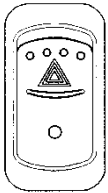

06256

### Hazard Warning Flashers

Press the rocker switch to make all turn signal lights flash at once. The dashboard telltale lights will flash when the hazard warning flashers are *ON*.



#### CAUTION

Do not use the hazard flashers for an extended period of time unless necessary because the electrical circuits are activated when the hazard switch is depressed.



06774

### Stop Light Indicator

This indicator light will illuminate simultaneously with the vehicle rear brake lights.



06771

### Stop Request Warning Light

This warning light will illuminate and an audible warning sound will be heard when one of passenger pushes the stop request button on the overhead console to request a stop for disembarking.

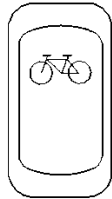

### Bike rack Warning Light (Optional)

This warning light will illuminate when the bike rack is folded down.

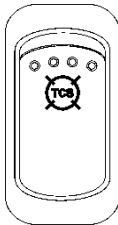

06758

### Traction Control System Mud/Snow Mode

On certain road conditions, it may be useful to retard the intervention of the traction control system TCS during vehicle acceleration. The Mud/Snow function allows greater engine power and more wheel spin during TCS operation. This function may be helpful to set the vehicle in motion on iced roads, for example.

Press the Mud/Snow switch to turn on this function. The TCS/ESC telltale blinks slowly when the TCS Mud/Snow mode is active. Always remember to turn the Mud/Snow feature off when driving on a firm road surface.

A new ignition cycle or a second pressing of the Mud/Snow switch will turn this function off.



### Transmission Retarder

Press this rocker switch to activate the transmission retarder. Refer also to "Transmission Retarder" in OTHER FEATURES section.

NOTE
<i>Deactivating the transmission retarder will turn on the indicator light located at the front of the vehicle.</i>

### Secondary use - Regeneration Inhibit Override

Flip this rocker switch 4 times (4 transitions from OFF to ON) within 2 seconds to override the regeneration inhibit function through geofencing and allow parked regeneration.

Maintenant dans la RJB à valider



### Fast Idle

For extended idling periods, run the engine at fast idle. Press down the rocker switch to engage fast idle. This increases the engine speed to approximately 1,000 rpm. Return to normal idle before driving or when stopping the engine.

 **CAUTION**

Reduce the engine to normal idle before shutting the engine *off*.

**NOTE**

*If the parking brake is released and/or the transmission is engaged with the engine running at fast idle, the engine will return to normal idle and remain there as long as the parking brake is not applied and/or transmission is not placed in neutral (N).*

*The engine will return to fast idle once the parking brake is applied or neutral (N) selected.*



06265

**Engine Stop Override (with Automatic Fire Detection and Suppression System)**

Press the Engine Stop Override switch on the dashboard or the Delay Engine Stop switch on the AFSS protection panel to delay the engine shutdown and extinguisher discharge by an additional 15 seconds.

 **CAUTION**

Use this function if you are not prepared to bring the vehicle to a safe stop (i.e. on a railroad track, in the intersection).

**R. H. DASHBOARD PANEL**

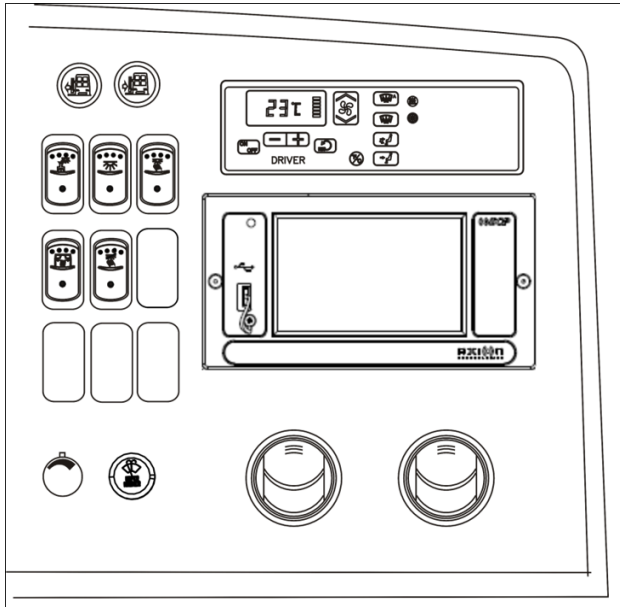

R. H. DASHBOARD PANEL

06724\_1

The HVAC control module, electronic destination sign control unit as well as the cluster dimmer switch, interior lighting control switches, entrance door operating buttons, miscellaneous control switches and air vents are located on the R.H. dashboard panel.



CLOSE



OPEN

**Entrance Door Operating Buttons**

Press the red (R.H. button) button to open the door. The door will open to full open position.

06464

Press and hold the green (L.H. button) button to close the door.



### WARNING

The door mechanism has no automatic safety protection to avoid injury to bystanders. The driver is responsible for the safe operation of the door.

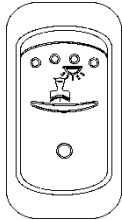

06244

#### Driver's Area Lighting

Press the rocker switch to illuminate the ceiling lights in the driver's area as needed.

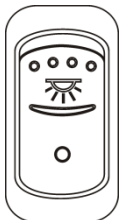

06239

#### Interior Lighting

Press this rocker switch to the first position to illuminate the aisle fluorescent lighting. Press down the second position to gradually illuminate the in-station reading lights to 80% of their intensity regardless if they were turned off individually by passengers. Lights will also turn OFF gradually.



### CAUTION

To avoid running down the batteries when the engine is off, turn off the lights or connect the optional battery charger to a 110-120-volt AC power supply.

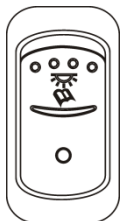

06240

#### Reading Lights

This switch powers the reading light circuit enabling passengers to operate their personal reading lights. Refer to VEHICLE INTERIOR section.



### CAUTION

To avoid running down the batteries when the engine is OFF, turn off the lights or connect the optional battery charger to a 110-120-volt ac power supply.

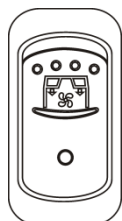

06245

#### Passenger Overhead Air Registers

Press the switch to start the air register fans. The fans are connected to a sensor and their speed will increase automatically if the outside temperature reach 60 deg. F or if the inside temperature rises above the set point.

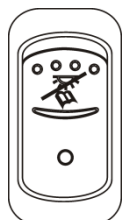

06240\_1

#### First Row Reading Lights Cancel Switch

This switch is used to cancel the first row reading lights. This function is useful to minimize glare in the windshield during night driving.

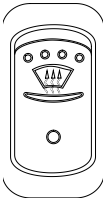

**Windshield Upper Section De-icing (option)**

The coach may be equipped with a defrosting system in the upper windshield section. Press the rocker switch to activate the blower in order to clear fog, frost or thin ice from either side of the upper windshield.

06259

The upper windshield defrosting is automatically activated when the outside temperature is lower than 39°F (4°C), the driver's side HVAC control unit is turned on and fan speed is higher than zero. After automatic activation of the upper windshield defrosting, the upper defroster unit can be turned off by cycling this switch to the ON position and then to the OFF position.



**Brightness Control**

Adjusts the brightness of the dashboard instruments and switches.

06249



**Wiper/Washer Control**

Push the control to activate the windshield washer. Turn the button to activate the wipers. The first position activates the wipers intermittently. The second position is the slow speed and the third position is for high speed wiping.

06249

**DRIVER'S HVAC CONTROL UNIT**



22296

The vehicle is divided into two areas:

- 1 - Driver's area (driver's HVAC unit)
- 2 - Passengers' area (central HVAC unit)

Fresh air is fed in each area and has a separate return air and discharge air duct.

The driver's HVAC control unit is used to control heating, ventilation, air conditioning and defroster in the driver's area. The passenger's area HVAC unit (central unit) has a preset temperature of 68°F (20°) and is fully automatic. It turns on at starting of the engine. No inputs are required from the driver to control the passenger's HVAC unit.

**NOTE**

*It is recommended to run engine at fast idle to operate the air conditioning system when the vehicle is stationary.*

*This will improve A/C compressor performance and provide adequate electrical power to the multiple A/C system fans.*

*When the system is running, keep roof ventilation hatch and door closed to prevent cooling loss.*

To prevent battery run-down, the central HVAC unit will not operate if the charging system is not working properly.

When the HVAC system is in operation, park at least 4 feet from other vehicles or buildings to allow sufficient air flow through the condenser core.

The driver's HVAC unit may be turned ON by pressing the ON/OFF button.

Also, the driver's HVAC unit turns on automatically at starting of the engine and uses the settings kept in memory before turning off of the system.

The HVAC control unit performs a self-test every time it is turned on. Codes are shown on displays or flashed on control buttons. Refer to the Maintenance Manual for more information on the diagnostic codes.

## 4-14 CONTROLS AND INSTRUMENTS

In cold weather, the A/C compressor starts automatically when the two following conditions are satisfied:

1. The outside temperature is above 32°F.
2. The increasing passenger's area temperature has reached 7°F under the set point. At this moment, enough heat is available from the engine to warm up the area while the air conditioning will remove moisture in air and prevent fogging up of the windows.

### NOTE

Upon starting if the outside temperature is above 32°F (0°C) and then drops below 32°F (0°C), the compressor will keep running up to a temperature of 15°F (-9°C) to prevent fogging up of the windows.

### Heating Mode Indicator



22131

This red LED illuminates when the system is heating.

### Cooling Mode Indicator



22134

This green LED illuminates when the system is cooling (when the compressor clutch is engaged).

### Fan Speed



22135

The driver's fan has six speeds. Increase speed by pressing on the upper portion of the button, decrease by pressing on the lower portion.

### Recirculate



22138

Closes or opens the driver's and passenger's unit fresh air damper.

A red LED in the top right corner of the button illuminates when air is recirculated.

This feature is automatically canceled when defogging is activated.

### Driver's area temperature setting



22303

The temperature displayed on the driver's HVAC control unit is the temperature set point.

To increase the temperature set point, press on the "+" sign, to decrease the temperature set point, press on the "-" sign. Temperature range is between 60°F and 82°F (16°C to 28°C). Setting for a temperature set point above 82°F (28°C) will keep the coolant valve open and "FULL" will be displayed.

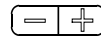

22132

In case of interior temperature sender unit failure, the coolant valve will remain open and three lines "---" will be displayed.



### WARNING

Warm temperatures may cause drowsiness and affect alertness while driving. Keep the temperature comfortable but not too high.

### Passenger section temperature setting

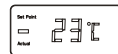

22304

The temperature displayed on the passenger's side HVAC control unit is the actual temperature in the passenger's area.

To increase or decrease the temperature set point in the passenger's area, press on the "+" or the "-" sign. Pressing these buttons will flash the displayed set point and the word "SET" will highlight. Temperature range is between 60°F and 82°F (16°C to 28°C).

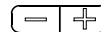

22132

In case of interior temperature sender unit failure, the coolant valve will remain open and two dashes "--" will be displayed. The driver can nevertheless control the temperature by adjusting the temperature set point above 72°F (22°C) to heat and below 72°F (22°C) to cool.

### Windshield Defogger

Upon pressing this button, the dashboard damper sends air only to the lower windshield. The fan is turned on to maximum speed, the fresh air damper opens completely (REC off) and the driver set point is increased to 4°F (2°C) over the passenger's section set point.



22305



22139

The dashboard damper sends air only to the lower windshield when activated. The footwell damper is also closed but the fan speed can be reduced or increased.

**NOTE**

*Upon starting of the vehicle, when the ambient temperature is very cold in and out of the vehicle, the HVAC control unit will permit a temperature overshoot up to 3° over the passenger's area set point to help warming up of the area because some parts of the vehicle like the seats and the overhead compartments accumulate cold.*

**Panel and Footwell**

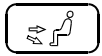

22137

The dashboard damper sends air to the panel vents and footwell.

**Panel**

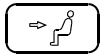

22136

Air is sent to panel registers. The footwell damper is closed.

**Temperature Degree Selector**



22133

Toggles temperature units between Fahrenheit and Celsius. The HVAC control unit must be on. Also toggles the outside temperature units displayed on the telltale panel.

**AIR VENTS**



Three adjustable driver air vents in the dashboard and one near the door feed air to the driver's compartment. Use the HVAC control panel to set air temperature and fan speed.

**ELECTRONIC DESTINATION SIGN**

The electronic Destination Sign System (DSS) is automatically activated when the ignition switch is turned to the ON position.

The controller provides a single control interface to multiple systems on the vehicle. System information such as message listings for destination signs, updated route or public service information for the INFOtransit system can be downloaded via USB, Wireless or other on board systems.



**Destination Sign Controller**

Refer to [Technical Publications web site](#) and [Supplier Publications section](#) for reference guide how to set the controller.

**Distress Signal (Emergency Mode)**

The electronic destination sign is equipped with a distress signal function activated using a foot switch located on the floor, just in front of the driver seat.

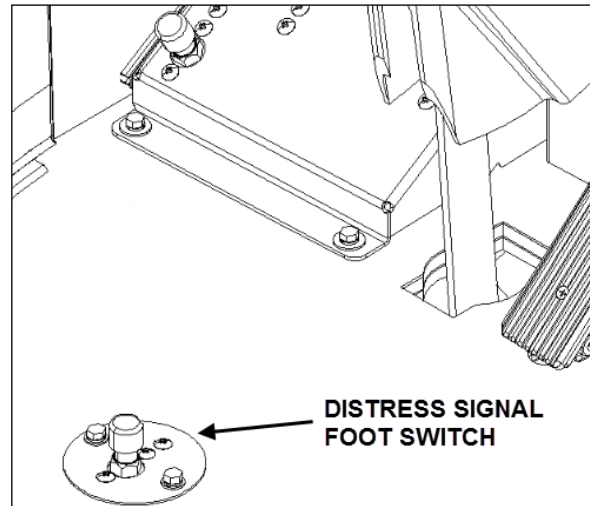

**Distress Signal Foot Switch**

When activated, a warning message will be displayed on all exterior destination signs to prompt a passer-by to call for help on behalf of the operator and allow emergency services to easily identify the vehicle needing assistance.

To deactivate the message, press the foot switch a second time and if necessary enter a code from the main default screen.

**NOTE**

*Several other functions are available through the touch-screen menu. Refer to Destination Sign User manuals included with the vehicle documentation for additional information about programming, downloading, troubleshooting and other menu options.*

### INSTRUMENT CLUSTER

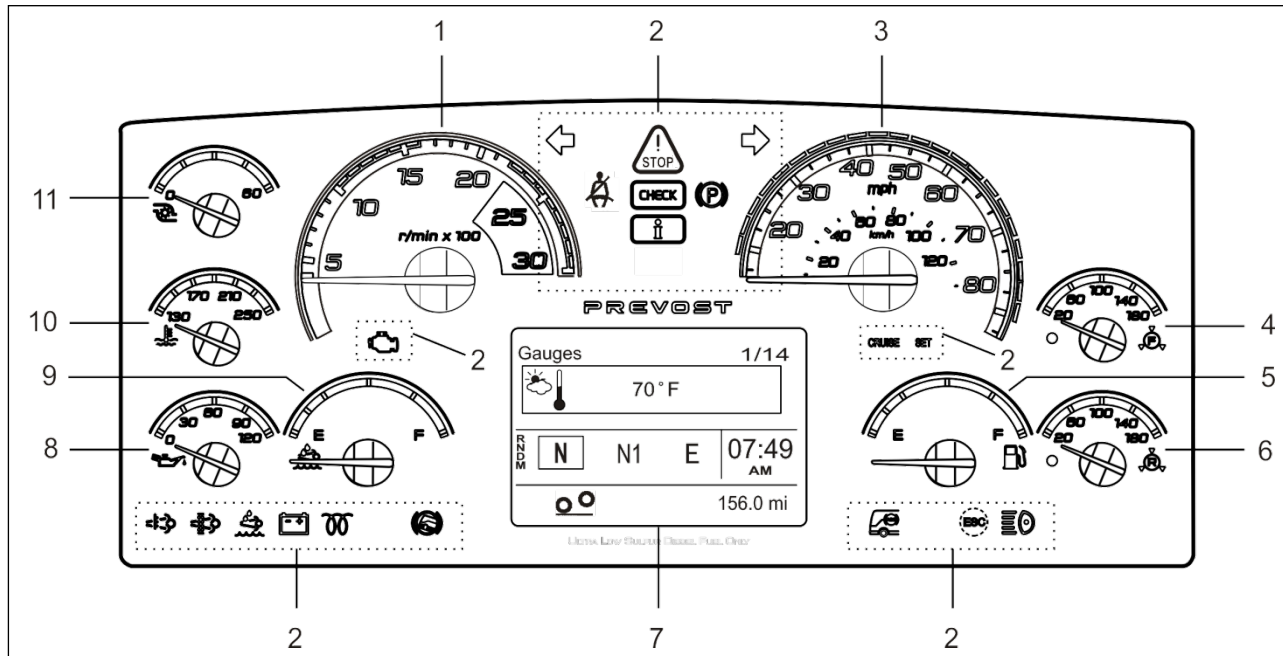

06727\_e

- |   |   |
|---|---|
| <ol style="list-style-type: none"> <li>1. Tachometer</li> <li>2. Telltale lights</li> <li>3. Speedometer</li> <li>4. Front brake air pressure (secondary)</li> <li>5. Fuel level</li> <li>6. Rear brake air pressure (primary)</li> </ol> | <ol style="list-style-type: none"> <li>7. Driver Information Display (DID)</li> <li>8. Oil pressure indicator</li> <li>9. DEF level (Diesel Exhaust Fluid) indicator</li> <li>10. Engine coolant temperature</li> <li>11. Turbo boost pressure</li> </ol> |
|---|---|

The instrument cluster includes the analog instruments. It also presents two devices to communicate information to the driver, the telltale lights and the Driver Information Display (DID).

Indications and warnings are presented according to three levels of attention required:

#### 1. The Telltale Lights

The highest level of attention. The telltale lights are temporary and exceptional; they present information critical to safety or vehicle integrity.

#### 2. The Pop-Up Messages

The second level of attention. The pop-up messages appear in the Driver Information Display DID without the driver's intervention and

acknowledgement. Pop-up messages present supplemental information to the driver.

#### 3. The Status Line

The lowest level of attention. The status line monitors certain systems and gives feedback to the driver concerning current actions and functions.



**ANALOG INDICATORS**

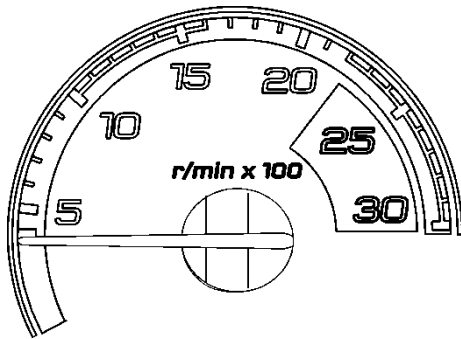

**Tachometer (rpm x 100)**

Indicates the operating speed of the engine in hundreds of revolutions per minute. The tachometer serves as a guide for gear shifting and helps to prevent engine over-speeding when driving downhill with the engine brake operating. Use the green range for normal driving (1000 to 1600 rpm).

06728



**CAUTION**

Never allow the engine to go into the red range. This could lead to severe engine damage.

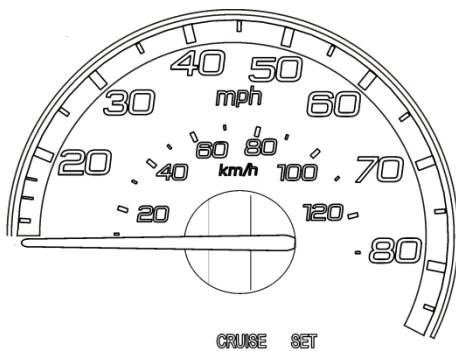

**Speedometer (mph, km/h)**

06729\_1

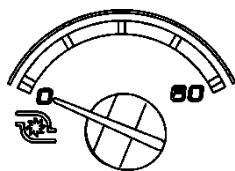

06730

**Turbo boost pressure (psi)**

Indicates the turbo boost pressure in psi. This pressure should be the same at a given engine temperature, speed, and load. An unusual reading could indicate an engine failure.

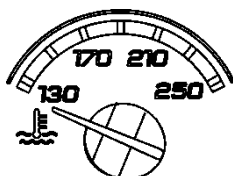

06731

**Engine coolant temperature (°F)**

Indicates the operating temperature of the engine coolant in °f. The normal reading should be between 170°f and 222°f (80°c to 106°c).

The temperature limit is dependent on the electronic program for the engine model. When coolant temperature is excessive, the stop telltale light turns on, an audible alarm sounds and a pop-up message appears on the DID. The engine protection system will automatically derate and stop the engine in 30 seconds. Stop at the first safe place where the problem can be checked.

If the temperature remains below or exceeds the normal temperature range, the cooling system should be checked for problems.



Stop telltale light

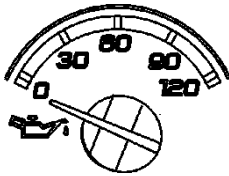

06732

**Engine Oil Pressure (Psi)**

Indicates the engine oil pressure in psi. When the oil pressure is too low, the stop telltale light turns on, an audible alarm sounds and a message appears on the DID. The engine protection system will automatically derate and stop the engine in 30 seconds. Bring the vehicle to a safe stop where the problem can be checked.



STOP telltale light



OIL PRESSURE pictogram

 <b>WARNING</b>
<p>Failure to take necessary action when the stop telltale light is on can ultimately result in automatic engine derate and shutdown.</p>

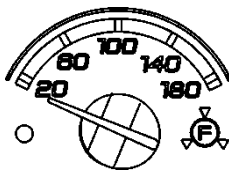

06737

**Front Brake Air Pressure Gage (Secondary System)**

Indicates the front brake air system pressure in psi. The normal operating pressure is from 122 to 140 psi.

The **low air pressure** indicator LED on the gage and the **STOP** telltale light illuminate when the front brake air system (secondary) pressure drops below 85 psi. An audible alarm will sound.



STOP telltale light

 <b>WARNING</b>
<p>The driver is responsible for monitoring the pressure as part of a regular sweep of the instruments.</p> <p>If the pressure drops in the secondary system but remains normal in the primary system, the front axle service brakes will not function but the drive and tag axle service brakes will operate normally, although if there is a leak in any pneumatic system (Sec/Pri/Park/Acc), the primary system might eventually lose its air pressure as well, depending on the nature and size of the leak. In the event of any air pressure</p>

loss in any system, the driver should pull to the side of the road as soon as can be safely done and investigate the situation.

Do not drive the coach when the brake air pressure is low.

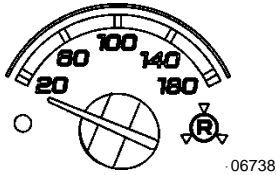

### Rear Brake Air Pressure Gage (Primary System)

Indicates the rear brake air system pressure in psi. The normal operating pressure is from 122 to 140 psi.

The **low air pressure** indicator LED on the gage and the **STOP** telltale light illuminate when the rear brake air system pressure drops below 85 psi. An audible alarm will sound.



STOP telltale light



### WARNING

The driver is responsible for monitoring the pressure as part of a regular sweep of the instruments.

In the event of a pressure loss in the primary brake system, the drive and tag axle service brakes will not function normally. It is critical to bring the coach to a safe stop as quickly as possible.

If there is sufficient pressure in the secondary brake system, modulated spring brake pressure (using the park brake chambers) will be used to apply the drive axle brakes, proportional to the braking pressure on the front axle. It must be noted this is an emergency situation and a significant amount of secondary air pressure is lost with each apply/release cycle. The spring brake modulation will only function two or three times, depending on the amount of secondary air pressure that was on hand when the primary brake pressure was lost.

Once the secondary air pressure drops below 60 psig, the park spring brakes are fully applied and cannot be released until pressure is restored.

Do not drive the coach when the brake air pressure is low.

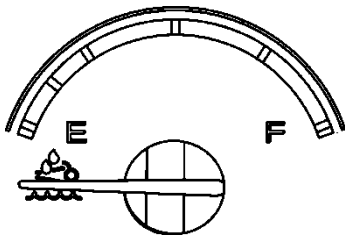

06735

**DEF level**

Indicates the amount of DEF (diesel exhaust fluid) remaining in the DEF tank. The DEF tank is considered as being full when it contains 16 gallons (60 liters) of DEF. DEF consumption will be approximately 2% of the diesel fuel consumed.



**CAUTION**

DEF will begin to crystallize and freeze at 12°f (-11°c). DEF expands by approximately 7% when frozen. In order to permit DEF expansion without causing damages to the DEF tank, do not fill the DEF tank with more than ¾ capacity.

**Fuel Level**

Indicates the amount of fuel remaining in the fuel tank. At the beginning of the red area, there is approximately 48 gallons (182 liters) left in the tank.

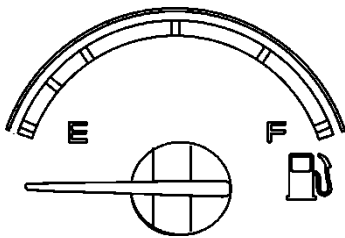

06736







**NOTE**









*A pop-up message will appear in the DID informing that there is only 24 gallons (92 liters) left in the fuel tank.*

**TELLTALE LIGHTS**

The telltale lights illuminate for 5 seconds at the start of every ignition cycle as a light bulb check.

	<p><b>Stop</b></p> <p>Indicates that a serious problem has been detected. Immediately park the vehicle in a safe place and stop the engine. This telltale light may be accompanied with a message in the DID and a diagnostic troubleshooting code will be stored to ease identification of the problem. <b>WARNING:</b> Failure to take necessary action when the STOP telltale light is on can ultimately result in automatic engine derate and shutdown.</p>
	<p><b>Check</b></p> <p>Indicates that a problem has been detected and must be checked at the next stop. This telltale light may be accompanied with a message in the DID and a diagnostic troubleshooting code will be stored to ease identification of the problem.</p>
	<p><b>Information</b></p> <p>This information telltale is not activated in this vehicle but will be visible during a few seconds when the vehicle ignition key is turned ON.</p>

	<p><b>Turn Signal Indicators</b></p> <p>Flashes when the right or left turn signals are activated. Signal right and left turns by operating the foot control switches. See “Foot Operated Controls” in this section.</p> <p><b>NOTE</b></p> <p><i>The turn signals are automatically activated when the vehicle is backing up or when the wheelchair lift is in function.</i></p>
	<p><b>Driver seat belt reminder light and warning buzzer</b></p> <p>When equipped with a seat belt buckle switch, warns the driver to fasten his/her seat belt.</p>
	<p><b>Parking Brake Or Emergency Brake Applied</b></p> <p>Illuminates when the emergency/parking brake is applied. The control valve is located on the L.H. control panel.</p> <p>This telltale also will flash and an audible alert will be heard if ignition is set to off and the parking brake is not engaged or if no brakes (service or parking) are applied while the vehicle is in neutral below 3 mph (5 km/h).</p>
	<p><b>Aftertreatment System Malfunction (Malfunction Indicator Lamp)</b></p> <p>Indicates a failure of an emission control device. May illuminate at the same time as the CHECK amber warning light. The lamp will go out after 3 completed <i>ignition on-ride-ignition off</i> cycles. Vehicle can be driven to end of shift. Call for service.</p>
	<p><b>High Exhaust System Temperature (HEST)</b></p> <p>Illuminates to notify the driver that the DPF is in active regenerative mode and that exhaust gas temperature at the exhaust system diffuser are potentially hazardous.</p> <div style="border: 1px solid black; padding: 5px; margin: 10px 0;"> <p> <b>WARNING</b></p> <p>During regeneration, exhaust temperature may reach up to 1200°f (650°c) at the particulate filter. When parking the vehicle, if this telltale light is illuminating, make sure that the exhaust system diffuser is away from people or any flammable materials, vapors or structures.</p> </div>
	<p><b>DPF Regeneration Request</b></p> <p>Illuminates to notify the driver that a manual stationary regeneration will be required soon. The flashing state indicates a more severe condition requiring regeneration. Refer to “Exhaust Aftertreatment System” paragraph in OTHER FEATURES section.</p>

	<p><b>Low DEF Level</b></p> <p>Illuminates when there is between 1.6 and 0.8 gallons (6 and 3 liters) of DEF left in the tank.</p> <div style="border: 1px solid black; padding: 5px;"> <p> <b>CAUTION</b></p> <p>This telltale light starts flashing when there is less than 0.8 gallons (3 liters) left in the tank. It may flash in conjunction with the check engine and / or stop engine lights.</p> <p>If the vehicle is kept in operation with an empty DEF tank, and engine derate will eventually occur, limiting the speed to 5 mph.</p> </div>
	<p><b>Alternators</b></p> <p>This telltale indicates that neither alternator is charging.</p> <div style="border: 1px solid black; padding: 5px;"> <p><b>NOTE</b></p> <p><i>“Charging System Malfunction” message will also appear in the DID</i></p> </div> <p>This telltale also will flash and an audible signal will be heard if the battery charger is plugged to an outside source and the parking brake is removed.</p>
	<p><b>Intake Air Preheater ON – Wait Before Starting</b></p> <p>Illuminates when the intake air preheater element is in function. Wait until this telltale light has turned off before starting the engine. For more information on this feature, refer to paragraph “Cold Weather Starting” in STARTING AND STOPPING PROCEDURES section.</p>
	<p><b>Hill Start Assist</b></p> <p>This function is not activated in this vehicle.</p>
	<p>Illuminates when the ABS is not available or when the ABS is malfunctioning. After startup, since the ABS system does not operate at less than 4 mph (7 km/h), the indicator will remain illuminated until the vehicle reaches that speed. Refer to OTHER FEATURES section.</p>
	<p><b>Electronic Stability Control (ESC)</b></p> <p>Quickly flashes every time the electronic stability intervenes. Will also flash when Mud/Snow mode is turned on using the Mud/Snow switch.</p>
	<p><b>High Beam</b></p> <p>Illuminates when the high beams are selected. High and low beams are selected with the foot-operated controls. Refer to “Foot Operated Controls” paragraph in this section.</p>

**STOP, CHECK AND INFORMATION TELLTALE LIGHTS**

STOP and CHECK telltale lights illuminate automatically to draw the attention of the driver and their associated messages are displayed in the DID. More than one message (see “Acknowledging Messages” below) can be active at the same time. A displayed message can be replaced by a new message provided the new message has a higher priority. Only fault codes that have a direct impact on vehicle operation are displayed. All fault codes are stored in the appropriate ECU for access by service technicians.

**STOP Telltale Light**

In the event of a serious fault, the red STOP telltale light comes on and an audible alarm will sound if the engine is running. An illuminated stop message light indicates a serious problem has been detected, and the driver must respond immediately to the problem.



When illuminating, this telltale light means the vehicle must be safely pulled off the road and stopped. In some instances, the engine must be switched off immediately.

	<b>WARNING</b>
Failure to stop and take necessary action when the stop telltale light is on can result in automatic engine derate and shutdown.	

In some cases preventive action may be taken by the engine ECU to protect the engine. For further details, refer to “Engine Protection System” in STARTING AND STOPPING PROCEDURES section.

**CHECK Telltale Light**

This telltale light means that a fault or an abnormal operating condition has been detected. The vehicle must be checked at the next stop.



If the CHECK telltale light illuminates, an associated message is displayed in the DID. Always pay attention to the associated messages (see “Acknowledging Messages” below).

**ACKNOWLEDGING MESSAGES**

A fault message associated to a STOP or CHECK telltale light must be acknowledged by pressing the ESCAPE or ENTER button after which the display returns to the same status that existed before the fault occurred. All messages can be acknowledged. Acknowledged but inactive messages are displayed again when the ignition key is turned to the START position or they can be read in the DID menu. Refer to OTHER FEATURES for more information on the DID menus.

**DRIVER INFORMATION DISPLAY**

The DID (Driver Information Display) is located in the center of the instrument cluster. It displays digital gages, main menus and submenus that provide necessary and important information to the driver. The information available to the driver depends on vehicle configuration, and whether the vehicle is in operation or parked. For the list of the available menus and submenus, refer to “Driver Information Display Menus” in OTHER FEATURES section.

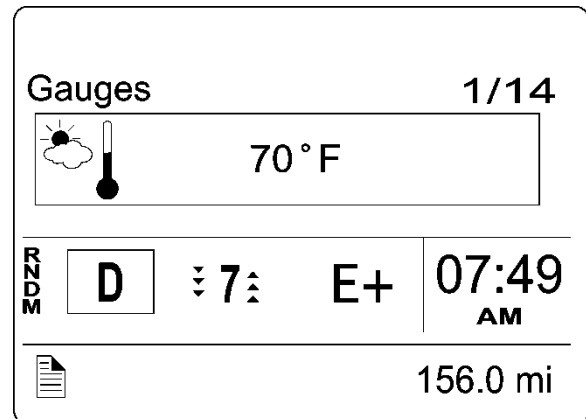

06746

The outside air temperature, fuel flow and the odometer (Allison transmission) are part of the default display. You can replace the default display by your selection of favorite gages using the Driver Information Display submenu Favorite Display Setting. Refer to *Other Features* section for more information.

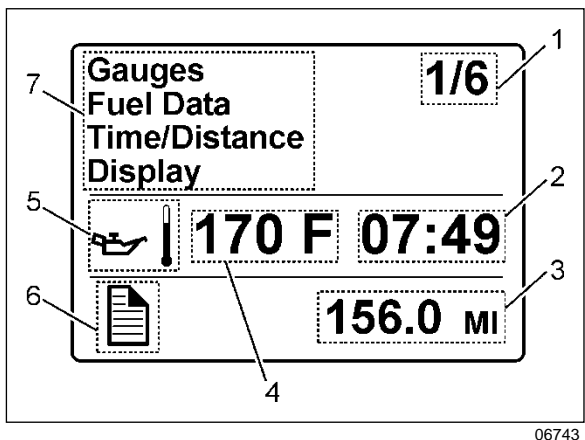
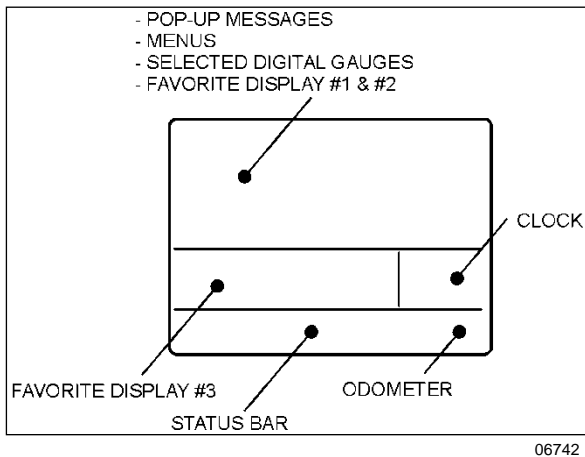

1. Indicates first of six available menus (varies by menu)
2. Clock
3. Odometer
4. Value or data (in this example, the engine oil temperature)
5. Pictogram relevant to the displayed value or data
6. Status bar active pictogram
7. Messages or available menus

**Selecting a menu**

Menus are placed in a cascade arrangement. Use the Driver Information Display (DID) keyboard to scroll through them.

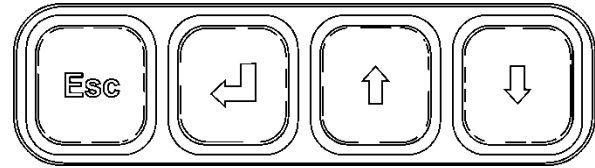

To select a menu:

1. Press the or **ESC** button to display the list of available menus.
2. Use the / button to scroll up or down through the menus.
3. Use the button to open a menu.
4. Use the **ESC** button to return to the previous menu or display or to cancel a setting or operation.

**To change settings**

To change a setting, like the clock, for example:

5. Use the / button to increase or decrease the numerical value of the selected field.
6. Use the button to confirm your choice and to move to the next field.
7. Press the **ESC** button to return to the previous field or to cancel a setting or operation.

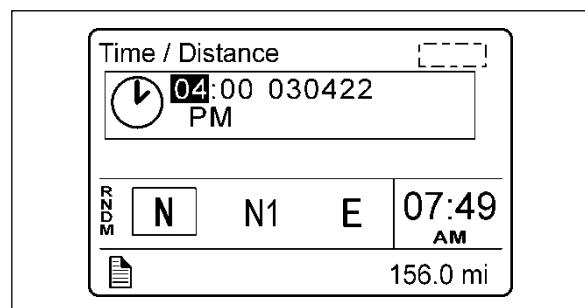





























**PICTOGRAMS AVAILABLE ON THE DRIVER INFORMATION DISPLAY (DID)**



**NOTE**  
*In certain situations, the pictogram displayed represents a system or a function of the vehicle. A particular pictogram may be displayed with different messages. In that situation, it is very important to pay attention to the message displayed with the pictogram.*





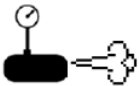

**Warning pictograms, pop-up message pictograms, verifications and information pictograms**

DRIVER INFORMATION DISPLAY GAGE MENU PICTOGRAMS	
Pictogram	Description
	<b>Date and time</b>
	<b>Outside air temperature</b>
	<b>Icing condition</b> If the exterior temperature is between 32 and 35°F, the outside air temperature pictogram described above is replaced by this popup
	<b>Engine temperature</b>
	<b>Transmission oil temperature</b>
	<b>Accessories air pressure</b> Normal pressure should be between 122 and 140 psi.
	<b>A/C compressor pressure</b> This pictogram is displayed with a/c compressor suction pressure value (low side) and discharge pressure value (high side).
	<b>Battery voltage</b> This pictogram is displayed with both the 12-volt and 24-volt electrical system current voltage value. When the engine is running, the 24-volt electrical system voltage value should be between 26,5 and 28,0 volts.
	<b>Battery state of charge</b>

POP-UP MESSAGES	
Pictogram	Description
	<b>High coolant temperature</b>
	<b>High engine oil temperature</b>
<b>CHECK ENGINE COOLANT LEVEL AT NEXT STOP</b>	<b>Low engine coolant level</b> Warns the driver that the engine coolant level has reached the <b>recovery tank</b> low level switch. Add coolant whenever possible.
<b>ENGINE COOLANT LEVEL CRITICALLY LOW</b>	<b>Critically low coolant level</b> Warns the driver that the engine coolant level has reached the <b>surge tank</b> low level switch. Stop and add coolant.
	<b>Low Engine oil pressure</b>
	<b>Low accessories air pressure</b> Low air in interlock brake system. Normal pressure should be between 122 and 144 psi.
	<b>A/C Fail</b>
	<b>Wait to start</b> This pictogram illuminates at any instance of starter lockout.
	<b>Low brake or ABS air pressure</b> This pictogram indicates that the air pressure value measured by the gages of the front and/or rear brakes is low.
	<b>Engine door ajar</b> This pictogram indicates that the engine compartment door is ajar.
	<b>Upper WCL door open</b> This pictogram indicates that the upper wheelchair lift is open or unlocked.
	<b>Lower or small WCL door open</b> This pictogram indicates that the lower or small wheelchair lift is open or unlocked.

	<p><b>Wheelchair lift</b></p> <p>This pictogram indicates that the wheelchair lift system is enabled and the wheelchair access door or the lift compartment door is open. It is necessary to stow the wheelchair lift, close the doors and set the wheelchair lift system enable switch to the off position to permit release of the parking brake or kneel the vehicle.</p>
	<p><b>Parking brake applied</b></p>
	<p><b>Remove parking brake</b></p> <p>These two pictograms are displayed if the driver tries to move or accelerate the vehicle with the parking brake applied.</p>
	<p><b>Tag axle lifted with vehicle speed &gt; 12 mph</b></p> <p>This pictogram appears if the vehicle speed exceeds 12 mph (20 km/h) while the tag axle is raised.</p>
	<p><b>Suspension Level Low With Vehicle Speed &gt; 12 mph</b></p> <p>This pictogram and message appear if the vehicle speed exceeds 12 mph (20 km/h) while the front suspension of the vehicle (kneeling) is lowered.</p>
	<p><b>Cooling fans low voltage</b></p> <p>This pictogram indicates that battery voltage is too low for a proper fan operation.</p>
	<p><b>TCS Status Icon</b></p> <p>This pictogram indicates that the traction control system is active. It is displayed in conjunction with the ESC telltale.</p>
	<p><b>Soot level critically high</b></p> <p>This pictogram indicates that the soot level in the diesel particulate filter is critically high or unidentifiable.</p>
<p>ENGINE COOLANT LEVEL CRITICALLY LOW</p>	<p><b>Critically low coolant level</b></p>
<p>DOOR POWER FAILURE</p>	<p><b>Door power failure</b></p> <p>This popup indicates that there is no power at the door control module or at one of the door solenoids</p>
<p>CHARGING SYSTEM MALFUNCTION</p>	<p><b>Charging system</b></p> <p>This popup appears in conjunction with the battery telltale if neither alternator is charging</p>
<p>REDUCE SPEED TO OPEN DOOR</p>	<p><b>Speed Switch</b></p> <p>This message will appear if the driver pushes door open button and vehicle speed is greater than 2 mph. It is a message to the driver to slow down in order to open the door.'</p>
<p>DOOR INTERLOCK FAILED TO DISABLE THE ACCELERATOR PEDAL (THROTTLE)</p>	<p><b>Throttle malfunction</b></p> <p>This popup indicates that the door interlock failed to disable the accelerator pedal</p>

	<p><b>Fire in engine compartment</b></p> <p>This pictogram appears if a fire is detected in the engine compartment while the vehicle is on the road. A distinctive alarm informs the driver when a fire is detected. In case of fire detection when parked (parking brake applied, engine running or not), the electric horn is activated to alert the driver. Refer to <i>Safety Features And Equipment</i> section.</p> <div style="border: 1px solid black; background-color: #cccccc; padding: 5px; margin-bottom: 5px;">  <p><b>WARNING</b></p> </div> <p>In case of a fire, stop the vehicle immediately, stop the engine and evacuate the vehicle.</p> <div style="border: 1px solid black; padding: 5px; margin-bottom: 5px;"> <p><b>NOTE</b></p> <p><i>It is possible to cancel an alarm while on the road. To do so, stop the vehicle. Cycle the ignition between the ON and OFF position and then start the vehicle normally. This can be done on a temporary basis when a false alarm is activated by a defective fire detector. The driver can go on without being annoyed by the alarm.</i></p> </div> <div style="border: 1px solid black; padding: 5px; margin-bottom: 5px;"> <p><b>NOTE</b></p> <p><i>To stop the electric horn alarm when parked, cycle the ignition between the ON and OFF position twice within 3 seconds.</i></p> </div> <div style="border: 1px solid black; padding: 5px;"> <p><b>NOTE</b></p> <p><i>For extinguisher's location, refer to SAFETY FEATURES AND EQUIPMENT section.</i></p> </div>
	<p><b>Compressor/air dryer fault</b></p> <p>This pictogram indicates that a risk of water in the pneumatic system has been detected due to a compressor or air dryer related problem. Possible causes are:</p> <ul style="list-style-type: none"> <li>• Compressor is used at an unusual (high) rate.</li> </ul> <p>A fault with the air system has been detected.</p>
	<p><b>Air leakage</b></p> <p>This pictogram indicates that an air leak has been detected in the pneumatic system.</p>

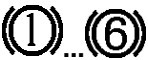
Status Line Pictograms	
Pictogram	Description
	<b>Raised tag axle</b>
	<b>DPF Regeneration inhibited</b> Confirms that IVN regeneration inhibit function is active because the vehicle is inside of a geofence. When flashing, this pictogram indicates an IVN issue inhibiting regeneration as well.
<b>TEST</b>	<b>Test mode</b> Indicate that the vehicle test mode has been initiated manually.
	<b>Entrance door interlock</b> Confirms that the entrance door interlock is enabled.
	<b>Entrance door interlock disabled</b> Indicates that the entrance door interlock is disabled through the use of the entrance door interlock cancel switch or the master interlock switch.
	<b>Kneeling/front suspension active</b> Indicates that the front suspension is lowered (kneeling).
	<b>Allison transmission retarder</b> Confirms that the Allison transmission retarder is OFF.
	<b>Allison transmission retarder – braking level 0, 1, 2, 3, 4, 5, 6</b> Indicate the retarder level. Refer to “Transmission Retarder” heading in this section.

**HORN**

The electric horn is operated from the steering wheel center pad or from the foot-operated switch.

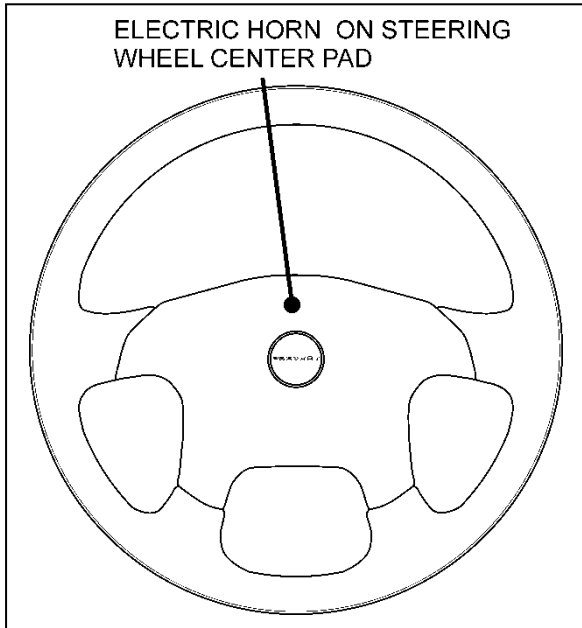

STEERING WHEEL

**NOTE**

*When the vehicle is stationary, the electric horn will sound to inform the driver that a fire is detected in the engine compartment.*

**FOOT-OPERATED CONTROLS**

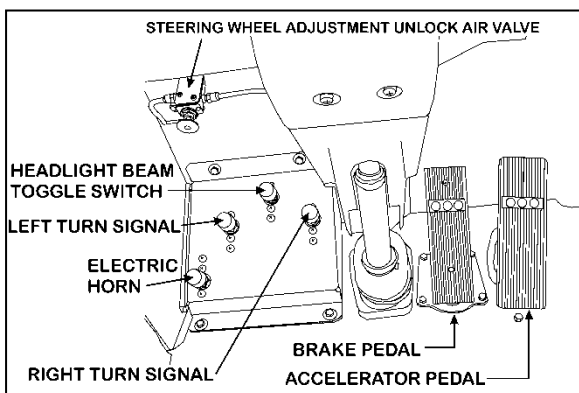

FOOT-OPERATED CONTROLS

00023A

**HEADLIGHT BEAM TOGGLE SWITCH**

Toggle between high and low beams by pressing the foot-operated switch.

**LEFT TURN SIGNAL SWITCH**

Press the foot-operated switch to signal a left turn. Pressing and quickly releasing the button will cause the turn signal to cycle ten times by itself.

**RIGHT TURN SIGNAL SWITCH**

Press the foot-operated switch to signal a right turn. Pressing and quickly releasing the button will cause the turn signal to cycle ten times by itself.

**NOTE**

*A quick single push and release on the turn signal switches makes the signal to flash and stop automatically after 10 seconds.*

**ELECTRIC HORN**

Press the foot-operated switch to activate the electric horn (city horn).

**BRAKE PEDAL**

The vehicle is equipped with a dual braking system. The front brakes operate from a different air pressure source from the drive and tag axle brakes.

Service brakes are applied by depressing the brake pedal. Braking increases with the amount of pressure applied to the foot pedal.

A warning LED and an audible alert will sound when the air pressure in either the primary or secondary circuit drops. If this occurs, stop the vehicle; determine the cause of the pressure loss before proceeding.

The brake pedal can be used in conjunction with the transmission retarder.

 **DANGER**

Immediately report any brake system problem to your company or directly to the nearest Prevost or Prevost-approved service center.

Do not "fan" or "pump" the brake pedal. This practice does not increase brake system effectiveness but rather reduces system air pressure thereby causing reduced braking effectiveness.

 **CAUTION**

"Riding" the brake by resting one's foot on the brake pedal when not braking can cause abnormally high brake temperature, can damage and cause premature wear of brake components and reduce brake effectiveness.

**ACCELERATOR PEDAL**

Controls engine RPM as needed.

**NOTE**

*The accelerator pedal will not operate when the entrance door is open.*

**ALLISON AUTOMATIC TRANSMISSION**

The transmission is fully automatic: Proper ranges should be automatically selected according to driving speeds to improve vehicle performance and control. The speed ratio of the power converter changes automatically as vehicle speed increases and direct-drive goes in and out as necessary. The speed ratio is modulated by vehicle speed and accelerator pedal position. You will find the complete transmission operation instructions and driving tips in the **Allison 5<sup>th</sup> Generation Bus Series Operator's Manual** included in your vehicle's publication box.

**OPERATION**

When a button is depressed on the transmission control pad, the corresponding letter or number is displayed indicating the transmission is ready to operate in the selected range. If the transmission control module (TCM) detects a serious problem in the transmission, the CHECK telltale lights on the dashboard.

**PUSHBUTTON SHIFT SELECTOR**

The pushbutton shift selector has the following elements:



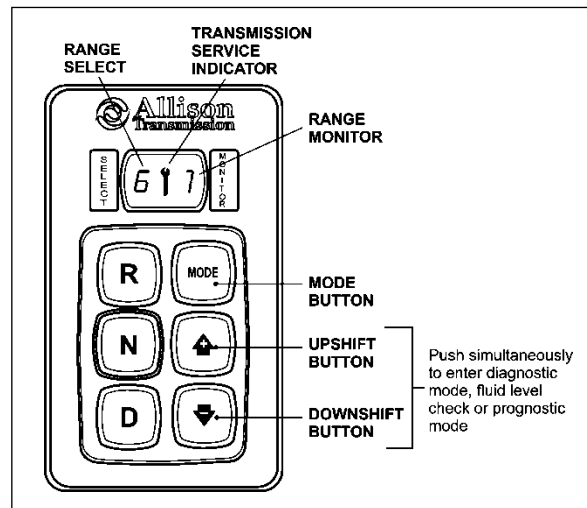

**R:** Press to select Reverse gear.

**N:** Press to select Neutral.

**D:** Press to select Drive. The highest forward range available will appear in the digital display window under SELECT. The transmission will start out in the lowest available forward range, displayed under MONITOR, and advance automatically to the highest range.



ALLISON PUSHBUTTON SHIFT SELECTOR 07142

  : Press respectively the  (Upshift) or  (Downshift) arrow button when in DRIVE to request the next higher or lower range. One press changes gears by one range. If the button is held down, the selection will scroll up or down until the button is released or until the highest or lowest possible range is selected. Protection mechanisms inhibit selecting ranges that are not appropriate for the current speed or which may damage driveline components.

**MODE:** Pressing the MODE button allows the driver to select the secondary shift mode that has been programed into the TCM unit.

**NOTE**

*When the diagnostic display mode has been entered, the MODE button is used to view and toggle through diagnostic code information. Refer to appendix B for more details about **diagnostic code display procedure** and **fluid level check** using the push button shift selector.*

**PRIMARY AND SECONDARY SHIFT MODES**

In the **primary shift mode** which is the default mode at starting of the engine, the transmission controller automatically selects between ECONOMY and SUPER ECONOMY shift schedules, based on the vehicle's actual payload and the grade on which it is operating. This is called Load Based Shift Scheduling (LBSS).

In the **secondary shift mode**, only the SUPER ECONOMY shift schedule (SESS) is available.

## 4-32 CONTROLS AND INSTRUMENTS

No switching is done between shift schedules. The secondary shift mode is available only if selected by the driver, using the MODE button. When the secondary mode is activated, "MODE" illuminates on the display.

### DESCRIPTION OF AVAILABLE RANGES

#### R (Reverse)

Press the «R» button to select reverse. Completely stop the vehicle and let the engine return to idle before shifting from forward range «D» to reverse «R» or from reverse to forward range. The reverse warning signal will be activated when this range is selected.

#### N (Neutral)

Use this position to start the engine. Select «N» (Neutral) when checking vehicle accessories and for extended periods of engine idle operation; parking brake must then be applied. *The push button shift selector automatically selects «N» (Neutral) when the ignition switch is turned ON.*

#### NOTE

*The automatic transmission does not have a park «P» position. Select «N» (Neutral) and apply parking brake when the vehicle is left unattended. An audible alert will sound if the engine is stopped and the parking brake is not applied.*



#### WARNING

Before leaving the driver seat, always put the transmission in NEUTRAL and apply parking brake.



#### WARNING

The vehicle service brake or park brake must be applied whenever NEUTRAL is selected to prevent unexpected vehicle movement.



#### CAUTION

Diesel engines should not be idled for extended periods at "slow" idle. For extended idling, engine should run to "fast" idle.



#### CAUTION

Do not allow your vehicle to "coast" in neutral «N». This practice can result in transmission damage. Also, no engine braking is available in neutral.

#### D (Drive)

Use this position for all normal driving conditions. After touching this pad, the vehicle will start in first or second range and will automatically upshift to a higher range as output speed increases. As the vehicle slows down, output speed decreases, the transmission automatically downshifts to the correct range. If a locked brake or a slick surface condition should occur, the TCM (Transmission Control Module) will command converter operation (disconnect lockup) and inhibit downshifts for a period of time or until normal wheel speed has been restored.

#### IMPORTANT NOTE

*Brake pedal must be applied when selecting «D» (Drive) otherwise the transmission will stay in «N» (Neutral).*

#### NOTE

*The transmission should normally be allowed to shift by itself, but manual shifting can be done as described below.*

#### 1 (First range)

Select this range when pulling through mud and snow, when speed control is needed for driving up or down steep grades or when maneuvering in tight spaces. This range also provides maximum driving torque and engine braking power or retarder braking effect. In the lower ranges (1, 2, 3 and 4), the transmission will not upshift above the highest gear selected unless engine overspeed is detected.

#### 2 (Second range)

Select this range when operating in heavy and congested traffic. The transmission will start in first and automatically upshift to second. When slowing, the transmission will automatically downshift to first range. Low ranges provide progressively greater engine and retarder braking power (the lower the range, the greater the engine and retarder braking effect).

#### 3, 4 (Third and fourth ranges)



Select these ranges when driving on moderate grades or when load and traffic conditions limit speed.

**WARNING**

Service brake should not be used to control the speed of vehicle on long, steep descents. Instead, lower transmission ranges should be used (in conjunction with output retarder. Refer to "Engine Brake" and "Transmission Retarder" headings in Section 5 *Other Features* for details regarding both systems. This procedure keeps service brake cool and ready for emergency stopping.

**CAUTION**

When descending in lower ranges, care must be taken that engine speed does not exceed 2,450 rpm.

