

PREVOST

Instruction Sheet

IS-95073

Date: **May 1995**
 Section: **22**
 Subject: **CENTRAL HEATING SYSTEM PUMP REPLACEMENT**
(Prévost number 871052)

Application:

Model	VIN
H3-40 Coach *	2P9H33404R1001035 up to 2P9H33402R1001079 incl.
H3-41 Coach *	2P9H33417S1001058 up to 2P9H33411S1001153 incl.
H3-45 Coach *	2P9H33492R1001047 up to 2P9H33497R1001092 inclusively and 2P9H33491S1001093 up to 2P9H33496S1001154 incl.
H3-45 VIP converted coach shell *	2P9V33494S1001057 up to 2P9V33499S1001152 incl.
XL-40 Coach *	2P9L33405R1001894 up to 2P9L33409R1001994 incl. and 2P9L33408S1001409 up to 2P9L33405S1001495 incl.
XL-45 Coach *	2P9L33490S1001497

* Effective only if vehicle is equipped with central heating system.

MATERIAL

The repair kit (Prévost number **871073**) includes the following parts.

Note: The repair kit does not include the pump body (12, Fig. 1) and the pump cover (2, Fig. 1).

Part No. Fig. 1	No. pièce	Description	Qty.
1	---	SCREW AND WASHER ASS'Y	8
3	---	GASKET	1
4	---	IMPELLER	1
5	---	SEAL ASS'Y AND BEARING	1
6	---	CASEBOLT 10-32X5	2
7	---	10-32 HEX NUT	2
8	---	LOCK WASHER	2
9	---	SLINGER	1
10	---	ARMATURE ADAPTER ASS'Y	1
11	---	STATOR	1
13	---	DRAIN PLUG - 1/8" NPT BRASS	1
14	---	END FRAME ASS'Y	1
15	---	BRUSH ASS'Y	2
16	---	CAP (BRUSH HOLDER)	2
	FI-95073	FEUILLE D'INSTRUCTIONS	1
	IS-95073	INSTRUCTION SHEET	1

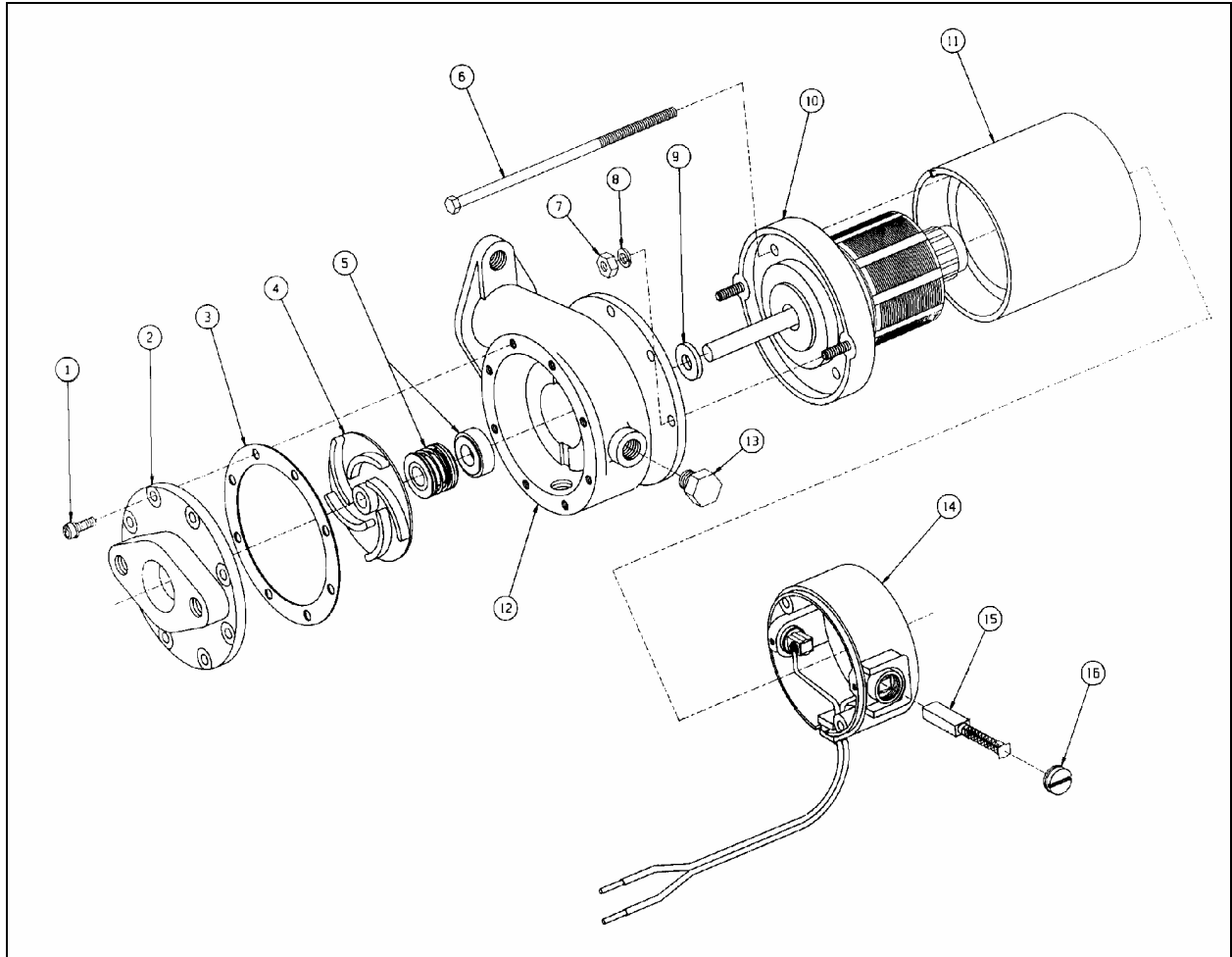

FIGURE 1: PUMP

22056

DESCRIPTION

It is possible that a casebolt on central heating system pump might have been tightened to 5 lbf-in instead of 15 lbf-in. Identify defective pump by turning the end frame assembly. At 5 lbf-in torque, the end frame moves according to a "ratchet" effect. If end frame has caused damage to pump parts, replace damaged parts according to following procedures.

PUMP REMOVAL

Warning: Park vehicle safely, apply parking brake, stop engine and set battery master switch(es) to the OFF position prior to working on the vehicle.

1. Allow engine coolant to cool. Remove surge tank pressure cap to decrease pressure in system.
2. Close both coolant shutoff valves.

On XL-40 coach, the valves are located in engine compartment. One is on the R.H. side of compartment and is accessible through engine compartment R.H. side door (Fig. 2).

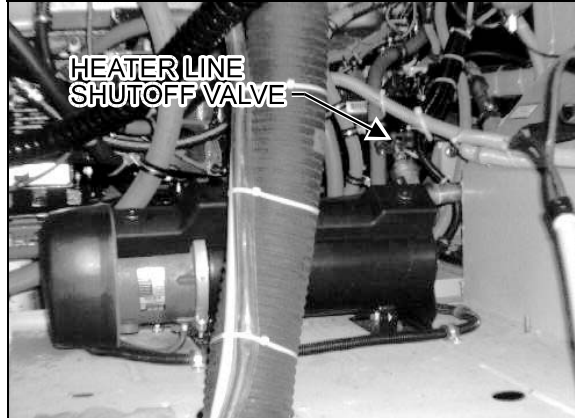

FIGURE 2: ENGINE COMPARTMENT R.H. SIDE DOOR 05039

The other is located on the L.H. side of engine underneath the fan gearbox and is accessible through the engine compartment rear doors (Fig. 3).

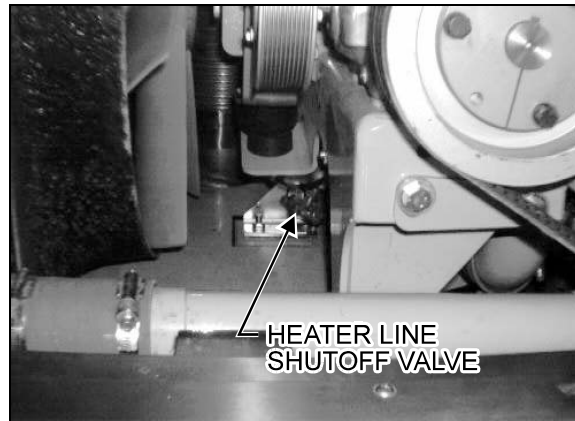

FIGURE 3: ENGINE COMPARTMENT - REAR DOORS 05040

On XL-45 coach, the valves are located in engine compartment, on the L.H. side of engine and are accessible through L.H. side rear service compartment (Fig. 4).

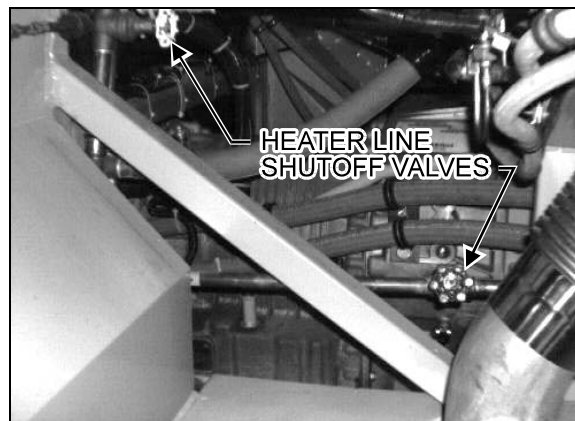
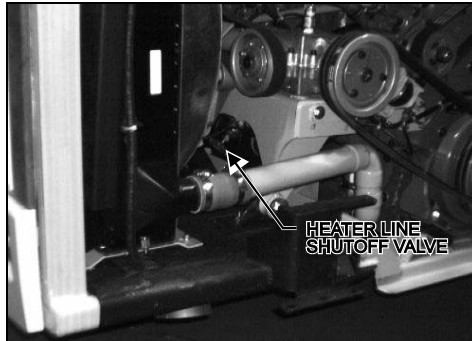
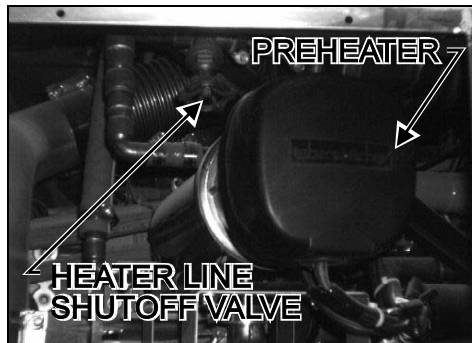

FIGURE 4: ENGINE COMPARTMENT
- L.H. SIDE REAR SERVICE COMPARTMENT

H3 vehicles. One of the heater line shutoff valves is located in the engine compartment under the radiator fan gearbox (Fig. 5). The other heater line shutoff valve is located in the L.H. rear electric compartment (near the preheater, Fig. 6). To gain access to the heater line shutoff valve, remove the preheater access panel screws. Remove the panel (Fig. 7).



05025
FIGURE 5: ENGINE COMPARTMENT - REAR DOOR



05026
FIGURE 6: REAR ELECTRIC COMPARTMENT

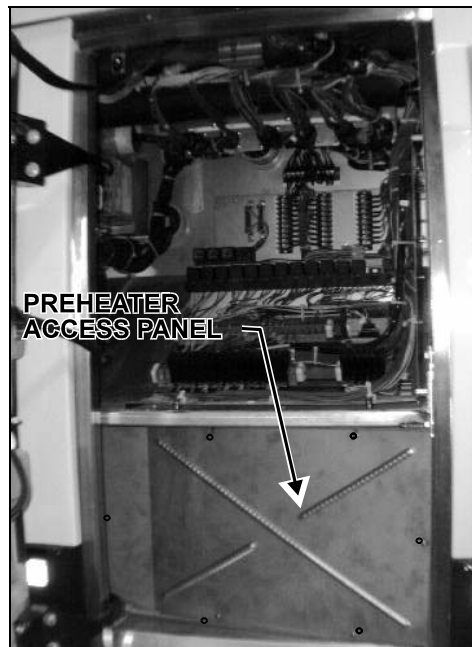

22058
FIGURE 7: REAR ELECTRIC COMPARTMENT

-
3. Disconnect the electric wiring from the motor.

Warning: Before proceeding with the following steps, make sure the coolant has cooled down. The sudden release of pressure from a heated cooling system can result in loss of coolant and possible personal injury (scalding) from the hot liquid.

4. **XL Coach (Fig. 8) and H3 (Fig. 9) vehicles, with central heating system.** Remove the drain plug at rear of pump and place a container to recover the residual coolant in the line.

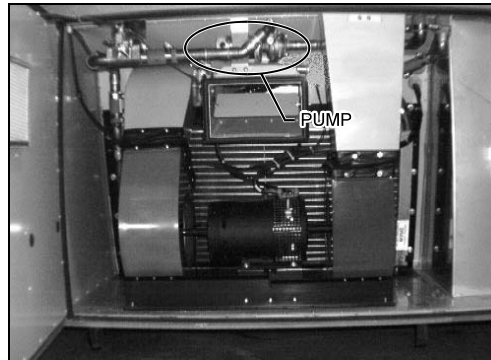

22088

**FIGURE 8: HVAC COMPARTMENT
- XL COACH WITH CENTRAL HEATING SYSTEM**

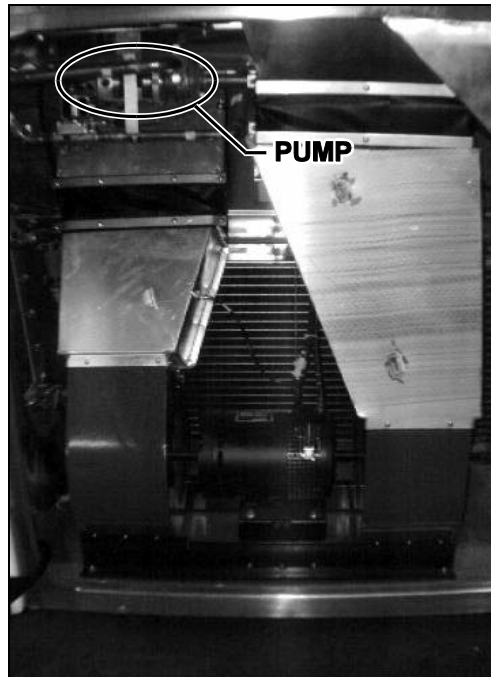

22093

**FIGURE 9: HVAC COMPARTMENT
H3 VEHICLES WITH CENTRAL HEATING SYSTEM**

5. **XL Coach and H3 vehicles, with central heating system.** Disconnect water lines from pump body connections.
6. Remove the clamp holding the copper pipe with the coolant strainer. Remove the two clamps holding the pump motor to its mounting bracket. Remove the pump with the motor as an assembly.

DISASSEMBLY

1. Remove two brush caps (16, Fig. 1) and two brush assemblies (15, Fig. 1). When removing brushes, note the position of the brush in the tube. Brush life is significantly decreased if brushes are not replaced properly.
2. Remove the pump cover (2, Fig. 1) by first removing the 8 head screws. Remove cover carefully to prevent damaging the gasket (3, Fig. 1).
3. Remove gasket (3, Fig. 1).
4. Remove two hex nuts and lock washers (7 & 8, Fig. 1) retaining pump assembly to motor.
5. Remove the pump from the motor as follows:
 - a. Install puller tool assembly (MP Co. Part No. 24702 or equivalent) to pump body (12, Fig. 1) and using four screws, remove from the pump cover (2, Fig. 1).
 - b. Tighten the puller screw to press the motor shaft out of the impeller hub. The pump is now free from the motor.
 - c. Remove the puller tool.
6. Remove impeller (4, Fig. 1) and components of the pump seal assembly (5, Fig. 1).

ASSEMBLY

1. Install slinger (9, Fig. 1) on the motor shaft.
2. Assemble body (12, Fig. 1) to the motor.
3. Install seal ass'y (5, Fig. 1).
4. Install impeller (4, Fig. 1) in the following manner:
 - a. Place the impeller on a flat surface with the vanes against the flat surface.
 - b. Invert the motor and pump body assembly, then pilot the pump shaft into the impeller bore. **DO NOT HAMMER** on the motor shaft extension at rear of motor.
 - c. Press on motor and pump body until the machined face of the pump body is flush with the face of the flat surface on which the impeller is resting. The face of the impeller vanes must now be flush with the machined face of the pump body.
5. Install gasket (3, Fig. 1). This gasket serves both to seal the cover and to establish the proper clearance between the face of the impeller and the pump cover.
6. Attach cover (2, Fig. 1) to the pump body using eight screws and washer ass'y (1, Fig. 1).
7. Install motor brushes assembly (15, Fig. 1) and brush caps (16, Fig. 1).

INSTALLATION

1. Apply gasket cement to the pump body line adapter and to the line flanges, put the two gaskets in place, and connect water lines to the pump at the flange connections. Position the pump and motor assembly on the mounting bracket. Position the mounting clamps over the motor and secure with mounting bolts.
2. Apply pipe sealant on threads of drain plug (13, Fig. 1), and screw it in place.
3. Connect electrical wiring to the pump motor.
4. Open shutoff valve.
5. Fill and bleed the cooling system as instructed in your maintenance manual under "*Filling Heating System*" and "*Bleeding Heating System*".