

## WARRANTY BULLETIN

### WB14-28E

DATE :	OCTOBER 2014	SECTION :	23 - Accessories
EXPIRATION:	OCTOBER 2016		
SUBJECT :	AFSS LINEAR THERMAL DETECTOR (LTD) REPLACEMENT AND RELOCATION OF IR SENSOR		

- REVISION B: THIS WARRANTY BULLETIN SUPERSEDES PREVIOUS VERSION.**  
 Bulletin extended to other US10 X3 coaches not already covered, up to the introduction of the change on production line (ECN2014007). Take note that on this revision "B", the IR sensor is rotated 180° to allow a drip path away from the IR sensor. Consequently, a new part (p/n 564534) is added to the kit. This edge clip will hold the IR sensor cables, preventing rubbing against the 4in OD turbo inlet pipe.
- REVISION C: THIS WARRANTY BULLETIN SUPERSEDES PREVIOUS VERSION.**  
 Bulletin extended to other US10 H3 coaches, up to the introduction of the change on production line (ECN2014007).
- REVISION D: THIS WARRANTY BULLETIN SUPERSEDES PREVIOUS VERSION.**  
 Bulletin extended to US10 XLII-45 Entertainer & US10 X3-45 VIP "Commercial Use", up to the introduction of the change on production line (ECN2014007).
- REVISION E: THIS WARRANTY BULLETIN SUPERSEDES PREVIOUS VERSION.**  
 In Application table, last VIN in H3 range was 2PCH33418EC712688, changed for 2PCH33491FC712751.

### APPLICATION

NOTICE TO SERVICE CENTERS																			
Verify vehicle eligibility by checking warranty bulletin status with <b>SAP</b> or via <b>ONLINE WARRANTY SYSTEM</b> available on Service / Warranty tab of Prevost website.																			
Model	VIN																		
X3-45 coaches Model Year : 2010 - 2014	<div style="text-align: center;">  </div> <p>The following vehicles:</p> <table style="width: 100%; border: none;"> <tr> <td style="width: 33%;">2PCG33498AC729907</td> <td style="width: 33%;">2PCG33499EC735608</td> <td style="width: 33%;">2PCG33494EC735659</td> </tr> <tr> <td>2PCG33498AC729907</td> <td>2PCG33497EC735610</td> <td>2PCG33492EC735661</td> </tr> <tr> <td>2PCG33491AC729926</td> <td>2PCG33499EC735611</td> <td>2PCG33494EC735662</td> </tr> <tr> <td>2PCG33499BC729965</td> <td>2PCG33490EC735612</td> <td>2PCG33498EC735664</td> </tr> <tr> <td>2PCG33491BC729992</td> <td>2PCG33492EC735613</td> <td>2PCG3349XEC735665</td> </tr> <tr> <td>2PCG3349XEC735603</td> <td></td> <td></td> </tr> </table> <p style="text-align: center;">And from            From 2PCG33491BC735002 up to 2PCG3349XEC735598 incl.</p>	2PCG33498AC729907	2PCG33499EC735608	2PCG33494EC735659	2PCG33498AC729907	2PCG33497EC735610	2PCG33492EC735661	2PCG33491AC729926	2PCG33499EC735611	2PCG33494EC735662	2PCG33499BC729965	2PCG33490EC735612	2PCG33498EC735664	2PCG33491BC729992	2PCG33492EC735613	2PCG3349XEC735665	2PCG3349XEC735603		
2PCG33498AC729907	2PCG33499EC735608	2PCG33494EC735659																	
2PCG33498AC729907	2PCG33497EC735610	2PCG33492EC735661																	
2PCG33491AC729926	2PCG33499EC735611	2PCG33494EC735662																	
2PCG33499BC729965	2PCG33490EC735612	2PCG33498EC735664																	
2PCG33491BC729992	2PCG33492EC735613	2PCG3349XEC735665																	
2PCG3349XEC735603																			
XLII-45 Entertainer, X3-45 VIP commercial use Model Year : 2010 - 2014	From 2PCY33498BC735003 up to 2PCCS3490EC735708 incl.																		
H3-41, H3-45 coaches Model Year : 2010 - 2014	<p>The following vehicles:</p> <table style="width: 100%; border: none;"> <tr> <td style="width: 50%;">2PCH33496AC711605</td> <td style="width: 50%;">2PCH33496AC711636</td> </tr> <tr> <td>2PCH33495AC711627</td> <td>2PCH33499BC711695</td> </tr> </table> <p style="text-align: center;">And from            From 2PCH33498BC711722 up to 2PCH33491FC712751 incl.</p>	2PCH33496AC711605	2PCH33496AC711636	2PCH33495AC711627	2PCH33499BC711695														
2PCH33496AC711605	2PCH33496AC711636																		
2PCH33495AC711627	2PCH33499BC711695																		

This bulletin does not necessarily apply to all the above-mentioned vehicles, some vehicles may have been modified before delivery. The owners of the vehicles affected by this bulletin will be advised by a letter indicating the Vehicle Identification Number (VIN) of each vehicle concerned.

## DESCRIPTION

On the vehicles affected by this bulletin, replace the LTD, relocate and replace the IR sensor as described in the following procedure.

## MATERIAL

X3-45 coaches, XLII Entertainer, X3-45 VIP: order kit "WB14-28" which includes the following parts:

Part No.	Description	Qty
069020	HARNESS, INTERFACE	1
069041	LTD (Linear Thermal Detector)	1
406701	SUPPORT, IR SENSOR	1
563457	SENSOR, INFRARED	1
500321	WASHER, BEL SPR .331x.827x.098 ZG603	1
502851	NUT, HEX M8-1.25 ZG603	1
5001742	SCREW, CAP HEXF M8-1.25x30 G8.8 ZG603	1
561565	SEAL 20-18 g	2
561578	TERMINAL, SOCKET 16-14 g	1
561689	TERMINAL, SOCKET 20-18 g	2
561782	CONNECTOR, SOCKET HOUSING PED WEATHER PACK	1
561786	SEAL 16-14 g	1
563588	TERMINAL, PIN	2
563589	CONNECTOR, SOCKET HOUSING DTM 06-2S	1
563590	CONNECTOR, PIN HOUSING DTM 04-2P PH 2C	1
563604	LOCK, SECONDARY	1
563606	PLUG, SEALING	2
5001017	SCREW, THREAD CUTTING HEX #10-24x1/2	6
564534	EDGE CLIP, CABLE TIE	1
500964	WASHER, FLAT .203 x .500 x .047 ZP	6
504013	TIE MOUNT, ¼ x ¼	6
507664	CABLE TIE, NYLON 3/16" x 11" DOUBLE LOOP HEAD	18
504637	CABLE TIE, NYLON 3/16" x 13"	20
502841	NUT, HEX NYRT M5-0.8 ZG603	2
5001146	SCREW, CAP HEX M5-0.8x20 SS EMN	2

H3 series coaches: order kit "WB14-28-2" which includes the following parts:

Part No.	Description	Qty
069020	HARNESS, INTERFACE	1
069041	LTD (Linear Thermal Detector)	1
217797	SUPPORT, IR SENSOR	1
504379	RIVET POP, DOME SS 3/16" x 1/4"	3
563457	SENSOR, INFRARED	1
502570	WASHER, SPLIT LOCK 6.1 x 11.8 x 1.6	2
5001146	SCREW, CAP HEX M5-0.8x20 SS EMN	2
561565	SEAL 20-18 g	2
561578	TERMINAL, SOCKET 16-14 g	1
561689	TERMINAL, SOCKET 20-18 g	2
561782	CONNECTOR, SOCKET HOUSING PED WEATHER PACK	1
561786	SEAL 16-14 g	1
563588	TERMINAL, PIN	2
563589	CONNECTOR, SOCKET HOUSING DTM 06-2S	1
563590	CONNECTOR, PIN HOUSING DTM 04-2P PH 2C	1
563604	LOCK, SECONDARY	1
563606	PLUG, SEALING	2
507664	CABLE TIE, NYLON 3/16" x 11" DOUBLE LOOP HEAD	18
504637	CABLE TIE, NYLON 3/16" x 13"	20

***NOTE***

*Material can be obtained through regular channels.*



**DANGER**

Park vehicle safely, apply parking brake, stop engine and set battery master switch(es) to the OFF position prior to working on the vehicle.

## PROCEDURE

PART 1 - LTD INSTALLATION GUIDELINES .....	5
PART 2 - PREPARATION .....	7
PART 3 – REMOVAL OF EXISTING IR SENSOR AND SUPPORT .....	10
PART 4 – INSTALLATION OF NEW IR SENSOR (XLII & X3 SERIES).....	11
PART 5 – INSTALLATION OF NEW IR SENSOR (H3 SERIES).....	12
PART 6 – REMOVAL OF EXISTING LTD (Linear Thermal Detector) .....	14
PART 7 – HOOKING UP ON EXISTING HARNESS .....	15
PART 8 – INSTALLATION OF NEW LTD .....	16
PART 9 – ROUTING INTERFACE HARNESS UP TO THE IR SENSOR (XLII & X3 SERIES) .....	19
PART 10 – ROUTING INTERFACE HARNESS UP TO THE IR SENSOR (H3 SERIES).....	23

**PART 1 - LTD INSTALLATION GUIDELINES**

**IMPORTANT: WHEN INSTALLING THE "LTD", THE FOLLOWING GUIDELINES MUST BE FOLLOWED.**

**NOTE**  
Always use double loop cable ties to secure LTD. LTD must be tied alone, with no other cables in the loop.

**NOT ALLOWED**

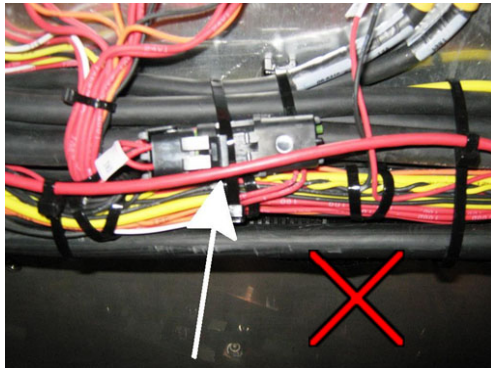

Possible contact or rubbing against screws, edges, etc.

**CORRECT**

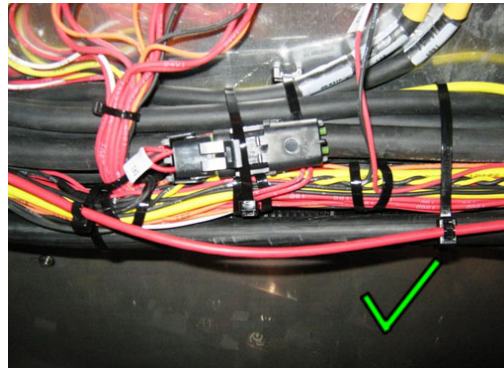

LTD must be routed clear of screws, sharp edges, etc.

**NOT ALLOWED**

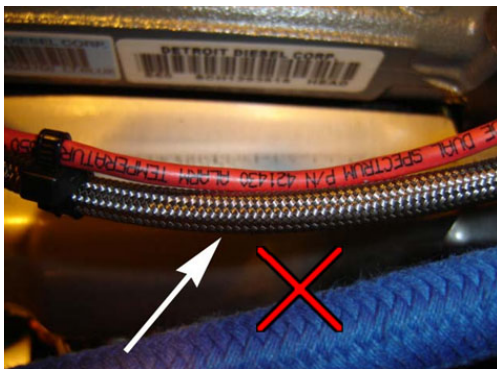

Rubbing or possible rubbing against abrasive surfaces

**CORRECT**

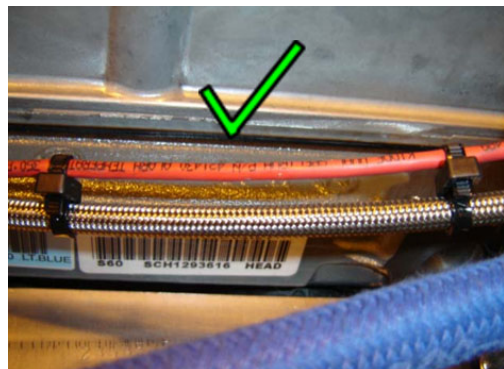

LTD must be secured with double loop cable ties. Distance between cable ties must not exceed 4 inches (100mm) max

**NOT ALLOWED**

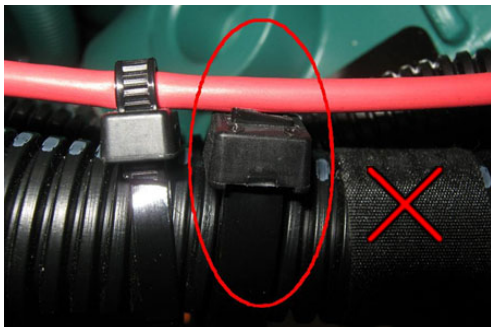

LTD touching cut cable tie

**NOT ALLOWED**

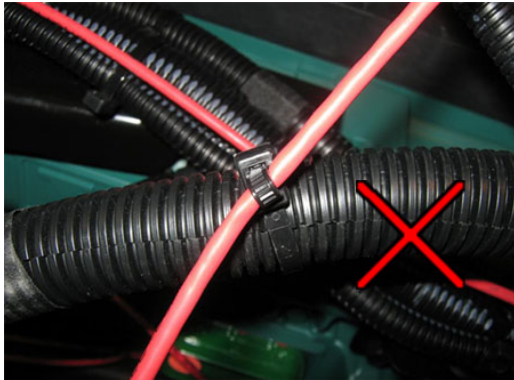

LTD extending slantingly from the cable tie

**CORRECT**

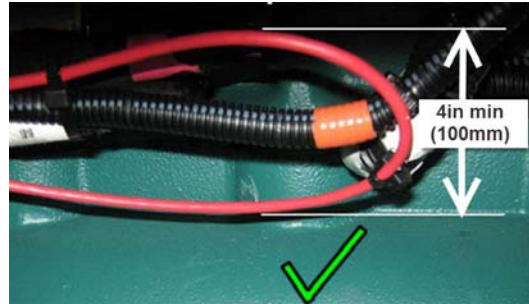

LTD is not a flexible harness. Avoid tight bends and kinks which could short circuit the LTD. Loops must have a minimum radii of 4 inches (100 mm)

**NOT ALLOWED**

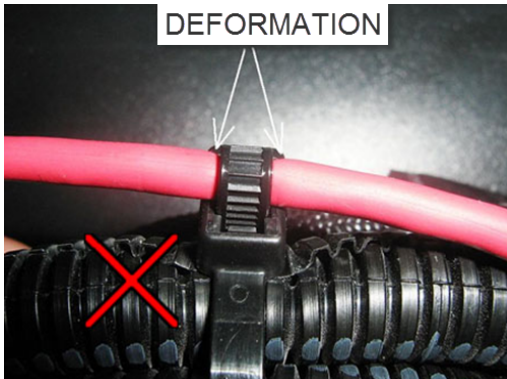

Cable tie tighten in excess on the LTD. Tighten cable tie on LTD by hand only. Tighten just enough to prevent LTD from slipping from once side to the other inside the cable tie loop

**CORRECT**

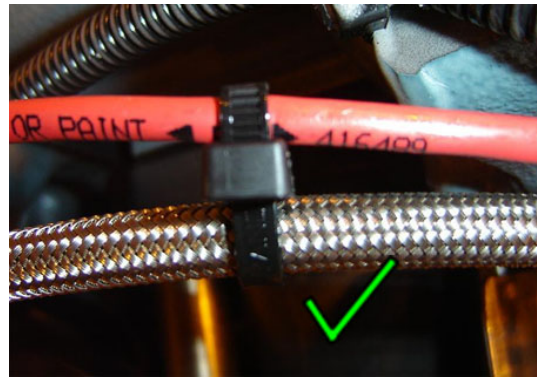

Proper tightening of the cable tie on the LTD

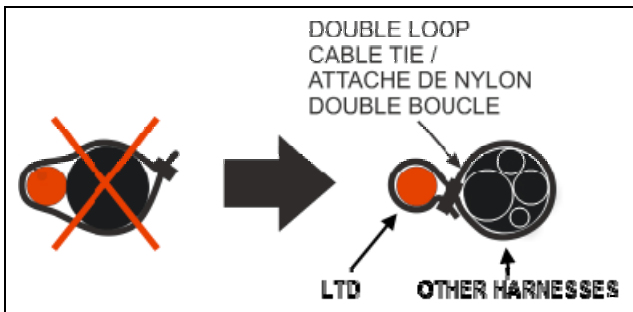

## PART 2 - PREPARATION

- 1) With the battery master switch to the ON position and the ignition switch to the ON position, check that there are no trouble conditions on the AFSS system. Check that the driver's area AFSS protection panel SYSTEM OK green lamp is illuminating. If it is not illuminating, then the TROUBLE lamp should blink or illuminate steady. You must troubleshoot and correct that situation prior proceeding to this bulletin.
- 2) Disconnect the extinguisher bottle connector. If available, plug special device Kidde Valve Simulator (Prevost #685128).

The Valve Simulator is used to simulate the squib and discharging of an extinguisher. It plugs into the wiring harness of the extinguishing circuit and provides an audible warning (chirp) when a signal is received from the control panel to discharge the extinguisher.

Failure to do so may result in extinguisher discharge at time of resetting the system if the LTD is short circuited due to improper manipulations and/or faulty installation.



FIGURE 1

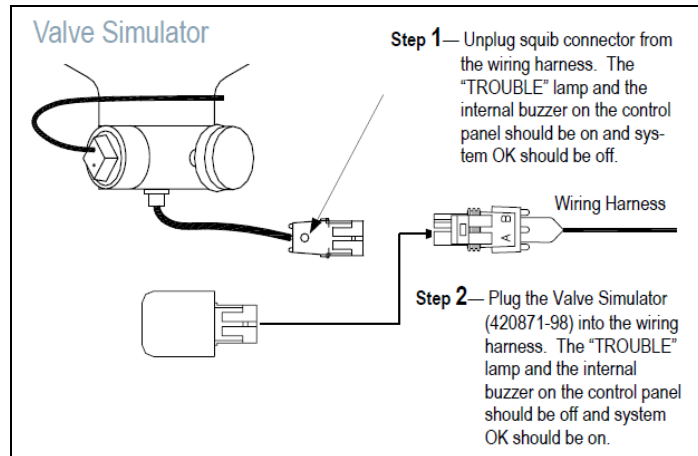

FIGURE 2

- 3) Turn the ignition switch to the OFF position. Set the battery master switch to the OFF position.
- 4) Inside the front electrical compartment, pull fuse F45 to cut electrical supply to the AFSS protection panel (see FIGURE 3).

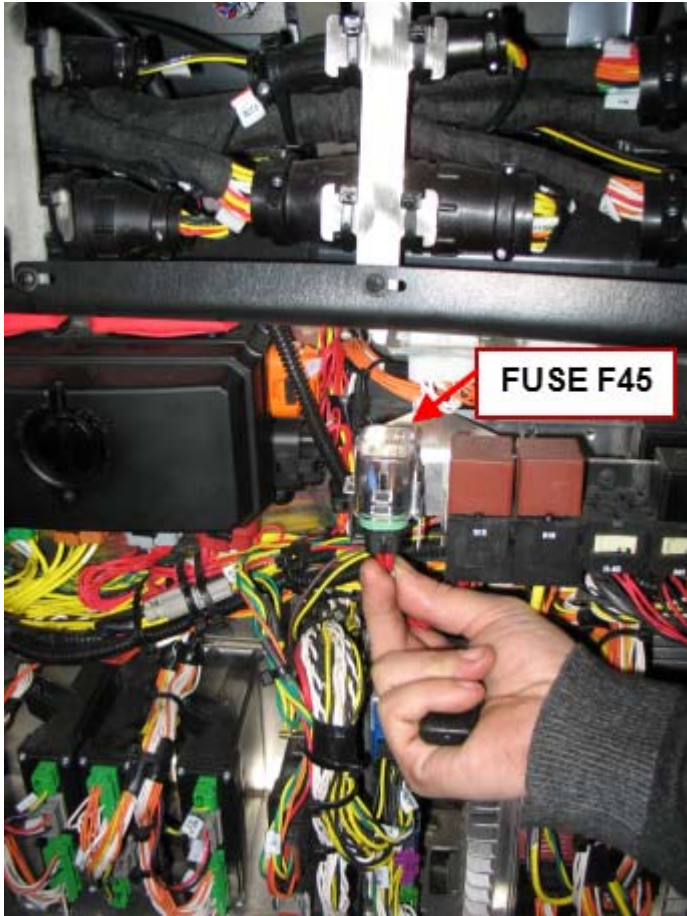

FIGURE 3: FUSE F45 INSIDE FRONT ELECTRICAL COMPARTMENT

- 5) **H3 SERIES:** To ease access to the engine, remove the rectangular access hatch located at the rear end of the passenger's area central aisle.
- 6) **X3 SERIES:** To ease access to the engine, remove the rectangular access hatch (figure 4) located under the rear seats shown on FIGURE 5. To do so, remove the seats, unscrew one nut each side of the seat cushions (FIGURE 6) and remove the seat cushions (use 10mm socket). Then, unscrews the four seat frame mounting bolts, use 17mm socket (FIGURE 7).



FIGURE 4

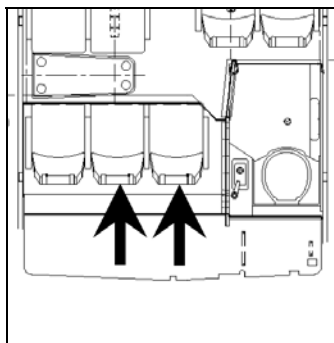

FIGURE 5





FIGURE 6 (X3 SERIES ONLY)



FIGURE 7 (X3 SERIES ONLY)



FIGURE 8 (X3 SERIES SHOWN)



FIGURE 9: REMOVE SPLASH GUARD SHOWN

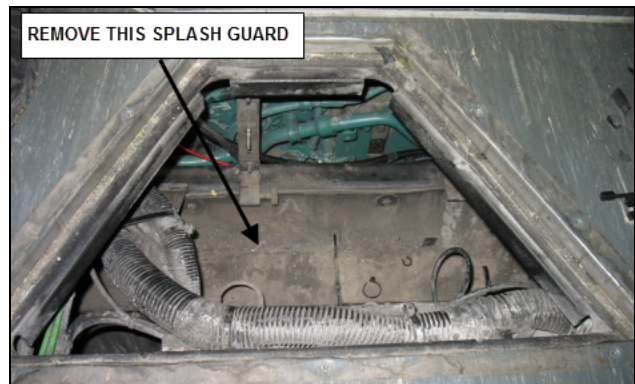

FIGURE 10: REMOVE SPLASH GUARD SHOWN

- 7) **X3 SERIES:** Remove the trapezoidal access hatch located at the rear of the passengers' area (FIGURE 8).
- 8) If applicable, remove the splash guard (see FIGURE 9, may differ on H3 series). To do so, unscrew one nut (use 10mm socket).
- 9) If applicable, remove the other splash guard (FIGURE 10, may differ on H3 series). To do so, remove 4 screws (use 10mm socket).

### PART 3 – REMOVAL OF EXISTING IR SENSOR AND SUPPORT

- 1) Locate the IR sensor and support above the turbo (FIGURE 11).
- 2) Disconnect A131A & A131B at the IR sensor (A, FIGURE 12).
- 3) Cut the nylon cable ties along the support and cut the nylon cable ties securing the engine compartment light cable up to the light (B, FIGURE 12).

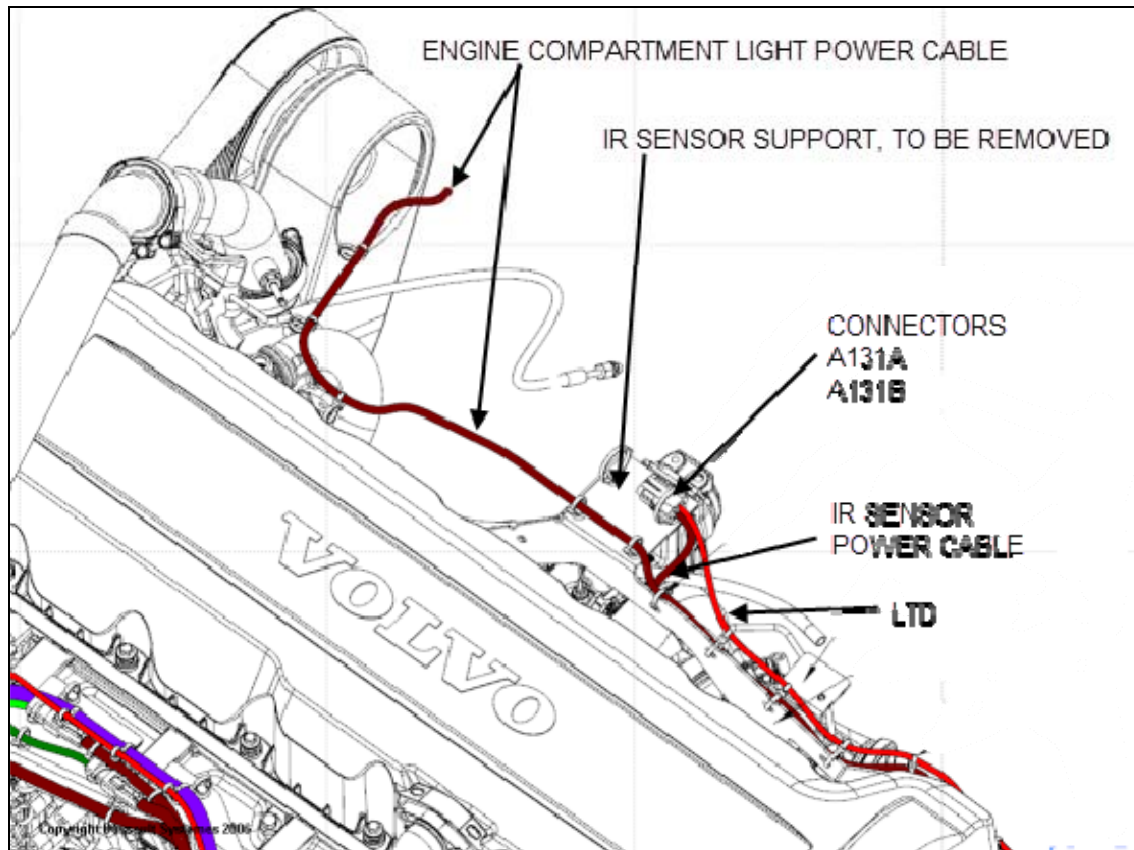

FIGURE 11: IDENTIFICATION OF COMPONENTS AND HARNESSSES

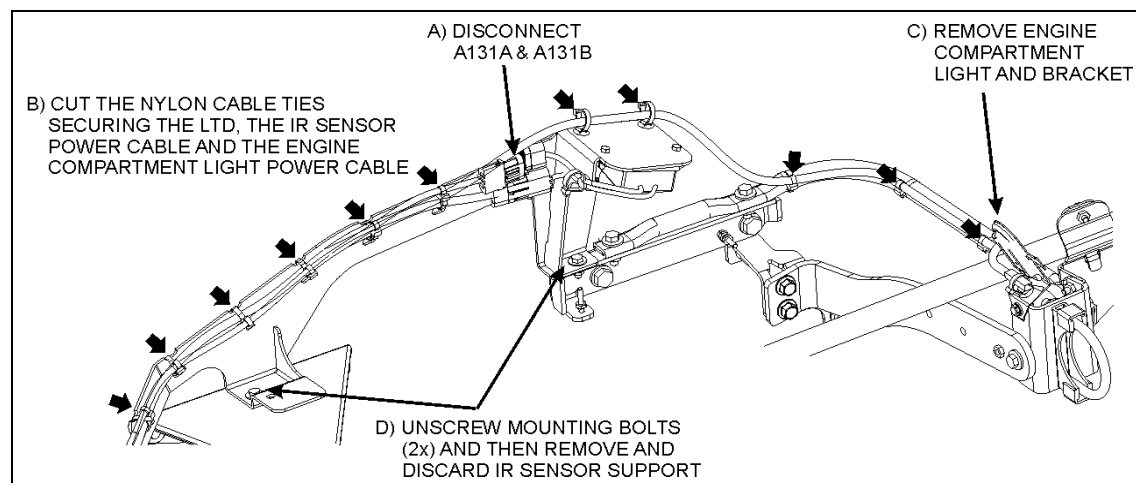

FIGURE 12

- 4) Remove and discard the engine compartment light and bracket (C, FIGURE 12).
- 5) Remove and discard the IR sensor support (D, FIGURE 12).



## CAUTION

**Do not reuse** the old IR sensor as it may fail prematurely and offer no protection.

### PART 4 – INSTALLATION OF NEW IR SENSOR (XLII & X3 SERIES)

- 1) Unscrew the bolt at the turbo inlet pipe support bracket (FIGURE 13).
- 2) Mount the new IR sensor onto the new support #406701 (FIGURE 14). Install IR sensor and support assembly onto turbo inlet pipe support bracket as per FIGURE 13. Take note that the sensor cables must be placed on the exterior side of the engine compartment.

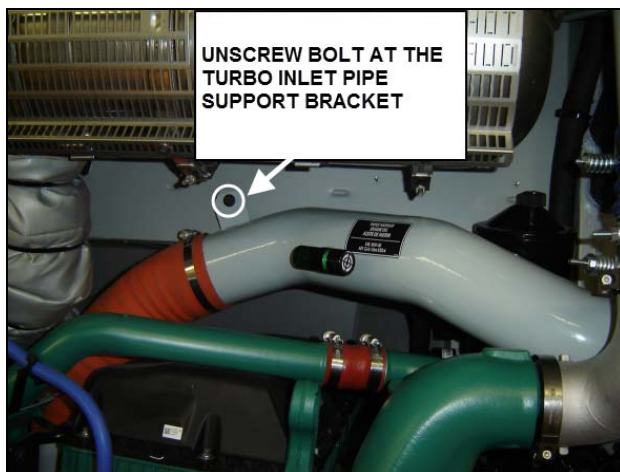

FIGURE 13

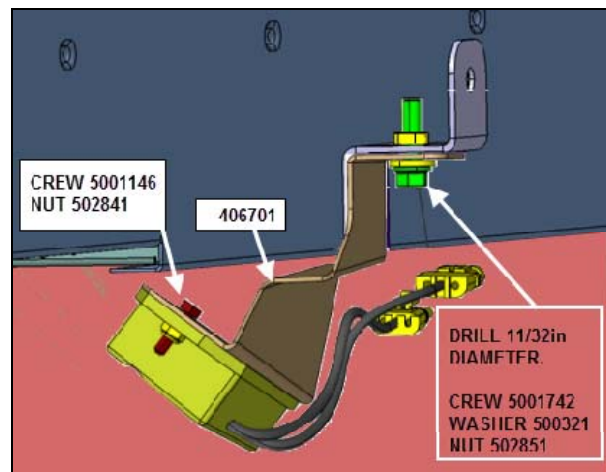

FIGURE 14

**PART 5 – INSTALLATION OF NEW IR SENSOR (H3 SERIES)**

- 1) Install the new IR sensor at new location as shown on FIGURE 15. The IR sensor will be installed on the stainless steel panel on top of the engine.

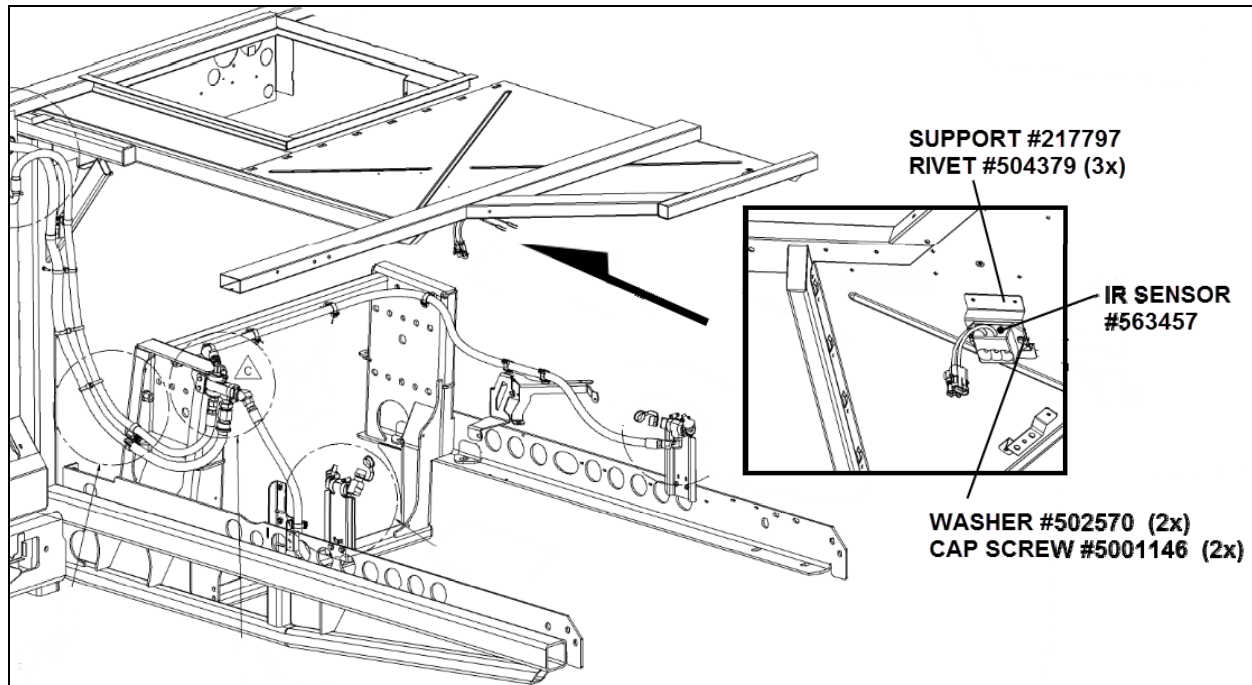

FIGURE 15

- 2) First, install support #217797 as shown on FIGURE 16. Locate the support according to measurements of FIGURE 17.
- 3) Pre-drill three 7/32" holes for the installation of the support. Secure support using three pop rivets #504379.

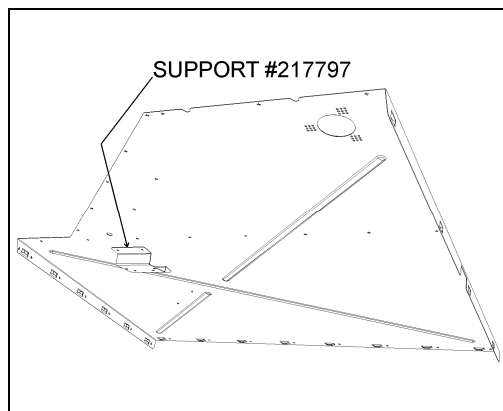

FIGURE 16

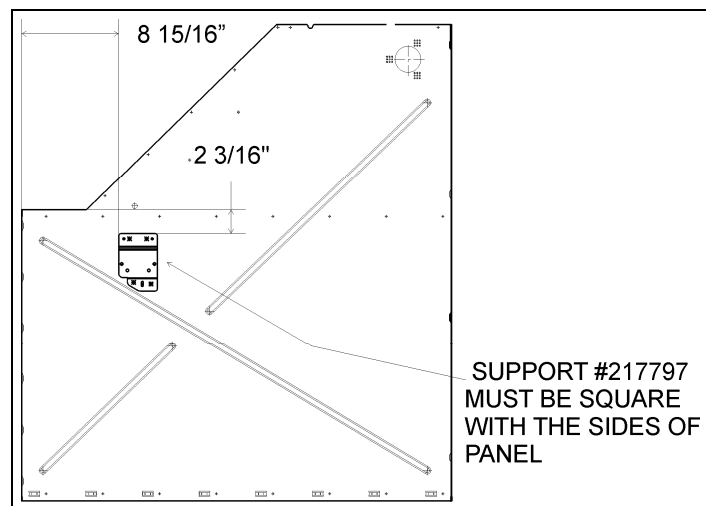

FIGURE 17

- 4) Fix IR sensor onto support as shown on FIGURE 18, using two split lock washers #502570 and two cap screws #5001146. IR sensor must be oriented so that the cables exiting the sensor body are located aft of the engine compartment.



FIGURE 18

**PART 6 – REMOVAL OF EXISTING LTD (Linear Thermal Detector)**

- 1) Cut all nylon cable ties and remove the entire LTD (cable with red sheath). On the engine hot side, the LTD may be routed under the starter and forms a loop and then comes back and runs to the cold side of the engine (FIGURE 19). On the cold side, the LTD is routed as shown on FIGURE 20. Keep the termination (a.k.a. EOL End of Line device) connector found at the end of the LTD for reused.

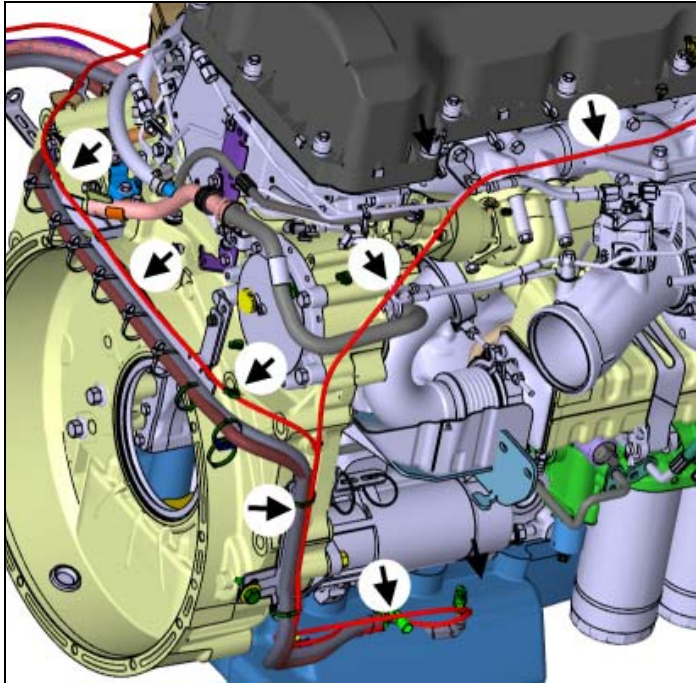

**FIGURE 19: REMOVE LTD**

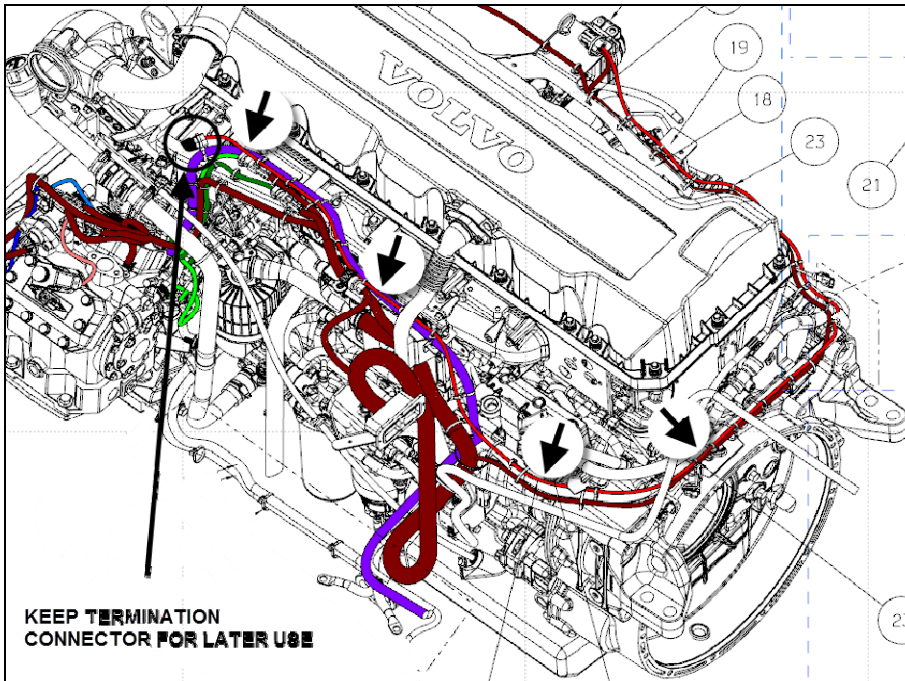

**FIGURE 20: REMOVE LTD. KEEP TERMINATION CONNECTOR (A.K.A. EOL)**

**PART 7 – HOOKING UP ON EXISTING HARNESS**

- 1) The engine compartment light power cable and the IR sensor power cable are joined together in one single harness. Locate this harness and cut it close to the bracket shown on FIGURE 21. Discard the section of this harness that runs on the turbo side.

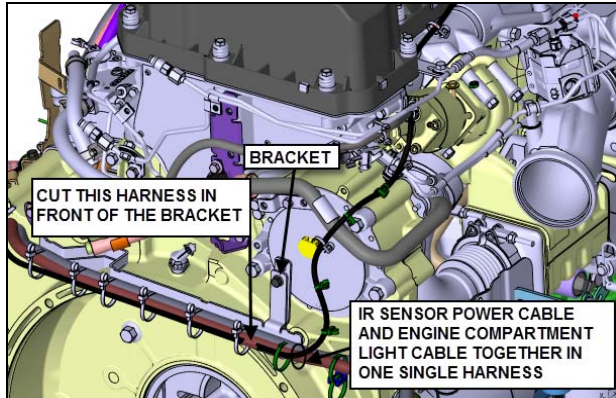

FIGURE 21: CUT THE HARNESS CLOSE TO THE BRACKET

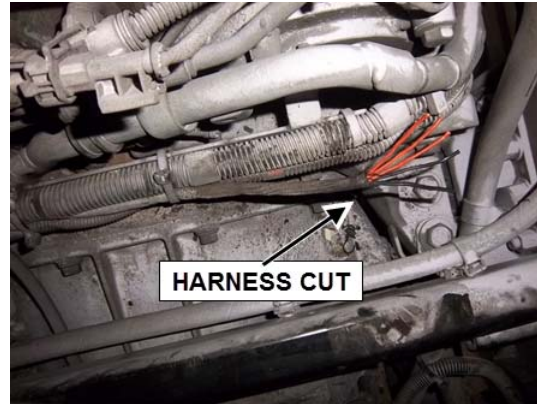

FIGURE 22: EXISTING HARNESS



FIGURE 23

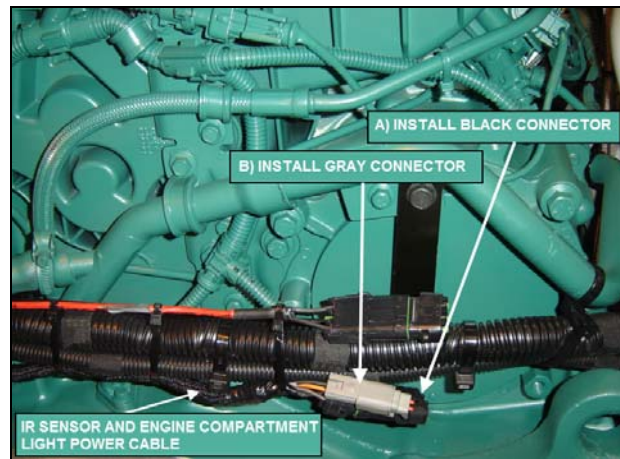

FIGURE 24

- 2) **Installation of black connector** (FIGURE 23, FIGURE 24). Inside the remaining section of previous step harness, identify and separate circuits 346, 0FE (ground) and 347. Install a PED Weather Pack connector.

Use:

- 1x TERMINAL, SOCKET 16-14 g #561578 (for ground wire 0FE)
- 2x TERMINAL, SOCKET 20-18 g #561689
- 1x CONNECTOR, SOCKET HOUSING #561782
- 1x SEAL 16-14 g #561786 (for ground wire 0FE)
- 2x SEAL 20-18 g #561565

circuit	cavity
346	A
0FE	B
347	C

- 3) **Installation of gray connector** (FIGURE 23, FIGURE 24, FIGURE 25). Inside the remaining section of the harness (previous steps), identify separate circuits 9B and 0RA2. Install a Deutsch DTM connector. This connector is installed as provision for further use if needed.

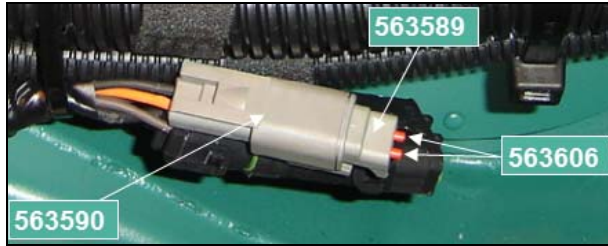

FIGURE 25: DEUTSCH CONNECTOR

Use:

- 2x #563588 TERMINAL, PIN
- 1X #563589 CONNECTOR, SOCKET HOUSING DTM 06-2S
- 1X #563590 CONNECTOR, PIN HOUSING DTM 04-2P PH 2C
- 1X #563604 LOCK, SECONDARY
- 2X #563606 PLUG, SEALING

circuit	cavity
9B	2
0RA2	1

PART 8 – INSTALLATION OF NEW LTD

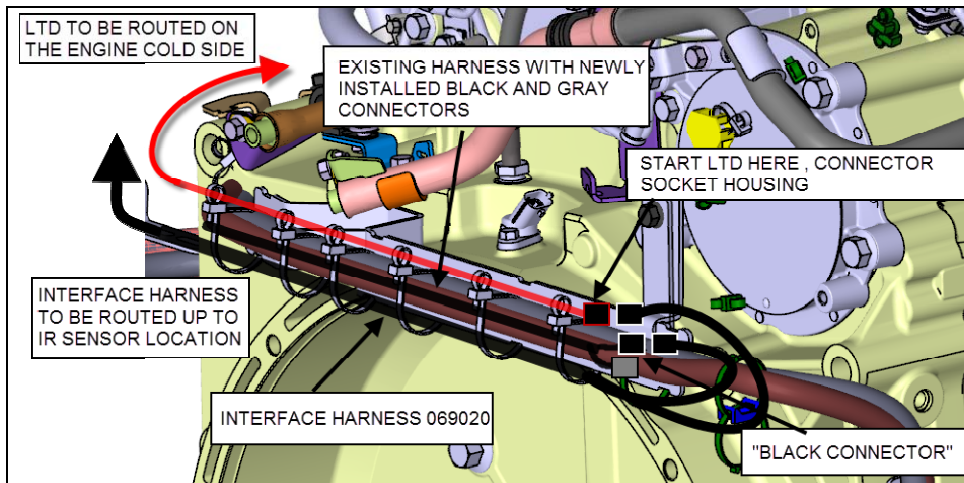

Figure 26

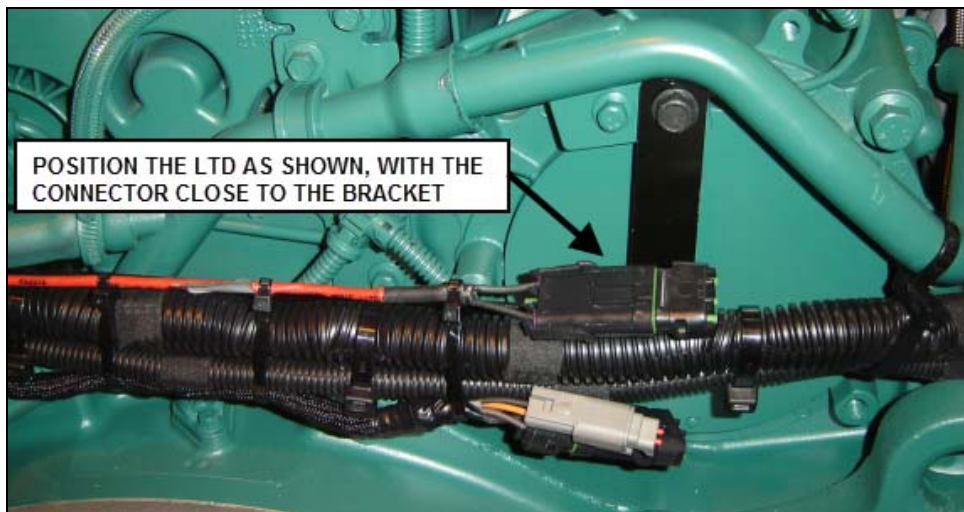

Figure 27



- 1) Secure LTD to existing harness (see Figure 26 for proper installation) using 6 double loop head nylon cable ties 507664. Use the second loop to attach the LTD (Figure 26 and Figure 27). Tighten the loop fixing the LTD by hand only. Follow the general recommendations.

Connect the interface harness to black and grey connectors as shown on Figure 28 and Figure 29.

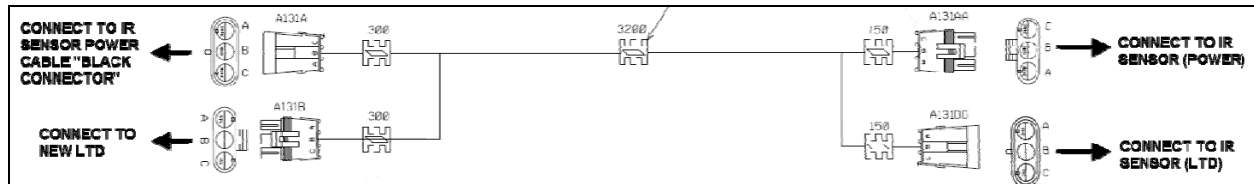

Figure 28: INTERFACE HARNESS #069041

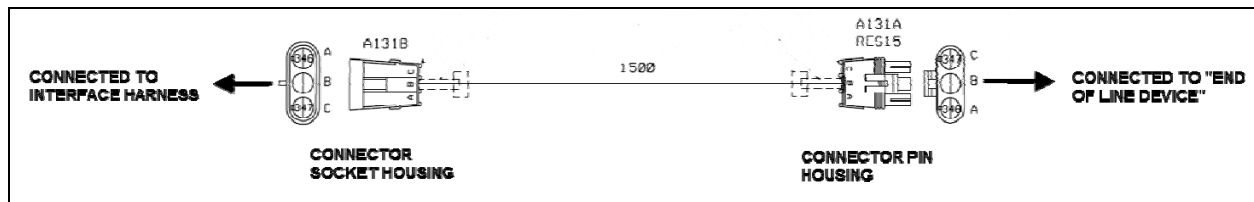
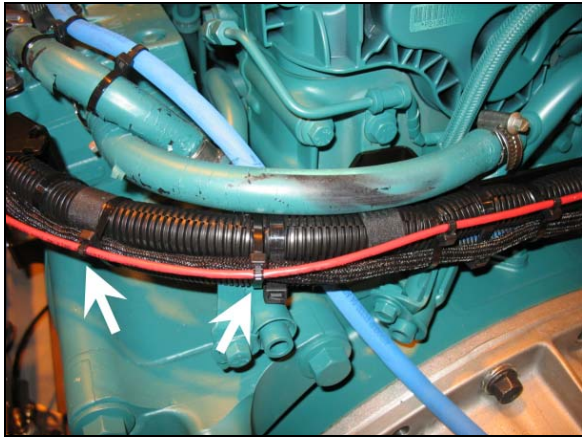

Figure 29: NEW LTD #069041

- 2) Route the LTD using double loop nylon cable ties. For each attachment point of the LTD, fix one loop of the cable tie around the close harnesses corrugated sleeve. Use the second loop to attach the LTD. Tighten the loop fixing the LTD by hand only. Follow the general recommendations.
- 3) Refer to the following pictures for proper attachment point location and installation method (consult the PDF color version of this document).



STEP 3 A



STEP 3 B

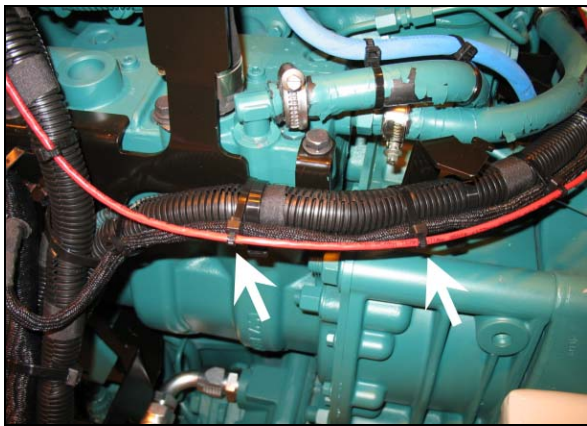

STEP 3 C

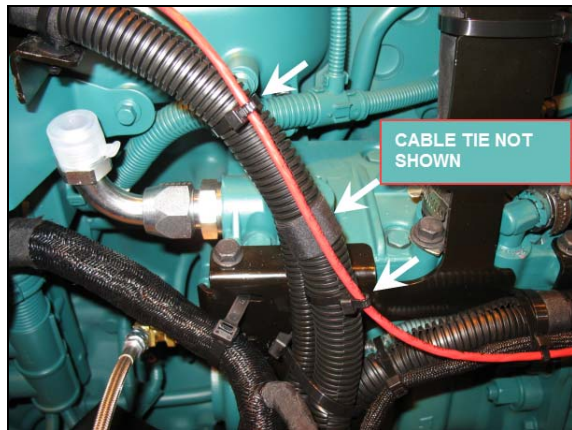

STEP 3 D



STEP 3 E

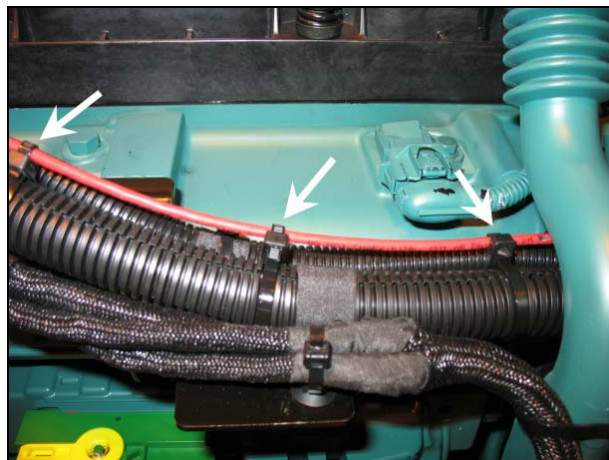

STEP 3 F



STEP 3 G



STEP 3 H: TERMINATION CONNECTOR

**PART 9 – ROUTING INTERFACE HARNESS UP TO THE IR SENSOR (XLII & X3 SERIES)**

- 1) Route the interface harness up to the IR sensor new location. Unlike the LTD, the interface harness is route on the vehicle structure, curbside. See images below.

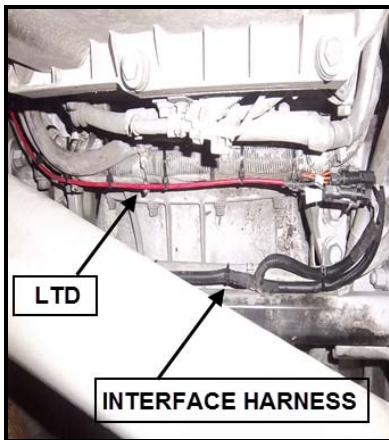

STEP 1-A

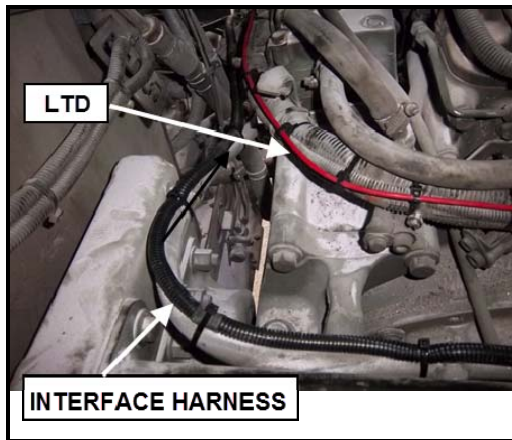

STEP 1-B

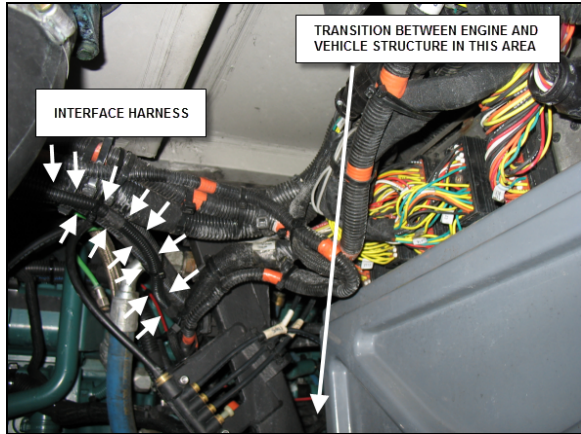

STEP 1-C

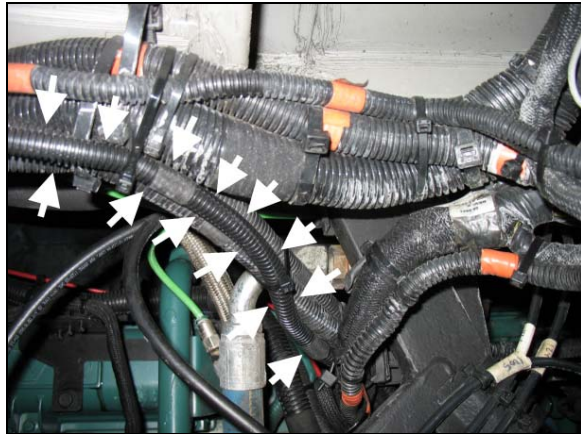

STEP 1-D

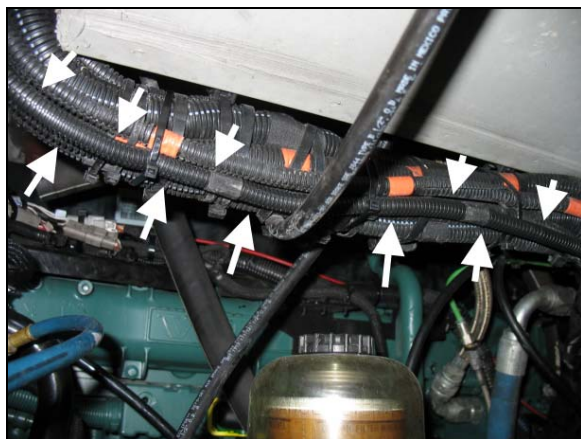

STEP 1-E

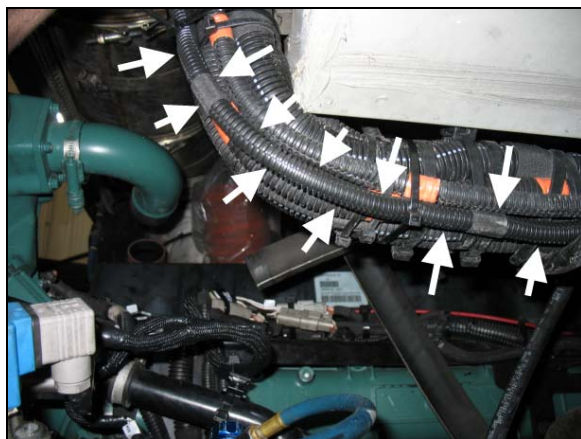

STEP 1-F



STEP 1-G

- 2) At this point, the end of the interface harness should be connected to the IR sensor in order to avoid having the interface harness extra length tied up close to the IR sensor. The extra-length will be looped and tied to close harnesses later on as shown on FIGURE 30.



FIGURE 30

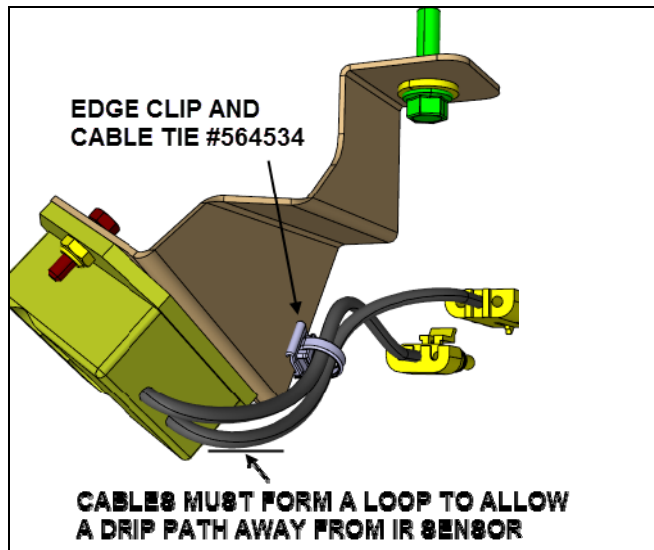

FIGURE 31

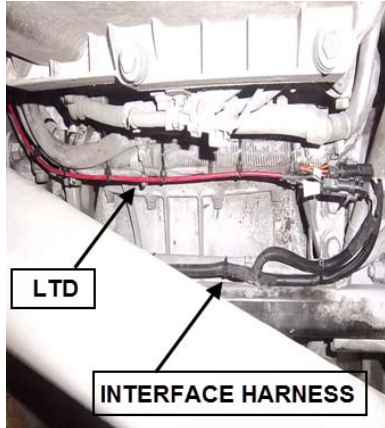

FIGURE 32

- 3) Connect the interface harness to the IR sensor. Secure IR sensor connectors as shown on FIGURE 31 and FIGURE 32 using 5 screws 501017 (pre-drilling diameter= 1/8 in ), 5 flat washers 500964, 5 tie mounts 504013, 5 nylon cable ties 504637 and 1 edge clip 564534. The IR sensor cables must form a loop to allow a drip path away from the IR sensor.
- 4) Secure the extra-length of interface harness to close harnesses as shown on FIGURE 30, using nylon cable ties 504637.
- 5) Put fuse F45 back in place. Set the battery master switch to the ON position.
- 6) Set the ignition switch to the ON position and check that the driver's area AFSS protection panel SYSTEM OK green lamp is illuminating and that no fire detected/extinguisher discharge condition has been triggered. If no Kidde valve simulator is installed, the TROUBLE lamp should illuminate steady, indicating there is a fault in the extinguishing circuit, which is normal if the extinguisher circuit is not connected to the extinguisher bottle. The TROUBLE lamp will blink if there is a fault in the detection circuit.  
  
If the ALARM lamp illuminates steady, a fire detected and extinguisher discharge conditions exist. Do not connect the extinguisher bottle to the extinguishing circuit.
- 7) If no fire detected/discharge condition exists, you can disconnect the valve simulator and plug the extinguisher bottle to the wiring harness of the extinguishing circuit.

**PART 10 – ROUTING INTERFACE HARNESS UP TO THE IR SENSOR (H3 SERIES)**

- 1) Route the interface harness up to the IR sensor new location. Unlike the LTD, the interface harness is routed on the curbside vehicle structure, attached to existing harnesses using nylon cable ties. See images below.



STEP 1 A

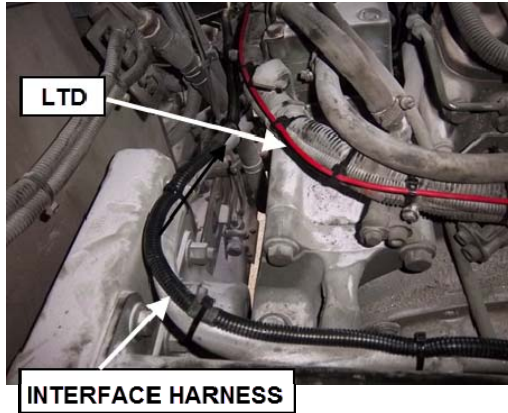

STEP 1 B

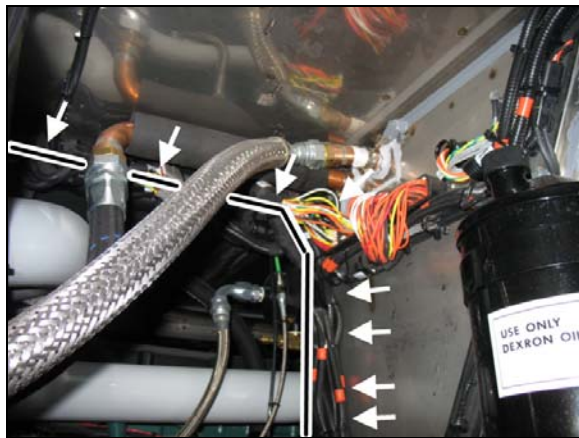

STEP 1 C



STEP 1 D

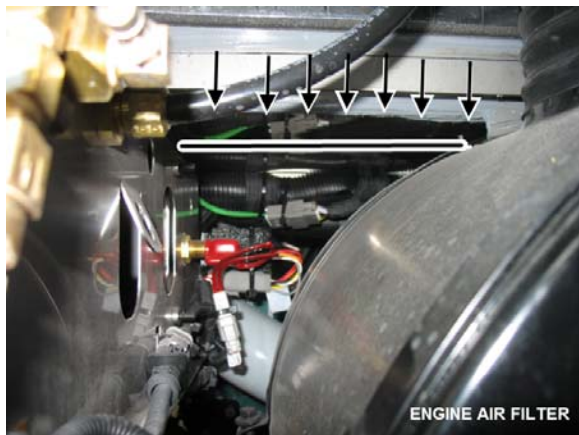

STEP 1 E

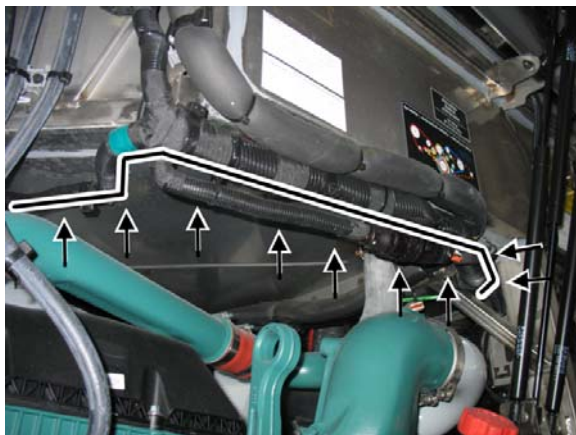

STEP 1 F



STEP 1 G

- 2) Connect the interface harness to the IR sensor (FIGURE 33).
- 3) Secure the interface harness connectors to close existing harness using three nylon cable ties #504637. The IR sensor cables must form a loop to allow a drip path away from the IR sensor (FIGURE 33, FIGURE 34).
- 4) Put fuse F45 back in place. Set the battery master switch to the ON position.
- 5) Set the ignition switch to the ON position and check that the driver's area AFSS protection panel SYSTEM OK green lamp is illuminating and that no fire detected/extinguisher discharge condition has been triggered. If no Kidde valve simulator is installed, the TROUBLE lamp should illuminate steady, indicating there is a fault in the extinguishing circuit, which is normal if the extinguisher circuit is not connected to the extinguisher bottle. The TROUBLE lamp will blink if there is a fault in the detection circuit.

If the ALARM lamp illuminates steady, a fire detected and extinguisher discharge conditions exist. Do not connect the extinguisher bottle to the extinguishing circuit.

- 6) If no fire detected/discharge condition exists, you can disconnect the valve simulator and plug the extinguisher bottle to the wiring harness of the extinguishing circuit.



FIGURE 33

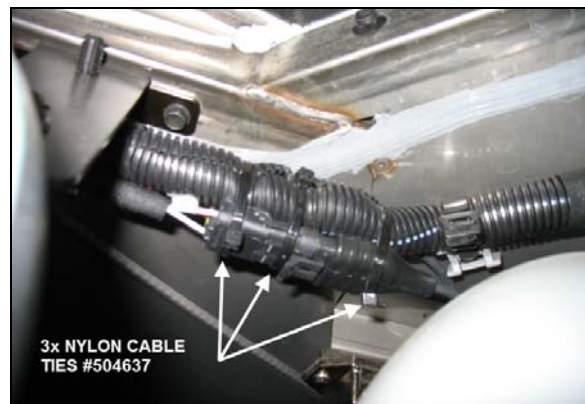

FIGURE 34



## PARTS / WASTE DISPOSAL

Discard waste according to applicable environmental regulations (Municipal/State[Prov.]/ Federal)

**Do not reuse** the old IR sensor as it may fail prematurely and offer no protection.

## WARRANTY

This modification is covered by Prevo's normal warranty. We will reimburse you the parts and 4 ½ hour(s) (4.5) of labor upon receipt of a warranty claim. Please submit claim via our Online Warranty System, available at [www.prevo.com](http://www.prevo.com) (under Service \ Warranty section). Use Claim Type: "Bulletin/Recall" and select "Warranty Bulletin WB14-28".

## OTHER

VBC Bulletin	na
Fail Code	23.08
Defect Code	09
Syst.Cond.	B
Causal Part	068552

Access all our Service Bulletins on  
<http://prevo.com/technicalpublications/en/pub.asp>  
or scan the QR-Code with your smart phone.

E-mail us at [technicalpublications\\_prev@prevo.com](mailto:technicalpublications_prev@prevo.com) and type  
"ADD" in the subject to receive our warranty bulletins by e-mail.

