

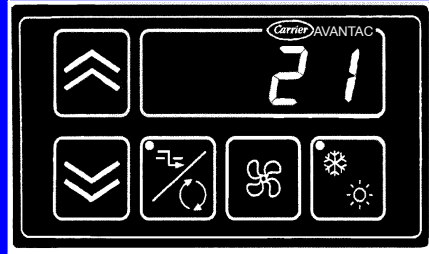

Transport Air Conditioning



OPERATOR'S MANUAL
for
AvantAC Electric
Roof Top Air Conditioning System



TRANSICOLD

OPERATOR'S MANUAL

AvantAC Electric

**ROOF TOP
AIR CONDITIONING
SYSTEM**

CONTENTS

	Page
Introduction	1
Safety	3
Unit/System Information	4
1.1 AIR CONDITIONING	4
1.2 AIR CONDITIONING SYSTEM	4
1.3 SYSTEM COMPONENTS	4
1.4 EQUIPMENT IDENTIFICATION	5
Unit Operation	6
2.1 DRIVERS DISPLAY	6
2.1.1 Key Functions	6
2.1.2 LED Functions	7
2.2 DRIVERS DISPLAY FUNCTIONS	8
2.3 PRE-TRIP INSPECTION	9
2.4 OPERATING INSTRUCTIONS	10
2.4.1 Display	10
2.4.2 Starting And Interior Temperature Control ..	10
2.4.3 Automatic Climate Control	10
2.4.4 Vent	11
2.4.5 Manual Reheat	11
2.4.6 Temperature Indication	11
System Maintenance	12
3.1 MAINTENANCE SCHEDULE	12
3.2 INSULATION MONITORING DEVICE (IMD) TEST PROCEEDURE	12
3.3 WARRANTY/SERVICE	13
Index	Index 1

INTRODUCTION

AVANTAC ELECTRIC OPERATOR'S MANUAL

This guide has been prepared for the operator of Carrier Transport AvantAC Air Conditioning systems. It contains basic instructions for the daily operation of the air conditioning system as well as safety information, and other information that will help you to maintain a comfort level for your self and your passengers. Please take the time to read the information contained in this booklet and refer to it whenever you have a question about the operation of your Carrier Transport Air Conditioning system.

More comprehensive information can be found in the AvantAC Electric Operation and Service Manual (T-314). This manual can be obtained from your Carrier Transport A/C dealer.

Your air conditioning system has been engineered to provide long, trouble-free performance when it is properly operated and maintained. A comprehensive maintenance program will help to insure that the unit continues to operate reliably. Such a maintenance program will also help to control operating costs, increase the unit's working life, and improve performance.

Some vehicles may require information from manuals supplied by the vehicle manufacturer or other special equipment suppliers. We urge you to review all these publications carefully. This will help you enjoy safe and trouble-free operation of your vehicle.

When having your unit serviced, be sure to specify genuine Carrier Transicold replacement parts for the highest quality and best reliability.

At Carrier Transport Air Conditioning, we are continually working to improve the products that we build for our customers. As a result, specifications may change without notice.

SAFETY

Your Carrier Transport Air Conditioning system has been designed with the safety of the operator in mind. During normal operation, all moving parts are fully enclosed to help prevent injury. During all pre-trip inspections, daily inspections, and problem troubleshooting, you may be exposed to moving parts; please stay clear of all moving parts when the unit is in operation.



WARNING

Beware of unannounced starting of the unit. The unit may cycle the fans and operating compressor unexpectedly as control requirements dictate. Turn system off and disconnect battery power.

REFRIGERANT

The refrigerant contained in the air conditioning system can cause frostbite, severe burns, or blindness when in direct contact with the skin or eyes. For this reason, and because of legislation regarding the handling of refrigerants during system service, we recommend that, whenever your unit requires service of the refrigeration system, you contact your nearest Carrier Transport Air Conditioning authorized dealer for service.

UNIT/SYSTEM INFORMATION

1.1 AIR CONDITIONING

Air Conditioning is the cooling, heating, dehumidification, and filtration of the air within the passenger compartment of a vehicle.

1.2 AIR CONDITIONING SYSTEM

An Air Conditioning System nominally includes an evaporator, a condenser, a compressor and interconnecting refrigerant hoses, fittings, and electrical harnesses and controls. The Carrier Transport Air Conditioning AvantAC Electric System may also include a generator and supporting equipment. A listing of the system components, along with specific data for each, is provided in Paragraph 1.3.

1.3 SYSTEM COMPONENTS

Generator - Provides AC power to operate the compressor, condenser and evaporator motors.

Main Disconnect Switch - Located in the power box assembly, it is used to connect and disconnect generator AC power from the rest of the system.

Control Box - Houses the fuses, ground plate and insulation monitoring device (IMD).

Power Source Selection Box (If Fitted) - Used to select input power from the generator or another power source.

Roof Top Module (Includes) -

Evaporator - The evaporator's primary function is to transfer heat contained in the passenger compartment air, into the refrigerant, which is circulated by the compressor, through the evaporator coil. During this process the air is also dehumidified.

Expansion Valve - Meters the refrigerant flow into the evaporator coil.

Compressor - The compressor is a high-pressure pump, which circulates the refrigerant through the evaporator and condenser.

Condenser - The condenser's primary function is to reject heat, which was transferred to the refrigerant by the evaporator from the passenger compartment of the vehicle.

Air Sensors / Pressure Transducers - The system is supplied with air sensors and pressure transducers. These devices signal the the microprocessor to control the system.

Inverter / Microprocessor - The inverter / microprocessor receives signals from various devices and calculates required system operation parameters to bring the vehicle interior temperature to the required set-point.

Fresh Air Flap - The fresh air flap opens and closes to regulate the delivery of fresh air to the vehicle interior. It is controlled by the microprocessor.

Pressure Switch - The systems use a high pressure switch wired to control the power circuit of the compressor. The switch is non-adjustable. If the pressure switch opens, interrupting the circuit to the compressor, the operation of the compressor will stop. When conditions return to normal the switch will automatically reset. The compressor will resume operating only after the system is shut down and then restarted.

Refrigerant - A refrigerant is a material that is used to move heat from the passenger compartment to the outside air. It is a substance that gives up heat by condensing at high temperature and pressures and absorbs heat by evaporating at low temperatures and pressures. The heat transfer properties exhibited when refrigerant changes state is the foundation of the refrigerant cycle.

1.4 Equipment Identification

In order to identify the air conditioning components you have, you will need to know the Parts Identification (PID) number and serial number. All Carrier Transport Air Conditioning systems have a PID / serial number decal located on the assembly. Knowing these locations and the information on the data tags will aid you in identifying the correct service procedures.

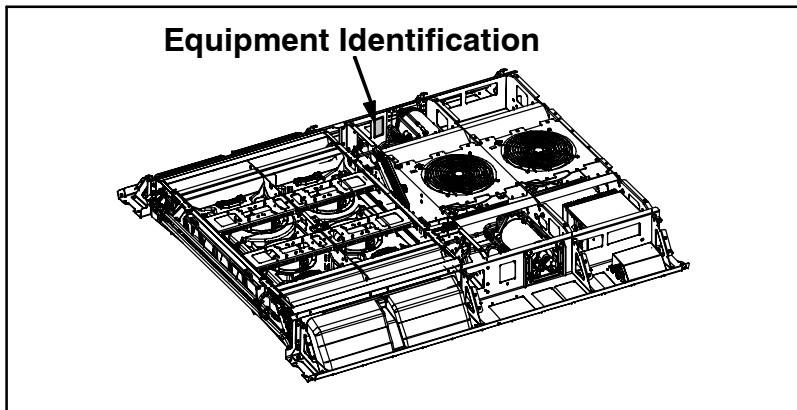

Figure 1-1 I.D. Location

UNIT OPERATION

Before attempting to operate the system, power must be available from the vehicle battery. The drivers display must be illuminated. This system will not operate unless the vehicle engine is operating.

2.1 DRIVERS DISPLAY

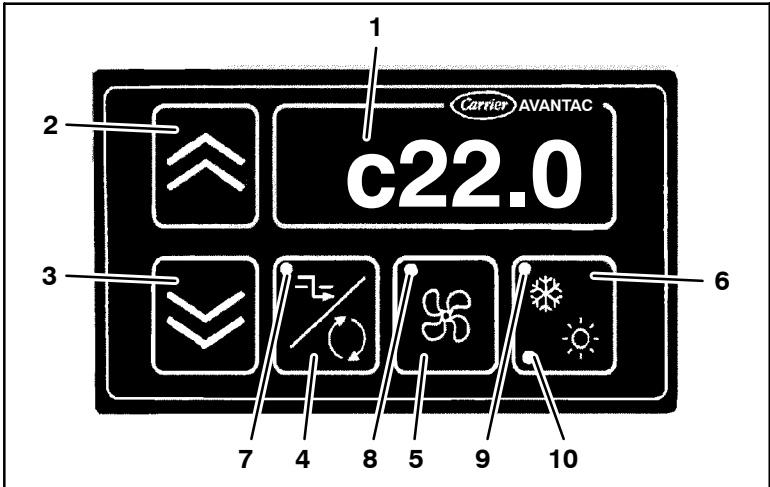

Figure 1-2 Drivers Display

KEYS

- 1. Display
- 2. Plus Key
- 3. Minus Key
- 4. Recirculate/Fresh Air
- 5. Blower Control Key
- 6. Automatic Climate Control (A/C)

LEDS

- 7. Fresh Air Open (Green)
- 8. Manual Blower 'ON' (Green)
- 9. Cooling/Heating (Green)
- 10. Malfunction Cooling Unit (Red)

2.1.1 Key Functions



Automatic Climate Control (A/C) - Switches on the automatic temperature control. The green LED will confirm the system is running. The red LED indicates a system malfunction.



Plus Key - Increases vehicle set-point by 0.5°C per stroke or increases manual blower speed, depending on displayed mode.



Minus Key - Decreases vehicle set-point by 0.5°C per stroke or decreases manual blower speed, depending on displayed mode.



Recirculating / Fresh Air - Switches from Recirculating Air to Fresh Air and vice versa.



Blower Control - Switches the evaporator blower motors from automatic speed control (based on controller inputs) to manual control where the operator may select blower speed based on the number of times the Plus Key or the Minus Key are stroked.



+ Temperature Indication - Use two keys, Minus Key and the Recirculating/Fresh Air Key - If both keys are pressed simultaneously the display shows the inside temperature for 10 seconds, if both keys are pressed a second time, the outside temperature will be displayed for 10 seconds.



+ Reheat - Use two keys, Recirculating / Fresh Air Key plus Blower Control - If both keys are pressed simultaneously the system will run in reheat for 3 minutes.

2.1.2 LED Functions

- Display - (Figure 1-2, Item 1.) The standard indication is the set-point temperature.
- Fresh Air - (Figure 1-2, Item 7.) This green LED will illuminate when the fresh air damper is open.
- Blower Control - (Figure 1-2, Item 8.) This green LED will illuminate when the evaporator blower motors are controlled manually as described in 2.1.1  'Blower Control'
- Cool/Heat - (Figure 1-2, Item 9.) This green LED will illuminate when the unit is operating in Auto Mode.
- Malfunction - (Figure 1-2, Item 10.) This red LED will illuminate when the high pressure safety switch activates.
- Reheat - (Figure 1-2, Item 9.) This green LED will flash when the reheat function is active.

2.2 DRIVER DISPLAY FUNCTIONS

KEY	OPERATION
Plus Key	<ul style="list-style-type: none"> -When the display shows return air temperature, press the Plus key will go to show return air set-point. -When the display shows return air set-point, press Plus key will increase set-point by 0.5C. -When the display shows manual fan speed, press Plus key will increase evaporator fan speed by 10Hz. -When the display shows information list, press Plus key will move to next display item in the information list.
Minus Key	<ul style="list-style-type: none"> -When the display shows return air temperature, press the Minus key will go to show return air set-point. -When the display shows return air set-point, press Minus key will decrease set-point by 0.5C. -When the display shows manual fan speed, press Minus key will decrease evaporator fan speed by 10Hz. -When the display shows information list, press Minus key will move to previous display item in the information list.
Plus and Minus Key	<ul style="list-style-type: none"> -When the display shows return air temperature set-point, pressing Plus and Minus Keys together will show the information list. -When the display shows the information list, pressing Plus and Minus Keys together will show return air temperature set-point.
Recirculate/Fresh Air Key	<ul style="list-style-type: none"> -Toggles fresh air flap automatic control or close. -When the LED is on, the flap is under automatic control. -When the LED is off, the flap is closed.

Blower Control Key	<p>-System OFF: Pressing this key activates the generator, evaporator motors and fresh air flap. The evaporator fan speed is controlled by pressing the Plus or Minus key.</p> <p>-System ON: Pressing the key changes the evaporator fan speed to manual control, so that the operator can control evaporator fan speed with the Plus or Minus keys. -Pressing again returns evaporator fan speed control to automatic.</p> <p>-When the LED is on, the evaporator fan is running and the speed is fixed to the manual setting.</p>
Automatic Climate Control Key	<p>-Toggles rooftop module on or off. When the upper left corner LED is on, the rooftop module is on.</p> <p>-The bottom left corner LED is an alarm indicator.</p> <p>-When there is an alarm, the LED will flash on and off.</p>
Minus Key and Recirculate/Fresh Air Key	<p>-Press Minus and Flap keys together to show return air temperature. When the display shows return air temperature, press the Minus and Flap key together again to show ambient temperature</p>
Recirculate/Fresh Air Key and Automatic Climate Control Key	<p>-Press Recirculate/Fresh Air and Automatic Climate Control keys together to activate the reheat mode for 20 minutes. When the reheat mode is activated, the green LED (See Figure 1-2, Item 9) will flash on/off.</p>

2.3 PRE-TRIP INSPECTION

After starting system, allow system to stabilize for ten to fifteen minutes and check for the following:

- a. Listen for abnormal noises in compressor or fan motors.
- b. Ensure that there are no alarms indicated.

2.4 OPERATING INSTRUCTIONS



When the engine is started, previously set functions of the control are reactivated.

2.4.1 Display

The display is dark when the unit is OFF. When the unit is ON the display shows the interior set-point temperature. When selecting individual functions, the display shows the corresponding information for a short period of time.

2.4.2 Starting And Interior Temperature Control

a. If the engine is not running, start the engine.

Pressing the Automatic Climate Control key  - will start vehicle interior temperature control. Press the Plus -  or Minus -  Keys to set the required temperature. The temperature can be adjusted between 18°C and 28°C. The cooling functions will be disabled if ambient air temperatures are below 10°C.

2.4.3 Automatic Climate Control



After selecting the automatic climate control the unit will be governed in relationship to the vehicle interior temperature and set-point temperature.

Heating: If the vehicle interior temperature drops more than 0.9°C below the set-point temperature, the control switches on the heating. If the vehicle interior temperature reaches the set-point, the heating will be minimized and shut off if the interior temperature rises to more than 0.9°C above set point.

Cooling: If the vehicle interior temperature rises more than 0.9°C above the set-point temperature, the control turns on the compressor. If the vehicle interior temperature drops more than 0.9°C below the set-point, the compressor is switched off. If the ambient temperature sensor is in operational, cooling is not allowed whenever the ambient temperature is below 10°C.

Blower: If automatic blower control is selected, the evaporator blower speed will vary in response to the relationship to the vehicle interior temperature and the controller set-point temperature.

2.4.4 Vent

The blowers may be switched to manual mode of operation by pressing the blower key . Press the plus  or minus  keys to select one of 6 different blower speeds (20%, 40%, 60%, 80%, 100%, and OFF).

The blowers cannot be switched OFF when Automatic Climate Control is ON.

When Automatic Climate Control is OFF, the blowers stop when the manual blower control is turned to OFF.



2.4.5 Manual Reheat



The Reheat mode is used to lower the air humidity and to help defogging the windshields. Press the Recirculating/Fresh Air 

Key and the Automatic Climate Control  Key at the same time to activate Reheat. Heating and cooling will be energized for 3 minutes. In addition, the evaporator blowers will be switched to maximum speed and the fresh air flap will be closed. At the end of the of Reheat, the functions will return to previously selected settings.

Reheat is disabled with ambient temperatures below 10°C.

2.4.6 Temperature Indication

Press the Recirculating/Fresh Air  Key and the Minus  Key at the same time to display the interior temperature (example "i 22"). The display will return to the original setting after 10 seconds.

Pressing the Recirculating/Fresh Air  Key and the Minus  Key a second time will display the ambient temperature (example "o 19").



A sensor malfunction will display as "i --" or "o --".

SYSTEM MAINTENANCE

3.1 MAINTENANCE SCHEDULE

SYSTEM		OPERATION
ON	OFF	
a. Daily Maintenance		
X	X X	Check tension and condition of drive belt. Pre-trip inspection - after starting. (Refer to paragraph 2.3)
b. Weekly Maintenance		
	X X X	Perform daily inspection. Check the condenser coils, the evaporator coils, and the fresh air filters for cleanliness. Clean return air filters.
c. Monthly Maintenance and Inspection		
	X X X X X X X	Perform weekly inspection. Check operation of IMD (Refer to paragraph 3.2). Clean evaporator drain pans and hoses. Check wire harnesses for chafing and loose terminals. Check fan motor bearings. Check generator mounting bolts for tightness. Clean fresh air filters.

3.2 INSULATION MONITORING DEVICE (IMD) TEST PROCEDURE

- a. Shut the vehicle engine off, but leave the 24VDC on for the driver display and rooftop modules.
- b. On the driver display, press Plus  (See Figure 1-2, Item 2) and Minus  (See Figure 1-2, Item 3) keys together to go to the parameter display mode. When the driver display is in the parameter mode, press the Plus  key multiple times until the generator voltage is shown on the display. Since the generator is not running, it will show a residual voltage which is close to the supplied 24VDC voltage.

- c. Toggle and hold the IMD test switch on the control box (See Figure 1-3). After holding the switch for about 10 seconds, the IMD test light on the control box should turn ON. On the driver display, the generator voltage should show 0V. This is to confirm the generator's 24VDC is turned off by the IMD.
- d. Release the IMD test switch on the control box. After releasing the switch for about 10 seconds, the IMD test light on the box will turn OFF. On the driver display (See Figure 1-2), the generator voltage should show close to 24VDC, which confirms the 24VDC voltage for the generator is back on.

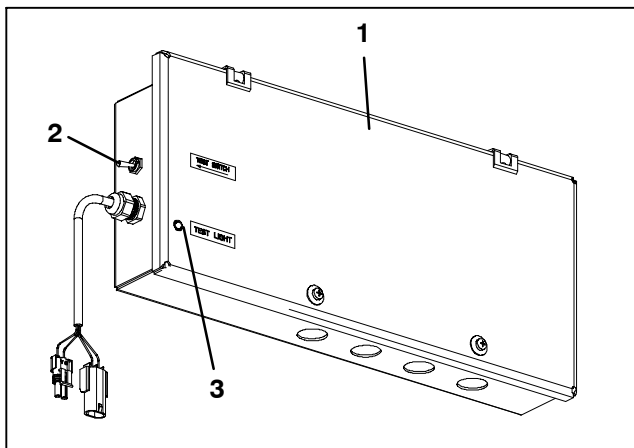

Figure 1-3 Control Box

1. Control Box
2. IMD Test Switch
3. IMD Test Light

3.3 WARRANTY/SERVICE

Thank you for choosing a Carrier Transport Air Conditioning system for your vehicle. We want to assure you of our continuing interest in your pleasure and satisfaction with your air conditioning system. If you have a question or concern and need help, contact your nearest Carrier Transport Air Conditioning Dealer.

INDEX

A

Air Conditioning System, 4

C

Compressor, 4

Condenser, 4

D

Drivers Display, 6

E

Equipment Identification, 5

Evaporator, 4

F

Fresh Air Flap, 5

G

Generator, 4

I

IMD Safety Box, 4

IMD Test Procedure, 12

Introduction, 1

Inverter / Microprocessor, 5

M

Main Disconnect Switch, 4

Maintenance Schedule, 12

O

Operating Instructions, 10

P

Power Source Selection Box, 4

Pre-Trip Inspection, 9

R

Refrigerant, 3, 5

Roof Top Module, 4

INDEX

S

Safety, 3
Sensor - Return Air, 4
Starting, 10
Switch - Pressure, 5
System Components, 4
System Maintenance, 12

U

Unit Information, 4
Unit Operation, 6

V

Valve - Expansion, 4

W

Warranty/Service, 13
What Is Air Conditioning, 4



Carrier

A United Technologies Company

Carrier Transicold Division,
Carrier Corporation
Transport Air Conditioning Group
P.O. Box 4805
Syracuse, N.Y. 13221 U.S.A

www.carrier.transicold.com



TRANSICOLD

A member of the United Technologies Corporation family. Stock symbol UTX
©2006 Carrier Corporation • Printed in U. S. A. 1106