



**9000485 & 9000485-W - OSCP**

**OPERATOR'S SYSTEM CONTROL PANEL**

# **OPERATION & PARTS MANUAL**

Axion Ref. No.: 3042010  
( Revision A )

Passenger Information System for Mass Transit Applications  
Système d'information aux passagers pour le transport en commun

# **Electronic Destination Sign Systems**

**9000485 & 9000485-W - OSCP**

**OPERATOR'S SYSTEM CONTROL PANEL**

# **OPERATION & PARTS MANUAL**

**Axion Ref. No.: 3042010  
( Revision A )**

**2014**

The information provided in this document may be modified without prior notice.  
No part of this manual may be reproduced or transmitted for any purpose by  
any electronic or mechanical means, without a written authorization from:

**© 2014 Axion Technologies Ltd.  
Technical Publications and Training Department  
All rights reserved**

**PRINTED IN CANADA**

## HANDBOOK CHANGE INFORMATION

At AXION TEHCNOLOGIES LTD., we continually strive to keep up with the latest electronic developments with circuit and component improvements or simply by designing new equipment.

Sometimes, due to printing requirements, we are unable to incorporate these changes immediately into printed handbooks.

Our customers are welcome to contact our Technical Department concerning their requirements for the latest changes to our publications.

We also request that you notify us of any error found or omission in our publications.

Axion Technologies Ltd.  
151, rue du Parc-de-l'Innovation  
La Pocatière, Québec, Canada, GOR 1Z0  
Phone: 418-856-1454

[www.axiontech.ca](http://www.axiontech.ca)

## List of revisions

REVISION	DATE	DESCRIPTION OF CHANGES
--	2014-02-26	Original
A	2014-07-18	Included OSCP Operation

## Table of Contents

SECTION 1.....	7
OPERATION.....	7
1. OPERATOR'S SYSTEM CONTROL PANEL (OSCP).....	1
1.1. OPERATING THE OSCP.....	1
1.1.1. DESTINATION SIGNS MANAGEMENT INTERFACE.....	1
1.1.1.1. ENTERING DESTINATION.....	3
1.1.1.2. PROGRAMMING AND RECALLING DESTINATION USING DESTA AND DESTB. .	5
1.1.1.3. ENTERING DESTINATION ID NUMBER.....	7
1.1.1.4. ENTERING PUBLIC MESSAGE.....	9
1.1.1.5. ENTERING TEXT FOR KEY NUMBER SIGN.....	11
1.1.1.6. SETTING SCREEN BRIGHTNESS.....	13
1.1.1.7. SIGNS SYSTEM DIAGNOSTIC.....	14
1.1.1.7.1. REBOOTING OSCP.....	16
1.1.1.7.2. ACTIVATING SIGNS TESTS.....	17
1.1.1.7.3. READING SIGNS DIAGNOSTIC.....	18
1.1.1.7.4. READING SIGNS DATABASE VERSION.....	19
1.1.1.7.5. DISPLAYING/CONFIGURING SIGNS NETWORK.....	20
1.1.1.8. SIGNS SYSTEM CONFIGURATION.....	23
1.1.1.8.1. SETTING SYSTEM SHUTDOWN DELAY.....	25
1.1.1.8.2. SETTING YIELD FUNCTION DELAY.....	26
1.1.1.8.3. SETTING EMERGENCY SWITCH STOP MODE.....	27
1.1.1.8.4. MODIFYING PUBLIC MESSAGE PASSWORD.....	28
1.1.1.8.5. MODIFYING EMERGENCY DEACTIVATE PASSWORD.....	30
1.1.1.8.6. SELECTING SIGN CPU FREQUENCY.....	32
1.1.1.8.7. ACTIVATING AUTOMATIC TEST MODE.....	33
1.1.1.8.8. ACTIVATING ACCENTUATED UPPERCASE.....	34
1.1.1.8.9. ACTIVATING DESTINATION ON START-UP.....	35
1.1.1.8.10. ACTIVATING PERMANENT PUBLIC MESSAGE.....	36
1.1.2. OSCP DIAGNOSTICS INTERFACE.....	37
1.1.2.1. DISPLAYING NETWORK INTERFACE.....	39
1.1.2.2. DISPLAYING Wi-Fi CONFIGURATION.....	40
1.1.2.3. DISPLAYING THE DOWNLOADED DATABASE STATISTICS.....	41
1.1.3. OSCP GENERAL CONFIGURATION INTERFACE.....	42
1.1.3.1. SETTING DATE AND TIME.....	44
1.1.3.2. SELECTING RS-232 PROTOCOL.....	46
1.1.3.3. CONTROLLING AUDIO FEEDBACK.....	47
Note: By selecting/deselecting Audio Feedback, the speaker icon on the status bar	
changes accordingly.....	48
1.1.3.4. SELECTING LANGUAGE.....	49
1.1.3.5. MODIFYING MAINTENANCE PASSWORD.....	50
1.1.3.6. MODIFYING VEHICLE NUMBER.....	52
1.2. USB TRANSFER.....	54

1.3. STATUS BAR ICON DESCRIPTIONS.....	56
1.3.1. Signs Error Icons.....	56
1.3.2. Function Error Icons.....	56
SECTION 2.....	57
PARTS LIST.....	57
1. TECHNICAL DESCRIPTION.....	58
2. OSCP DESCRIPTION.....	59
2.1. DIMENSIONS.....	59
2.2. EXPLODED VIEW.....	60
2.3. OSCP BOARDS.....	61
1.3.3. Processor Board Assy 8102172.....	61
1.3.4. LCD Board Assy 8101687.....	62
1.3.5. Wi-Fi Board 8101689 (Optional, on 9000485-W only).....	63
2.4. PARTS LIST.....	64
3. REMOVAL AND REPLACEMENT PROCEDURES.....	66
3.1. OSCP REMOVAL AND REPLACEMENT.....	66
3.2. OSCP BOARDS REMOVAL AND REPLACEMENT.....	67
1.3.6. LCD board removal and replacement.....	67
1.3.7. Wi-Fi board removal and replacement.....	67
1.3.8. Processor board removal and replacement.....	68
1.3.9. Battery removal and replacement.....	68

# **SECTION 1 OPERATION**

## 1. OPERATOR'S SYSTEM CONTROL PANEL (OSCP)

The OSCP is the new, more efficient generation of user interface. Its touchscreen and graphics functions facilitate the operation of the EDSS. The main window or desktop gives access to the three following applications:

- Access to the destination signs management interface
- Access to the general diagnostics interface
- Access to the general configuration interface.



Figure 1: Desktop Window

### 1.1. OPERATING THE OSCP

#### 1.1.1. DESTINATION SIGNS MANAGEMENT INTERFACE

The destination management window gives access to the operation of the EDSS. The tool bar in the upper section of the window gives access to the following functions:

- Back (return to previous window)
- Screen intensity adjustment
- Access to signs system diagnostic
- Access to signs system configuration menu.

The status bar in the bottom section of the window shows the error indicators, the Ethernet and Wi-Fi link statuses, the audio feedback status, and the clock.



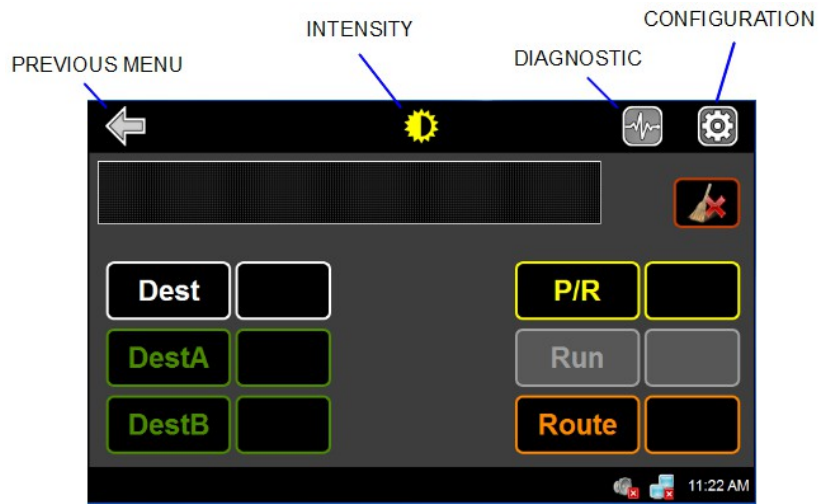

**Figure 2: Destination Signs Management**

The main function of this window is to control the messages displayed on the signs system. The upper section of the window shows the messages displayed on the front sign of the vehicle. The following table presents the different buttons of the window and their functions.

Button	Function
<b>Dest</b>	<ul style="list-style-type: none"> <li>Access keyboard to enter appropriate destination number (see following window).</li> </ul>
<b>DestA / DestB</b>	<ul style="list-style-type: none"> <li>Reapply destination number previously stored.</li> </ul>
<b>Route</b>	<ul style="list-style-type: none"> <li>Access keyboard to enter destination ID number.</li> </ul>
<b>P/R</b>	<ul style="list-style-type: none"> <li>Access keyboard to enter public message number.</li> </ul>
<b>Run</b>	<ul style="list-style-type: none"> <li>Access keyboard to enter key number.</li> </ul>
	<ul style="list-style-type: none"> <li>Delete the Destination and the Route numbers</li> </ul>

*Table 1: Destination Signs Management Interface*

### 1.1.1.1. ENTERING DESTINATION

- Consult your Transit Authority code list.
- Press **Dest**.

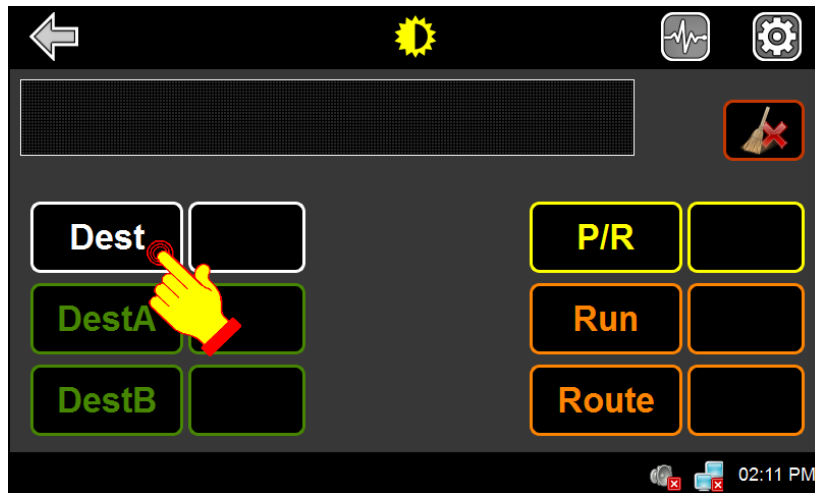

Figure 3: Main Destination Window

- Using the alphanumeric keyboard, enter the code of the destination to be displayed.
- Press **ENTER** to validate your choice.

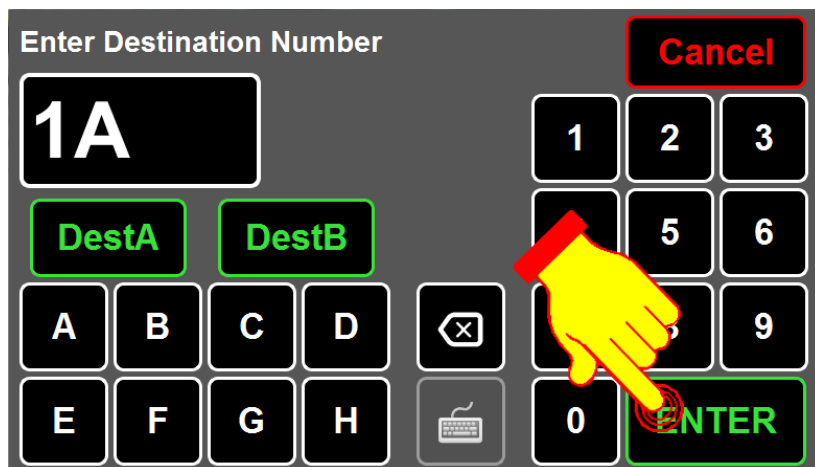

Figure 4: Entering Destination

When the destination is entered, the OSCP displays the following information:

- Destination number displays in the **Dest** field.
- Front destination content (message) displays in the text field.

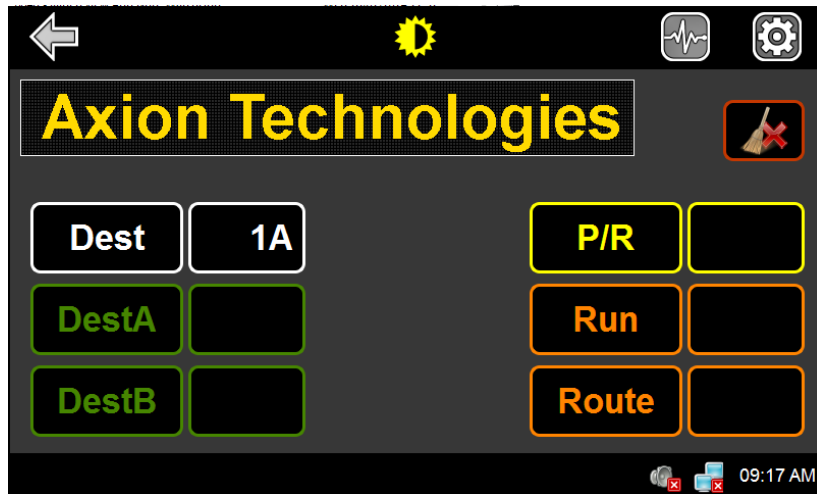

Figure 5: Destination Display

### 1.1.1.2. PROGRAMMING AND RECALLING DESTINATION USING DESTA AND DESTB

**DESTA** and **DESTB** buttons allow to store two destination numbers. When programmed, these destination codes may be recalled by pressing **DESTA** and **DESTB**.

To program the destination numbers, proceed as follows:

- Press **Dest**.

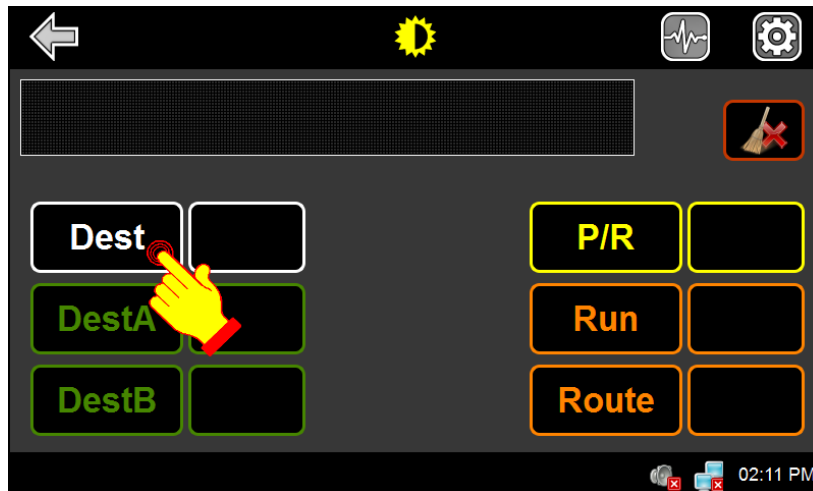

Figure 6: Main Destination Window

- Using the alphanumeric keyboard, enter the code of the destination.
- Press **DestA** or **DestB** to store your choice.

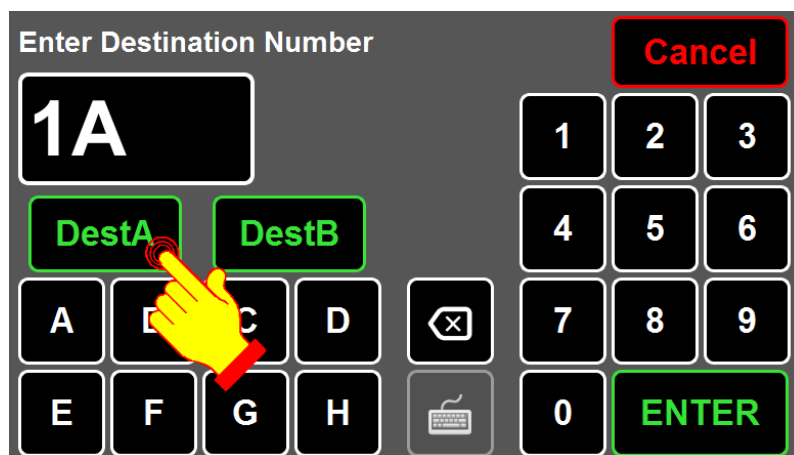

Figure 7: DestA Destination Number Programming

- Press **DESTA** or **DESTB** to recall the associated destination number.

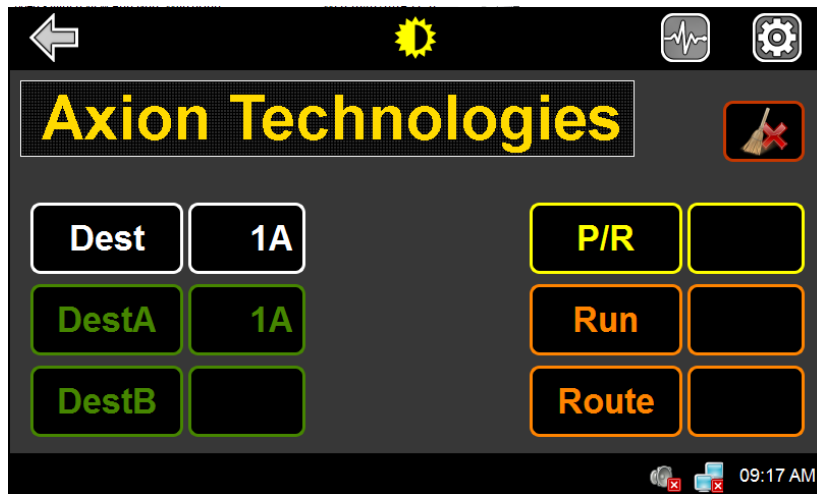

Figure 8: DestA Destination Recall

### 1.1.1.3. ENTERING DESTINATION ID NUMBER

- Consult your Transit Authority code list.
- Press **Route**.

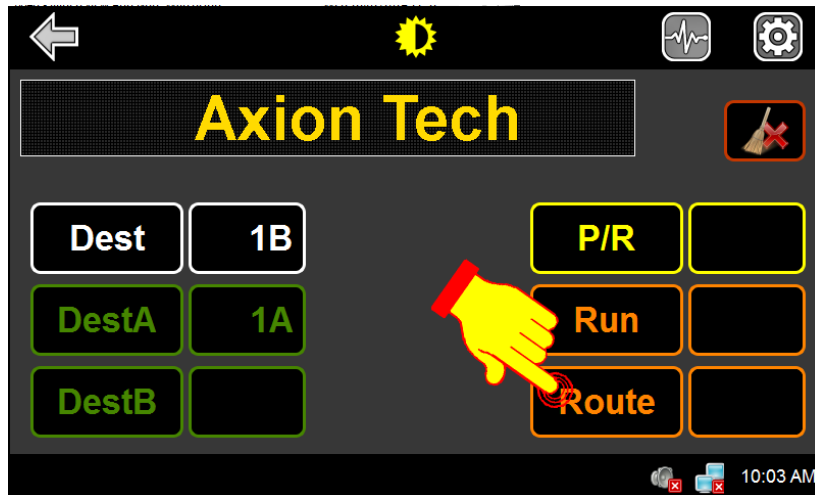

Figure 9: Destination ID Route

- Using the alphanumeric keyboard, enter the destination ID number.
- Press **ENTER** to validate your choice.

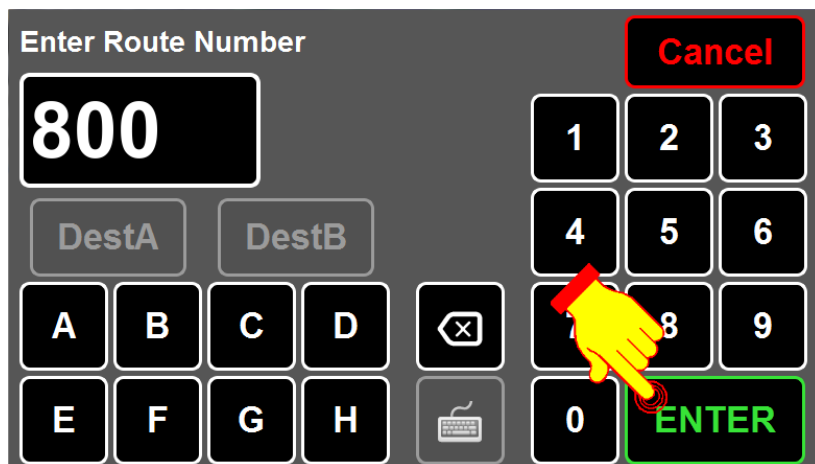

Figure 10: Entering Route Number

When the ID number is entered, the OSCP displays the following information:

- ID number displays in the **Route** field.
- ID number and the Front Destination content (message) display in the text field.

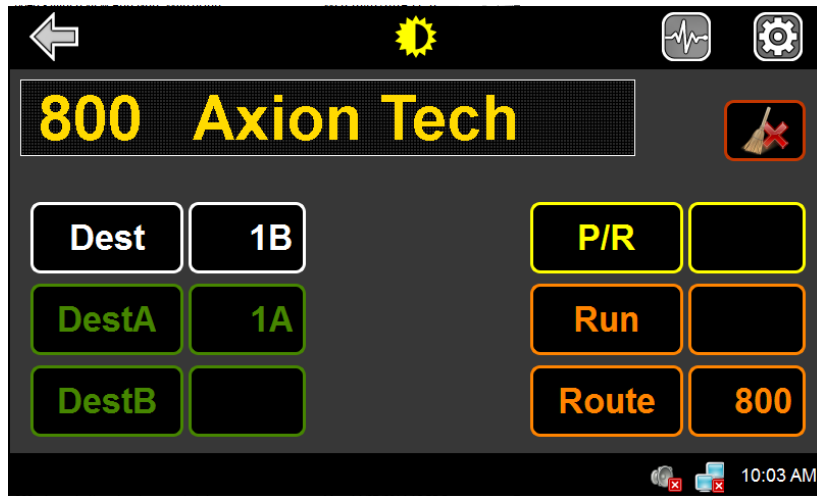

Figure 11: Destination ID display

### 1.1.1.4. ENTERING PUBLIC MESSAGE

- Consult your Transit Authority code list for the public service announcement to be displayed.
- Press **P/R**.

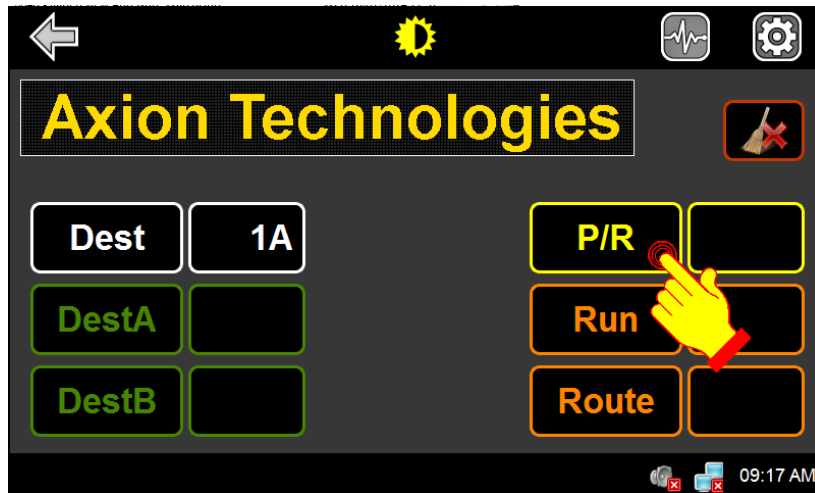

Figure 12: Public Message Button

- Using the alphanumeric keypad, enter the code of the public message to be added to the destination displayed on the signs. Depending on the option chosen (See Section 1.1.1.8.10), the entering of a public message number may be protected by a password (default or factory programmed 1234). To remove the public message, enter 0 as the public message code.
- Press **ENTER** to confirm your choice.



Figure 13: Entering Public Message Number

When the message is entered, the OSCP displays the following information:

- Public message number is displayed in the **P/R** field.
- Front destination content (message) and public message alternately display in the text field.



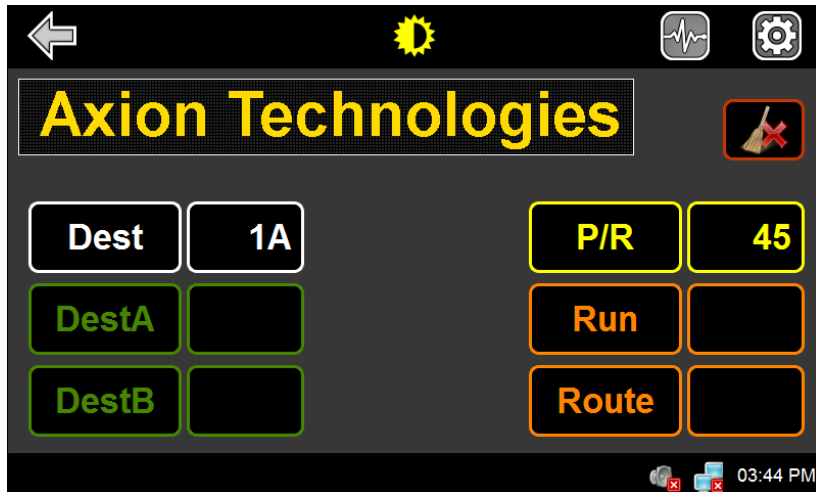

Figure 14: Front Destination Sign Content Display



Figure 15: Public Message Display

### 1.1.1.5. ENTERING TEXT FOR KEY NUMBER SIGN

If you have a key number sign configured in your network, the **Run** button is enabled which allows to enter text. Otherwise, the button is greyed out and disabled.

- Press **Run**.

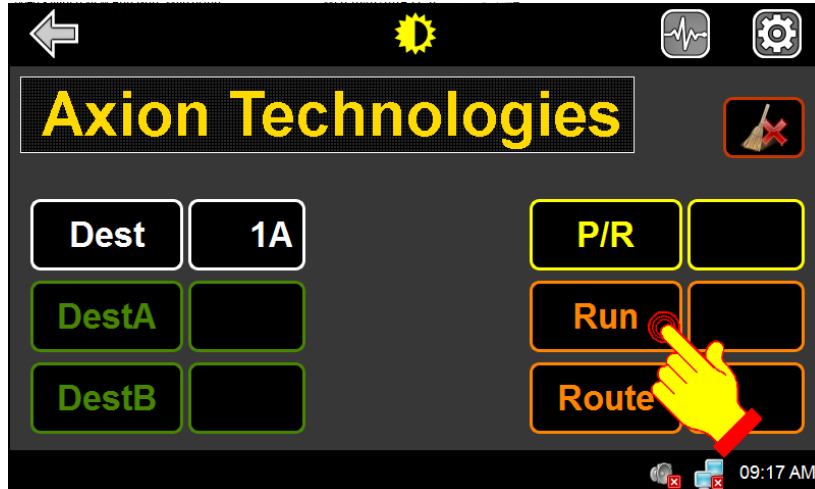



Figure 16: Entering Key Number Text

- Using the alphanumeric keyboard or the full keyboard , enter the text to be displayed on the key number.
- Press **ENTER** to validate your choice.

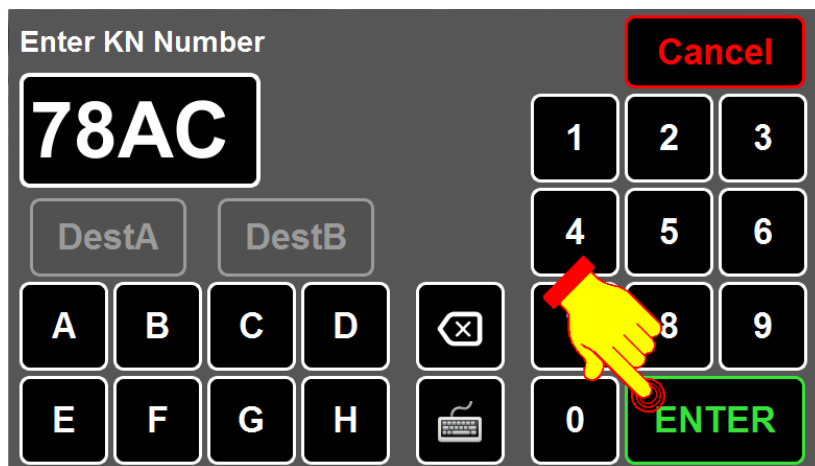

Figure 17: Entering Key Number Validation

When the key number text is entered, the OSCP displays the following information:

- Key Number text is displayed in the **Run** field.

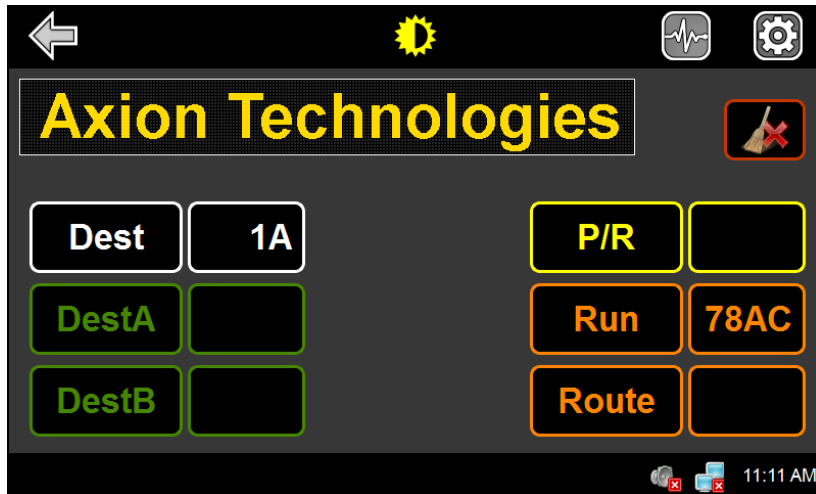

Figure 18: Key Number Display

### 1.1.1.6. SETTING SCREEN BRIGHTNESS

- Press **Intensity**

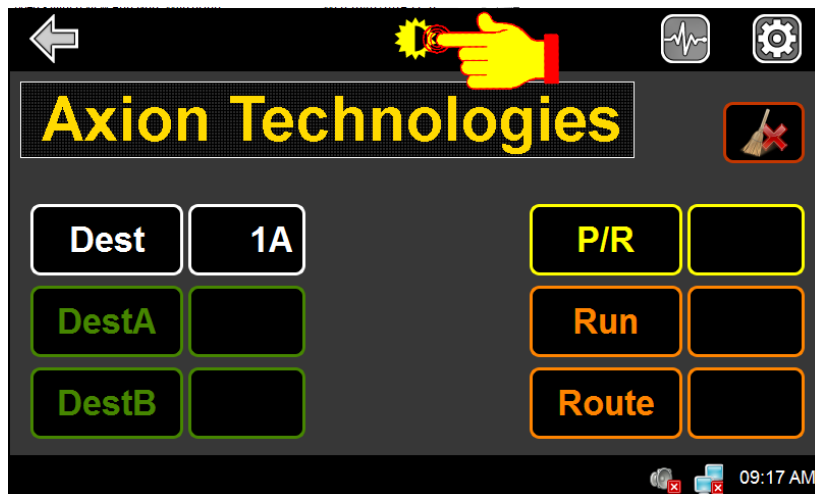

Figure 19: Intensity Button

- Use the two arrows to set to the desired brightness between 10% (low brightness) and 100% (full brightness).
- Press **Exit** to confirm the brightness level.

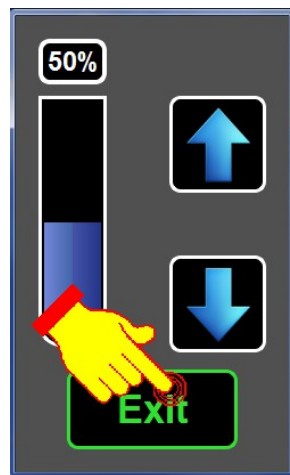

Figure 20: Brightness Setting

### 1.1.1.7. SIGNS SYSTEM DIAGNOSTIC

The Signs System Diagnostic can be selected from the DESTINATIONS MANAGEMENT INTERFACE by pressing the **Diagnostic** icon.

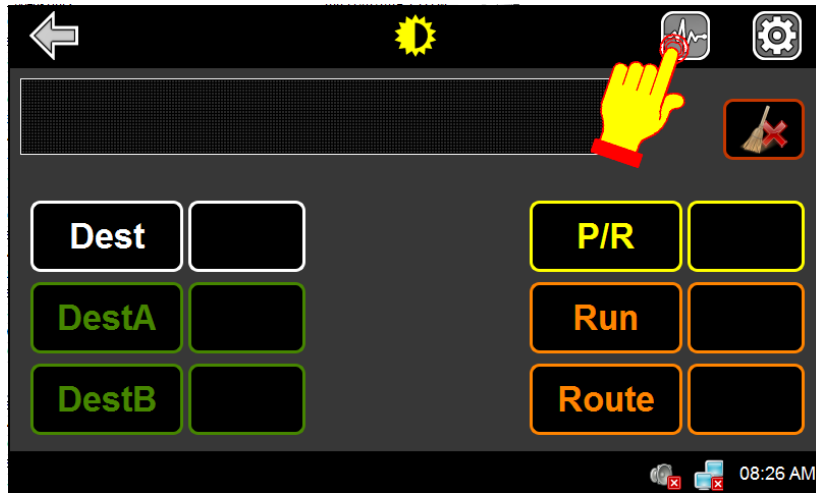

Figure 21: Signs System Diagnostic – Diagnostic Icon

The maintenance password (default or factory programmed 1234) is required to access the EDSS diagnostic menu.

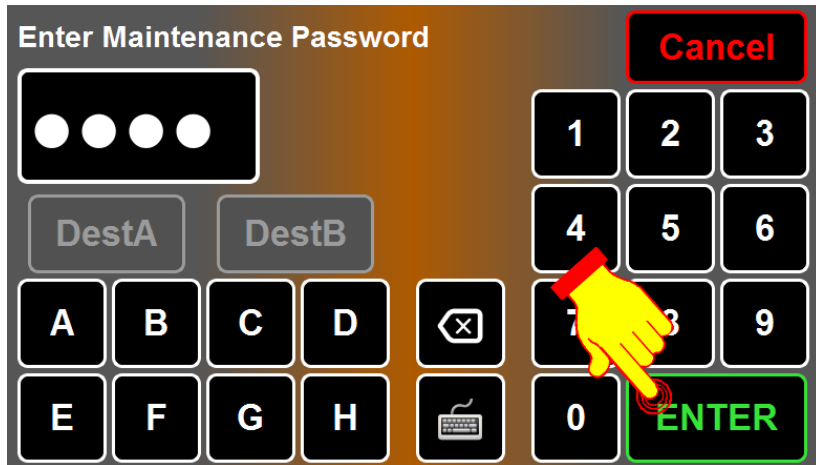

Figure 22: Signs System Diagnostic – Maintenance Password

The following table and windows present the available options.

Button	Function
<b>Reboot</b>	<ul style="list-style-type: none"> <li>• Reboot OSCP.</li> </ul>
<b>Signs - Test</b>	<ul style="list-style-type: none"> <li>• Show test sequences to ensure that signs are operational.</li> </ul>
<b>Signs – Diag.</b>	<ul style="list-style-type: none"> <li>• Display messages of errors that may occur on the EDSS.</li> </ul>
<b>Signs – DB ver.</b>	<ul style="list-style-type: none"> <li>• Show current and next databases stored in the OSCP.</li> </ul>
<b>Signs - Network</b>	<ul style="list-style-type: none"> <li>• Display ID and versions of signs entered in the database.</li> </ul>

Table 2: Diagnostic Menu Options & Functions

To return to the DESTINATIONS MANAGEMENT INTERFACE, press the Previous Menu icon.

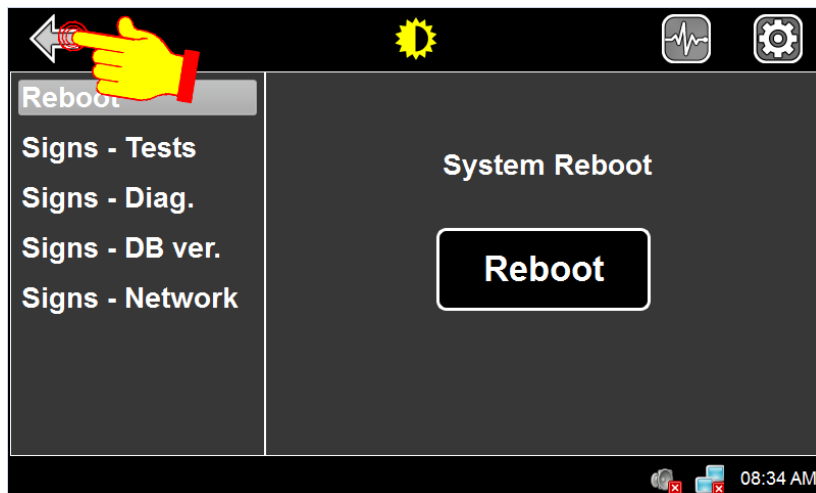

Figure 23: Signs System Diagnostic – Previous Icon

### 1.1.1.7.1. REBOOTING OSCP

- From the SIGNS SYSTEM DIAGNOSTIC screen select **Reboot**.

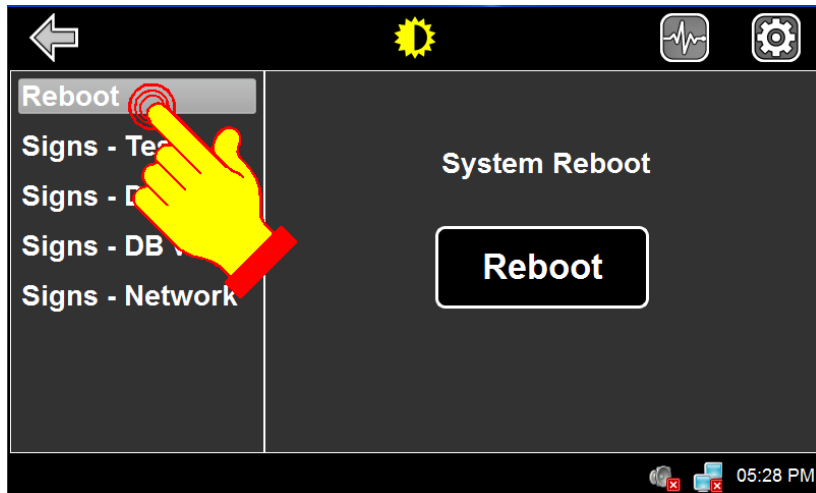

Figure 24: Signs System Diagnostic – Reboot Option

- Press **Reboot**.

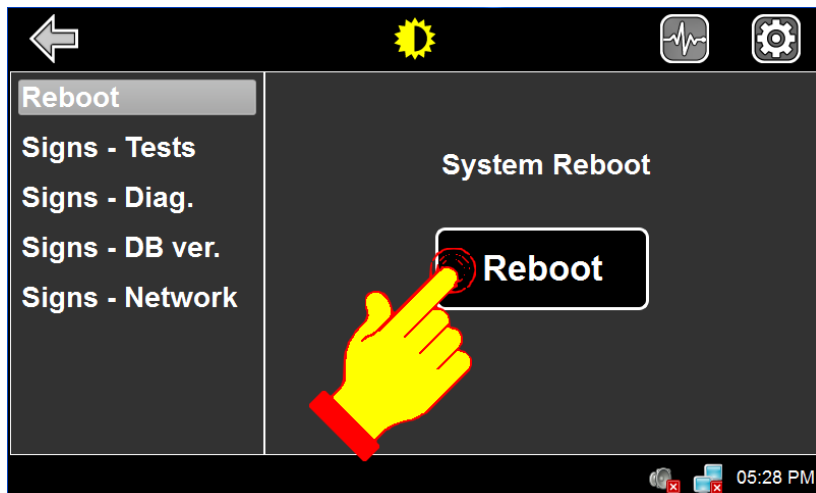

Figure 25: Signs System Diagnostic – Reboot Button

- OSCP reboots.

### 1.1.1.7.2. ACTIVATING SIGNS TESTS

This option activates different test patterns on the signs.

- From the SIGNS SYSTEM DIAGNOSTIC screen select **Signs - Tests**.

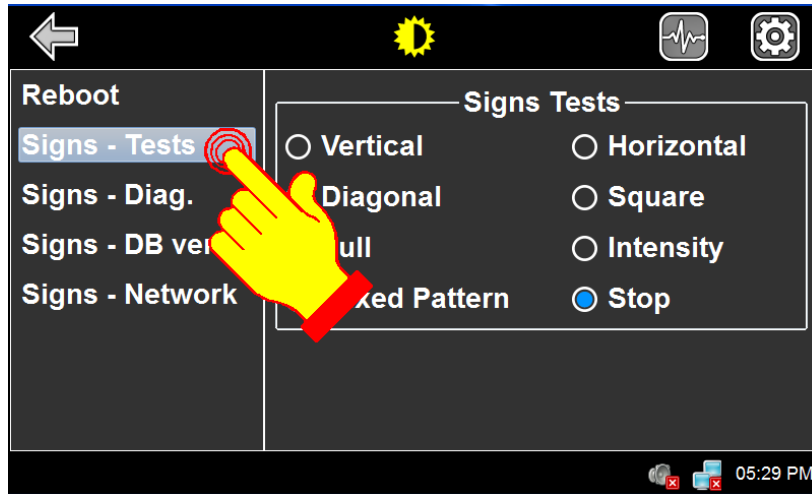

Figure 26: Signs System Diagnostic – Signs - Tests

- To select the desired test mode, check the required test checkbox in the right side section of the window:

Button	Function
<b>Vertical</b>	<ul style="list-style-type: none"> <li>Display vertical lines on signs.</li> </ul>
<b>Diagonal</b>	<ul style="list-style-type: none"> <li>Display diagonal lines on signs.</li> </ul>
<b>Full</b>	<ul style="list-style-type: none"> <li>Illuminate all LEDs on signs</li> </ul>
<b>Mixed Pattern</b>	<ul style="list-style-type: none"> <li>Display different test patterns:                             <ul style="list-style-type: none"> <li>- Alternating squares on and off</li> <li>- Alternating lines on and off (one line every four lines)</li> <li>- Axion's logo;</li> <li>- Size of the sign in terms of lines and columns;</li> </ul> </li> </ul>
<b>Horizontal</b>	<ul style="list-style-type: none"> <li>Display horizontal lines on signs.</li> </ul>
<b>Square</b>	<ul style="list-style-type: none"> <li>Display alternately solid (Lit LEDs) and blank squares (Unlit LEDs)</li> </ul>
<b>Intensity</b>	<ul style="list-style-type: none"> <li>Check photosensor functionality, display intensity level on each sign.</li> </ul>
<b>Stop</b>	<ul style="list-style-type: none"> <li>Stop the test mode and clear all signs</li> </ul>

Table 3: Signs Test Mode



### 1.1.1.7.3. READING SIGNS DIAGNOSTIC

This option is used to determine which signs is in error and identify the error types.

The errors are displayed in the status bar. The following errors can be displayed.





Error Icon	Description
	<ul style="list-style-type: none"> <li>Indicates a communication failure between the OSCP and one or more signs.</li> </ul>
	<ul style="list-style-type: none"> <li>Indicates that the ID of the sign present on the network differs from that configured on the OSCP.</li> </ul>
	<ul style="list-style-type: none"> <li>Indicates that the OSCP sign database does not match the sign configuration.</li> </ul>
	<ul style="list-style-type: none"> <li>Indicates a photosensor error on one or more signs.</li> </ul>
	<ul style="list-style-type: none"> <li>Indicates that the sign present on the network does not support the operating frequency configured on the OSCP.</li> </ul>

Table 4: Signs Error

To determine which signs are in error:

- From the SIGNS SYSTEM DIAGNOSTIC screen select **Signs – Diag.**
- If an error is detected on a sign, the corresponding error icon is displayed on the row of the sign.

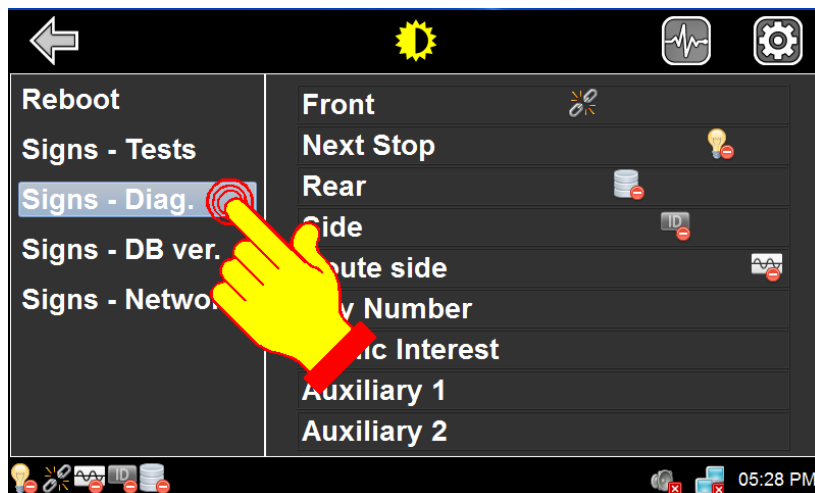

Figure 27: Signs System Diagnostic - Signs – Diag.

### 1.1.1.7.4. READING SIGNS DATABASE VERSION

This option is used to validate the version of the databases present on the OSCP.

- From the SIGNS SYSTEM DIAGNOSTIC screen select **Signs – DB ver.**

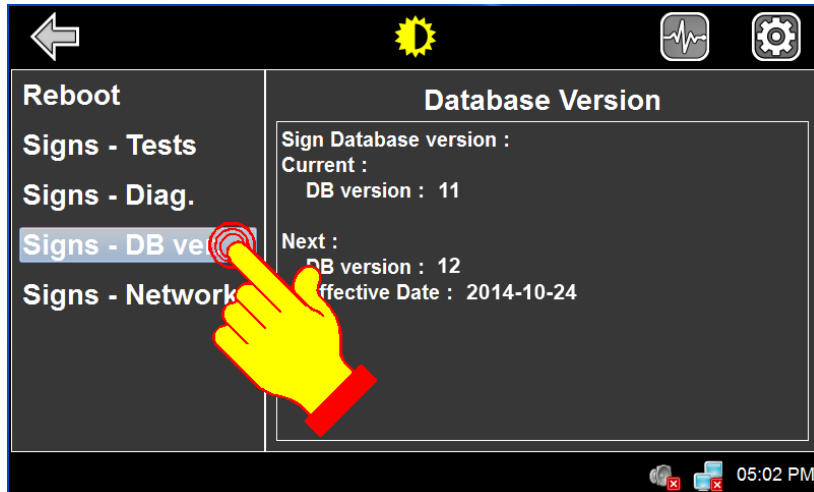

Figure 28: Signs System Diagnostic – Signs DB Version

- The version of the current database displays.
- The version and the effective date of the next database display.

<b>Current:</b>		Current version of the database
<b>DB Version</b>	<b>11</b>	Current version ID
<b>Next:</b>		Next version of the database
<b>DB version</b>	<b>12</b>	Next version ID
<b>Effective date</b>	<b>2014-10-24</b>	Effective date of the next database

### 1.1.1.7.5. DISPLAYING/CONFIGURING SIGNS NETWORK

This option is used to display or configure the signs network.

To display the signs network:

- From the SIGNS SYSTEM DIAGNOSTIC screen select **Signs – Network**.

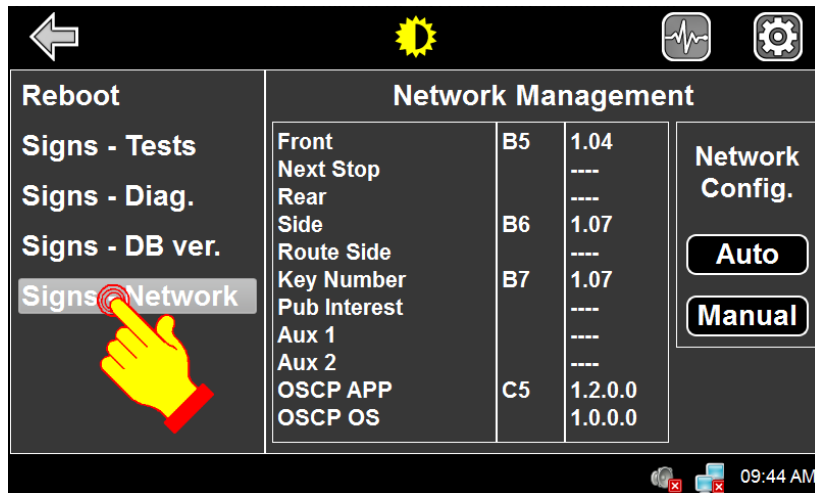

Figure 29: Signs System Diagnostic – Signs Network

- The first column shows all signs that could be present on the network.
- The second column shows the sign ID of each configured sign. If there is no code associated with a sign, this sign is not present on the network. To see the valid identification code, refer to the Sign Identification Table in the Section 7 of the Manual entitled 3042145\_User Man\_Série 40.
- The third column shows the version of the signs present on the network.

Automatic configuration of the signs network.

- To automatically configure the network, press **Auto**.

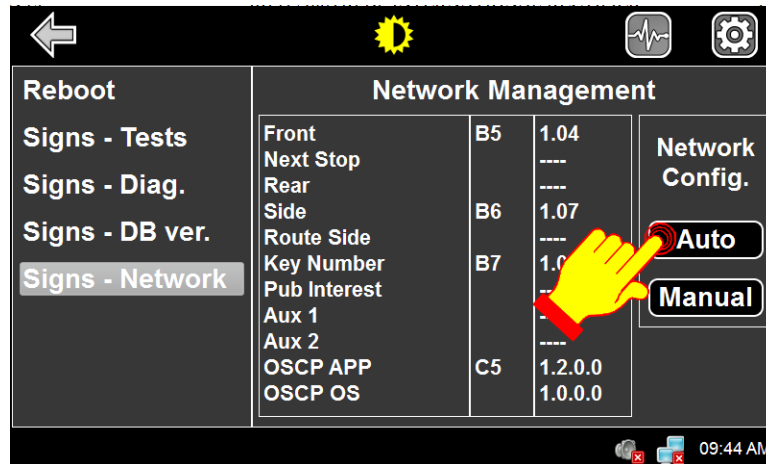

Figure 30: Signs Network Automatic Configuration

Manual configuration of the signs network.

- To manually configure the network, press **Manual**.

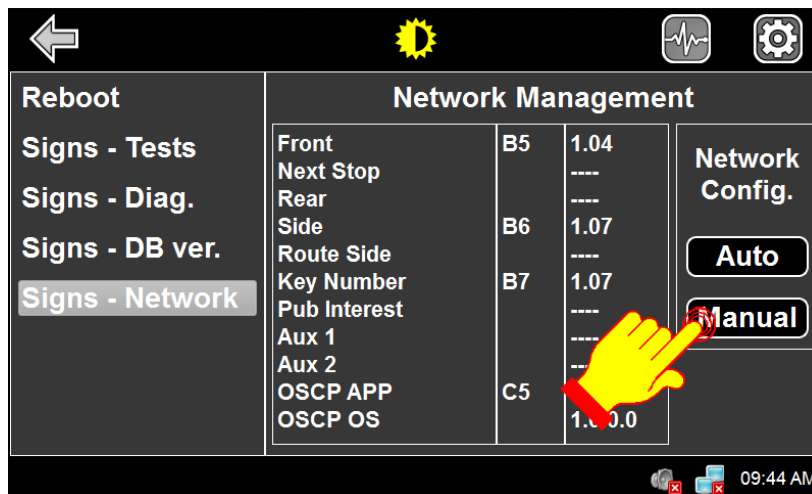

Figure 31: Signs Network Manual Configuration

- To configure a sign on the network, press the associated field to highlight it and enter the sign ID of the desired sign using the keypad. For valid ID code, refer to the Sign Identification Table in the Section 7 of the Manual entitled 3042145\_User Man\_Série 40.
- Once all signs are selected and identified, press **ENTER** to validate your choice.

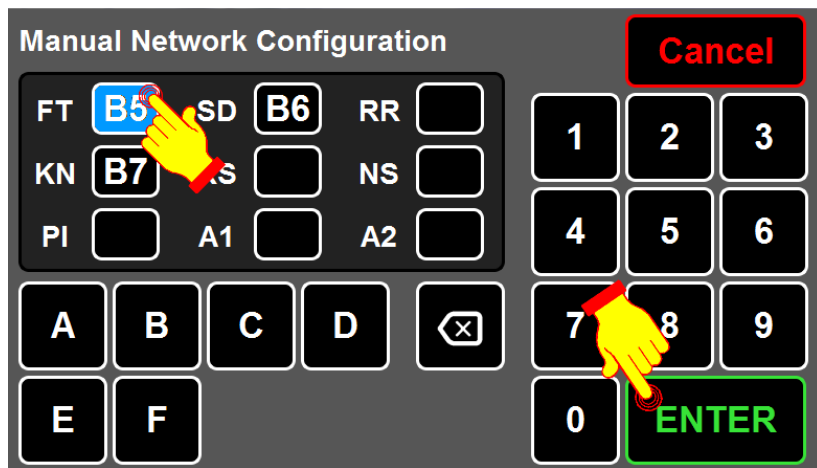

Figure 32: Sign Network Configuration Validation

### 1.1.1.8. SIGNS SYSTEM CONFIGURATION

The SIGNS SYSTEM CONFIGURATION can be selected from the DESTINATIONS MANAGEMENT INTERFACE by pressing the **Configuration** icon.

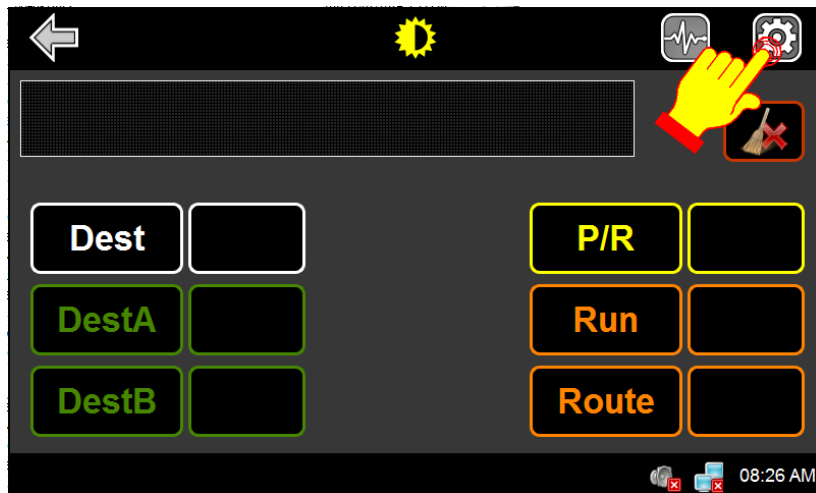

Figure 33: Signs System Configuration Icon

The maintenance password (default or factory programmed 1234) is required to access the EDSS configuration menu.

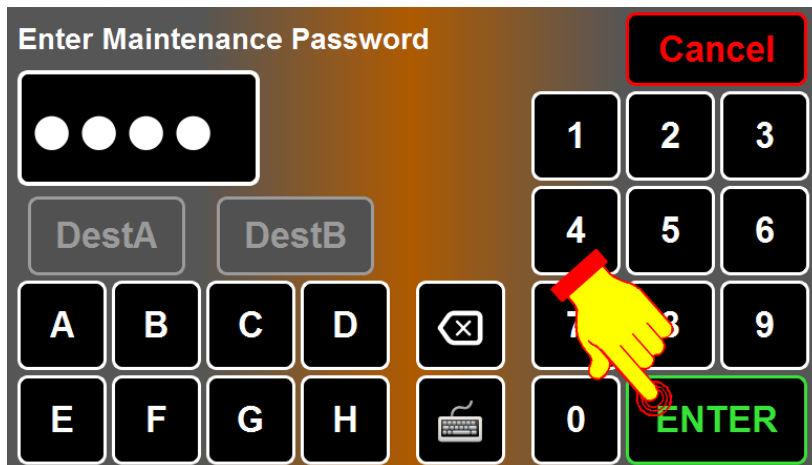

Figure 34: Signs System Configuration – Maintenance Password

The following table presents the available options.

Option	Function
<b>Delays</b>	<ul style="list-style-type: none"> <li>• Modify system shutdown delay.</li> <li>• Modify Yield message display time.</li> </ul>
<b>Emergency Mngt</b>	<ul style="list-style-type: none"> <li>• Set emergency stop mode.</li> <li>• Set emergency reading (on/off).</li> </ul>
<b>Passwords</b>	<ul style="list-style-type: none"> <li>• Modify passwords for public message and emergency stop..</li> </ul>
<b>Special Options</b>	<ul style="list-style-type: none"> <li>• Change operating frequency of the sign CPU boards.</li> <li>• Activate automatic test mode.</li> <li>• Activate fonts table including accentuated upper-case letters.</li> </ul>
<b>User interface</b>	<ul style="list-style-type: none"> <li>• Activate two functions:                             <ul style="list-style-type: none"> <li>- Automatic destination at power-up.</li> <li>- Permanent public message.</li> </ul> </li> </ul>

Table 5: Configuration Menu Options & Functions

To return to the DESTINATIONS MANAGEMENT INTERFACE, press the Previous Menu icon

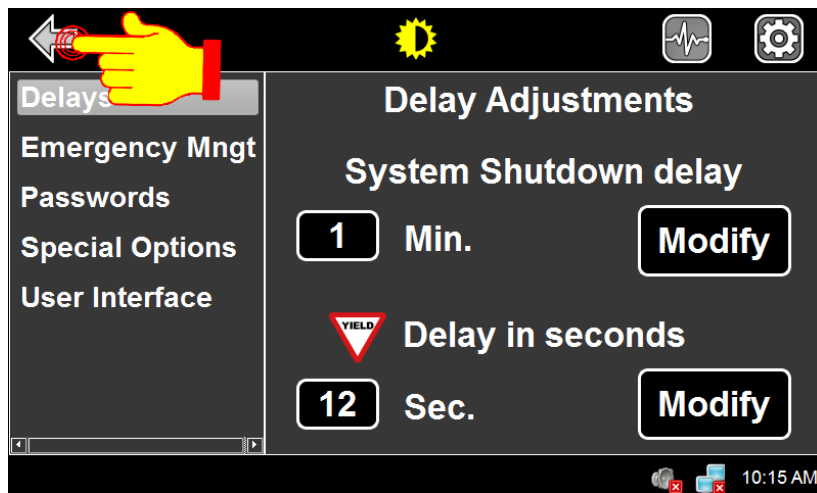

Figure 35: Previous Menu Icon

### 1.1.1.8.1. SETTING SYSTEM SHUTDOWN DELAY

- From the SIGNS SYSTEM CONFIGURATION screen select **Delays**.

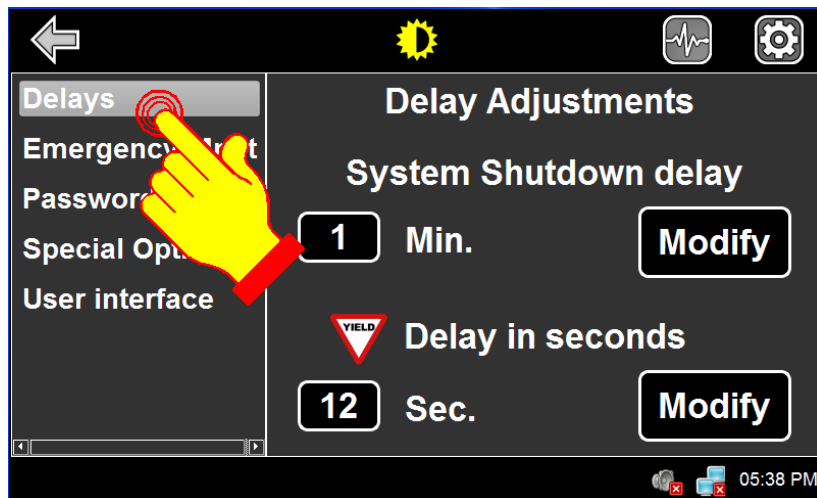

Figure 36: Signs System Configuration – Delay Option

- EDSS remains ON for a programmed period of time when the vehicle is stopped and ignition turned “OFF”. For no delay, set delay to “0” minutes
- Press **Modify** to change the programmed shutdown delay.

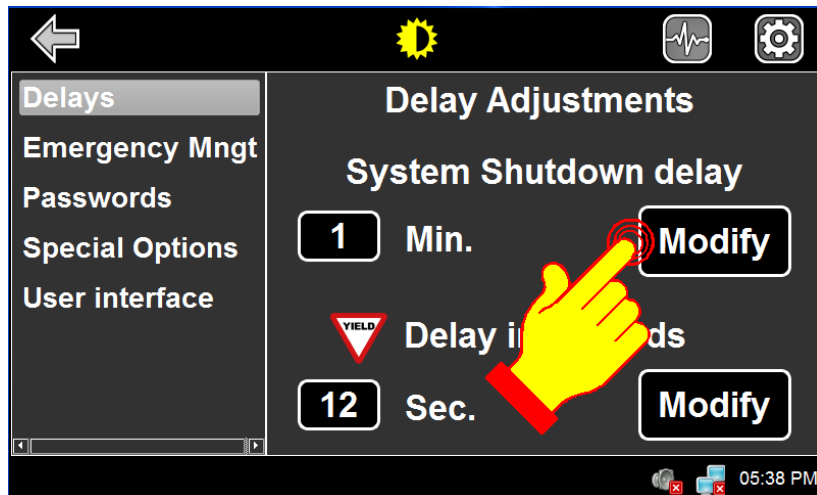

Figure 37: Setting System Shutdown Delay



### 1.1.1.8.2. SETTING YIELD FUNCTION DELAY

- From the SIGNS SYSTEM CONFIGURATION screen select **Delays**.

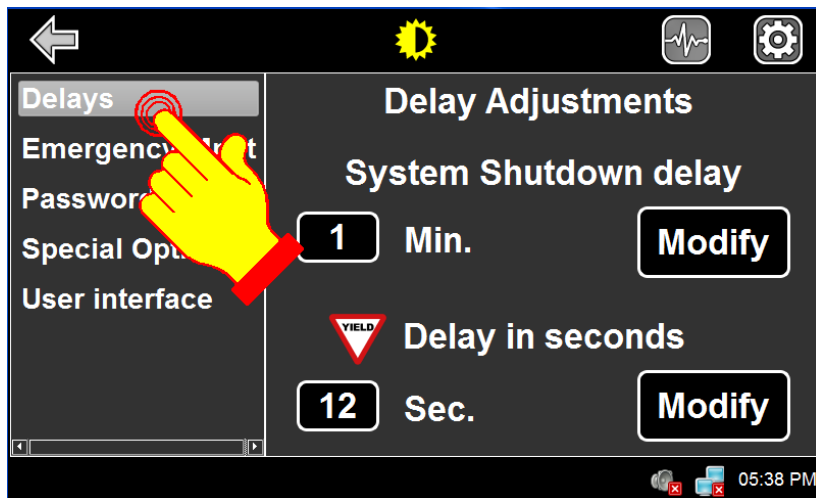

Figure 38: Signs System Configuration – Delay Option

- Rear sign displays YIELD message for a minimum programmed period of time upon activation of the Yield Switch. For no delay, set delay to “0” second.
- Press **Modify** to change the yield delay value.

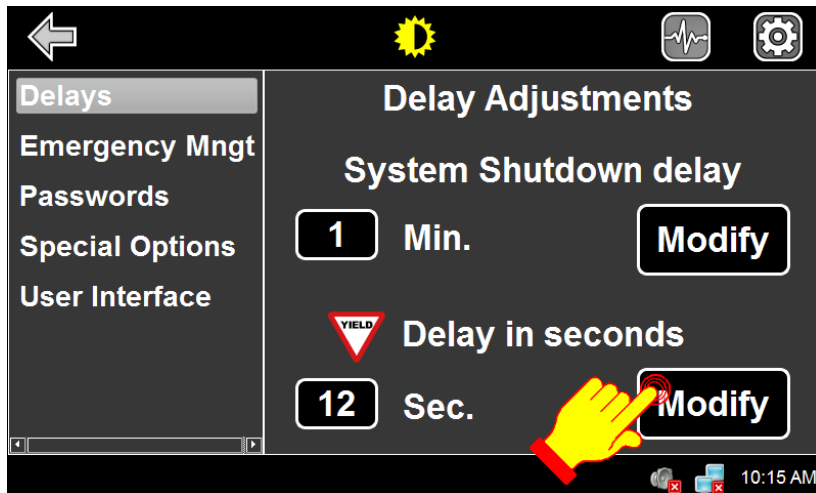

Figure 39: Setting Yield Function Delay

### 1.1.1.8.3. SETTING EMERGENCY SWITCH STOP MODE

- From the SIGNS SYSTEM CONFIGURATION screen select **Emergency Mngt.**

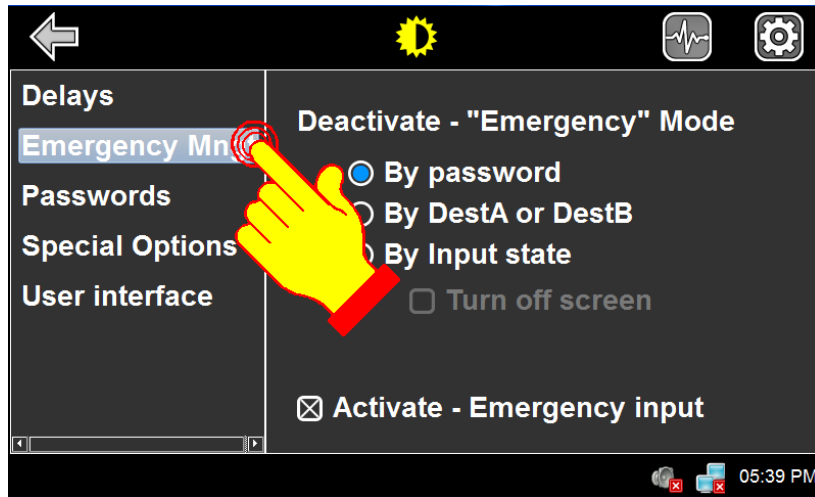

Figure 40: Setting Emergency Switch Stop Mode

- Select the appropriate mode according to your application

Mode	Description
By password	Stops the emergency message when the emergency switch is set to OFF and the emergency password (default "00") is entered.
By DestA or DestB	Stops the emergency message when the emergency switch is set to OFF and DESTA or DESTB is pressed followed by ENTER. Note: It is possible to provide a new destination number between DEST A/B and ENTER.
By Input State	The emergency mode is stopped by turning off the emergency switch. For this option, you can also select the Turn off screen option to turn off the LCD of the OSCP when the emergency is activated.
Activate – Emergency input	If checked, the Emergency switch function is activated. Otherwise, it is disabled

Table 6: Configuration Menu Options & Functions

### 1.1.1.8.4. MODIFYING PUBLIC MESSAGE PASSWORD

- From the SIGNS SYSTEM CONFIGURATION screen select **Passwords**.

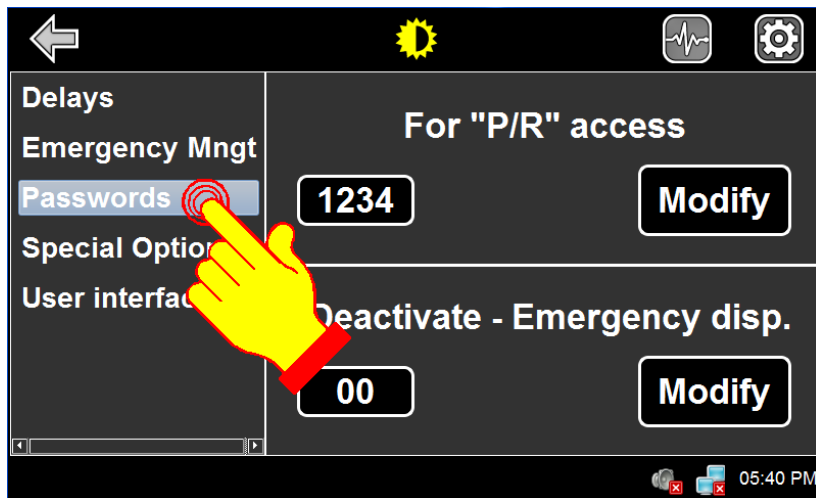

Figure 41: Setting Public Message Password

- Press **Modify** in section For “P/R” access.

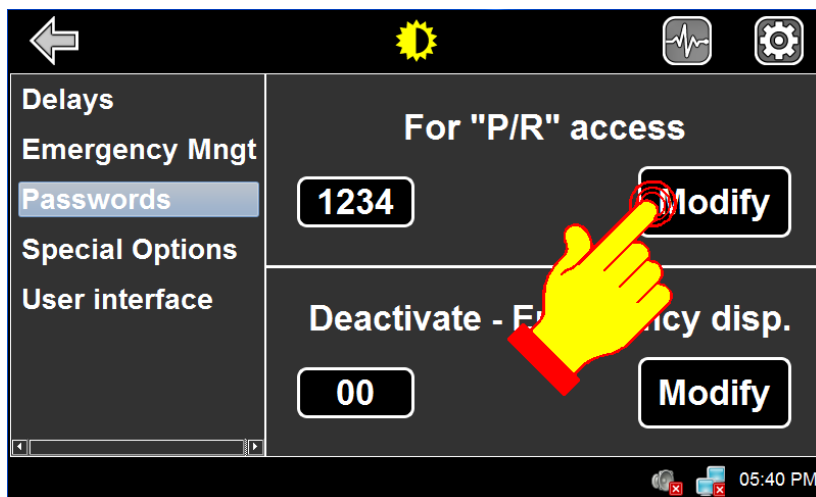

Figure 42: Modifying Public Message Password - P/R

- Using the alphanumeric keyboard, enter the new password.
- Press **ENTER** to validate your choice.

Note: If a password is required and you have forgotten it, enter the hardcoded value “**9595**”.

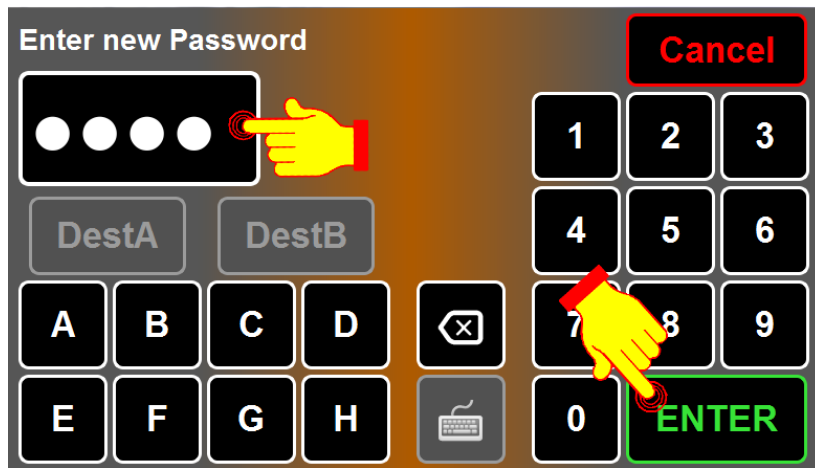

Figure 43: Validating New P/R Password

### 1.1.1.8.5. MODIFYING EMERGENCY DEACTIVATE PASSWORD

- From the SIGNS SYSTEM CONFIGURATION screen select **Passwords**.

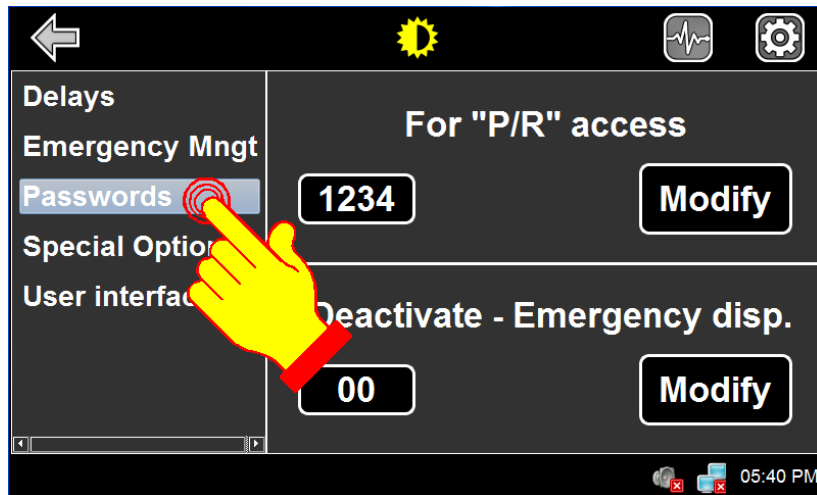

Figure 44: Signs System Configuration – Passwords Option

- Press **Modify** in section **Deactivate – Emergency disp.**

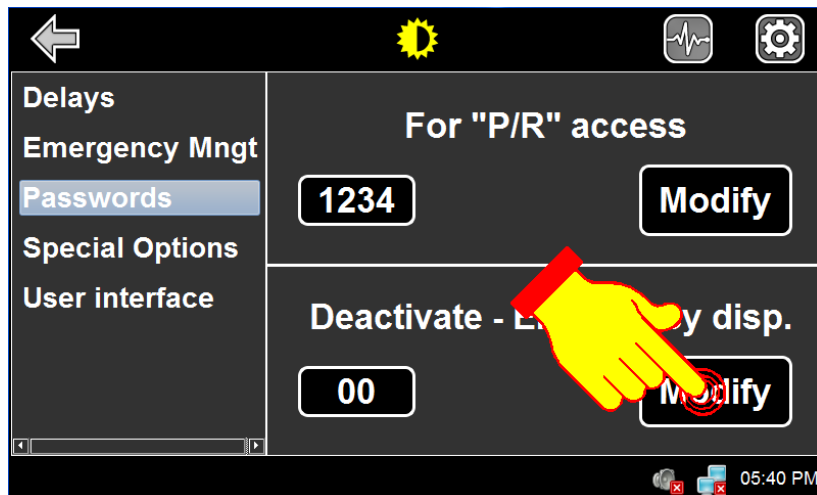

Figure 45: Signs System Configuration – P/R Deactivate

- Using the alphanumeric keyboard, enter the new password.
- Press ENTER to validate your choice.
- Note: If a password is required and you have forgotten it, enter the hardcoded value “95”.



Figure 46: Validating Emergency Deactivate Password

### 1.1.1.8.6. SELECTING SIGN CPU FREQUENCY

This option allows to modify the operating frequency of the signs.

- From the SIGNS SYSTEM CONFIGURATION screen select **Special options**.
- Select the desired frequency by selecting **Freq1** (29.4912 MHz.) or **Freq2** (22,1148 MHz).

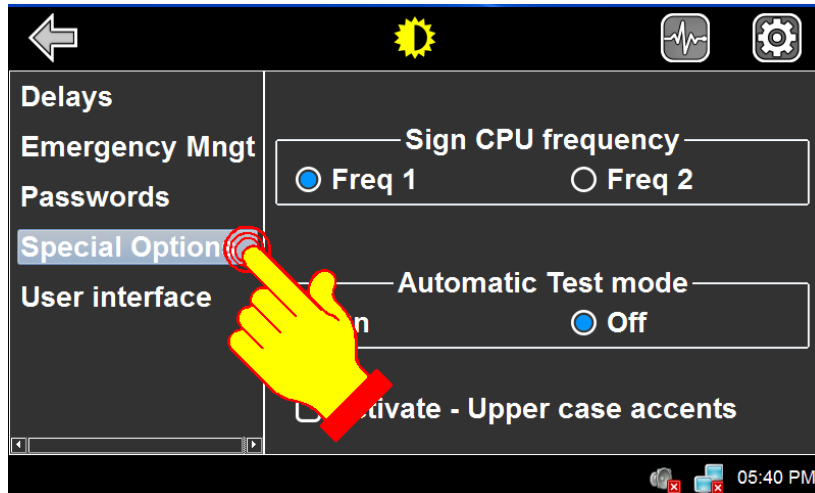

Figure 47: Sign CPU Frequency Selection

### 1.1.1.8.7. ACTIVATING AUTOMATIC TEST MODE

The test mode allows the signs to display messages in sequence to ensure they properly operate. The message sequence is as follows:

- Lit and unlit squares display alternately.
  - Lit and unlit lines display alternately (one lit line every four lines).
  - Axion's logo.
  - Sign dimensions in terms of number of lines and columns.
- From the SIGNS SYSTEM CONFIGURATION screen select **Special options**.

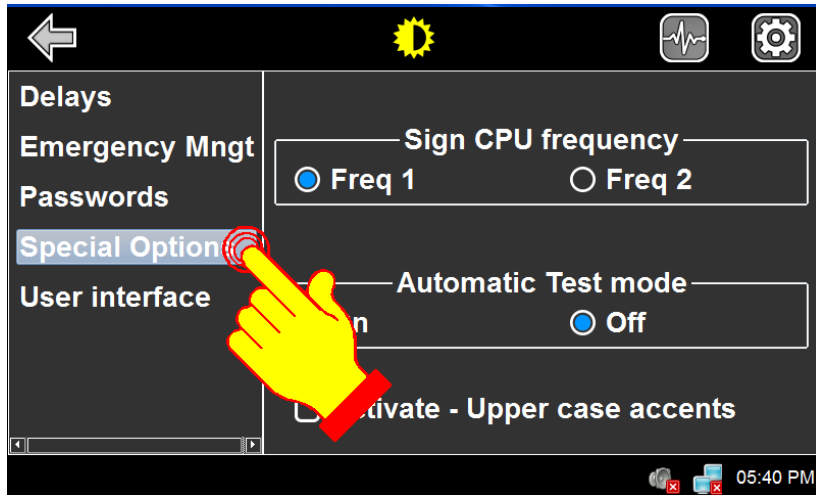

Figure 48: Activation/Deactivation Automatic Test Mode

- Turn on/off the Automatic Test mode by selecting the radio button.

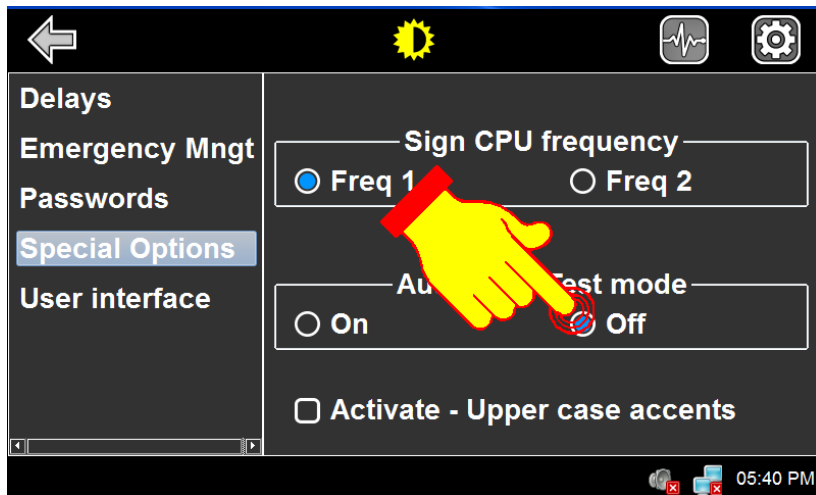

Figure 49: Activation/Deactivation Automatic Test Mode



### 1.1.1.8.8. ACTIVATING ACCENTUATED UPPERCASE

Activation of the font set with accentuated uppercase used by the signs on the network.

- From the SIGNS SYSTEM CONFIGURATION screen select **Special options**.

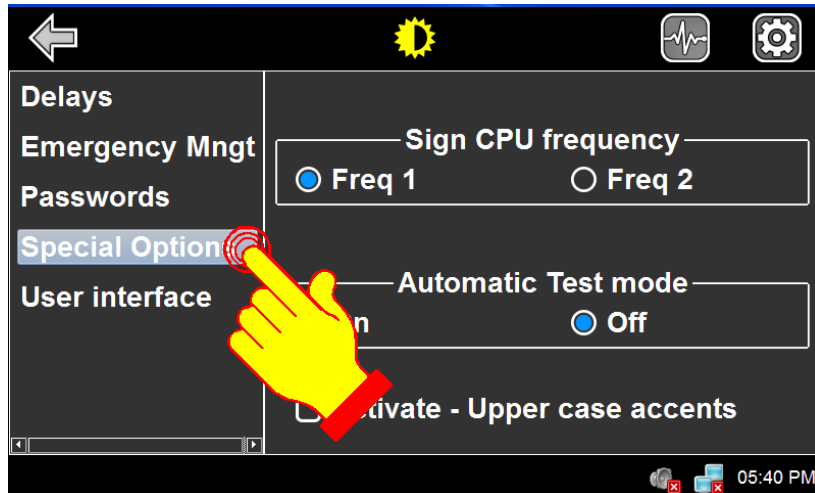

Figure 50: Accentuated Uppercase – Special Options

- Select **Activate – Upper case accents**.

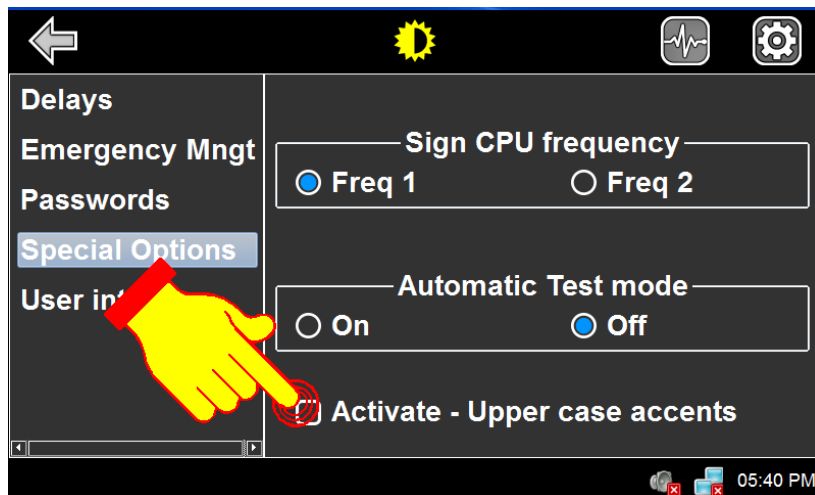

Figure 51: Activation of Upper Case Accents

### 1.1.1.8.9. ACTIVATING DESTINATION ON START-UP

When you turn on the bus ignition, the OSCP can automatically recall the last destination number entered before you switched off the bus engine.

- From the SIGNS SYSTEM CONFIGURATION screen select **User interface**.



Figure 52: Activating Destination on Start-up – User Interface Option

- Select **Activate – Dest. On Start-up**.



Figure 53: Activating Destination on Start-Up

### 1.1.1.8.10. ACTIVATING PERMANENT PUBLIC MESSAGE

When you turn on the bus ignition, the OSCP can automatically recall the last public message number entered before you switched off the bus engine. Grant limited access to public service announcements by requesting password.

- From the SIGNS SYSTEM CONFIGURATION screen select **User interface**.



Figure 54: Activating Permanent P/R – User Interface Option

- Select **Activate – Permanent P/R**.



Figure 55: Activation of Permanent Public Message

### 1.1.2. OSCP DIAGNOSTICS INTERFACE

We access the general diagnostics window from the desktop window. The maintenance password (default or factory programmed 1234) is required to access this menu.

- From the Desktop Window, press the DIAGNOSTICS icon.

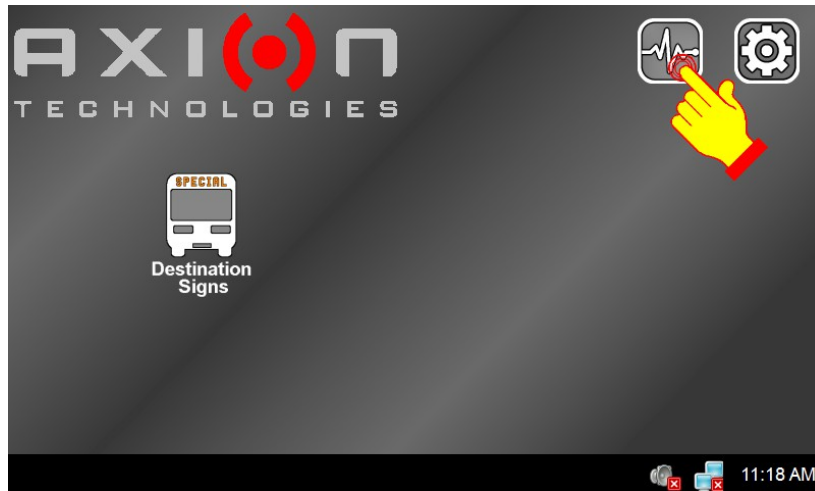

Figure 56: Main Screen Diagnostic Icon

- Using the alphanumeric keyboard, enter the maintenance password (default or factory programmed 1234).

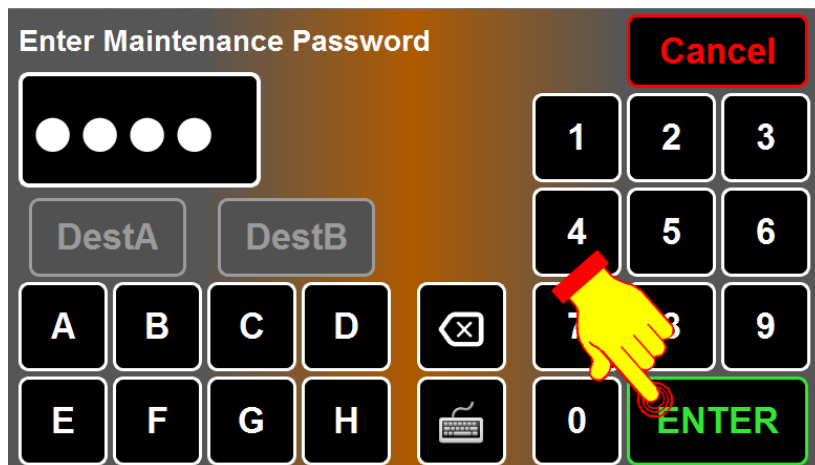

Figure 57: Maintenance Password

Option	Function
Network Interf.	<ul style="list-style-type: none"> <li>Display OSCP network interfaces.</li> </ul>
Wi-Fi Config.	<ul style="list-style-type: none"> <li>Display:                             <ul style="list-style-type: none"> <li>OSCP Wi-Fi configuration</li> <li>FTP connection parameters.</li> </ul> </li> </ul>
Downloaded DB	<ul style="list-style-type: none"> <li>Display download statistics.</li> </ul>

Table 7: General Diagnostics

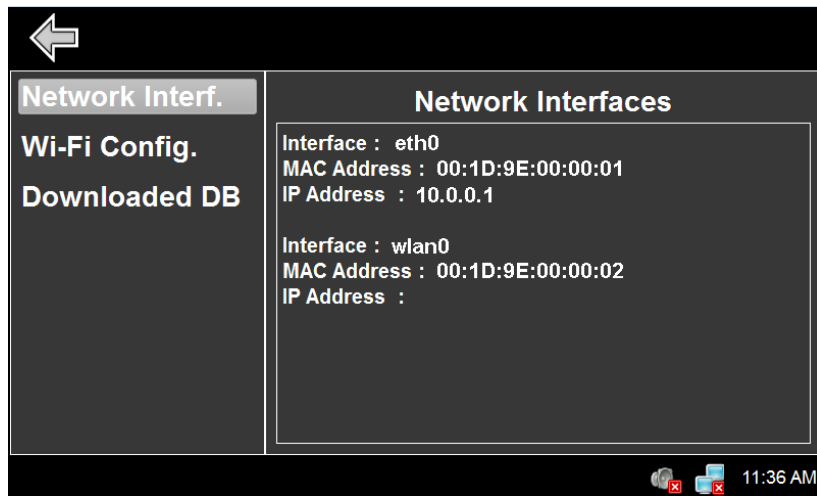



Figure 58: Network Interface

To return to the Desktop Window, press the Previous window icon (  ).

### 1.1.2.1. DISPLAYING NETWORK INTERFACE

Display the OSCP networks connections parameters (MAC and IP address).

- From the OSCP DIAGNOSTICS INTERFACE screen select **Network Interf.**

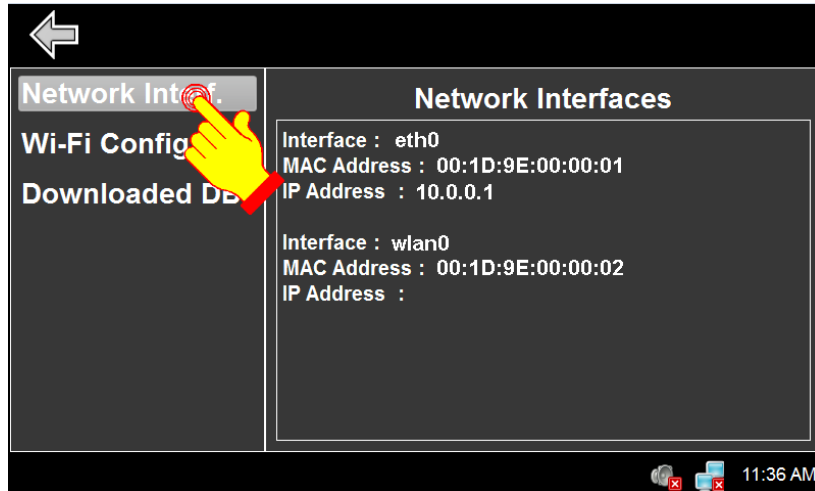

Figure 59: Displaying Network Interface

### 1.1.2.2. DISPLAYING Wi-Fi CONFIGURATION

Display the OSCP Wi-Fi configuration and the FTP connection parameters.

- From the OSCP DIAGNOSTICS INTERFACE screen select **Wi-Fi Config**.

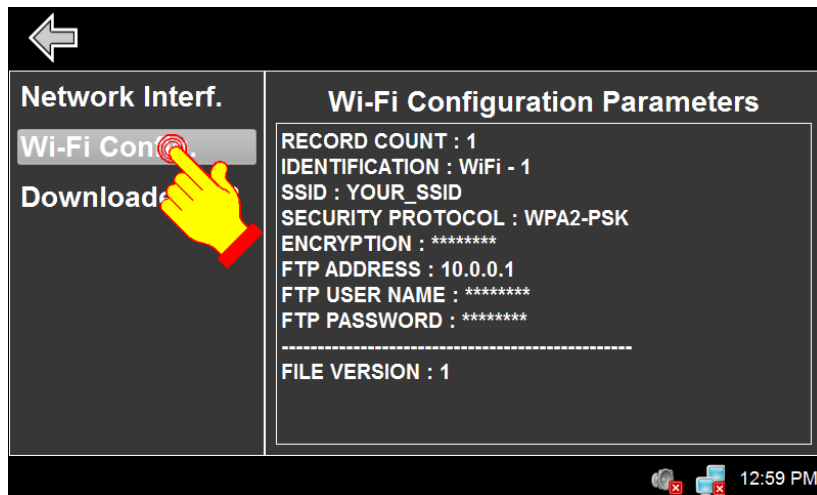

Figure 60: Displaying Wi-Fi Config

### 1.1.2.3. DISPLAYING THE DOWNLOADED DATABASE STATISTICS

Display the OSCP the downloaded database parameters.

- From the OSCP DIAGNOSTICS INTERFACE screen select **Downloaded DB**.

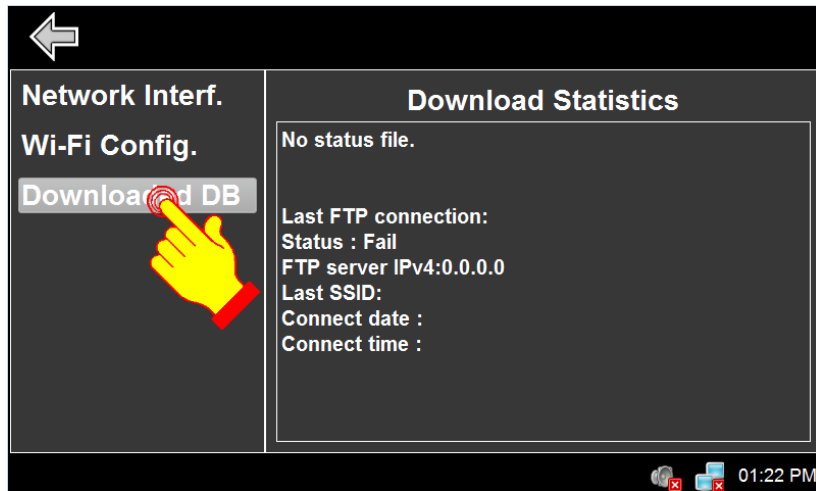

Figure 61: General Diagnostics – Downloaded DB Option

Status	Description
No status file	No Wi-Fi transfer
	or
Database ID: xx	Last uploaded database ID number
Database Transfer Status:	Database transfer status <ul style="list-style-type: none"> <li>• Error</li> <li>• Success</li> <li>• Incomplete</li> </ul>
Last status: yyyy-mm-dd	Date of the last upload

Last FTP Connection	
Status	FTP connection status <ul style="list-style-type: none"> <li>• Success</li> <li>• Fail</li> </ul>
FTP server IPv4:	IPv4 address of last FTP connection
Last SSID	Last SSID name of last FTP connection
Connect date: Connect time:	Last “date and time” connection to FTP



### 1.1.3. OSCP GENERAL CONFIGURATION INTERFACE

We access the general configuration window from the desktop window. The maintenance password is required to access this menu.

- From the Desktop Window, press the **CONFIGURATION** icon.



Figure 62: Main Screen

- Using the alphanumeric keyboard, enter the maintenance password (default or factory programmed 1234).

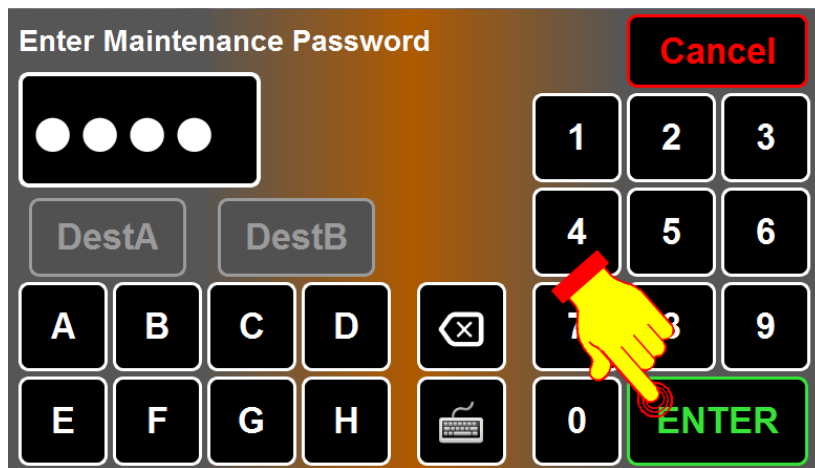

Figure 63: Maintenance Password

Option	Function
Date and Time	<ul style="list-style-type: none"> <li>Modify OSCP date and time.</li> </ul>
RS232 Protocol	<ul style="list-style-type: none"> <li>Display protocol used by the OSCP serial link.</li> </ul>
User Interface	<ul style="list-style-type: none"> <li>Modify some details of the behavior of the OSCP.</li> </ul>
Vehicle number	<ul style="list-style-type: none"> <li>Modify vehicle number.</li> </ul>

Table 8: General Diagnostics

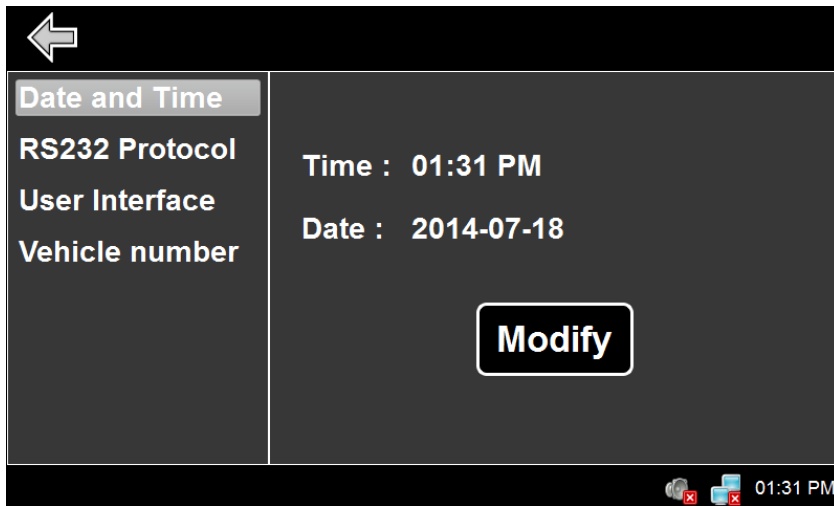



Figure 64: General Config Interface

To return to the Desktop Window, press the Previous window icon (  ).

### 1.1.3.1. SETTING DATE AND TIME

- From the OSCP CONFIGURATION INTERFACE screen select **Date and Time**.

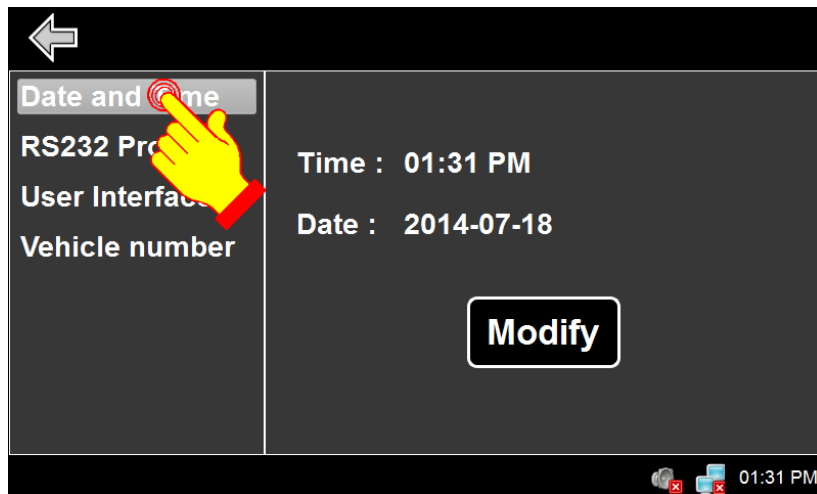

Figure 65: Setting Date and Time

- The change either the date and time, press **Modify**.

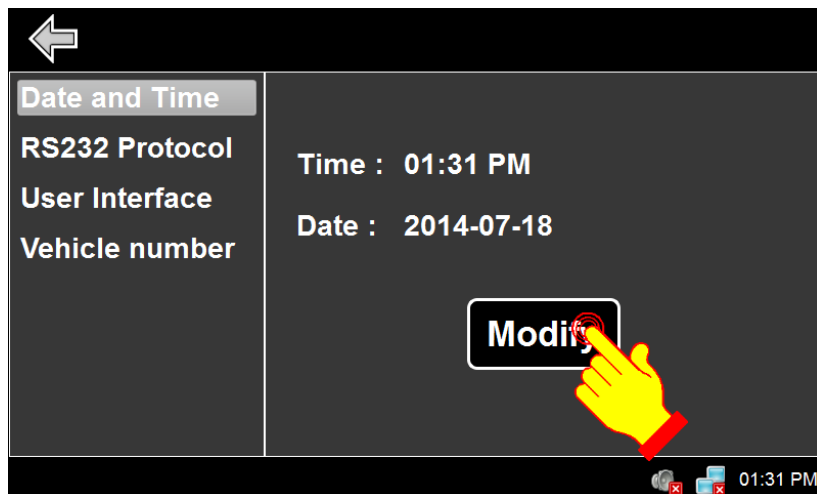

Figure 66: Date and Time Modify Button

- Arrows allow to modify time, year or month. Click date in the calendar to modify the date.
  - To modify time:
    - Press hours, minutes or seconds and use up/down arrows to modify.
  - To modify year:
    - Use up/down arrows next to year to modify.
  - To modify month:
    - Use left/right arrows to change month or press the month name and select from the list
  - To modify date:
    - Highlight the desired date by selecting a date in the calendar.

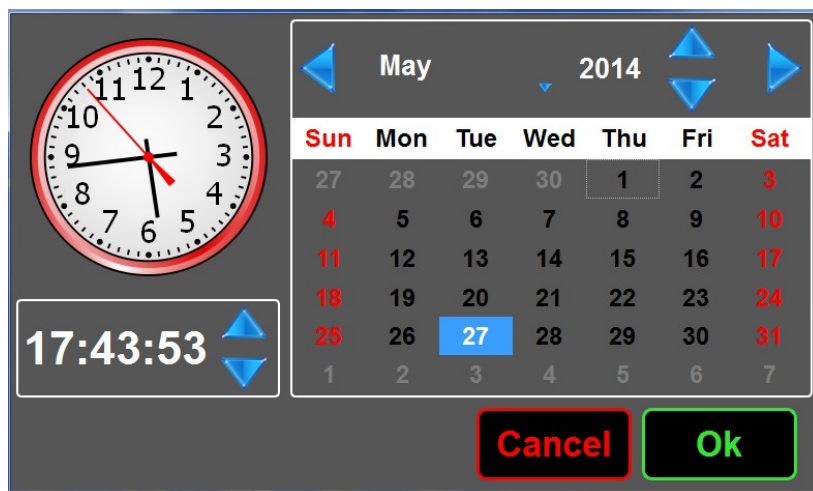

Figure 67: Setting Date and Time

- Press **OK** to validate your choice.

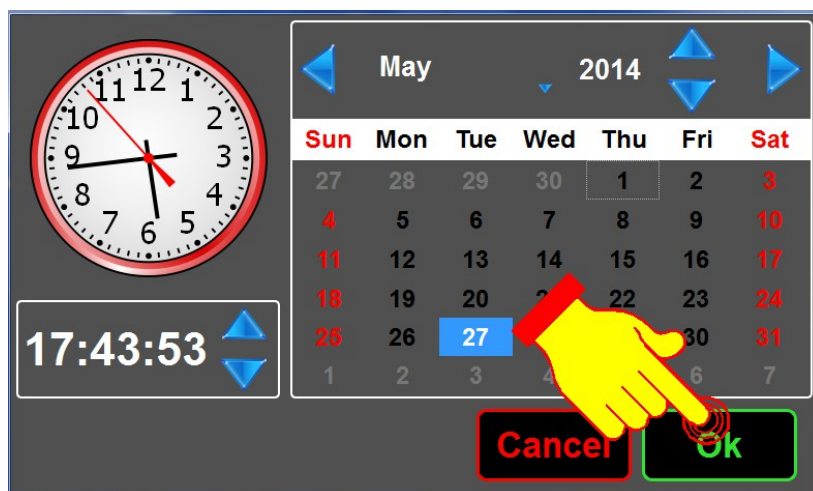

Figure 68: Setting Date and Time – OK Button

### 1.1.3.2. SELECTING RS-232 PROTOCOL

This option allows to change the RS-232 protocol.

- From the OSCP CONFIGURATION INTERFACE screen select **RS232 Protocol**.

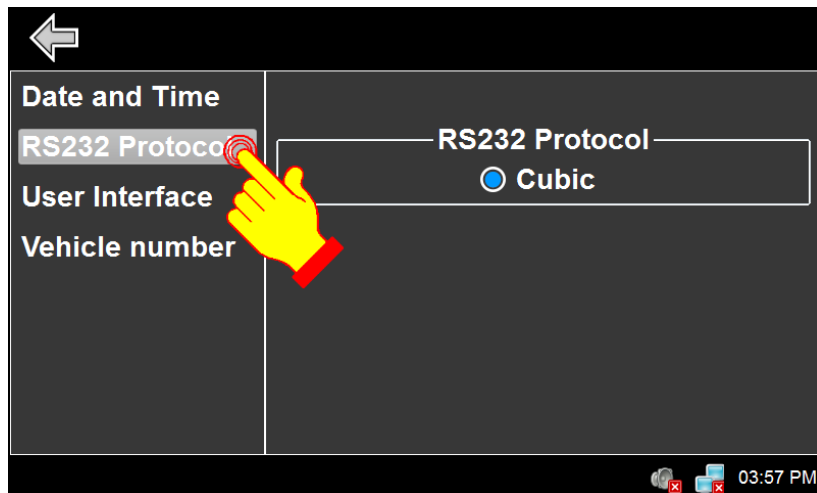

Figure 69: RS-232 Protocol Option

- Note: Only Cubic protocol is programmed in OSCP.

### 1.1.3.3. CONTROLLING AUDIO FEEDBACK

This option activates or deactivates audio feedback when pressing any button.

- From the OSCP CONFIGURATION INTERFACE screen select **User interface**.

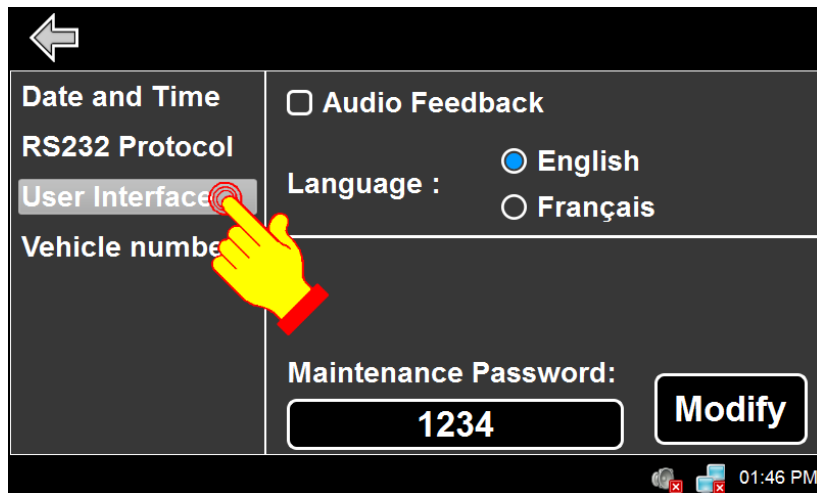

Figure 70: User Interface Option

- Select/deselect **Audio Feedback**.

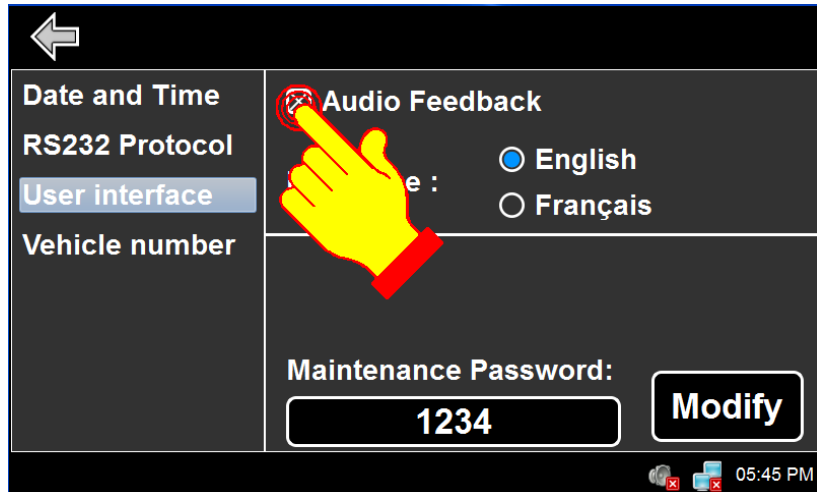

Figure 60: Selecting/Deselecting Audio Feedback Control

Note: By selecting/deselecting **Audio Feedback**, the speaker icon on the status bar changes accordingly.

	Audio Feedback ON
	Audio Feedback OFF

### 1.1.3.4. SELECTING LANGUAGE

- From the OSCP CONFIGURATION INTERFACE screen select **User Interface**.

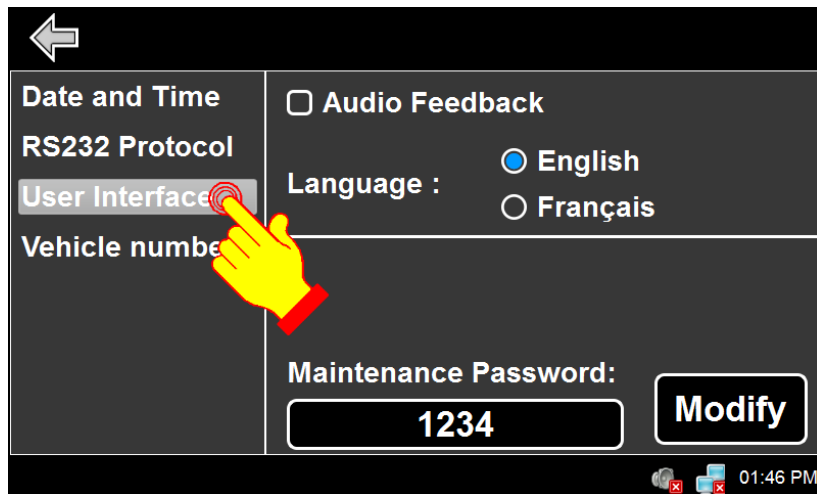

Figure 72: User Interface Option

- Select the required language.

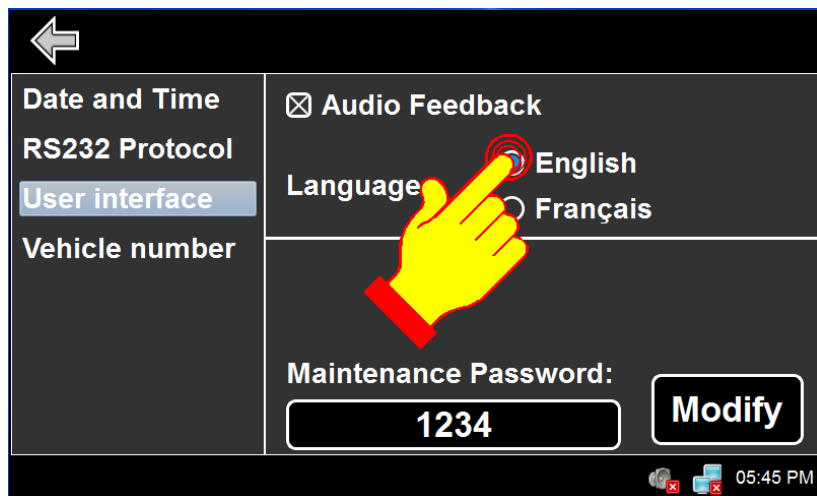

Figure 73: Selecting Language



### 1.1.3.5. MODIFYING MAINTENANCE PASSWORD

- From the OSCP CONFIGURATION INTERFACE screen select **User Interface**.

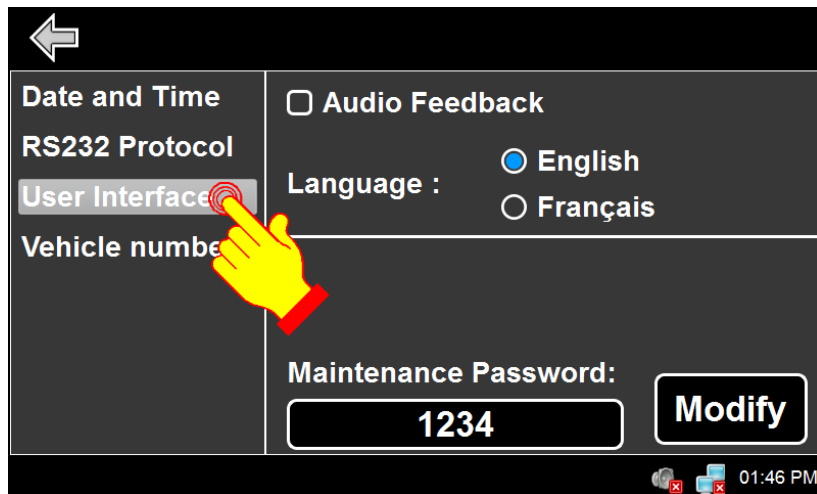

Figure 74: User Interface Option

- Press **Modify**.

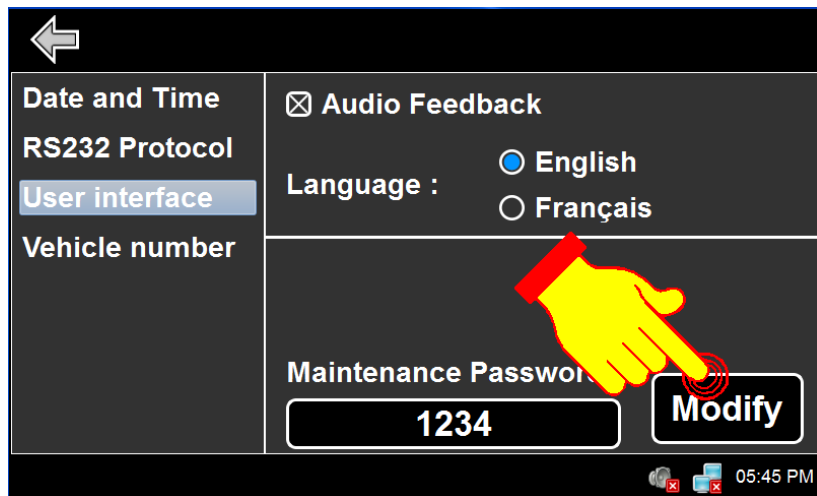

Figure 75: Modifying Maintenance Password

- Using the alphanumeric keyboard, enter the new password.
- Press **ENTER** to validate your choice.

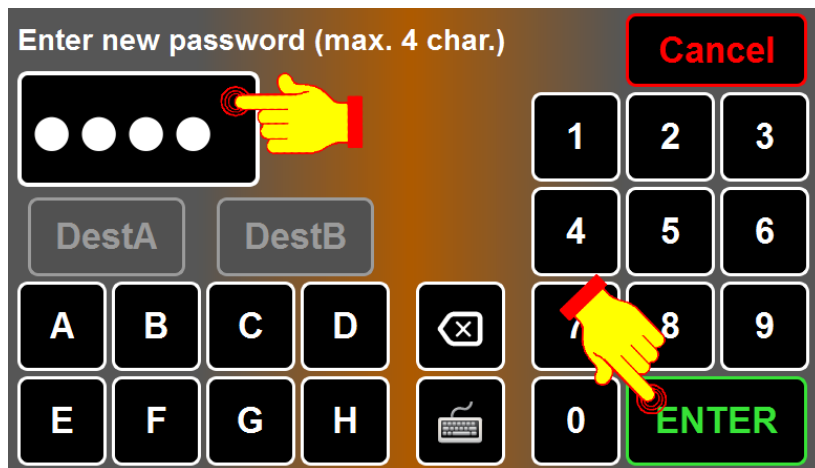

Figure 76: New Maintenance Password

- Note : If a password is required and you have forgotten it, enter the hardcoded value “9595”.
- Note: The maintenance password could be more complex (as required). Use the full keyboard to modify



### 1.1.3.6. MODIFYING VEHICLE NUMBER

This option allows to modify the vehicle number. This number is necessary to identify the vehicle for wireless data transfers. The number is the ID sent to the FTP server that controls the data transfers.

- From the OSCP CONFIGURATION INTERFACE screen select **Vehicle number**.

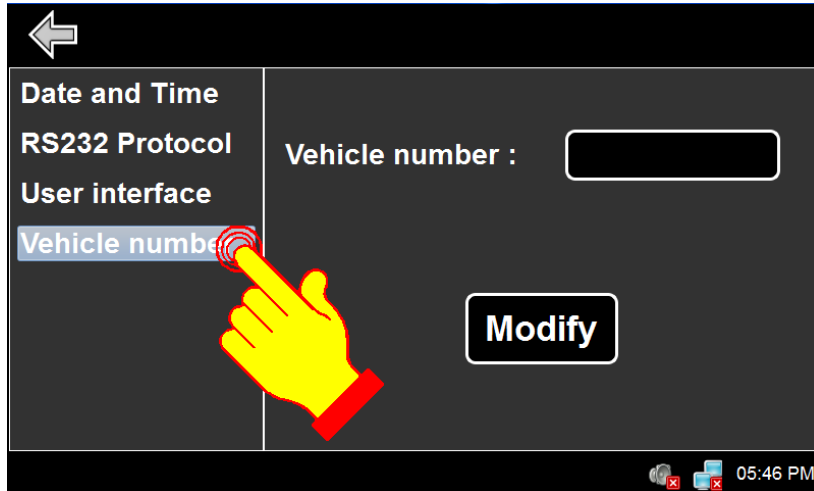

Figure 77: Entering Vehicle Number

- Press **Modify**.

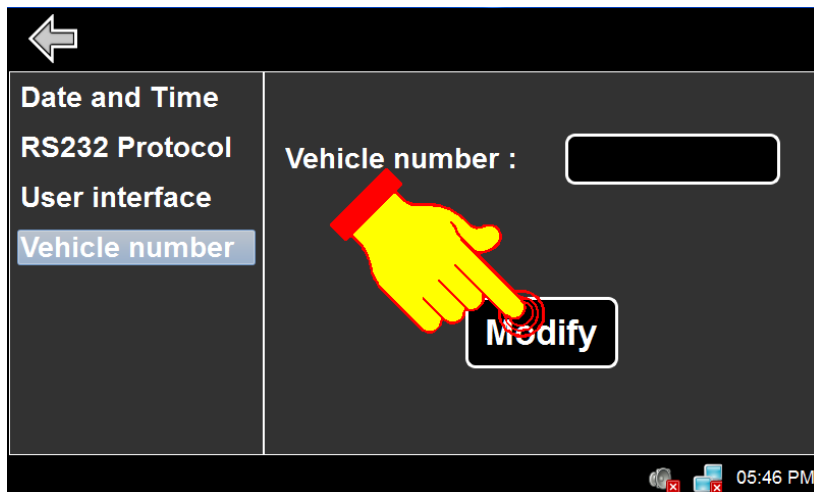



Figure 78: Entering Vehicle Number – Modify Button

- Using the alphanumeric keyboard or the full keyboard  , enter the vehicle number.

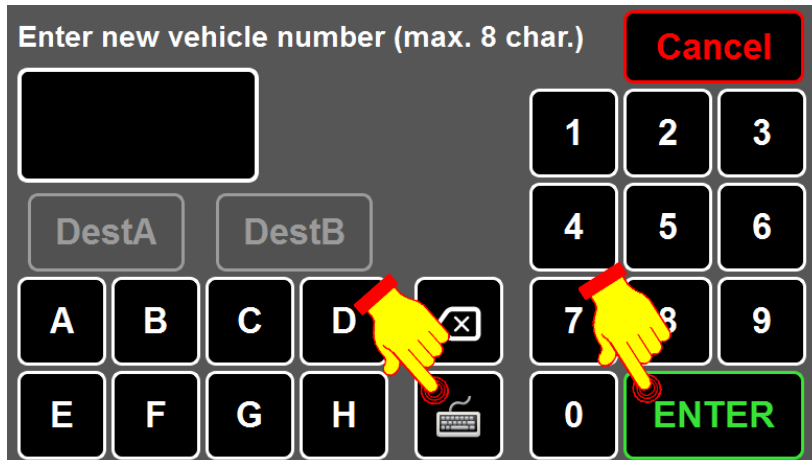

Figure 79: Entering Vehicle Number – Modify Button

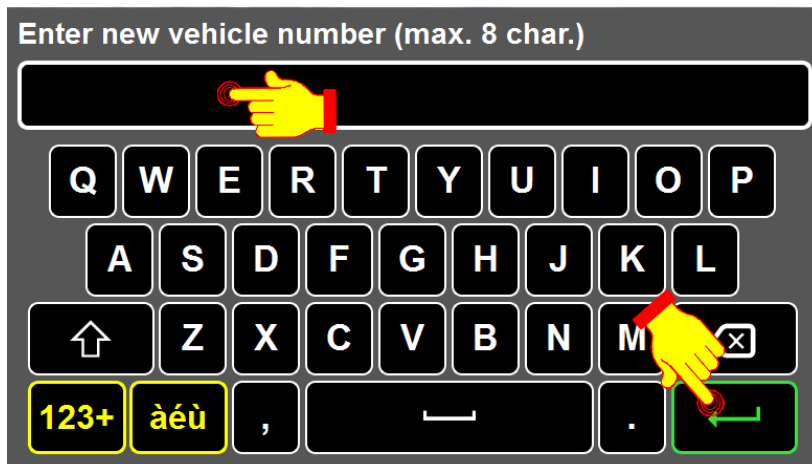

Figure 80: Vehicle Number Validation

- Press **ENTER** to validate your choice.

## 1.2. USB TRANSFER

The OSCP offers different options to transfer data using a USB key.

- Enter a USB key into the OSCP USB slot.
- Once the USB key is detected the following screen appears :

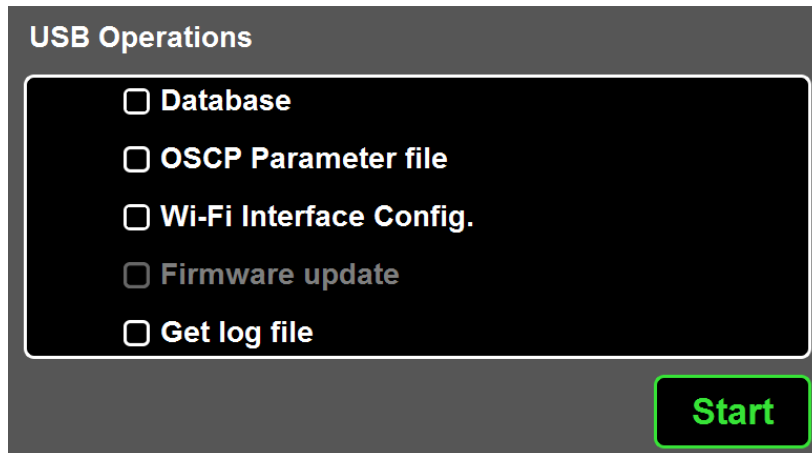

Figure 81: USB Operations

- Note: The available options are in white. Unavailable options are greyed.

- Select the available options and functions are as follows:

Option	Function
Database	<ul style="list-style-type: none"> <li>Copy destination database to the OSCP.</li> </ul>
OSCP Parameter file	<ul style="list-style-type: none"> <li>Copy the file including the parameters to customize the OSCP behavior.</li> </ul>
W-Fi Interface Config.	<ul style="list-style-type: none"> <li>Copy the file including the Wi-Fi environment and FTP configuration to the OSCP. This file is required to allow Wi-Fi transfers towards the OSCP.</li> </ul>
Firmware update	<ul style="list-style-type: none"> <li>Update OSCP and signs firmware.</li> </ul>
Get log file	<ul style="list-style-type: none"> <li>Get information from the OSCP on the latest events to occur during the OSCP execution.</li> </ul>

Table 9: USB Transfer Options and Functions

- Press **Start**.

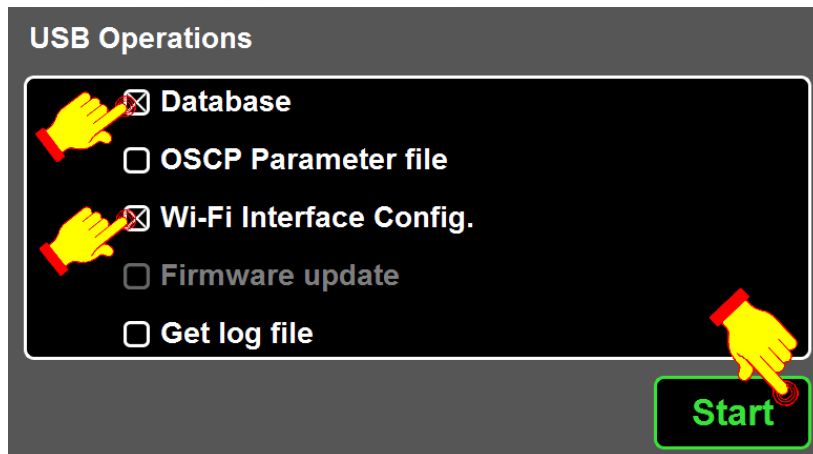

Figure 82: USB Selection

- Wait until the operation is completed. The operation status will be displayed when completed.

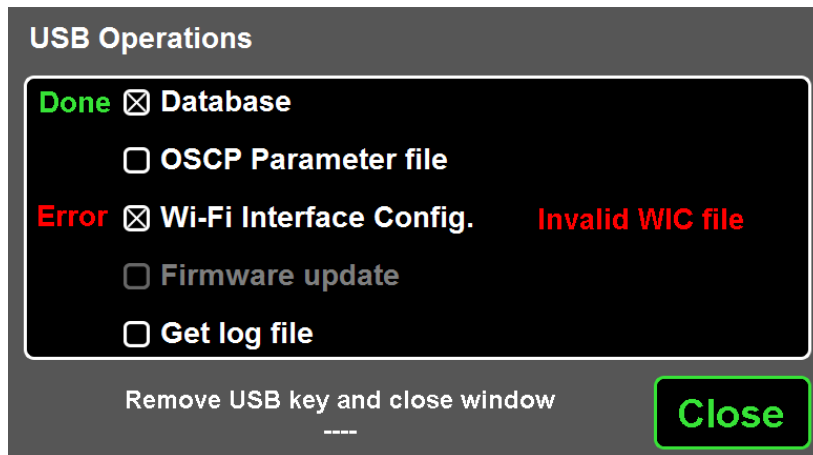

Figure 83: USB Result



- Remove USB key or press **Close** to terminate the USB transfer.

## 1.3. STATUS BAR ICON DESCRIPTIONS



### 1.3.1. Signs Error Icons

Refer to Section 1.1.1.7.3

### 1.3.2. Function Error Icons

Speaker Icons	
	Audio feedback on.
	Audio feedback off.

Ethernet Icons	
	Ethernet interface is active and running.
	Ethernet interface is active and not running.
	Ethernet interface is inactive and/or active but not configured.





Wi-Fi Icons	
	Wi-Fi interface is active and running.
	Wi-Fi interface is active and running but the vehicle number is not configured.
	Wi-Fi interface is active and running but the WIC file is not present.
	Wi-Fi interface is inactive or defective.
No icon	The OSCP is not configured (factory programmed) as Wi-Fi enabled.

Table 9: Function Error Icons

# **SECTION 2 PARTS LIST**



## 1. TECHNICAL DESCRIPTION



### FUNCTIONS

- ⇒ Controls all signs installed on the vehicle
- ⇒ Management of public messages
- ⇒ Messages are selected by entering the destination number
- ⇒ Transfer of Database (Ethernet, USB) (or Wi-Fi (Optional)
- ⇒ Self-diagnosis and messages are displayed on the OSCP screen
- ⇒ Transfer of LED Test Messages to signs
- ⇒ Compatible with RS-232, J1708
- ⇒ Backward compatible with Axion's control console
- ⇒ Larger memory to allow larger databases
- ⇒ Other available options:
  - Multiple discrete inputs: wheelchair loading, emergency, yield
  - Automatic routing
  - Power-off delay

### FEATURES

- ⇒ Number of signs managed: up to 9 per vehicle
- ⇒ Display: 5-in TFT | Resistive touch | 800 x 480
- ⇒ Case material: ABS, Black
- ⇒ Voltage Range: 10 - 36 Vdc, 12 or 24 Vdc nominal voltage
- ⇒ Power consumption: 0.5 A (Nom. @ 24Vdc)
- ⇒ Ethernet connector: RJ-45
- ⇒ Antenna connector: Reverse polarity SMA

### MECHANICAL FEATURES

- ⇒ Height: 10,16 cm (4,0 in)
- ⇒ Length: 19,69 cm (7,75 in)
- ⇒ Thickness: 4.57 cm (1.80 in)
- ⇒ Weight: 0.5 kg (1.1 lb)

## 2. OSCP DESCRIPTION

### 2.1. DIMENSIONS

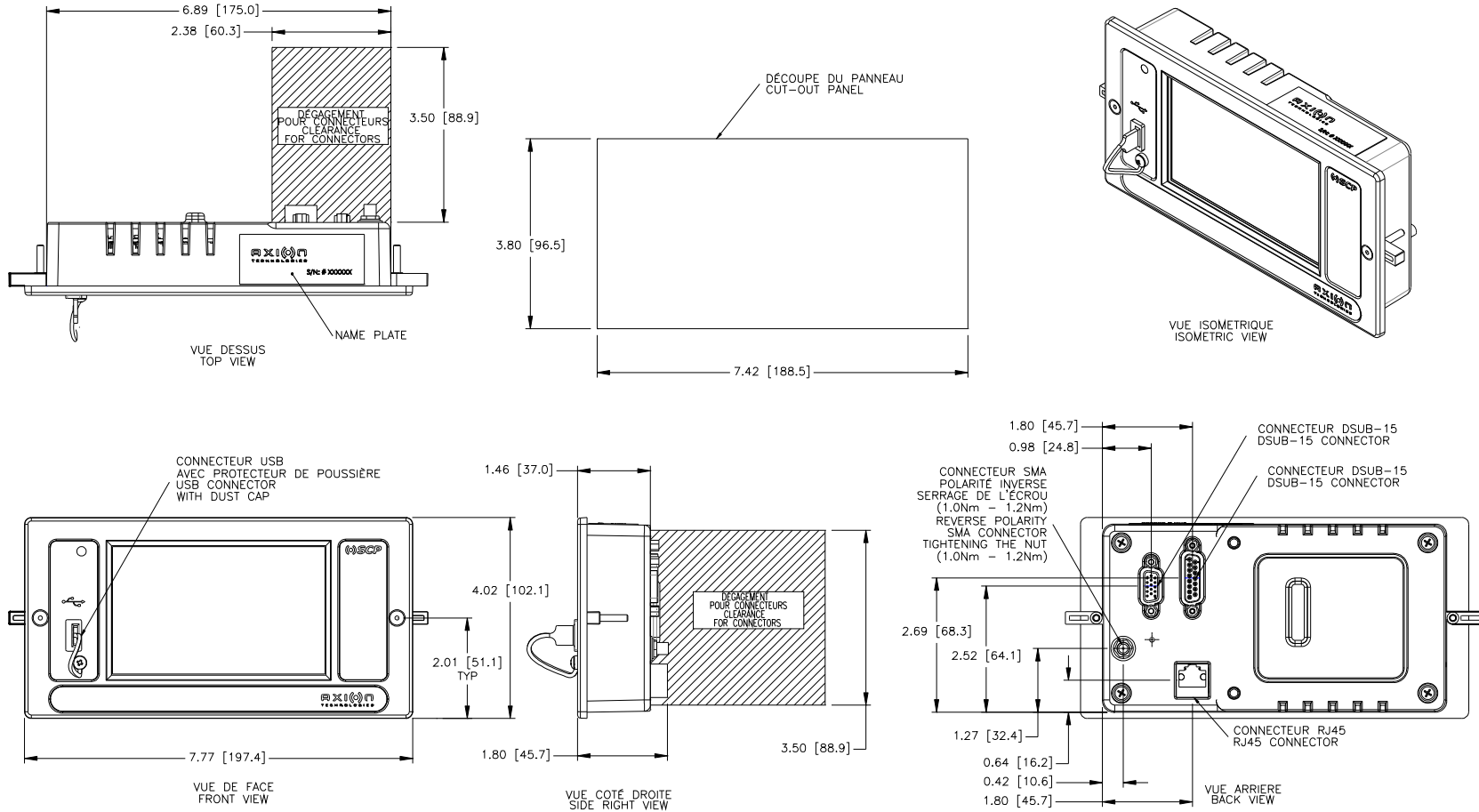

### 2.2. EXPLODED VIEW

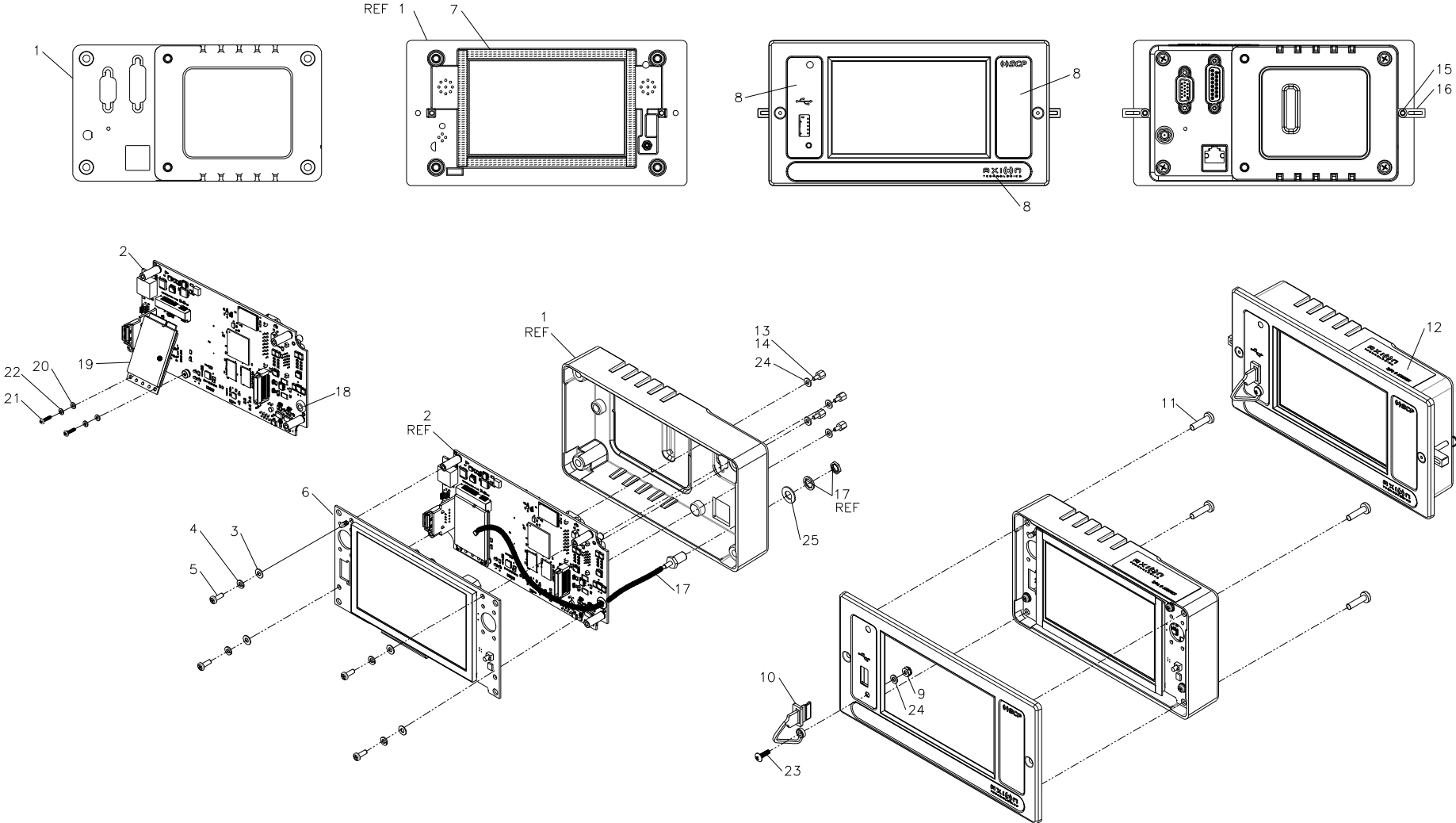

## 2.3. OSCP BOARDS

### 1.3.3. Processor Board Assy 8102172

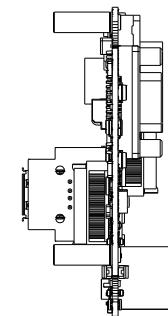
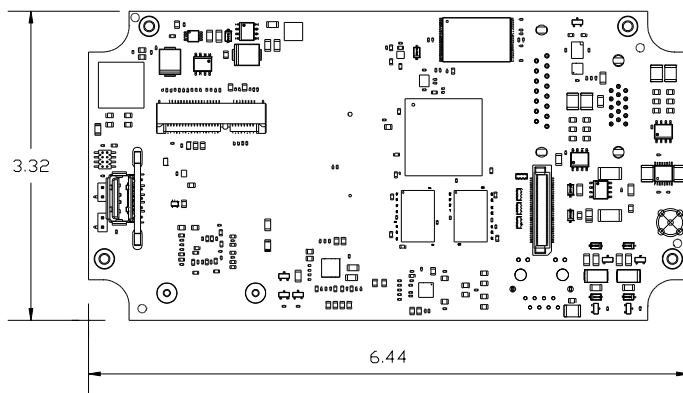
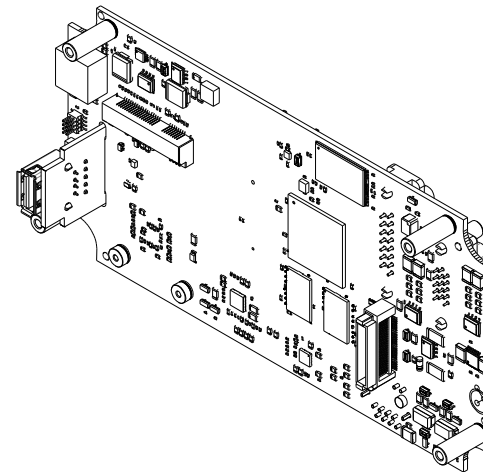
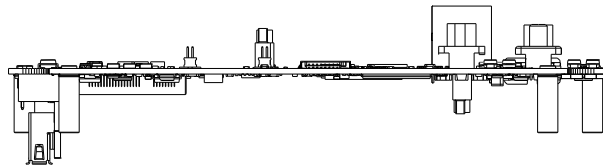

### 1.3.4. LCD Board Assy 8101687

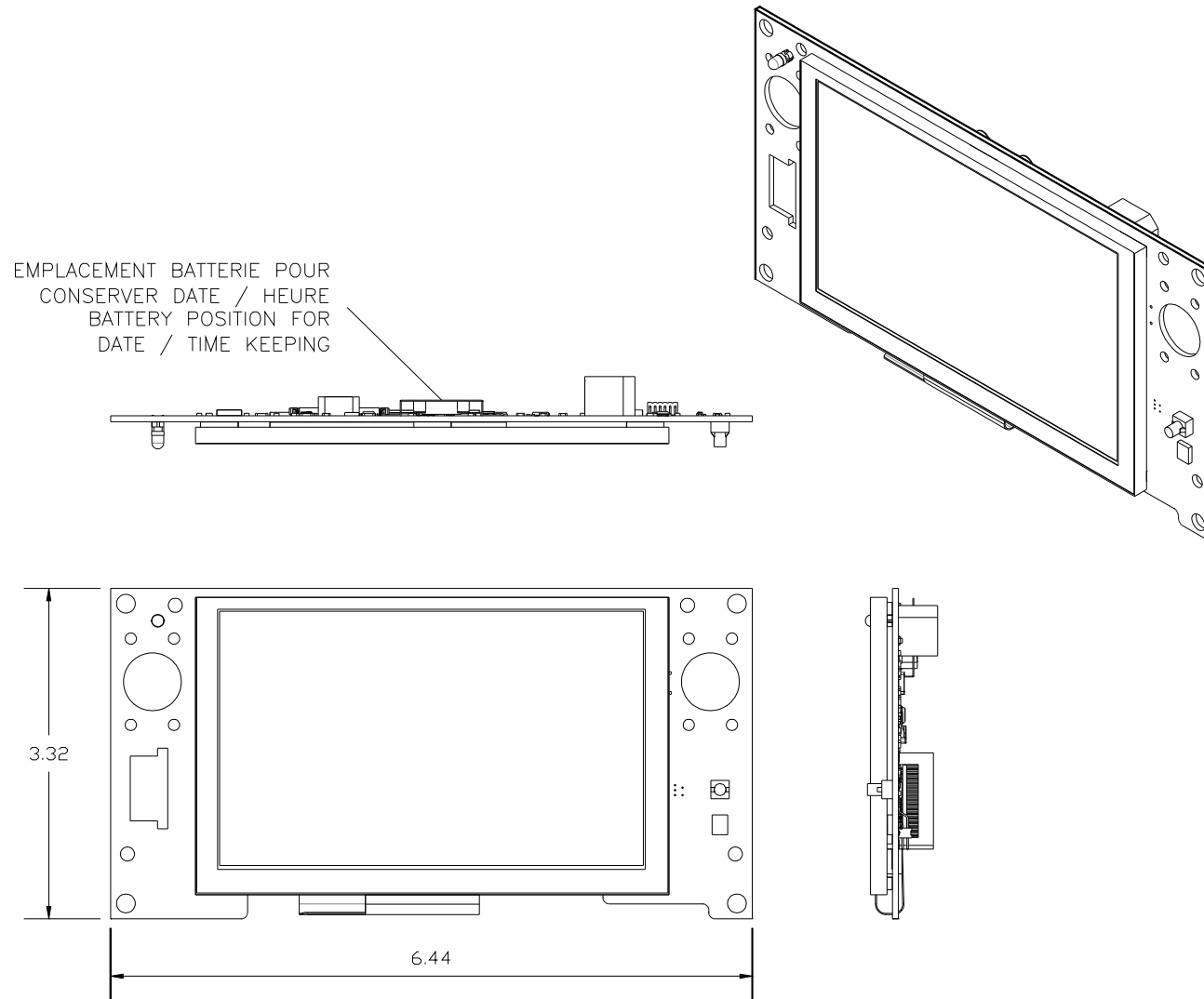

### 1.3.5. Wi-Fi Board 8101689 (Optional, on 9000485-W only)

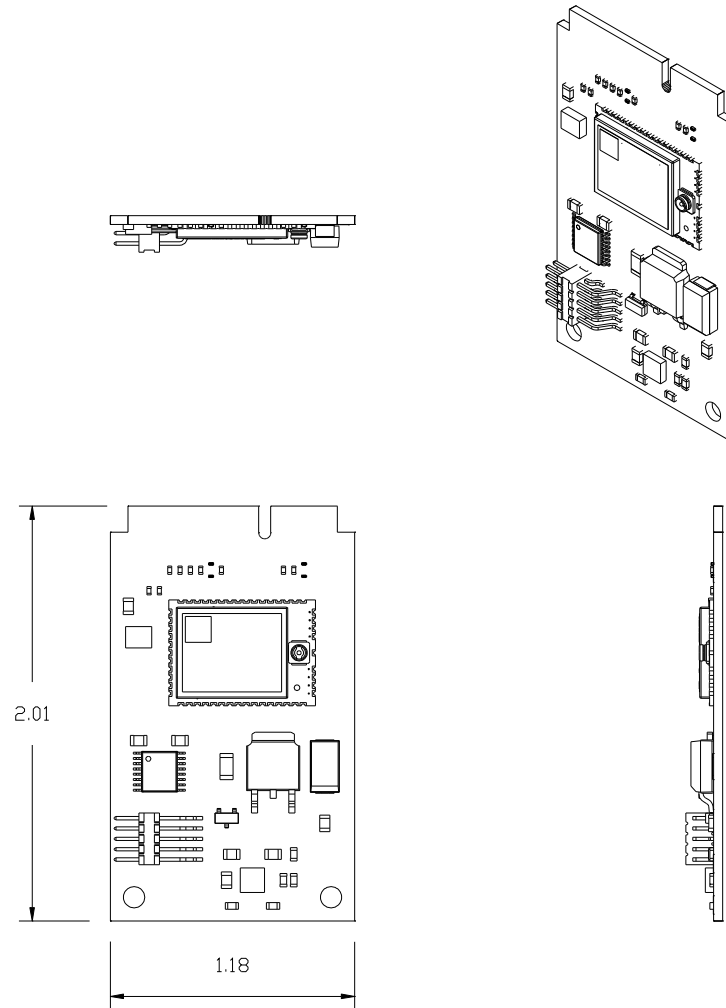

## 2.4. PARTS LIST

### NOTE

The following callouts correspond to superseded or unavailable items for board #900485: 17, 18, 19, 20, 21, and 22.

Item No.	Part No.	Qty <sup>1</sup>	Description	Manufacturer	Remarks
<b>X</b>	<b>9000485</b>	<b>1</b>	<b>Onboard System Controller Panel</b>	<b>AXION</b>	
1	0400565	1	0930 OSCP CASING	AXION	
2	8102172	1	0930 OSCP PROCESSOR BOARD ASSY	AXION	
3	2827312	4	FLAT WASHER M3 SST 7MM 3.2MM LF	659-F03-1P SPAENAU	
4	2827309	4	SPRING WASHER M3 SST 6.2MM 3.1MM	668-004 SPAENAU	
5	2827271	4	SCREW PHI M3 8MM SST PAN	425-G08-1N SPAENAU	
6	8101687	1	0930 OSCP LCD BOARD ASSY	AXION	
7	0400580	1	0930 LCD GASKET	AXION	
8	0400571	1	OSCP FRONT STICKER	AXION	
9	2825209	1	LOCKNUT 4-40 SST NYL	179-006 SPAE-NAUR	
10	2100403	1	DUST CAP USB TYPE A	MUSB-2A111-024-BP AMPHENOL	
11	2827605	4	SCREW PHI M4 16MM SST PAN	425-051 SPAENAU	
12	8505917	1	0930 OSCP BASE BAR CODE	AXION	
13	2825213	4	SPCR HEX 4-40 3/16 DSUB SZN MX	5747877-3 TE CONNECTIVITY	
14	1600092	A/R	THREAD LOCKER GLUE REMOVABLE (242)	24231 LOCTITE CANADA	
15	2826199	2	SCREW ALL 6-32 1 STL BLK FL	91253A153 MAC MASTER	
16	0400171	2	RETAINING CLIP	AXION	
23	2825320	1	SCREW PHI 4-40 3-8 SST TR BLK	94779A306 McMASTER 98019A309 MCMaster- CARR	
24	2827268	5	FLAT WASHER SST #4 1/4 1/32		

<sup>1</sup> QTY UOM = EA unless specified

*Continued on next page*

**Items specific to 9000485-W only**

Item No.	Part No.	Qty <sup>1</sup>	Description	Manufacturer	Remarks
<b>X</b>	<b>9000485-W</b>	<b>1</b>	<b>Passenger Information System Controller</b>	<b>AXION</b>	<b>Items of 9000485 plus following items</b>
12	8505919	1	0930 OSCP WI-FI BAR CODE	AXION	
17	2109855	1	SMA STR & UFL W 6" COAX CABLE	RN-UFL-SMA6 ROVING NETWORKS	
18	2500005	1	GROMMET 1/8X1/4X1/16 RUB	B-1030 SPAENAU	
19	8101689	1	0930 OSCP WIFI BOARD ASSY	AXION	
20	2826257	2	FLAT WASHER SZN M2 4.5 0.5	657-083ZP SPAENAU	
21	2825122	2	SCREW PZD M2 8MM SST PAN	3060699 BOSSARD	
22	2826255	2	SPRING WASH SZN M2 4.4 0.5	664-001ZP SPAENAU	
25	2827574	1	FIBRE WASHER M6 DIN522	526-388 RS COMPONENTS	



### 3. REMOVAL AND REPLACEMENT PROCEDURES

#### 3.1. OSCP REMOVAL AND REPLACEMENT

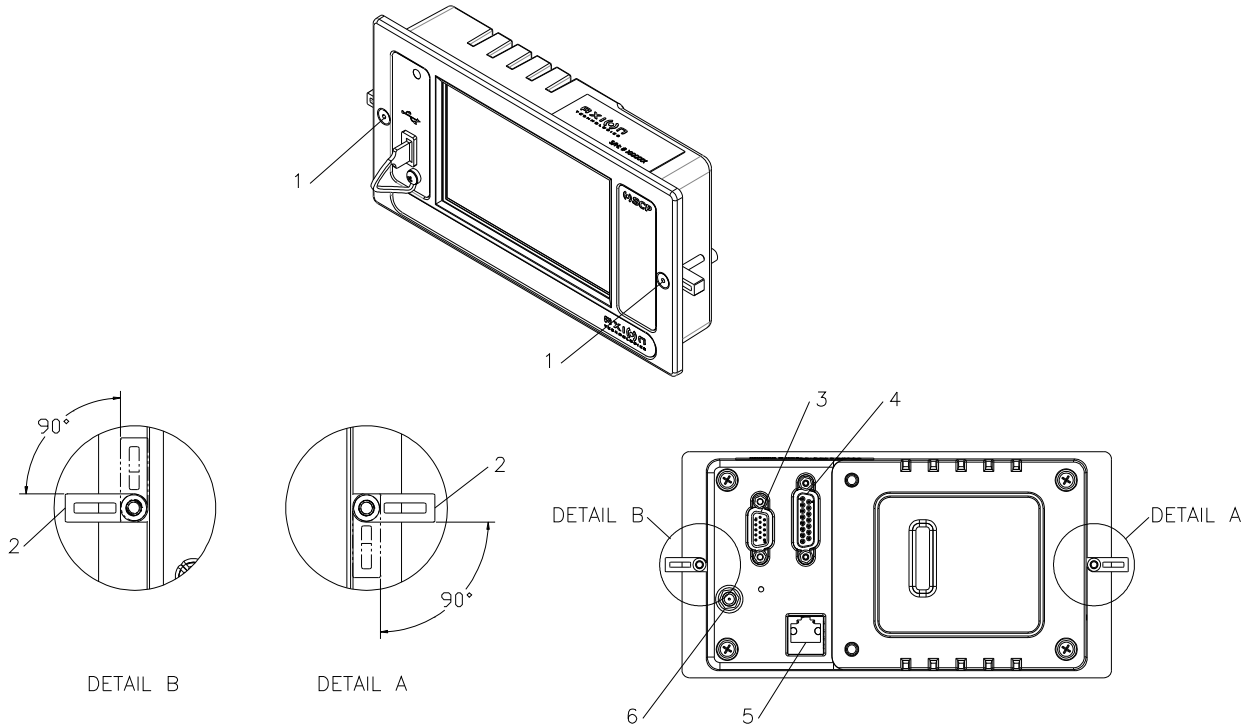

**Procedure :**

- Loosen screws (1) to tilt plastic clip (2) to 90°.
- Completely remove console from dash.
- Disconnect connectors (3, 4, 5, 6) from rear console.
- Reverse procedure to replace console.

## 3.2. OSCP BOARDS REMOVAL AND REPLACEMENT

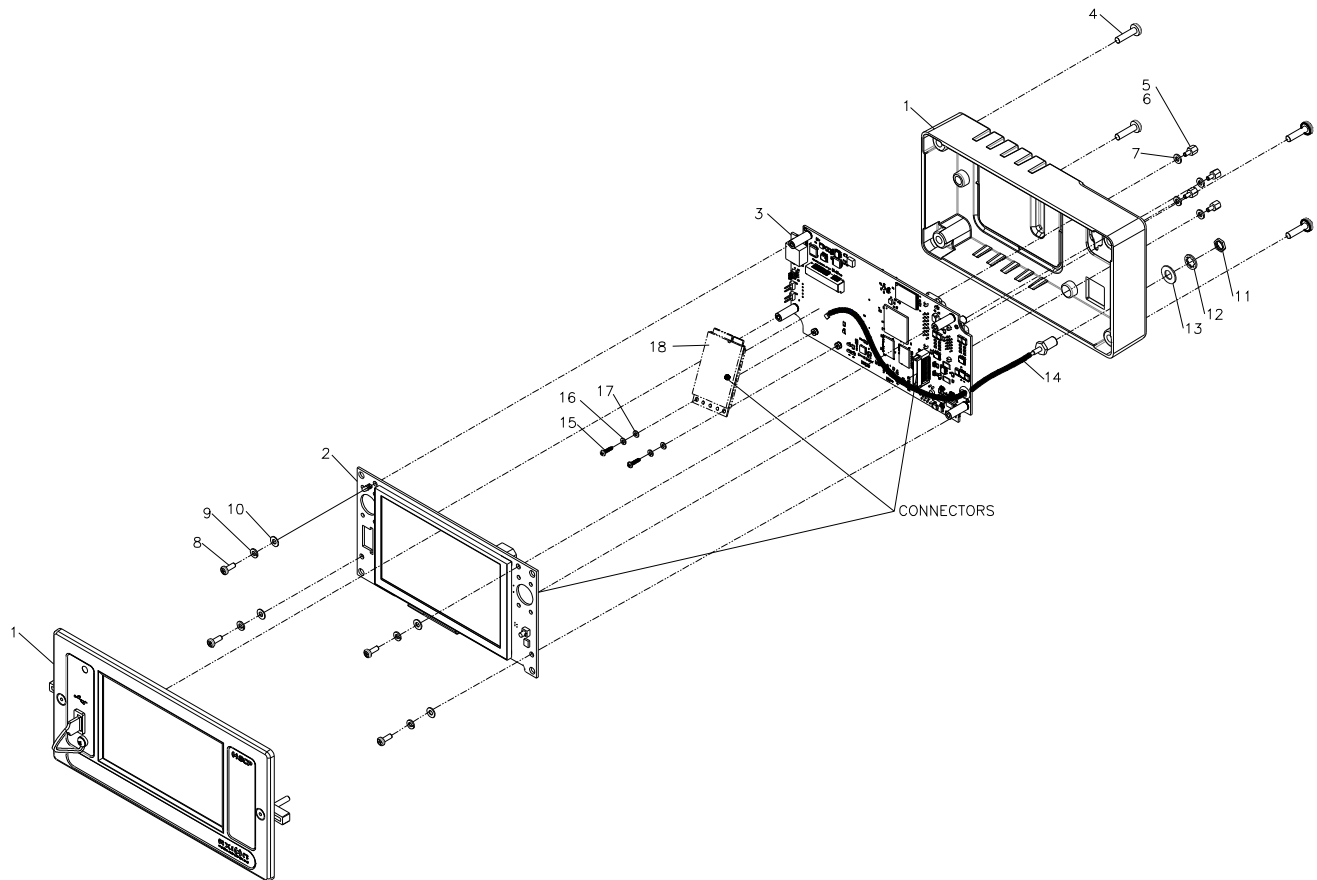

### 1.3.6. LCD board removal and replacement

- Unscrew four screws (4).
- Pull apart top casing (1).
- Remove four screws (8) and washers (9, 10).
- Disconnect LCD board (2) from Processor board (3).
- Reverse procedure to replace LCD board.
  - Refer to the OSCP User Guide to recalibrate the touch panel.

### 1.3.7. Wi-Fi board removal and replacement

- Unscrew four screws (4).
- Pull apart top casing (1).
- Remove four screws (8) and washers (9, 10).
- Disconnect LCD board (2) from Processor board (3).
- Remove two screws (15) and washers (16, 17)
- Disconnect Wi-Fi board (18) from Processor board (3).
- Reverse procedure to replace Wi-Fi board.
  - Refer to the OSCP User Guide to configure Wi-Fi.

### 1.3.8. Processor board removal and replacement

- Unscrew four screws (4).
- Pull apart top casing (1).
- Remove four screws (8) and washers (9, 10).
- Disconnect LCD board (2) from Processor board (3).
- Remove two screws (15) and washers (16, 17)
- Disconnect Wi-Fi board (18) from Processor board (3).
- Remove D-SUB connector spacer assembly (5, 6, 7).
  - When assembling, apply threadlocker (6) on spacer (5).
- Reverse procedure to replace Processor board.

### 1.3.9. Battery removal and replacement

- Unscrew four screws (4).
- Pull apart top casing (1).
- Remove four screws (8) and washers (9, 10).
- Disconnect LCD board (2) from Processor board (3).
- Replace battery.
- Reverse procedure to replace LCD board.
- Update date and time using the OSCP User Guide.