

Spicer® Driveshafts



SPICER®

Drivetrain Products

Service Manual

Spicer® Life Series

DSSM-0100

January 2016

Inspection Procedures

Inspection Warnings and Cautions	1
Universal Joints	4
Slip Member Assembly	5
Tubing Inspection	7
Center Bearings	7

Lubrication

Warnings and Cautions	8
Recommended Lubricants for Relubable Universal Joints and Slip Members	9
Grease Compatibility	9
Universal Joints	10
Slip Joint	12
Center Bearings	13

Removal

Warnings and Cautions	14
Driveshaft Assemblies	15
Grease Zerk Removal and Installation	16
Slip Member Boot	18
Center Bearing	19

Installation

Warnings and Cautions	21
Universal Joint - Snap-Ring Style	22
Universal Joint - Spring Tab Style	24
Center Bearing	25
Slip Member and Boot	26
Driveshaft	27

Glossary

Glossary	29
Appendix	32

For additional service information, go to www.dana.com or call 1-877-777-5360.

General Information

Spicer Life Series™ Features and Benefits

Note: Spicer Life Series™ driveshafts are found on vehicles throughout the world. Therefore, this manual includes worldwide terminology.

This manual encompasses inspection, lubrication, removal and installation procedures for Spicer Life Series™ 55, 70, 90, 100, 140, 170 and 250 driveshaft assemblies.

Important Features of a Spicer Life Series™ Driveshaft

Spicer offers a complete range of driveshaft solutions to meet the full spectrum of needs in medium and heavy duty applications. The Spicer Life Series™ driveshafts have been designed and developed to stand up to the wear and tear of heavy hauling tasks. They are the first driveshafts in the industry to be compatible with advancing powertrain specifications for higher engine torque and lower axle ratios. No one does more than Spicer in meeting the needs of the marketplace.

Spicer Life Series™ driveshafts offer:

- Longer life
- Lower lifetime management
- Increased strength for higher engine torque and lower axle ratios
- Smaller driveshaft rotating diameter

A driveshaft that transmits high torque loads must be durable and strong. Spicer uses forged steel and high strength cast yokes to provide the necessary rigidity to maintain bearing alignment under torque loads. Spicer Life Series Quick Disconnect™ end yokes reduce the time to remove or install the driveshaft, equating up to a 75% labor savings for service. Applications requiring flange connections, S.A.E., DIN and cross-serrated T-Flanges are available. A new cold-formed, bearing retainer provides structural rigidity and reduces bearing movement which may result from overloading.

Spicer Life Series™ award winning* universal joint kits are specifically designed to give extended driveshaft life. Flat-ended needle bearings are used to withstand oscillating loads while the driveshaft is rotating and to eliminate skewing in the bearing cup. Thrust washers significantly reduce end galling on trunnion ends and lower universal joint operating temperature. Synthetic rubber seals and plastic seal guards provide lubricant retention and help prevent the entry of foreign material, significantly increasing universal joint life. The centrally located grease zerk (nipple) fitting increases the strength of the journal cross and allows more torque carrying capacity.

High-strength steel tubing is used to provide maximum torque carrying capacity at minimum practical weight. Increased tube diameter allows a higher critical speed and longer one-piece driveshafts. This increased stiffness also improves noise, vibration and harshness. New slip member booting or alternative seal can offers better protection against environmental contaminants, increases component life, and is lubricated for the life of the product.

The new integral tube sleeve and yoke shaft design, found on heavy duty Spicer Life Series™ designs, along with larger diameter involute splines, creates greater strength and torsional stiffness with less weight. This new design leads to improved balance and less slip effort, resulting in reduced noise and vibration for the entire driveshaft system. Spicer Glidecote®, found in all slip member assemblies, reduces friction, thereby lowering thrust loads under high torque. This nylon coating also prevents spline wear and extends life.

Spicer Life Series™ Inspection Warnings and Cautions

Before You Get Started

1. ALWAYS wear safety glasses when performing maintenance or service. Failure to wear safety glasses can result in personal injury and/or partial or complete vision loss.
2. NEVER go under a vehicle while the engine is running. Be sure the vehicle's engine is off, and keys are removed from ignition.
3. NEVER go under or work on a vehicle that is not on a level or flat surface.
4. NEVER work on a driveshaft without blocking the vehicle's wheels and releasing all parking brakes. See warning below.
5. NEVER lift a vehicle without the appropriate weight-rated, vehicle-support equipment.
6. NEVER REMOVE a driveshaft from the vehicle without keeping the vehicle's transmission in neutral. See above warning.
7. CAUTION – Spicer Life Series™ driveshaft assemblies can weigh in excess of 100 pounds (46 kilograms). Be sure to use proper lifting techniques when handling Spicer Life Series™ driveshafts. More than one person may be needed when handling driveshaft assemblies.
8. ALWAYS use support straps to prevent the driveshaft from falling, causing injury and/or damage during the loosening or removal of any driveshaft hardware.
9. NEVER heat components or use sledgehammers or floor jacks to remove the driveshaft from vehicle.

Note: For driveshaft applications that have pillow blocks, dampers, parking brakes or retarders, refer to these component manufacturers' or the original equipment vehicle manufacturers' service manuals for proper procedures.

Driveline

WARNING

WARNING: Failure to replace damaged driveline components can cause driveline failure, which can result in separation of the driveline from the vehicle. A separated driveline can result in property damage, serious personal injury, or death.

WARNING: Reassembly of a driveline out of original phase can cause vibration and failure of the driveline and attaching components.

WARNING: Driveshaft assemblies can weigh in excess of 100 pounds(46 kilograms). Be sure to use proper lifting techniques when handling driveshafts. More than one person may be needed when handling driveshaft assemblies.

WARNING: Never heat components, never use sledge hammers, and never use floor jacks to disassemble driveshafts. This can result in damaged, weakened, or bent components.

End Fitting

WARNING

WARNING: A loose end-fitting can result in driveline failure, which can in turn lead to separation of the driveline from the vehicle. A separated driveline can lead to property damage, serious personal injury, or death.

Universal Joint

WARNING

WARNING: Excessive looseness across the end of universal joint bearing cup assemblies can cause imbalance or vibration in the driveshaft assembly. Imbalance or vibration can cause component wear, which can result in separation of the driveline.

WARNING: DO NOT reuse bolts or use inferior grade bolts. Reuse of bolts and/or use of inferior bolts can cause driveline failure, which can result in separation of the driveline from the vehicle.

WARNING: Failure to torque bolts to specification can cause driveline failure, which can result in separation of the driveline from the vehicle.

CAUTION: Use a journal locator to avoid nicking journal cross trunnions or damaging oil seal slingers.

CAUTION: If a bearing assembly or journal cross is worn or damaged, the universal joint assembly must be replaced.

CAUTION: Be sure the snap rings are properly seated in the snap ring grooves.

Slip Member

WARNING

WARNING: Excessive radial looseness in the slip member assembly can cause imbalance or vibration in the driveshaft. Imbalance or vibration can cause components to wear, which in turn can result in separation of the driveline from the vehicle. A separated driveline can cause property damage, serious personal injury or death.

Yoke (Includes Slip Yoke, Yoke Shaft, and Tube Yoke)

WARNING: A loose or damaged slip yoke seal allows contaminants to invade the slip member assembly. Invasion of contaminants into the slip member assembly can degrade the grease, and damage slip member components, which can result in driveline separation.

WARNING: DO NOT deform yoke cross holes by removing excessive metal. Raised metal or deformed yoke cross holes can be a cause of cross and bearing failure, which can result in separation of driveline from the vehicle.

WARNING: Yoke shaft assemblies can weigh in excess of 50 pounds (23 kilograms). Be sure to use proper lifting techniques when handling yoke shafts.

Tubing

WARNING

WARNING: Bent or dented tubing can cause imbalance or vibration in the driveshaft assembly. Imbalance or vibration can cause component wear, which can result in separation of the driveline from the vehicle.

CAUTION: Do not bend or dent the tube when handling or servicing driveshaft.

Midship Nut

WARNING

WARNING: DO NOT reuse the midship nut. Reuse of the midship nut can cause driveline failure, which can result in separation of the driveline from the vehicle.

WARNING: DO NOT touch or disturb the micro-encapsulated adhesive found on the midship nut threads. Doing so may initiate the curing process and impair the installation of the nut. Premature curing of the micro-encapsulated adhesive will result in improper installation of the midship nut. Improper installation of this nut can cause driveline failure, which can result in separation of the driveline from the vehicle.

WARNING: Failure to torque the midship nut to required specifications can cause driveline failure, which can result in separation of the driveline from the vehicle.

WARNING: A loose midship nut can result in driveline failure, which can result in separation of the driveline from the vehicle.

Center Bearing

WARNING

WARNING: Loose center bearing bracket bolts can result in driveline failure, which can result in separation of the driveline from the vehicle.

WARNING: Damaged center bearings or center bearing components can cause imbalance or vibration in the driveshaft assembly. Imbalance or vibration can cause component wear, which can result in separation of the driveline from the vehicle.

Foreign Material

WARNING

WARNING: Build-up of foreign material, excessive paint, or undercoating on a driveshaft can cause imbalance or vibration in the driveshaft assembly. Imbalance or vibration can cause component wear, which can result in separation of the driveline from the vehicle.

WARNING: A contaminated slip member can result in separation from the vehicle. A separated driveline can result in property damage, serious personal injury or death.

Hardware

WARNING

WARNING: Loose, missing, or damaged bearing retainers or stamped straps, retaining bolts, nuts, end fitting tangs, snap

rings, or rotating bearing cups can result in driveline failure. A separated driveline can lead to property damage, serious personal injury, or death.

WARNING: DO NOT reuse bolts, straps, nuts, or damaged bearing retainers or inferior grade bolts. Reuse of bolts, straps, nuts, or damaged bearing retainers, or use of inferior grade bolts can cause driveline failure.

CAUTION: If loosening or removing bolts, always install a new strap and bolts and torque bolts to specification.

CAUTION: All slip yoke and universal joint seals should be completely purged.

Lubrication

WARNING

WARNING: A missing, loose, or fractured grease zerk (nipple) fitting or plug eliminates the ability to lubricate the universal joint. Improper or inadequate lubrication can cause driveline failure, which can result in separation of the driveline from the vehicle.

WARNING: Improper lubrication techniques can cause driveline failure, which can result in separation of the driveline from the vehicle.

WARNING: A missing, loose, damaged, or fractured plug or grease zerk (nipple) fitting can allow contaminants to invade the universal joint. Invasion of contaminants into the universal joint can degrade grease and cause universal joint damage, which can result in separation of the driveline from the vehicle.

WARNING: Incompatible greases that are applied to universal joints and/or slip members can result in driveline failure and can result in separation of the driveline from the vehicle.

WARNING: Hand tightening of grease zerk (nipple) fitting or plugs is NOT recommended. Failure to torque grease zerk (nipple) fittings to specifications can result in separation of the driveline from the vehicle.

WARNING: Maximum grease gun pressure should not exceed 60 psi. Excessive grease gun pressures may cause seal damage.

CAUTION: In cold temperatures, be sure to drive the vehicle immediately after lubrication. This activates the slip spline and removes excess grease. Failure to do so could cause excess grease to stiffen in the cold weather and force the plug out. The end of the spline would then be open to collect contaminants and cause the spline to wear and/or seize.

Inspection Procedures

Visually inspect all input and output end-fitting retaining nuts or bolts for any gaps between mating surfaces. If gaps are present, consult transmission, axle or transfer case original equipment manufacturers' service and maintenance manuals for proper fastener specifications.

Visually inspect for damaged bearing retainers or stamped straps, loose bearing retainer bolts or strap bolts, loose companion flange bolts and nuts, loose or missing spring tabs or spring tab bolts, damaged tangs on end fittings, damaged or missing snap rings, and rotating bearing cups.

If any of these situations are evident, replacement of the components is necessary. Refer to the removal and installation sections of this manual for proper replacement procedures.

Universal Joints

Note: The following procedures are to be performed prior to any lubrication of universal joints or slip members. The addition of lubricant can mask the looseness in a component that is beginning to show wear and may be in need of replacement.

1. Check for excessive looseness across the ends of the universal joint bearing cup assemblies and trunnions. Take hold of the inboard yoke on the driveshaft with both hands. Try to move the yoke vertically and horizontally.

There should be less than .006" (.15mm) movement in the universal joint relative to the inboard or outboard yokes. If looseness is greater than .006" (.15mm), the universal joint kit may need to be replaced.

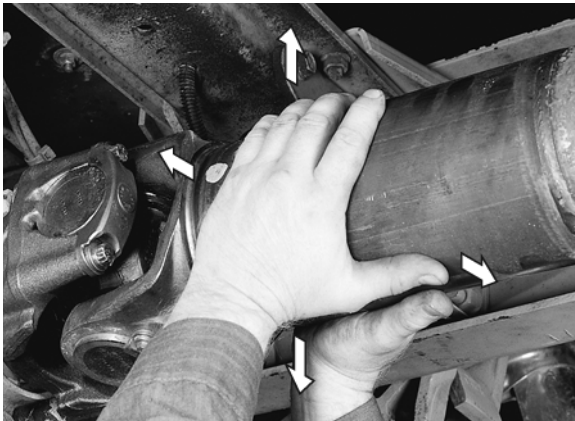

⚠ IMPORTANT

Note: If the movement of the driveshaft is greater than .006", the carrier assemblies input shaft and/or output shaft ends play must be checked to make sure they are within specification. Endplay readings that are out of specification must be corrected before an accurate driveshaft reading can be taken. Refer to the Input/Output Shaft Endplay Inspection procedure.

⚠ WARNING

Excessive looseness across ends of universal joint bearing cup assemblies can cause imbalance or vibration in the driveshaft assembly. Imbalance or vibration can cause component wear, which can result in separation of the driveline from the vehicle.

Check Input Shaft End-Play (Forward Axle)

- a. Position dial indicator at yoke end of input shaft.
- b. Push on input shaft and zero dial indicator.
- c. Using pry bar, move input shaft axially and measure/record end-play.

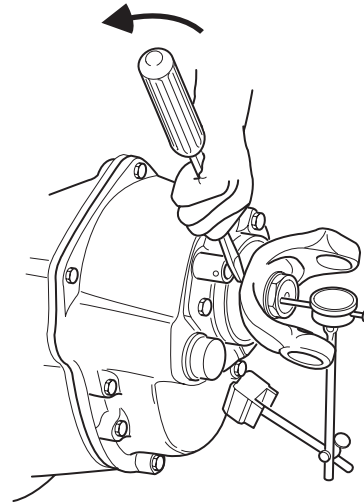

Add shims to increase end-play.

Note: Input and output shaft endplay specifications will vary between model. Refer to manufacturer's service manual for correct endplay specifications.

Remove shim to decreased end-play.

<i>Measured end-play (Step 3)</i>	<i>0.015" – 0.015"</i>
<i>Desired end-play (New Parts)</i>	<i><u>0.003" to 0.007"</u></i>
<i>Remove shims to provide desired end-play</i>	<i>0.012" to 0.008"</i>

Check Output Shaft End-Play (Forward Axle)

- a. Position dial indicator at yoke end of input shaft.
- b. Push on output shaft and zero dial indicator.
- c. Using pry bar, move input shaft axially and measure/record end-play.

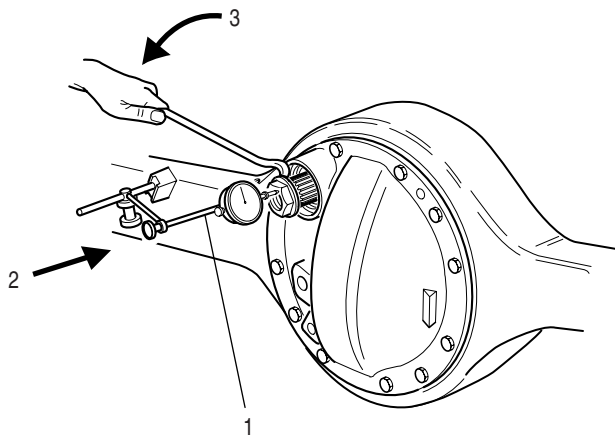

Note: The output yoke can be installed when taking end-play measurements.

- d. Correct end-play for new assembly is .001" to .015".

Grease Zerk Inspection

Check for presence of all grease zerk fittings. Grease zerk fittings should not be loose, fractured or missing.



- If grease zerk fitting is loose, tighten to required specifications.
- If grease zerk fitting is fractured, replace grease zerk fitting and tighten to required specifications.
- If grease zerk fitting is missing, the entire universal joint kit needs to be replaced.
- If the plug is loose, tighten to required specifications.
- If a plug is missing or fractured, the entire universal joint kit needs to be replaced.

Slip Member Assembly Inspection

1. Check the slip member assembly for excessive radial looseness. Using a dial indicator, take hold of the tubing near the slip member with both hands and try to move vertically, up and down relative to the ground.

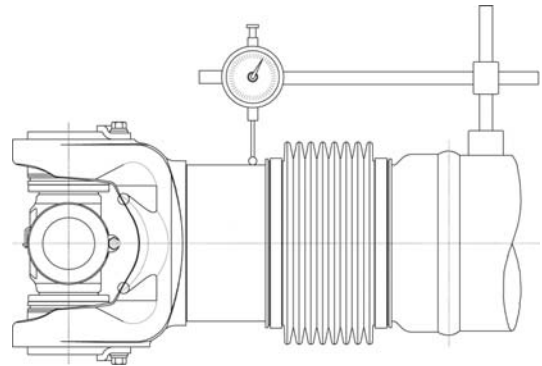

2. Arrange dial indicator with magnetic base one-quarter inch (1/4") from the driveshaft's tube weld. Dial indicator should be firmly mounted on the tube so that **no** movement of the dial indicator base is allowed.
3. Extend dial indicator arm from the base, across the slip member boot, allowing the dial indicator to contact the yoke shaft tube one quarter inch (1/4") off the opposite side of the boot from where the magnetic base is mounted. Dial indicator's arm should be running parallel to the driveshaft.

4. Apply effort perpendicular to shaft axis making note of total indicator travel. Allowable indicator travel is .000-.012 in.

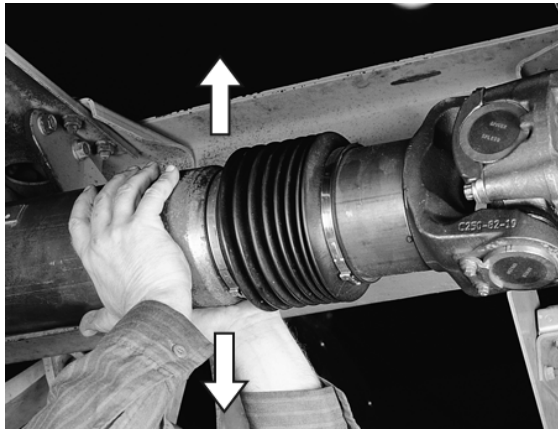

⚠ WARNING

Excessive radial looseness can cause imbalance or vibration in the driveshaft assembly. Imbalance or vibration can cause component wear, which can result in separation of the driveline from the vehicle.

5. For an inboard and outboard slip yoke assembly design, check to be sure the slip yoke Welch plug is not loose, missing or damaged.



If any of these situations are evident, replacement of the slip yoke and professional rebalancing of the driveshaft is necessary.

6. Visually inspect for the presence of the grease zerk fitting, if applicable, on the slip yoke.
 - a. If grease zerk fitting is loose, tighten to required specifications. (See Table C.)
 - b. If grease zerk fitting is missing or fractured, the slip members may need to be replaced.

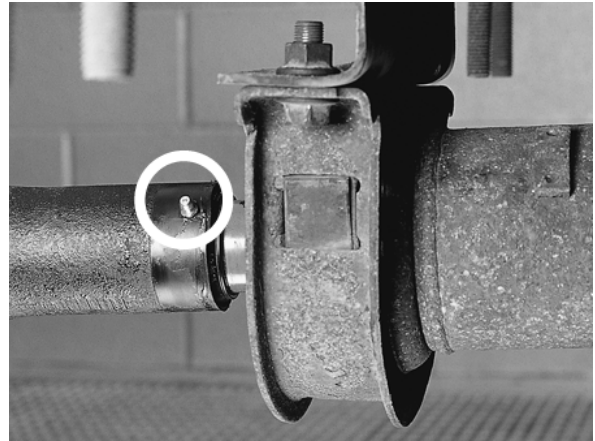

Table C - Slip Member Grease Zerk Fitting Specifications

Thread Size	Zerk Nm	Torque IN. LB.
0.25"-28"	3.5-6.2	31-55

7. Check the slip yoke seal. Make sure the seal is properly attached to the slip yoke and is not loose or damaged.

Permanently Lubricated Style

Check the yoke shaft boot. Make sure the boot is properly attached to the yoke shaft assembly and splined sleeve. Visually inspect for boot tears, punctures, loose clamps and clamp damage.

If any of these situations are evident, replace damaged components and measure slip joint movement.

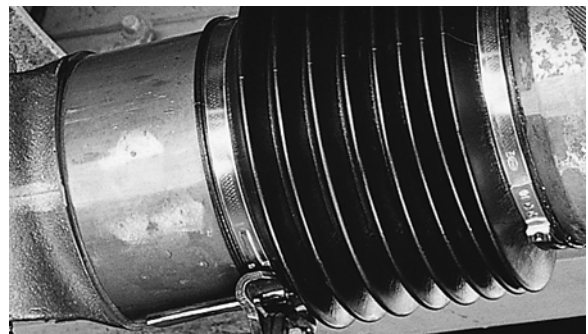

Tubing Inspection

1. Check the driveshaft for bent or dented tubing. If either of these situations is evident, replacement of the complete driveshaft assembly or tube is necessary.
2. Make certain there is no buildup of foreign material on driveshaft.

If found, buildup should be removed carefully to avoid damaging the driveshaft.

- a. When removing dirt or mud, rinse with water.
- b. When removing tar or undercoating, use mineral spirits or any appropriate solvent.

Center Bearings Inspection

1. Visually inspect all center bearings, end-fitting mid-ship nuts for any gaps between the mating surfaces.

Note: Be sure to repeat steps 2 and 3 for all center bearing end fittings for broken back and backlash.

2. Inspect the center bearing bracket bolts for looseness.



Note: If looseness is evident, retighten center bearing bracket bolts. Consult the vehicle manufacturers' specifications for proper bolt torque. Check the alignment of the bracket before tightening the bolts. Bracket should not be skewed.

3. Visually inspect the center bearing rubber cushion for damage. Make sure the slingers are not rubbing against the rubber cushion. Verify that the rubber cushion is properly seated in the metal bracket.

Spicer Life Series™ Lubrication Warnings and Cautions

Before You Get Started

1. ALWAYS wear safety glasses when performing maintenance or service. Failure to wear safety glasses can result in personal injury and/or partial or complete vision loss.
2. NEVER go under a vehicle while the engine is running. Be sure the vehicle's engine is off, and keys are removed from ignition.
3. NEVER go under or work on a vehicle that is not on a level or flat surface.
4. NEVER work on a driveshaft without blocking the vehicle's wheels and releasing all parking brakes. See warning below.
5. NEVER lift a vehicle without the appropriate weight-rated, vehicle-support equipment.
6. NEVER REMOVE a driveshaft from the vehicle without keeping the vehicle's transmission in neutral. See above warning.
7. CAUTION – Spicer Life Series™ driveshaft assemblies can weigh in excess of 100 pounds (46 kilograms). Be sure to use proper lifting techniques when handling Spicer Life Series™ driveshafts. More than one person may be needed when handling driveshaft assemblies.
8. ALWAYS use support straps to prevent the driveshaft from falling out of vehicle during the removal and installation process.
9. ALWAYS wear protective gloves when applying grease to slip joints or other driveshaft components.
10. NEVER heat components or use sledgehammers or floor jacks to remove the driveshaft from vehicle.

Note: For driveshaft applications that have pillow blocks, dampers, parking brakes or retarders, refer to these component manufacturers' or the original equipment vehicle manufacturers' service manuals for proper procedures.

⚠ WARNING

Failure to release all parking brakes and failure to place transmission in neutral can result in torque being applied to the driveshaft. Disconnecting a driveshaft with applied torque can result in property damage, serious personal injury or death.

Inadequate lubrication can cause driveline failure which can result in separation of the driveline from the vehicle. A separated driveline can result in property damage, serious personal injury or death.

Incompatible lubricants/greases which are applied to universal joints and/or slip members, can result in failure of the driveline and can result in separation of the driveline from the vehicle.

To prevent serious eye injury, always wear safety glasses when performing maintenance or service. Failure to wear safety glasses could result in serious personal injury, and/or partial or complete vision loss.

Spicer Life Series™ Lubrication

⚠ WARNING

ALWAYS use support straps to prevent the driveshaft from falling out of the vehicle. Failure to use a support straps can cause damage to the driveshaft or result in property damage, serious personal injury or death. **DO NOT** attach the support straps to fuel lines, oil lines, brake lines, or wiring. **DO NOT** entangle fuel lines, oil lines, brake lines or wiring in the support straps.

Lack of proper lubrication is one of the most common causes of universal joint and slip member problems. When properly applied, relubable Spicer Life Series™ universal joints which are adequately relubricated at recommended intervals will meet or exceed vehicle operation requirements.

Note: Spicer Life Series™ replacement universal joint kits contain only enough grease to provide needle roller bearing protection during storage. It is therefore necessary to completely lubricate each replacement kit prior to assembly into yokes.

Note: There are numerous instances when special lubrication is required by vehicle specifications or customer request. The lubrication recommendations listed in this manual are prescribed by Spicer Driveshaft Division engineering. Any alternate lubricants, or lubrication procedures, are the responsibility of the user.

Inadequate relubrication intervals and failure to properly lubricate the universal joints will cause universal joint failures. Proper relubrication flushes the universal joints, thus removing abrasive contaminants from the bearings. Relubable slip members must also be adequately relubricated to prevent slip member failure.

⚠ WARNING

Inadequate relubrication can cause driveline failure which can result in separation of the driveline from the vehicle.

Recommended Lubricants for Relubable Universal Joints and Slip Members

Standard Application

Spicer recommends that the following requirements be met for any lubricant that will be used to service most vehicular, industrial and all auxiliary driveshaft applications.

Note: Refer to Dana information bulletin number J3295 for additional grease specification guidelines.

⚠ CAUTION

Failure to use Dana recommended grease specification may cause premature component wear and void warranty coverage.

- Use a good quality E.P. (extreme pressure) grease
- Timkin Test Load – 50 lbs/23Kg minimum
- Meeting N.L.G.I. (National Lubricating Grease Institute), E.P., Grade 2 specifications
- Grease must have an operating range of +325°F to -10°F (+163°C to -23°C)

Consult your local lubricant source for greases that meet these specifications.

⚠ WARNING

Incompatible lubricants/greases which are applied to universal joints and/or slip members, can result in failure of the driveline and can result in separation of the driveline from the vehicle.

Grease Compatibility

When greases made from different thickeners are mixed, the mixture may result in lower service performance or physical properties than either of the original component products. This reduction in lubricant performance is called incompatibility. It may show up in any of several areas, such as:

1. Lower heat resistance;
2. Change in consistency, usually softening; or
3. Decrease in shear stability.

Mixtures which show none of these changes are considered compatible. Incompatibility is not always caused by the thickener, since each of the greases in the mixture is a complete package—thickener, fluid, and additives.

Sometimes the thickener of one grease is incompatible with the fluid or the additives present in the second grease. If the mixture proves to be significantly softer, less shear stable, or less heat resistant than the original grease, the mixture shall be deemed incompatible.

Incompatibility is best determined in service or in service-related tests; it is not predictable. Certain thickener combinations often have been found unsatisfactory and are generally so recognized. These would include lithium and sodium greases and organo-clay and most soap greases. **Contact your local lubricant supplier for grease compatibility information.**

To help reduce the effects of incompatible greases, make sure to thoroughly purge all four bearing seals on each universal joint with the new grease. Purge seals until the fresh grease is visible on the outside of all four bearing seals.

It is recommended that all purged grease be wiped clean to prevent discharge into the general environment.

Intervals for Universal Joints

Lubrication intervals vary depending on the service requirements and operating conditions of the vehicle or machine. The table, below, shows the recommended universal joint lubrication intervals for various types of service.

Universal Joint Lubrication Intervals

Series	Cycle*	City	On-Highway	Linehaul	Off-Highway
10-Series (1480 thru 1810 & SPL-90)	All	5,000 / 8,000 mi (8,000/12,000 km)	10,000 / 15,000 mi (16,000 / 24,000 km)	10,000 / 15,000 mi (16,000 / 24,000 km)	10,000 / 15,000 mi (16,000 / 24,000 km)
Life Series (Medium Duty) SPL-55, 70, & 100		25,000 mi (40,000 km) or 6 months	25,000 mi (40,000 km) or 6 months	25,000 mi (40,000 km) or 6 months	25,000 mi (40,000 km) or 6 months
Life Series (Heavy Duty) SPL-140		25,000 mi (40,000 km) or 6 months	100,000 mi (160,000 km) or 6 months	100,000 mi (160,000 km) or 6 months	25,000 mi (40,000 km) or 6 months
Life XL Series (Heavy Duty) SPL-170XL, 250XL, & 350XL	First Lubrication	100,000 mi (160,000 km) or 1 year	350,000 mi (560,000 km) or 3 years	350,000 mi (560,000 km) or 3 years	100,000 mi (160,000 km) or 1 year
	Relubrication	25,000 mi (40,000 km) or 6 months	100,000 mi (160,000 km) or 6 months	100,000 mi (160,000 km) or 6 months	25,000 mi (40,000 km) or 6 months

IMPORTANT: *Slip members are booted and permanently lubricated.

FIRST LUBRICATION - After initial miles or time is reached, the u-joints must be relubricated.

RELUBRICATION - Once greased, this relubrication interval must be followed.

We recommend relubrication with Chevron Ultra-Duty EP-2 or a compatible lithium-based grease meeting N.L.G.I. Grade 2 specifications with an operating range of +325°F/+163°C to -10°F/-23°C.

NOTE: We recommend that all driveshafts be inspected for wear and damage every time the vehicle is serviced. This includes any scheduled and/or unscheduled maintenance that occurs within the driveshaft lube intervals.

City is defined as all applications that require a minimum of 90% of operation time within the city limits.

On-Highway is defined as all applications requiring less than 10% of operation time on gravel, dirt, or unpaved roads.

Linehaul is defined as 100% of operation time on smooth concrete or asphalt.

On/Off-Highway is defined as all applications operating primarily on paved roads, but requiring more than 10% of operating time on gravel, dirt, or unpaved roads.

Universal Joints Lubrication

1. Use the recommended lubricant to purge all four seals of each universal joint. This flushes abrasive contaminants from each bearing assembly and assures proper filling of all four bearings.

IMPORTANT

Note: Make sure **fresh** grease is evident at all universal joint bearing seals.

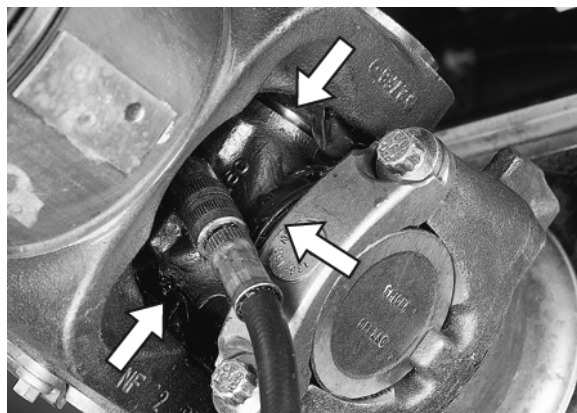

2. If any of the seals fail to purge, try to push the trunion away from the bearing cup while applying grease. On two side zerk fittings, try greasing from the opposite side of the fitting.

Note: Due to sealing capability of the Spicer Life design, there may be one or more bearing assembly seals that will not purge.

3. If any bearing cup assemblies fail to purge, releasing seal tension may be necessary.

Releasing Universal Joint Bearing Seal Tension

Quick Disconnect™ Spring Tab Style

IMPORTANT

It will be necessary to have additional bearing retainer or stamped strap bolts and stamped straps in order to complete the following instructions.

1. Utilizing a brass hammer and wearing safety glasses, sharply strike inboard yoke on lug ear once to firmly seat bearing against spring tab and relieve tension across span. Rotate shaft 180 degrees and repeat procedure on opposite lug ear.



2. Apply grease gun pressure and purge all four bearings until fresh grease is seen at all four bearing seals.
3. If striking lug ears does not cause purging, remove and discard spring tab bolts and spring tabs.

4. With a marking stick, paint marker or other legible device, mark all bearing positions in relation to yokes and bearing retainers at the effected universal joint. This assures proper reassembly of the driveshaft into the vehicle, in its original position. See Warning Below.

WARNING

Reassembly of a driveline out of original phase can cause vibration and failure of the driveline and attaching components.



5. Working at the effected universal joint, support the driveshaft with a support strap. Attach support straps to frame rails or some structural part of the vehicle.
6. Remove the bearing retainers and bolts at the effected universal joint.

Note: New cold formed bearing retainers **DO NOT** need to be replaced. Replace only if damaged.

Cold Formed Straps (SPL 140, 170, 250, 350)



Stamped Straps (SPL 55, 70, 100)



Bolt Specifications - Quick Disconnect™

Series	Thread Size	Head Size*	Bolt Torque	
			N·m	Lb. Ft.
SPL 140	12mm - 1.25	12mm, 12 point	156	115
SPL 170	12mm - 1.25	12mm, 12 point	156	115
SPL 250	12mm - 1.25	12mm, 12 point	156	115
SPL 350	12mm - 1.25	12mm, 12 point	250	185

* Spicer bolts are specially heat-treated.
DO NOT substitute with inferior grade bolts.

- It may be necessary to unseat bearing cup assemblies by tapping on yoke or bearing cup with a soft-faced hammer. Once the bearing cup assemblies are free, allow the driveshaft to rest on support strap.



- Apply a c-clamp around the outboard bearings. Apply grease gun pressure. Completely purge both inboard bearings.

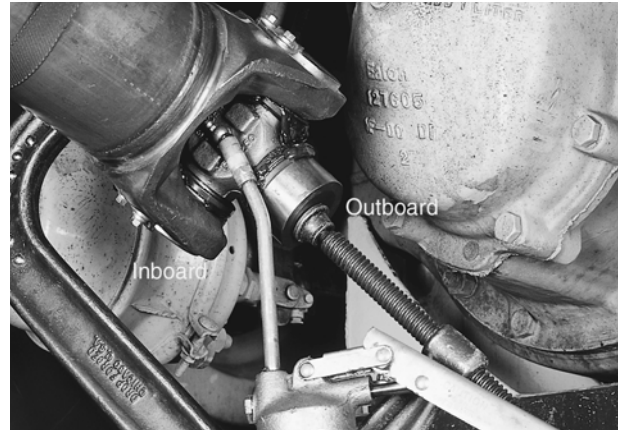

- If bearings fail to purge, slightly loosen c-clamp and reapply grease gun pressure until both outboard bearings purge.
- After all four bearings purge fresh grease, retighten c-clamp to squeeze out excess grease and wipe clean. This will ease installation of universal joint kit back into yoke. Install universal joint kit in the yoke using new bearing retainer bolts, and torque bolts to the required specifications.
- If the bearings still will not purge, complete replacement of the universal joint kit is required. See removal section of this manual for proper procedures on removing Spicer Quick Disconnect™ style driveshaft assemblies and spring tab style universal joints.

Slip Joint Lubrication

Lubrication Procedure for Slip Members

- Apply grease gun pressure to the lube fitting until lubricant appears at the seal. Always use an E.P., Grade 2 specification, N.G.L.I grease on spline members. Spicer recommends the same lubricant used for universal joints.

Caution - In cold temperatures, be sure to activate the slip member by driving the vehicle sufficiently to cause displacement of the grease prior to its stiffening. Failure to do so could cause the excess lubricant to stiffen in the cold weather and force the welch plug out. The end of the spline would then be open to collect contaminants and can result in drive-line failure.

Lubrication for Center Bearings

All Spicer manufactured center bearings are permanently lubricated. No attempt should be made to add or change grease with the bearing itself.

This Page Intentionally Blank

Spicer Life Series™ Driveshaft Removal Warnings and Cautions

Before You Get Started

1. ALWAYS wear safety glasses when performing maintenance or service. Failure to wear safety glasses can result in personal injury and/or partial or complete vision loss.
2. NEVER go under a vehicle while the engine is running. Be sure the vehicle's engine is off, and keys are removed from ignition.
3. NEVER go under or work on a vehicle that is not on a level or flat surface.
4. NEVER work on a driveshaft without blocking the vehicle's wheels and releasing all parking brakes. See warning below.
5. NEVER lift a vehicle without the appropriate weight-rated, vehicle-support equipment.
6. NEVER REMOVE a driveshaft from the vehicle without keeping the vehicle's transmission in neutral. See above warning.
7. CAUTION – Spicer Life Series™ driveshaft assemblies can weigh in excess of 100 pounds (46 kilograms). Be sure to use proper lifting techniques when handling Spicer Life Series™ driveshafts. More than one person may be needed when handling driveshaft assemblies.
8. ALWAYS use support straps to prevent the driveshaft from falling out of vehicle during the removal and installation process.
9. NEVER heat components or use sledgehammers or floor jacks to remove the driveshaft from vehicle.

Note: For driveshaft applications that have pillow blocks, dampers, parking brakes or retarders, refer to these component manufacturers' or the original equipment vehicle manufacturers' service manuals for proper procedures.

WARNING

Reassembly of a driveline out of original phase can cause vibration and failure of the driveline and attaching components. Failure of a driveline can result in separation of driveline from the vehicle, which can result in property damage, serious personal injury or death.

Attaching or entangling support straps to fuel, oil or brake lines or wiring can result in their damage. Damaged fuel, oil or brake lines or wiring can result in failure of the vehi-

cle, which can result in property damage, serious personal injury or death.

DO NOT reuse bearing retainer bolts, stamped straps, stamped strap bolts, damaged bearing retainers, or use inferior grade bolts. Reuse of bearing retainer bolts, stamped straps, stamped strap bolts, damaged bearing retainers or the use of inferior grade bolts can cause driveline failure, which can result in separation of driveline from the vehicle. A separated driveline can result in property damage, serious personal injury or death.

DO NOT deform yoke cross holes by removing excessive metal. Raised metal or deformed yoke cross holes can be a cause of cross and bearing failure, which can result in separation of driveline from vehicle. A separated driveline can result in property damage, serious personal injury or death.

DO NOT reuse flange bolts, washers or nuts or use inferior grade bolts. Reuse of flange bolts, washers or nuts or use of inferior grade bolts can cause driveline failure, which can result in separation of driveline from the vehicle. A separated driveline can result in property damage, serious personal injury or death.

Driveshaft assemblies can weigh in excess of 100 pounds (46 kilograms). Make sure to use proper lifting techniques when handling driveshafts. More than one person may be needed when handling driveshaft assemblies.

Hand tightening of grease zerk fittings or plugs is NOT recommended. Grease zerk fittings or plugs will eventually vibrate loose and fall out of journal. Prolonged operation with missing grease zerk fittings or plugs allows contaminants into the universal joint. Invasion of contaminants into the universal joint can degrade the lubricant and cause universal joint damage, which can result in separation of the driveline from the vehicle. A separated driveline can result in property damage, serious personal injury or death.

Removal

Driveshaft Removal

Refer to the transmission, axle or transfer case original equipment manufacturers' service and maintenance manuals for removal procedure.

Removal Procedures for Driveshaft Assemblies

1. Mark Driveshaft ("Phasing Marks")
It is imperative to mark all the mating components of a driveshaft, as illustrated below. Mark the driveshaft with a marking stick, paint marker or other legible marking device. In addition, be sure to mark all bearing positions, spline positions, shaft locations and all bearing retainers. This assures proper reassembly of the driveshaft into the vehicle, in its original position.

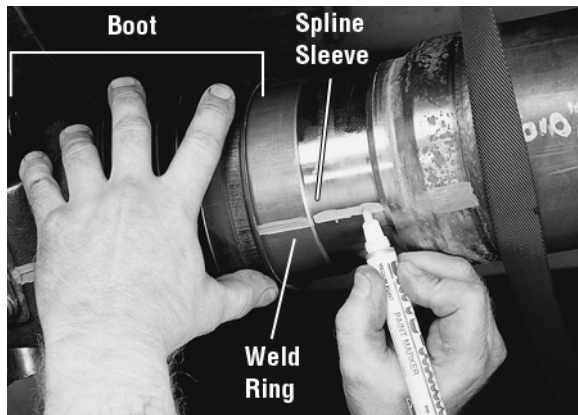

2. Be sure to ALWAYS use support straps to prevent the driveshaft from falling out of the vehicle.

3. Remove the bearing retainers or stamped straps and bolts at rear end. Discard bolts. Discard stamped straps.
 - a. Cold Formed retainers CAN be reused if there is no damage. If damaged, replace.
 - b. Stamped straps CANNOT be reused.

Cold Formed Straps



Stamped Straps



4. It may be necessary to unseat bearing cup assemblies by tapping on yoke or bearing cup with a soft-faced hammer. Once the bearing cup assemblies are free, collapse the driveshaft until both bearing assemblies clear the open end yoke cross holes. Allow the driveshaft to rest on support strap.



5. Remove bearing retainers or stamped straps and bolts at the **front** end.
6. Inspect all end yoke cross hole surfaces and bolt hole threads for damage. If the bolt hole threads are damaged, the yoke must be replaced.
7. Inspect for raised metal or fretting on open yoke cross holes can be removed with a fine-toothed file and/or emery cloth.



8. Inspect the end yoke cross holes for distortion and damage.

Inspect Companion Flange/Flange Yokes

1. Inspect all flange bolt hole threads or through holes for damage. If the bolt hole threads or through holes are damaged, the flange must be replaced.

Note: For removal procedures for companion flanges, refer to the original equipment manufacturers' service and maintenance manuals. For removal procedures for flange yokes, see removal of universal joints in this manual.

2. Inspect all flange faces for galling or damage. If damaged, the flange must be replaced.

Grease Zerk Removal and Installation

Remove Grease Zerk Fitting or Plug

1. Tilt the universal joint kit or flange yoke and universal joint kit to allow access to effected grease zerk fitting or plug. Using pliers or an open-ended wrench, turn grease zerk fitting or plug counter-clockwise until it is removed from the journal cross. Discard the grease zerk fitting or plug.

Grease Zerk Fitting Only

Check for threads in the journal. If threads are present, proceed to next step. If threads are not present, replacement of universal joint is necessary.

2. Thoroughly wipe clean the grease zerk fitting or plug threaded hole.

Install New Grease Zerk Fitting or Plug

3. Install new grease zerk fitting or plug. Tighten to minimum 15 ft. lbs. (20 Nm). Then continue to turn only until grease zerk fitting is correctly positioned.

Slip Member Assembly

Remove Grease Zerk Fitting

1. Using pliers or an open-ended wrench, turn grease zerk fitting counter-clockwise until it is removed from the slip yoke seal. Discard the grease zerk fitting.
2. Thoroughly wipe clean the grease zerk fitting threaded hole.

Install New Grease Zerk Fitting

3. Install new grease zerk fitting (Spicer part number 500174-1). Tighten to 31-55 in. lbs. (3.5-6.2 Nm).

Removal Procedure for Universal Joint Kits

Note: Refer to the Appendix for the recommended list of tools for the following procedure.

Remove Universal Joint Kit(s)

1. **For Snap-Ring Style:** Using snap-ring pliers, remove all snap rings. If snap rings are severely corroded or out-of-round, snap rings must be replaced.

Snap-Ring Style

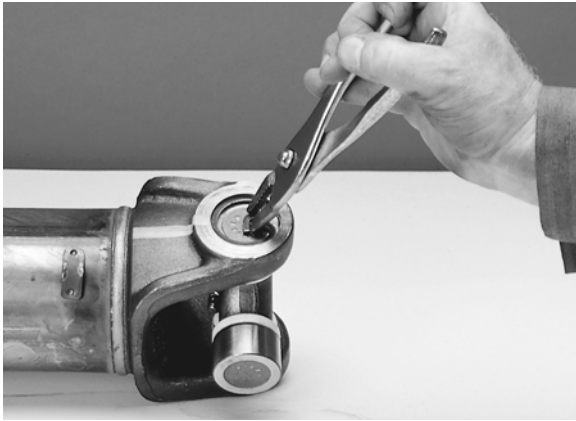

1. **For Quick Disconnect™ Style:** Remove spring tab bolts and discard, and remove outboard bearing cap assemblies.

Quick Disconnect™ Style



2. Make sure universal joints cross assembly is not tilted in the yoke. Place bearing cup spacer onto the base of the arbor press and under the yoke. If the arbor is larger than the bearing cup diameter, a smaller diameter push rod will be needed to avoid damaging the yoke or bearing.

Correct Positioning

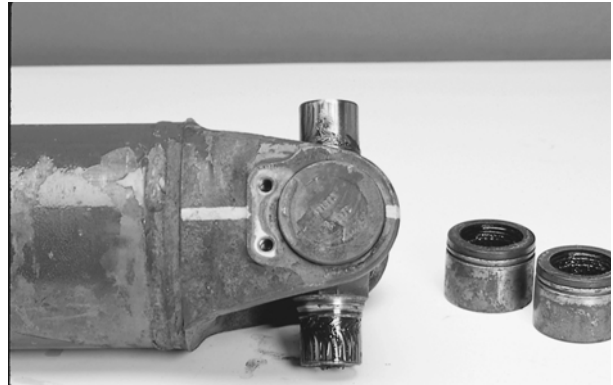

Incorrect Positioning



- Using an arbor press, press down on the upper bearing cup assembly until the shoulder of the journal cross makes contact with the inside of the yoke ear.

Caution - DO NOT over press the bearing cup and journal cross. This can damage the inside of the yoke ear.

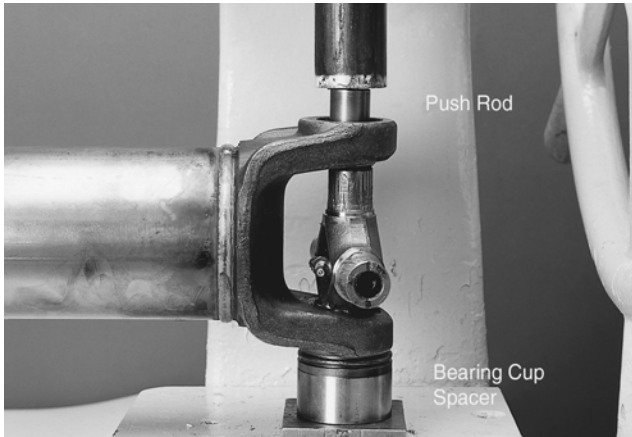

- The bearing cup is not designed to drop out of the yoke. Move the partially pressed-out bearing cup from side to side, to "walk" the bearing cup out of the yoke ear. Remove the bearing cup from the trunnion.
- Place the yoke in the press, with the remaining bearing cup face down. Using a push rod, press on the end of the journal cross trunnion. Continue to press down on the journal cross trunnion until the shoulder of the journal cross makes contact with the inside of the yoke ear.

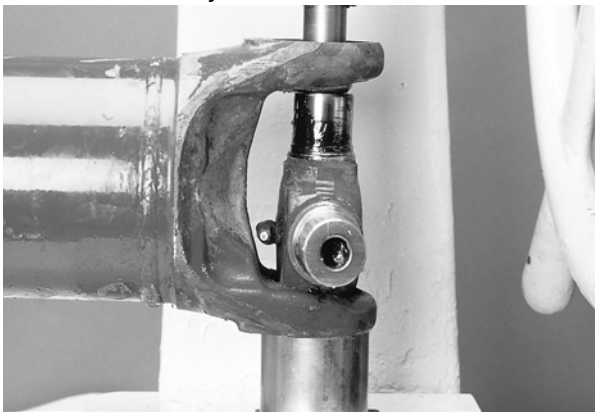

Inspect Tube Yoke and Flange Yoke (if applicable)

- Inspect the tube yoke and flange yoke (if applicable) cross hole surfaces for damage or raised metal. Raised metal or fretting can be removed from yoke cross holes with a fine-toothed file and/or emery cloth.

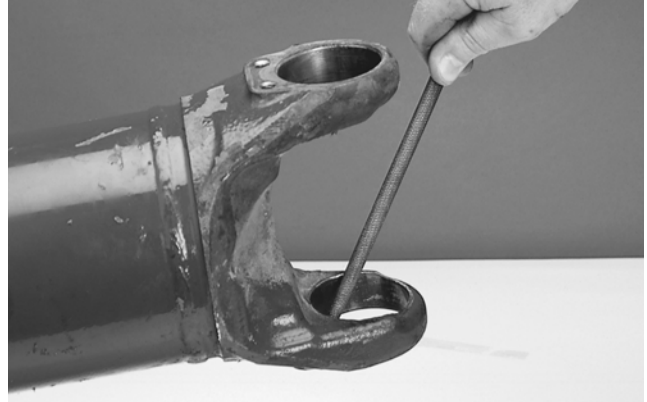

Removal Procedure for Slip Member Boot

Mark Driveshaft ("Phasing Marks")

- It is imperative to mark all mating components of the driveshaft. Mark the driveshaft with a marking stick, paint marker or other legible marking device.
- Remove and discard both boot clamps. Clamps may be separated using a chisel to disengage locking hooks. **DO NOT** reuse clamps.



- Completely collapse the boot toward the yoke shaft to expose weld ring and spline sleeve area. Wipe weld ring and spline sleeve areas clean.
- Remove the yoke shaft and boot from the spline sleeve. Discard boot.

5. Inspect the yoke shaft spline surface for damage. If the splines are damaged, missing or twisted, or any Glidecote is missing, complete driveshaft replacement is necessary.
6. Inspect the spline sleeve for damage. If the splines are damaged, missing or twisted, complete drive-shaft replacement is necessary.
7. Inspect the entire slip assembly for contaminants. If the slip assembly shows evidence of rust or the lube is severely contaminated, complete driveshaft replacement is necessary.

Note: Refer to Slip Member Installation section of this manual for additional details.

Center Bearing Removal

Remove Midship Nut on Center Bearing Yoke

1. Mark the counterbore of end yoke to midship "nose" with marking stick, paint marker or other legible marking device. This assures proper reassembly of the center bearing end yoke in its original phased position.

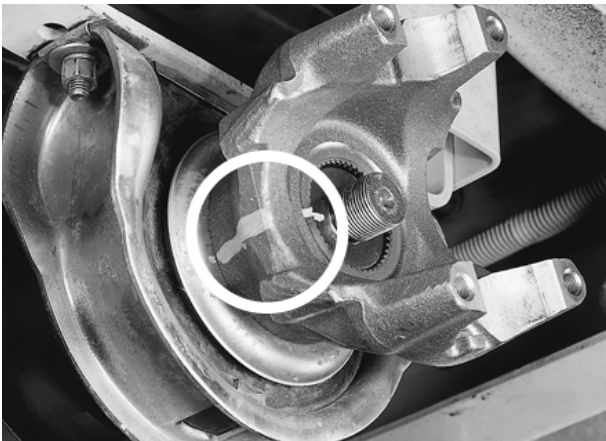

2. Remove midship nut. Discard nut. If washer is damaged, discard and replace. Otherwise, reuse washer.

DO NOT reuse midship nut. Reuse of midship nut can cause driveline failure, which can result in separation of driveline from vehicle. A separated driveline can result in property damage, serious personal injury or death.

Caution - The following step is an additional marking process to that described in the previous section step one. Be sure to mark as directed.

3. Remove center bearing bracket bolts. Allow coupling shaft to rest on support strap.



4. Using a puller, follow the tool manufacturer's instructions to remove the yoke and center bearing companion flange. Both the yoke and companion flange are press fit and should **NOT** be removed with a hammer. If either the yoke or companion flange are loose enough to be removed by hand, the entire coupling shaft must be replaced. Remove and discard slinger from the yoke.

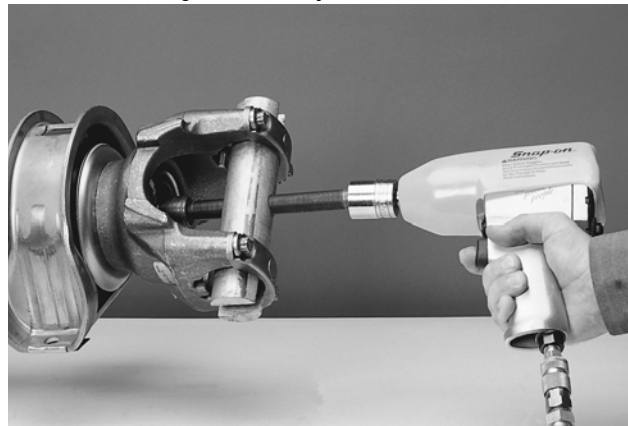

Center Bearing End Yoke Splines Inspection

1. Visually inspect the splines of the center bearing end yoke. If the yoke splines are damaged, missing or twisted, the yoke must be replaced. If the yoke hub is cracked, the yoke must be replaced.
2. Visually inspect the midship splines and threads. If the splines or threads are damaged, missing or twisted, replacement of the entire coupling shaft is necessary.

Remove Center Bearing

1. On some Spicer center bearing assemblies, a metal retainer spans the outside center bearing bracket. If present, remove the metal retainer and discard.

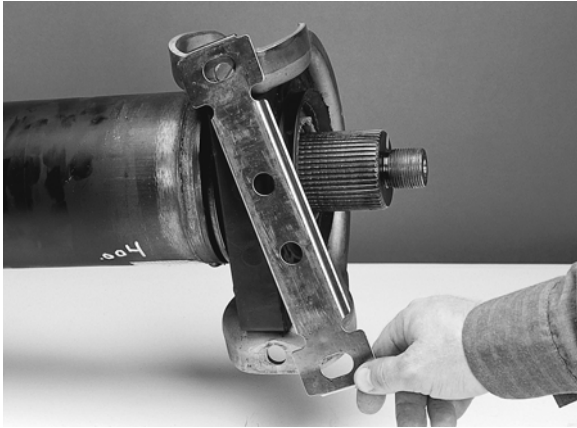

2. Remove and discard the center bearing bracket.



3. Remove and discard rubber cushion.



4. Using a puller, follow the tool manufacturer's instructions to remove the bearing assembly from the midship. Discard the center bearing.

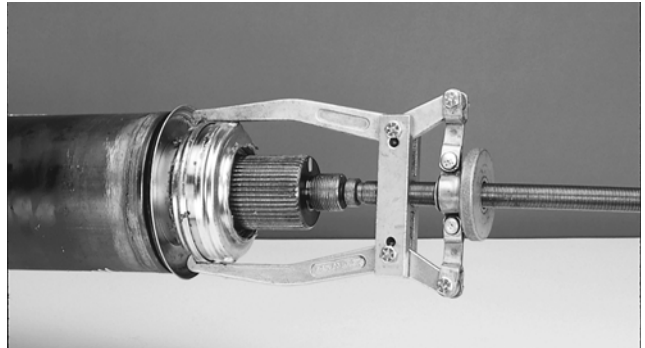

Inspect Midship Bearing Diameter

5. Inspect midship for wear on bearing diameter. If midship is damaged from a seized bearing, replacement of entire coupling shaft is necessary.

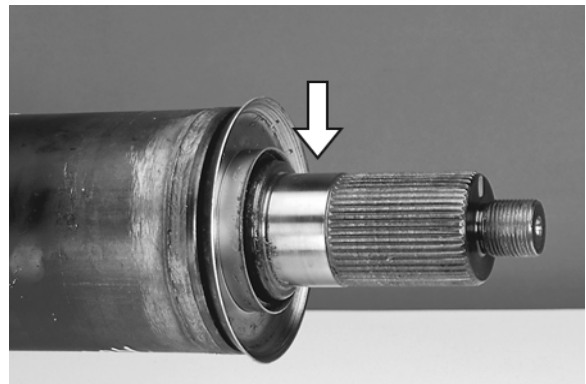

6. If no damage is apparent, remove slinger and discard. Proceed to installation of center bearing.

Spicer Life Series™ Driveshaft Installation Warnings and Cautions

Before You Get Started

1. ALWAYS wear safety glasses when performing maintenance or service. Failure to wear safety glasses can result in personal injury and/or partial or complete vision loss.
2. NEVER go under a vehicle while the engine is running. Be sure the vehicle's engine is off, and keys are removed from ignition.
3. NEVER go under or work on a vehicle that is not on a level or flat surface.
4. NEVER work on a driveshaft without blocking the vehicle's wheels and releasing all parking brakes. See warning below.
5. NEVER lift a vehicle without the appropriate weight-rated, vehicle-support equipment.
6. NEVER REMOVE a driveshaft from the vehicle without keeping the vehicle's transmission in neutral. See above warning.
7. CAUTION – Spicer Life Series™ driveshaft assemblies can weigh in excess of 100 pounds (46 kilograms). Be sure to use proper lifting techniques when handling Spicer Life Series™ driveshafts. More than one person may be needed when handling driveshaft assemblies.
8. ALWAYS use support straps to prevent the driveshaft from falling, causing injury and/or damage during the loosening or removal of any driveshaft hardware.
9. NEVER heat components or use sledgehammers or floor jacks to remove the driveshaft from vehicle.

Note: For driveshaft applications that have pillow blocks, dampers, parking brakes or retarders, refer to these component manufacturers' or the original equipment vehicle manufacturers' service manuals for proper procedures.

WARNING

Reassembly of a driveline out of original phase can cause vibration and failure of the driveline and attaching components. Failure of a driveline can result in separation of driveline from the vehicle, which can result in property damage, serious personal injury or death.

Rotating bearing cup assemblies can result in yoke cross hole wear and distortion. Distorted yokes can result in separation of the driveline from the vehicle.

Reuse of spring tab bolts or failure to properly tighten spring tab bolts to required specifications can cause the driveline to loosen and separate from the vehicle.

Failure to torque the midship nut to required specifications can cause driveline failure, which can result in separation of the driveline from the vehicle.

Reuse of boot clamps or failure to properly tighten boot clamps to required specifications could allow intrusion of contaminants onto slip member and can cause driveline failure, which can result in separation of driveline from the vehicle.

Attaching or entangling support straps to fuel, oil or brake lines or wiring can result in their damage. Damaged fuel, oil or brake lines or wiring can result in failure of the vehicle.

Improperly seated bearing cup assemblies can cause driveline failure, which can result in separation of the driveline from the vehicle.

Failure to install new stamped straps and new bolts and to torque bolts to specification can cause driveline failure, which can result in separation of the driveline from the vehicle.

Installation of a driveline out of original phase can cause vibration and failure of the driveline and attaching components. Failure of a driveline can result in separation of the driveline from the vehicle.

Universal Joint Installation

Snap-Ring Style

Spicer Life Series 55, 70, 90, 100, 350

1. Using a high quality National Lubricating Grease Institute E. P. Grade 2 lubricating grease, wipe each bearing cup assembly with grease. Fill all cavities between the needle rollers. Also apply a liberal coating of grease on the bottom of each bearing cup assembly and on the lip of the seal.

Note: Refer to Dana information bulletin J3295 for additional grease specification guidelines.

Caution: Failure to use Dana recommended grease specifications may cause premature component wear and void warranty coverage.



Do not add grease to non-greasable U-joint kits. Mixing grease types and/or over greasing can cause premature failures.



Caution - Spicer **DOES NOT** recommend wiping the outside of bearing cup assemblies or yoke cross holes with grease, oil or silicone-based sprays. This could result in bearing cup assembly rotation in yokes.

2. Position the journal cross into the yoke cross holes with grease zerk (nipple) fitting inward toward tubing. The double-headed, grease zerk (nipple) fitting should be perpendicular to the yoke cross holes.

Failure to properly position the universal joint kit will result in the inability to grease the universal joint.

Note: If using an arbor press, proceed to step 3. If using a universal joint tool, follow the manufacturer's instructions.



Note: Always inspect bearing cups for rollers that may have fallen (downed rollers) out of place before installation.

3. Move one end of the journal cross to cause a trunnion to project through the cross hole beyond the outer machined face of the yoke ear. Place the bearing cup assembly over the protruding trunnion diameter and align it to the yoke cross hole.
4. Align the yoke in an arbor press with the bearing assembly resting on the base of the press. Cover the yoke ear with a metal plate that has 0.25 inch (6.4 mm) minimum thickness. Push the yoke onto the bearing cup assembly until it is flush with the cross hole face.

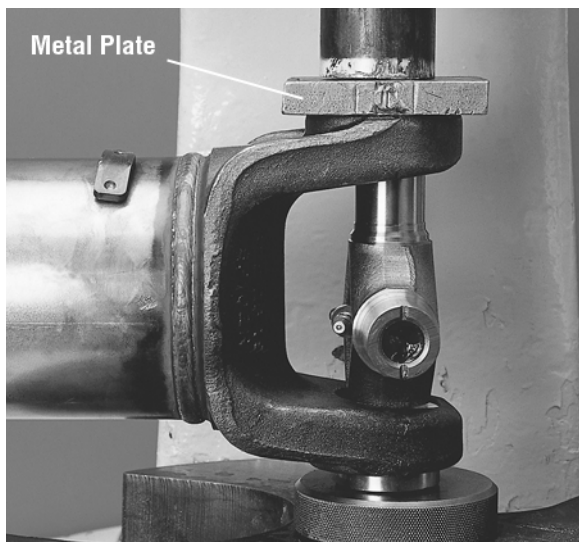

5. Place a push rod that is smaller than the diameter of the bearing cup assembly under the bearing cup assembly and continue pressing into the yoke cross hole until far enough to install a snap ring.

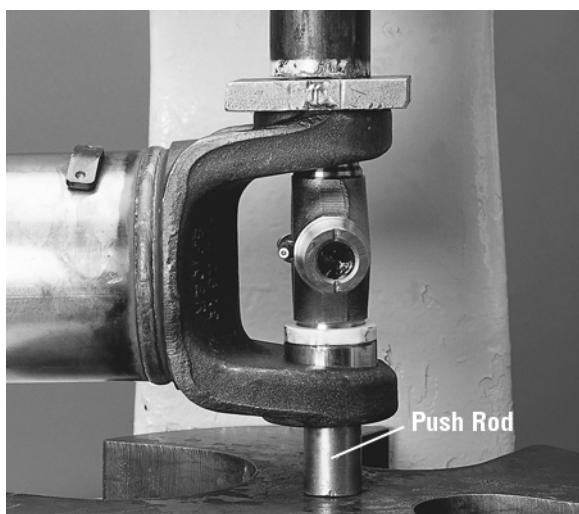

6. Remove yoke from arbor press. Install a snap ring using snap ring pliers.

7. Flip yoke 180 degrees. Place another bearing cup over trunnion diameter and align it to yoke cross hole. Align yoke in arbor press with previously installed bearing cup assembly resting on base of press. Place a push rod that is smaller than the bearing cup assembly on top of the bearing cup assembly. Press bearing cup assembly into the yoke cross hole until far enough to install a snap ring.

CAUTION

Bearing caps must be aligned with the trunnion before pressing to avoid bearing roller and trunnion damage.

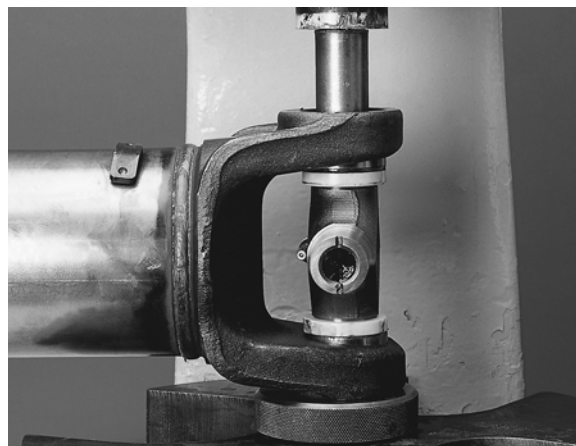

8. Remove yoke from arbor press. Install a snap ring using snap ring pliers.
9. Seat installed snap rings into grooves using a small chisel or punch.



- Flex the journal cross to make sure it moves smoothly and freely in the bearings.

Note: If the joint is stiff, place a plate on the yoke ear and hit the plate with a hammer to seat the bearing cup assemblies.

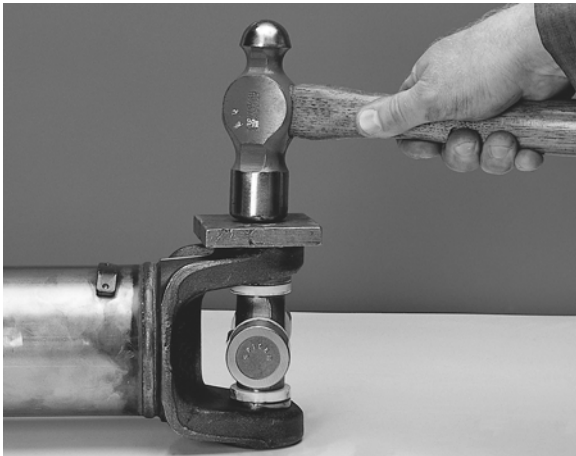

- Rotate the journal cross to make sure it moves smoothly and freely in the bearings. If not, disassemble and inspect the journal and bearing assemblies for skewed or dropped needle rollers. Reference removal procedures for universal joints, snap-ring style.

Spring Tab Style

Spicer Life Series 140, 170 & 250

- Remove needle retaining plugs from all bearing cup assemblies. Using a high quality National Lubricating Grease Institute E. P. Grade 2 lubricating grease, wipe each bearing cup assembly with grease. Fill all cavities between the needle rollers. Also apply a liberal coating of grease on the bottom of each bearing cup assembly and on the lip of the seal.

Note: Refer to Dana information bulletin J3295 for additional grease specification guidelines.

CAUTION

Failure to use Dana recommended grease specifications may cause premature component wear and void warranty coverage.



Caution - Spicer DOES NOT recommend wiping the outside of bearing cup assemblies or yoke cross holes with grease, oil or silicone-based sprays. This could result in bearing cup assembly rotation in yokes.

- Position the journal cross into the yoke cross holes with the grease zerk (nipple) fitting inward toward tubing. The double-headed, grease zerk (nipple) fitting should be perpendicular to the yoke cross holes.

Note: Failure to properly position the universal joint will result in the inability to grease the universal joint.



Note: Always inspect bearing cups for rollers that may have fallen (downed rollers) out of place before installation.

3. Move one end of the journal cross to cause a trunnion to project through the cross hole beyond the outer machined face of the yoke ear. Take one bearing cup assembly and position an installation height tool on the end of the bearing cup assembly. Place the bearing cup assembly over the protruding trunnion diameter and align it to the yoke cross.



4. Align the yoke in an arbor press with the bearing assembly resting on the base of the press. Cover the yoke ear with a metal plate that has 0.25 inch (6.4 mm) minimum thickness. Push the yoke onto the bearing cup assembly until it is flush with the cross hole face. **Do not remove the installation height tool.**

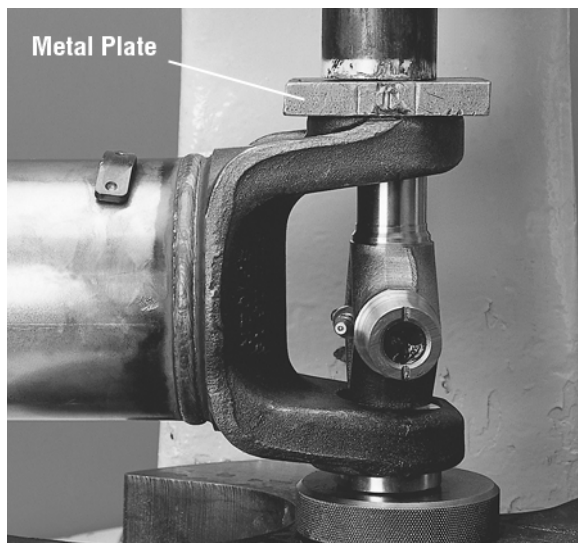

5. Flip yoke 180 degrees. Position the remaining installation height tool on the end of another bearing cup assembly. Place bearing cup assembly over trunnion diameter and align it to the yoke cross hole. Push the bearing cup assembly until both installation height tools are flush with the cross hole face.

6. Install new spring tabs and 8mm thread bolts. Make sure that no grease or foreign material is present between the contact areas of the spring tabs, bearing cups and yoke cross hole faces. Tighten bolts to the required torque.



SPRING TAB BOLT SPECIFICATIONS

SERIES	THREAD SIZE	HEAD SIZE	BOLT Nm	TORQUE LB. FT.
SPL140	8mm x 1.00	8mm, 6 point	34-41	25-30
SPL170	8mm x 1.00	8mm, 6 point	34-41	25-30
SPL250	8mm x 1.00	8mm, 6 point	34-41	25-30

**Bolts are specially heat-treated.
DO NOT substitute inferior grade bolts.*

Center Bearing Installation

1. Wipe the bearing surface of the midship tube shaft with a fine emery cloth.
2. Install a new slinger (included in center bearing replacement kit) on the midship tube shaft using a section of tubing to avoid damaging slinger. Make sure the slinger is completely seated against the midship tube shaft shoulder



Note: If the application requires the installation of a slinger, avoid damage during installation.

Note: Do not reuse old slingers. Most replacement center bearings will not include slingers.

- Carefully align the new center bearing assembly with the ground surface of the midship tube shaft. Physically push the center bearing onto the midship tube shaft.

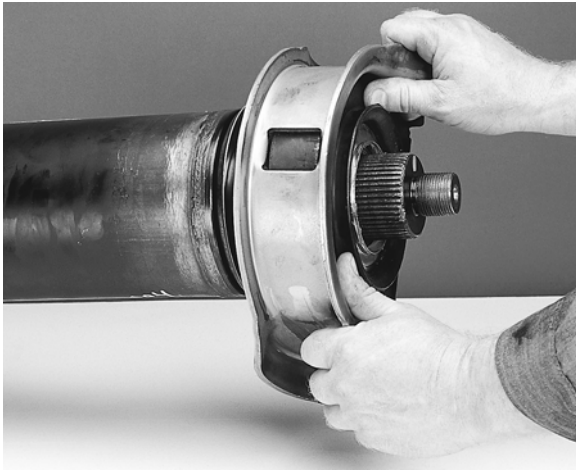

- Press remaining slinger on end yoke using a section of tubing to avoid damaging slinger.



- Using a soft-faced hammer, drive the yoke onto midship tube shaft, making sure phasing marks from driveshaft removal procedure are in line. Continue to tap the yoke until it is completely seated against the center bearing.

Note: Only drive (press) off the washer face of the yoke. Never hammer or press on the ears of the yoke. See illustration.

- Install a washer (if required) and **new** midship nut and torque nut to specifications. See midship nut specifications, Table MM.

Failure to torque midship nut to required specifications can cause driveline failure, which can result in separation of the driveline from the vehicle. A separated driveline can result in property damage, serious personal injury or death.

Table MM - Midship Nut Specifications

Series	Head Size	Nut Torque N-m	Nut Torque Lbs. Ft.
SPL55	1 5/16"	542-610	400-450
SPL70	1 5/8"	644-712	475-525
SPL90	1 5/8"	644-712	475-525
SPL100	1 5/8"	644-712	475-525
SPL140	41mm*	644-712	475-525
SPL170	41mm*	644-712	475-525
SPL250	41mm*	644-712	475-525
SPL350	41mm*	1100-1300	810-950

Slip Member and Boot Installation

- Clean ALL grease from yoke shaft and spline sleeve. Make sure grease-cutting solvent does not intrude into the tube through the vent hole in the spline sleeve plug. Be sure the phasing marks made during disassembly are not removed.



Note: Failure to torque strap bolts in the proper sequence may cause premature bearing failure.



- Torque strap bolts to specification according to the chart below.

Bolt Specifications - Quick Disconnect™

Series	Thread Size	Head Size	Bolt Torque Nm	Bolt Torque Lb. Ft.
SPL 55 SPL 70 SPL 90/100	3/8 - 24	3/8" 12 point	75	55
SPL 140 SPL 170 SPL 250	12mm - 1.25	1/2" 12 point	156	115

- Grease the U-joint and slip member after drive-shaft installation. Refer to Lubrication section of this manual. Refer to Dana information bulletin J3295 for grease specification guidelines.

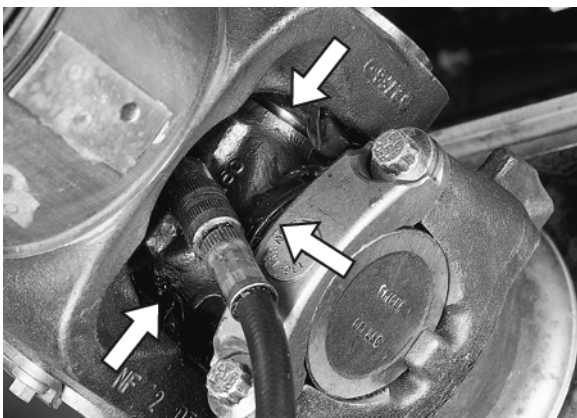

Glossary

Balancing - A procedure by which the mass distribution of a rotating body is checked, and corrected to insure smooth operation.

Ball Yoke - See Tube Yoke.

Bearing Cross Hole - See Cross Hole.

Bearing Cup Assembly - Consists of a bearing up with needle rollers generally held in place by a seal guard and bearing seal. Sometimes the assembly includes a thrust washer.

Bearing Cup - A cup-shaped member used as the bearing bore of a bearing cup assembly and for positioning a thrust end of a cross trunnion.

Bearing Retainer - A heavy, formed metal cap used to retain a bearing cup assembly in Quick Disconnect end yoke or flange yoke designs.

Bearing Seal - A flexible member of a bearing cup assembly which prevents the escape of lubricant from or entry of foreign matter into a bearing.

Bearing Strap - Stamped metal strap used to retain a bearing cup assembly in a half-round end yoke or flange yoke design.

Boot - A flexible member which prevents the escape of lubricant from or entry of foreign matter into the slip spline members.

Boot Clamp - A thin adjustable band used to hold the boot in position on the slip spline members.

Boot Seal - See Boot.

Center Bearing - Consists of a rolling element bearing isolated in rubber and a bracket configuration for attachment to the vehicle fram.

Companion Flange - A fixed flange member that attaches the driveshaft assembly to another drivetrain component.

Coupling Shaft - The coupling member or members of a multiple-piece driveline which includes a center bearing.

Cross - See Journal Cross.

Cross Hole - A through hole in each lug ear of a yoke used to locate a bearing cup assembly.

Deflector - See Slinger.

Driveline - An assembly of one or more coupling shafts and a driveshaft with provisions for axial movement, which transmits torque and/or rotary motion at a fixed or varying angular relationship from one drivetrain component to another.

Driveshaft - An assembly of one or two universal joints connected to a tubular shaft member which accomodates axial movement.

Driveshaft Length (Center Line to Center Line or CL to CL) - The distance between the outermost universal joint centers on a driveshaft. On driveshafts with variable length centers, it is usually measured in the compressed or installed lengths.

Ear - One of two projecting parts of a yoke symmetrically located with respect to the yoke's rotational axis.

End Fitting - An end yoke or companion flange (including S.A.E., DIN and T-Type styles) that attaches a driveshaft to another drivetrain component.

End Yoke - A Quick Disconnect yoke that attaches a driveshaft to another drivetrain component.

Flange Yoke - A full-round or Quick Disconnect style yoke which attaches a driveshaft to a companion flange.

Glidecote - The blue, nylon, wear-resistant coating on Spicer yoke shafts and tube shafts.

Grease Zerk Fitting - The fitting on the shoulder or center of a journal cross or on a relubable slip spline that allows for lubrication.

Inboard Yokes - Yokes that make up the ends of a driveshaft or coupling shaft assembly, i.e. tube yokes, slip yokes, yoke shafts, and center bearing end yokes.

Installation Height Tools - Round, hard plastic disk that are supplied with all Spicer Life Series replacement universal joint kits to ensure proper bearing cup assembly installation specifications.

Journal Cross - The core component of a universal joint which is an intermediate drive member with four equally spaced trunnions in the same plane.

Lug Ear - See Ear.

Midship Shaft - A machined element consisting of spline teeth, a pilot for a center bearing and a piloting hub that attaches to the tube of a coupling shaft assembly.

Needle Rollers - One of the rolling elements of a bearing cup assembly.

Outboard Components - Yokes that are not a part of a drive-shaft, i.e. transmission, axle, transfer case end yokes and/or companion flanges.

Phase Angle - The relative rotational position of each yoke on a driveshaft or driveline.

Pressure Relief Hole - A hole in the welch plug of Spicer slip yokes that allows air to escape from the slip member assembly.

Purge - The act of flushing old grease and contaminants from universal joint kits and slip member assemblies with fresh grease.

Quick Disconnect Cross Hole - A semicircular hole located on the end of each lug ear of some end yoke and flange yoke designs used to locate a bearing cup assembly.

Retaining Ring - See Snap Ring.

Retaining Ring Groove - See Snap Ring Groove.

Seal Can - A metal "can" that permanently seals the slip member on a driveshaft. Usually found on European-style driveshaft assemblies.

Seal Guard - A covering member used to protect a bearing seal on the bearing cup assembly.

Serrated Flange - See T-Flange

Shaft Length - Distance between the outermost universal joint center to joint center.

Shaft Support Bearing - See Center Bearing

Slinger - A stamped metal or non-metal ring which prevents the entry of foreign matter into a center bearing, transmission, axle or transfer case.

Slip - The total permissible length of axial travel.

Slip Yoke - A yoke which accommodates axial movement.

Slip Yoke Plug - See Welch Plug.

Slip Yoke Seal - Pop-on or threaded ring that contains a seal that protects the slip member assembly from environmental contaminants and retains lubricant.

Snap Ring - A removable member used as a shoulder to retain and position a bearing cup assembly in a yoke cross hole.

Snap Ring Groove - A groove used to locate a snap ring.

Spline - A machined element consisting of integral keys (spline teeth) or keyways (spaces) equally spaced around a circle or portion thereof.

Spline Sleeve - A tubular-type, machined element consisting of internal splines which is attached to a tube or tube yoke in a driveshaft assembly.

Spring Tab - A patented stamped metal plate that takes the place of a bearing plate and acts as a structural member by reducing looseness in a universal joint kit. Found only on Spicer Life Series driveshaft assemblies.

Stub Shaft - See Tube Shaft.

Tang - A nib of metal found on Quick Disconnect end yoke and/or flange yoke style cross holes, used to locate a bearing cup assembly.

T-Flange - A companion flange and flange yoke design which has a serrated flange face. Found most often in European applications.

T-Type Flange - See T-Flange.

Thrust Washer - A washer found in the bottom of a bearing cup assembly that reduces needle roller friction, bearing heat and guards against end galling on the journal cross trunnions.

Tubing - See Tube.

Tube O.D. (outside diameter) - The outside diameter of a tube.

Tube Yoke - An inboard yoke with a piloting hub for attachment to a tube or spline sleeve.

Tube Shaft - A machined element consisting of spline teeth and a piloting hub that attaches to the tube of a driveshaft assembly.

Trunnion(s) - Any of the four projecting journals of a cross.

Universal Joint - A mechanical device which can transmit torque and/or rotary motion from one shaft to another at fixed or varying angles of intersection of the shaft axes. Consisting of a journal cross, fitting and four bearing cup assemblies.

Universal Joint Kit - See Universal Joint.

U-Joint - Universal Joint with installation hardware.

Welch Plug - A plug in the slip yoke face that seals off one end of the spline opening. Also known as a slip yoke plug.

Weld Yoke - See Tube Yoke.

Yoke Lug Ear Cross Hole - See Cross Hole.

Yoke Shaft - A slip member yoke with a male machined spline used for axial movement.

Appendix

Required Tools

One of the following is recommended:

- Three ton minimum, Arbor Press, along with (for Spicer Life Series 55, 70, 90, 100, 140, 170 & 255) Bearing Cup Spacer and Push Rod
Metal Plate 0.25 inches (6.4mm) thick,
or
- J & J Tool Co., Inc. (See photo 104)
Universal Joint Puller Kit 4LIFE - Basic or Complete
(for Spicer Life Series 140, 170 & 250)
1-800-2221-4903
Outside U.S.A. and Canada 1-215-256-9300
or
- Tiger Tool TGLS-597 (See photo 105) or Mark 10A
(not shown)
(for Spicer Life Series 140, 170 & 250)
1-800-61-4660
Outside U.S.A. and Canada 1-604-855-1133

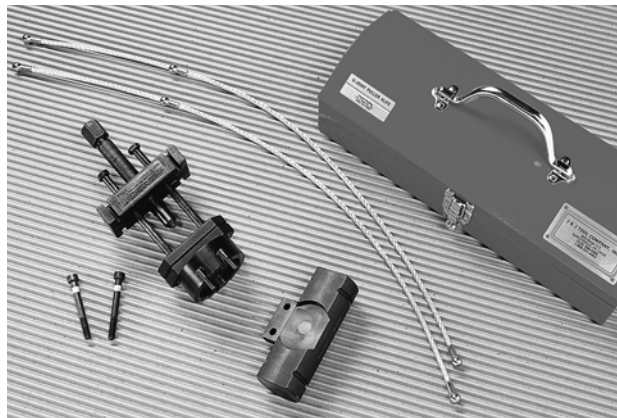

For spec'ing or service assistance, call 1-877-777-5360 or visit our website at www.dana.com

Dana Commercial Vehicle Products Group

3939 Technology Drive
Maumee, Ohio, USA 43537

www.dana.com



SPICER®

Drivetrain Products