

136	CAMBIO DE MECANISMO EN ASIENTO HANDICAP <i>CHANGE OF MECHANISM IN SEAT HANDICAP</i>	Elaboración	15-sept-08	D.I. M.C.B.
		Aprobación	15-sept-08	D.I. M.C.B.
No. Instructivo	Descripción	Revisión	06/16/2016	L.D.I. J.V.I

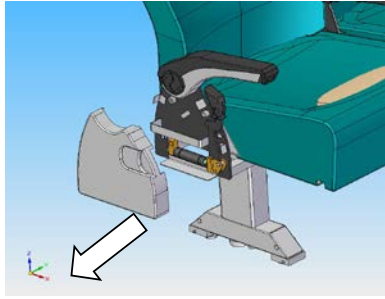

1. QUITAR TAPA PLÁSTICA
QUITANDO LOS
REMACHES
**1. REMOVE PLASTIC
COVER REMOVING THE
RIVETS**



2. QUITAR ACCIONADOR DE COJIN
2.REMOVE LEVER OF BLOCKADE []

2. QUITAR CANDADOS "E" DEL MECANISMO
3. REMOVE MECHANISM'S "E" CLIPS

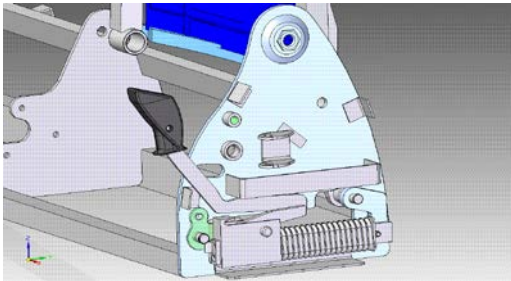
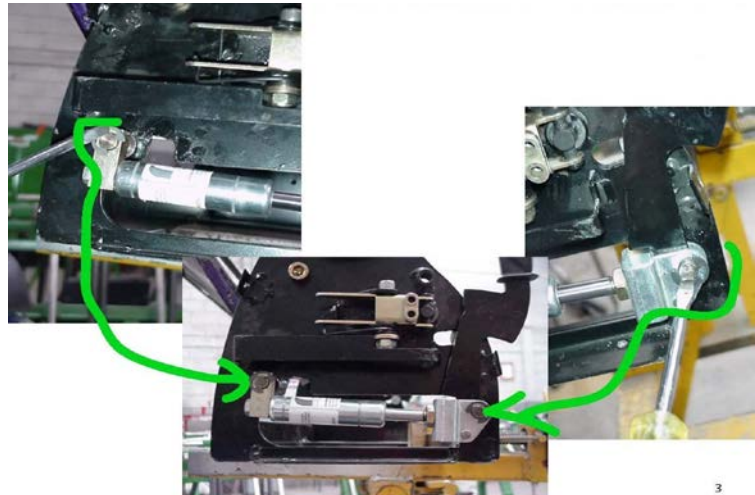

4. COLOCAR NUEVO MECANISMO T0507c320
4. PLACE NEW MECHANISM []

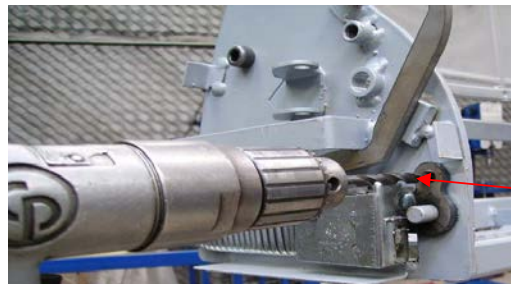

5. HACER BARRENO EN LA PLACA COMO SE ILUSTR.
5. DRILL DE PLATE AS SHOW, USE SLOT HOW GUIDE

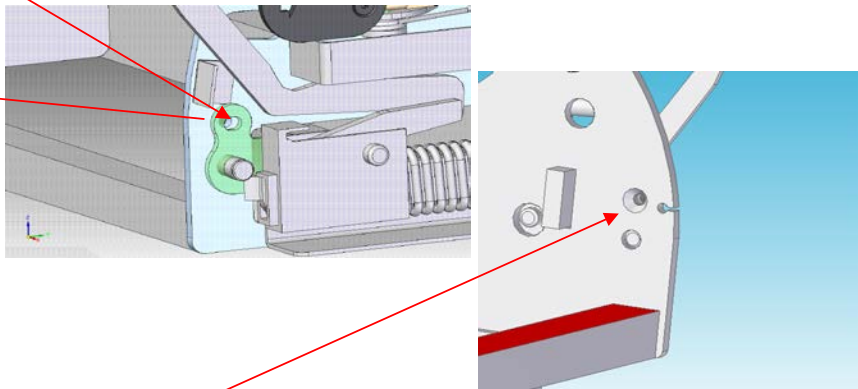

5.1 TO MAKE CHAMFER FOR BOLT FLAT COUNTERSINK 1/4" x 3/4"
BY THE INTERIOR SIDE PLATE FRAME SEAGT

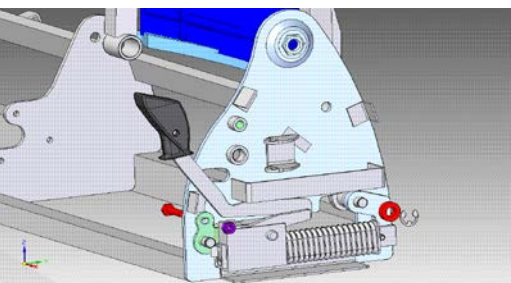

6. COLOCAR EL BUJE,CANDADO "E",TOR. C/B. 1/4" x 1" Y TCA. DE SEG. 1/4"

136	CAMBIO DE MECANISMO EN ASIENTO HANDICAP <i>CHANGE OF MECHANISM IN SEAT HANDICAP</i>	Elaboración	15-sept-08	D.I. M.C.B.
		Aprobación	15-sept-08	D.I. M.C.B.
No. Instructivo	Descripción	Revisión	06/16/2016	L.D.I. J.V.I

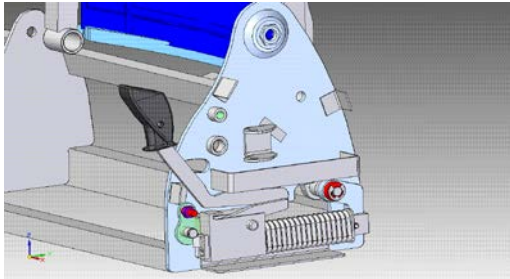

BOLT 1/4" AUTOLOCK BOLT FLAT COUNTERSIN 1/4" x 3/4"
 BUSHING



6. PLACE THE BUSHING, CLIP "E", SCREW 1/4"x1" AND BOLT AUTOLOCK 1/4"

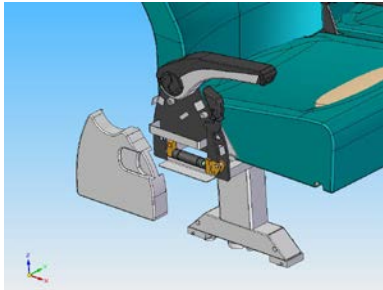

7. COLOCAR TAPA PLASTICA
 Y REMACHARLA
**7. PLACE PLASTIC
 COVER AGAIN AND THE RIVETS TOO**



8. COLOCAR ACCIONADOR DE COJIN
**8. PLACE LEVER OF BLOCKADE []
 AGAIN**

