

**\*\*Ground distribution:\*\***

0-Electric gnd  
00- Electronic Gnd

A-Dash - Lh console harness  
F-Front junction box harness  
FH-Front harness  
R-Rear junction box harness  
FR-Front to rear

# Chassis ground distribution

## Front GND stud

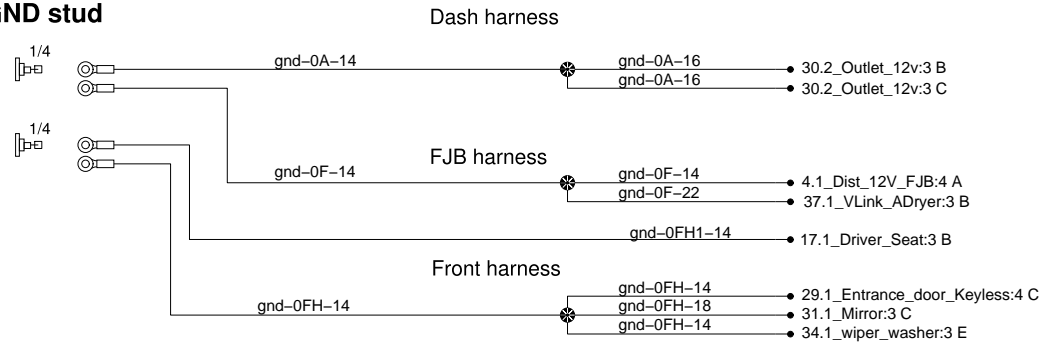

## Evaporator cmpt. stud

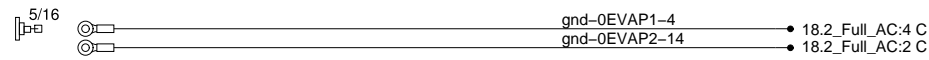

## Urea cmpt. stud

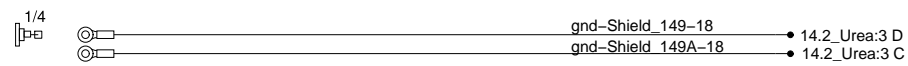

## Located on the top of the luggage compartment

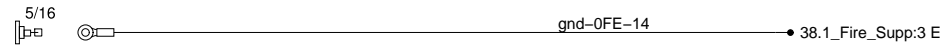

## Condensor cmpt. stud

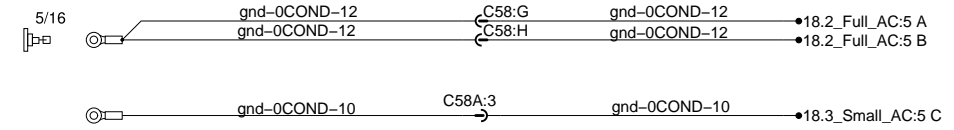

## RJB stud

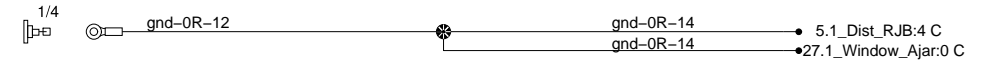

## Front radiator stud

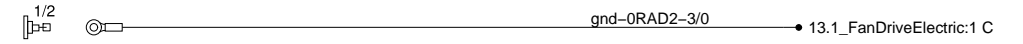

## Rear radiator stud



## Radiator on door stud

## Trailer stud



## Engine cmpt. studs

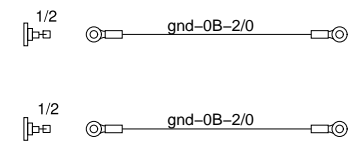

## Engine studs

