



**PREVOST.**

# **OPERATOR'S MANUAL**

**X3-45 COACH**



# PREVOST

## OPERATOR'S MANUAL X3-45 COACH



PA-1636 rev. 3  
February 2024

## PA-1636

### Featuring:

- New front and rear aerodynamic design
- New head light design

First edition: July 2019, Model-year 2019 preliminary vehicle K-6447

| REV | EFFECTIVE | DESCRIPTION   | DATE        |
|-----|-----------|---|-------------|
| -   | L-6493    | First release   | July 2019   |
| 1   | M-6655    | New Prevost Driver Assist system                                    | August 2020 |
| 2   | N-6676    | New VSS06 sound selector, new HVAC control module, new DEA700 radio | May 2021    |
| 3   | R-4068    | New MY2024 D13 engine EPA2024 EOBD-U24                              | Feb 2024    |

|  |             |
|--|-------------|
|  | i           |
| <b>FOREWORD</b>  |             |
| <b>IMPORTANT INFORMATION</b> .....                           | <b>X</b>    |
| <b>COMPLIANCE</b> .....                                      | <b>XI</b>   |
| STATE OF CALIFORNIA PROPOSITION 65 .....                     | <b>XI</b>   |
| <b>CRITICAL EMISSION-RELATED MAINTENANCE</b> .....           | <b>XII</b>  |
| <b>DATA LOGGING</b> .....                                    | <b>XIII</b> |
| EVENT DATA RECORDING DEVICES .....                           | <b>XIII</b> |
| ELECTRONIC LOGGING DEVICE (ELD) .....                        | <b>XIV</b>  |
| TELEMATICS DEVICE .....                                      | <b>XV</b>   |
| <b>OWNERSHIP OR ADDRESS HAS CHANGED</b> .....                | <b>XV</b>   |
| <b>QUESTIONS AND COMPLAINTS</b> .....                        | <b>XV</b>   |
| <b>REPORTING SAFETY DEFECTS</b> .....                        | <b>XVI</b>  |
| UNITED STATES .....  | <b>XVI</b>  |
| CANADA .....   | <b>XVI</b>  |
| <b>SECTION 1 - Safety Precautions</b>                        |             |
| <b>SAFE OPERATING PRACTICES</b> .....                        | <b>2</b>    |
| <b>DEFENSIVE DRIVING PRACTICES</b> .....                     | <b>3</b>    |
| <b>OTHER PRECAUTIONS</b> .....                               | <b>3</b>    |
| <b>SECTION 2 - Coach Exterior</b>                            |             |
| <b>EXTERIOR VIEW</b> .....                                   | <b>2</b>    |
| <b>ENGINE COMPARTMENT COMPONENTS</b> .....                   | <b>4</b>    |
| <b>ENGINE COMPARTMENT REAR DOOR</b> .....                    | <b>6</b>    |
| <b>EXHAUST AFTERTREATMENT SYSTEM ACCESS DOOR</b> .....       | <b>7</b>    |
| <b>BACK-UP CAMERA</b> .....                                  | <b>7</b>    |
| <b>ENGINE COMPARTMENT CURBSIDE DOOR</b> .....                | <b>8</b>    |
| <b>120-VOLT CONNECTORS</b> .....                             | <b>8</b>    |
| ENGINE BLOCK HEATER .....                                    | <b>8</b>    |
| BATTERY CHARGER .....  | <b>8</b>    |
| <b>MAIN POWER COMPARTMENT</b> .....                          | <b>9</b>    |
| <b>WHEELCHAIR LIFT ACCESS DOORS</b> .....                    | <b>10</b>   |
| <b>FUEL AND DIESEL EXHAUST FLUID (DEF) FILLER DOOR</b> ..... | <b>10</b>   |
| <b>CONDENSER COMPARTMENT (A/C)</b> .....                     | <b>11</b>   |
| <b>BAGGAGE COMPARTMENTS</b> .....                            | <b>13</b>   |
| <b>ENTRANCE DOOR</b> .....                                   | <b>14</b>   |
| LOCK OPERATION .....   | <b>14</b>   |
| OPENING THE ENTRANCE DOOR FROM OUTSIDE .....                 | <b>14</b>   |
| OPENING THE ENTRANCE DOOR FROM INSIDE .....                  | <b>14</b>   |
| DOOR OPERATION LOGIC .....                                   | <b>14</b>   |
| EMERGENCY DOOR OPENING .....                                 | <b>15</b>   |
| <b>SPARE WHEEL COMPARTMENT</b> .....                         | <b>15</b>   |
| <b>FRONT ELECTRICAL AND SERVICE COMPARTMENT</b> .....        | <b>16</b>   |
| <b>REAR-VIEW MIRRORS</b> .....                               | <b>17</b>   |
| <b>SIDE CAMERA REAR-VIEW SYSTEM</b> .....                    | <b>17</b>   |
| <b>EVAPORATOR COMPARTMENT</b> .....                          | <b>17</b>   |
| <b>REAR FENDERS</b> .....                                    | <b>18</b>   |
| <b>COOLANT PREHEATER</b> .....                               | <b>18</b>   |
| <b>HUBODOMETER</b> .....                                     | <b>18</b>   |
| <b>ENGINE RADIATOR DOOR</b> .....                            | <b>19</b>   |
| <b>SCR CONVERTER ACCESS HATCH</b> .....                      | <b>20</b>   |
| <b>TRAILER HITCH</b> .....                                   | <b>20</b>   |
| TRAILER HITCH LIMITATIONS .....                              | <b>21</b>   |

### 3-ii Table of contents

---

#### SECTION 3 - Coach Interior

|   |           |
|---|-----------|
| <b>UTILITY COMPARTMENTS</b> .....                   | <b>2</b>  |
| <b>MICROPHONE JACKS</b> .....                       | <b>2</b>  |
| <b>DRIVER'S SEAT - ISRI</b> .....                   | <b>2</b>  |
| MECHANICAL ISRI SEAT .....                          | 2         |
| PNEUMATIC ISRI SEAT .....                           | 4         |
| <b>DRIVER'S SEAT – USSC 9100ALX</b> .....           | <b>4</b>  |
| DRIVER SEAT BELT .....                              | 5         |
| <b>PASSENGER SEATS</b> .....                        | <b>6</b>  |
| SWIVEL SEATS .....                                  | 6         |
| PASSENGER SEAT BELT .....                           | 7         |
| FOLDING TRAYS .....                                 | 7         |
| <b>TABLES</b> .....                                 | <b>8</b>  |
| <b>OVERHEAD CONSOLE</b> .....                       | <b>8</b>  |
| ADJUSTABLE AIR REGISTERS .....                      | 8         |
| SERVICE CHIME .....                                 | 8         |
| READING LIGHTS .....                                | 8         |
| <b>WINDOWS</b> .....                                | <b>9</b>  |
| PANORAMIC WINDOWS .....                             | 9         |
| DRIVER'S POWER WINDOW .....                         | 9         |
| <b>DRIVER'S AREA SUNSHADES</b> .....                | <b>9</b>  |
| <b>VENTILATION / EMERGENCY EGRESS HATCHES</b> ..... | <b>10</b> |
| <b>OVERHEAD COMPARTMENTS</b> .....                  | <b>10</b> |
| <b>ADJUSTABLE HVAC REGISTERS</b> .....              | <b>11</b> |
| <b>WASTE CONTAINER</b> .....                        | <b>11</b> |
| <b>STEERING WHEEL ADJUSTMENT</b> .....              | <b>11</b> |
| <b>INTERIOR MIRRORS</b> .....                       | <b>11</b> |
| <b>LAVATORY</b> .....                               | <b>11</b> |
| <b>GALLEY</b> .....                                 | <b>12</b> |
| <b>KEYS</b> .....                                   | <b>13</b> |
| EXTERIOR COMPARTMENT KEY .....                      | 13        |
| UTILITY COMPARTMENT KEY .....                       | 13        |
| FUEL FILLER DOOR KEY (OPTION) .....                 | 13        |
| LAVATORY DOOR KEY .....                             | 13        |
| UTILITY AND VIDEO COMPARTMENT KEY .....             | 13        |
| HAND TOWEL DISPENSER KEY .....                      | 13        |

#### SECTION 4 - Controls and Instruments

|   |           |
|---|-----------|
| <b>IGNITION SWITCH</b> .....                          | <b>4</b>  |
| ACCESSORIES .....                                     | 4         |
| OFF .....   | 4         |
| ON .....  | 4         |
| START .....   | 5         |
| <b>DRIVER'S AREA OVERVIEW</b> .....                   | <b>6</b>  |
| <b>LATERAL CONTROL PANEL</b> .....                    | <b>7</b>  |
| TRANSMISSION CONTROL PAD .....                        | 7         |
| CONTROL SWITCHES .....                                | 7         |
| MIRROR CONTROLS .....                                 | 9         |
| TAG AXLE CONTROL VALVE .....                          | 9         |
| PARKING BRAKE CONTROL VALVE .....                     | 9         |
| PREHEATER TIMER (OPTION) .....                        | 9         |
| LOW-BUOY CONTROL VALVE (OPTION) .....                 | 9         |
| UTILITY COMPARTMENT .....                             | 10        |
| 12-VOLT POWER OUTLET .....                            | 10        |
| TRAILER AIR SUPPLY CONTROL VALVE (OPTION) .....       | 10        |
| EMERGENCY/PARKING BRAKES OVERRULE CONTROL VALVE ..... | 10        |
| <b>SIDE CAMERA REAR-VIEW MONITORS</b> .....           | <b>10</b> |

|  |           |
|--|-----------|
| REFERENCE LINES .....  | 10        |
| BRIGHTNESS ADJUSTMENT .....  | 11        |
| MONITOR STATE .....  | 11        |
| <b>BACK-UP CAMERA AND MONITOR .....</b>  | <b>13</b> |
| <b>SCENIC VIEWING SYSTEM CAMERA .....</b>                                      | <b>13</b> |
| <b>ON BOARD DIAGNOSTIC TOOL RECEPTACLE .....</b>                               | <b>13</b> |
| <b>AUTOMATIC FIRE DETECTION AND SUPPRESSION SYSTEM (AFSS) .....</b>            | <b>13</b> |
| AUTOMATIC FIRE SUPPRESSION SYSTEM PANEL .....                                  | 13        |
| <b>CRUISE CONTROL .....</b>  | <b>13</b> |
| TURNING THE SYSTEM ON .....  | 14        |
| SETTING A CRUISING SPEED .....   | 14        |
| <b>PREVOST DRIVER ASSIST™ .....</b>  | <b>16</b> |
| ASSOCIATED HARDWARE EQUIPMENT .....  | 16        |
| PREVOST DRIVER ASSIST™ CONSISTS OF THE FOLLOWING SYSTEMS AND FEATURES .....    | 17        |
| POTENTIALLY CHALLENGING SITUATIONS FOR THE PREVOST DRIVER ASSIST™ SYSTEM ..... | 19        |
| LANE DEPARTURE WARNING LDW .....   | 19        |
| FORWARD COLLISION MITIGATION FCM .....   | 22        |
| ADAPTIVE CRUISE WITH BRAKING ACB .....   | 23        |
| FOLLOWING DISTANCE ALERT (FDA) .....   | 26        |
| FOLLOWING DISTANCE ALERT .....   | 27        |
| IMPACT ALERT .....   | 28        |
| BRAKE OVERUSE WARNING .....  | 28        |
| WHAT TO EXPECT WHEN USING THE PREVOST DRIVER ASSIST™ SYSTEM .....              | 30        |
| HOW YOUR ACTIONS IMPACT THE PREVOST DRIVER ASSIST™ SYSTEM .....                | 33        |
| <b>TIRE PRESSURE MONITORING SYSTEMS (TPMS) .....</b>                           | <b>35</b> |
| SYSTEM MALFUNCTION .....   | 35        |
| TPMS-LITE VERSION .....  | 35        |
| ON-SCREEN TPMS VERSION .....   | 35        |
| <b>DASHBOARD .....</b>   | <b>39</b> |
| CONTROL SWITCHES .....   | 40        |
| <b>AUDIO-VIDEO SELECTOR FOR THE PASSENGER'S AREA .....</b>                     | <b>45</b> |
| OPERATION OF THE OPTIONAL AUDIO-VIDEO MODESTY PANEL .....                      | 48        |
| <b>DASHBOARD RADIO AM/FM/SAT SERIES DEA700 .....</b>                           | <b>48</b> |
| <b>HVAC CONTROL UNIT .....</b>   | <b>49</b> |
| <b>AIR REGISTERS .....</b>   | <b>50</b> |
| <b>INSTRUMENT PANEL .....</b>  | <b>51</b> |
| ANALOG INDICATORS .....  | 52        |
| TELLTALE LIGHTS .....  | 56        |
| STOP, CHECK AND INFORMATION TELLTALE LIGHTS .....                              | 60        |
| DRIVER INFORMATION DISPLAY .....   | 61        |
| DRIVER INFORMATION LEVEL .....   | 63        |
| PICTOGRAMS DISPLAYED ON THE DRIVER INFORMATION DISPLAY (DID) .....             | 64        |
| <b>STEERING COLUMN CONTROLS .....</b>  | <b>73</b> |
| MULTI-FUNCTION LEVER .....   | 73        |
| STEERING WHEEL CONTROLS .....  | 74        |
| HORNS .....  | 76        |
| <b>FOOT-OPERATED CONTROLS .....</b>  | <b>76</b> |
| BRAKE PEDAL .....  | 76        |
| ACCELERATOR PEDAL .....  | 76        |
| STEERING WHEEL ADJUSTMENT .....  | 77        |
| <b>ALLISON TRANSMISSION .....</b>  | <b>77</b> |
| OPERATION .....  | 77        |
| PUSHBUTTON SHIFT SELECTOR .....  | 77        |
| PRIMARY AND SECONDARY SHIFT SCHEDULES .....                                    | 78        |
| TRANSMISSION SERVICE INDICATOR .....   | 78        |

### 3-iv Table of contents

---

|  |           |
|--|-----------|
| DESCRIPTION OF AVAILABLE RANGES .....  | 78        |
| <b>VOLVO I-SHIFT TRANSMISSION .....</b>  | <b>80</b> |
| PUSHBUTTON SHIFT SELECTOR .....  | 81        |
| DISPLAY .....  | 81        |
| ACCELERATOR PEDAL .....  | 81        |
| ECONOMY AND PERFORMANCE MODE .....   | 81        |
| ECO-ROLL MODE (FREEWHEEL FUNCTION) .....   | 81        |
| LIMP HOME MODE .....   | 82        |
| STARTING AND STOPPING .....  | 82        |
| STARTING THE VEHICLE UPHILL AND DOWNHILL .....   | 83        |
| DRIVING .....  | 84        |
| TOWING RECOMMENDATIONS .....   | 85        |
| <br>   |           |
| <b>SECTION 5 - Other Features</b>  |           |
| <b>EXHAUST AFTERTREATMENT SYSTEM .....</b>   | <b>3</b>  |
| FILTRATION AND REGENERATION UNIT .....   | 3         |
| PASSIVE REGENERATION .....   | 3         |
| ACTIVE REGENERATION .....  | 3         |
| STATIONARY (PARKED) REGENERATION .....   | 3         |
| DEF CLOGGING SEQUENCE – INSTRUMENT CLUSTER TELLTALE LIGHT .....                          | 4         |
| SELECTIVE CATALYTIC REDUCTION UNIT .....   | 5         |
| DRIVER WARNING AND INDUCEMENT MEASURES .....   | 7         |
| <b>DRIVER INFORMATION DISPLAY (DID) MENUS .....</b>                                      | <b>11</b> |
| GAUGES .....   | 12        |
| FUEL DATA .....  | 14        |
| TIME/DISTANCE .....  | 15        |
| VEHICLE MESSAGES .....   | 16        |
| RESET TRIP DATA .....  | 16        |
| DISPLAY SETTINGS .....   | 16        |
| DIAGNOSTICS MENU .....   | 19        |
| PRE-TRIP ASSISTANCE (OPTION) .....   | 20        |
| DATA LOG .....   | 22        |
| AFTERTREATMENT .....   | 23        |
| PASSWORD .....   | 25        |
| PREVOST LIAISON (OPTION) .....   | 25        |
| <b>INTELLIGENT SLEEP MODE (ISM) .....</b>  | <b>27</b> |
| <b>TRANSMISSION RETARDER (OPTION) .....</b>  | <b>27</b> |
| <b>ENGINE BRAKE .....</b>  | <b>27</b> |
| VOLVO ENGINE BRAKE (VEB) .....   | 28        |
| CRUISE CONTROL AND ENGINE BRAKE .....  | 28        |
| <b>ABS, TRACTION CONTROL SYSTEM (TCS) &amp; ELECTRONIC STABILITY CONTROL (ESC) .....</b> | <b>29</b> |
| ANTILOCK BRAKING SYSTEM (ABS) .....  | 29        |
| TRACTION CONTROL SYSTEM (TCS) .....  | 29        |
| ELECTRONIC STABILITY CONTROL (OPTION) .....  | 29        |
| <b>DRIVER CONTROLLED DIFFERENTIAL LOCK (DCDL) .....</b>                                  | <b>30</b> |
| OPERATION TIPS .....   | 30        |
| LOCKING THE DCDL .....   | 31        |
| UNLOCKING THE DCDL .....   | 31        |
| <b>KNEELING SYSTEM .....</b>   | <b>31</b> |
| <b>HIGH-BUOY .....</b>   | <b>31</b> |
| <b>LOW-BUOY .....</b>  | <b>32</b> |
| <b>RETRACTABLE TAG AXLE .....</b>  | <b>32</b> |
| <b>OPTIONAL AUTOMATIC TAG AXLE UNLOADING .....</b>                                       | <b>32</b> |
| <b>PREHEATER .....</b>   | <b>32</b> |
| SWITCHING THE HEATER ON .....  | 33        |
| SWITCHING THE HEATER OFF .....   | 33        |



|   |           |
|---|-----------|
| COOLANT HEATER TIMER .....  | 33        |
| PREHEATER TROUBLESHOOTING AND MAINTENANCE .....                                 | 35        |
| <b>WHEELCHAIR LIFT SYSTEM .....</b>   | <b>36</b> |
| INTRODUCTION .....  | 36        |
| OVERVIEW .....  | 36        |
| GENERAL SAFETY PRECAUTIONS .....  | 38        |
| OPERATING INSTRUCTIONS .....  | 38        |
| MANUAL LIFT OPERATION .....   | 44        |
| <b>SEATS RECONFIGURATION .....</b>  | <b>50</b> |
| <b>WHEELCHAIR RESTRAINT SYSTEMS .....</b>                                       | <b>51</b> |
| 4-POINT SECUREMENT WITH FLOOR ANCHORAGE .....                                   | 51        |
| 4-POINT SECUREMENT WITH ANCHORAGE TO PASSENGERS SEAT PEDESTALS .....            | 52        |
| <b>WHEELCHAIR LIFT SYSTEM - THRESHOLD WARNING SYSTEM (TWS) ADJUSTMENT .....</b> | <b>53</b> |
| ADJUST AIMING OF ACOUSTIC SENSOR BEAM .....                                     | 53        |
| TEST AIM OF ACOUSTIC SENSOR BEAM (WHEELCHAIR ACCESS) .....                      | 54        |
| ADJUST ACOUSTIC SENSOR TIMING .....   | 54        |
| <b>WCL CASSETTE INSTALLATION AND REMOVAL .....</b>                              | <b>54</b> |
| <br><b>SECTION 6 - Starting and Stopping Procedures</b>                         |           |
| <b>IGNITION SWITCH .....</b>  | <b>2</b>  |
| <b>STARTING THE ENGINE .....</b>  | <b>4</b>  |
| STARTING FROM THE DRIVER'S SEAT .....   | 4         |
| STARTING FROM THE ENGINE COMPARTMENT .....                                      | 5         |
| COLD WEATHER STARTING .....   | 6         |
| JUMP STARTING .....   | 6         |
| <b>ENGINE PROTECTION SYSTEM .....</b>   | <b>8</b>  |
| AUTOMATIC ENGINE SHUTDOWN .....   | 8         |
| <b>IDLE SHUTDOWN TIMER .....</b>  | <b>8</b>  |
| <b>ENGINE BLOCK HEATER .....</b>  | <b>9</b>  |
| <b>ENGINE WARM-UP .....</b>   | <b>9</b>  |
| <b>ALLISON TRANSMISSION WARM-UP .....</b>                                       | <b>9</b>  |
| <b>STARTING THE VEHICLE AFTER A FIRE ALARM .....</b>                            | <b>9</b>  |
| <br><b>SECTION 7 - Safety Features and Equipment</b>                            |           |
| <b>EMERGENCY EXITS .....</b>  | <b>2</b>  |
| SIDE WINDOWS .....  | 2         |
| ROOF HATCH .....  | 2         |
| EMERGENCY ENTRANCE DOOR OPENING .....   | 3         |
| <b>EMERGENCY EQUIPMENT .....</b>  | <b>4</b>  |
| FIRE EXTINGUISHERS .....  | 4         |
| FIRST-AID KIT .....   | 4         |
| FIRE HATCHET .....  | 5         |
| WARNING REFLECTORS .....  | 5         |
| JACK AND TOOLS X3 SERIES .....  | 5         |
| SPARE PARTS KIT .....   | 5         |
| AUTOMATIC FIRE SUPPRESSION SYSTEM (AFSS) .....                                  | 5         |
| TIRE PRESSURE MONITORING SYSTEM .....   | 6         |
| <b>LIMP-HOME BELT .....</b>   | <b>9</b>  |
| LOWER ALTERNATOR FAILURE .....  | 9         |
| <b>SPARE WHEEL .....</b>  | <b>10</b> |
| CHANGING A WHEEL .....  | 10        |
| SUPER SINGLE TIRE REPLACEMENT .....   | 11        |
| <b>EMERGENCY AIR-FILL VALVES .....</b>  | <b>11</b> |
| <b>EMERGENCY AND PARKING BRAKES .....</b>                                       | <b>12</b> |
| <b>VEHICLE JACKING POINTS .....</b>   | <b>12</b> |
| HYDRAULIC JACK .....  | 12        |
| <b>TOWING THE VEHICLE .....</b>   | <b>13</b> |

### 3-vi Table of contents

---

|   |           |
|---|-----------|
| <b>DAYTIME RUNNING LIGHTS</b> .....   | <b>13</b> |
| <b>FOG LIGHTS</b> .....   | <b>13</b> |
| <b>PERIMETER LIGHTS</b> .....   | <b>13</b> |
| <b>COMPARTMENT LIGHTING</b> .....   | <b>14</b> |
| <b>MUD FLAPS AND SPLASH GUARDS</b> .....                                      | <b>14</b> |
| <b>BACK-UP CAMERA</b> .....   | <b>14</b> |
| <b>BACK-UP ALARM</b> .....  | <b>14</b> |
| <b>ESSENTIAL FUNCTIONS TO OPERATE THE VEHICLE (BASIC LIMP-HOME FUNCTIONS)</b> | <b>14</b> |
| AVAILABLE FUNCTIONS .....   | 14        |

#### **SECTION 8 - Care and Maintenance**

|  |           |
|--|-----------|
| <b>CLEANING</b> .....                                  | <b>3</b>  |
| SEAT UPHOLSTERY .....                                  | 3         |
| PLASTIC AND VINYL .....                                | 4         |
| WINDOWS .....  | 4         |
| STAINLESS STEEL .....                                  | 4         |
| HIGH PRESSURE LAMINATE .....                           | 4         |
| CARPET .....   | 4         |
| RUBBER COMPONENTS .....                                | 4         |
| FLOOR CLEANING .....                                   | 4         |
| EXTERIOR SURFACES .....                                | 5         |
| WINDSHIELD .....                                       | 5         |
| WIPER BLADES .....                                     | 5         |
| <b>LAVATORY MAINTENANCE</b> .....                      | <b>5</b>  |
| FILLING THE SUMP TANK .....                            | 5         |
| DRAINING THE SUMP TANK .....                           | 6         |
| <b>FLUID LEVEL VERIFICATION</b> .....                  | <b>6</b>  |
| ENGINE OIL LEVEL .....                                 | 6         |
| TRANSMISSION FLUID LEVEL .....                         | 7         |
| POWER STEERING FLUID LEVEL .....                       | 9         |
| DRIVE AXLE WHEEL BEARING OIL LEVEL .....               | 9         |
| FRONT AND TAG AXLE WHEEL HUBS .....                    | 9         |
| COOLANT FLUID LEVEL .....                              | 9         |
| WINDSHIELD WASHER & HEADLIGHTS WASHER RESERVOIRS ..... | 11        |
| <b>OTHER VERIFICATION</b> .....                        | <b>11</b> |
| ELECTRIC COOLING FANS .....                            | 11        |
| AIR TANK PURGE .....                                   | 12        |
| FIRE EXTINGUISHERS .....                               | 12        |
| PRIMARY FUEL FILTER .....                              | 12        |
| DRIVER'S A/C COMPRESSOR BELT .....                     | 13        |
| CENTRAL A/C COMPRESSOR BELTS .....                     | 13        |
| ALTERNATOR DRIVE BELTS .....                           | 14        |
| BACK-UP CAMERA .....                                   | 14        |
| ENGINE AIR FILTER RESTRICTION INDICATOR .....          | 14        |
| A/C AND HEATING SYSTEM AIR FILTERS .....               | 14        |
| HOSE INSPECTION .....                                  | 16        |
| LUBRICATION .....                                      | 16        |
| WHEELS AND TIRES VERIFICATIONS .....                   | 16        |
| WHEEL BEARINGS .....                                   | 17        |
| SERVICE BRAKE TEST .....                               | 17        |
| PARKING BRAKE TEST .....                               | 17        |
| EXTERIOR LIGHTING VERIFICATION WITH TEST MODE .....    | 18        |
| <b>GENERAL RECOMMENDATIONS</b> .....                   | <b>21</b> |
| <b>WALKAROUND INSPECTION (BEFORE EVERY TRIP)</b> ..... | <b>25</b> |
| APPROACHING THE VEHICLE .....                          | 26        |
| PREPARATION .....                                      | 26        |
| STEP 1: RIGHT SIDE .....                               | 26        |

|  |    |
|--|----|
| STEP 2: ENGINE COMPARTMENT RIGHT SIDE AREA ..... | 26 |
| STEP 3: ENGINE COMPARTMENT .....                 | 26 |
| STEP 4: REAR LEFT SIDE .....                     | 26 |
| STEP 5: FRONT LEFT SIDE .....                    | 27 |
| STEP 6: FRONT .....                              | 27 |
| STEP 7: FRONT RIGHT SIDE .....                   | 27 |
| STEP 8: INSIDE THE VEHICLE .....                 | 27 |
| WITH ENGINE RUNNING .....                        | 27 |

**SECTION 9 - Technical Information**

|  |           |
|--|-----------|
| <b>DIMENSIONS AND WEIGHTS .....</b>  | <b>3</b>  |
| <b>CAPACITIES .....</b>  | <b>6</b>  |
| <b>TURNING RADIUS .....</b>  | <b>7</b>  |
| <b>FUEL TYPE .....</b>   | <b>8</b>  |
| BIODIESEL FUEL .....   | 8         |
| <b>WHEELS AND TIRES .....</b>  | <b>8</b>  |
| RECOMMENDED TIRE INFLATION PRESSURE AT MAXIMUM COLD LOAD .....                     | 8         |
| <b>BELTS .....</b>   | <b>9</b>  |
| <b>VOLVO D13 ENGINE .....</b>  | <b>9</b>  |
| <b>ALLISON TRANSMISSION .....</b>  | <b>9</b>  |
| GEAR RATIOS .....  | 9         |
| <b>VOLVO I-SHIFT TRANSMISSION .....</b>  | <b>9</b>  |
| <b>PROPELLER SHAFT .....</b>   | <b>10</b> |
| <b>BRAKES .....</b>  | <b>10</b> |
| BRAKE CHAMBER EFFECTIVE AREA .....   | 10        |
| <b>AIR SYSTEM .....</b>  | <b>10</b> |
| <b>ANTILOCK BRAKING SYSTEM (ABS) .....</b>   | <b>10</b> |
| <b>AUTOMATIC TRACTION CONTROL (ATC) – ELECTRONIC STABILITY CONTROL (ESC) .....</b> | <b>10</b> |
| <b>STEERING .....</b>  | <b>11</b> |
| <b>ELECTRICAL SYSTEM .....</b>   | <b>11</b> |
| <b>AXLES .....</b>   | <b>11</b> |
| I-BEAM FRONT AXLE .....  | 11        |
| FRONT AXLE - INDEPENDENT FRONT SUSPENSION (IFS) .....                              | 11        |
| DRIVE AXLE .....   | 11        |
| TAG AXLE .....   | 12        |
| <b>SUSPENSION .....</b>  | <b>12</b> |
| I-BEAM AXLE FRONT SUSPENSION .....   | 12        |
| INDEPENDENT FRONT SUSPENSION .....   | 12        |
| DRIVE AXLE .....   | 12        |
| TAG AXLE .....   | 12        |
| <b>ALIGNMENT SPECIFICATIONS .....</b>  | <b>12</b> |
| <b>COOLING SYSTEM .....</b>  | <b>13</b> |
| <b>FUEL SYSTEM .....</b>   | <b>13</b> |
| <b>EXHAUST SYSTEM .....</b>  | <b>14</b> |
| <b>HEATING AND AIR CONDITIONING .....</b>  | <b>14</b> |
| <b>OIL SPECIFICATIONS .....</b>  | <b>14</b> |
| ENGINE .....   | 14        |
| ALLISON TRANSMISSION .....   | 14        |
| I-SHIFT TRANSMISSION .....   | 15        |
| DIFFERENTIAL .....   | 15        |
| POWER STEERING RESERVOIR .....   | 15        |
| <b>PRE-HEATING SYSTEM .....</b>  | <b>15</b> |
| <b>PLATES AND CERTIFICATION .....</b>  | <b>15</b> |
| SAFETY CERTIFICATION .....   | 16        |
| DOT CERTIFICATION PLATE .....  | 16        |
| <b>EPA ENGINE LABEL .....</b>  | <b>17</b> |
| <b>VEHICLE IDENTIFICATION NUMBER (VIN) .....</b>                                   | <b>17</b> |

### 3-viii Table of contents

---

|  |           |
|--|-----------|
| VIN DEFINITION .....   | 18        |
| <b>COACH FINAL RECORD .....</b>  | <b>19</b> |
| <b>ABBREVIATIONS .....</b>   | <b>1</b>  |
| <b>APPENDIX A - SERVICE LITERATURE</b>   |           |
| <b>SERVICE LITERATURE .....</b>  | <b>2</b>  |
| <b>NOTICE .....</b>  | <b>2</b>  |
| DECLARATION OF THE MANUFACTURING DEFECTS TO THE GOVERNMENT OF THE UNITED STATES .....                | 2         |
| DECLARATION OF THE MANUFACTURING DEFECTS TO THE CANADIAN GOVERNMENT .....                            | 3         |
| DECLARATION OF THE MANUFACTURING DEFECTS TO PREVOST .....  | 3         |
| <b>APPENDIX B - Multiplex Troubleshooting</b>  |           |
| <b>MULTIPLEX TROUBLESHOOTING GUIDE .....</b>   | <b>2</b>  |
| <b>APPENDIX B - Allison Transmission Other Features</b>  |           |
| <b>OIL LEVEL CHECK USING THE PUSHBUTTON SHIFT SELECTOR .....</b>                                     | <b>2</b>  |
| <b>CONTROL SYSTEM PROGNOSTICS .....</b>  | <b>3</b>  |
| NORMAL PROGNOSTICS INDICATION AT ENGINE START .....  | 3         |
| OIL LIFE MONITOR .....   | 3         |
| FILTER LIFE MONITOR .....  | 4         |
| TRANSMISSION HEALTH MONITOR .....  | 5         |
| <b>DIAGNOSTIC TROUBLESHOOTING CODES (DTC) — ALLISON 5TH GENERATION CONTROLS .....</b>                | <b>7</b>  |
| DIAGNOSTIC TROUBLESHOOTING CODES (DTC) OVERVIEW .....  | 7         |
| USING SHIFT SELECTOR FOR ACCESSING DIAGNOSTIC INFORMATION .....                                      | 7         |
| <b>DIAGNOSTIC CODE DISPLAY AND CLEARING PROCEDURE .....</b>  | <b>8</b>  |
| EXITING DIAGNOSTIC MODE .....  | 8         |
| <b>DIAGNOSTIC TROUBLE CODE RESPONSE .....</b>  | <b>9</b>  |
| <b>DIAGNOSTIC TROUBLESHOOTING CODES (DTC) LIST - ALLISON 5TH &amp; 6TH GENERATION CONTROLS .....</b> | <b>10</b> |
| <b>APPENDIX D - tpms troubleshooting</b>   |           |
| <b>ON-SCREEN TPMS .....</b>  | <b>2</b>  |
| <b>TPMS-LITE .....</b>   | <b>4</b>  |

## FOREWORD

|  |             |
|--|-------------|
| <b>IMPORTANT INFORMATION</b> .....                 | <b>X</b>    |
| <b>COMPLIANCE</b> .....                            | <b>XI</b>   |
| STATE OF CALIFORNIA PROPOSITION 65 .....           | <b>XI</b>   |
| <b>CRITICAL EMISSION-RELATED MAINTENANCE</b> ..... | <b>XII</b>  |
| <b>DATA LOGGING</b> .....                          | <b>XIII</b> |
| EVENT DATA RECORDING DEVICES .....                 | <b>XIII</b> |
| ELECTRONIC LOGGING DEVICE (ELD) .....              | <b>XIV</b>  |
| TELEMATICS DEVICE .....                            | <b>XV</b>   |
| <b>OWNERSHIP OR ADDRESS HAS CHANGED</b> .....      | <b>XV</b>   |
| <b>QUESTIONS AND COMPLAINTS</b> .....              | <b>XV</b>   |
| <b>REPORTING SAFETY DEFECTS</b> .....              | <b>XVI</b>  |
| UNITED STATES .....                                | <b>XVI</b>  |
| CANADA .....                                       | <b>XVI</b>  |

## IMPORTANT INFORMATION

This manual has been prepared to thoroughly acquaint the driver and service technicians with the equipment and features in order to fully appreciate and safely enjoy this vehicle.

Prevost is committed to the continuous improvement of quality, reliability, durability and safety. With innovative features, the vehicle was designed with passengers, driver safety and comfort in mind.

This manual contains information available at the time of publication. Standard and optional equipment are covered in this manual. Therefore, some of the optional equipment described may not apply to your vehicle. In doubt, refer to the technical documentation package provided.

Driver controls and instruments incorporate advanced technology for enhanced driving ease and security. This manual describes the main features, instruments, controls, and servicing requirements for standard and optional equipment.

Read this manual carefully to take advantage of the advanced features and to ensure optimum safety and passenger comfort.

Keep the manual in the vehicle at all times. Make sure it is kept with the vehicle when ownership is transferred. Please notify the [Prevost Warranty Support Team](#) of any change of address or transfer of ownership. This will ensure fast and reliable service to all operators.

### NOTE

*Illustrations in this manual are used for reference only and may differ from the actual vehicle; however, key components addressed in the manual are represented as accurately as possible.*

Danger, Warning, Caution and Note are used throughout this manual to emphasize important points when necessary:



### DANGER

Directs the operator's attention to unsafe practices which could result in serious personal injury or death.



### WARNING

Directs the operator's attention to unsafe practices which could result in serious personal injury or severe damage to the vehicle.



### CAUTION

Directs the operator's attention to unsafe practices where personal injury is not likely but damage to vehicle components could occur.

### NOTE

*Indicates supplementary information essential to the proper operation of the vehicle.*


The service life of the vehicle depends on the kind of attention it receives. Pay close attention to the warnings, cautions and notes. Read the various notices and instructions posted throughout the vehicle and attached to equipment.

Continuous improvement is a primary focus at Prevost, we reserve the right to make changes anytime, without notice, and without incurring any obligation.

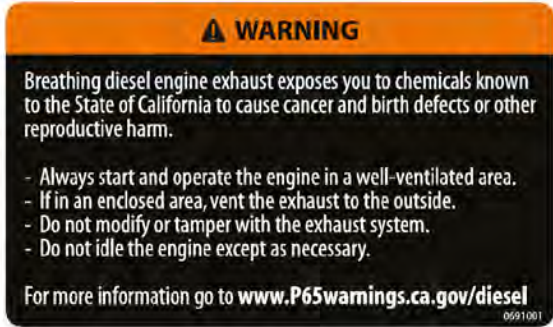


Before reproducing or copying this manual, in whole or in part, written consent must be obtained from Prevost.

## COMPLIANCE

### STATE OF CALIFORNIA PROPOSITION 65

|  <b>WARNING</b>  |
|---|
| <p>Breathing diesel engine exhaust exposes you to chemicals known to the State of California to cause cancer and birth defects or other reproductive harm.</p> <ul style="list-style-type: none"> <li>- Always start and operate the engine in a well-ventilated area.</li> <li>- If in an enclosed area, vent the exhaust to the outside.</li> <li>- Do not modify or tamper with the exhaust system.</li> <li>- Do not idle the engine except as necessary.</li> </ul> <p>For more information go to <a href="http://www.P65warnings.ca.gov/diesel">www.P65warnings.ca.gov/diesel</a></p> |

#### Proposition 65 Warning Decal on Diesel Engine Exhaust Health Hazard

|  |   |
|--|---|
| <p style="text-align: right;">18755-1</p>  <p>DECAL #0691001</p> <p>This warning decal is available through Prevost Parts.</p> | <div style="display: flex; justify-content: space-around;"> <div style="text-align: center;"> <p><b>H3 SERIES</b></p>  </div> <div style="text-align: center;"> <p><b>X3 SERIES</b></p>  </div> </div> <p style="text-align: right;">18755</p> <p>Best location where to affix the decal on the vehicle.</p> |
|--|---|

## CRITICAL EMISSION-RELATED MAINTENANCE

### Source of parts and repair:

A repair shop or person of the owner's choosing must maintain, replace, or repair emission control devices and systems per manufacturer's recommendations.

### Replacement of tires that are GHG certified:

The original equipment tires installed on this vehicle at the factory were certified to the U.S. EPA Greenhouse Gas (GHG) and National Highway Traffic Safety Administration (NHTSA) Fuel Efficiency regulations. Replacement of these tires should be with a tire of equal or lower rolling resistance levels (TRRL or Crr). Please consult your tire supplier(s) for appropriate replacement tires.

### Maintaining a GHG certified tire:

In order to maintain the certified rolling resistance of the tires which optimize fuel economy, the maintenance procedures provide by the tire manufacturer must be followed.



## DATA LOGGING

### EVENT DATA RECORDING DEVICES

This PREVOST vehicle is equipped with a device generally referred to as an "event data recorder" or "EDR." Please note that while the term "event data recorder" is typically used throughout the motor vehicle industry, not every EDR is the same; i.e., they do not all record the same data elements.

The EDR on this PREVOST vehicle records vehicle speed, engine RPM, time and date, plus a variety of pedal and switch positions, both before and after an "event." Sudden vehicle deceleration or the occurrence of certain other vehicle operational characteristics will define (trigger) an "event."

For any questions about this vehicle EDR device, contact a PREVOST Service Center or a regional service manager.

## 4-xiv Foreword

---

### ELECTRONIC LOGGING DEVICE (ELD)

This vehicle is equipped with a dedicated ELD interface connector located under the lower left part of the dashboard. This SAE J1939 9 PIN connector is compatible with most FMCSA approved ELD and will ensure that the ELD will not interfere with the vehicle communication, diagnostic and/or driving systems.

Please take note that **the OBD connector is only intended as a diagnostic equipment connection.** Installing an aftermarket plug-in device that uses the OBD port may cause interference and/or damage to the vehicle systems, potentially affecting safe operation.

Both connectors (OBD and ELD) are clearly identified under the dash by stickers. **The OBD port must remain unconnected at all times except during vehicle maintenance (using Prevost approved diagnostic equipment only).**

Connecting aftermarket equipment to the OBD connector may lead to:

- Incorrect emission monitoring and failure to meet the requirements of emission tests.
- Erratic behavior of one or more of the vehicle safety devices/driving aids, increasing the risk of accidents.
- False code readings and inconsistency during vehicle diagnostic procedures, increasing the vehicle down time.
- Unreliable ELD connection/recording and potential violations with the federal ELD regulations\*.

\* For more information regarding Federal ELD requirements, consult the [FMSCA](#)

## TELEMATICS DEVICE

Your vehicle is equipped with one or more recording devices (“Telematics Device”), associated with Prevo’s Connected Vehicle Services (the “Telematics Services”). These services, which are described in greater detail at [www.prevocar.com](http://www.prevocar.com) (the “Website”), allow you to manage vehicle maintenance and repair in a cost-effective manner by providing: proactive diagnostic and repair planning assistance with detailed analysis of diagnostic trouble codes; streamlined service procedures with parts-on-hand confirmation before a vehicle arrives for service; and live repair and customer communication. The service eliminates or reduces diagnostic time, enhances repair efficiency, expedites the decision process, improves communications and maximizes uptime. To access the Telematics Services, you must enter into a Telematics Subscription Agreement with Prevo, via the sales agreement pertaining to your vehicle.

The Telematics Device collects stores and/or transmits information about your vehicle. Such information may include direction and rate of speed, fuel consumption, engine performance, gearing, rpm, altitude, geo-location (including a history of where the vehicle travels), safety information related to the use and operation of the vehicle, vehicle performance, diagnostic data and error codes. The Telematics Device has the capacity to store historical data about the use and performance of your vehicle. The Telematics Device has the ability to transmit information to a central communications system. The information contained in your Telematics Device may be periodically transmitted to or accessed by Prevo and others authorized by Prevo, along with your vehicle’s VIN or other identifying information. Prevo does not collect any driver information. Prevo retains and uses this information to understand the operational use of your vehicle, to remotely tune your vehicle, and to help facilitate maintenance and vehicle improvements. To the extent allowed by law, Prevo reserves the right to access, use and control this information.

**Declining to enter into a Telematics Subscription Agreement with Prevo, or canceling a Telematics Subscription Agreement, will not end the transmission of data from your Telematics Device or the collection of information by Prevo. Prevo may access Telematics Data, to the extent it is available, and use it in connection with providing services and vehicle improvements to you and your vehicle. Prevo will regularly purge from its systems all data collected from your Telematics Device, at time intervals determined by Prevo at its sole discretion.**

## OWNERSHIP OR ADDRESS HAS CHANGED

If your address has changed or you are the new owner, please help us update our records. Use the link below to access the Prevo Warranty Support web page.

<http://www.prevocar.com/parts-and-services/warranty>

Click on the link ‘Prevo Change Ownership’, fill the form, save it and email the file at [prevost.warranty@volvo.com](mailto:prevost.warranty@volvo.com).

## QUESTIONS AND COMPLAINTS

Your satisfaction is our most important concern. If questions or complaints arise, first discuss the matter with the service manager at the Prevo facility involved. If you are not satisfied with the service manager’s response, contact the branch manager. If, for any reason, you need further assistance after dealing with the personnel at a Prevo facility, contact your regional service manager. The regional service manager has the responsibility and the authority to recommend action in most cases and (with the aid of relevant district service personnel) will make every effort to conduct a fair review of the situation.

# REPORTING SAFETY DEFECTS

## UNITED STATES

If you believe that your vehicle has a defect which could cause a crash, injury or death, you should immediately inform the National Highway Traffic Safety Administration (NHTSA), in addition to notifying Prevest.

If NHTSA receives similar complaints, it may open an investigation and if it finds that a safety defect exists in a group of vehicles, it may order a recall and remedy campaign. However, NHTSA cannot become involved in individual problems between you, your Prevest Service Center, or Prevest.

To contact NHTSA, either call the U.S. Government's Vehicle Safety Hotline toll-free at 1-888-327-4236 (TTY: 1-800-424-9153); go to <http://www.NHTSA.gov>; or write to: Administrator, National Highway Traffic Safety Administration, 400 Seventh Street, S.W., Washington, DC 20590. You can also obtain other information about motor vehicle safety from the Vehicle Safety Hotline.

## CANADA

Canadian customers who wish to report a safety-related defect to Transport Canada — Defect Investigations and Recalls, may telephone the toll free hotline at 1-800-333-0510, or contact Transport Canada by mail at Transport Canada, ASFAD, Place de Ville Tower C, 330 Sparks Street, Ottawa ON K1A 0N5. For additional road safety information, please visit the Road Safety website at <http://www.tc.gc.ca/roadsafety/menu.htm>.

**SECTION 1 - SAFETY PRECAUTIONS**

**SAFE OPERATING PRACTICES** ..... 2  
**DEFENSIVE DRIVING PRACTICES** ..... 3  
**OTHER PRECAUTIONS** ..... 3

## 1-2 Safety Precautions

---

### SAFE OPERATING PRACTICES

To ensure safe and reliable operation, heed the following safety precautions.

- Operation and maintenance of the vehicle must be performed only by qualified personnel.
- Before driving, conduct a walk around inspection and check that all baggage compartment doors and equipment access doors are securely shut.
- Make sure good visibility is maintained at all times. Keep windshields clean and free of obstructions.
- Adjust the driver's seat so that all controls can be reached easily.
- Always wear your safety belt when driving.
- Check the instrument panel frequently. Do not operate the vehicle when dials or indicators do not indicate normal operating conditions.
- Always pay attention to pedestrians passing in front and behind the vehicle. Always yield to pedestrians at pedestrian walkways.
- Do not drive over obstacles on the road. Empty boxes, piles of leaves, and snowdrifts could conceal hidden dangers that could damage the vehicle suspension and underbody.
- When turning or changing lanes, signal your intention well in advance.
- When approaching to make a right turn, reduce the space between the vehicle and the curb to make sure another vehicle cannot pass on the right. Since the vehicle makes wide turns, allow enough space to make safe turns.
- Switch from high beams to low beams when meeting or following other vehicles within 500 feet (150 meters).
- Never leave the vehicle unattended with the engine running or with the key in the ignition. Turn off the engine, remove keys and apply the parking brake before leaving the vehicle.
- Shut-off the engine before refueling, adding oil, performing maintenance or servicing tasks, unless stated otherwise.
- Fuel is highly flammable and explosive. Do not smoke when refueling. Keep away from open flames or sparks.
- Do not run the engine or HVAC system with access doors left open. Close compartment doors before operating any equipment.
- Do not remove the surge tank filler cap or the cooling system pressure cap when the engine is hot. Let the engine cool down before removing filler caps.
- Do not attempt to push or pull-start the vehicle.
- The service life of the vehicle depends on the kind of maintenance it receives. Always record any problems and report them immediately to maintenance personnel.
- After each trip, perform a system diagnostic to check if error codes and anomalies were recorded in the vehicle electronic modules.
- Do not use the trailer hitch before reading the safety, technical and operational requirements..
- Do not use the trailer hitch before reading the safety, technical and operational requirements on page 14 of this manual.

## DEFENSIVE DRIVING PRACTICES

- For city driving, allow a four to six second travel interval between your vehicle and the vehicle ahead. Increase this travel interval to six to eight seconds for highway driving. Increase time interval for driving at night or in foul weather.
- Be prepared to stop when approaching an intersection. The stopping distance of the vehicle increases with the weight and speed.
- Establish eye-to-eye contact with other drivers and with pedestrians. Use, high beam and low beam headlights, turn signals and horn as needed.
- On highway, don't stare at the road ahead. Keep your eyes moving. Check mirrors and dashboard instruments frequently.
- To keep the vehicle from drifting across lanes during highway driving, always look over the horizon on the road ahead.
- Adjust your speed to road conditions, traffic and visibility. Never exceed the posted speed limits.
- If another vehicle is following close behind, reduce your speed to let the vehicle pass.
- For additional information about safe operation and defensive driving practices, contact the local department of motor vehicles authority.

## OTHER PRECAUTIONS



### WARNING

This vehicle is not designed to carry standing passengers.



### WARNING

#### CALIFORNIA PROPOSITION 65

Diesel engine exhaust and some of its constituents are known to the State of California to cause cancer, birth defects and other reproductive harm.

Battery posts, terminals and other related accessories contain lead and lead compounds, chemical known to the State of California to cause cancer and other reproductive harm.

Batteries also contain other chemicals known to the State of California to cause cancer.

Wash hands after handling.



### DANGER

Make sure that electrical current or air pressure is removed before performing any work. A part may be energized even if the ignition switch is OFF. A part may be under pressure even if all tanks are empty. Before performing any work on the vehicle, refer to wiring diagrams and/or air schematics to thoroughly understand the system.

### NOTE

*When the ignition switch is set to the OFF position, the electrical components are not energized except for the MCM (Master Chassis Module), the battery equalizer, the preheater system and some electronic modules; which are energized during 15 minutes after the ignition has been set to the OFF position. Prior to working on one of these electrical components, set the main electrical shut-off switch to the OFF position. If the vehicle will not be operated for a long period (more than 2 weeks), it is recommended, in order to prevent the batteries from discharging, to trip the main circuit breakers located in the main power compartment to stop the small current drawn by the radio preset station memory, the MCM memory and the instrument cluster clock. Note that the radio station presets will be erased, same thing for the diagnostic codes history and the instrument cluster clock will have to be reset.*

## 1-4 Safety Precautions

---



### CAUTION

PRECAUTIONS ARE TO BE OBSERVED BEFORE WELDING TO MINIMIZE THE RISK OF MAJOR AND COSTLY DAMAGES CAUSED TO THE VEHICLE ELECTRONIC COMPONENTS!

1. Set the main electrical shut-off switch to "OFF" position.
2. Trip circuit breaker CB2 and CB6.
3. Disconnect electronic ground terminal from the ground junction block located in the battery compartment.
4. Make sure to clamp the welding ground return as close as possible to the welding point and make a good electric contact to the chassis.

Detailed instructions are provided in section 00-GENERAL of your vehicle maintenance manual.



## SECTION 2 - COACH EXTERIOR

|   |    |
|---|----|
| EXTERIOR VIEW .....                                   | 2  |
| ENGINE COMPARTMENT COMPONENTS .....                   | 4  |
| ENGINE COMPARTMENT REAR DOOR .....                    | 6  |
| EXHAUST AFTERTREATMENT SYSTEM ACCESS DOOR .....       | 7  |
| BACK-UP CAMERA .....                                  | 7  |
| ENGINE COMPARTMENT CURBSIDE DOOR .....                | 8  |
| 120-VOLT CONNECTORS .....                             | 8  |
| ENGINE BLOCK HEATER .....                             | 8  |
| BATTERY CHARGER .....                                 | 8  |
| MAIN POWER COMPARTMENT .....                          | 9  |
| WHEELCHAIR LIFT ACCESS DOORS .....                    | 10 |
| FUEL AND DIESEL EXHAUST FLUID (DEF) FILLER DOOR ..... | 10 |
| CONDENSER COMPARTMENT (A/C) .....                     | 11 |
| BAGGAGE COMPARTMENTS .....                            | 13 |
| ENTRANCE DOOR .....                                   | 14 |
| LOCK OPERATION .....                                  | 14 |
| OPENING THE ENTRANCE DOOR FROM OUTSIDE .....          | 14 |
| OPENING THE ENTRANCE DOOR FROM INSIDE .....           | 14 |
| DOOR OPERATION LOGIC .....                            | 14 |
| EMERGENCY DOOR OPENING .....                          | 15 |
| SPARE WHEEL COMPARTMENT .....                         | 15 |
| FRONT ELECTRICAL AND SERVICE COMPARTMENT .....        | 16 |
| REAR-VIEW MIRRORS .....                               | 17 |
| SIDE CAMERA REAR-VIEW SYSTEM .....                    | 17 |
| EVAPORATOR COMPARTMENT .....                          | 17 |
| REAR FENDERS .....                                    | 18 |
| COOLANT PREHEATER .....                               | 18 |
| HUBODOMETER .....                                     | 18 |
| ENGINE RADIATOR DOOR .....                            | 19 |
| SCR CONVERTER ACCESS HATCH .....                      | 20 |
| TRAILER HITCH .....                                   | 20 |
| TRAILER HITCH LIMITATIONS .....                       | 21 |

## 2-2 Coach Exterior

### EXTERIOR VIEW

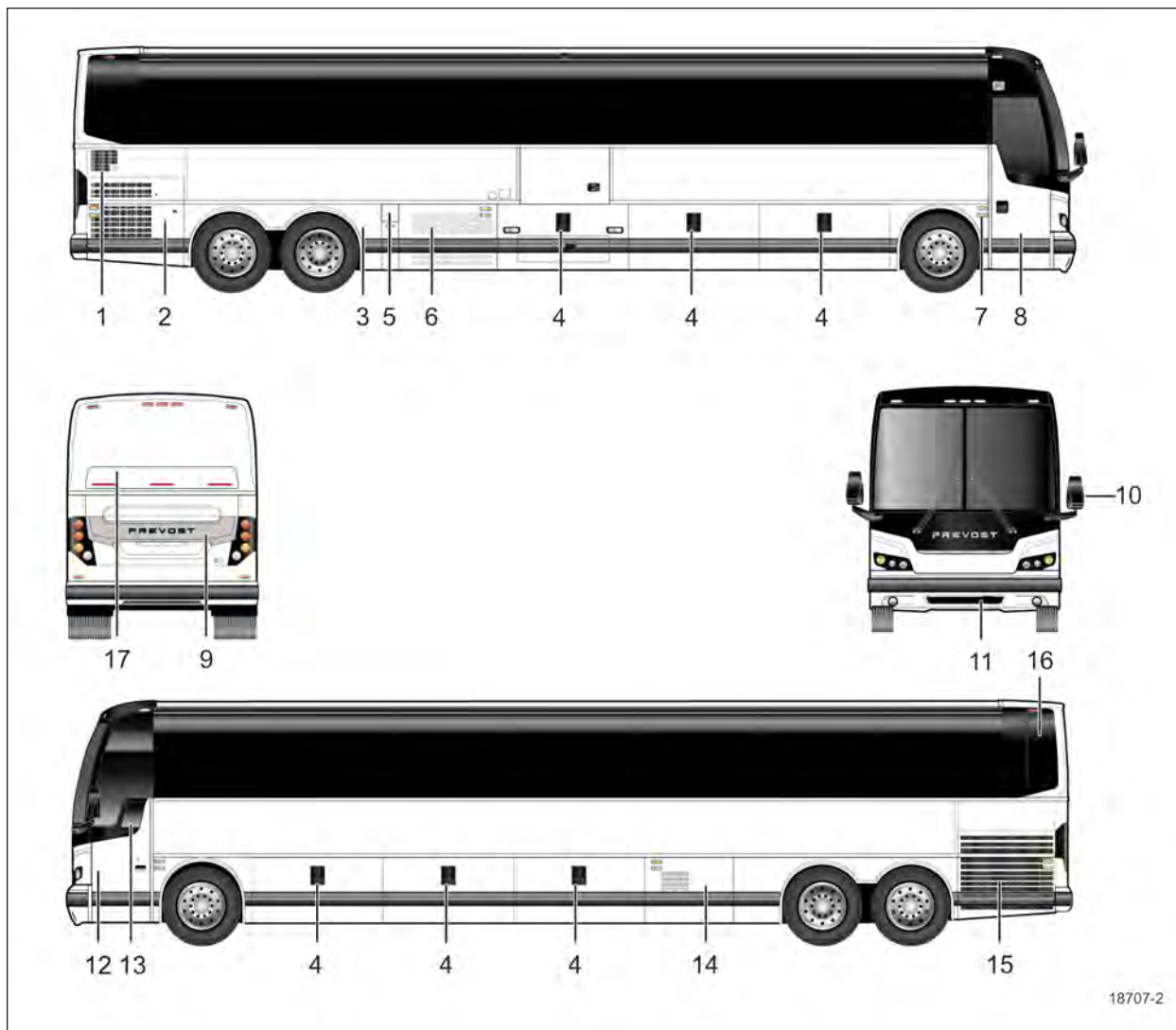


FIGURE 1: X3-45 EXTERIOR VIEW (TYPICAL)

1. Engine air filter intake grill
2. Engine compartment curbside door
3. Hinged rear fender
4. Baggage compartment
5. Fuel filler neck & DEF filler neck door
6. Condenser compartment
7. Entrance door control switch
8. Entrance door
9. Engine compartment rear door
10. Rear-view mirrors
11. Spare wheel compartment
12. Front electrical and service compartment
13. Driver's power window
14. Evaporator compartment and coolant heater compartment
15. Radiator door
16. SCR converter access door
17. Exhaust aftertreatment system access door

## ENGINE COMPARTMENT COMPONENTS

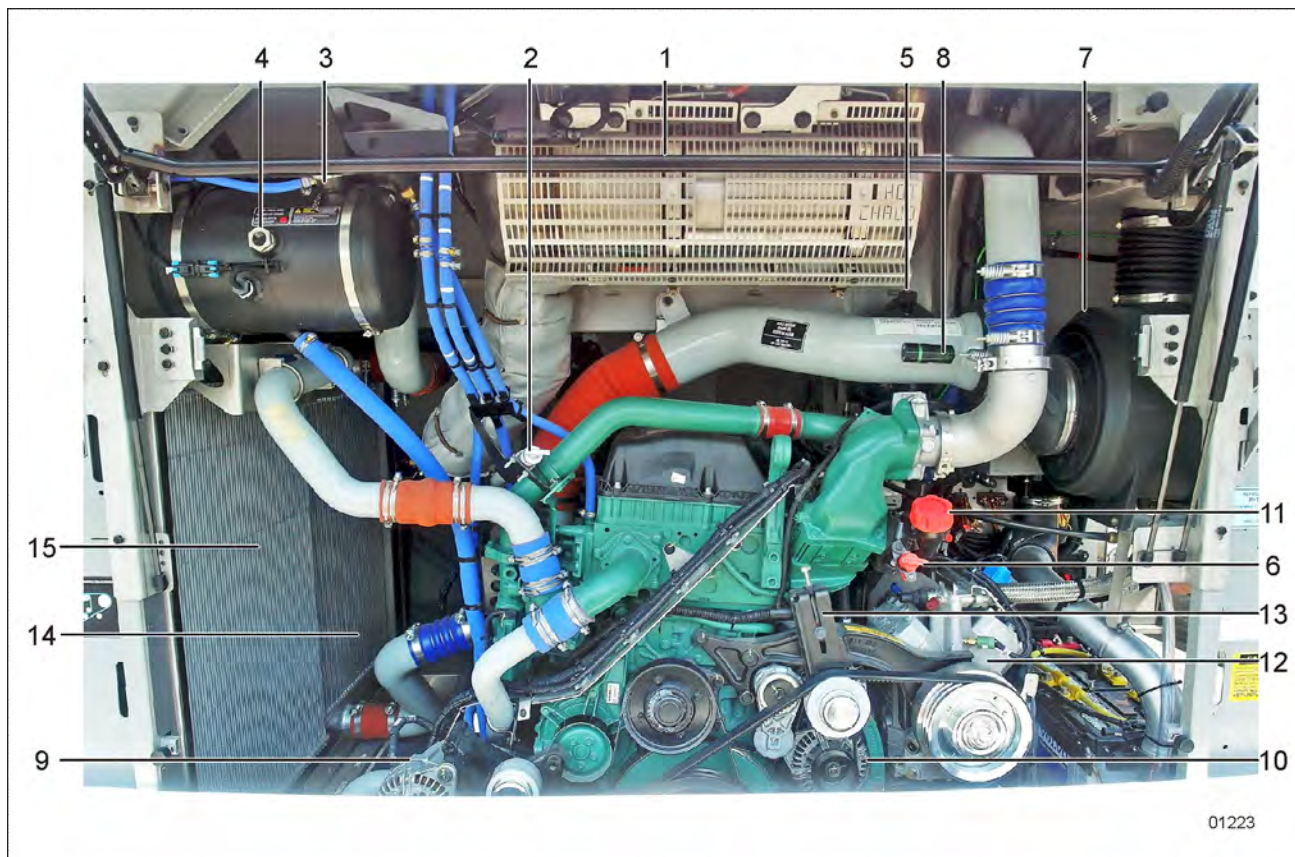


FIGURE 2: ENGINE COMPARTMENT FEATURING VOLVO D13 ENGINE

1. Diesel Oxidation Catalyst (DOC) & Diesel Particulate Filter (DPF) Assembly;
2. Transmission fluid dipstick (if equipped with Allison transmission);
3. Coolant fluid surge tank filler cap;
4. Coolant fluid surge tank sight glass;
5. Power steering fluid reservoir;
6. Engine oil dipstick;
7. Air filter;
8. Air filter restriction indicator;
9. Alternators, Road side
10. Alternator, Curb side;
11. Engine oil filler tube;
12. Central A/C compressor;
13. Compressor belt tensioner;
14. Charge air cooler;
15. Radiator;

## 2-6 Coach Exterior

### ENGINE COMPARTMENT REAR DOOR

To open the engine compartment rear door, open the engine compartment curb side door and pull the yellow lever located on the rear door, grab the side of the door in the middle, pull and lift the door.

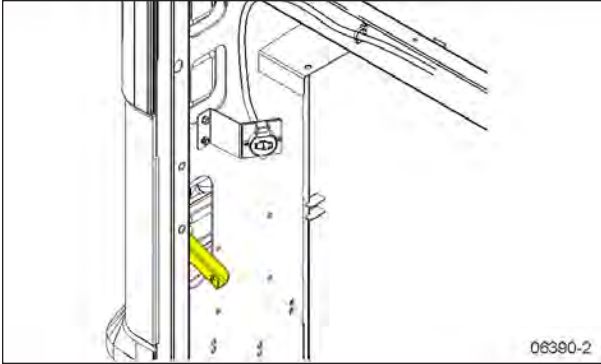


FIGURE 3: ENGINE COMPARTMENT DOOR RELEASE LEVER



#### WARNING

Unless otherwise stated, do not run the engine when the engine compartment is open.

The door swings out to provide access to the following:

- Engine;
- Alternators;
- A/C compressor;
- A/C belt tensioner (refer to "[CENTRAL A/C COMPRESSOR BELTS](#)" on page 13 in Care and Maintenance);
- Engine starting selector (refer to "[STARTING FROM THE ENGINE COMPARTMENT](#)" on page 5 in Starting and Stopping Procedures);
- Coolant line shutoff valves;
- Engine certification plates;
- Engine coolant surge tank and filler cap;
- Air filter restriction indicator;
- Engine oil dipstick and filler tube;
- Power steering fluid reserve tank;
- Allison automatic transmission fluid dipstick;

#### NOTE

*The engine compartment lights will turn on automatically when the engine door is opened*

A catch engages to maintain the door in the full open position. To close the door, slightly lift up the door and release the catch before firmly shutting down the door.



FIGURE 4: REAR DOOR SAFETY CATCH



**WARNING**

Unless otherwise specified, do not run the engine when the engine compartment rear door is open. Close the engine compartment rear door before starting the engine.

**EXHAUST AFTERTREATMENT SYSTEM ACCESS DOOR**

The engine door must be open before opening the exhaust aftertreatment system access door. To open the access door, pull down the latch release knob.

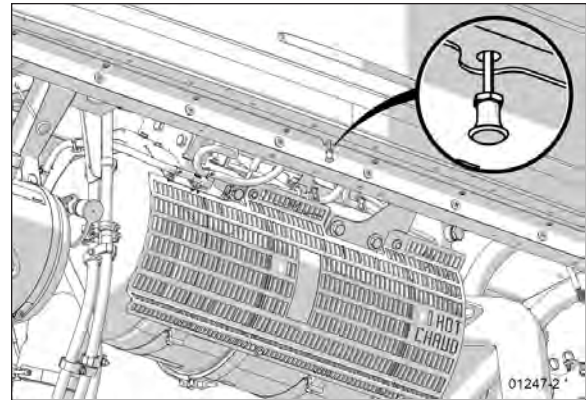


FIGURE 5: AFTERTREATMENT ACCESS DOOR LATCH

To close the door, lower the door and push against the release lever spring to latch the door shut.

**BACK-UP CAMERA**

An optional back-up camera is available which provides the driver with visual assistance when backing-up. The back-up camera is mounted in a housing with a retractable cover. For additional information, refer to Controls and Instruments and Care and maintenance chapters.

## 2-8 Coach Exterior

### ENGINE COMPARTMENT CURBSIDE DOOR

This door can be locked using the exterior compartment key. To open, pull towards the front on the rod located in the recess to the right of the door.

The engine compartment curbside door provides access to the following equipment:

- Engine compartment rear door release lever;
- Booster block terminals;
- Main power compartment (a.k.a. rear junction box);
- Battery bank;
- Fuel Pro filter/water separator (optional);
- Emergency air fill valve;
- Sump tank access cap;
- Battery charger 120 volt connector located on the access door;
- Engine block heater 120 volt connector (optional);
- Lavatory maintenance valve and connectors;
- Fresh water reservoir fill connector;

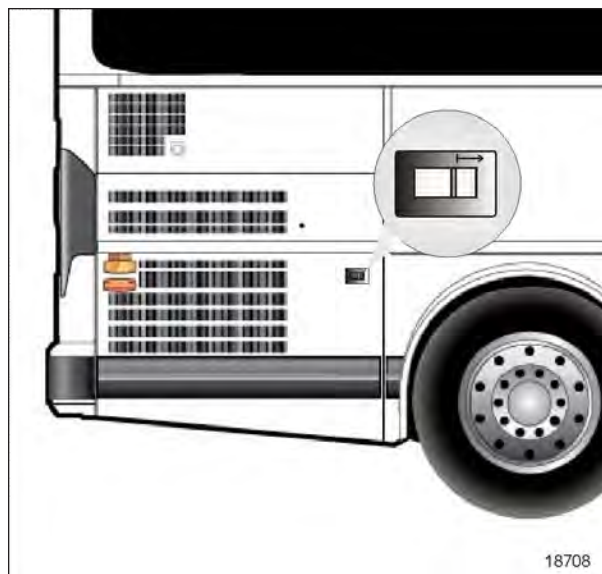


FIGURE 6: ENGINE COMPARTMENT CURBSIDE DOOR

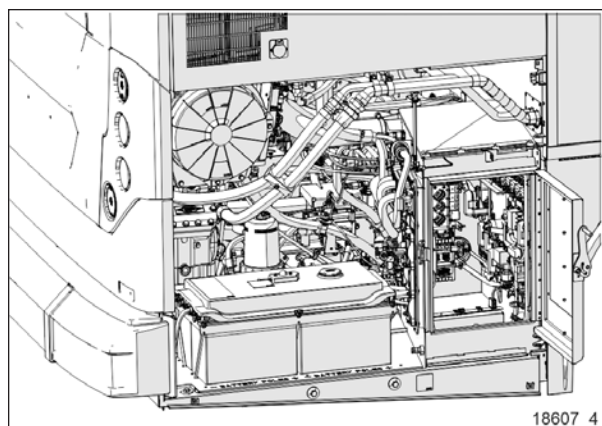


FIGURE 7: ENGINE COMPARTMENT CURBSIDE

### 120-VOLT CONNECTORS

#### ENGINE BLOCK HEATER

This connector is used with a 120 volts supply and is connected to the optional engine block heater. Refer to Starting and Stopping Procedures chapter.

#### BATTERY CHARGER

Another connector is used to connect the battery charger to a 120-VAC power source.



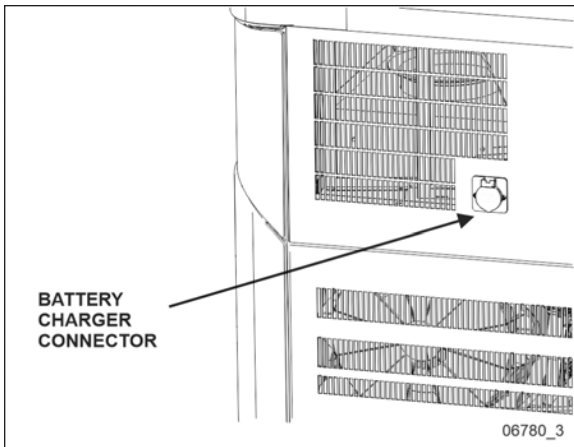
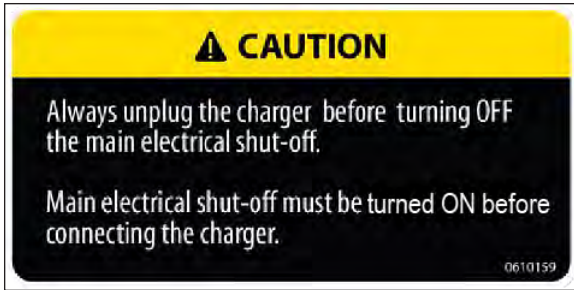


FIGURE 8: BATTERY CHARGER 120-VOLT CONNECTOR

## MAIN POWER COMPARTMENT

The main power compartment (a.k.a. rear junction box) and battery installation are accessible from the engine compartment curbside door.

The batteries are housed and secured on the engine R.H. side deck. The battery posts and connections are protected by a watertight cover. The cover is fitted with a built-in vent. The cover can be unlocked and then removed with the use of the same type of hardware that allows opening and closing of the rear fender.

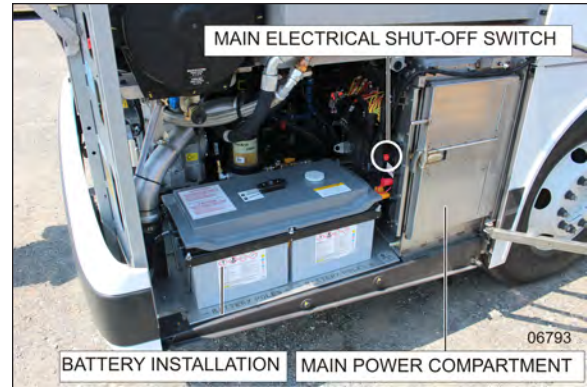


FIGURE 9: ENGINE R.H. SIDE COMPARTMENT (TYPICAL)

The main power compartment panel provides access to the following:

- Rear 12VD, 24VD junction blocks;
- Main circuit breakers;
- AE49, AE50, AE51, AE52 I/O-EB Multiplex modules;
- Vehicle Electrical Center Rear (VECR);
- Master relay R1;
- 12V ignition relay R3;
- Starter relay;
- Relays and fuses;
- Battery equalizer;
- 12VD & 24 VD current sensors.

## 2-10 Coach Exterior



FIGURE 10: MAIN POWER COMPARTMENT (TYPICAL)

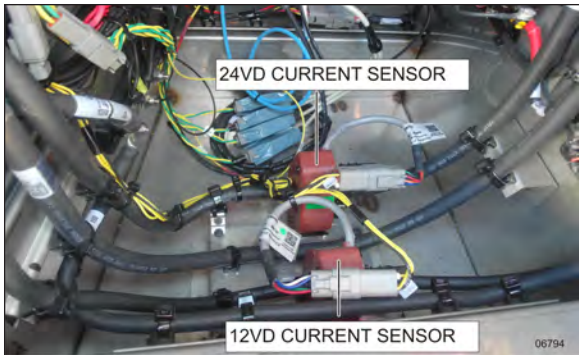


FIGURE 11: 12VD / 24VD CURRENT SENSORS IN MPC (TYPICAL)

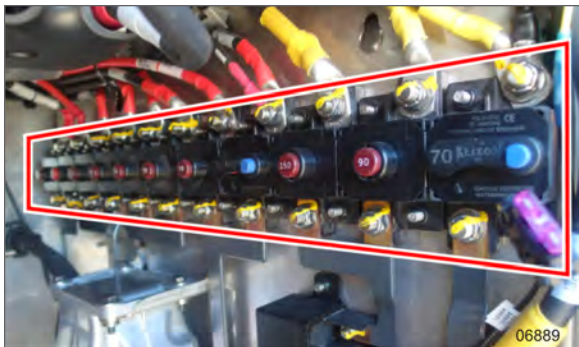


FIGURE 12: MAIN CIRCUIT BREAKERS IN MPC (TYPICAL)

## WHEELCHAIR LIFT ACCESS DOORS

To open the optional wheelchair lift access doors, the coach must be parked on a flat and level surface with the parking brake on. Using the exterior compartment doors key, unlock and carefully lower the lift mechanism access door which is part of the baggage compartment door. The lift mechanism access door is located directly below the wheelchair access door. A handle at the left of the lift mechanism unlocks and enables opening of the wheelchair access door.

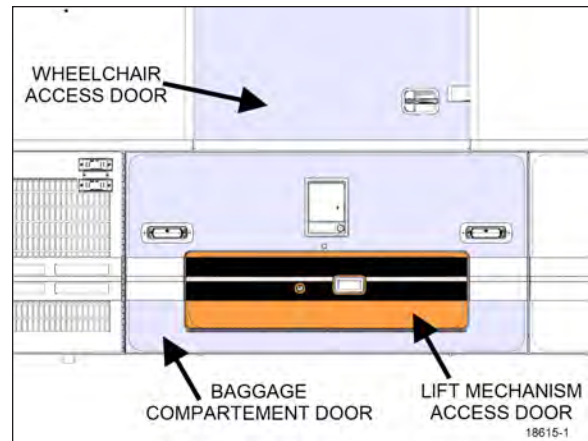


FIGURE 13: WHEELCHAIR LIFT ACCESS DOORS

## FUEL AND DIESEL EXHAUST FLUID (DEF) FILLER DOOR

The fuel and Diesel Exhaust Fluid (DEF) filler door is located on the R.H. side of the coach providing easy filling.

A spring keeps the door either open or shut. A key is provided for unlocking the door if the option was chosen.

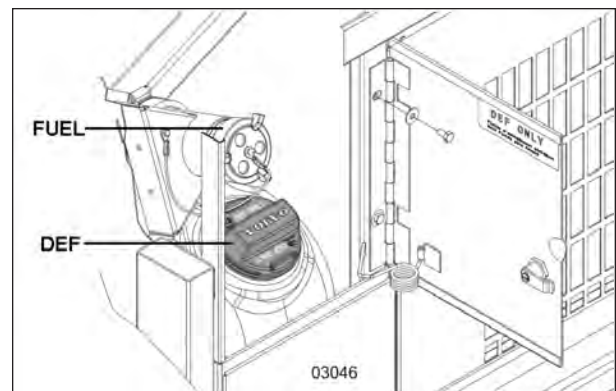


FIGURE 14: FUEL & DEF FILLER DOOR

**NOTE**

Provided the vehicle is parked on level ground, an automatic nozzle will automatically shut off when the fuel tank is approximately 95% full.

**NOTE**

The fuel & DEF filler door must be in the unlocked position before closing

**WARNING****DEF – Do not overfill**

If an automatic nozzle is used for filling diesel exhaust fluid (DEF), do not add further DEF after the nozzle has automatically shut off flow a first time.

If such nozzle is not available, use the DEF level gage on the instrument panel to control the quantity during filling.

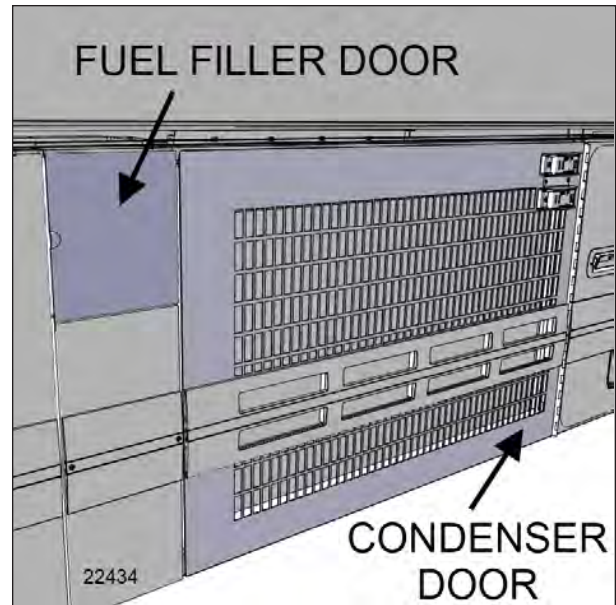
Diesel exhaust fluid DEF will begin to crystallize and freeze at 12°F (-11°C) and expand by 7% when frozen. To allow expansion without damaging the DEF tank, do not fill the tank with more than 16 gallons (60 liters).

**WARNING**

Do not fill to more than 95% of the fuel tank capacity. Do not "top off" the tank, doing so may result in fuel spillage when the fuel expands.

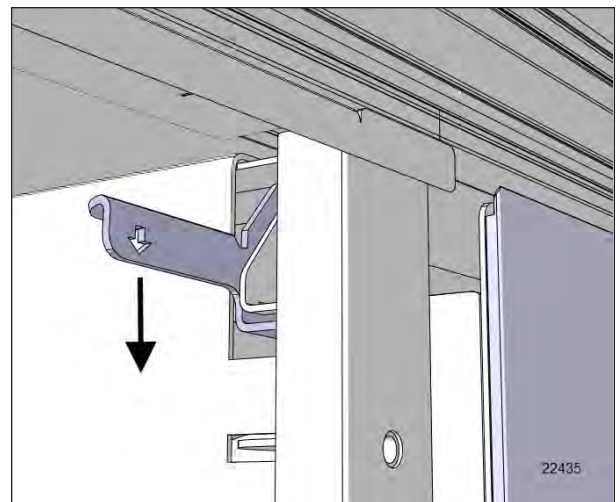
## CONDENSER COMPARTMENT (A/C)

To open the condenser door, open the fuel filler door and locate the door latch behind the door.



**FIGURE 15: CONDENSER COMPARTMENT DOOR (A/C)**

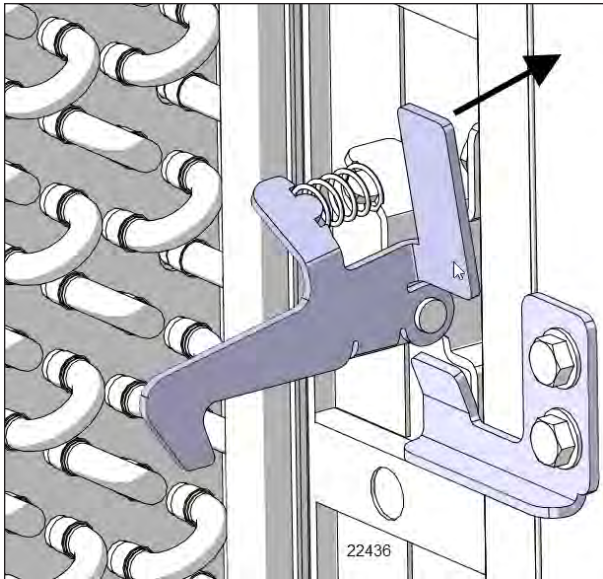
Push down the door latch (first lock).



**FIGURE 16: CONDENSER COMPARTMENT DOOR LATCH**

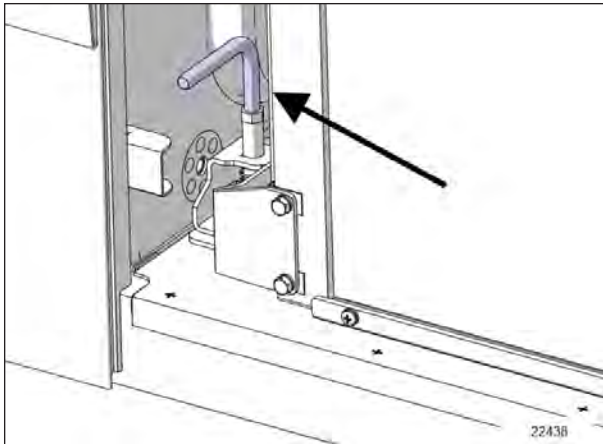
Open the door slightly to get access to the secondary latch (second lock) and push the handle.

## 2-12 Coach Exterior

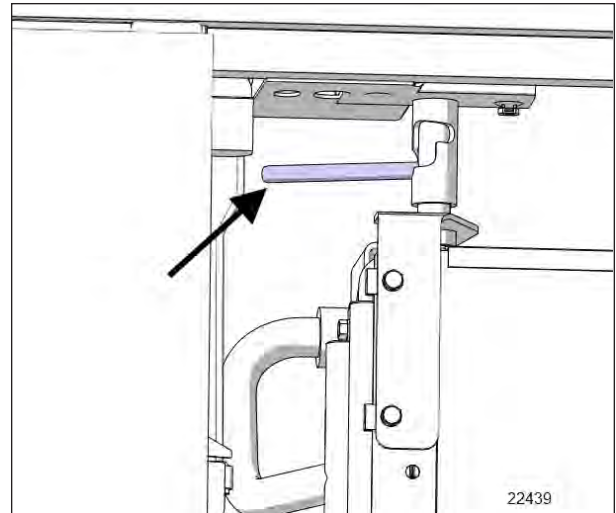


**FIGURE 17: SECONDARY LATCH**

Unlock both bottom and top condenser unit latches.

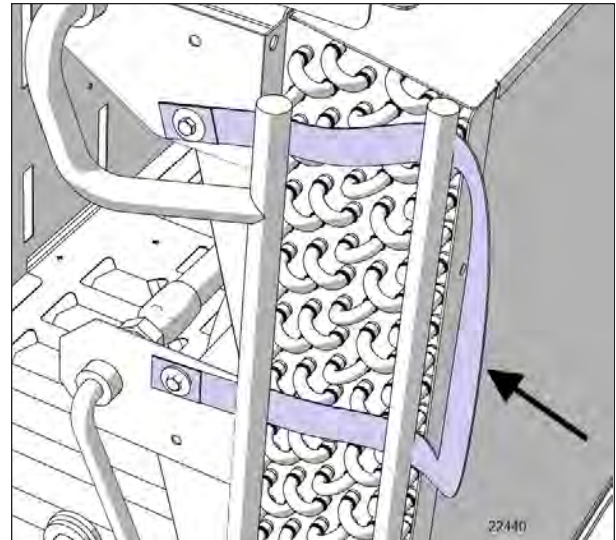


**FIGURE 18: BOTTOM CONDENSER UNIT LATCH**



**FIGURE 19: TOP CONDENSER UNIT LATCH**

Use the strap to pull out the condenser unit.



**FIGURE 20: CONDENSER CORE STRAP**



### **CAUTION**

Only the strap should be used to pull the condenser-fan assembly open. Damage to the condenser could result if pulling by other means

The condenser compartment is equipped with an automatic light and provides access to the following:

- Exhaust aftertreatment control module (EACM);
- Diesel Exhaust Fluid (DEF) Tank and DEF pump;
- Condenser;

- Condenser fans;
- Refrigerant filter- dryer and moisture indicator;
- Refrigerant receiver tank;

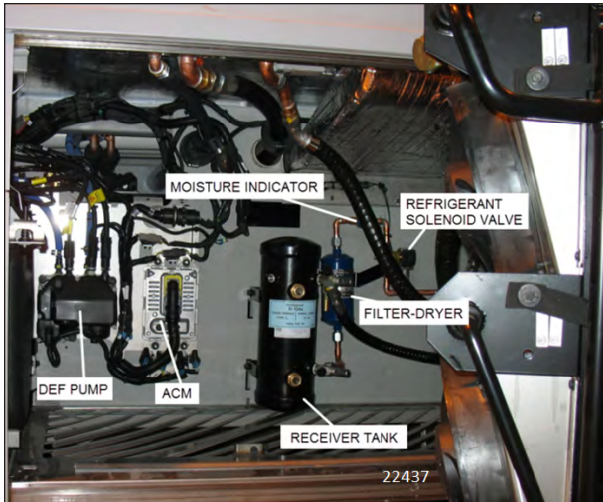


FIGURE 21: CONDENSER COMPARTMENT (A/C)

## BAGGAGE COMPARTMENTS

The baggage compartments of the X3-45 provide 406 ft<sup>3</sup> (11.5 m<sup>3</sup>) of storage capacity. The compartments can be locked or unlocked by using the exterior compartment key. Pull up operating handle to release the latch, and then pull the door open. Pressurized cylinders assist the opening and closing of the baggage compartment doors and hold the doors open.

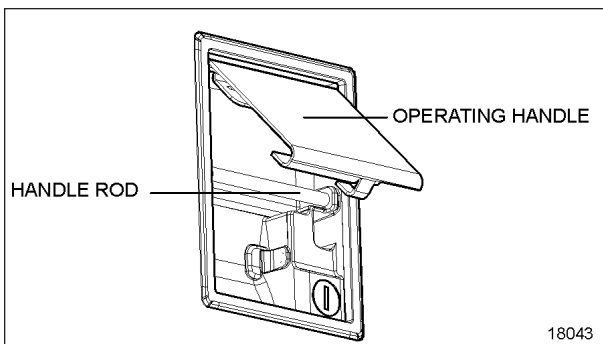


FIGURE 22: BAGGAGE DOOR LOCK AND LEVER

To close, pull the door down by the handle rod. Complete the closing of the door by returning the operating handle to its initial position.



### CAUTION

Do not slam shut the baggage compartment doors. Damage to the door weather-stripping or locking mechanism could result.

Lights in the baggage compartments turn on automatically when the door is opened.



FIGURE 23: BAGGAGE DOOR LOCK AND LEVER

### NOTE

The baggage compartment doors can be locked/unlocked from the driver's position by the optional central locking system. The switch is on the L.H. control panel. Refer to "Controls & Instruments" chapter.

### NOTE

For added safety, open the door until the catch assist in holding the door in the open position. Lift lever to release the door



### WARNING

To avoid injury, keep hands clear of baggage compartment door edge and door frame when closing.

### NOTE

To prevent theft and vandalism, always lock the baggage compartment doors before leaving the vehicle unattended.

## 2-14 Coach Exterior

### ENTRANCE DOOR

Entrance door operation from the inside or outside and in case of emergency.

#### LOCK OPERATION

Lock or unlock the entrance door from outside the vehicle by turning the key in the door lock (counterclockwise to lock, clockwise to unlock).

The only way to unlock the entrance door from the inside is by sliding its lock lever to the left.

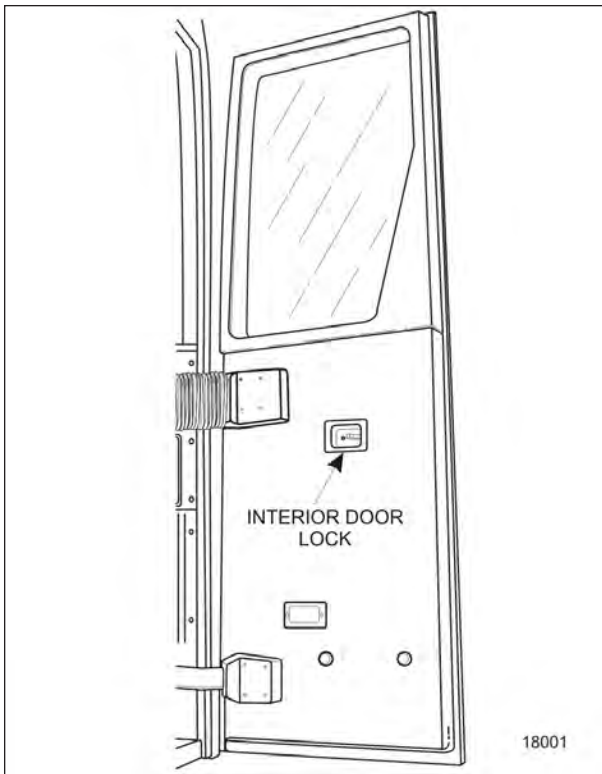


FIGURE 24: ENTRANCE DOOR – X3

#### OPENING THE ENTRANCE DOOR FROM OUTSIDE

The opening and closing of the door may be pneumatically controlled from the outside using the 3-position switch located on the door L.H. side. Open the door by pushing the switch forward, close by pushing the switch rearward.

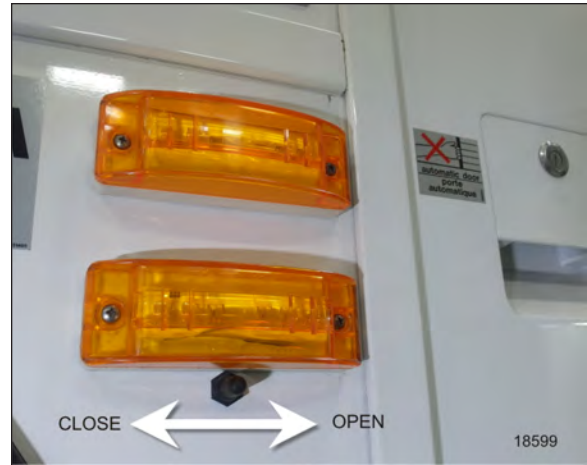


FIGURE 25: ENTRANCE DOOR EXTERIOR SWITCH

#### OPENING THE ENTRANCE DOOR FROM INSIDE

From the inside, open and close the door using the door operation buttons on the R.H. dashboard panel.

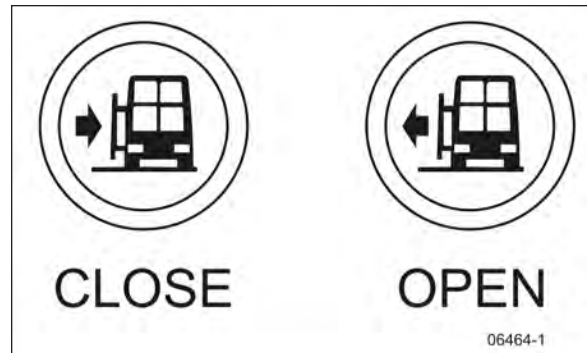


FIGURE 26: DASHBOARD SWITCHES

#### NOTE

*If the interior lever is used to exit the coach and the key is not used to unlock the door, it will lock again upon closing. Remember to keep the key with you upon exiting.*

#### DOOR OPERATION LOGIC

If the switch is held in position until the door is fully open or closed, the system holds pressure in the door cylinder, locking the door in that position. The door can be open to any position by releasing the exterior switch or inside door control buttons when the desired position is attained. However, the door is not locked in any position other than fully open or fully closed. The door can

then be open or closed further by pushing or pulling on the door.

When the door is almost shut, a mechanism will finish the closing of the door. This works even when the door is closed manually.

## EMERGENCY DOOR OPENING

Refer to "[EMERGENCY ENTRANCE DOOR OPENING](#)" on page 3 in Section 7, Safety Features and Equipment.

## SPARE WHEEL COMPARTMENT

The front bumper can be tilted downward to give access to the spare wheel.



### WARNING

The compartment behind the bumper is not designed for miscellaneous storage. Never store loose objects in this compartment since they can interfere with the steering linkage mechanism.

Pull the release handle located inside front service compartment to tilt down the entire bumper assembly.

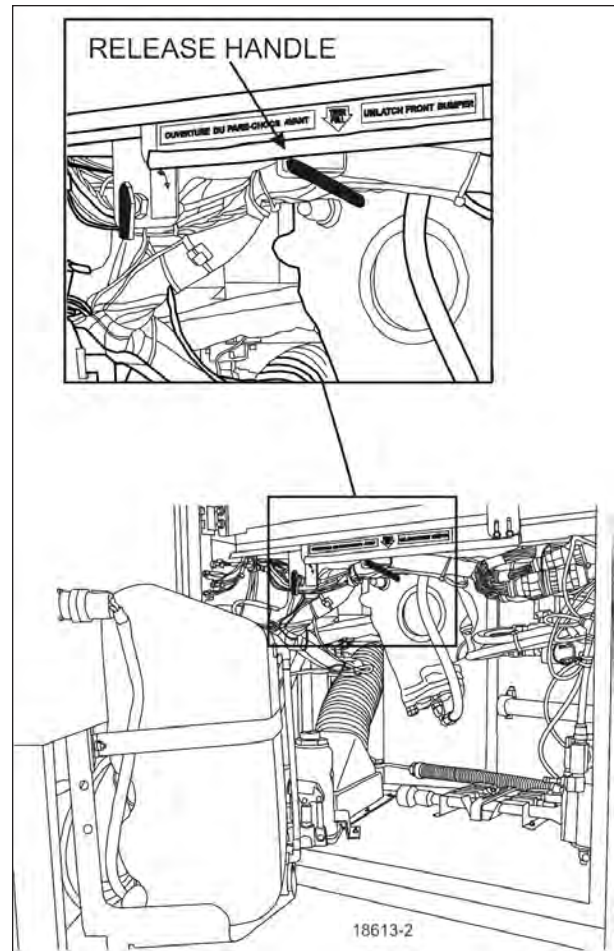


FIGURE 27: RELEASE HANDLE

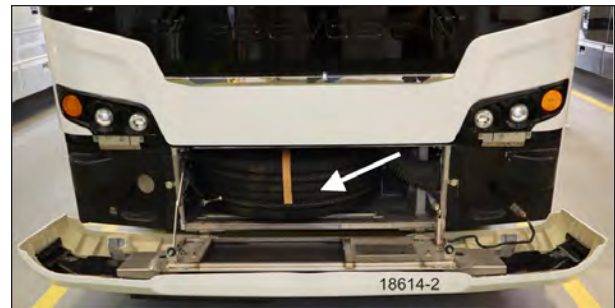


FIGURE 28: SPARE WHEEL IN FRONT BUMPER COMPARTMENT



### WARNING

Although a powerful spring assists in reclining the bumper, it remains heavy and rests low when open. Caution should be used when reclining.

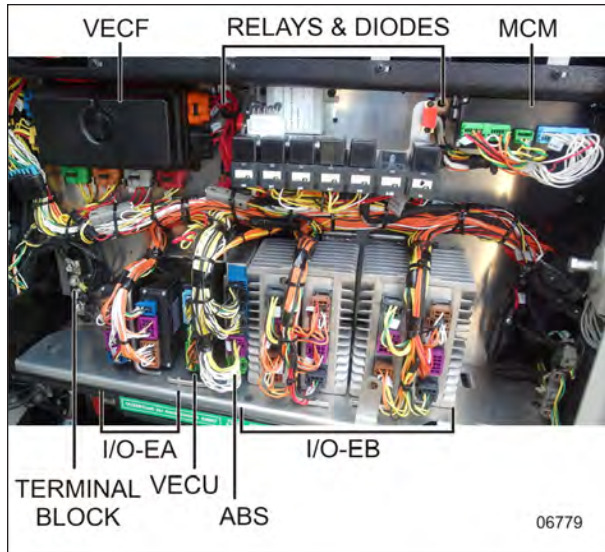
Check that bumper is securely closed shut before driving.

## 2-16 Coach Exterior

### FRONT ELECTRICAL AND SERVICE COMPARTMENT

To open the front electrical and service compartment door, pull the rod inside the vehicle, next to the driver's power window or use the exterior compartment key to open from outside the coach.

The light in the front electrical and service compartment turns on automatically when the door is opened.



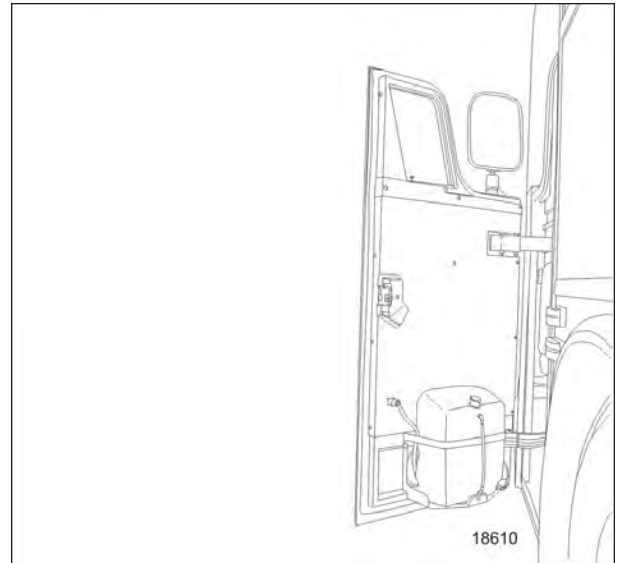
**FIGURE 29: FRONT ELECTRICAL COMPARTMENT**

The electrical section of the front compartment provides access to the following:

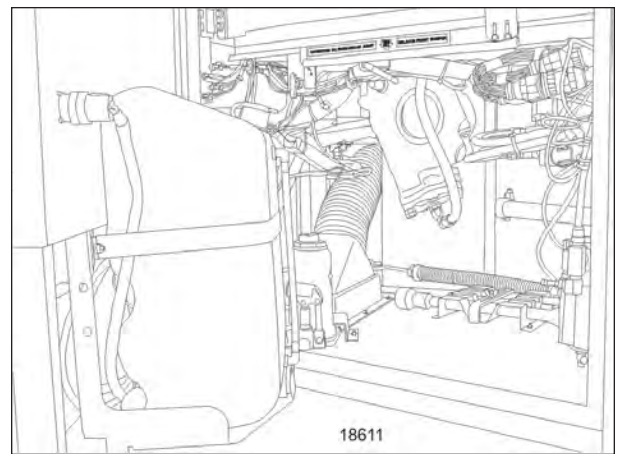
- Vehicle Electrical Center Front (VECF);
- Relays and diodes;
- Master Control Module (MCM) (A36);
- Front terminal block;
- I/OE-B Multiplex Modules;
- I/OE-A Multiplex Modules;
- VECU;
- ABS Electronic Control Unit (ECU);
- C226 connector (MCM) type DB9 for laptop diagnostic tool;

The lower section of the front service compartment provides access to the following:

- Emergency entrance door air pressure relief valve;
- Windshield washer reservoir & headlights washer reservoir (optional);
- Accessories air tank fill valve
- Pneumatic accessories panel;
- Accessories air tank drain valve;
- Jack and tools



**FIGURE 30: FRONT SERVICE COMPARTMENT DOOR**



**FIGURE 31: FRONT SERVICE COMPARTMENT**



## REAR-VIEW MIRRORS

The vehicle is equipped with flat-type and convex-type rear-view mirrors. Convex mirrors give a wide-angle view. Objects viewed in convex-type rear-view mirrors appear smaller and are actually closer than they appear.

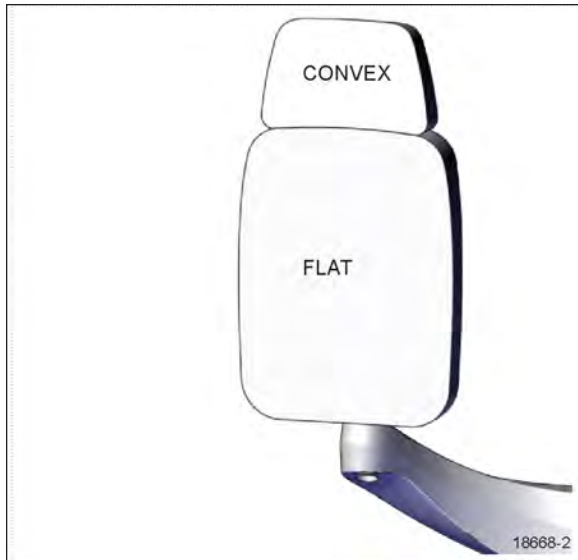


FIGURE 32: EXTERIOR REAR-VIEW MIRROR

To provide good visibility in cold weather, the mirrors can be equipped with heating elements. The elements are activated by a rocker switch located on the dashboard. Refer to "Controls & Instruments" chapter. Thermostats are used to prevent continuous operation of the heating elements.

### CAUTION

Do not attach stick-on type convex mirror accessories to the heated mirror glass. This could impede uniform heat distribution on the mirror surface and could break the mirror glass.

As an option, the mirrors may be equipped with LED turning signal lights to give an additional signal light when turning or changing lane for extra safety or for other drivers to see your signal when driving too close, in rain, fog or when in a blind spot.

The mirrors are adjusted using the controls located on the lateral control panel. Refer to "Controls & Instruments" section.

Adjust the side-view mirrors until the side of the vehicle is visible. Adjust the flat-type mirror until the road behind is in full view.

## SIDE CAMERA REAR-VIEW SYSTEM

The vehicle may be equipped with the optional video camera mirror system. To provide good visibility in cold weather, the camera lens shield is equipped with heating elements. The heating elements are activated by a rocker switch located on the dashboard. Refer to "Controls & Instruments" chapter.

### CAUTION

To avoid damage to the heating system, the heating elements shall not be permanently activated.

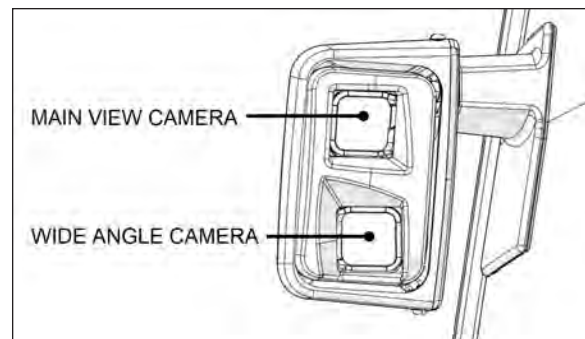


FIGURE 33: L.H. SIDE CAMERA

## EVAPORATOR COMPARTMENT

The HVAC (Heating, Ventilation and Air Conditioning) evaporator and heater coils are located in this compartment along with the blowers.

The evaporator compartment door release latch is located on the right wall of the baggage compartment, left of the door.

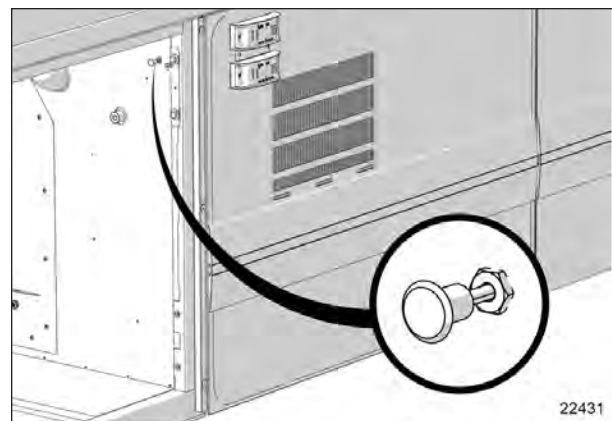


FIGURE 34: EVAPORATOR DOOR RELEASE LATCH

## 2-18 Coach Exterior

Pull the release latch then slide your hand in the opening to depress the secondary latch and swing open.

Temperature sensor is located behind the front bumper under the driver side head lights.

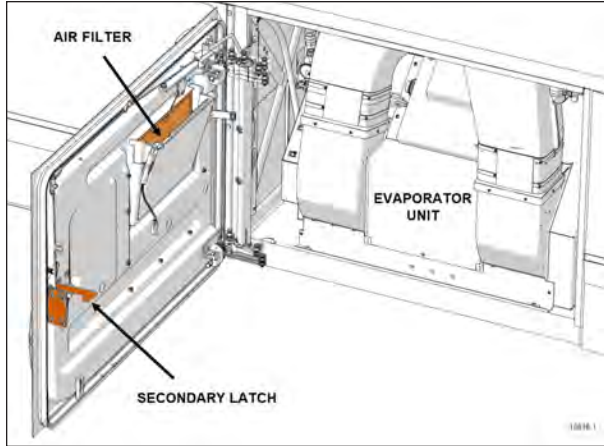


FIGURE 35: EVAPORATOR COMPARTMENT

## REAR FENDERS

Rear fenders are hinged for maintenance on brakes and suspension. Each rear fender panel has two mechanical springs loaded holding devices that secure the fender to the vehicle's structure.

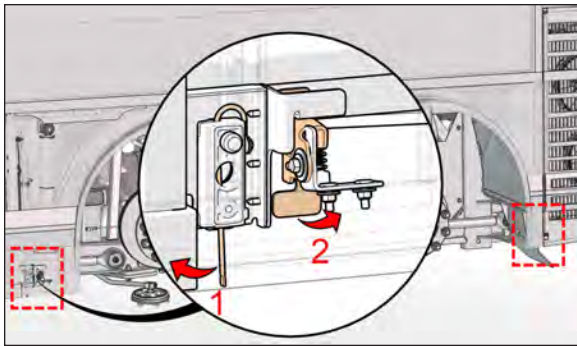


FIGURE 36: FENDER LATCHES

To lift a rear fender:

1. Push rod sideways;
2. Pull the secondary latch and then lift the fender.

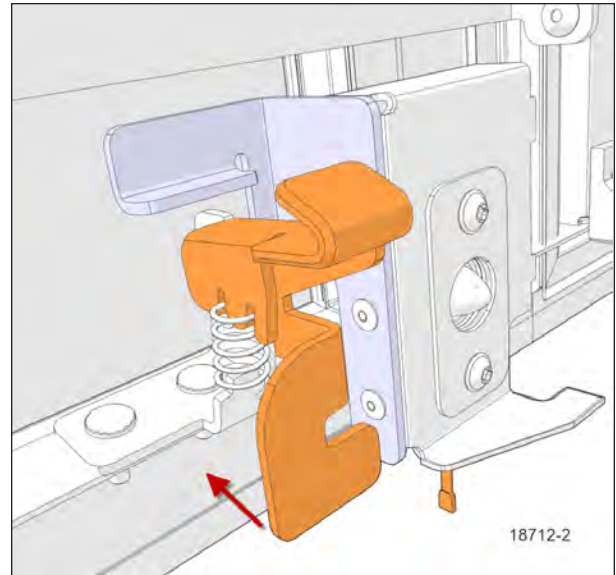


FIGURE 37: SECONDARY LATCH

## COOLANT PREHEATER

The vehicle may be equipped with the optional preheater located aft of the evaporator compartment, and accessible under left rear fender.

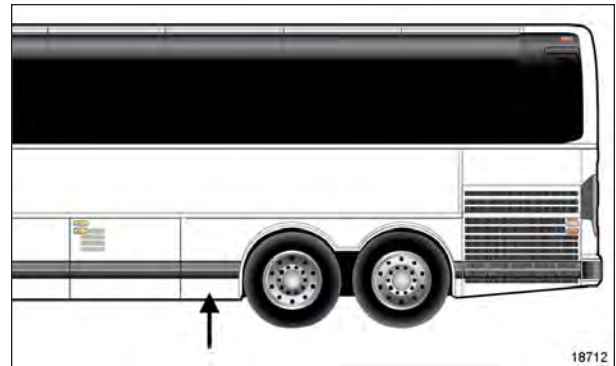


FIGURE 38: LOCATION OF PREHEATER

The water recirculating pump is also located in this location.

## HUBODOMETER

An odometer is installed on the curbside drive axle wheel hub. The odometer calculates the total distance in miles or kilometers (depending on the model installed) traveled by the coach since manufacture, including factory road testing.

**NOTE**

It is normal for the hubodometer, the engine ECM and the vehicle odometer to disagree on the total mileage.

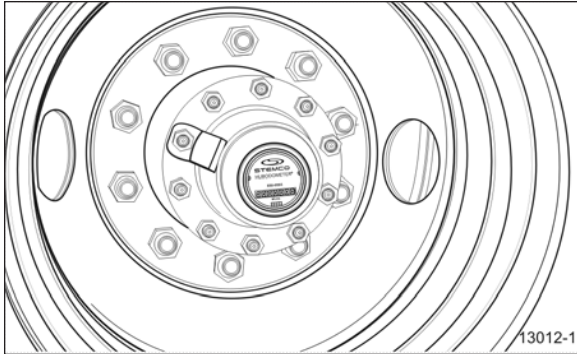


FIGURE 39: HUBODOMETER

## ENGINE RADIATOR DOOR

The engine radiator door gives access to the radiator electrical fans and power distribution box.

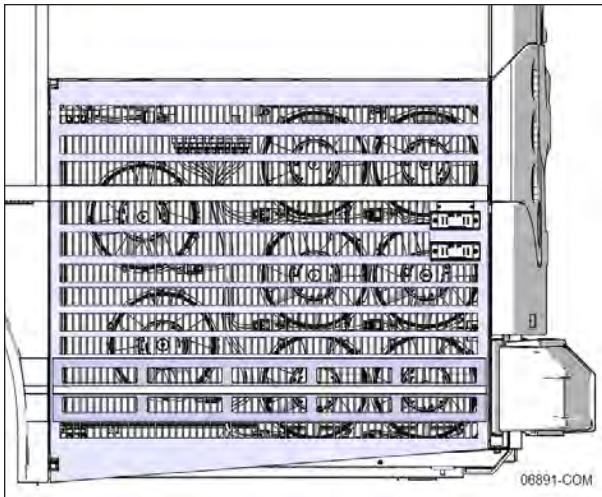


FIGURE 40: RADIATOR DOOR

Open the engine compartment rear door to access the engine radiator door release lever (see image below). Pull lever to release the radiator door.

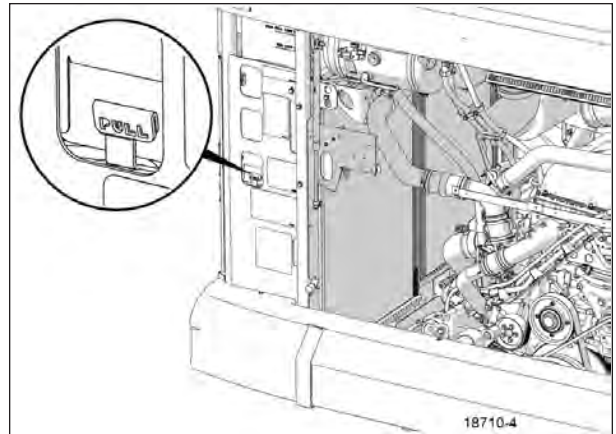


FIGURE 41: RADIATOR DOOR RELEASE LEVER LOCATION

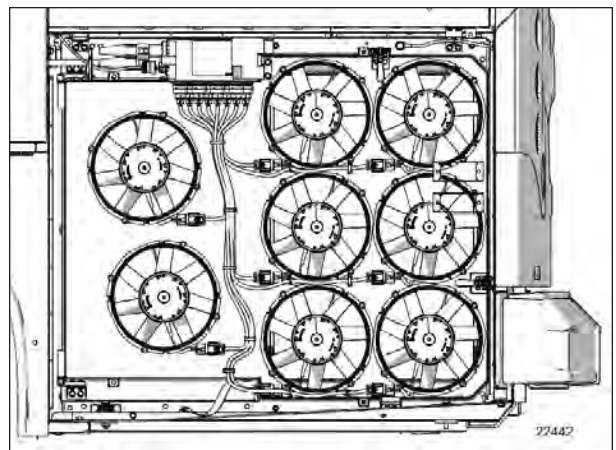


FIGURE 42: RADIATOR DOOR OPENED (FAN SHROUD NOT SHOWN)



### WARNING

WHEN THE ENGINE IS RUNNING...

Cooling fans may activate at any moment.

Keep hands away from cooling fans or keep the radiator door closed



### WARNING

**Cooling fans may be running when the engine is shut down in the following conditions:**

- If a High Exhaust Temperature condition exists (e.g. following regeneration). The CAC fans will keep running for a maximum of 15 minutes.
- During the electric Motor Test Sequence, the cooling fans will start running briefly.

## SCR CONVERTER ACCESS HATCH

This hatch is located above the radiator door.

To open the door, pull the handle behind the door panel (on the left).

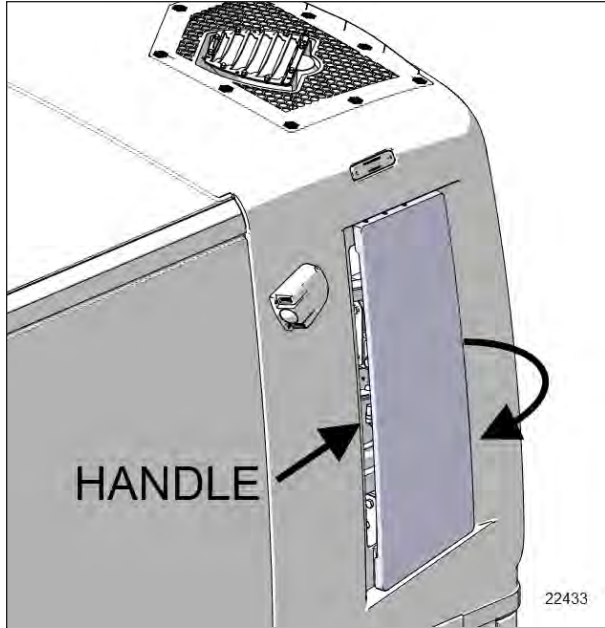


FIGURE 43: SCR CONVERTER ACCESS DOOR



FIGURE 44: SCR ACCESS DOOR HANDLE



### WARNING

External and internal temperatures remain hot long after the engine has been shut down. Allow the Exhaust Aftertreatment System to cool before handling. Wear protective clothing and gloves while servicing.

## TRAILER HITCH

Your vehicle may be equipped with a factory-installed trailer hitch which has been designed to meet the following rating:

**Maximum gross trailer weight:**

**20,000 lbs. (9072 kg)**

**Maximum tongue weight at 6 1/2 inches (165 mm) or less from coupling receiver:**

**1,500 lbs. (680 kg)**

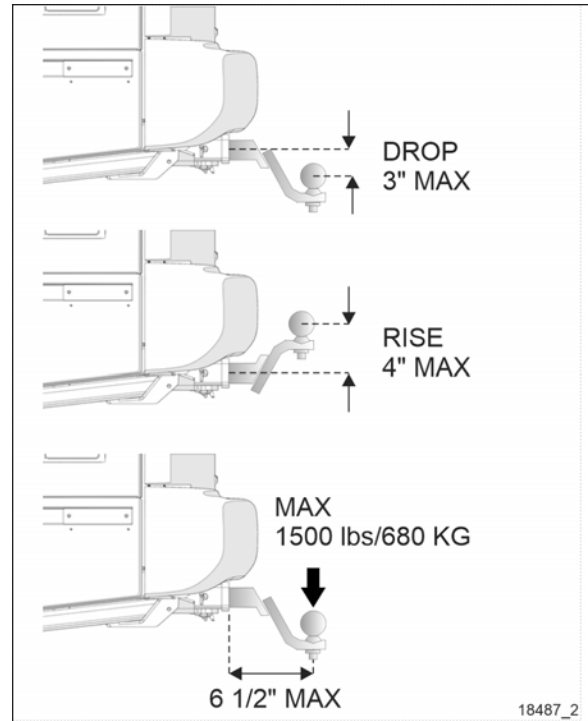


FIGURE 45: TRAILER HITCH

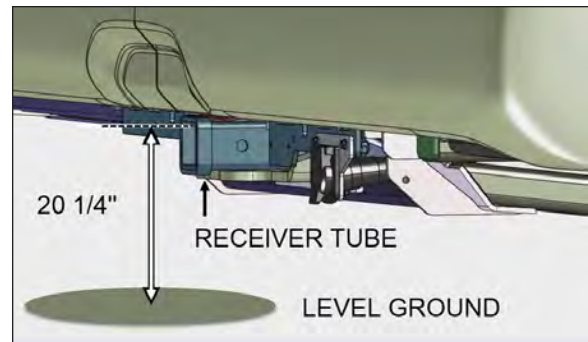


FIGURE 46: TRAILER HITCH



### DANGER

The draw bar and the ball used for towing the trailer should be rated for 20,000 lbs. capacity or more.

**WARNING**

Pulling a trailer weighing more than the recommended *maximum gross weight* may cause engine and transmission overheating, and a possible hitch failure.

**NOTE**

Pulling a trailer over long distances is considered as a "severe operating condition" for the vehicle. The engine will require more frequent servicing.

**TRAILER HITCH LIMITATIONS**

The minimum requirement for a trailer weighing up to 20,000 lbs. when coupled to a 20,000 lbs. Prevost Trailer Hitch is as per the following:

1. The trailer must comply with **Federal Motor Carrier Safety Regulations 393.52** regarding trailer braking capability.
2. The trailer coupling attachments must meet the following minimum static test load requirements. Use the indicated Gross Trailer Weight Rating (GTWR) of your trailer and multiply by the indicated value below.
  - Longitudinal tension and compression: (1.5 x GTWR)
  - Transverse thrust: (0.5 x GTWR)
  - Vertical tension and compression: (0.5 x GTWR)

*Loads indicated must be applied without incurring loss of attachments or distortion or failure which could affect the safe towing of a trailer.*

3. The ball and trailer coupling must meet the following minimum test load requirements without incurring failure. Use the indicated Gross Weight Rating (GTWR) of your trailer and multiply by the indicated value below.
  - Longitudinal tension and compression: (GTWR x 3)
  - Transverse thrust: (GTWR x 1)

- Vertical tension and compression: (GTWR x 1.3)

*In this case, failure is identified as the point at which the coupling or ball will accept no additional test load without separation of the ball from the coupling ball socket, or the occurrence of a metal fracture of either coupling ball or coupling assembly, which results in separation of the ball from the coupling ball socket.*

4. Two lengths of safety chain shall be used. The strength rating (minimum breaking force) of each individual chain and its connecting means shall be equal to, or exceed the trailer's Gross Weight Rating (GTWR).
5. The towing vehicle must be equipped with engine brake or transmission retarder. The engine or the transmission retarder on the vehicle must be functional at all times (to be inspected frequently).



## SECTION 3 - COACH INTERIOR

|   |           |
|---|-----------|
| <b>UTILITY COMPARTMENTS</b> .....                   | <b>2</b>  |
| <b>MICROPHONE JACKS</b> .....                       | <b>2</b>  |
| <b>DRIVER'S SEAT - ISRI</b> .....                   | <b>2</b>  |
| MECHANICAL ISRI SEAT .....                          | 2         |
| PNEUMATIC ISRI SEAT .....                           | 4         |
| <b>DRIVER'S SEAT – USSC 9100ALX</b> .....           | <b>4</b>  |
| DRIVER SEAT BELT .....                              | 5         |
| <b>PASSENGER SEATS</b> .....                        | <b>6</b>  |
| SWIVEL SEATS .....                                  | 6         |
| PASSENGER SEAT BELT .....                           | 7         |
| FOLDING TRAYS .....                                 | 7         |
| <b>TABLES</b> .....                                 | <b>8</b>  |
| <b>OVERHEAD CONSOLE</b> .....                       | <b>8</b>  |
| ADJUSTABLE AIR REGISTERS .....                      | 8         |
| SERVICE CHIME .....                                 | 8         |
| READING LIGHTS .....                                | 8         |
| <b>WINDOWS</b> .....                                | <b>9</b>  |
| PANORAMIC WINDOWS .....                             | 9         |
| DRIVER'S POWER WINDOW .....                         | 9         |
| <b>DRIVER'S AREA SUNSHADES</b> .....                | <b>9</b>  |
| <b>VENTILATION / EMERGENCY EGRESS HATCHES</b> ..... | <b>10</b> |
| <b>OVERHEAD COMPARTMENTS</b> .....                  | <b>10</b> |
| <b>ADJUSTABLE HVAC REGISTERS</b> .....              | <b>11</b> |
| <b>WASTE CONTAINER</b> .....                        | <b>11</b> |
| <b>STEERING WHEEL ADJUSTMENT</b> .....              | <b>11</b> |
| <b>INTERIOR MIRRORS</b> .....                       | <b>11</b> |
| <b>LAVATORY</b> .....                               | <b>11</b> |
| <b>GALLEY</b> .....                                 | <b>12</b> |
| <b>KEYS</b> .....                                   | <b>13</b> |
| EXTERIOR COMPARTMENT KEY .....                      | 13        |
| UTILITY COMPARTMENT KEY .....                       | 13        |
| FUEL FILLER DOOR KEY (OPTION) .....                 | 13        |
| LAVATORY DOOR KEY .....                             | 13        |
| UTILITY AND VIDEO COMPARTMENT KEY .....             | 13        |
| HAND TOWEL DISPENSER KEY .....                      | 13        |

## 3-2 Coach Interior

### UTILITY COMPARTMENTS

Two lockable utility compartments are located at the base of the windshield. Another utility compartment is located on the console, and includes a 12 volt appliance socket.

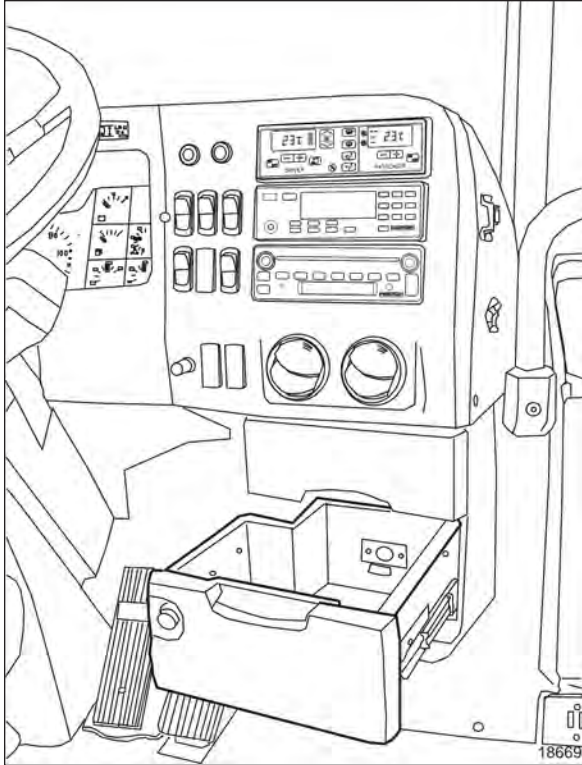


FIGURE 1: UTILITY COMPARTMENT IN CONSOLE

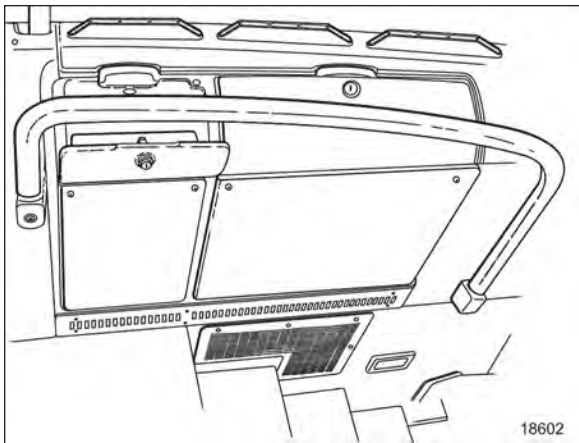


FIGURE 2: UTILITY COMPARTMENTS

### MICROPHONE JACKS

Up to six microphone jacks for the PA system can be located in the following locations:

- On the wall to the left of the driver;
- On the right-hand side of the dashboard;
- Two optional outlet for the tour guide on the modesty panel;
- One optional outlet on the lavatory wall, behind the last row of seats;
- One optional outlet under the overhead storage compartment, at the rear of the coach.

### DRIVER'S SEAT - ISRI

The vehicle can be equipped with one of two models of ISRI driver's seats. Mechanically adjusted seat and pneumatic models are available. Both seats are equipped with safety belts. Lumbar supports, heated cushions and adjustable armrests are optional.

#### DANGER

The driver's seat must be adjusted to allow the driver easy access to the coach controls. Never adjust seat while driving vehicle as this could result in loss of vehicle control.

#### DANGER

Make sure that seat is adjusted and that safety belt is buckled up before driving vehicle.

### MECHANICAL ISRI SEAT

#### Adjustment

Seat can be adjusted to the desired driving position by following the instructions listed below:



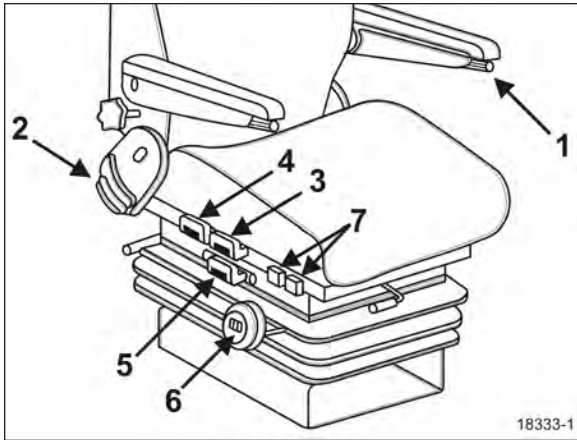


FIGURE 3: DRIVER'S SEAT ADJUSTMENT (MECHANICAL)

Armrest



The driver's seat can be equipped with two folding armrests.

To lower the armrest:

- Turn the control knob #1 (refer to figure: Driver's seat adjustment (mechanical)) counter-clockwise without applying pressure on the armrest
- Push the armrest down.
- Repeat procedure until the desired position is reached.

Backrest



Lift the lever #2 then adjust backrest to the desired angle.

Tilt (front)



To lower or raise the seat's front section, pull the handle #3 up and push or pull the seat cushion.

Tilt (rear)



To lower or raise the seat's rear section, pull the handle #4 up and push or pull the seat cushion.



**WARNING**

To avoid pinching the fingers between buckle and controls, lower the safety belt buckle before adjusting seat height.

Up and Down



Pull both handles (3 and 4) up to adjust the height of the seat.

Fore and Aft



To adjust distance between driver and dashboard, pull the handle #5 up and slide the seat forward or backward.

**NOTE**

*Fore-and-aft seat adjustment control may also be located at the front of the seat.*

Suspension



For maximum mechanical suspension performance, rotate the handwheel #6 until your body weight (in pounds) is shown on the indicator.

The seat suspension resistance can be changed to suit the driver. Turn the handwheel clockwise to increase suspension resistance and counter-clockwise to decrease resistance.

## 3-4 Coach Interior

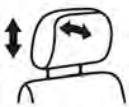
### Lumbar Support



To inflate the upper lumbar support bellows, depress the front rocker switch #7 upward. To deflate, depress the rocker switch downward.

Follow the same procedure to inflate and deflate the lower bellows using the rear rocker switch.

### Headrest



The headrest can be adjusted forward, rearward and vertically by 2 inches (50 mm). Directly move the headrest to the desired position.



## DANGER

For best protection, position headrest behind your head, not behind your neck.

### PNEUMATIC ISRI SEAT

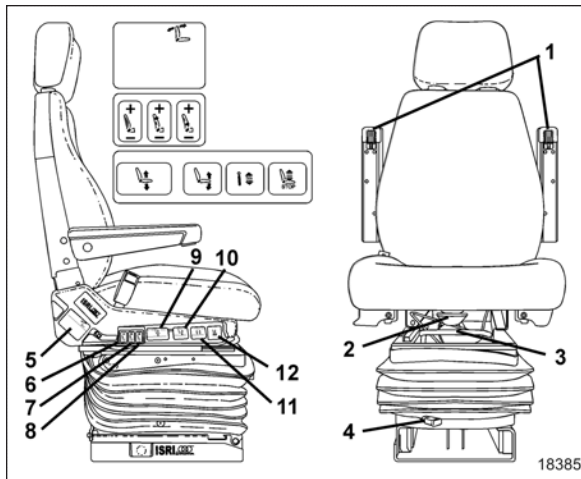


FIGURE 4: PNEUMATIC DRIVER'S SEAT

#### (1) Armrest

Rotate control knob to select desired arm-resting angle. When not in use, raise armrest parallel with backrest.

#### (2) Seat Cushion

Provides optimum comfort and support for any driver size. Adjustable to 50 mm (2 inch) length.

#### (3) Fore-and-aft

Pull handle up and slide seat forwards or backwards to adjust distance between seat and dashboard.

#### (4) Isolator

Reduces horizontal vibration, ensuring smooth ride.

#### (5) Backrest

Lift lever to select proper angle of backrest.

#### (6) Air Side Bolster

Offers desired side support to avoid body side-way.

#### (7) (8) Air Lumbar

Provides back support with upper and lower settings, ensuring comfort during lengthy sitting.

#### (9) Air Height Adjustment

Moves seat up or down independently of other seat settings. 100 mm (4 inch) total travel.

#### (10) Adjustable Seat Recline

Allows easy adjustment of four-setting inclination.

#### (11) Adjustable Shock Absorber

Choose stiff or soft ride infinitely.

#### (12) Quick Air Release

Exhausts all air from suspension, allowing for easy entry/exit. Returns seat to previous position.

## DRIVER'S SEAT – USSC 9100ALX

The coach can be equipped with USSC 9100 ALX air suspension seat. This seat is equipped with 3-point safety belts, lumbar supports, dual shock suspension damping and quick dump air release. This seat also features adjustable headrest.

## DANGER

The driver's seat must be adjusted to allow the driver easy access to the coach controls. Never adjust seat while driving vehicle as this could result in loss of vehicle control.

## DANGER

Make sure that seat is adjusted and that safety belt is buckled up before driving vehicle.

### DRIVER SEAT BELT

The driver's seat is equipped with a retractable safety belt as required by State, Provincial and Federal regulations.

## WARNING

A snug fit with the lap belt positioned low on the hips is necessary to maximize driver safety. The belt should not be worn twisted. Avoid pinching belt and/or belt hardware in the seat mechanism. Do not wear the belt over rigid or breakable objects, such as eyeglasses, pens or keys as these may cause injuries.

## CAUTION

Never bleach or dry clean a safety belt.

To fasten, pull seat belt out of the retractor and insert the latch plate into the buckle until it clicks. No special adjustment is required since the reel device is self-adjusting. If seat belt operation becomes defective, report to a Prevost Car service center immediately.

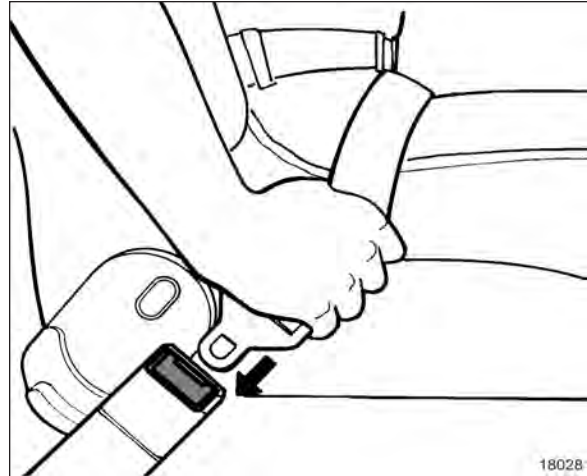


FIGURE 5: TO FASTEN SEAT BELT

To unfasten belt, press the red button in the center of buckle and allow belt to retract. If the belt does not fully retract, pull it out and check for kinks or twists. Make sure that it remains untwisted as it retracts.

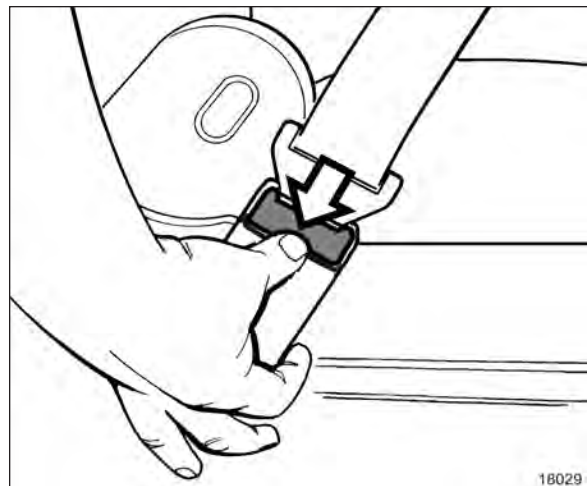


FIGURE 6: TO UNFASTEN SEAT BELT

## WARNING

Most State and Provincial laws require that safety belts be worn when they are supplied with the seat.

### NOTE

*The safety belt must be pulled out slowly and continuously, otherwise it will lock the reel before the latch plate reaches the buckle. If this happens, allow the belt to retract completely and repeat the procedure correctly.*

## 3-6 Coach Interior

### PASSENGER SEATS

Passenger seats may be equipped with grip handles, newspaper holders, trays, cup holders and footrests.

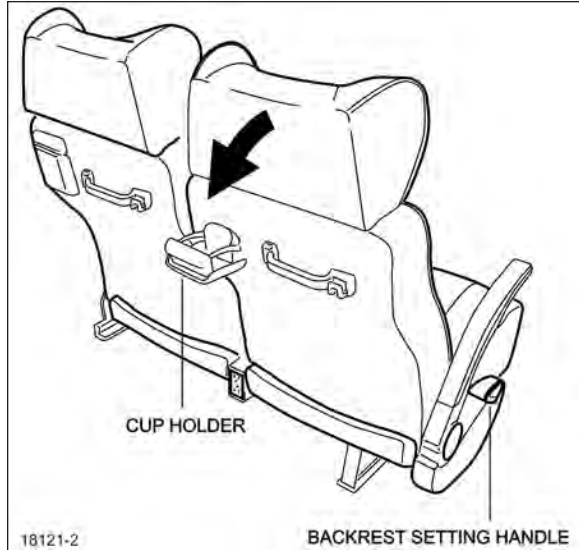


FIGURE 7: PASSENGER SEAT

All seats are track-mounted so that the seating configuration can be changed. Each set is mounted on rectangular aluminum bases to make cleaning between the base and side wall easier.

Passenger seat backrests can be tilted by using the push-button located on the base of the seat. Depress and hold push-button, then adjust backrest to the desired angle. Release the push-button to lock backrest in position.

A folding armrest is installed on the aisle side of the passenger. Another folding armrest is located between the two seats and can be raised for passenger convenience. A fixed armrest is installed on the window side of the seat.

### SWIVEL SEATS

The coach may be equipped with two sets of swivel seats to allow the installation of card tables. The swivel seat can be rotated for passenger privacy. Follow this procedure for seat rotation:

1. Loosen the threaded stud knob under the seat on the aisle side.

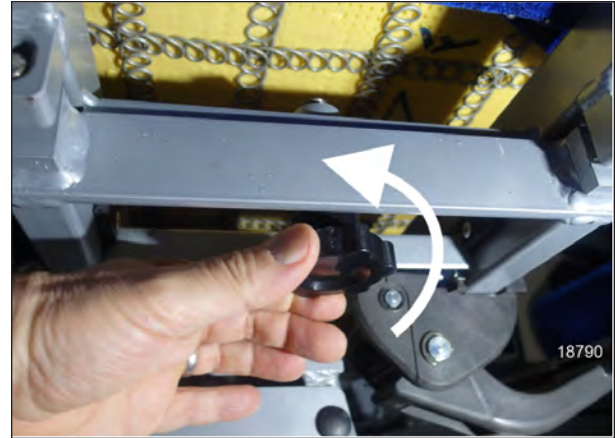


FIGURE 8: LOOSEN THE KNOB

2. Pull the seat toward the aisle to unlock the rotation.



FIGURE 9: PULL TO UNLOCK THE ROTATION

3. Rotate the seats until it stops (A) and push back toward the window to lock rotation (B).



FIGURE 10: FINAL POSITION

4. Fasten the threaded-stud knob under the seat on the aisle side.

## PASSENGER SEAT BELT

Passengers are strongly advised to wear seat belts at all times. Children can use a passenger seat belt as long as they are large enough to properly wear the seat belt. The shoulder belt must be correctly positioned over the child's shoulder and it must not touch the neck or lie below the shoulder.

To fasten, pull seat belt out of the retractor and insert the latch plate into the buckle until it clicks. No special adjustment is required since the retractor device is self adjusting. If the seat belt operation becomes defective, report to maintenance personnel immediately.

## ELR/ALR RETRACTOR LOCK MODE

Amaya passenger seat belts are equipped with switchable ELR/ALR retractor lock mode:

- **Emergency Locking Retractor (ELR) mode:** Allows the seat belt to extend and retract to allow passengers some freedom of movement in the seat. Locks only when the vehicle or occupant slows quickly/abruptly or stops suddenly. **Will not secure a child safety seat.**
- **Automatic Locking Retractor (ALR) mode:** Locks and maintains a fixed seat belt length during use. The belt cannot be extended further. **For use with a child safety seat.**



## CHILD RESTRAINT SYSTEMS

Occupants under 40" height must use Child Seat / Booster

The seat belts are equipped with switchable ELR/ALR retractor lock mode.

Activate the ALR retractor lock mode to hold a child restraint system by pulling the shoulder belt all the way out. Allow it to retract to desired length. Check that the belt straps are fully tightened and the retractor / webbing are locked.

Note: Unbuckling the belt and allowing it to retract fully deactivates the ALR retractor.

Failure to use the ALR lock mode will result in the child safety seat not being properly secured.

When using a booster seat, do not pull the shoulder belt all the way out. Doing so would engage the ALR lock mode which is not recommended with booster seat.

Install the child seat/booster according to the manufacturer's instructions.

## FOLDING TRAYS

Two optional folding tray models can be installed in the coach.

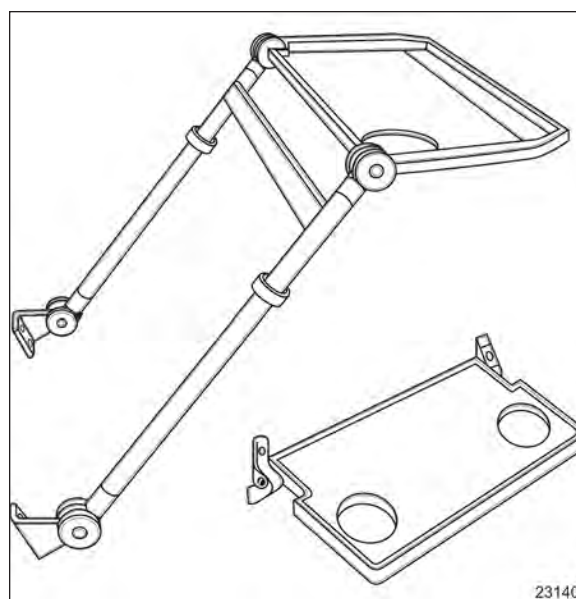


FIGURE 11: FOLDING TRAY MODELS

## 3-8 Coach Interior

### NOTE

Both tray models as well as the tray installed onto each modesty panel are equipped with tumbler holders.

## TABLES

Two removable tables are provided as standard equipment in the passenger swivel seat configuration. The tables are stored in the overhead storage compartments in separate storage bags.

To install the table, hold it at 45° (degrees) to the side wall. Insert the spring-loaded pin then the locking pin into the hinge. Push on the locking clamp to release the leg. Unfold the leg until the clamp locks it in position.

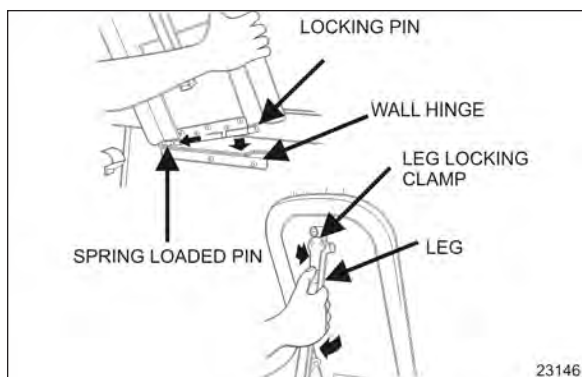


FIGURE 12: REMOVABLE TABLE INSTALLATION

## OVERHEAD CONSOLE

An overhead console is installed above each row of twin seats. Amenities include reading lights, air vents and an optional service bell.

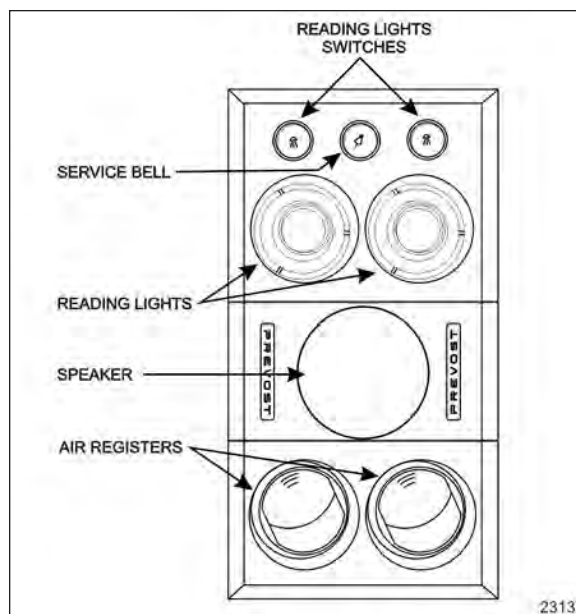


FIGURE 13: OVERHEAD CONSOLE

## ADJUSTABLE AIR REGISTERS

Manually adjustable registers located on the overhead console provide air flow to the passengers. Airflow can be directed, passengers can orient individual registers by rotating the nozzle. To adjust the airflow, passengers must open or close the flaps. Activation of the fans is done by depressing a rocker switch on the dashboard. Refer to Controls & Instruments.

## SERVICE CHIME

Pressing the service button on the overhead console will illuminate the button providing a visual cue for service personnel and, if activated, will sound a chime in the driver's area. The chime system is activated by a rocker switch located on the dashboard. Refer to [Stop / Service Chime \(Optional\)](#) in Controls & Instruments chapter. Passengers may also use the chime system to request a stop for disembarking. Press the service button a second time to cancel the service request. To adjust the chime volume level, refer to "Controls & Instruments" under Audiovisual Controller.

## READING LIGHTS

Reading lights are mounted underneath the overhead storage compartments. Depressing a rocker switch located on the dashboard will

activate the reading light circuit and allow passenger control of reading lights.

## WINDOWS

The vehicle is equipped with flush-mount type windows all around and a split-window windshield for maximum visibility.

### PANORAMIC WINDOWS

Panoramic side windows can come in either single pane or, as an option, double pane (thermopane) glass. Some of these windows are of the fixed type and cannot be opened. Others can be easily opened to serve as emergency exits.

#### Fixed Windows

These windows are bonded to the structure. Fixed windows cannot be opened.

#### Emergency Windows

These windows can be opened from inside the vehicle as emergency exits. A decal on window sills indicates the location of the emergency windows. To open an emergency window, lift the window release bar (sill) and push the window open from the bottom.



FIGURE 14: EMERGENCY WINDOW OPENING

To close, lift the release bar and pull the window into position. Push down on release bar to lock the window shut.

For more information on emergency windows, refer to ["EMERGENCY EXITS" on page 2](#) in section *SAFETY FEATURES & EQUIPMENT*.

### Window Sun Shades

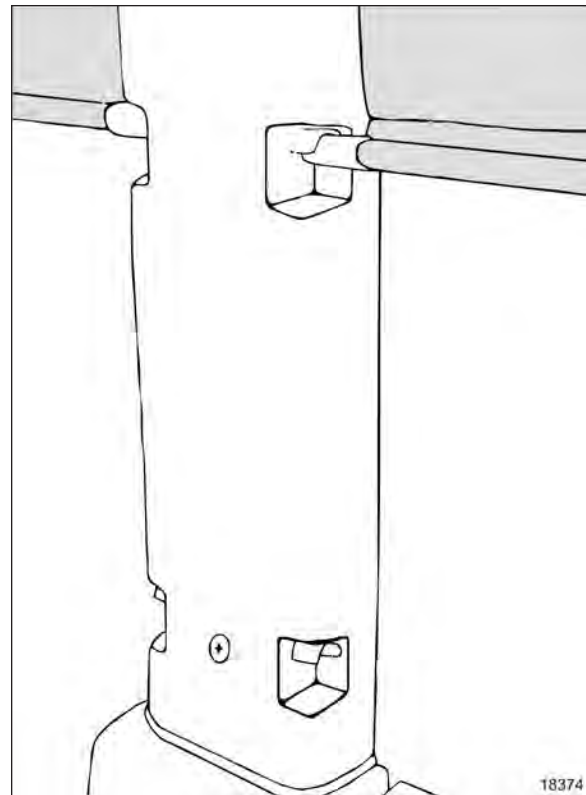


FIGURE 15: PULL DOWN SUN SHADES

Passenger windows may be equipped with pull-down sun shades. To operate, pull down the shade and insert the hem into the first or second catch. To retract pull out from the slots and guide the shade back up.

### DRIVER'S POWER WINDOW

The driver has a power window on the left side of the vehicle. The windows are controlled by a rocker switch located on the driver's control panel. Refer to "Controls and Instruments".

### DRIVER'S AREA SUNSHADES

This vehicle is provided with a sunshade on the driver's left side window. To operate, pull down the sunshade by its knob to the appropriate position and release. It will remain in position. To raise, pull up the sunshade by its knob.

## 3-10 Coach Interior

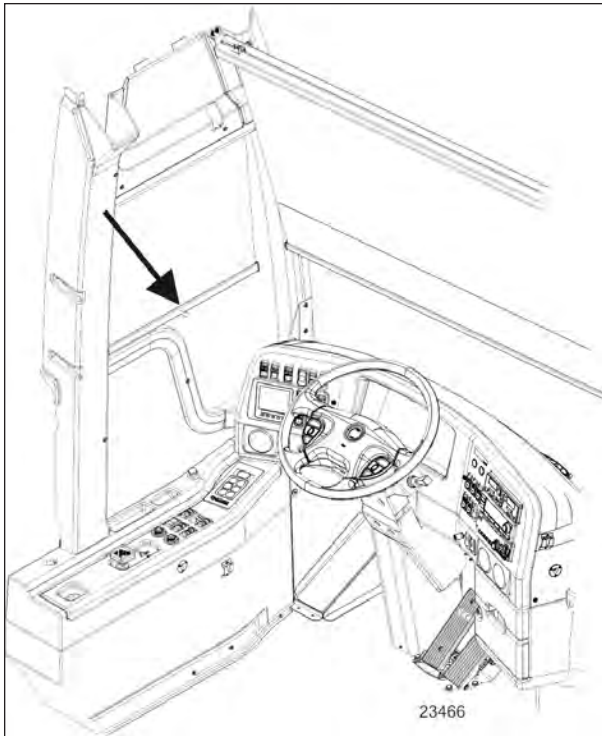


FIGURE 16: DRIVER'S WINDOW SUNSHADE

Two electrically-operated sunshades are installed behind the windshields. Two rocker switches on the dashboard operate each shade individually. Refer to "Controls and Instruments" chapter for more information.



### CAUTION

The electric shades should only be operated electrically. Pulling down manually may damage the mechanism.

## VENTILATION / EMERGENCY EGRESS HATCHES

A ventilation hatch may be installed in the ceiling at the rear of the coach. A second, optional hatch can be installed on the roof at the front of the coach. To open the hatch, push up with both hands and pull down to close. The ventilation hatch can be completely opened for emergency egress. Refer to "Safety Features and Equipment".

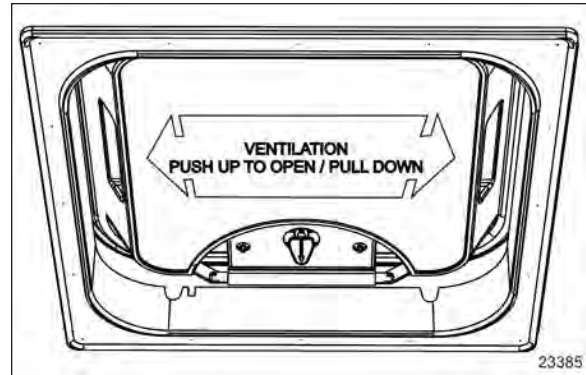


FIGURE 17: VENTILATION HATCH



### WARNING

Be aware of coach overhead clearance when traveling under overpasses with the ventilation hatch(es) open. Check for maximum clearance height.

## OVERHEAD COMPARTMENTS

Passenger carry-on baggage is stored in overhead compartments on each side of the coach. A first aid kit is located in the first front curb side overhead storage compartment.

A media player may be installed in the first front driver's side overhead storage compartment.

To open the optional closed overhead storage compartments, push the handle in to release the latch, then let go. A pressurized cylinder opens the door.

### NOTE

*The overhead storage compartments have a minimum number of separators installed so as to quicken inspection for forgotten objects.*

### NOTE

*An optional lock can be installed on the first front driver's side overhead storage compartment door.*





FIGURE 18: OVERHEAD STORAGE COMPARTMENTS

## ADJUSTABLE HVAC REGISTERS

Use the HVAC control panel to set air temperature (refer to "[HVAC CONTROL UNIT](#)" on [page 1](#) in Controls & Instruments chapter).

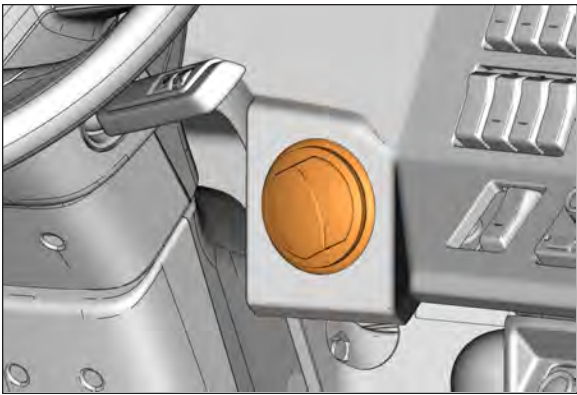


FIGURE 19: DASHBOARD AIR REGISTER

## WASTE CONTAINER

The waste container is located on the lavatory wall, and is accessible through an opening on each side of the wall. A small door, located on the aisle side, gives access to the waste container for cleaning.

## STEERING WHEEL ADJUSTMENT

Push on the valve button located in the foot-operated control housing to unlock the steering wheel for tilt and telescopic adjustment (refer to "[FOOT-OPERATED CONTROLS](#)" on [page 76](#) in Controls and Instruments chapter).

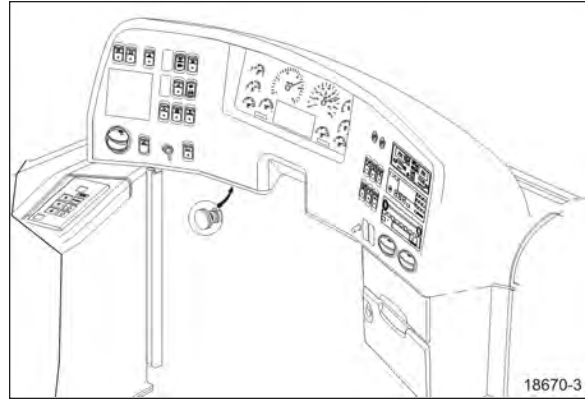


FIGURE 20: TILT AND TELESCOPIC ADJUSTMENT



## DANGER

Do not adjust the steering wheel while driving. Loss of control could result. Park the vehicle safely and apply parking brakes before adjusting the steering wheel.

## INTERIOR MIRRORS

Two manually adjustable convex mirrors are located in the driver's area. A 6 inches round mirror positioned just above the entrance door stepwell helps to determine that the front door is cleared of passengers while a central rectangular mirror allows the driver to see the aisle and the passengers behind him.

## LAVATORY

The lavatory is located in the rear curb side corner of the coach. It is equipped with a chemical flush toilet, bathroom tissue dispenser, mirror and waste container access.

A movement detector will automatically illuminate a fluorescent light inside the lavatory and two outside signs to indicate occupation. One sign is located on the outer wall of the lavatory and another sign is located over the windshield. A telltale light on the dashboard will also illuminate to inform the driver when the lavatory is occupied.

If emergency assistance is required, the lavatory occupant can actuate a buzzer that will sound in driver's area. The buzzer's push-button is located just below the toilet flush button.

### 3-12 Coach Interior



FIGURE 21: FLUSH AND EMERGENCY BUTTONS

The lavatory has its own ventilation system that operates only when the ignition switch is in the "ON" position.

#### **NOTE**

*This fan runs constantly when the ignition switch located on the dashboard is in the "ON" position.*

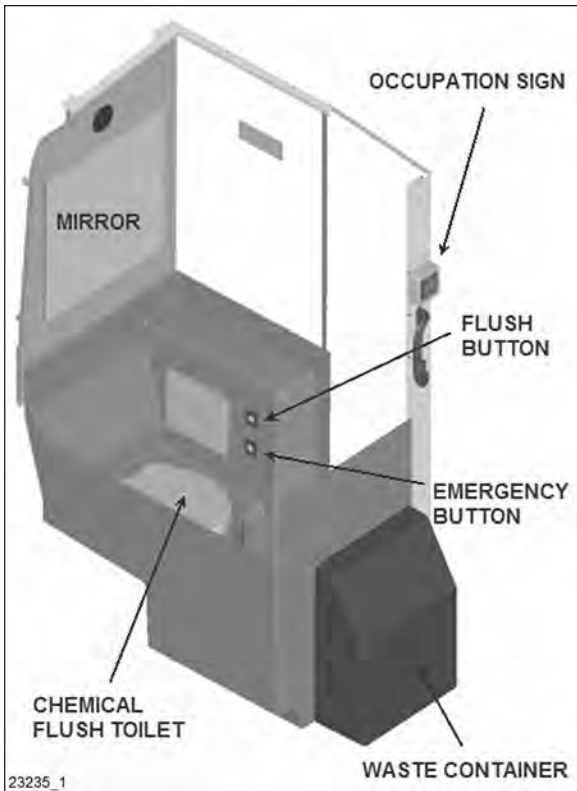


FIGURE 22: LAVATORY

## GALLEY

The optional galley may include features such as a microwave oven and refrigerator to accommodate hot or cold food and beverage

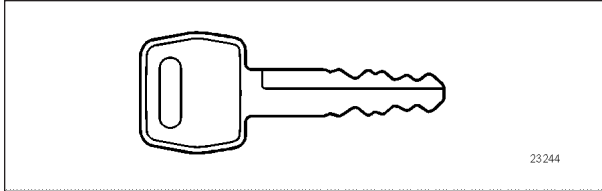
service. The galley's electrical power circuit is activated by a rocker switch located on the dashboard. Refer to "Controls & Instruments" chapter.

## KEYS

Depending on options, up to nine different keys may be provided with the coach.

### EXTERIOR COMPARTMENT KEY

Use this key to lock or unlock the entrance door, the baggage doors the electrical and service compartment doors, except the fuel filler door.

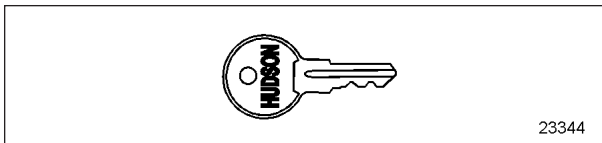


#### NOTE

*It is also possible to lock/unlock the baggage compartment doors from the inside by means of the baggage compartment- locking system switch located on the lateral control panel.*

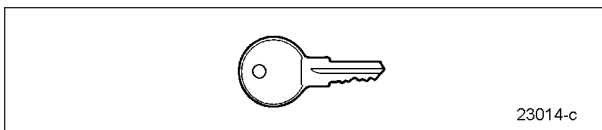
### UTILITY COMPARTMENT KEY

This key locks or unlocks the utility compartments and the utility drawers on and around the dashboard.

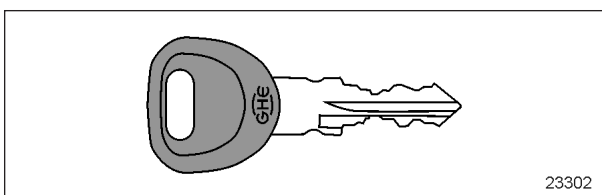


### FUEL FILLER DOOR KEY (OPTION)

Use this key to lock or unlock the fuel filler door.

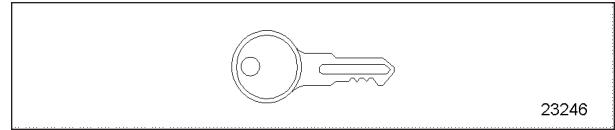


### LAVATORY DOOR KEY



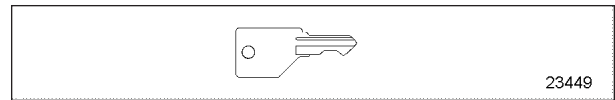
Use this key to lock or unlock the lavatory.

### UTILITY AND VIDEO COMPARTMENT KEY



Use this key to lock or unlock the lockable utility compartments and the lockable overhead compartment containing the video cassette player.

### HAND TOWEL DISPENSER KEY



Use this key to open the hand towel dispenser.

#### NOTE

*Optional moist towel dispenser uses another key.*



## SECTION 4 - CONTROLS AND INSTRUMENTS

|  |           |
|--|-----------|
| <b>IGNITION SWITCH</b> .....   | <b>4</b>  |
| ACCESSORIES .....  | 4         |
| OFF .....  | 4         |
| ON .....   | 4         |
| START .....  | 5         |
| <b>DRIVER'S AREA OVERVIEW</b> .....  | <b>6</b>  |
| <b>LATERAL CONTROL PANEL</b> .....   | <b>7</b>  |
| TRANSMISSION CONTROL PAD .....   | 7         |
| CONTROL SWITCHES .....   | 7         |
| MIRROR CONTROLS .....  | 9         |
| TAG AXLE CONTROL VALVE .....   | 9         |
| PARKING BRAKE CONTROL VALVE .....  | 9         |
| PREHEATER TIMER (OPTION) .....   | 9         |
| LOW-BUOY CONTROL VALVE (OPTION) .....  | 9         |
| UTILITY COMPARTMENT .....  | 10        |
| 12-VOLT POWER OUTLET .....   | 10        |
| TRAILER AIR SUPPLY CONTROL VALVE (OPTION) .....                                | 10        |
| EMERGENCY/PARKING BRAKES OVERRULE CONTROL VALVE .....                          | 10        |
| <b>SIDE CAMERA REAR-VIEW MONITORS</b> .....                                    | <b>10</b> |
| REFERENCE LINES .....  | 10        |
| BRIGHTNESS ADJUSTMENT .....  | 11        |
| MONITOR STATE .....  | 11        |
| <b>BACK-UP CAMERA AND MONITOR</b> .....  | <b>13</b> |
| <b>SCENIC VIEWING SYSTEM CAMERA</b> .....                                      | <b>13</b> |
| <b>ON BOARD DIAGNOSTIC TOOL RECEPTACLE</b> .....                               | <b>13</b> |
| <b>AUTOMATIC FIRE DETECTION AND SUPPRESSION SYSTEM (AFSS)</b> .....            | <b>13</b> |
| AUTOMATIC FIRE SUPPRESSION SYSTEM PANEL .....                                  | 13        |
| <b>CRUISE CONTROL</b> .....  | <b>13</b> |
| TURNING THE SYSTEM ON .....  | 14        |
| SETTING A CRUISING SPEED .....   | 14        |
| <b>PREVOST DRIVER ASSIST™</b> .....  | <b>16</b> |
| ASSOCIATED HARDWARE EQUIPMENT .....  | 16        |
| PREVOST DRIVER ASSIST™ CONSISTS OF THE FOLLOWING SYSTEMS AND FEATURES .....    | 17        |
| POTENTIALLY CHALLENGING SITUATIONS FOR THE PREVOST DRIVER ASSIST™ SYSTEM ..... | 19        |
| LANE DEPARTURE WARNING LDW .....   | 19        |
| FORWARD COLLISION MITIGATION FCM .....   | 22        |
| ADAPTIVE CRUISE WITH BRAKING ACB .....   | 23        |
| FOLLOWING DISTANCE ALERT (FDA) .....   | 26        |

## 4-2 Controls and Instruments

---

|  |           |
|--|-----------|
| FOLLOWING DISTANCE ALERT .....                                     | 27        |
| IMPACT ALERT .....   | 28        |
| BRAKE OVERUSE WARNING .....  | 28        |
| WHAT TO EXPECT WHEN USING THE PREVOST DRIVER ASSIST™ SYSTEM .....  | 30        |
| HOW YOUR ACTIONS IMPACT THE PREVOST DRIVER ASSIST™ SYSTEM .....    | 33        |
| <b>TIRE PRESSURE MONITORING SYSTEMS (TPMS) .....</b>               | <b>35</b> |
| SYSTEM MALFUNCTION .....   | 35        |
| TPMS-LITE VERSION .....  | 35        |
| ON-SCREEN TPMS VERSION .....                                       | 35        |
| <b>DASHBOARD .....</b>   | <b>39</b> |
| CONTROL SWITCHES .....   | 40        |
| <b>AUDIO-VIDEO SELECTOR FOR THE PASSENGER'S AREA .....</b>         | <b>45</b> |
| OPERATION OF THE OPTIONAL AUDIO-VIDEO MODESTY PANEL .....          | 48        |
| <b>DASHBOARD RADIO AM/FM/SAT SERIES DEA700 .....</b>               | <b>48</b> |
| <b>HVAC CONTROL UNIT .....</b>                                     | <b>49</b> |
| <b>AIR REGISTERS .....</b>   | <b>50</b> |
| <b>INSTRUMENT PANEL .....</b>                                      | <b>51</b> |
| ANALOG INDICATORS .....  | 52        |
| TELLTALE LIGHTS .....  | 56        |
| STOP, CHECK AND INFORMATION TELLTALE LIGHTS .....                  | 60        |
| DRIVER INFORMATION DISPLAY .....                                   | 61        |
| DRIVER INFORMATION LEVEL .....                                     | 63        |
| PICTOGRAMS DISPLAYED ON THE DRIVER INFORMATION DISPLAY (DID) ..... | 64        |
| <b>STEERING COLUMN CONTROLS .....</b>                              | <b>73</b> |
| MULTI-FUNCTION LEVER .....   | 73        |
| STEERING WHEEL CONTROLS .....                                      | 74        |
| HORNS .....  | 76        |
| <b>FOOT-OPERATED CONTROLS .....</b>                                | <b>76</b> |
| BRAKE PEDAL .....  | 76        |
| ACCELERATOR PEDAL .....  | 76        |
| STEERING WHEEL ADJUSTMENT .....                                    | 77        |
| <b>ALLISON TRANSMISSION .....</b>                                  | <b>77</b> |
| OPERATION .....  | 77        |
| PUSHBUTTON SHIFT SELECTOR .....                                    | 77        |
| PRIMARY AND SECONDARY SHIFT SCHEDULES .....                        | 78        |
| TRANSMISSION SERVICE INDICATOR .....                               | 78        |
| DESCRIPTION OF AVAILABLE RANGES .....                              | 78        |
| <b>VOLVO I-SHIFT TRANSMISSION .....</b>                            | <b>80</b> |
| PUSHBUTTON SHIFT SELECTOR .....                                    | 81        |
| DISPLAY .....  | 81        |
| ACCELERATOR PEDAL .....  | 81        |

ECONOMY AND PERFORMANCE MODE ..... 81

ECO-ROLL MODE (FREEWHEEL FUNCTION) ..... 81

LIMP HOME MODE ..... 82

STARTING AND STOPPING ..... 82

STARTING THE VEHICLE UPHILL AND DOWNHILL ..... 83

DRIVING ..... 84

TOWING RECOMMENDATIONS ..... 85

## IGNITION SWITCH

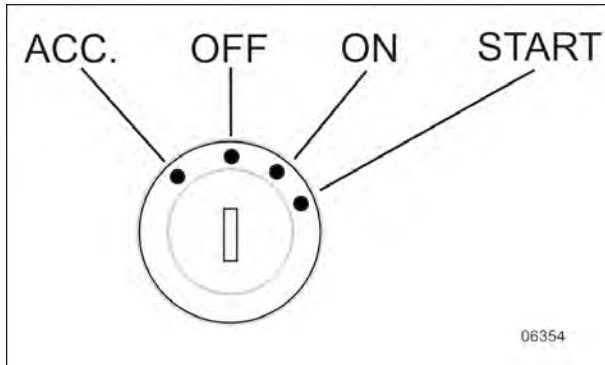


FIGURE 1: IGNITION SWITCH KEY POSITIONS

The ignition switch is located on the lower left side of the dashboard. With the battery master switch activated, turn the ignition key counterclockwise to the ACC position to activate the electrical circuits.

To start the engine, turn the key clockwise to the START position, and then release it. The key will set to ON position.

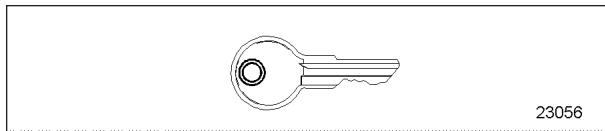


FIGURE 2: IGNITION KEY

Coaches may also be equipped with an ignition lever instead of an ignition key.

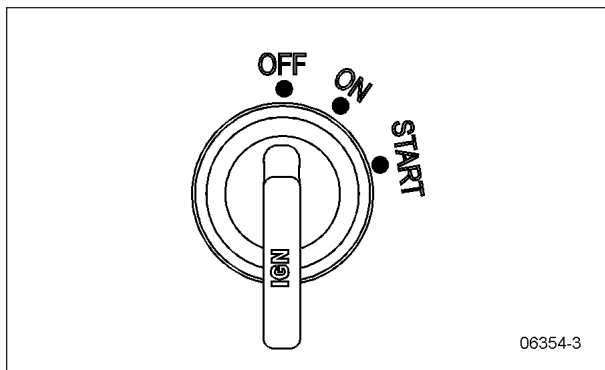


FIGURE 3: IGNITION SWITCH LEVER POSITIONS



### CAUTION

When the vehicle is parked overnight or for an extended period of time, the battery master switch (ignition switch) should be set to the OFF position.

### NOTE

When the battery master switch (ignition switch) is set to the OFF position, all electrical supply from the batteries is cut off, with the exception of battery equalizer check module, ECM ignition and power supply, Allison TCM or I-Shift transmission ECU, auxiliary coolant heater timer, coolant heater and water recirculating pump, power-verter, fire alarm and entrance door.

The ignition switch doubles as the battery master switch. Any position other than OFF activates the electrical circuits.

The ignition switch is located on the lower left side of the dashboard. It has four positions:

### ACCESSORIES

To operate the accessories only, turn the ignition key counterclockwise to the ACC position.

The electrical circuits are activated when the switch is in this position. The features enabled when the switch is in the ACC position are all those linked directly to the battery such as the radio or entertainment system, exterior and interior lighting.

### OFF

In the OFF position, ignition cannot take place. The key can be removed in this position.

The electrical circuits are not activated when the switch is in this position with the exception of the circuits of the accessories connected directly to the batteries and the “wake-up” systems which remains active for about 15 minutes after the ignition is set to the OFF position. Maintain the switch in this position when parked overnight or for an extended period.

### ON

To place ignition switch to the ON position, turn the key clockwise to the first position.

The electrical circuits activated are the same than the ACC position, plus the transmission, engine and accessories, ABS system, wipers, level low system, dashboard cluster gauges and buzzers, air horn and air dryer heater are activated when



the key is in this position. Do not leave the key in this position unless the engine is running.

### START

Turn the key clockwise to the second position and release as soon as the engine starts. The key will return to the ON position. If the engine did not start, return the ignition key to the OFF position before trying to restart the engine.

The ignition switch is equipped with a starter protection which inhibits turning the key to the START position if the key has not previously been turned to the OFF position.



#### CAUTION

To avoid overheating the starter, do not engage the starter for more than 15 seconds at a time. Allow the starter to cool before trying to restart the engine.



#### DANGER

Do not use ether or other combustible starting aid fluid on any engine equipped with an intake air preheater. If the engine is equipped with a preheater, introduction of ether or similar starting aids could cause a fire or explosion resulting in severe property damage, serious personal injury or death.

### DRIVER'S AREA OVERVIEW

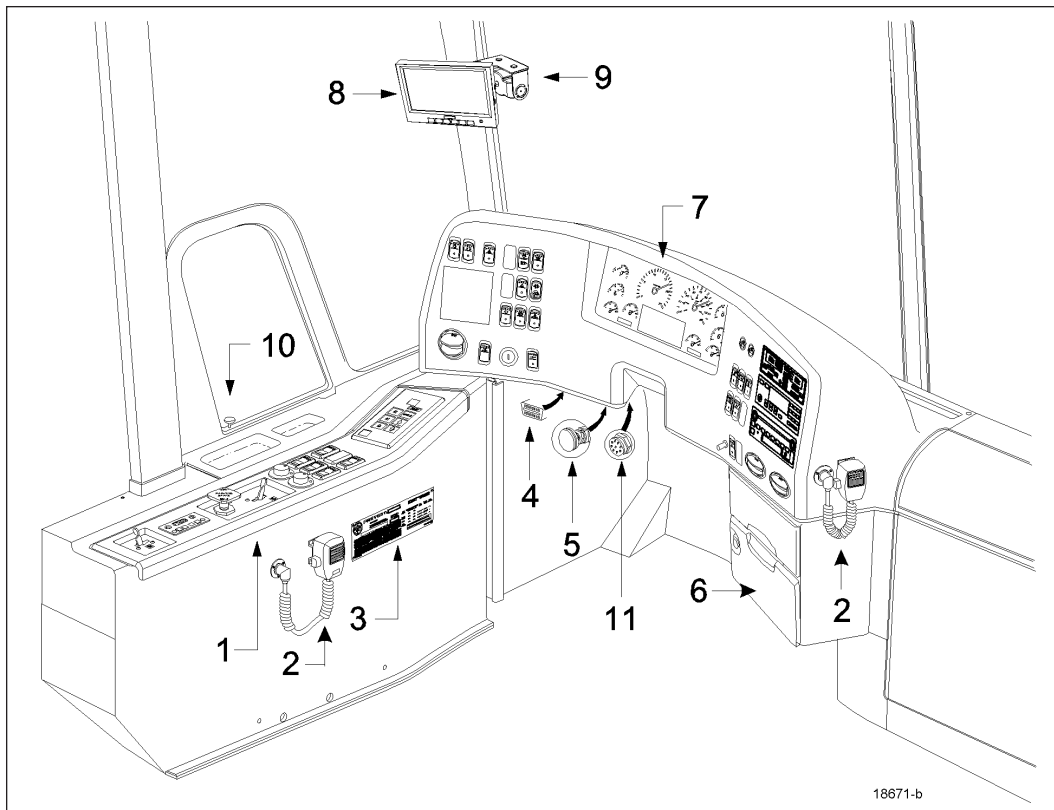


FIGURE 4: DRIVER'S AREA

1. Lateral control panel
2. Microphone
3. DOT certification plate
4. OBD (On Board Diagnostics) receptacle
5. Foot operated steering wheel adjustment knob
6. Driver's utility compartment
7. Dashboard
8. Rear-view monitor (optional)
9. Front view scenic camera (optional)
10. Front service door unlocking pull rod
11. Electronic Logging Device Connection (ELD)

## LATERAL CONTROL PANEL

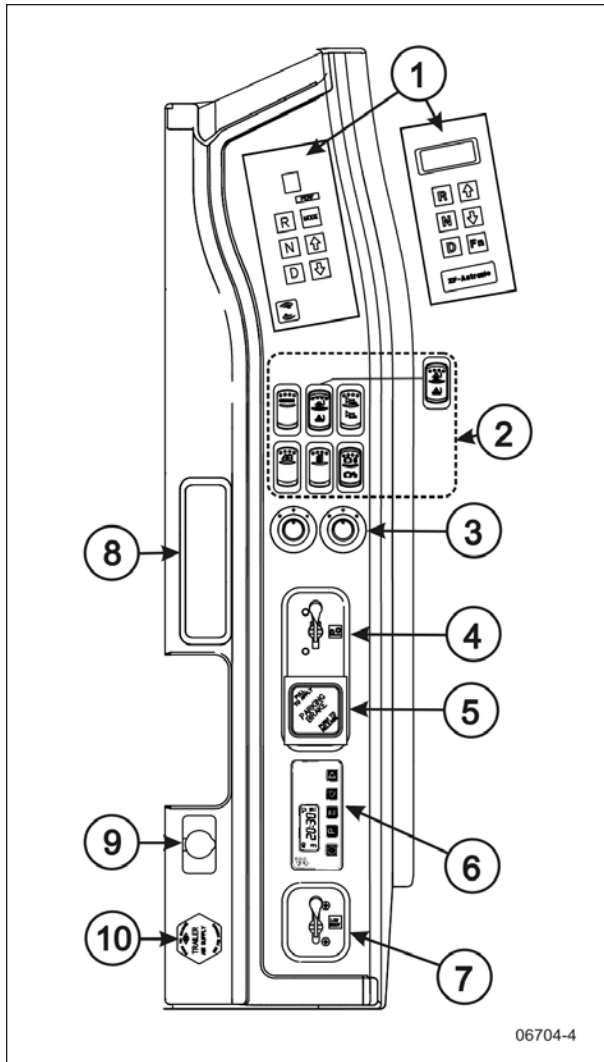


FIGURE 5: LATERAL CONTROL PANEL

1. Transmission control pad
2. Control switches
3. Mirror controls
4. Tag axle control valve
5. Parking brakes control valve
6. Coolant heater timer (option)
7. Low-buoy control valve (option)
8. Utility Compartment

9. 12 volts Appliances Socket
10. Trailer Air Supply Control Valve (option)

## TRANSMISSION CONTROL PAD

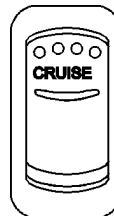
The Allison or Volvo I-Shift transmission control pad is located on the lateral control panel. Refer to ["ALLISON TRANSMISSION" on page 77](#) or ["VOLVO I-SHIFT TRANSMISSION " on page 80](#) in this chapter for operating instructions and more information.



FIGURE 6: TRANSMISSION CONTROL PAD

## CONTROL SWITCHES

### Cruise Control Switch

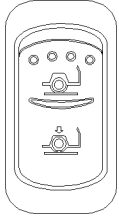


Depress the cruise rocker switch to activate the cruise control. This turns the system on. A led on the switch shows that you can now set the vehicle at a desired cruising speed.

For operation of the cruise control, refer to ["CRUISE CONTROL" on page 13](#) or ["ADAPTIVE CRUISE with BRAKING acb" on page 23](#) in this section.

### Kneeling / Front Axle Hi-Buoy (Optional)

## 4-8 Controls and Instruments



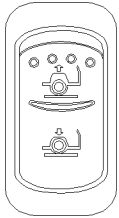
Momentarily press the rocker switch downwards to lower the front end of the coach 4 inches (100 mm). Momentarily press the rocker switch upwards to raise the coach to the normal driving height. Refer to "[High-BUOY](#)" on page 31 and "[KNEELING SYSTEM](#)" on page 31 in Section 5 for more information.

Press and hold the rocker switch upwards to raise the front end of the coach 4 inches (100 mm). Release the rocker switch to return the coach to the normal driving height.

### NOTE

*The parking brakes must be applied to allow the use of the kneeling.*

### Kneeling / Full Hi-Buoy (Optional)



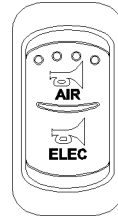
Momentarily press the rocker switch downwards to lower the front end of the coach 4 inches (100 mm). Momentarily press the rocker switch upwards to return the coach to normal driving height. Refer to "[High-BUOY](#)" on page 31 and "[KNEELING SYSTEM](#)" on page 31 in Section 5 for more information.

Press and hold the rocker switch upwards to raise the complete suspension of the coach 4 inches (100 mm). Release the rocker switch to return the coach to the normal driving height.

### NOTE

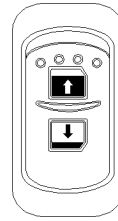
*The parking brakes must be applied to allow the use of the kneeling.*

### Horn Selector



Use this switch to toggle between the air horn and the electric horn when pressing the steering wheel center pad.

### Power Window Switch



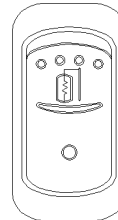
Use this rocker switch to open or close the driver's power window.



### CAUTION

Close power window when parked or leaving the coach unattended.

### Outside Rear View Mirror / Video Camera Mirror System Heat (Optional)



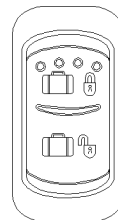
Press this rocker switch to clear fog, frost or thin ice from outside mirrors or the video camera mirror system lens protector.



### CAUTION

To avoid damage to the heating system, the heating elements shall not be permanently activated.

### Baggage Compartments Central Locking System



This system enables locking all baggage compartment doors by pressing the switch forward. To unlock, press the switch rearward.

**NOTE**

Service compartment doors are not linked to the baggage compartment-locking system.

**NOTE**

Baggage compartment doors must be unlocked using the key first, they can then be unlocked or locked using the baggage compartment-locking system.

**MIRROR CONTROLS**

Turn the pointer knob counterclockwise for flat mirror adjustment and clockwise for convex mirror adjustment, then use the pointer knob as a joystick to adjust the selected mirror's viewing angle. Adjust the right outside mirror similarly but by using the right side control.

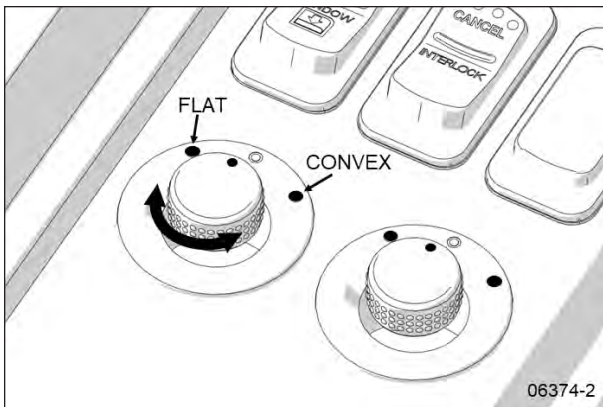


FIGURE 7: MIRROR CONTROLS

**NOTE**

If the mirror assemblies on your vehicle do not include convex mirrors, only one mirror control knob will be installed for both mirrors. To operate, turn pointer counterclockwise for L.H. mirror adjustment and clockwise for R.H. mirror adjustment, then use the joystick control to adjust the selected mirror's viewing angle.

**TAG AXLE CONTROL VALVE**

Lift the tag axle by pushing the lever forward. Pulling the lever rearward will lower and load the tag axle. Refer to "[RETRACTABLE TAG AXLE](#)" on page 32 in Section 5 Other Features for additional information.

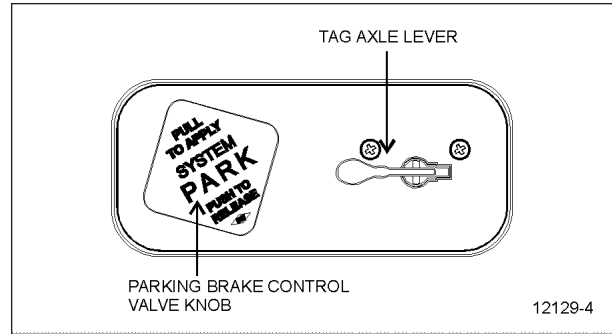


FIGURE 8: TAG AXLE CONTROL VALVE



**CAUTION**

Do not drive vehicle with tag axle raised when speed is exceeding 12 mph (20 km/h).

**PARKING BRAKE CONTROL VALVE**

Spring-loaded parking brakes are applied by lifting the safety cover (if present) and pulling up the control valve knob. Push down to release brakes. Refer to "[EMERGENCY AND PARKING BRAKES](#)" on page 12 in Section 7 Safety Features and Equipment.

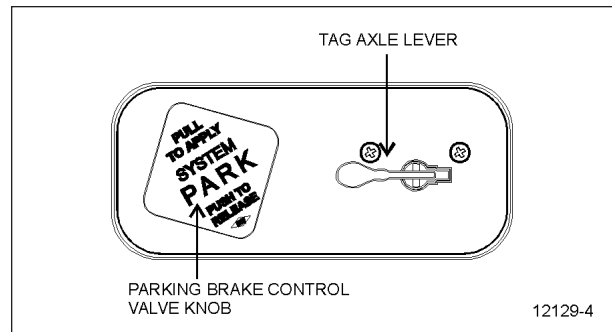


FIGURE 9: PARKING BRAKE CONTROL VALVE

**PREHEATER TIMER (OPTION)**

Use the timer to program the start time of the optional engine coolant heater. Refer to "[COOLANT HEATER TIMER](#)" on page 33 in Section 5 Other Features and [7 day timer operating instructions](#) for additional information.

**LOW-BUOY CONTROL VALVE (OPTION)**

Toggle back the control lever to lower the coach by about four inches. Returning the lever to the normal (forward) position raises the vehicle back to its normal height. Refer to "[LOW-BUOY](#)" on

## 4-10 Controls and Instruments

[page 32](#) in Other Features section for more information.

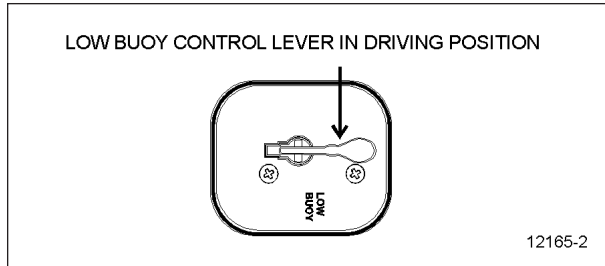


FIGURE 10: LOW-BUOY CONTROL VALVE



### CAUTION

Do not exceed speeds of 5 mph (8 km/h) when activated.

### UTILITY COMPARTMENT

To open the compartment, lift the cover.

### 12-VOLT POWER OUTLET

This 12-volt DC power outlet can be used to power small 12-volt DC appliances such as a cellular phone or a vacuum cleaner. The maximum power consumption allowed for appliances plugged in this socket is 130 watts. Make sure appliances are equipped with suitable plugs that will not damage the socket.

### TRAILER AIR SUPPLY CONTROL VALVE (OPTION)



The trailer air braking system is supplied by pushing this control valve.

### EMERGENCY/PARKING BRAKES OVERRULE CONTROL VALVE

The coach may be equipped with the optional parking brake overrule system, which allows the vehicle to be moved to the nearest safe parking area if the spring-loaded emergency brake has automatically applied to the drive axle wheels. To

actuate the parking brakes overrule system, push and hold down the control valve located on the lateral control panel.

## SIDE CAMERA REAR-VIEW MONITORS

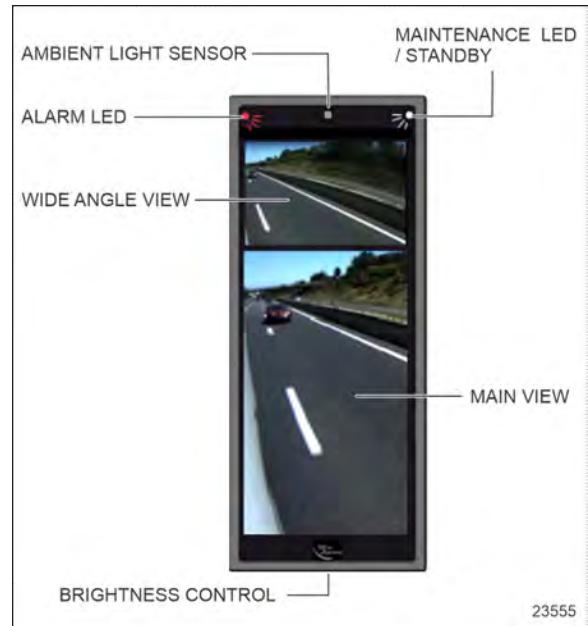


FIGURE 11: MONITOR



### CAUTION

Do not cover the cooling vents on the back of the monitor.

### REFERENCE LINES

Upon activation of the turn signals, three reference lines appear on the main view of the corresponding monitor (see image below). When in reverse, two reference lines (yellow & red) are displayed on both monitor.



### CAUTION

The position of the reference lines is approximate and may differ by a few feet from the actual distance. The driver always remains responsible to ensure a safe distance during maneuvers.

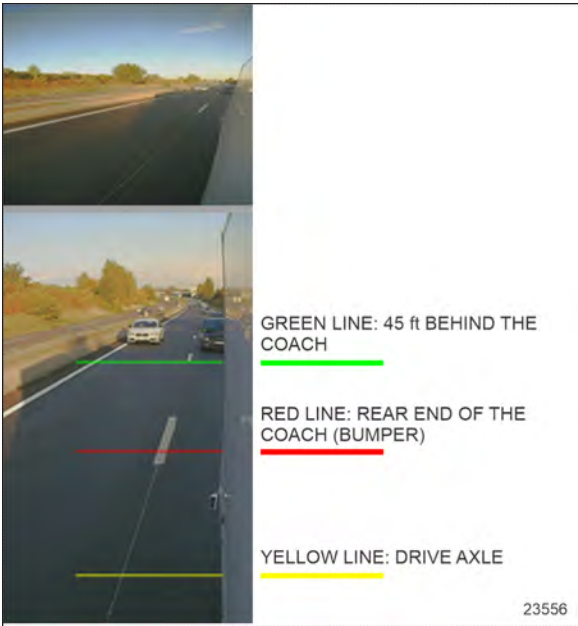


FIGURE 12: REFERENCE LINES IN MONITOR

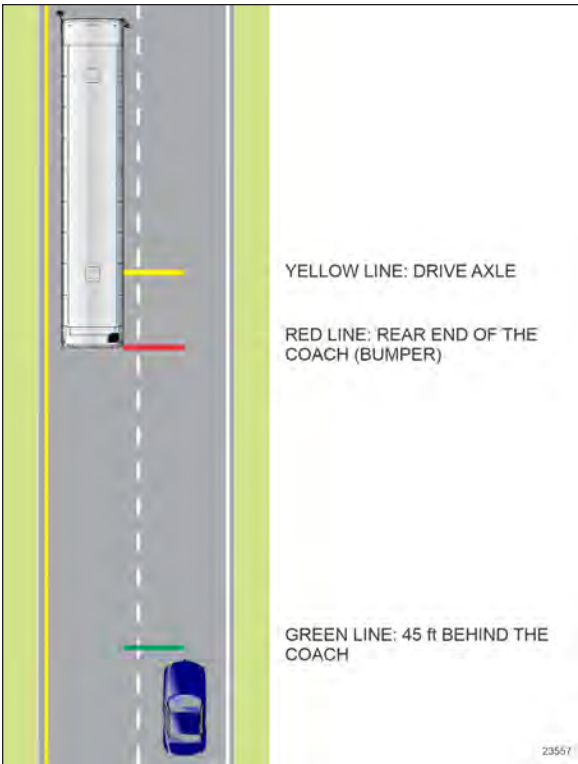


FIGURE 13: REFERENCE LINES

**BRIGHTNESS ADJUSTMENT**

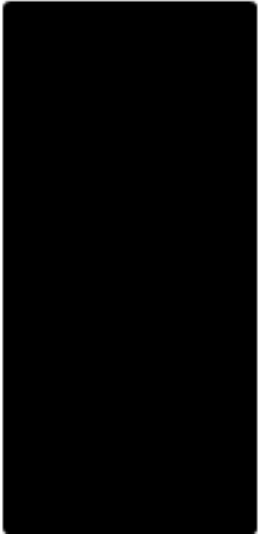
Each monitor switches automatically and independently between night mode and day mode depending on the actual ambient light. However, the driver can adjust the brightness with the brightness control at the bottom of the

monitor. This manual adjustment will change the brightness of both monitor at the same time.

**MONITOR STATE**

|                                |                                 |
|--------------------------------|---------------------------------|
| <p>SYSTEM BOOT</p>             | <p>NORMAL OPERATION</p>         |
| <p>SLEEP MODE<br/>blinking</p> | <p>MINOR ISSUE<br/>blinking</p> |

## 4-12 Controls and Instruments

|  |   |
|--|---|
| <p>WIDE-ANGLE VIEW<br/>NOT AVAILABLE</p> <p>blinking</p>  <p>The image shows a red indicator light in the top-left corner of a black display area. A large red 'X' is drawn over the top half of the display. Below the 'X' is a small, blurry inset image of a road scene.</p> | <p>MAIN VIEW NOT<br/>AVAILABLE</p> <p>steady</p>  <p>The image shows a red indicator light in the top-left corner of a black display area. A large red 'X' is drawn over the top half of the display. Below the 'X' is a horizontal white line, and the bottom half of the display is also crossed out with a red 'X'.</p> |
| <p>MAJOR ISSUE</p> <p>blinking</p>  <p>The image shows a red indicator light in the top-left corner of a black display area.</p>   | <p>NOT POWERED</p>  <p>The image shows a black display area with no indicator lights.</p>   |



## BACK-UP CAMERA AND MONITOR

An optional back-up camera is available which provides the driver with visual assistance when backing-up.

The monitor is mounted on the windshield L.H. side pillar and switches ON automatically when the transmission is in the reverse (R) range.

## SCENIC VIEWING SYSTEM CAMERA

The optional scenic viewing system enables the passengers to view the road ahead of the vehicle. The camera is mounted above the back-up camera monitor and the system is switched ON using the dashboard mounted FRONT CAMERA/TV switch.

## ON BOARD DIAGNOSTIC TOOL RECEPTACLE

To ease troubleshooting, you can connect a diagnostic tool through the OBD receptacle to access recorded data. The OBD receptacle is located under the dashboard, on the left side.

## AUTOMATIC FIRE DETECTION AND SUPPRESSION SYSTEM (AFSS)

The vehicle may be equipped with an Automatic Fire detection and Suppression System (AFSS).

### AUTOMATIC FIRE SUPPRESSION SYSTEM PANEL

The panel displays the current system status. The protection panel contains “SYSTEM OK”, fire “ALARM” and “TROUBLE” lamps, the audio alarm, the “TEST/RESET” switch, and the “ALARM SILENCE” switch.

The “SYSTEM OK” lamp indicates power is on the system and that there is no trouble conditions present. The “TROUBLE” lamp blinks if there is a fault in the detection circuitry and illuminates solid if there is a fault in the extinguishing circuitry.

When the “TROUBLE” lamp is on, the “SYSTEM OK” lamp will be off and the audible alarm will sound intermittently. The “SYSTEM OK” lamp will flash when the system is low on battery power. Depressing the “TEST/RESET” switch tests the protection panel lamps and audio alarm. The “ALARM SILENCE” switch will disable the audio alarm.

When a fire detector automatically detects a fire, the fire “ALARM” lamp and audio alarm activate. When the Manual Activation Switch is activated, the fire “ALARM” lamp blinks and the audio alarm activates. The lamp will blink until power is cycled to the system.

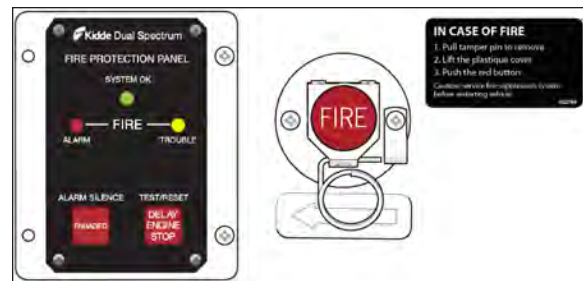


FIGURE 14: AFSS PANEL & MANUAL ACTIVATION SWITCH

### Manual Activation Switch

The manual activation switch allows immediate system activation (extinguisher discharge and engine shutdown) by the driver at any time. Activation of the switch is accomplished by twisting and pulling the tamper seal to remove, lifting the cover and pressing the red “FIRE” button for more than half a second. After the manual activation switch has been activated, the protection panel will blink the fire “ALARM” indicator until power has been cycled to the system.

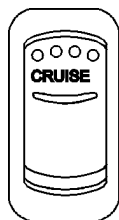
Refer to [“AUTOMATIC FIRE SUPPRESSION SYSTEM \(AFSS\)” on page 5](#) in section *Safety Features and Equipment* for more information.

## CRUISE CONTROL

The cruise control allows you to cruise the vehicle at a desired speed over 30 mph (50 km/h) without having to use the accelerator pedal.

## 4-14 Controls and Instruments

### TURNING THE SYSTEM ON



To operate the cruise control, press the CRUISE rocker switch located on the lateral control panel to the ON position. This turns the system on. The dashboard telltale turns on; you can now set the vehicle at a desired cruising speed. To turn off the system, press the rocker switch to the OFF position.

#### NOTE

The cruise switch and RESUME button do not operate at speeds below 30 mph (50 km/h).

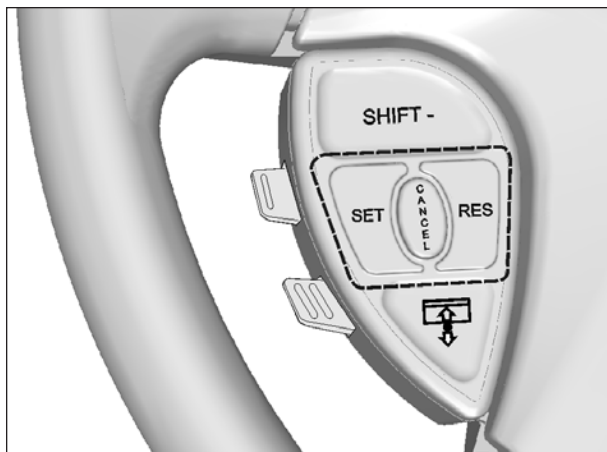


FIGURE 15: CRUISE CONTROL BUTTONS

### SETTING A CRUISING SPEED

Accelerate the vehicle to the desired cruising speed using the accelerator pedal. Press and release the SET button then remove foot from the accelerator pedal. This will set the vehicle cruise speed and store it in memory. The set speed will appear in the driver information display.

#### Increasing Set Speed

The vehicle cruise speed setting can be increased by one of the following methods.

1. Accelerate using the accelerator pedal until the desired cruising speed is reached. Press and release the SET button.

or

2. Press and hold the RES (RESUME) button until the desired cruising speed is reached. When the RES button is released, the new cruising

speed will be stored in the cruise control memory.

or

3. When driving with cruise control, each time the RES button is momentarily depressed, the cruising set speed is raised by 1 mph (2 km/h).

#### NOTE

When driving with cruise control, the vehicle can still be accelerated by depressing the accelerator pedal in the usual manner. Once the accelerator pedal is released, the vehicle will return to the previously set cruising speed.

### Decreasing Set Speed

The vehicle cruise speed setting can be decreased by one of the following methods.

1. Press and hold the SET button until the desired cruising speed is reached. When the SET button is released, the new cruising speed will be stored in the cruise control memory.

or

2. Each brief pressing of the SET button will decrease set cruising speed by 1 mph (2 km/h).

or

3. Slightly apply the service brake and when desired cruise speed is reached, press and release the SET button.

### Canceling The Set Speed

You can cancel the set cruising speed by:

1. Pressing momentarily the CANCEL button;
2. Depressing the brake pedal.

### Automatic Cruise Control Cancellation

The set speed is automatically canceled in any of the following situations:

- The windshield wipers are operating in low or high speed;
- The actual vehicle speed falls below 30 mph (50 km/h).

## Resuming Set Speed

If the set speed is canceled by pressing the CANCEL button or depressing the brake pedal, pressing the RESUME button will restore the speed set prior to cancellation, providing that your speed is above 30 mph (50 km/h).

### NOTE

*When driving downhill with the cruise control on and set, the engine brake or the transmission retarder engage automatically (if previously activated) when the selected cruise speed is exceeded by approximately:*

- 4 mph (7 km/h) with the engine brake activated;
- 0.6 mph (1 km/h) with the transmission retarder activated.

*The engine brake or the transmission retarder is then disengaged when speed has returned near to selected cruise speed.*

*The engine brake will provide low braking power or high braking power depending on which of the two steering wheel engine brake control buttons is activated;*

① = Engine Brake Low

② = Engine Brake High

*The transmission retarder maximum braking level is determined by the retarder hand lever position on the steering wheel.*

### NOTE

*To avoid sudden vehicle hesitation, slightly depress the accelerator pedal before disengaging the cruise control.*

### NOTE

*When the CRUISE rocker switch is released, the cruise control is completely shut off and the cruise speed setting is erased from the cruise control memory.*

### NOTE

*If the engine was stopped and the CRUISE rocker switch was in the ON position, the rocker switch must be reset by turning it OFF then ON again in order for the cruise control to be reactivated.*



### WARNING

Do not use the cruise control when driving speed must be constantly adjusted, such as in heavy traffic or on icy, snow-covered or slippery roads, or on gravel roads.



### WARNING

Do not put the transmission in the neutral (N) position while driving with cruise control. This may cause the engine to over-speed and result in a loss of driving control.

## 4-16 Controls and Instruments

### PREVOST DRIVER ASSIST™

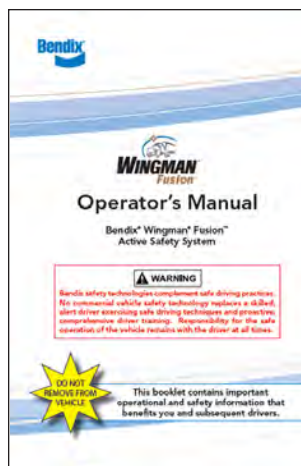
Prevost Driver Assist™ provides what is commonly known in the automotive industry as Advanced Driver Assistance Systems (ADAS). ADAS are meant to assist but not replace the driver. ADAS must be monitored at all times.



#### WARNING

Even with Prevost Driver Assist™ system, the driver must remain alert, react appropriately and in a timely manner, and use good driving practices. The ultimate responsibility for the safe operation of the vehicle remains with the driver at all times.

Be certain that you have read all safety warnings found in **Bendix Wingman Fusion Operator's Manual BW2681** available on Prevost Technical Publications site.



### ASSOCIATED HARDWARE EQUIPMENT

- FLR-21 radar sensor (ACB)
- Head-up display (HUD)
- Lane Departure Warning System (LDW) enable/disable switch
- FLC-20 windshield forward-looking camera (LDW)
- Bendix ESP EC-80 Controller
- Instrument panel DID (telltale, warning pop-ups and system status pictograms)

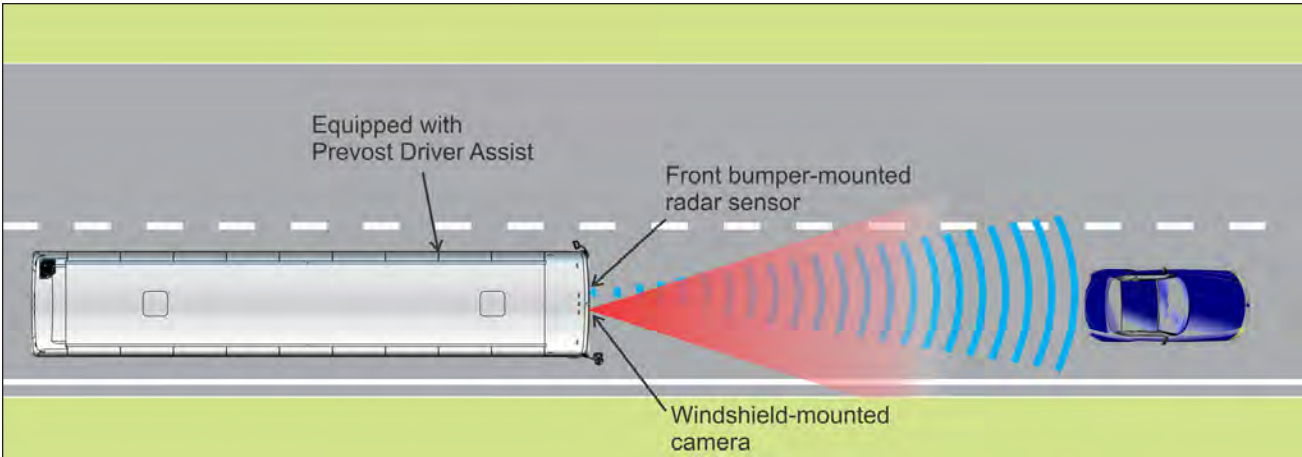


FIGURE 16: PREVOST DRIVER ASSIST™ SYSTEM USES A CAMERA AND RADAR SENSOR

**PREVOST DRIVER ASSIST™ CONSISTS OF THE FOLLOWING SYSTEMS AND FEATURES**

| DRIVING CONTROL ASSISTANCE       |  |
|----------------------------------|--|
| Adaptive Cruise with Braking ACB | Assists with acceleration and/or braking to maintain a prescribed distance between your vehicle and the vehicle ahead in your lane of travel. <ul style="list-style-type: none"> <li>• FDA Following Distance Alert</li> <li>• IA Impact Alert</li> </ul>  |
| COLLISION WARNINGS               |  |
| Lane Departure Warning LDW       | Alerts the driver as the vehicle unintentionally approaches or crosses lane markers.   |
| Head-Up Display HUD              | Projects a visual forward collision warning into the driver's forward line of sight.   |
| COLLISION INTERVENTION           |  |
| Forward Collision Mitigation FCM | Detects potential collision with stationary or moving vehicles in the lane ahead while the vehicle is traveling forward, provides forward collision warning and automatically applies the brakes to lessen the severity of an impact. <ul style="list-style-type: none"> <li>• SVB Stationary vehicle braking</li> </ul> |

## 4-18 Controls and Instruments

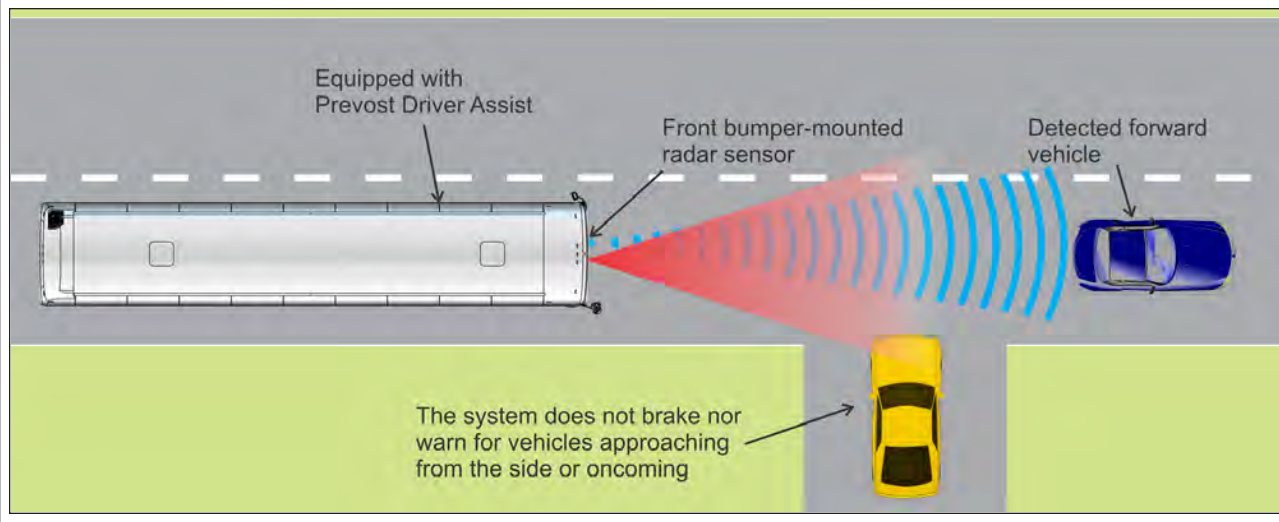
| FEATURES   | ACTIVE EVEN IF ACB IS OFF OR CRUISE SPEED NOT SET |
|--|---|
| FDA Following Distance Alert (warnings only)   | Yes<br>If speed above 36 mph (58 km/h)            |
| IA Impact Alert (warnings only)  | Yes<br>If speed above 15 mph (24 km/h)            |
| LDW Lane Departure Warning   | Yes<br>If speed above 36 mph (58 km/h)            |
| FCM Forward Collision Mitigation (including SVB Stationary Vehicle Braking) (warnings & braking) | Yes<br>If speed above 15 mph (24 km/h)            |



### WARNING

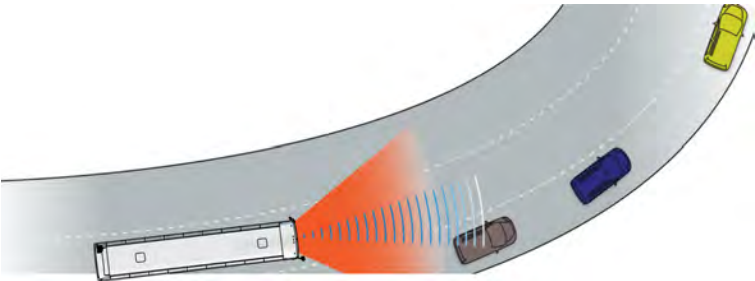
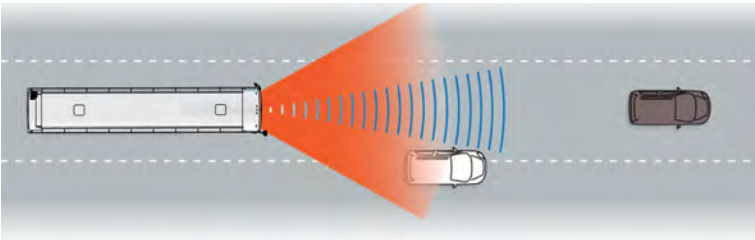
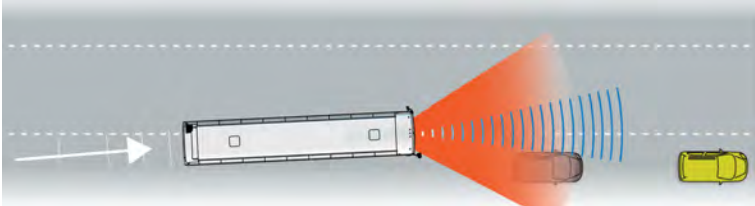
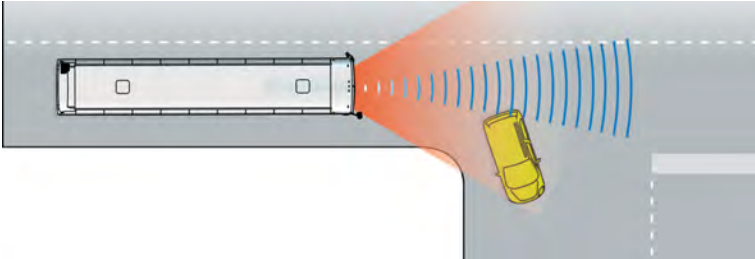
The PrevoSt Driver Assist™ system reacts **ONLY** to vehicles that are **stationary or moving in the same direction as your vehicle**.

The PrevoSt Driver Assist™ system **DOES NOT** respond to side-to-side moving traffic, or oncoming traffic. The system will not slow your vehicle or provide an alert as you approach vehicles in these circumstances.



**POTENTIALLY CHALLENGING SITUATIONS FOR THE PREVOST DRIVER ASSIST™ SYSTEM**

The following examples illustrate situations that may issue an alert or braking in a manner not consistent with your expectations. The Prevost Driver Assist™ system may unexpectedly issue warnings, apply braking, or not respond.

| <b>CHALLENGING SITUATION EXAMPLES</b>  |  |
|--|--|
|    | <p>Driving through a curve or an exit ramp</p>             |
|   | <p>Other vehicles partially inside your lane of travel</p> |
|  | <p>Lane changes</p>  |
|  | <p>Turning vehicles</p>                                    |

**LANE DEPARTURE WARNING LDW**

Using the FLC-20 windshield forward-looking camera, the Lane Departure Warning system (LDW) monitors the vehicle position in its lane and alerts the driver as the vehicle unintentionally approaches or crosses lane

## 4-20 Controls and Instruments

markers thru audible and visual warnings. **The driver should immediately correct the vehicle tracking and maintain position in the lane.**

When changing lanes, the driver must use the turn signals.

### LDW Activation

The Lane Departure Warning system is active whenever the vehicle is traveling above 36 mph (58 km/h). LDW is active no matter if the ACB is OFF or speed not set.

### Temporarily Disabling The Lane Departure Warning (LDW)




To avoid erroneous LDW warnings in areas such as the work zone where the road markings present might cause false alerts, LDW system can be disabled by the driver using the enable/disable switch. LDW system will reactivate automatically after a delay of 15 minutes or a transition from OFF to ON of the ignition key or upon pressing of the enable/disable switch a second time.



FIGURE 17: LDW ENABLE/DISABLE SWITCH


### LDW Status Line Pictograms Description

The following pictograms appear in the DID status line to confirm that the system is active and currently tracking the driving lane.

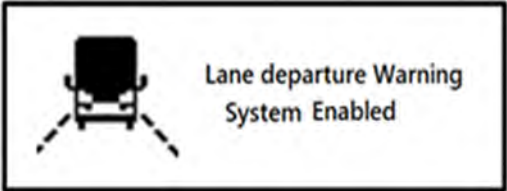
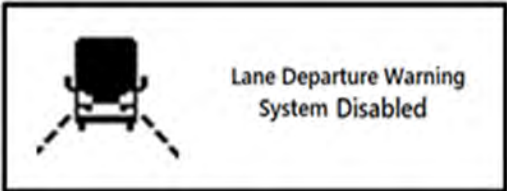


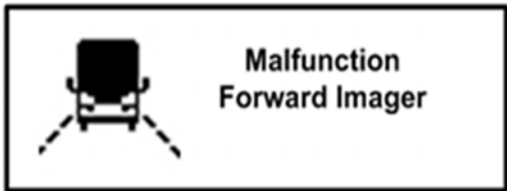
| PICTOGRAM   | DESCRIPTION   |
|---|---|
|  | Actively tracking lane markings on both sides of current lane |
|  | Currently tracking lane marking on the left side only         |
|  | Currently tracking lane marking on the right side only        |

The following pictogram appears in the DID status line to warn that the system IS NOT currently tracking the driving lane.










| PICTOGRAM   | DESCRIPTION   |
|---|---|
|  | LDW system initializing during the start-up or tracking not available   |
| none  | If none of the LDW status pictograms appear on the DID status line and the driver has not pressed the LDW enable/disable switch, this indicates that the system using the FLC-20 forward-looking camera has detected a DTC (diagnostic troubleshooting code) and the system should be serviced at the earliest opportunity. |

**LDW Popup Messages Definition**

| POPUP MESSAGE   | DESCRIPTION/AUDIBLE ALARM  |
|---|--|
|    | LDW system enabled – the LDW system is currently tracking the driving lane.  |
|   | LDW system disabled – the LDW system IS NOT currently tracking the driving lane.   |
|  | The vehicle is about to cross the right lane marker.<br><br>audible warning: TOK – TOK   |
|  | The vehicle is about to cross the left lane marker.<br><br>audible warning: TOK – TOK  |
|  | Indicates a malfunction of the forward-looking camera. The LDW system tracking might be disabled or not reliable.<br><br>The driver can acknowledge and turn off this popup message using Esc (escape) button on the steering wheel. |

## 4-22 Controls and Instruments

|   |  |
|---|--|
|  <p><b>Malfunction<br/>Check camera<br/>for obstructions</b></p>   | <p>Indicates a malfunction of the LDW system camera. The LDW system tracking might be disabled or not reliable.</p> <p>Stop the vehicle and check if something is obstructing the camera.</p> <p>The driver can acknowledge and turn off this popup message using Esc (escape) button on the steering wheel.</p> |
|  <p><b>Malfunction<br/>Brake Switch</b></p>                        | <p>Indicates a malfunction of the LDW system brake switch. The LDW system tracking might be disabled or not reliable.</p> <p>The driver can acknowledge and turn off this popup message using Esc (escape) button on the steering wheel.</p>   |
|  <p><b>Malfunction<br/>Turn Signal</b></p>                         | <p>Indicates a malfunction of the directional turn signals. The driver can acknowledge and turn off this popup message using Esc (escape) button on the steering wheel.</p>  |
|  <p><b>Input switch<br/>stuck low</b></p>                          | <p>Indicates a malfunction of the LDW system input switch.</p> <p>The driver can acknowledge and turn off this popup message using Esc (escape) button on the steering wheel.</p>  |
|  <p><b>Network Error</b></p>                                     | <p>Indicates a loss of communication on the vehicle data network. The LDW system tracking might be disabled or not reliable.</p> <p>The driver can acknowledge and turn off this popup message using Esc (escape) button on the steering wheel.</p>  |
|  <p><b>Unknown<br/>Vehicle Speed</b></p>                         | <p>Indicates the current vehicle speed is unknown. The LDW system tracking might be disabled or not reliable.</p> <p>The driver can acknowledge and turn off this popup message using Esc (escape) button on the steering wheel.</p>   |
|  <p><b>Lane Departure<br/>Warning System<br/>Malfunction</b></p> | <p>Indicates a malfunction of the LDW system. The LDW system tracking is not available.</p>  |

## FORWARD COLLISION MITIGATION FCM

The Forward Collision Mitigation system (FCM) detects potential collisions while the vehicle is traveling forward, provides warnings to the driver and when needed, automatically applies up to 66% of the braking power to lessen the severity of an impact.

The FCM system is ready to intervene whenever the vehicle is traveling at speed above 15 mph (24 km/h). It operates independently of the vehicle ACB and will intervene even if the cruise control is turned off or there is no cruise set speed.

The FCM system is enhanced with the use of the FLC-20 windshield forward-looking camera. This camera increases the performance of the collision mitigation system by optically detecting a forward object as a vehicle and confirming with the ACB radar sensor its position within the lane of travel.

If the forward vehicle is stationary, the FCM system will apply up to 66% of the braking power. The maximum speed reduction is about 25 mph / 40 km/h. Note that this feature will not bring the vehicle to a complete stop.



### CAUTION

#### **Pedestrians, Animals, Non-metallic, or Limited-metallic Objects**

The Prevost Driver Assist™ system **will not** warn or react to pedestrians, animals, and non-metallic objects. The system may not warn or react to limited-metallic objects (such as recreational vehicles, horse-drawn buggies, motorcycles, logging trailers, etc.).

### Head-Up Display HUD

The FCM system is enhanced with a Head-Up Display (HUD) LED warning. The HUD project an intensive red light that is reflected in the windscreen to warn the driver when the FCM detects potential collision.

HUD Diagnostic: At startup, the HUD warning LED shall be diagnosed for failures such as open circuit, short to battery and short to ground. This shall be performed by activating the LED for a short time.

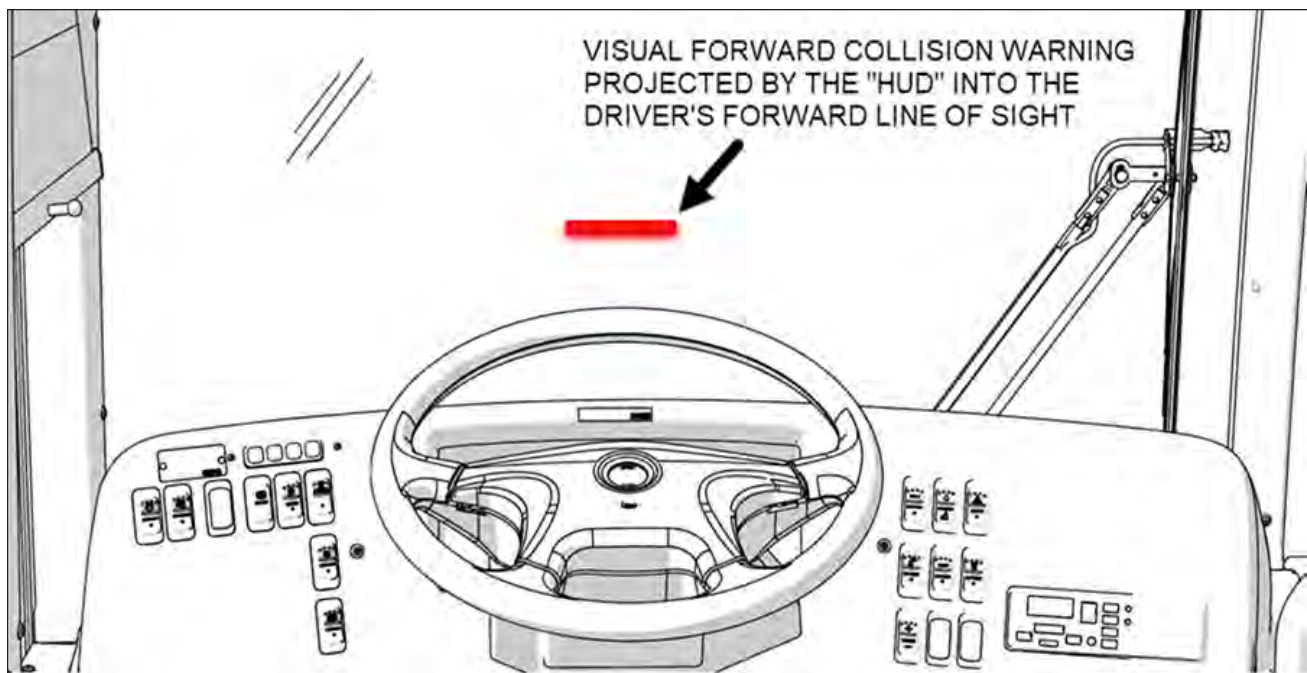


FIGURE 18: HEAD-UP DISPLAY PROJECTED VISUAL WARNING

### ADAPTIVE CRUISE WITH BRAKING ACB

Adaptive Cruise with Braking (ACB) is a cruise control that not only maintains the set speed, but will also intervene, as needed, to help the driver maintain a set following distance behind a detected forward vehicle by reducing speed as necessary. As soon as the forward vehicle is at a safe distance, the coach will resume to the cruise set speed.

## 4-24 Controls and Instruments

### NOTE

The following paragraphs briefly sum up the information concerning the operation and function of the ACB. Before driving the vehicle, be certain that you have read and that you fully understand each step of the driving and handling information found in Bendix Wingman Fusion Operator's Manual BW2681. The driver should fully understand all the audible alerts and visual indicators that the system provides. Bendix Wingman Fusion Operator's Manual BW2681 (available on Prevest web site and included on the Technical Publications USB key).



### WARNING

Even with ACB, the driver must remain alert, react appropriately and in a timely manner, and use good driving practices. Ultimate responsibility for the safe operation of the vehicle remains with the driver at all times.

Be certain that you have read all safety warnings found in Bendix Wingman Fusion Operator's Manual BW2681.

The driver will benefit all the audible and visual warnings that the system provides whether or not ACB is turned on. In addition to the audible and visual warnings, when the ACB is turned on and a **cruise speed is set**, the driver benefits from active interventions like engine throttle reduction, engine brake application and service brake application **to help maintain a set following distance**.



### WARNING

Adaptive Cruise with Braking must be used only in the same conditions that are normally recommended for ordinary cruise control. Refer to "Regular Cruise Control" paragraph.

## TURNING OFF THE ACB SYSTEM

You can turn off the ACB system, simply by applying service brakes, setting the CRUISE rocker switch to the OFF position or pressing the cruise control CANCEL button on the steering wheel.

### NOTE

*Whenever the service brakes are applied by intervention of the ACB or by the driver, normal cruise will automatically be canceled. The driver must resume or set the cruise mode in order for the vehicle to throttle up.*

## TURNING THE ACB SYSTEM ON

Activation of the Adaptive Cruise with Braking is similar to the regular cruise control activation. Press the CRUISE rocker switch to the ON position, accelerate the vehicle to the desired cruising speed and then, press the SET button. ACB is now engaged with the set following distance and driver warning features. Whenever the cruise control is engaged, the ACB is also engaged. You cannot engage the cruise control alone, without engaging the ACB features.

## MAINTAINING A SET FOLLOWING DISTANCE

Using a radar sensor mounted to the front bumper, the ACB system measures the distance between the coach and the forward vehicle and intervenes to help maintain a safe set following distance behind the vehicle. This feature engages automatically once the driver turns on the ACB and sets cruise speed.

Following distance refers to the time gap, measured in seconds, between the coach and the vehicle ahead. The actual physical distance between the coach and the vehicle ahead will vary based on your set cruise speed; although the set time gap remains the same for all set cruise speeds. Prevest's default set time gap is 1.7 seconds.

With cruise control engaged and a cruise speed set, you are maintaining a set following distance behind the vehicle in front of you (the system DOES NOT respond to side-to-side moving traffic or oncoming traffic.).

**If the vehicle in front of the coach slows down** below your cruise control set speed, the system will progressively intervene as follows, in this order:

1. Reduce the engine throttle;
2. Apply the engine brake;
3. Apply about 30% of the service brakes available braking power in an attempt to maintain the set following distance.

The driver must apply additional braking power when required, to avoid collision or to maintain a safe distance from the vehicle ahead.

### **NOTE**

*If the ACB is actively decelerating or braking the coach in an attempt to maintain the set following distance at the moment when the driver cancels the ACB system, the ACB system will continue deceleration or braking intervention until a safe following distance is established, then will cancel.*

*Even though the cruise control doesn't operate at speeds below 30 mph (50 km/h), the ACB system will continue deceleration or braking intervention in an attempt to maintain the set following distance if the coach speed reduces to less than 30 mph (50 km/h).*

**If the vehicle ahead slows below your cruise control's set speed**, but then accelerates away, and the ACB system did not need to use the service brakes as it managed the intervention, the coach will automatically accelerate back to the original cruise control set speed, and again maintain a set following distance behind the forward vehicle.

### **NOTE**

*The maximum radar range is approximately 500 feet (150 meters). Rain, snow, fog, ice and other severe weather conditions may affect the performance of the ACB system and shorten radar range.*

*As part of your pre-trip vehicle inspection, check to see that there is no mud, snow, ice build-up or other obstruction in front of the radar sensor. You should inspect the radar sensor mounting and remove any obstruction that may impair the sensor functioning.*

## **DRIVER WARNINGS**




Before using the ACB, the driver should fully understand all the audible and visual warnings that the system provides. Any audible warning (beeping or tone) means that your vehicle is too close from the vehicle ahead.

## **DASHBOARD TELLTALE**

When ACB is turned on and a cruise speed is set, if the forward vehicle is detected (in range) by the radar, the FORWARD VEHICLE DETECTED telltale light will illuminate. This is an indication to the driver that the forward vehicle is being tracked, that the ACB is actively managing the distance between the coach and the vehicle ahead and that the ACB system may automatically intervene to maintain the set following distance. There are three types of warnings with this telltale light.

| FORWARD VEHICLE<br>DETECTED telltale light | COLOR | DESCRIPTION |
|--|-------|-------------|
|--|-------|-------------|

## 4-26 Controls and Instruments

|   |              |   |
|---|--------------|---|
|  | green        | The forward vehicle is detected (in range)  |
|  | red flashing | <b>Impact alert.</b> The forward vehicle is too close to follow safely or a metallic stationary object such as a stopped or stalled vehicle in your lane of travel is detected. The driver must intervene to avoid a collision. |
|  | red solid    | ACB system malfunction. The ACB system and the alert functions are not available.   |

### Speedometer Leds

With the cruise control engaged and a cruise speed set, a green LED illuminates above the cruise control set speed on the speedometer.

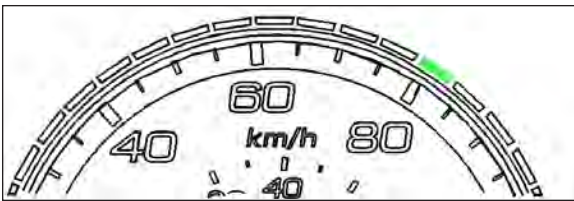


FIGURE 19: THE CRUISE SET SPEED IS 80 KM/H

With a cruise speed set, the vehicle ahead slows moderately. The system will display to the driver the approximate speed of the vehicle ahead with yellow LEDs above the speedometer.

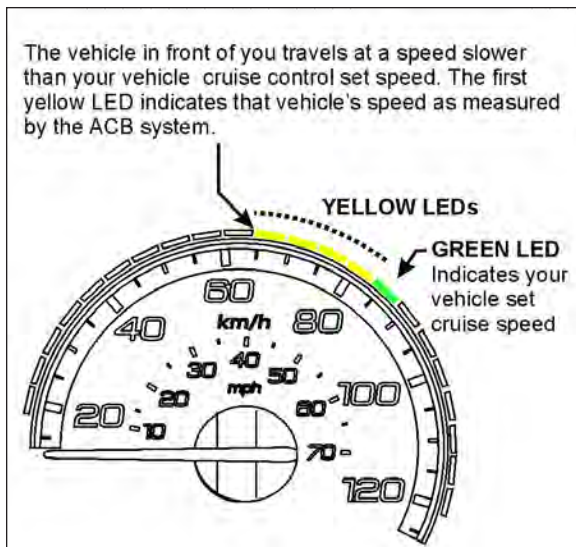


FIGURE 20: EXAMPLE OF THE SPEEDOMETER LED DISPLAY WHEN THE FORWARD VEHICLE IS SLOWER WHILE THE COACH TRAVELS WITH THE ACB CRUISE CONTROL ON AND SET

### FOLLOWING DISTANCE ALERT (FDA)

Following Distance Alert is always active whenever the coach is moving to a speed greater than 36 mph (58 km/h), whether or not ACB is turned on.

Following Distance Alert provides both audible and visual warnings whenever the distance between the coach and the forward vehicle is less than the set distance and getting closer. Once the audible warning is given, the

driver must increase the distance between the coach and the vehicle ahead until the audible warning stops or maneuver clear of the forward vehicle.



**WARNING**

Active interventions of ACB to maintain safe following distance (throttle reduction, engine brake application, service brakes application) are only operational when the ACB is engaged with a cruise speed set.

**IMPACT ALERT (IA)**

Impact Alerts are always operational when the vehicle is moving above 15 mph (24 km/h) whether or not ACB is turned on.

The Impact Alert warning is the most severe warning issued by the ACB system. This alert indicates that the driver must take immediate evasive action by applying more braking power and/or steering clear of the vehicle ahead to potentially avoid or lessen the severity of a collision. **Collision Mitigation Braking CMB** applies vehicle braking to help avoid or lessen the severity of a collision with a forward vehicle.

The Impact Alert is also applicable to stationary metallic objects such as stopped or stalled vehicles. This alert provides a warning given up to 3.0 seconds before a potential collision with a stationary metallic object in the coach's lane of travel. The driver can either slow down or maneuver in an attempt to avoid the object.

The Impact Alert will only warn and will not actively decelerate or brake the coach when approaching stationary objects.



**WARNING**

Active interventions of ACB to maintain safe following distance (throttle reduction, engine brake/retarder application, service brakes application) are only operational when the ACB is engaged with a cruise speed set.

**BRAKE OVERUSE WARNING**



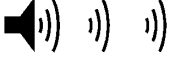
ACB provides a warning when the system is intervening and using the service brakes excessively. Overuse of the foundation brakes can lead to the brakes overheating and a potential loss of braking performance from brake fade. For example, the use of ACB on downhill runs may cause this alert to be activated. It is recommended that ACB be disengaged on downhill grades. The driver should use appropriate gearing and brake techniques, and not rely on ACB, on downhill grades.





If the driver does not respond to the Brake Overuse Warning after a brief delay, the ACB will switch off.


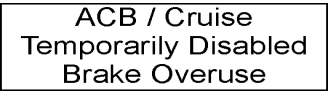

**FOLLOWING DISTANCE ALERT**

|           |  |
|-----------|--|
| CONDITION | The Following Distance Alert feature is only available when the coach speed is greater than 36 mph (58 km/h), whether or not ACB is engaged. |
|           | The forward vehicle is slowing down and the distance between your vehicle the coach and the forward vehicle is less than the set distance.   |

## 4-28 Controls and Instruments

|                       |   |   |
|-----------------------|---|---|
| ACTIONS BY ACB SYSTEM | “Distance Alert” pop-up message appears on the DID  |  |
|                       | The speedometer LEDs illuminate in <b>red</b>   |  |
|                       | If the vehicles remain too close from each other for more than 15 seconds, an audible warning will sound ( <b>beeping</b> ) |  |

| <b>IMPACT ALERT</b>   |  |   |
|-----------------------|--|---|
| SITUATION             | ACB system detects a risk of collision with a forward-moving vehicle or a stationary metallic object in your lane of travel. |   |
| ACTIONS BY ACB SYSTEM | On the dashboard, the Forward Vehicle Detected telltale <b>flashes in red</b>  |    |
|                       | “Impact Alert” pop-up message appears on the DID   |    |
|                       | The speedometer LEDs <b>flash in red</b>   |   |
|                       | An audible warning will sound ( <b>continuous modulating tone</b> )  |  |

| <b>BRAKE OVERUSE WARNING</b> |  |   |
|------------------------------|--|---|
| SITUATION                    | ACB system is using the service brakes excessively to maintain the set following distance (for example, the use of ACB on long, steep downhill runs). Excessive application of the service brakes can cause the brakes to overheat resulting in increasing stopping distances. |   |
| ACTIONS BY ACB SYSTEM        | After a brief delay, the ACB system will stop functioning and be disabled.   |   |
|                              | On the dashboard, the Forward Vehicle Detected telltale <b>illuminates in red</b>  |  |
|                              | “ACB/Cruise Temporarily Disabled Brake Overuse” pop-up message appears on the DID  |  |
|                              | “ACB Not Available” pictogram appears on the DID status line   |  |



### SELF-DIAGNOSTIC AT START-UP

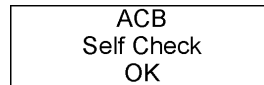
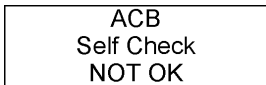
Initiate the self-diagnostic as follows:

- The engine must be running since at least 15 seconds with the parking brake applied.
- Trip the CRUISE rocker switch located on the lateral control panel from OFF to ON position.

The following sequence will begin:

1. Pop-up message “Impact Alert” will show in the DID;
2. The speedometer LEDs will flash in red;
3. FORWARD VEHICLE DETECTED telltale will flash in red;
4. The Impact Alert audible alarm will sound.

At the end of the self-diagnostic sequence, pop-up message « ACB SELF-CHECK OK » will show on the DID if the system functions properly or « ACB SELF-CHECK NOT OK » if a fault condition is detected.



### SYSTEM MALFUNCTION

In case of system malfunction, visual warnings will illuminate in the instrument cluster or the driver information display to warn the driver that the ACB is disabled. In that situation, the Impact Alert and Distance Alert functions are not available.

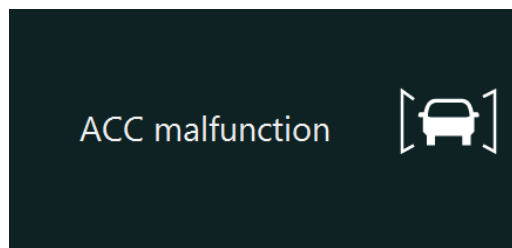
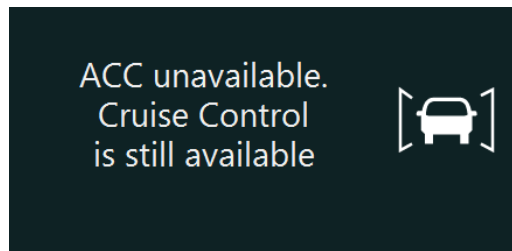
If the ACB is not available, the FORWARD VEHICLE DETECTED telltale light will illuminate in red and will stay on and “ACB NOT AVAILABLE” pictogram will appear on the DID status line.



FORWARD VEHICLE DETECTED telltale light



ACB NOT AVAILABLE pictogram

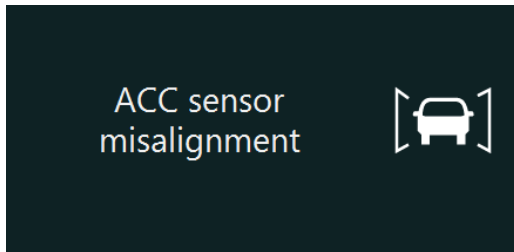


## 4-30 Controls and Instruments

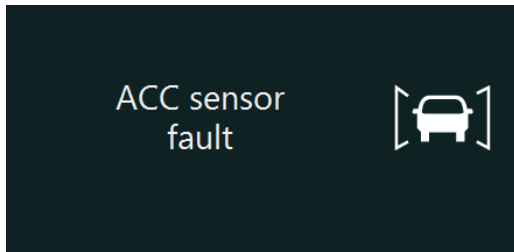
---

For proper functioning of the system, the radar must be perfectly aligned and not blocked. If a radar fault condition is detected, one of the following pop-up messages will show in the DID.

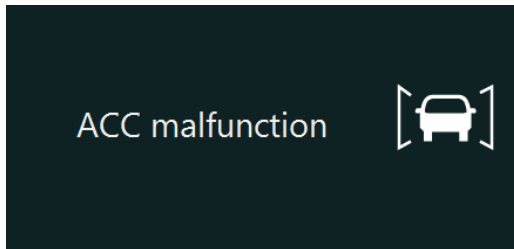
### ACB SENSOR (RADAR) MISALIGNMENT



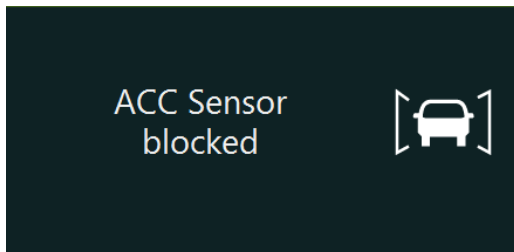
### ACB SENSOR (RADAR) FAULT



### ACB DATA LINK FAILURE



### ACB SENSOR (RADAR) BLOCKED



## WHAT TO EXPECT WHEN USING THE PREVOST DRIVER ASSIST™ SYSTEM

**PART 1** All driving scenarios (cruise control is either ON or OFF)

### What to Expect

| Situation  | Typical system indication/alerts   | Typical system actions/cautions   |
|--|--|---|
| <b>Stationary objects/vehicles ahead in your lane of travel</b>  |  |   |
| A stationary ( <b>non-vehicle</b> ) object is present ahead in the lane in which the truck is traveling.   | none   | The driver must immediately act to potentially avoid, or lessen the severity of, a collision.   |
| A stationary motor vehicle is detected ahead in your lane.<br><i>Factors that can potentially affect the system's ability to identify a vehicle include: if the vehicle is not a licensed motorized vehicle; or certain types of trailers.</i> | If the vehicle is traveling above 10 mph / 16 km/h, a stationary vehicle alert may be issued up to three-and-a-half (3.5) seconds prior to impact.   | The driver must immediately act to potentially avoid, or lessen the severity of, a collision. If a collision is likely to occur, Prevost Driver Assist™ system can provide a warning and/or apply the vehicle service brakes. |
| <b>Moving objects/vehicles ahead in your lane of travel</b>  |  |   |
| Your vehicle comes up fast behind a slower-moving detected forward vehicle.  | The Following Distance Alert (FDA) will sound and a visual message typically appears on the DID. Depending on how close your vehicle approaches, the system may initiate an Impact Alert (IA) warning. | None.<br>You must respond as needed.  |
| The detected forward vehicle slows rapidly.  | The Following Distance Alert (FDA), or Impact Alert (IA) warning (continuous tone) will sound and a visual message typically appears on the DID.   | None. You must respond as needed. If a collision is likely to occur, the collision mitigation feature will apply your vehicle's brakes.   |
| A pedestrian, deer, or dog runs in front of your vehicle, or any organic or non-metallic object is in front of your vehicle.   | None   | None.<br>You must respond as needed.  |
| Another vehicle crosses the road perpendicular to your path of travel – such as intersections.   | None   | None.<br>You must respond as needed.  |
| A collision mitigation braking event has begun and you, as the driver, steers into an adjacent lane to avoid the forward vehicle.  | None   | Prevost Driver Assist™ system will continue to apply the brakes if it detects another vehicle ahead in the new traffic lane posing a threat.  |
| <b>Lane Departure Warning System Active (LDW pictogram being displayed)</b>  |  |   |
| Your vehicle signals a lane change and crosses a lane marking.   | None   | None  |
| Traveling below 36 mph (58 km/h), your vehicle crosses a lane marker (without the corresponding turn signal activated).  | None   | None.<br>You must respond as needed.  |

## 4-32 Controls and Instruments

|  |  |   |
|--|--|---|
| <p>Traveling above 36 mph (58 km/h), your vehicle departs your lane of travel without the corresponding turn signal activated.</p> |  | <p>None.<br/>You must respond as needed.<br/>(use the turn signal when changing lanes and/or keep your vehicle within the lane markings).</p>   |
| <p><b>PART 2</b> ACB cruise control is ON and speed is SET</p>   |  |   |
| <p><b>What to Expect</b></p>   |  |   |
| <p>Situation</p>   | <p>Typical system indication/alerts</p>  | <p>Typical system actions/cautions</p>  |
| <p>Interactions with vehicles ahead in your lane of travel</p>   |  |   |
| <p>With no detected forward vehicle.</p>   | <p>None</p>  | <p>Your vehicle maintains the set speed.</p>  |
| <p>With a detected forward vehicle.</p>  | <p>The cruise control ON indicator is illuminated and the detected forward vehicle telltale is illuminated.</p>                                    | <p>The Adaptive Cruise with Braking feature will maintain the set speed and following distance.</p>   |
| <p>The detected forward vehicle slows moderately.</p>  | <p>The Following Distance Alert (FDA) will sound and a visual message typically appears on the DID.</p>  | <p>You must respond as needed.<br/><br/>If the system intervenes, the vehicle throttle will be reduced; the engine retarder engaged; and the service brakes applied, in that order to maintain the set following distance.<br/><br/><i>NOTE: When the ACB applies the service brakes, cruise control will automatically pause, and will cancel if vehicle speed falls below the minimum set speed or the driver manually depresses the brake pedal.</i></p>       |
| <p>The detected forward vehicle slows rapidly.</p>   | <p>The Impact Alert (IA) warning will sound and a visual message typically appears on the DID. The Following Distance Alert may also be heard.</p> | <p>You must respond as needed.<br/><br/>If the system intervenes, the vehicle throttle will be reduced; the engine retarder engaged; and the foundation brakes applied, in that order to maintain the set following distance.<br/><br/><i>NOTE: When the ACB applies the foundation brakes, cruise control will automatically pause, and will cancel if vehicle speed falls below the minimum set speed or the driver manually depresses the brake pedal.</i></p> |

|   |   |  |
|---|---|--|
| A detected forward vehicle cuts in front of your vehicle and speeds away. | Following Distance Alerts (FDAs) may be given to you, depending on the exact system configuration that has been set for the vehicle, and how close the vehicle cuts in front. | Vehicle maintains set speed.   |
| <b>Downhill Grades</b>  |   |  |
| Going down a grade with a detected forward vehicle.                       | DO NOT USE cruise control on downhill grades.   | DO NOT USE cruise control on downhill grades. Brake overuse may occur. |
| Cruise control should NOT be used on downhill grades.                     |   |  |



**WARNING**

*The section preceding shows examples of situations and typical Prevost Driver Assist™ system responses. However, the chart does not attempt to cover all possible situations.*

Due to the inherent limitations of radar and camera technology, the enhanced Collision Mitigation Technology – on rare occasions – may not detect moving vehicles or stationary vehicles in your vehicle’s lane of travel. Alerts, warnings, or brake interventions may not occur.

Due to the inherent limitations of radar and camera technology, the enhanced Collision Mitigation Technology – on rare occasions – may react to moving vehicles not in your vehicle’s lane of travel. Alerts, warnings, or brake interventions may occur.

**HOW YOUR ACTIONS IMPACT THE PREVOST DRIVER ASSIST™ SYSTEM**

| Your Action   | Reactions of the Prevost Driver Assist™ system  |
|---|---|
| If you, the driver, do this:  | Expect the Prevost Driver Assist™ system to do this:  |
| Step on the brake (during a collision mitigation event).                    | As the driver, you are always in control and are able to apply full braking power.  |
| Step aggressively on the accelerator (during a collision mitigation event). | As the driver, you are always in control. Your actions override any Prevost Driver Assist™ system actions. NOTE: If cruise control is engaged, it will be overridden until the accelerator is released; then cruise control will resume the original set speed automatically. |
| Step on the brake (when in cruise).   | Cruise control will be canceled.  |
| Step on the accelerator (when in cruise).                                   | Cruise control will be overridden until the accelerator is released; then cruise control will resume the original set speed automatically.  |
| Switch ON the cruise control.   | Nothing. The Active Cruise with Braking (braking to maintain a set following distance) feature will not engage until the driver sets the cruise control speed.  |
| Switch OFF the cruise control.  | The Active Cruise with Braking feature will turn off; the collision mitigation feature remains active and ready to intervene. You, the driver, will continue to hear all alerts as needed.  |
| Set the cruise control speed.   | The Active Cruise with Braking feature is automatically activated, and your vehicle maintains set speed and following distance behind the vehicle ahead in your lane of travel.   |

## 4-34 Controls and Instruments

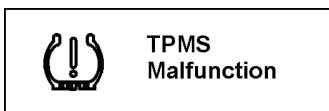
| Your Action                             | Reactions of the PrevoSt Driver Assist™ system  |
|---|---|
| If you, the driver, do this:            | Expect the PrevoSt Driver Assist™ system to do this:  |
| Cover or block the radar or camera.     | <p>The PrevoSt Driver Assist™ system performance will be diminished, or disabled, when either the radar or the camera becomes blocked. An alert will be issued to alert the driver to indicate this condition.</p> <p><b>Radar:</b></p> <p>Radar blocked will be indicated through an alert and will disable the radar-based functions as follows:</p> <ul style="list-style-type: none"> <li>- Loss of forward-moving vehicle braking;</li> <li>- Loss of ACB. The camera based function LDW will remain.</li> </ul> <p><b>Camera:</b></p> <p>Camera blocked will be indicated through an alert and will disable all camera-based functions as follows:</p> <ul style="list-style-type: none"> <li>- Reduced braking performance on moving vehicle (speed reduction 15 mph / 24 km/h maximum);</li> <li>- Loss of LDW.</li> </ul> <p>The radar-based function ACB will remain.</p> |
| Use normal cruise control “+/-” switch. | Vehicle speed increased (+) or reduced (-) to achieve the new set speed while actively maintaining the following distance with the vehicle ahead, if one is present within 500 feet / 152 meters.   |

## TIRE PRESSURE MONITORING SYSTEMS (TPMS)

Two versions of tire pressure monitoring system are available in option, TPMS-Lite and the On-Screen TPMS

### SYSTEM MALFUNCTION

In case of system malfunction, the following warning pop-up message will show on the DID to warn the driver that the TPMS might be disabled or unreliable. Refer to Appendix D TPMS Troubleshooting Guide for further details.



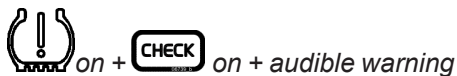
### TPMS-LITE VERSION

TPMS-Lite provides the safety and convenience of a TPMS in a discreet way. Low pressure and high temperature warning thresholds are factory set. This system has no dedicated display.

### Instrument Cluster Alarms And Warnings

Visual and audible warnings turn on to indicate either a low tire pressure or high tire temperature through three different warning conditions:

#### 1- LOW TIRE PRESSURE WARNING



Indicates that tire pressure has reached a critical threshold. This alarm will trigger if a tire pressure falls below 40 psig. **Stop the vehicle as soon as possible.**

#### 2- HIGH TIRE TEMPERATURE WARNING



A high temperature warning will trigger if a tire temperature rises above 194°F (90°C). **You should stop the vehicle as soon as possible and check your tires.**

#### 3- HIGH TEMPERATURE ALARM



Indicates a critically high tire temperature. A high temperature alarm will trigger if a tire temperature rises above 212°F (100°C). **Stop the vehicle as soon as possible.**

See also "[TPMS-LITE](#)" on page 4 in Appendix D.

### ON-SCREEN TPMS VERSION

This system is a sensing device designed to identify and display tire operating data and activate an alert or warning when pressure or temperature irregularities are detected.

#### NOTE

*It is the responsibility of the driver to react promptly and with discretion to alerts and warnings. Abnormal tire inflation pressures should be corrected at the earliest opportunity.*

### Instrument Cluster Alarms And Warnings

Visual and audible warnings turn on to indicate either a low tire pressure or high tire temperature through two different warning conditions:

#### 1- LOW TIRE PRESSURE WARNING



Indicates a low tire pressure. Refer to the dedicated display to determine whether the warning condition is critical or not.

#### 2- HIGH TIRE TEMPERATURE WARNING

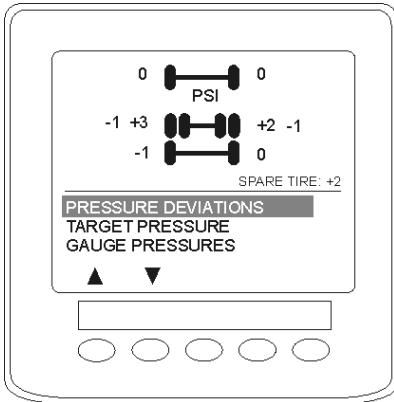


A high temperature warning will trigger if a tire temperature rises above 194°F (90°C). **You should stop the vehicle as soon as possible and check your tires.**

### Dedicated Display

The TPMS display knows where the sensors are located. It receives the raw temperature and pressure readings from the TPMS receiver, it reads several signals from the vehicle and does the calculation required to generate the various screens.

## 4-36 Controls and Instruments



**FIGURE 21: ON-SCREEN TPMS DEDICATED DISPLAY**

When no readings have been received for a tire location or when the received data correspond to a parameter range defined as unavailable, then the reading is considered as not available and appears as two dash lines “--”.

The TPMS display is initially configured to define how many axles and running tires are present on the vehicle. For current Prevost vehicle models, there are two axles / tire configurations. These configurations are:

**CONFIGURATION 1:** Axle 1 (Front) Two tires, Axle 2 (Drive) 4 tires, Axle 3 (Tag) 2 tires.

**CONFIGURATION 2:** Axle 1 (Front) Two tires, Axle 2 (Drive) 2 tires (super Singles), Axle 3 (Tag) 2 tires.

The TPMS display is also configured with several other parameters, including threshold levels for the alarms.

The TPMS display turns OFF when the ignition key is switched OFF.

### Operation

The system will monitor all vehicle tires (6 or 8) plus the spare tire when a spare is supplied.

#### **NOTE**

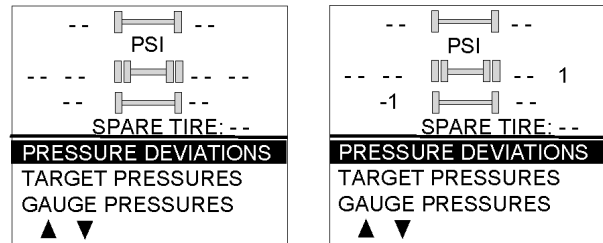
*Some vehicle models do not come with a spare tire.*

There are two configurations of vehicle tires to be supported. One configuration (the most common) consists of 8 tires total: two tires on the front axle, 4 tires on the drive axle and 2 tires on tag axle. All screen figures shown in this document relates to this vehicle configuration. The second tire configuration consist of 6 tires total: 2 tires on the

front axle, 2 tires on the drive axle (super single tires) and 2 tires on the tag axle. The vehicle tire configuration is selected with a parameter (Refer to ["TIRE PRESSURE MONITORING SYSTEM" on page 6](#) in *Section 7 Safety Features and Equipment* for more information). When the display is configured for 6 tires, the drive axle tires appears as one large tire on both side instead of twin tires as illustrated in this document and there is one reading appearing on each side instead of two as illustrated in this document.

### Start-up

When the ignition switch is turned to ON, the following screen appears on the TPMS Display. Dash lines are displayed meaning that no pressure data have been received by the display.



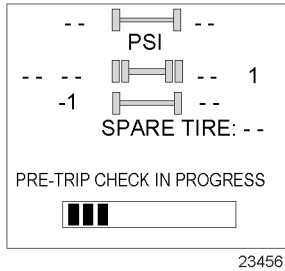
23455

As illustrated, the pressure readings will appear replacing the dash lines as the TPMS display starts to receive pressure data from the TPMS receiver. It can take 1 minute to get all pressure readings updated since the sensors transmit at a one-minute interval. The user can flip through the menus.

### Pre-Trip Check

When one of the preconditions defined to start the pre-trip check is met, the TPM display enters into a pre-trip check routine and the screen shown below appears. The preconditions to initiate the pre-trip are: Park brake removed Or No activity on the display menu keys for a defined time (Key pressed timeout). After a pre-trip, the display is in a “drive” mode with bottom menu replaced by the alarm status. The display remains in this mode until one of the following occurs: A menu key is touched while the park brake is applied, or the park brake does a transition from released to park brake applied.





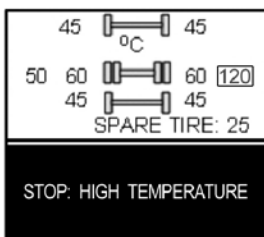
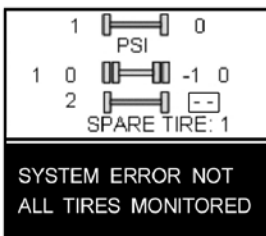
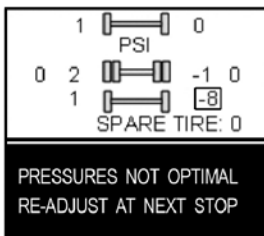
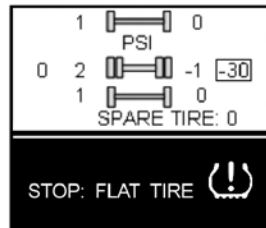
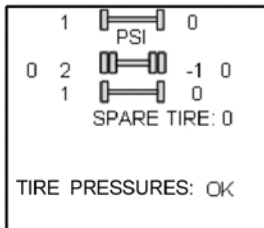
23456

During the pre-trip check, the pressure readings for the different wheels become all available.

The pre-trip check ends, either when: the pressure readings have been received for all running wheels or the pre-trip check maximum time has elapsed. It was selected to provide sufficient time for all wheel sensors to wake-up and send a first reading.

The pre-trip check is aborted and the bottom menu reappears if the park brake was active and the user press one of the menu keys.

Upon completion of the pre-trip check, the TPMS display will come up with one of the following screens:



23410

A rectangle around each pressure and temperature reading of the tires that have an issue is blinking to draw the attention to the defective tires.

In the case of multiple errors at the same time, the highest priority error is displayed at the

bottom. “Flat Tire” has the highest priority followed by “High Temperature”, “Not all tires monitored” and “Tire pressure not Optimal”.

To get the driver’s attention to the alarms, the bottom section of the screen where the alarm message appears will blink to reverse contrast. Pressing any key will acknowledge the alarms that are considered as non-critical and stop the blinking of these alarms message for the remaining of the trip. The non-critical alarms are: “Pressure not optimal” and “Not all tires monitored”. The “flat tires” and “high temperature” alarms are critical and will keep blinking even when a key is pressed. If a different alarm occurs, blinking will start again. The blinking rectangle around the pressure/temperature readings is not impacted by the acknowledgement and keeps blinking until the error condition disappears.

The spare tire does not contribute to alarms and so never blinks.

On the road, the TPMS display shows one of the 5 previous screens.

In the event of a temperature alarm, the display switches automatically to temperature readings.

The driver can also press any of the menu keys to momentary switch the display to temperature readings. In this case, the temperature reading appears for 15 seconds and the display returns to pressure.

The switching to temperature by pressing a key does not take place if there is an acknowledgeable alarm active, since in this case pressing the key does acknowledge the alarm.

The switching to temperature does not take place either if there is an alarm of Temperature or Flat Tire.

The switching to temperature works when the bottom message indicates either: Tire Pressure OK, Pressure Not Optimal non flashing or not all tires monitored non flashing. When the switch is done to temperature readings, the bottom portion of the screen is not affected and still shows the status message.

**NOTE**  
*High temperature is not likely to occur during the pre-trip.*

## 4-38 Controls and Instruments

The pressure and temperature readings are continuously updated with the displayed readings of the wheel having issues blinking. The bottom line message is automatically updated to the highest priority alarm prevailing.

On the occurrence of an alarm, a beep will sound. The alarm beep could be turned OFF in the alarm settings menu.

### Spare Tire

The spare tire is monitored but it is not taken into account when setting the bottom alarm messages. This is to prevent unnecessary alarms that would otherwise occur, if for example, the spare tire is removed from a vehicle.

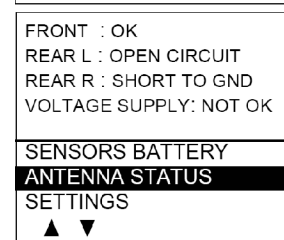
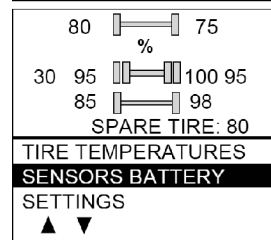
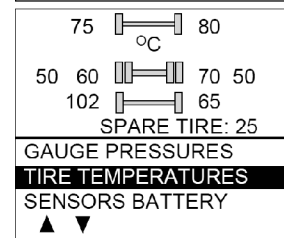
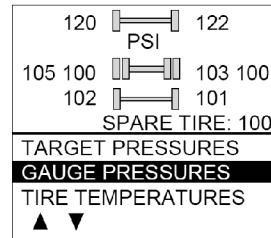
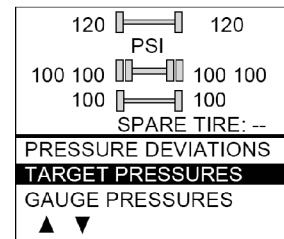
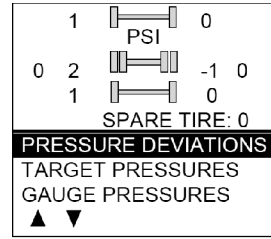
The user will have the possibility to check the pressure of the spare tire by accessing the TPMS display menu. For vehicles that have no spare tires, the title "spare tire" will still appear on the screens but the pressure will remain with two dash lines at all time.

### Post Trip Operation

When parking the vehicle (park brake applied), the TPMS display keep the drive mode display active. The driver can press any keys to get the bottom lines showing the status information replaced with the menus.

The pressure readings are still displayed and updated as new readings are received and the readings are blinking if not within the optimum pressure range.

From this point the user can scroll through the menus to get more detailed information and inflate or deflate the tires to bring them back to their optimum target pressures. Scrolling through these menus is also available prior to departure.

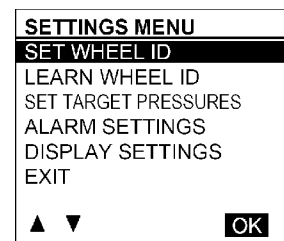
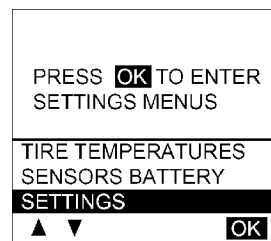


23411

The display remains in this mode with the menus appearing at the bottom until the pre-trip check sequence starts again.

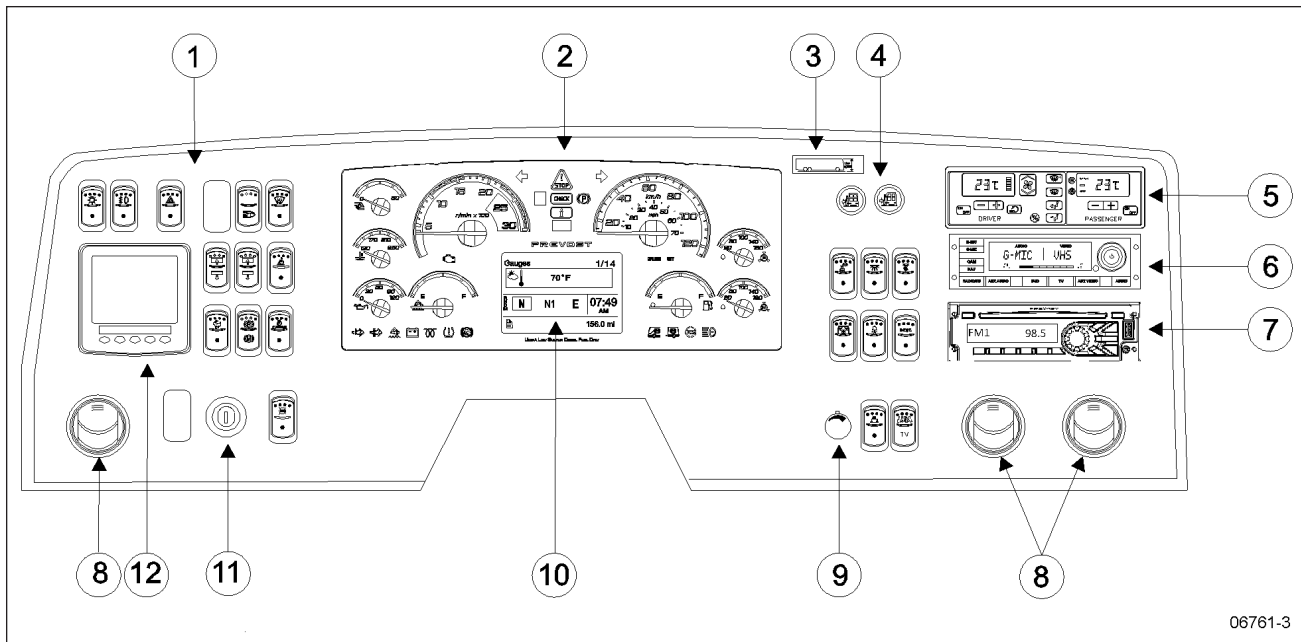
Scrolling down below the Battery life menu will show the Settings menu. Highlighting the Settings and pressing OK allows entering the settings menu. Refer to ["Setting The On-Screen TPMS" on page 7](#) in Section 7 Safety Features and Equipment for more information.

Highlighting the Exit menu and pressing OK exits the settings and come back to the pressure display mode.



23411-2

## DASHBOARD



06761-3

FIGURE 22: DASHBOARD

1. L.H. dashboard panel
2. Instrument cluster
3. Vehicle clearance information
4. R.H. dashboard panel
5. HVAC control unit
6. Audio-video selector panel VSS-05
7. Dashboard radio
8. Air registers
9. Brightness control
10. Driver information display (DID)
11. Ignition switch
12. On-Screen tire pressure monitoring system display

## 4-40 Controls and Instruments

### CONTROL SWITCHES

High quality switches are used to control many of the features of the vehicle. Many switches have an embedded indicator LED to inform the driver at a glance which features are active.

On some switches, the indicator LED will turn off after a short while when the engine is running. This is normal and is designed to reduce glare when driving. The functions still operate even if the LED is off. If the switches are still on when the engine is turned off, the LEDs will illuminate to warn the driver to turn them off. Switches are described in the order they appear, from left to right, top to bottom.

### L.H. DASHBOARD PANEL

The L.H. dashboard panel includes controls for the operation of the coach; it also includes the ignition switch and an adjustable air register.

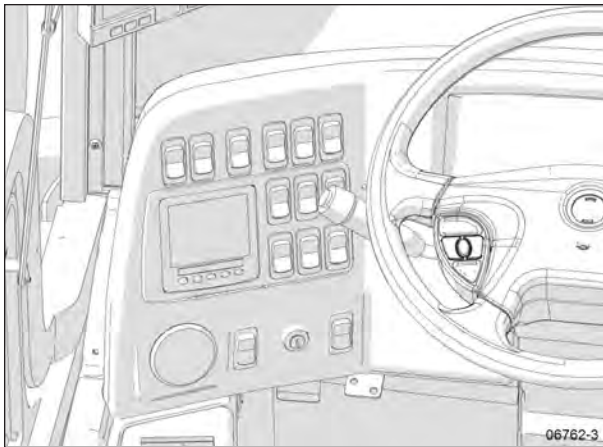
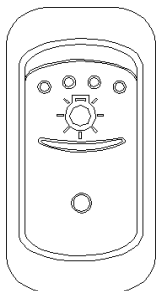


FIGURE 23: L.H. DASHBOARD PANEL

### Headlights And Exterior Lighting



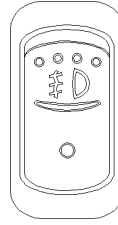
**OFF position** – Daytime running lights only (with engine running).

Press this rocker switch to turn on the following lights:

**First position** – Front parking lights, taillights, clearance lights, marker lights, license plate light.

**Second position** (push down fully) – the headlights, the controls and instrument lights and all lights from the first position.

### Fog Lights (Optional)

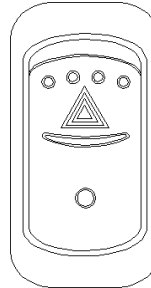


Optional halogen fog lights provide better visibility in fog and precipitation. They improve close range visibility and provide added safety.

#### NOTE

*Some states and provinces restrict the use of fog lights. Verify local state or provincial regulations before using.*

### Hazard Warning Flashers



Press the rocker switch to make all turn signal lights flash at once. The dashboard telltale lights will flash when the hazard warning flashers are ON.

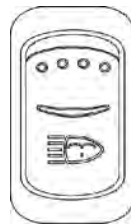
Once the hazard warning flashers are activated, the ignition switch can be turned to the OFF position. The hazard warning flashers will stay activated and will prevent the vehicle systems to fall in “sleep mode”.



#### CAUTION

Do not use the hazard flashers for an extended period of time with the engine shut down unless necessary. The electrical circuits remain activated when the hazard switch is depressed.

### Headlights Washer



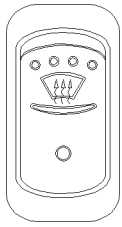
Momentarily press this rocker switch to spray the headlights washer fluid. Each pressing of this switch produces two successive jets.



#### CAUTION

Do not operate the washer while the washer fluid reservoirs are empty. This may damage the washer fluid pumps.

### Windshield Upper Section Defrosting (Option)



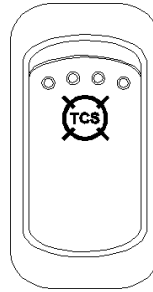
The coach may be equipped with an optional defrosting system in the upper windshield section. Press the rocker switch to activate the blower in order to clear fog, frost or thin ice from either side of the upper windshield.

The upper windshield defrosting is automatically activated when:

1. The outside temperature is lower than 39°F (4°C);
2. The engine temperature is higher than 86°F (30°C);
3. The driver's side HVAC control unit is turned on and the fan speed is higher than zero.

After automatic activation of the upper windshield defrosting, the upper defroster unit can be turned off by cycling this switch to the ON position and then to the OFF position.

### Traction Control System Mud/Snow Mode

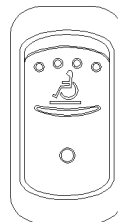


On certain road conditions, it may be useful to retard the intervention of the traction control system TCS during vehicle acceleration. The Mud/Snow function allows greater engine power and more wheel spin during TCS operation. This function may be helpful to set the vehicle in motion on iced roads, for example.

Press the Mod/Snow switch to turn on this function. The TCS icon blinks slowly in the DID when the TCS Mud/Snow mode is active. Always remember to turn the Mud/Snow feature off when driving on a firm road surface.

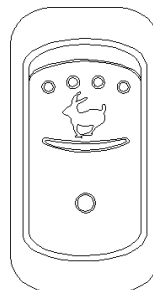
A new ignition cycle or a second pressing of the Mud/Snow switch will turn this function off.

### Wheelchair Lift System Activation (Option)



Supply electrical power to the wheelchair lift system by pressing down on the rocker switch. Refer to Other Features for instructions on operating the wheelchair lift.

### Fast Idle



For extended idling periods, run the engine at fast idle. Press down this rocker switch to engage fast idle. This increases the engine speed to approximately 1,000 rpm. Return to normal idle before driving or when stopping the engine.



**CAUTION**

If the parking brake is released and/or the transmission is engaged with the engine running at fast idle, the engine will return to normal idle and remain there as long as the parking brake is not applied and/or transmission is not placed in neutral (n).

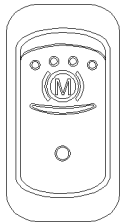
The engine will return to fast idle once the parking brake is applied or neutral (n) selected.



**CAUTION**

Return the engine to normal idle before shutting the engine off.

**Engine Brake (Optional)**

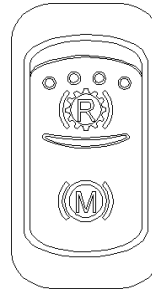


The vehicle's engine brake is by default set to automatic (AUTO **A** mode). On vehicles equipped with this switch, it is possible to disable the engine brake (OFF mode).

From OFF or AUTO mode, the driver can switch directly to Engine Brake LOW **1** or Engine Brake HIGH **2** mode by using the buttons on the steering wheel. Refer to ["TRANSMISSION RETARDER \(option\)" on page 27](#) & ["ENGINE BRAKE" on page 27](#) in Section 5 Other Features.

The switch will have to be pressed again to return to AUTO **A** mode (cycling the ignition will have the same effect).

**Engine Brake / Transmission Retarder**



Use this switch to select between the transmission retarder or the engine brake when using the vehicle speed retarding device switches on the steering wheel. Neither system can be in function at the same time. This rocker switch is present on the dashboard, only if the vehicle is equipped with both systems. Refer to ["TRANSMISSION RETARDER" on page 1](#) in this section. Refer also to ["TRANSMISSION RETARDER \(option\)" on page 27](#) & ["ENGINE BRAKE" on page 27](#) in Section 5 Other Features.

**Engine Stop Override (With Automatic Fire Detection And Suppression System)**



Press the Engine Stop Override switch on the dashboard or the Delay Engine Stop switch on the AFSS protection panel to delay the engine shutdown and extinguisher discharge by an additional 15 seconds.



**CAUTION**

Use this function if you are not prepared to bring the vehicle to a safe stop (i.e. on a railroad track, in intersection).

This switch is functional only if the vehicle is equipped with the Automatic Fire Detection and Suppression System.

**Driver Controlled Differential Lock (Dcdl) (Optional)**



Press this rocker switch to lock or unlock differential action. Refer to ["DRIVER CONTROLLED DIFFERENTIAL LOCK \(DCDL\)" on page 30](#) in Section 5 Other Features for the complete operating instructions.



**CAUTION**

- Engage DCDL only under poor road surface conditions.
- DCDL will not engage and will disengage in speed higher than 5 mph.
- Do not lock DCDL when one or more wheels are slipping, spinning or losing traction. You can damage the drive axle.
- Using the rocker switch, unlock DCDL when the need for improved traction has passed otherwise it will re-engage automatically as speed gets below 5 mph. Over a prolonged period, this situation will increase tire wear and stress to the vehicle.
- Do not engage during downhill operation.

**R.H. DASHBOARD PANEL**

Controls for passenger entertainment are grouped on the R.H. dashboard panel. The HVAC control module as well as the cluster dimmer switch, miscellaneous control switches and air vents are also located on this side of the dashboard.

Vehicle clearance information may also be affixed in this location.

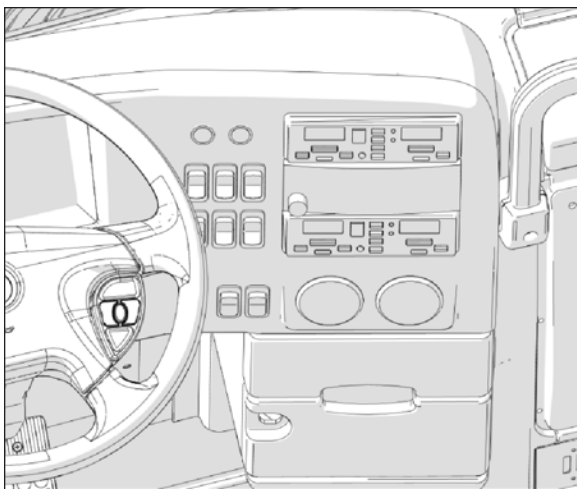
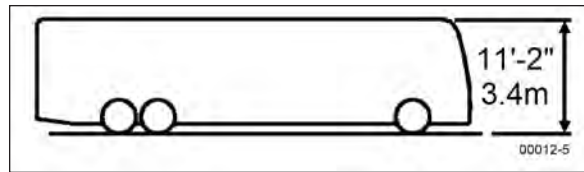


FIGURE 24: R.H. DASHBOARD PANEL

**Vehicle Clearance Information**



Normal ride height clearance

Roof hatch closed: 11'-2" (3.4 m).

Roof hatch open (ventilation): 11'-5" (3.48 m).



**CAUTION**

Vehicle clearance is higher when the ventilation hatch is open (if installed), hi-buoy is selected or if additional equipment is installed on the roof.

**Door Operating Buttons**



CLOSE



OPEN

Press and hold button to open or close the door.

Releasing the button at any time will immediately stop door movement.

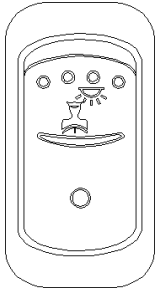


**WARNING**

The door mechanism has no automatic safety protection to avoid injury to bystanders. The driver is responsible for the safe operation of the door.

## 4-44 Controls and Instruments

### Driver's Area Lighting

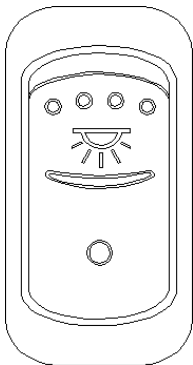


Press this rocker switch to turn on the driver's overhead light as needed.

#### NOTE

*The entrance overhead light and the stepwell lights turn on with the entrance door opening and turn off with door closing. If the entrance door is left opened, these lights will be turned off automatically if the battery voltage drops below 24.0 volts.*

### Interior Lighting



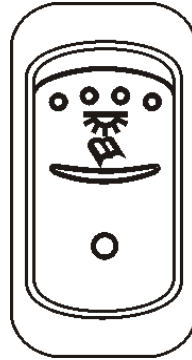
Press this rocker switch to the first position to illuminate the aisle fluorescent lighting. Press down the second position to gradually illuminate the in-station reading lights to 80% of their intensity regardless if they were turned off individually by passengers. Lights will also turn OFF gradually.



#### CAUTION

To avoid running down the batteries when the engine is off, turn off the lights or connect the battery charger to a 110-120-volt AC power supply.

### Reading Lights



This switch powers the reading light circuit enabling passengers to operate their personal reading lights. Refer to "Coach Interior" chapter.

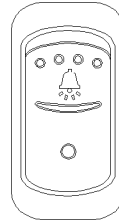
Turning the key or ignition lever to the accessory position "ACC" when the reading lights are on will activate the lights to full intensity, providing a clear view over the entire cabin area.



#### CAUTION

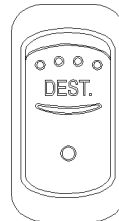
To avoid running down the batteries when the engine is off, turn off the lights or connect the battery charger to a 110-120-volt AC power supply.

### Stop / Service Chime (Optional)



Press this switch to enable the stop/service chime. Even when the chime circuit is disabled, the buttons in the overhead panels will illuminate if depressed by the passengers.

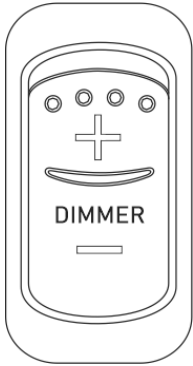
### Destination Sign (Optional)



Press this rocker switch to illuminate the destination sign.

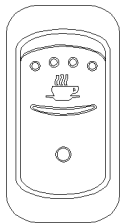


**Dashboard Brightness Control**



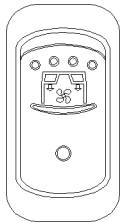
Adjusts the brightness of the dashboard instruments and switches.

**Galley**



This switch activates the optional galley's electrical circuit.

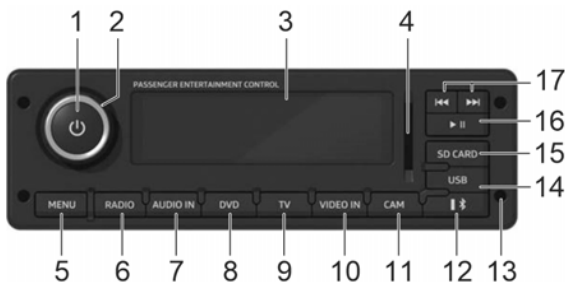
**Passenger Overhead Air Registers**



Press the switch to the first position to set the fans to low speed. Press the switch to the second position to set the fans to high speed.

If equipped with the optional air conditioning in the overhead compartments, activating the fans also engages the A/C compressor.

**AUDIO-VIDEO SELECTOR FOR THE PASSENGER'S AREA**



23558

The VSS-06 Video and Sound Selector enables the driver to select audio, audio/video and video sources with settings of volume level, bass, treble, loudness for the passenger's area only. The DVD player, media player, microphones and auxiliary audio or video sources are controlled with this unit.

**1) POWER**

Turns on/off the unit

**2) VOLUME KNOB**

Increases or decreases the sound output level. Changes the selected setting.

**3) FRONT DISPLAY**

Shows information about the operational status of the unit.

**4) SD MEMORY CARD SLOT**

**5) MENU**

- a. Press MENU to enter the menu.
- b. In menu, rotate VOLUME knob or short press ►►| or |◄◄ to reach the appropriate function.
- c. Short press POWER button or ►|| to select the function.
- d. Short press on any program source button will exit the menu.

**6) RADIO program source**

Selects the dashboard radio as current audio source for the passenger's area.

**7) AUDIO IN program source**

Selects the auxiliary 3.5 mm port as current audio source.

**8) DVD program source**

Selects DVD Player as current audio/video source.

**9) TV program source**

Selects the female HDMI cable connection coming from the back of the parcel rack HDMI switch as current audio/video source

## 4-46 Controls and Instruments

---

(standard on H3 Series, optional on X3 Series).

### 10) VIDEO IN program source

Press VIDEO IN to select an auxiliary video input as current audio/video source.

Press VIDEO IN to select the optional modesty panel HDMI connection as current audio/video source.

### 11) CAM program source

- a. Press CAM button to select the optional panoramic view camera signal. The video bar of the VSS06 front display will show "CAM". The video monitors turn on automatically.
- b. Press CAM button again to turn off the panoramic view camera and return to previous audio/video source.

### 12) BLUETOOTH program source

Selects the connected Bluetooth device audio streaming content as current audio source.

### 13) UNIT REMOVAL TOOL INSERTION HOLE (4X)

### 14) USB program source

Selects the device connected via the USB port as current audio/video source.

### 15) SD MEMORY CARD program source

Selects the SD card content as current audio/video source.

### 16) PLAYBACK / PAUSE

### 17) SKIP FORWARD / BACKWARD

## Program Source Selection

1. Press any of the following buttons RADIO, AUDIO IN, VIDEO IN, BLUETOOTH, USB, SD CARD and select the needed program then press TV button to select VIDEO IN

program sources if applicable.

2. In compatibility mode, pressing DVD button will select DVD program. In non-compatibility mode, then press DVD to switch into VIDEO IN program sources.
3. When pressing on the following buttons DVD, TV, VIDEO IN, select VIDEO IN video signal.
4. When USB, SD Card selection is to play video, it will select its related video signal. When switching from other signal source, the unit will mute 8 seconds and show Prevost interface.
5. Inserting SD Card or connecting USB will enter active status in inactive mode.

## MENU Button Functions

Volume adjustment

- volume background
- volume gong to passengers
- microphone gong signal ON/OFF

Audio

- bass
- treble
- balance
- loudness

Language

- english
- français

Compatibility

Test mode

Software update

### Background Volume Adjustment

When a microphone is activated, the current audio source volume will reduce to a certain level which has been set at the factory. To adjust this level, proceed as follows:

1. Press MENU button to enter menu list.
2. Rotate VOLUME knob or short press ►►| or |◄◄ button to reach VOLUME ADJUSTMENT.
3. Press POWER button or ►|| button to select VOLUME ADJUSTMENT.
4. Press POWER button or ►|| button to select VOLUME BACKGROUND and rotate VOLUME knob or short press ►►| or |◄◄ button to adjust.
5. Press POWER button to save the setting. If no button press occurs within 8 seconds, the setting will be saved automatically and the unit returns to the previous program.

### Gong Sound Level

A gong will sound in the passenger's area upon activating of the microphone. The gong sound level can be adjusted as follows:

1. Press MENU button to enter menu list.
2. Rotate VOLUME knob or short press ►►| or |◄◄ button to reach VOLUME ADJUSTMENT.
3. Press POWER button or ►|| button to select VOLUME ADJUSTMENT.
4. Press POWER button or ►|| button to select VOLUME GONG TO PASSENGERS and rotate VOLUME knob or short press ►►| or |◄◄ button to adjust.
5. Press POWER button to save the setting. If no button press occurs within 8 seconds, the setting will be

saved automatically and the unit returns to the previous program.

### Disabling Gong Sound

1. Press MENU button to enter menu list.
2. Rotate VOLUME knob or short press ►►| or |◄◄ button to reach VOLUME ADJUSTMENT.
3. Press POWER button or ►|| button to select VOLUME ADJUSTMENT.
4. Press POWER button or ►|| button to select MICROPHONE GONG SIGNAL ON/OFF and rotate VOLUME knob or short press ►►| or |◄◄ button to select ON or OFF as needed..
5. Press POWER button to save the setting. If no button press occurs within 8 seconds, the setting will be saved automatically and the unit returns to previous program.

### AUDIO Settings Treble / Bass / Balance / Loudness Setting

1. Press MENU button to enter menu list.
2. Rotate VOLUME knob or short press ►►| or |◄◄ button to reach AUDIO.
3. Press POWER button or ►|| button to select AUDIO.
4. Rotate VOLUME knob or short press ►►| or |◄◄ button to reach the desired function.
5. Press POWER button or ►|| button to select desired function and rotate VOLUME knob or short press ►►| or |◄◄ button to adjust.

NOTE: If no VOLUME knob rotation occurs within 8 seconds after selecting BASS, TREB, BAL and

## 4-48 Controls and Instruments

LOUD modes, the unit automatically sets in the VOL mode.

### Language Selection

The VSS06 supports English & French. To change language:

1. Press MENU button to enter menu list.
2. Rotate VOLUME knob or short press ►►| or |◄◄ button to reach LANGUAGE.
3. Press POWER button or ►|| button to select LANGUAGE.
4. Rotate VOLUME knob or short press ►►| or |◄◄ button to select the desired language.
5. Press POWER button to save the setting.

### Compatibility

This function is used only when replacing a VSS05 unit by VSS06.

### Bluetooth Mode

1. The VSS06 automatically reconnects a paired device after power on. The blue Bluetooth indicator light will flash.
2. With a long press of 3 seconds on BLUETOOTH button, the user can disconnect the Bluetooth devices. The red Bluetooth indicator light will flash when no Bluetooth device is connected.
3. The blue Bluetooth indicator light lights up when the unit is connected to a Bluetooth device.
4. Pairing to the VSS06 is done through your Bluetooth device. When pairing a Bluetooth device, the user can confirm whether the pairing code displayed on the VSS06 matches the

pairing code displayed on the Bluetooth device.

### OPERATION OF THE OPTIONAL AUDIO-VIDEO MODESTY PANEL

On some vehicles, it is possible to connect and display on the main monitor a laptop or other audio-video equipment (DVD player, gaming console) from an optional audio-video modesty panel located behind the driver's seat.

To do so, connect the laptop to the modesty DB9 connector (9 pins, blue connector), select Video IN on the unit and turn on the laptop presentation mode.

Devices using RCA connectors (DVD, gaming console) can also be used by connecting them to the 3 modesty RCA connectors and selecting the Video and Sound Selector TV mode.

### DASHBOARD RADIO AM/FM/SAT SERIES DEA700

See **DEA700 Series Radio Owner's Manual** for more information. This manual is available on the Technical Publications site at <https://techpub.prevostcar.com/en/>. Select **Supplier Publications** tab and then select **Audio & Video (misc)** in the list of supplier for a faster search.



#### NOTE

*Using the microphone while driving is not recommended. For this reason, there are no microphones installed on the radio at the factory.*

**NOTE**

The driver speakers are controlled from the dashboard radio volume knob while the passenger's area speakers are controlled from the VSS06 Sound Selector volume knob.

**HVAC CONTROL UNIT**

The vehicle is slightly pressurized by the central HVAC system to prevent dust and moisture from entering.

Separate driver and passenger heating, ventilation and air conditioning controls are located on this panel. To operate, the engine must be running.

The driver HVAC unit turns on automatically at engine start and uses the settings that were kept in memory before turning off the system. The A/C compressor starts automatically when the two following conditions are met:

1. The outside temperature is above 32 °F (0 °C).
2. The passenger's area temperature has reached 7 °F (4 °C) under the set point.

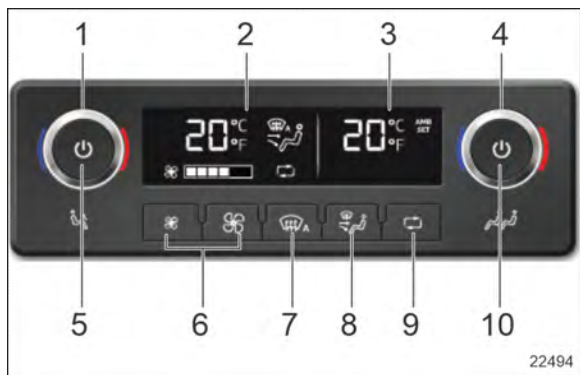


FIGURE 25: CONTROL UNIT FOR HIGH CAPACITY CENTRAL HVAC SYSTEM

**1) Driver temperature set point adjustment**

Increases or decreases the temperature set point for the driver's area.

**2) Driver section display**

Displays the temperature set point, the fan speed, the air selection and recirculate air status for the driver area.

**3) Passenger section display**

Displays the actual temperature in the passenger area.

**4) Passenger temperature set point adjustment**

Increases or decreases the temperature set point for the passenger area.

**5) Driver HVAC power button**

Turns on/off the driver HVAC unit.

**6) Fan speed**

Increases or decreases the fan speed.

**7) Auto-defrost**

Upon pressing this button, the dashboard damper sends air only to the lower windshield. The fan is turned on to maximum speed, the fresh air damper opens completely (recirculate off) and the driver set point is increased to 4 °F (2 °C) over the passenger section set point.

**8) Air selection**

Changes the air outlets used.

**9) Recirculate**

Switches between outside air and recirculated air for the driver and passenger area. This feature is automatically canceled when the windshield defrost is activated.

**10) Passenger HVAC power button**

Turns on/off the passenger HVAC unit.

**Temperature Unit Selection °F / °C**

To switch the temperature units, press simultaneously both fan speed buttons for 3 seconds.

**Driver Section Temperature Setting In Case Of Temperature Sender Failure**

On the driver section of the control unit only, asking for a temperature set point above 82 °F (28 °C) will keep the coolant valve open .

In case of interior temperature sender unit failure, the coolant valve will remain open.

## 4-50 Controls and Instruments

### Passenger Section Temperature Setting In Case Of Temperature Sender Failure

In case of interior temperature sender unit failure, the coolant valve will remain open. The driver can nevertheless control the temperature by adjusting the temperature set point above 72 °F (22 °C) to heat and below 72 °F (22 °C) to cool.

#### NOTE

*To operate the air conditioning system when stationary, run the engine at fast idle. When the system is running, keep windows and door closed.*

*To prevent battery run-down, the central A/C and heating systems will not operate if the charging system is not working properly.*

*When the A/C system is running, park at least 4 feet (1,5 m) from other vehicles or buildings to allow sufficient air flow through the condenser core.*

*Upon starting, if the outside temperature is above 32 °F (0 °C) and then drops below 32 °F (0 °C), the compressor will keep running up to a temperature of 15 °F (-9 °C) to prevent fogging.*



#### WARNING

Warm temperatures may cause drowsiness and affect alertness while driving. Keep the temperature comfortable but not too high.

#### NOTE

*Upon starting of the vehicle, when the ambient temperature is very cold and so is the inside of the vehicle, the HVAC control unit will allow a temperature overshoot up to 3° over the passenger area set point to help warm up of the area because some parts of the vehicle like the seats and the overhead compartments accumulate cold.*

## AIR REGISTERS

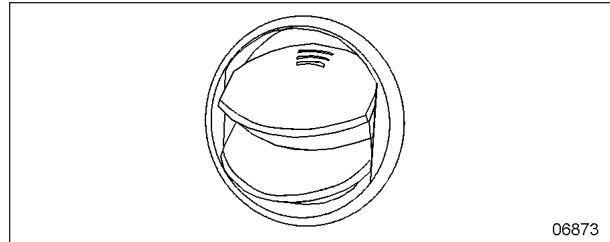
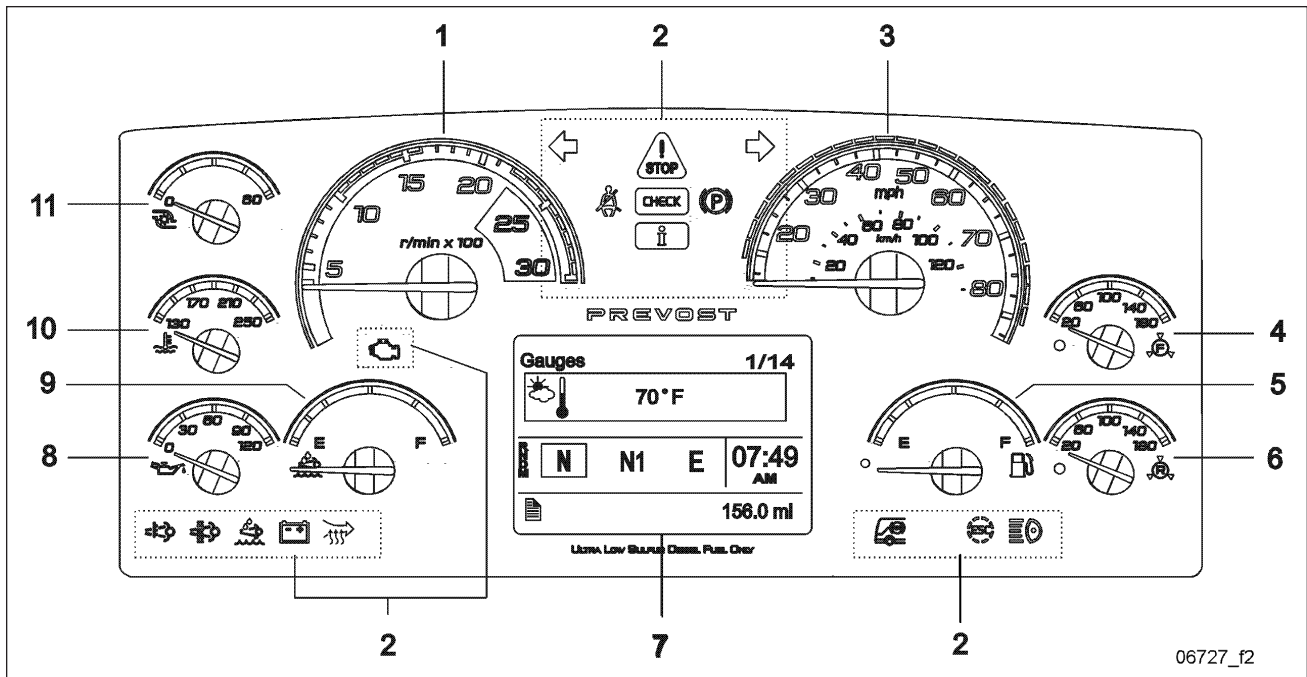


FIGURE 26: AIR REGISTER

Adjustable air registers feed air to the driver's area. Three are located in the dashboard and one near the door. Use the HVAC control panel to set air temperature and fan speed.

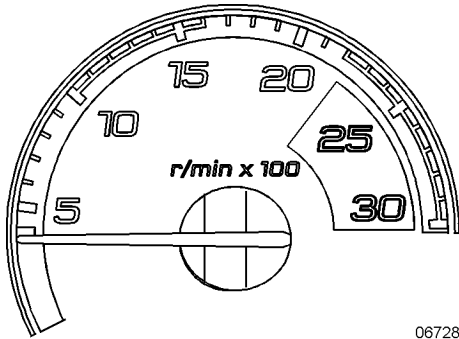
## INSTRUMENT PANEL



1. Tachometer
2. Telltale lights
3. Speedometer
4. Front brake air pressure (secondary)
5. Fuel level
6. Rear brake air pressure (primary)
7. Driver Information Display (DID)
8. Oil pressure indicator
9. DEF (Diesel Exhaust Fluid) level indicator
10. Engine coolant temperature
11. Turbo boost pressure

## 4-52 Controls and Instruments

### ANALOG INDICATORS



#### Tachometer (Rpm X 100)

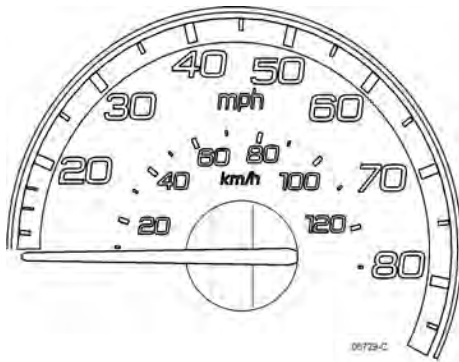
Indicates the operating speed of the engine in hundreds of revolutions per minute. Use the green range for normal driving (1000 to 1600 RPM).

The tachometer serves as a guide for gear shifting and helps to prevent engine overspeeding when driving downhill with the engine brake operating.



#### CAUTION

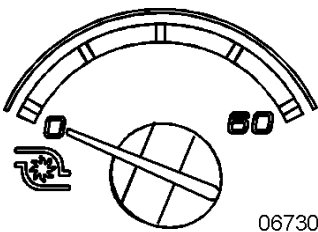
Never allow the engine to go into the red range. This could lead to severe engine damage.



#### Speedometer (MPH, Km/h)

Indicates the vehicle speed in miles per hour (mph) and kilometers per hour (km/h).

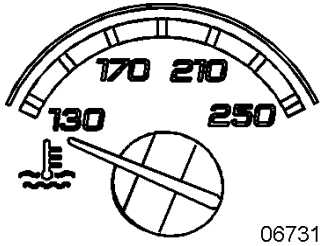
The LEDs above the instrument work in conjunction with the Adaptive Cruise With Braking (ACB) system. Refer to Adaptive Cruise With Braking" paragraph for further details.



#### Turbo Boost Pressure (psi)

Indicates the turbo boost pressure in psi. This pressure should be the same at a given engine temperature, speed, and load. An unusual reading could indicate an engine failure.





06731

### Engine Coolant Temperature (°F)

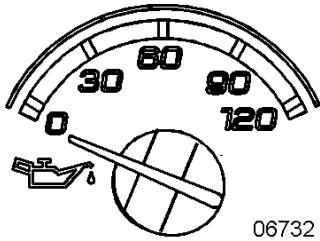
Indicates the operating temperature of the engine coolant in °F. The normal reading should be between 170°F and 222°F (80°C to 106°C).

The temperature limit is dependent on the electronic program for the engine model. When coolant temperature is excessive, the STOP telltale light turns on, an audible alarm sounds and a pop-up message appears on the DID. The engine protection system will automatically derate and stop the engine in 30 seconds. Stop at the first safe place where the problem can be checked.

If the temperature remains below or exceeds the normal temperature range, the cooling system should be checked for problems.



STOP telltale light



06732

### Engine Oil Pressure (psi)

Indicates the engine oil pressure in psi. When the oil pressure is too low, the STOP telltale light turns on, an audible alarm sounds and a message appears on the DID. The engine protection system will automatically derate and stop the engine in 30 seconds. Bring the vehicle to a safe stop where the problem can be checked.



STOP telltale light



OIL PRESSURE Pictogram



### CAUTION

Failure to take necessary action when the STOP telltale light is on can ultimately result in automatic engine derate and shutdown.



### Front Brake Air Pressure Gage (Secondary System)

Indicates the front brake air system pressure in psi. The normal operating pressure is from 122 to 140 psi.

The low air pressure indicator LED on the gage and the STOP telltale light illuminate when the front brake air system (secondary) pressure drops below 85 psi. An audible alarm will sound.



STOP telltale light



### WARNING

The driver is responsible for monitoring the pressure as part of a regular sweep of the instruments.

If the pressure drops in the secondary system but remains normal in the primary system, the front axle service brakes will not function but the drive and tag axle service brakes will operate normally, although if there is a leak in any pneumatic system (Sec/Pri/Park/Acc), the primary system might eventually lose its air pressure as well, depending on the nature and size of the leak. In the event of any air pressure loss in any system, the driver should pull to the side of the road as soon as can be safely done and investigate the situation.

Do not drive the coach when the brake air pressure is low.



### Rear Brake Air Pressure Gage (Primary System)

Indicates the rear brake air system pressure in psi. The normal operating pressure is from 122 to 140 psi.

The low air pressure indicator LED on the gage and the STOP telltale light illuminate when the rear brake air system pressure drops below 85 psi. An audible alarm will sound.



STOP telltale light



### WARNING

The driver is responsible for monitoring the pressure as part of a regular sweep of the instruments.

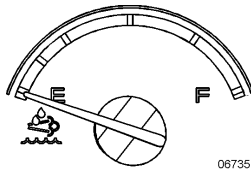
In the event of a pressure loss in the primary brake system, the drive and tag axle service brakes will not function normally. It is critical to bring the coach to a safe stop as quickly as possible.

If there is sufficient pressure in the secondary brake system, modulated spring brake pressure (using the park brake chambers) will be used to apply the drive axle brakes, proportional to the braking pressure on the front axle. It must be noted this is an emergency and a significant amount of secondary air pressure is lost with each apply/release cycle. The spring brake modulation will only function two or three times, depending on the amount of secondary air pressure that was on hand when the primary brake pressure was lost.

Once the secondary air pressure drops below 60 psig, the park spring brakes are fully applied and cannot be released until pressure is restored.

Do not drive the coach when the brake air pressure is low.

## 4-56 Controls and Instruments



### DEF Level

Indicates the amount of DEF (Diesel Exhaust Fluid) remaining in the DEF tank. The DEF tank is considered as being full when it contains 16 gallons (60 liters) of DEF. DEF consumption will be approximately 2% of the diesel fuel consumed.

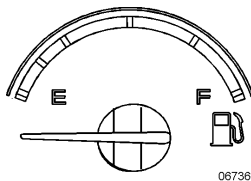


### CAUTION

#### DEF – Do not overfill

If an automatic nozzle is used for filling diesel exhaust fluid (DEF), do not add further DEF after the nozzle has automatically shut off flow a first time. If such nozzle is not available, use the DEF level gage on the instrument panel to control the quantity during filling.

Diesel exhaust fluid DEF will begin to crystallize and freeze at 12°F (-11°C) and expand by 7% when frozen. To allow expansion without damaging the DEF tank, do not fill the tank with more than 16 gallons (60 liters).



### Fuel Level

Indicates the amount of fuel remaining in the fuel tank. At the beginning of the red area, there is approximately 48 gallons (182 liters) left in the tank.

### NOTE

*A pop-up message will appear in the DID informing that there is only 26 gallons (98 liters) left in the fuel tank.*

## TELLTALE LIGHTS

The telltale lights illuminate for 5 seconds at the start of every ignition cycle as a light bulb check.

A telltale test can be initiated by the DID Diagnostic Menu, under Cluster Selftest. See [DIAGNOSTICS MENU](#)



### Stop

Indicates that a serious problem has been detected. Immediately park the coach in a safe place and stop the engine. This telltale light may be accompanied with a message in the DID and a diagnostic troubleshooting code will be stored to ease identification of the problem.



### WARNING

Failure to take necessary action when the STOP telltale light is on can ultimately result in automatic engine derate and shutdown.



### Check

Indicates that a problem has been detected and must be checked at the next stop. This telltale light may be accompanied with a message in the DID and a diagnostic troubleshooting code will be stored to ease identification of the problem.



### Forward Vehicle Detected – Adaptive Cruise With Braking

When the ACB is engaged with a cruise speed set and the forward vehicle is in range, the FORWARD VEHICLE DETECTED telltale light illuminates, indicating the ACB system is actively tracking the forward vehicle.

GREEN: The vehicle ahead of you is detected by the radar.

FLASHING RED: Impact alert. The vehicle ahead of you is too close. The driver must take immediate evasive action by applying more braking power and/or steering clear of the vehicle ahead to avoid a potential collision.

RED: System malfunctions. The Adaptive Cruise with Braking is not available.



### Information

This telltale light illuminates when there is a new information message or an abnormal status is detected by the electronic control unit. A pictogram, text or both are shown in the DID in addition to the INFO telltale light. Make sure the indicated fault is checked at the next stop.



### Turn Signal Indicators

Flashes when the right or left turn signals are activated. Signal right and left turns by operating the multi-function lever. See ["MULTI-FUNCTION LEVER" on page 73](#) in this section.

#### NOTE

*The turn signals are automatically activated when the vehicle is backing up.*



### Parking Brake Or Emergency Brake Applied

Illuminates when the emergency/parking brake is applied. The control valve is located on the L.H. control panel. An audible alert will sound if ignition is turned to Off and the parking brake is not engaged.



### Driver's Seat Belt Reminder Light And Warning Buzzer

When equipped with a seat belt buckle switch, warns the driver to fasten his/her seat belt.



### Aftertreatment System Malfunction (Malfunction Indicator Lamp)

Indicates a failure of an emission control device. May illuminate at the same time as the CHECK amber warning light. The lamp will go out after 3 completed ignition on-ride-ignition off cycles. Vehicle can be driven to end of the shift. Call for service.

### CRUISE

### Cruise Control

Indicates that the cruise control is enabled.

## 4-58 Controls and Instruments

SET

### Cruise Control Set Speed

Indicates that a cruising speed is set and stored in the memory.



### High Exhaust System Temperature (HEST)

Illuminates to notify the driver of potentially hazardous exhaust gas temperature at the exhaust system diffuser.



#### WARNING

During regeneration, exhaust temperature may reach up to 1200°F (650°C) at the particulate filter. When parking the vehicle, if this telltale light is illuminating, make sure that the exhaust system diffuser is away from people or any flammable materials, vapors or structures.



### DPF Regeneration Request

Illuminates to notify the driver that a manual stationary regeneration will be required soon. Refer to ["STATIONARY \(PARKED\) REGENERATION" on page 3](#) in Section 5 Other Features.



### Def Tank Low Level Indicator

Illuminates when there is less than 2.6 gallons (10 liters) of DEF left in the tank.



#### CAUTION

If the vehicle is kept in operation with an empty DEF tank, engine derate will eventually occur, limiting the speed to 5 mph.



### Charging System Warning Light

Indicates a malfunction of the charging system or a low battery voltage condition.

#### NOTE

*To identify if an alternator is defective (1=lower alternator, 2=upper alternator), perform a system diagnostic using the Driver Information Display DIAGNOSTICS menu. Select VIEW ACTIVE FAULTS and then ELECTRICAL SYSTEM. Scroll through the active faults. The electrical system active faults will appear. A diagnostic message indicating "alternator 1" or "alternator 2" with failure mode "open circuit" will come in sight.*



### Intake Air Preheater On – Wait Before Starting

Illuminates when the intake air preheater element is in function. Wait until this telltale light has turned off before starting the engine. For more information, refer to ["COLD WEATHER STARTING" on page 6](#) in Section 6 Starting and Stopping Procedures.



### Hill Start Assist

Indicates a malfunction of the Hill Start Assist function. This function might not be available.



### Antilock Brake System (ABS)

Illuminates when the ABS is not available or when the ABS is malfunctioning. Since the ABS system does not operate at less than 4 mph (7 km/h), the indicator will remain illuminated until the coach reaches that speed. Refer to ["ANTILOCK BRAKING SYSTEM \(ABS\)" on page 29](#) in Section 5 Other Features.



### Trailer Antilock Brake System (ABS)

Illuminates when the trailer ABS is not available or when the trailer ABS is malfunctioning.



### Esc - Electronic Stability Control

At vehicle ignition, the ESC telltale lamp illuminates for approximately 3 seconds and then turns off. If it remains on steadily (not flashing) after ignition, or if it illuminates steadily while you are driving, the ESC system may not be fully functional or their operation may be completely disabled. If this happens, your vehicle will still have normal service braking and can still be driven, but without the benefits of the ESC system.

Flashes quickly when ESC intervenes to reduce risk of loss of control.



### High Beam

Illuminates when the high beams are selected.

High and low beams are selected with the multi-function lever. Refer to ["MULTI-FUNCTION LEVER" on page 73](#) in this section.

## 4-60 Controls and Instruments

### STOP, CHECK AND INFORMATION TELLTALE LIGHTS

STOP, CHECK and INFORMATION telltale lights illuminate automatically to draw the attention of the driver and their associated messages are displayed in the DID. More than one message (see “Acknowledging Messages” below) can be active at the same time. A displayed message can be replaced by a new message provided the new message has a higher priority. Only fault codes that have a direct impact on vehicle operation are displayed. All fault codes are stored in the appropriate ECU for access by service technicians.

#### Stop Telltale Light

In the event of a serious fault, the red STOP telltale light comes on and an audible alarm will sound if the engine is running. An illuminated stop message light indicates a serious problem has been detected, and the driver must respond immediately to the problem.



When illuminating, this telltale light means the vehicle must be safely pulled off the road and stopped. In some instances, the engine must be switched off immediately.



#### WARNING

Failure to stop and take necessary action when the STOP telltale light is on can result in an automatic engine derate and shutdown.

In some cases preventive action may be taken by the engine ECU to protect the engine. For further details, refer to [“ENGINE PROTECTION SYSTEM” on page 8](#) in Section 6 Starting and Stopping Procedures.

#### Check Telltale Light

This telltale light means that a fault or an abnormal operating condition has been detected. The vehicle must be checked at the next stop.



If the CHECK telltale light illuminates, an associated message is displayed in the DID. Always pay attention to the associated messages (see “Acknowledging Messages” below).

#### Information Telltale Light

The INFO indicator light comes on when there is a new information message or an abnormal status is detected by the electronic control unit. A pictogram or text or both are shown in the DID in addition to the INFO telltale light (see “Acknowledging Messages” below).



#### Acknowledging Messages

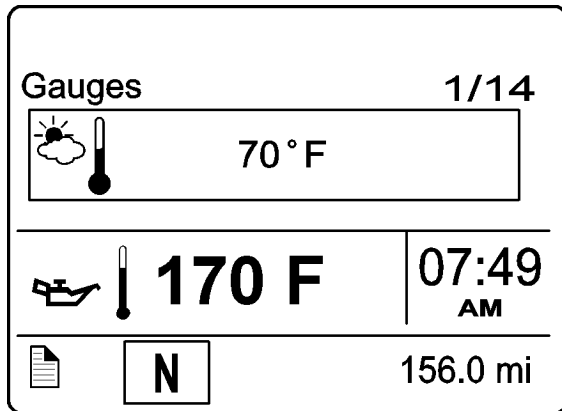
A fault message associated to a STOP, CHECK or INFORMATION telltale light must be acknowledged by pressing the ESCAPE or ENTER button after which the display returns to the same status that existed before the fault occurred. All messages can be acknowledged. Acknowledgement of pop-up messages and warnings stops the audible warning.

Acknowledged but inactive messages are displayed again when the ignition key is turned to the START position or they can be read in the DID menu. Refer to Other Features for more information on the DID menus.



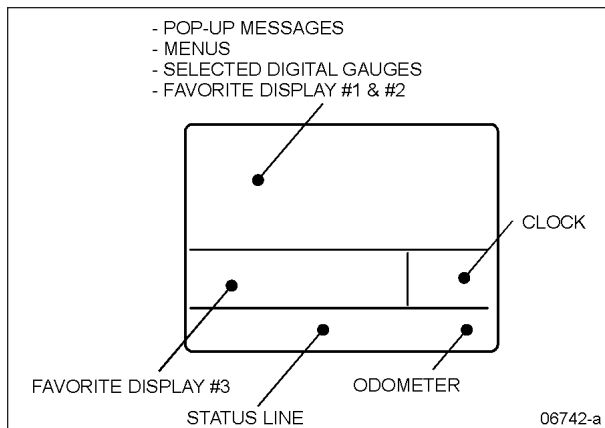
### DRIVER INFORMATION DISPLAY

The DID (Driver Information Display) is located in the center of the instrument cluster. It displays digital gages, main menus and submenus that provide necessary and important information to the driver. The information available to the driver depends on vehicle configuration, and whether the vehicle is in operation or parked. For the list of the available menus and submenus, refer to ["DRIVER INFORMATION DISPLAY \(DID\) MENUS" on page 11](#) in Section 5 Other Features.

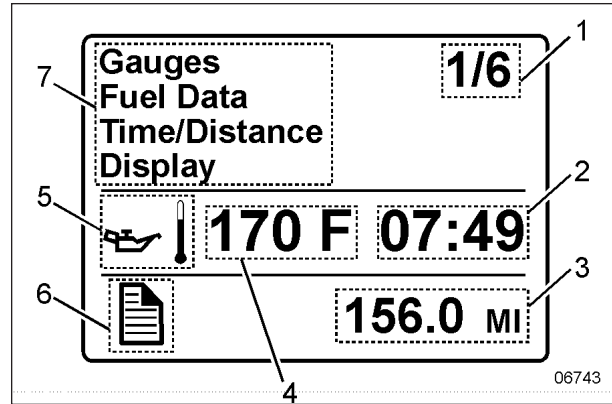


06746

The outside air temperature, fuel flow and the odometer (Allison transmission) or the current gear position (transmission I-Shift) are part of the default display. You can replace the default display by your selection of favorite gages using the Driver Information Display submenu Favorite Display Setting. Refer to ["DRIVER INFORMATION DISPLAY \(DID\) MENUS" on page 11](#) in Section 5 Other Features for more information.



06742-a

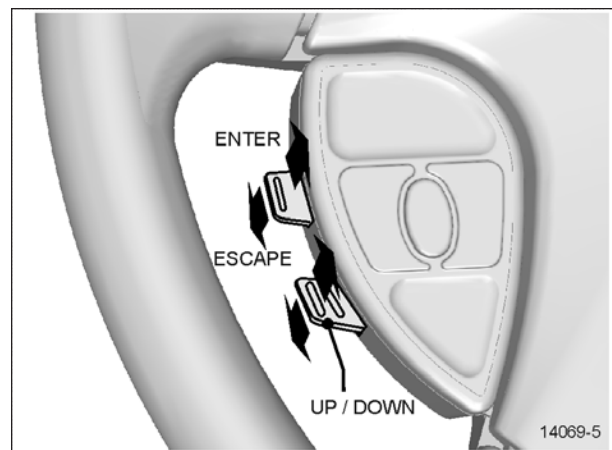


06743

1. Indicates first of six available menus (varies by menu)
2. Clock
3. Odometer
4. Value or data (in this example, the engine oil temperature)
5. Pictogram relevant to the displayed value or data
6. Status bar active pictogram
7. Messages or available menus

### Selecting A Menu

Menus are placed in a cascade arrangement. Use the steering wheel controls buttons to scroll through them.



14069-5

To select a menu:

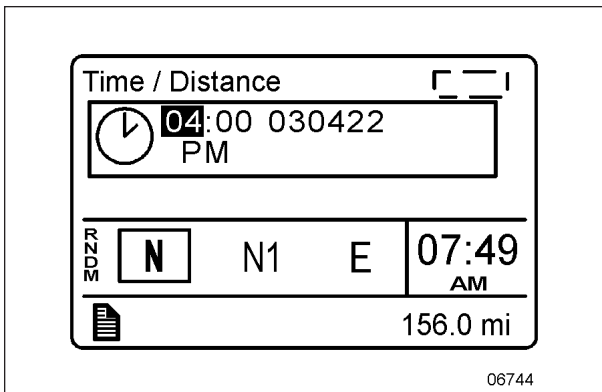
## 4-62 Controls and Instruments

1. Press the ENTER or ESCAPE button to display the list of available menus.
2. Use the UP/DOWN button to scroll up or down through the menus.
3. Use the ENTER button to open a menu.
4. Use the ESCAPE button to return to the previous menu or display or to cancel a setting or operation.

### To Change Settings

To change a setting, like the clock:

1. Use the UP/DOWN button to increase or decrease the numerical value of the selected range.
2. Use the ENTER button to confirm your choice and to move to the next field.
3. Press the ESCAPE button to return to the previous field or to cancel a setting or operation.



### Scrolling Through The Menus Without Using The Steering Wheel Buttons

In case of failure of the steering wheel buttons, it is still possible to gain access to the menus or acknowledge the pop-up messages to return to the default display.

This alternate mode is possible only if the steering wheel buttons are faulty.

To enable the alternate mode:

1. Apply the parking brake;
2. Depress and hold the service brake pedal.

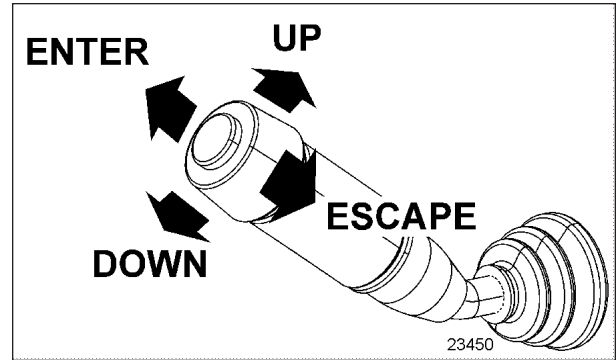


FIGURE 27: MULTI-FUNCTION LEVER

In alternate mode, use the multi-function lever as follows:

- Move the lever up = UP
- Move the lever down = DOWN
- Push the lever away from you = ENTER
- Pull the lever towards you = ESCAPE

## DRIVER INFORMATION LEVEL

The instrument cluster includes the analog instruments. It also presents two devices to communicate information to the driver, the telltale lights and the Driver Information Display (DID).

Indications and warnings are presented according to three levels of attention required:

### First Level - Telltale Lights

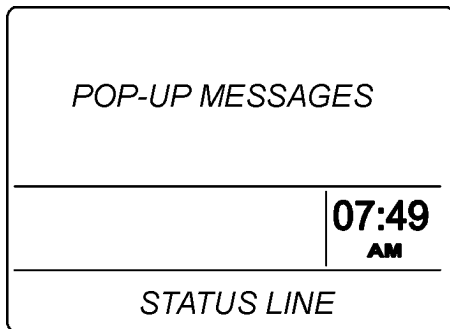
Telltale lights are temporary and exceptional; they present information critical to safety or vehicle integrity.

### Second Level - Pop-up Messages

Pop-up messages appear in the Driver Information Display DID without the driver's intervention and acknowledgment. Pop-up messages present supplemental information to the driver.

### Third Level- Status Line

The status line monitors certain systems and gives feedback to the driver concerning current actions and functions.



06742b

## 4-64 Controls and Instruments









### PICTOGRAMS DISPLAYED ON THE DRIVER INFORMATION DISPLAY (DID)

#### NOTE

In certain situations, the pictogram displayed represents a system or a function of the vehicle. A particular pictogram may be displayed with different messages. In that situation, it is very important to pay attention to the message displayed with the pictogram.

### DRIVER INFORMATION DISPLAY “GAUGES” MENU PICTOGRAMS








#### “GAUGES” MENU PICTOGRAMS

| PICTOGRAM   | DESCRIPTION   |
|---|---|
|    | <b>Engine oil temperature</b>   |
|    | <b>Outside Air Temperature</b>  |
|    | <b>A/C Compressor Pressure</b><br>This pictogram is displayed with A/C compressor suction pressure value (Low Side) and discharge pressure value (High Side).   |
|   | <b>Accessories Air Pressure</b><br>Normal pressure should be between 122 and 140 psi.   |
|  | <b>Voltmeter</b><br>This pictogram is displayed with both the 12-volt and 24-volt electrical system current voltage value. When the engine is running, the 24-volt electrical system voltage value should be between 26,5 and 28,0 volts. |
|  | <b>Transmission Oil Temperature</b>   |
|  | <b>Current Gear Position (I-Shift Transmission)</b><br>Indicate the current transmission gear position on the Volvo I-Shift transmission.<br>R= reverse<br>N = neutral<br>D= drive<br>M= manual mode                                      |
|  | <b>Battery State of Charge</b><br>This pictogram is displayed with the state of charge (%) of the 12-volt and 24-volt battery banks.  |

**POP-UP MESSAGES**

Acknowledge messages by pressing the escape (ESC) button on the steering wheel. Acknowledgement of pop-up messages and warnings stops the audible warning.

**Pop-up Pictograms**

| PICTOGRAM   | DESCRIPTION  |
|---|--|
|    | <b>High Engine Oil Temperature</b>   |
|    | <b>Engine Coolant Temperature</b>  |
| CHECK ENGINE COOLANT LEVEL AT NEXT STOP   | <b>Low engine coolant level</b><br>Warns the driver that the engine coolant level has reached the recovery tank low level switch. Add coolant whenever possible.   |
| ENGINE COOLANT LEVEL CRITICALLY LOW   | <b>Critically low coolant level</b><br>Warns the driver that the engine coolant level has reached the surge tank low level switch. Stop and add coolant.   |
|    | <b>Engine Oil Pressure</b>   |
|   | <b>Engine Temperature Too Low for Volvo Engine Brake (VEB) Operation</b>   |
|  | <b>High Transmission Oil Temperature</b><br>This pictogram indicates that the transmission oil temperature is too high. Turn the transmission retarder off to allow the oil to cool down.  |
|  | <b>Allison Transmission– Oil or Filter Replacement Required</b><br>This pictogram may be displayed with many different messages. Pay attention to the displayed message which can advise that the transmission oil or filter change is necessary. Refer to Appendix C for more information on the Allison transmission prognostic features (oil life monitor, filter life monitor, transmission health monitor). |
|  | <b>Trailer Braking System Low Air Pressure / Trailer Parking Brake</b><br>This pictogram appears when the trailer emergency/parking brake is unexpectedly applied as when the vehicle is moving and a parking brake air line rupture happens.  |
|  | <b>Low Brake Air Pressure</b><br>The message associated to this pictogram is “Low System Brake Air”. Warns the driver that the brake air system pressure of the primary or/and secondary system has decreased below 85 psig. Do not drive the coach when the brake air pressure is low.  |

### Pop-up Pictograms



#### TCS traction control system and electronic stability control

At vehicle ignition, the TCS icon appears for approximately 2 seconds and then disappears.

If it remains on steadily (not flashing) after ignition, or if it is on steadily while you are driving, the TCS system may not be fully functional or the operation may be completely disabled. If this happens, your vehicle will still have normal service braking and it still can be driven, although without the benefits of the TCS system.

Flashes slowly when TCS Mud/Snow mode is turned on using the Mud/Snow switch.

Flashes quickly when TCS intervenes to reduce risk of loss of control.



#### A/C System Pressure High

This pictogram indicates that the A/C system pressure is too high. If the A/C pressure is too high, the compressor clutch is disengaged, but the fan remains activated.

#### **NOTE**

*When outside temperature is high, it is possible and normal for that pictogram to appear.*



#### A/C System Pressure Low

This pictogram indicates that the A/C system pressure is too low. If the A/C pressure is too low, the compressor clutch disengages and the fan stops.

#### **NOTE**

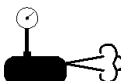
*When outside temperature is low, it is possible and normal for that pictogram to appear.*



#### Compressor/air dryer fault

This pictogram indicates that a risk of water in the pneumatic system has been detected due to a compressor or air dryer related problems. Possible causes are:

- Compressor is used at an unusual (high) rate.
- A fault with the air system has been detected.



#### Air leakage

This pictogram indicates that an air leak has been detected in the pneumatic system.

## Pop-up Pictograms



### Battery Voltage Warning

This pictogram indicates that the battery voltage is too high, too low or the 12 volt / 24-volt battery arrangement is not equalized.

The value LOW or HIGH is displayed at the right of the pictogram to indicate if the voltage is too low or too high.

#### **NOTE**

*This pictogram will illuminate for a few seconds after the engine is started because of the voltage drop when the starter is engaged.*

#### **NOTE**

*This pictogram may appear as a reminder to connect the battery charger if the ignition switch is left in the "ON" position for twenty minutes with the engine not running and parking brake set.*

#### **NOTE**

*To identify the battery problem (too high, too low or not equalized voltage), using the DID menus, perform a system diagnostic by selecting DIAGNOSTIC, VIEW ACTIVE FAULTS, ELECTRICAL SYSTEM and see the fault messages.*

#### **NOTE**

*To prevent discharge of the batteries when the engine is not running, some functions are automatically switched off if the battery voltage drops below 24.0 volts for more than 30 seconds. Set the ignition key to the OFF position and then turn the ignition key to the ON position to reactivate the functions for a period of 30 seconds before they switch off again.*

#### **NOTE**

*If the battery equalizer indicator illuminates, make sure that the battery equalizer circuit breakers are reset before requesting breakdown assistance. Wait 15 minutes after setting breakers to allow batteries to equalize. The breakers are located in the main power compartment.*



### Engine Door Ajar

This pictogram indicates that the engine compartment door is ajar.



### Emergency window open

This pictogram indicates that an emergency window is open or unlocked.



### Baggage Compartment Door Ajar

This pictogram indicates that one or more baggage bay doors are ajar.

## 4-68 Controls and Instruments

### Pop-up Pictograms



#### Low Windshield Washer or Headlights Washer Fluid Level

Illuminates when the windshield washer or the headlight washer fluid level is low. The washer fluid containers are located inside the front service compartment.



#### WARNING

Do not drive without sufficient washer fluid.



#### Wheelchair lift

This pictogram indicates that the wheelchair lift system is enabled and the wheelchair access door or the lift compartment door is open. It is necessary to stow the wheelchair lift, close the doors and set the wheelchair lift system enable switch to the OFF position to permit release of the parking brake.



#### Lavatory Occupied

This pictogram indicates that the lavatory compartment is occupied. This pictogram will appear only when the engine is shut down in order to advise the driver of the presence of a passenger in the lavatory compartment during a stop.



#### Lavatory compartment emergency call

If the vehicle is moving, this pictogram indicates that a passenger has activated the lavatory compartment emergency call button.



#### Differential lock (option)

This pictogram indicates that the differential action is locked.



#### Freezing conditions

This pictogram appears when the temperature is in the range between 0°C and 2°C (32°F et 35°F), when the road is most slippery.



#### Fuel level

This pictogram appears when approximately 26 US gallons (98 liters) of fuel remains in the tank. Refuel as soon as possible.



#### Automatic traction control

This pictogram appears when the automatic traction control system intervenes to prevent excess wheel spin during acceleration.



#### Parking brake applied



#### DPF regeneration



**Pop-up Pictograms**



**High exhaust gas temperature**

This pictogram appears to notify the driver of potentially hazardous exhaust gas temperature at the DPF outlet.



**WARNING**

During regeneration, exhaust temperature may reach up to 1200°F (650°C) at the particulate filter. When parking the vehicle, if this pictogram is displayed, make sure that the DPF outlet diffuser is away from people or any flammable materials, vapors or structures.



**Fuel Economy**

This pictogram is displayed with fuel consumption value of the vehicle. Proper units for the displayed value are written under the pictogram: liters/100 km, km/liter, mpg, and liters/hour.



**Percentage of Trip Made Using Regenerated Electricity**

This pictogram is displayed with the percentage of trip done with electricity produced with engine negative torque (braking, deceleration).



**Leg Fuel Consumption**

This pictogram is displayed with the value for the fuel consumption for the current leg.



**Trip Data**

Function of the DID's "Time/Distance" menu. Refer to ["DRIVER INFORMATION DISPLAY \(DID\) MENUS" on page 11](#) in *Section 5 Other Features*.



**Estimated Time of Arrival**

Function of the DID's "Time/Distance" menu. Refer to ["DRIVER INFORMATION DISPLAY \(DID\) MENUS" on page 11](#) in *Section 5 Other Features*.



**Fuel Filter/Water Separator**

Indicates that draining of the fuel filter/water separator is required. See ["PRIMARY FUEL FILTER" on page 12](#) in *Section 8 Care And Maintenance*.



**Raised tag axle**

This pictogram appears if the vehicle speed exceeds 12 mph (20 km/h) while the tag axle is raised.



**Cooling fans low voltage**

This pictogram indicates that battery voltage is too low for proper fan operation.



**Low buoy & Kneeling**

This pictogram appears if the vehicle speed exceeds 12 mph (20 km/h) while the front suspension of the vehicle or the entire vehicle suspension is lowered.

### Pop-up Pictograms



#### Fire in engine compartment

This pictogram appears if a fire is detected in the engine compartment while the vehicle is on the road. An audible alarm informs the driver when a fire is detected. In case of fire detection when parked (parking brake applied, engine running or not), the electric horn is activated to alert the driver. Refer to ["AUTOMATIC FIRE SUPPRESSION SYSTEM \(AFSS\)" on page 5](#) in Section 7 Safety Features and Equipment.



#### WARNING

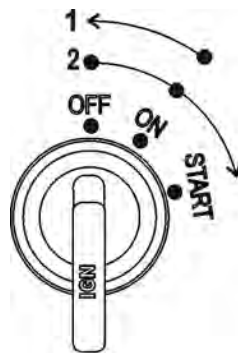
In case of a fire, stop the vehicle immediately, stop the engine and evacuate the vehicle.

#### NOTE

*It is possible to cancel an alarm while on the road. To do so, stop the vehicle and perform this ignition switch (key) sequence.*

*From the ON position, turn to OFF, return to ON and START the vehicle within two seconds.*

*To stop the electric horn alarm when parked, cycle the ignition between the ON and OFF position twice within 3 seconds.*



06354-5











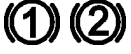
#### NOTE

*To stop the electric horn alarm when parked, cycle the ignition between the on and off position twice within 3 seconds.*

*For the location of the extinguisher, refer to ["FIRE EXTINGUISHERS "](#) on page 4 in Section 7 Safety Features And Equipment.*

**STATUS BAR PICTOGRAMS**

These pictograms will appear in the status line of the DID.

| Status Bar Pictograms   |  |
|---|--|
| PICTOGRAM   | DESCRIPTION  |
|    | <b>Message Active</b>  |
|    | <b>Alarm Clock Activated</b>   |
|    | <b>Raised Tag Axle</b>   |
|    | <b>Kneeling/Front Suspension Hi-Buoy Active</b><br>This pictogram appears if the vehicle speed exceeds 12 mph (20 km/h) while the front suspension of the vehicle (kneeling – solid ON pictogram) or the entire vehicle suspension is lowered (low buoy – blinking pictogram).                       |
|    | <b>Baggage Compartments Locked</b><br>Confirms that all the baggage compartment doors are locked.  |
|  | <b>Baggage Compartments Unlocked</b><br>Indicates that at least one baggage compartment door is unlocked.  |
|  | <b>Adaptive Cruise with Braking (ACB) Not Available</b><br>Indicates that the Adaptive Cruise with Braking system is disabled.   |
|  | <b>Engine Brake</b><br>Engine brake is disabled (OFF mode).  |
|  | <b>Engine Brake - Auto Mode</b><br>Indicates that the engine brake is in the AUTO mode. When using this mode, the engine brake is activated when pressing on the brake pedal.<br>The engine brake is by default set to AUTO mode when the vehicle ignition switch is cycled from OFF to ON position. |
|  | <b>Low Brake Air Pressure</b><br>Warns the driver that the brake air system pressure of the primary or/and secondary system has decreased below 85 psig. Do not drive the coach when the brake air pressure is low.  |
|  | <b>Engine Brake – Engine Brake Low (1) And Engine Brake High (2)</b><br>Confirms which engine braking power is selected with the steering wheel control buttons.   |

## 4-72 Controls and Instruments

### Status Bar Pictograms



#### Allison Transmission Retarder

Confirms that the Allison transmission retarder is off.



#### Allison Transmission Retarder – Braking Level 0, 1, 2, 3, 4, 5, 6

Confirms the retarder hand lever position. Each position corresponds to a given braking level. Refer to [TRANSMISSION RETARDER](#) in this section.

TEST

#### Vehicle Test

Confirms that one of the vehicle test modes is active. For further information about the available test modes, refer to ["DIAGNOSTICS MENU" on page 19](#) in *Section 5 Other Features*.

## STEERING COLUMN CONTROLS

Many of the most frequently used controls are conveniently placed on the steering column or the steering wheel. The multi-function lever is located on the left side of the steering wheel while the optional transmission retarder lever is located on the right side of the steering wheel. Switches for the electric horn and the air horn are located directly on the steering wheel.

### MULTI-FUNCTION LEVER

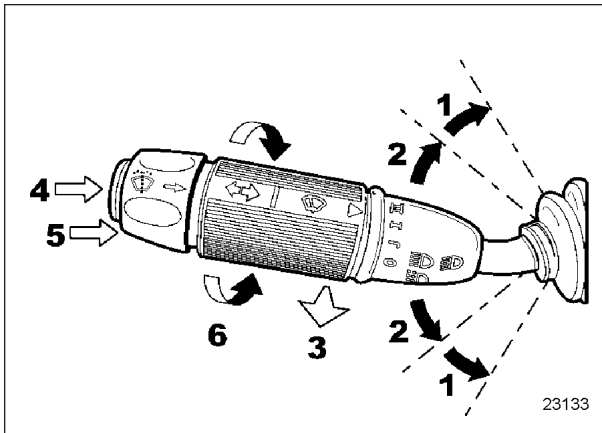


FIGURE 28: MULTI-FUNCTION LEVER

The multi-function lever is used to operate the following:

#### (1) Turn Signal

Move the lever all the way up until it locks in position to signal a right turn. Move the lever all the way down until it locks in position to signal a left turn. The lever automatically returns to the horizontal OFF position once the turn is completed.

#### (2) Lane Change Signal

Move the lever part way to the catch position and hold until the lane change maneuver is completed. The lever will spring back into the OFF position once released.

#### (3) Headlight Beam Toggle Switch

Toggle between high and low beams by pulling the lever up towards you. To flash the headlights, pull the lever up halfway. The lever will spring back into normal position once released.

#### (4) Courtesy Blinkers

Clearance and parking lights can be flashed by pressing the button located on the lever tip.

#### (5) Windshield Washer Control

Push the external ring at the end of the lever towards the steering column to activate the windshield washers. The wipers come On and continue wiping for a few seconds after the ring is released.

If equipped with the Video Camera Mirror System, activation of the windshield washers produces a jet of compressed air to clean the camera lens protectors.



#### WARNING

Before using the windshield washers in cold weather, heat the windshield with the defroster to prevent icing and reduced visibility.



#### CAUTION

To avoid damaging the pump mechanism, do not use the windshield washer when the fluid level is very low or empty.

#### (6) Windshield Wipers

Turn the lever counterclockwise to activate the windshield wipers. The first position activates the wipers intermittently. The second position is the slow speed and the third position is for high speed wiping.



#### CAUTION

To avoid scratching the windshield, do not operate the wipers when the windshield is dry. To avoid damaging the wiper motor, free wiper blades that may be frozen to the windshield before operating the wipers.

## 4-74 Controls and Instruments

### STEERING WHEEL CONTROLS

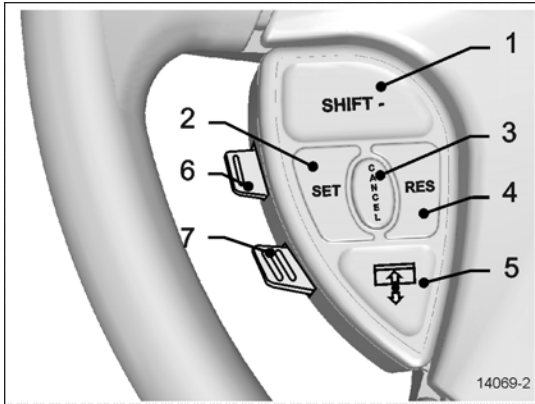


FIGURE 29: LEFT STEERING WHEEL CONTROLS

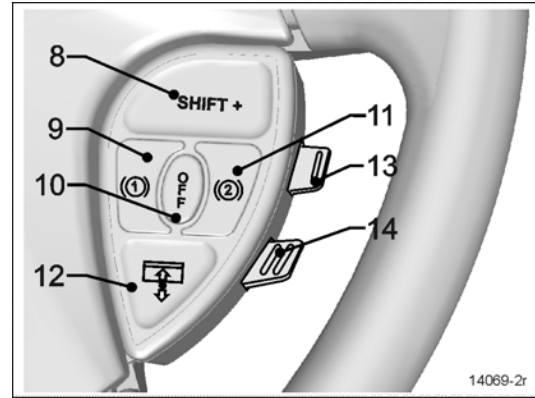


FIGURE 30: RIGHT STEERING WHEEL CONTROLS

#### THE STEERING WHEEL CONTROLS INCLUDE THE FOLLOWING FUNCTIONS:

##### 1, 8 Shift Down, Shift Up (I-Shift Transmission Only)

Use these buttons to shift down or shift up manually the transmission range as would do the “-” & “+” keys on the I-Shift gear selector keypad.

##### 2, 3, 4 Set, Cancel, Resume (Cruise Control)

For cruise control operating instructions, refer to [“CRUISE CONTROL” on page 13](#) in this section.

##### 5, 12 Left Sunshade

Press and hold the button to lower the left sunshade. Press twice rapidly and hold the button to raise the left or right sunshade.



#### CAUTION

Do not attempt to raise or lower these shades manually. Damage to the electric motor or roller mechanism could result.

##### 6 Escape/Enter (Driver Information Display)

Enter: Lift this button briefly.

Escape: Press briefly on this button.

##### 7 Up/Down (Driver Information Display)

Use this button to scroll up or down through the menus.

##### 9 Retarder / Engine Brake Low

If the vehicle is equipped with a transmission retarder, press this button to enable the transmission retarder. Afterwards, operate the transmission retarder with the hand lever mounted on the steering wheel or the brake pedal. For more information about the operation of this system, refer to “transmission retarder” heading in this chapter.

On vehicles equipped with an engine brake, the engine brake provides two levels of braking power. Press this button for low engine braking power (about 50 % of full braking power). Refer to [“VOLVO ENGINE BRAKE \(VEB\)” on page 28](#) in Section 5 Other Features for more information about the engine brake operation and AUTO

**10 Retarder / Engine Brake Off**

Press this button to cancel operation of the transmission retarder.

On vehicles equipped with engine brake, this button is a momentary switch that will cancel the Engine Brake LOW ① or Engine Brake HIGH ② mode and switch the engine brake to AUTO ③ mode. On vehicles so equipped, an engine brake switch located in the dashboard can be used to cancel completely (OFF mode) the engine brake.

**NOTE**

*Engine brake is safe to use in any road conditions including adverse conditions.*

**11 Retarder / Engine Brake High ②**

If your vehicle is equipped with a transmission retarder, this button has the same effect as the retarder/engine brake LOW ① button.

On vehicles equipped with engine brake, pressing this button will permit full application of the engine brake (100 % of braking power). Refer to "[VOLVO ENGINE BRAKE \(VEB\)](#)" on page 28 in Section 5 Other Features for more information concerning the engine brake operation and AUTO ③ mode.

**12 Right Sunshade**

Press and hold the button to lower the right sunshade. Press twice rapidly and hold the button to raise the left or right sunshade.



**CAUTION**

Do not attempt to raise or lower these shades manually. Damage to the electric motor or roller mechanism could result.

**13 Volume (Dashboard Radio)**

Use this button to increase or decrease the dashboard radio (driver's radio) volume.

**14 Seek (Dashboard Radio)**

Use this button to seek up or down for a radio station.

## 4-76 Controls and Instruments

### HORNS

The electric horn (city horn) and air horn (highway horn) are operated from the steering wheel center pad. Use the Horn Selector switch located on the lateral control panel to select the appropriate horn type.

#### NOTE

*When the vehicle is stationary, the electric horn will sound to inform the driver that a fire is detected in the engine compartment.*

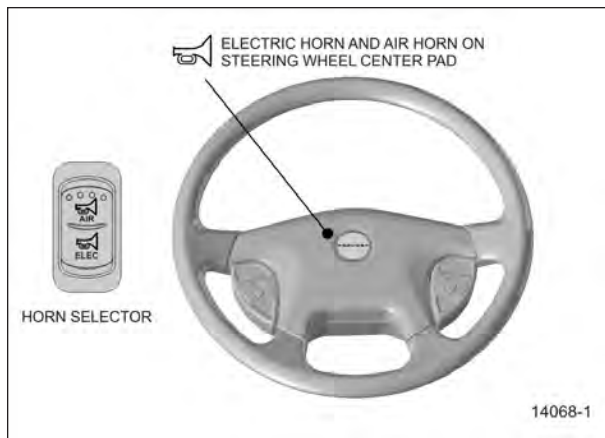


FIGURE 31: STEERING WHEEL

### FOOT-OPERATED CONTROLS

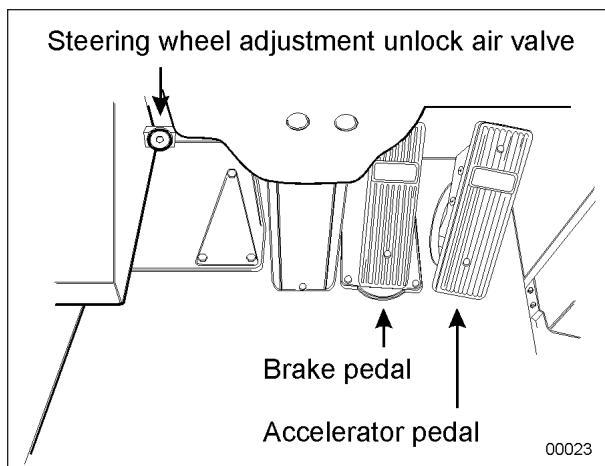


FIGURE 32: FOOT OPERATED CONTROLS

### BRAKE PEDAL

The coach is equipped with a dual braking system. The front brakes operate from a different air source than the drive and tag axle brakes.

The dual braking system becomes a modulated emergency system if a pressure drop occurs in the primary brake system (rear brakes).

Service brakes are applied by depressing the brake pedal. Braking increases with the amount of pressure applied to the foot pedal. Refer to ["ANTILOCK BRAKING SYSTEM \(ABS\)" on page 29](#) in Section 5 Other Features . When the brake pedal is depressed, the brake lights turn on automatically.

For safe and effective braking, the air system pressure should reach at least 95 psi in both the primary and secondary circuits.

A warning light and an audible alert will sound when the air pressure in either the primary or secondary circuit drops below 85 psi. If this occurs, stop the coach; determine the cause of the pressure loss before proceeding. The brake pedal can be used in conjunction with the transmission retarder. Refer to ["TRANSMISSION RETARDER" on page 1](#) in this section.



#### DANGER

Immediately report any brake system problem to your company or directly to the nearest Prevost or Prevost-approved service center.

Do not "fan" or "pump" the brake pedal. This practice does not increase brake system effectiveness but rather reduces system air pressure thereby causing reduced braking effectiveness.



#### CAUTION

"Riding" the brake by resting one's foot on the brake pedal when not braking can cause abnormally high brake temperature, can damage and cause premature wear of brake components and reduce brake effectiveness.

### ACCELERATOR PEDAL

Controls engine RPM as needed.



#### CAUTION

Do not let the engine operate above 2,450 rpm.



## STEERING WHEEL ADJUSTMENT

Push on the valve button with the left foot to unlock the steering wheel for tilt and telescopic adjustment.

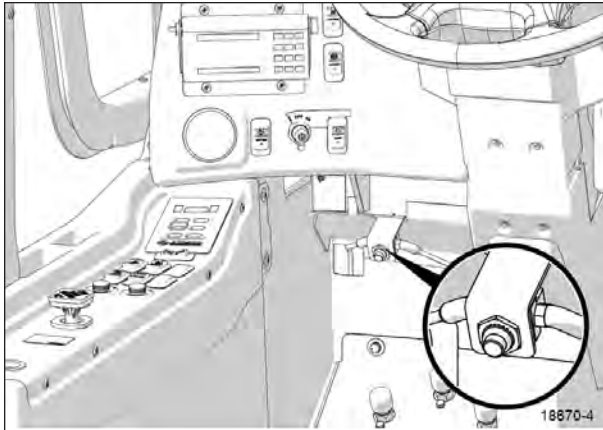


FIGURE 33: TILT AND TELESCOPIC ADJUSTMENT



### WARNING

Do not adjust the steering wheel while the vehicle is moving. Loss of control could result. Park the vehicle safely and apply parking brake before adjusting.

## ALLISON TRANSMISSION

The transmission is fully automatic: Proper ranges should be automatically selected according to driving speeds to improve vehicle performance and control. The speed ratio of the power converter changes automatically as vehicle speed increases and direct-drive goes in and out as necessary. The speed ratio is modulated by vehicle speed and accelerator pedal position. You will find the complete transmission operation instructions and driving tips in the *Allison 5th & 6th Generation Operator's Manual 3000\_4000 Series* available on the Prevost Technical Publications site.

### OPERATION

When a button is depressed on the transmission control pad, the corresponding letter or number is displayed indicating the transmission is ready to operate in the selected range. If the transmission control module (TCM) detects a serious problem

in the transmission, the CHECK telltale lights on the dashboard.

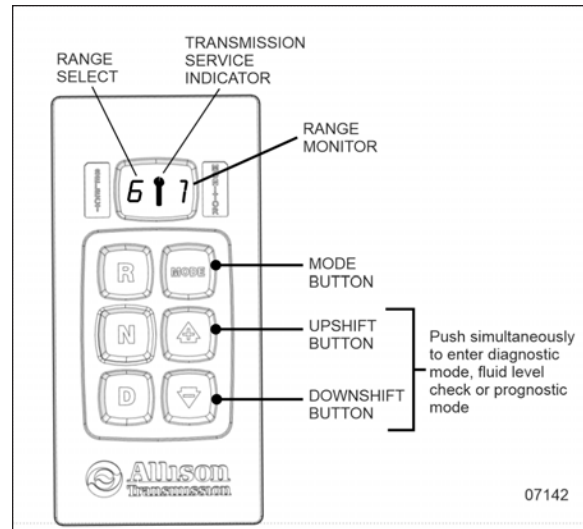


FIGURE 34: ALLISON PUSHBUTTON SHIFT SELECTOR

## PUSHBUTTON SHIFT SELECTOR

The pushbutton shift selector has the following elements:

**R:** Press to select Reverse gear.

**N:** Press to select Neutral.

**D:** Press to select Drive. The highest forward range available will appear in the digital display window under SELECT. The transmission will start out in the lowest available forward range, displayed under MONITOR, and advance automatically to the highest range.

⬆ ⬇ : Press respectively the ⬆ (Upshift) or ⬇ (Downshift) arrow button when in DRIVE to request the next higher or lower range. One press changes gears by one range. If the button is held down, the selection will scroll up or down until the button is released or until the highest or lowest possible range is selected. Protection mechanisms inhibit selecting ranges that are not appropriate for the current speed or which may damage driveline components.

**MODE:** Pressing the MODE button allows the driver to activate the secondary shift schedule that has been programed into the TCM unit.

## 4-78 Controls and Instruments

### PRIMARY AND SECONDARY SHIFT SCHEDULES


The primary shift schedule is the default mode at starting of the engine and is typically specified to accommodate normal vehicle operation. The transmission controller automatically selects between ECONOMY and PERFORMANCE shift strategy, based on the vehicle actual load and the grade on which the vehicle is operating. This is called Load Based Shift Scheduling (LBSS). This can produce improved overall vehicle fuel economy while still enabling high productivity when the vehicle is loaded.

In the secondary shift schedule, only the ECONOMY shift strategy is available. No switching is done between shift strategies. The secondary shift mode is available only if selected by the driver, using the MODE button. When the secondary mode is activated, "MODE" illuminates on the display.

#### NOTE

*When the diagnostic display mode has been entered, the MODE button is used to view and toggle through diagnostic code information. Refer to appendix C for more details about diagnostic code display procedure and fluid level check using the pushbutton shift selector.*

### TRANSMISSION SERVICE INDICATOR

: This indicator will be illuminated upon the detection of a service issue relating to clutch, filter or fluid life. The appearance of the indicator (lit steadily, flashing, etc.) varies for each of the conditions monitored by the system. Refer to the Allison transmission Appendix for more details about diagnostic code display procedure, fluid level check or prognostic features (Oil Life Monitor, Filter Life Monitor and Transmission Health Monitor) using the pushbutton shift selector.

Illuminated at startup for a bulb check, this indicator will then be turned off if no service conditions exist.

### DESCRIPTION OF AVAILABLE RANGES

#### R (Reverse)

Press the «R» button to select reverse. Completely stop the vehicle and let the engine return idle before shifting from forward range «D» to reverse «R» or from reverse to forward range. The reverse warning signal will be activated when this range is selected.

#### N (Neutral)

Use this position to start the engine. Select «N» (Neutral) when checking vehicle accessories and for extended periods of engine idle operation; parking brake must then be applied. The pushbutton shift selector automatically selects «N» (Neutral) when the ignition switch is turned On.

#### NOTE

*The automatic transmission does not have a park «P» position. Select «N» (Neutral) and apply parking brake when the vehicle is left unattended. An audible alert will sound if the engine is stopped and the parking brake is not applied.*



#### WARNING

Before leaving the driver's seat, always put the transmission in NEUTRAL and apply parking brake.



#### WARNING

The vehicle service brakes or park brake must be applied whenever NEUTRAL is selected to prevent unexpected vehicle movement.



#### CAUTION

Do not allow your vehicle to "coast" in neutral «N». This practice can result in transmission damage. Also, no engine braking is available in neutral.

**D (Drive)**

Use this position for all normal driving conditions. After touching this pad, the vehicle will start in first or second range and will automatically upshift to a higher range as output speed increases. As the vehicle slows down, output speed decreases, the transmission automatically downshifts to the correct range. If a locked brake or a slick surface condition should occur, the TCM (Transmission Control Module) will command converter operation (disconnect lockup) and inhibit downshift for a period of time or until normal wheel speed has been restored.

**NOTE**

*IMPORTANT: Brake pedal must be applied when selecting «D» (Drive) otherwise the transmission will stay in «N» (Neutral).*

**NOTE**

*The transmission should normally be allowed to shift by itself, but manual shifting can be done as described below.*

**1 (First Range)**

Select this range when pulling through mud and snow, when speed control is needed for driving up or down steep grades or when maneuvering in tight spaces. This range also provides maximum driving torque and engine braking power or retarder braking effect. In the lower ranges (1, 2, 3 and 4), the transmission will not upshift above the highest gear selected unless engine overspeed is detected.

**2 (Second Range)**

Select this range when operating in heavy and congested traffic. The transmission will start in first and automatically upshift to second. When slowing, the transmission will automatically downshift to first range. Low ranges provide progressively greater engine and retarder braking power (the lower the range, the greater the engine and retarder braking effect).

**3, 4 (Third And Fourth Ranges)**

Select these ranges when driving on moderate grades or when load and traffic conditions limit speed.

**WARNING**

Service brakes should not be used to control the speed of the vehicle on long, steep descents. Instead, lower transmission ranges should be used in conjunction with the output retarder.

**CAUTION**

When descending in lower ranges, care must be taken that engine speed does not exceed 2,450 rpm.

## VOLVO I-SHIFT TRANSMISSION

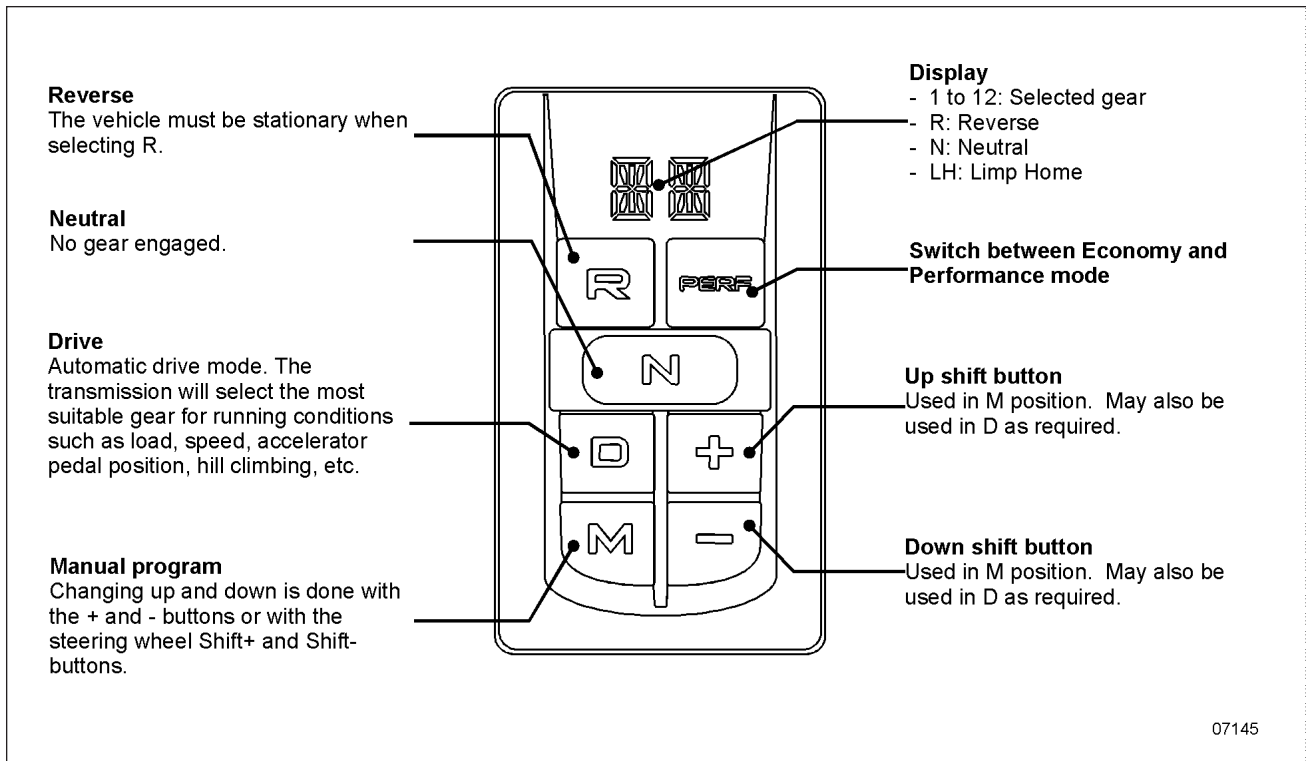


FIGURE 35: I-SHIFT PUSHBUTTON SELECTOR

The I-Shift transmission is an automated gearbox with 12 forward gears and 2 reverse gears. The clutch operation and gear shifting are fully automatic so that the driver can concentrate on the traffic.

## PUSHBUTTON SHIFT SELECTOR

The pushbutton shift selector has four gear positions: R, N, D and M.

R= Reverse

N= Neutral

D= Drive

M= Manual program

It is not possible to shift either directly from R position to D or M position nor from D or M position to R position. N position must be selected first. If the driver executes such gear shifts, the transmission will shift automatically to N position.

R ⇔ N ⇔ D or M

## DISPLAY

Status of the I-Shift transmission is shown on the Driver Information Display (DID). Displayed information is position, selected gear and driving mode.

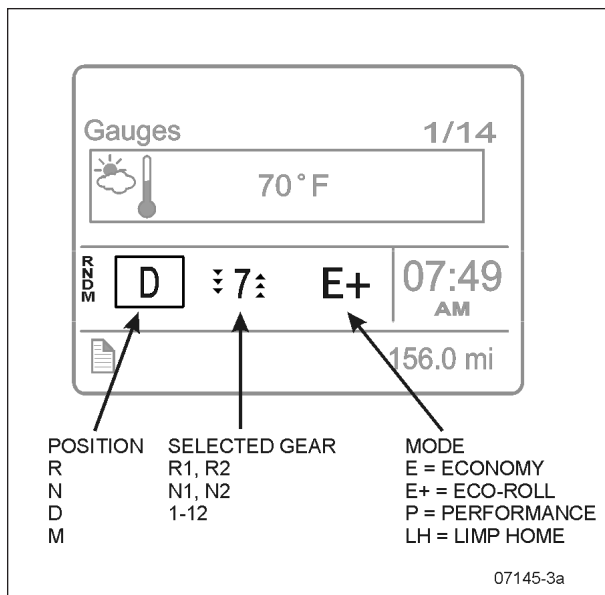


FIGURE 36: I-SHIFT PUSH BUTTON SELECTOR

## ACCELERATOR PEDAL

When changing gear, the accelerator pedal should not be released. The system will govern the clutch, gearbox and engine speed. The system selects the gear and the point in time for gear changing for optimum driving performance

based on the accelerator pedal position, road inclination, etc.

## ECONOMY AND PERFORMANCE MODE

When the engine is started, the transmission is in Economy mode. The transmission automatically selects shift points and engine parameters to maximize fuel economy. Economy mode is primarily used when driving under normal conditions.

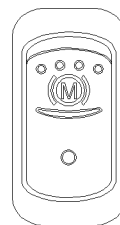
The Performance mode gives driveability the highest priority for optimum driving in traffic condition and gradeability.

### NOTE

Operating the vehicle in Performance mode for extended periods can result in a loss of fuel economy.

## ECO-ROLL MODE (FREEWHEEL FUNCTION)

Eco-Roll reduces fuel consumption by automatically disengaging the driveline when the engine is not needed to maintain vehicle speed. When Eco-Roll is active, the engine speed is temporarily reduced to idle. Eco-Roll can be used during normal driving with the accelerator pedal or while in cruise control mode.




Eco-Roll is only available when the engine brake is in Auto mode (A). First, set the dashboard Engine Brake switch to the ON position.

When Eco-Roll is enabled, the DID shows E+. When Eco-Roll intervenes, the selected gear displayed in the DID (7–12) will change momentarily to N1 or N2.

Eco-Roll disengages as soon as the brake pedal or the accelerator pedal is depressed, but it remains available. To disable Eco-Roll, set the dashboard Engine Brake switch to the OFF position. Eco-Roll is not available when the Engine Brake Low (1) or Engine Brake High (2) modes are selected.

## 4-82 Controls and Instruments

When Eco-Roll is enabled, it activates automatically, but only when the following conditions exist:

- Accelerator pedal is released.
- Service brake is released.
- Engine brake is in Auto mode .
- Transmission pushbutton shift selector is in the D position
- Transmission is operating in the Economy mode.
- Vehicle is operating on a downhill or uphill grade not greater than 2%.
- Selected gear is greater than 6.
- Brake cruise set speed is greater than 3 mph (5 km/h) above cruise set-speed.
- Vehicle speed is less than 78 mph (125 km/h).
- Electronic Stability Control (ESC) and antilock brake system (ABS) are not active.
- Exhaust Aftertreatment System regeneration is not active.

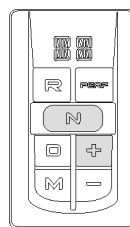
### LIMP HOME MODE

Limp home is an emergency mode that can be engaged if a fault has occurred in the gearbox that prevents the vehicle from being driven in automatic, manual or reverse modes.

#### **NOTE**

*Limp Home mode should only be used for moving short distances.*

### To Activate The Limp Home Mode



- Simultaneously press **N** and **+** buttons. Activating can only be done while the vehicle is stationary.
- Select **M** position or **R** position as required.

The driver can select gears for forward driving or for reversing using the **+** and **-** button when position **M** (manual program) or **R** (reverse) is selected.

The following gears are available:

Forward driving - 1, 3 & 5

Reverse driving - R1

To select the reverse driving in Limp Home mode, simply select position **R**. Gear changing can only be done while the vehicle is stationary.

### To Deactivate The Limp Home Mode

The Limp Home Mode will be deactivated when the ignition is turned off.

## STARTING AND STOPPING

Closely follow the procedures below to start and stop the vehicle.

### Starting

The pushbutton shift selector must be in the N position or the engine will not start. If the pushbutton shift selector is not in neutral, a starter protection message will appear in the DID along with the Information telltale and an audible warning.

If there is not enough air pressure in the I-Shift air tank, a low air supply message will appear in the DID along with the Information telltale light and an audible warning. Start the engine and allow the air pressure to build in the tank. Wait until the message and the telltale light turn off before attempting to shift the transmission into gear.

The brake pedal must be pressed down when passing from the N position to another position otherwise pressing the buttons will have no effects.

## Stopping

When parking the vehicle, always apply the parking brake and place the pushbutton shift selector to the N position. Make sure the parking brake is holding the vehicle before leaving the driver position. Failure to do so can result in unexpected vehicle movement and can cause serious personal injury or death.

When the vehicle is stopped:

1. Apply the parking brake.
2. Select the N position on the pushbutton shift selector.
3. Turn off the engine.

## STARTING THE VEHICLE UPHILL AND DOWNHILL

### Hilly Operating Conditions

When starting the vehicle on an uphill slope:

1. Press the brake pedal.
2. Select the D position on pushbutton shift selector. The driver can use the – button to select a lower start gear if wanted.
3. Quickly move your foot from the brake pedal and completely depress the accelerator pedal.



### CAUTION

Always use the brakes to hold the vehicle stationary on an uphill stop. Never hold the vehicle stationary on an uphill slope using the accelerator pedal. The clutch could overheat, which could cause it to break down.

The I-Shift transmission clutch is a dry disc type, with no torque converter. Never allow the clutch to slip in too high a gear when starting the vehicle. If the clutch overheats, a high clutch load message or clutch protection active message will appear in the DID along with the Check telltale light and an audible warning.



### DANGER

The vehicle can roll when stopped on a hill or grade, or when the vehicle is starting from a stop on a hill or grade. Always use the brakes to hold the vehicle stationary on a hill or grade. Failure to do so can result in serious personal injury or death.

### Hill Start Assist

Hill Start Assist provides anti-roll assistance during the transition from standing still to starting on a grade. The brake system maintains pressure in the brake chambers for 3 seconds after the service brake pedal is released, which allows time for the driver to move his foot from the brake pedal to the accelerator pedal.

Hill Start Assist is only intended to temporarily hold the vehicle on a grade before the vehicle is put into motion. The vehicle brake must be applied, independent of Hill Start Assist, to hold the vehicle on a grade for an extended period of time.

When available, Hill Start Assist is enabled at starting of the engine. The Hill Start Assist telltale light in the instrument cluster will blink to indicate that the feature is temporarily disabled. If a Hill Start Assist fault occurs, the Hill Start Assist telltale light in the instrument cluster will illuminate and the feature is permanently unavailable until the fault is repaired.

When Hill Start Assist is enabled, it activates automatically, but only when the following conditions exist:

- Vehicle speed is zero.
- Vehicle is on an incline or decline greater than 2%.
- Shift selector is in the D position on an incline or R position on a decline.
- Service brake is applied.
- ESC (Electronic Stability Control) is functioning normally.
- There has been no ESC activity in the preceding stops.

## 4-84 Controls and Instruments

When the service brake pedal is released, the brakes are applied for approximately 3 seconds or until the accelerator pedal is depressed, whichever occurs first.


### **WARNING**

Always apply parking brake before leaving driver's seat. The driver must not leave the vehicle when the engine is running and a gear is selected.

## DRIVING

The most efficient way to operate the vehicle is to use the automatic drive program, which is the D position on the pushbutton shift selector. Gear changing is automatic and the driver can concentrate on the road ahead.

### **NOTE**

*When driving in automatic drive mode (position D), the engine brake control should be in the Auto mode  to maximize the integration of the transmission and brake system according to Eco-Roll mode. This means optimum performance and fuel economy at all times.*

## D Position

With the pushbutton shift selector in the D position, the transmission will automatically upshift and downshift as necessary to maintain the desired vehicle speed for the current driving conditions.

At starting of the vehicle, the gearbox selects between gear 1-6 the most suitable start gear with respect to weight and road's gradient. The driver can select a pulling away gear different than the one selected by using the + and - buttons.

When the vehicle is moving in automatic drive mode, the driver can intervene manually, while maintaining the accelerator pedal depressed, by selecting a higher or lower gear using the + and - buttons. The arrows in the display show how many gears are available to change up or down.

Whenever gear changing is not desired while in automatic drive mode, change the pushbutton shift selector from D to M. No further gear changes will be carried out and the current gear will remain engaged.



## CAUTION

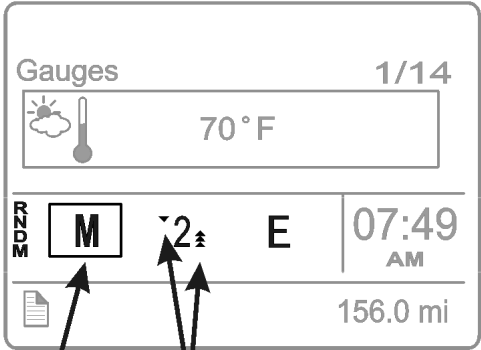
There is a risk of over-revving the engine when the transmission is locked in a gear. Damage to the engine may occur. To lock the transmission in the current gear, change the pushbutton shift selector from the D position to the M position. This function can be used for all 12 forward gears. To return to the automatic drive mode, set the pushbutton shift selector back to the D position.

## M Position

It is possible to drive the vehicle with full manual gear changing or take over from the automatic gear changing system whenever required. Gear changing is done by first selecting the manual position M.

In manual shift mode, the driver use the + and - buttons to select gears.

The transmission will not automatically change gears as the driving conditions change. The current gear is displayed in the DID along with the up and down arrows. The number of available upshifts and downshifts will change as driving conditions change.



The diagram shows a section of the instrument cluster display. At the top, it says "Gauges" and "1/14". Below that is a weather icon and "70° F". In the center, there is a box with "M" (Manual mode) and "E" (Eco mode). To the right of "M" is a gear indicator showing "2" with up and down arrows. Below "M" is a document icon. To the right of "E" is the time "07:49 AM". At the bottom right, it shows "156.0 mi".

**POSITION**  
M= Manual

**AVAILABLE UPSHIFTS AND DOWNSHIFTS IN MANUAL MODE**

- ▲▲▲ 3 GEARS UP
- ▲▲ 2 GEARS UP
- ▲ 1 GEAR UP
- ▼ 1 GEAR DOWN
- ▼▼ 2 GEARS DOWN
- ▼▼▼ 3 GEARS DOWN

06741-5



When changing a gear, the accelerator pedal should not be released.



### CAUTION

Starting in too high a gear exposes the clutch to high levels of wear.



### CAUTION

The driver must avoid over-revving the engine.

### R Position

The system will select R2 automatically when the pushbutton shift selector is set to R, but if wanted, the driver can select R1 as reverse gear manually using the – button. During reverse, it is possible to shift between gear R1 and R2 using the + and – buttons.

### TOWING RECOMMENDATIONS



### CAUTION

When towing the vehicle, the transmission output shaft must not be allowed to spin or turn. If the vehicle is towed with the drive wheels still in contact with the road surface, the vehicle axle shafts or driveline must be removed or disconnected. Do not attempt to push or pull-start the vehicle.

Failure to disconnect the driveshaft, remove the drive axle shafts or lift the drive wheels off the ground before towing will cause serious damage to transmission.

Non-compliance with the above requirements will void the warranty.



### CAUTION

Make sure axle shafts or driveshaft are installed correctly after towing. Tighten axle shaft and driveshaft nuts to the correct torque settings. Do not invert shafts.



## SECTION 5 - OTHER FEATURES

|  |           |
|--|-----------|
| <b>EXHAUST AFTERTREATMENT SYSTEM</b> .....   | <b>3</b>  |
| FILTRATION AND REGENERATION UNIT .....   | 3         |
| PASSIVE REGENERATION .....   | 3         |
| ACTIVE REGENERATION .....  | 3         |
| STATIONARY (PARKED) REGENERATION .....   | 3         |
| DEF CLOGGING SEQUENCE – INSTRUMENT CLUSTER TELLTALE LIGHT .....                          | 4         |
| SELECTIVE CATALYTIC REDUCTION UNIT .....   | 5         |
| DRIVER WARNING AND INDUCEMENT MEASURES .....   | 7         |
| <b>DRIVER INFORMATION DISPLAY (DID) MENUS</b> .....                                      | <b>11</b> |
| GAUGES .....   | 12        |
| FUEL DATA .....  | 14        |
| TIME/DISTANCE .....  | 15        |
| VEHICLE MESSAGES .....   | 16        |
| RESET TRIP DATA .....  | 16        |
| DISPLAY SETTINGS .....   | 16        |
| DIAGNOSTICS MENU .....   | 19        |
| PRE-TRIP ASSISTANCE (OPTION) .....   | 20        |
| DATA LOG .....   | 22        |
| AFTERTREATMENT .....   | 23        |
| PASSWORD .....   | 25        |
| PREVOST LIAISON (OPTION) .....   | 25        |
| <b>INTELLIGENT SLEEP MODE (ISM)</b> .....  | <b>27</b> |
| <b>TRANSMISSION RETARDER (OPTION)</b> .....  | <b>27</b> |
| <b>ENGINE BRAKE</b> .....  | <b>27</b> |
| VOLVO ENGINE BRAKE (VEB) .....   | 28        |
| CRUISE CONTROL AND ENGINE BRAKE .....  | 28        |
| <b>ABS, TRACTION CONTROL SYSTEM (TCS) &amp; ELECTRONIC STABILITY CONTROL (ESC)</b> ..... | <b>29</b> |
| ANTILOCK BRAKING SYSTEM (ABS) .....  | 29        |
| TRACTION CONTROL SYSTEM (TCS) .....  | 29        |
| ELECTRONIC STABILITY CONTROL (OPTION) .....  | 29        |
| <b>DRIVER CONTROLLED DIFFERENTIAL LOCK (DCDL)</b> .....                                  | <b>30</b> |
| OPERATION TIPS .....   | 30        |
| LOCKING THE DCDL .....   | 31        |
| UNLOCKING THE DCDL .....   | 31        |
| <b>KNEELING SYSTEM</b> .....   | <b>31</b> |
| <b>HIGH-BUOY</b> .....   | <b>31</b> |
| <b>LOW-BUOY</b> .....  | <b>32</b> |
| <b>RETRACTABLE TAG AXLE</b> .....  | <b>32</b> |

## 5-2 Other Features

---

|   |           |
|---|-----------|
| <b>OPTIONAL AUTOMATIC TAG AXLE UNLOADING</b> .....                              | <b>32</b> |
| <b>PREHEATER</b> .....  | <b>32</b> |
| SWITCHING THE HEATER ON .....   | 33        |
| SWITCHING THE HEATER OFF .....  | 33        |
| COOLANT HEATER TIMER .....  | 33        |
| PREHEATER TROUBLESHOOTING AND MAINTENANCE .....                                 | 35        |
| <b>WHEELCHAIR LIFT SYSTEM</b> .....   | <b>36</b> |
| INTRODUCTION .....  | 36        |
| OVERVIEW .....  | 36        |
| GENERAL SAFETY PRECAUTIONS .....  | 38        |
| OPERATING INSTRUCTIONS .....  | 38        |
| MANUAL LIFT OPERATION .....   | 44        |
| <b>SEATS RECONFIGURATION</b> .....  | <b>50</b> |
| <b>WHEELCHAIR RESTRAINT SYSTEMS</b> .....                                       | <b>51</b> |
| 4-POINT SECUREMENT WITH FLOOR ANCHORAGE .....                                   | 51        |
| 4-POINT SECUREMENT WITH ANCHORAGE TO PASSENGERS SEAT PEDESTALS .....            | 52        |
| <b>WHEELCHAIR LIFT SYSTEM - THRESHOLD WARNING SYSTEM (TWS) ADJUSTMENT</b> ..... | <b>53</b> |
| ADJUST AIMING OF ACOUSTIC SENSOR BEAM .....                                     | 53        |
| TEST AIM OF ACOUSTIC SENSOR BEAM (WHEELCHAIR ACCESS) .....                      | 54        |
| ADJUST ACOUSTIC SENSOR TIMING .....   | 54        |
| <b>WCL CASSETTE INSTALLATION AND REMOVAL</b> .....                              | <b>54</b> |

## EXHAUST AFTERTREATMENT SYSTEM

The exhaust aftertreatment system consists of two units, the filtration and regeneration unit and the selective catalytic reduction SCR unit.

### FILTRATION AND REGENERATION UNIT

The main purpose of the filtration and regeneration unit is to capture and oxidize (regenerate) the particulate matter (soot) in the engine exhaust gas. The exhaust gas first enters the Diesel Oxidation Catalyst (DOC) and then flow through the Diesel Particulate Filter (DPF); together they capture and regenerate the soot on a regular or passive basis. Through constant monitoring of the exhaust gas temperature and the system back pressure, the engine control module is able to manage regeneration.

### PASSIVE REGENERATION

Passive regeneration is the process by which the particulate matter is oxidized due to the heat generated by the engine internal combustion process. During normal highway operation, exhaust temperatures alone are usually high enough to oxidize accumulating soot. In low ambient temperatures, however, or in some stop-and-go applications, the system needs a little help to regenerate, or clean itself. This process is called “active” regeneration.

### ACTIVE REGENERATION

Active regeneration is necessary when the engine internal combustion process alone does not generate enough heat. A dosing system injects a mist of diesel fuel into the exhaust system to increase and maintain the aftertreatment system temperature. Exhaust temperature must be above 572°F (300°C) to initiate the oxidation catalyst, which in turn oxidizes the injected diesel fuel molecules to achieve up to 1200°F (650°C) exhaust temperature at the particulate filter. This process of active regeneration takes place during the normal operation cycle of the vehicle without charges in performance or control for the operator. EPA2010 compliant and later Volvo engines produce less soot, so less active or stationary regeneration will be required.








### STATIONARY (PARKED) REGENERATION

In a small number of specific engine duty cycles, engine control module may not be capable of completing an active regeneration. In these situations, the operator will be notified that a stationary or parked regeneration may be required. A DPF telltale light will illuminate indicating the need for user interaction. The lamp gives the operator a grace period to allow this process to take place at a time when most convenient for the operator. This process requires the vehicle to be parked while a driver or maintenance technician initiates the regeneration process using the DID menus. Once initiated, the stationary regeneration process will be complete in about 45 minutes.

The driver will be notified of the need for a stationary regeneration (parked) by illumination of the DPF Regeneration telltale light.

## 5-4 Other Features

### DEF CLOGGING SEQUENCE – INSTRUMENT CLUSTER TELLTALE LIGHT

|         |   |   |
|---------|---|---|
| LEVEL 1 |  solid   | <p>REGENERATION NEEDED</p> <p>Diesel particulate filter is becoming full</p> <p>The DPF Regeneration telltale light illuminates to notify the driver that a stationary regeneration (parked) will be required soon. When this lamp is lit, initiate stationary regeneration process at an appropriate time of day.<br/> <b>THERE IS NO URGENCY AT THIS LEVEL.</b></p>   |
| LEVEL 2 |  flashing  | <p>REGENERATION REQUIRED</p> <p>Diesel particulate filter full</p> <p>If no DPF regeneration occurs after the initial DPF Regeneration telltale light illumination, the lamp will begin blinking and a stationary regeneration should be initiated as soon as possible in order to prevent Level 3.</p>   |
| LEVEL 3 |  flashing<br>+<br>  | <p>ATD SERVICE REQUIRED</p> <p>ENGINE DERATE ACTIVE</p> <p>Diesel particulate filter overfull</p> <p>If the flashing DPF Regeneration telltale light is still ignored, the CHECK telltale light will illuminate. In that situation, engine performance is limited. Perform a parked regeneration IMMEDIATELY to avoid further derate and prevent Level 4.</p>   |
| LEVEL 4 |  flashing<br>+<br><br>+<br> | <p>ATD SERVICE REQUIRED</p> <p>ENGINE SHUTDOWN ACTIVE</p> <p>A serious engine problem has occurred. The DPF may be over its maximum capacity.</p> <p>If a stationary regeneration is still not initiated, a standard Engine Protection Shutdown sequence will occur. All of the following dashboard lamps will be present:</p> <ul style="list-style-type: none"> <li>• Blinking DPF Regeneration telltale light;</li> <li>• Solid CHECK telltale light;</li> <li>• Solid STOP telltale light.</li> </ul> <p>Once engine derate and/or shutdown sequence is completed, a stationary regeneration must occur to continue vehicle operation. If the driver continues to operate the vehicle without regeneration, additional measures will be taken to protect the engine and ATD from damage, up to and including engine shutdown. Parked regeneration might no longer be possible.</p> <p><b>If engine protection has been initiated and forces the engine to shutdown, you can immediately RE-START the engine and perform the necessary steps in order to initiate a stationary regeneration.</b></p> <p style="text-align: center;"><b><u>Find and solve the cause of the shutdown</u></b></p> |

## Initiating A Stationary (Parked) Regeneration

### NOTE

At the starting of the engine, if a stationary regeneration is required, the engine coolant temperature must reach 140°F (60°C) before any stationary regeneration may be initiated and completed. Permit the engine to idle for a short while or drive the vehicle until engine temperature increases sufficiently.



### WARNING

Do not initiate a stationary regeneration in a closed area like a garage. Stationary regenerations must be undertaken outdoors only.



### WARNING

During stationary regeneration, exhaust temperature may reach up to 1200°F (650°C) at the particulate filter. Before initiating stationary regeneration, make sure that the DPF outlet diffuser is clear of objects and that no one is working near the DPF outlet diffuser.



### WARNING

Hot surfaces. Keep yourself clear of all hot Aftertreatment Device components, particularly during and after active or stationary regeneration. Hot surfaces can cause serious burns.

### NOTE

#### STATIONARY REGENERATION

*This process requires the vehicle to be parked while the driver or a maintenance technician initiates the regeneration process.*

The DPF Regeneration telltale light illuminates to notify the driver of the need and urgency of a manual stationary regeneration.



DPF REGENERATION telltale light

If stationary regeneration is not performed, this telltale light will blink, indicating that a stationary regeneration is required immediately. If stationary regeneration is still not performed, “engine power derate and shutdown” sequence may occur as per level 1 to level 4 sequence.

To initiate a stationary regeneration:

- Park the vehicle in a clear area, vehicle speed must be 0 mph (0 km/h);
- Engine must be on normal idle and fully warmed up (coolant temperature above 140°F/60°C);
- Apply parking brakes and set the transmission to neutral (N).
- Press the DID ENTER button and then get to the DID Aftertreatment menu. Select sub-menu Request Parked REGEN and press ENTER button to confirm and initiate regeneration.

The regeneration will begin. Turn off the air conditioning to reduce engine load. The engine idling speed will increase to 1600 rpm. Once the regeneration is completed, the engine speed will return to normal idle.

## Voluntary Interruption Of A Stationary Regeneration

It is possible to interrupt a stationary regeneration at all times. To do so, get to the DID's Aftertreatment menu, select Cancel REGEN and press ENTER button to confirm. You can stop regeneration simply by releasing the parking brake. Use this procedure in order to move the vehicle in a safe area only.

If regeneration is interrupted, it is very important to reinitiate the regeneration as soon as possible.



### CAUTION

If an active regeneration is stopped repeatedly, the vehicle may need to be taken to a service facility. The service facility will use a service tool to manually initiate the regeneration. Moreover, the interruption of active regeneration should not be considered as a normal practice. Some components of the aftertreatment system might be damaged in the long term.

## SELECTIVE CATALYTIC REDUCTION UNIT

Selective Catalytic Reduction (SCR) is a technology that uses Diesel Exhaust Fluid (DEF) and a catalytic converter to reduce nitrogen oxides (NOx) emissions.

## 5-6 Other Features

SCR is an exhaust aftertreatment system that injects a small amount of DEF into the exhaust gas between the DPF and the selective reduction catalytic converter. DEF turns to ammonia and carbon dioxide when heated. The exhaust stream then passes over a catalyst, the ammonia reacts with the NOx to form nitrogen and water vapor.

The basic elements of the SCR system consist of a 15.9 gallons (60 liters) DEF tank complete with pump, lines and heating system, a dosing injector, a catalytic converter and the control and monitoring system.

### Diesel Exhaust Fluid (DEF)

When handling DEF solution, keep electrical connectors properly connected or well capped, otherwise there is a risk that the DEF will cause oxidation that cannot be removed. Water or compressed air will not help, since DEF quickly oxidizes certain metals. If a disconnected connector comes into contact with the DEF solution, it must be replaced immediately to prevent the DEF solution from creeping further into the copper wiring, which takes place at a speed of about 2.4 in (60 mm) per hour.



#### CAUTION

Diesel Exhaust Fluid (DEF) is a nontoxic aqueous solution of urea (32.5%) and ultra-pure water (67.5%). Urea is a compound of nitrogen that turns to ammonia when heated. The fluid is non-flammable, and is not dangerous when handled as recommended. However, it is highly corrosive to certain metals, especially copper and brass.

When detaching hoses and components, do not spill DEF on disconnected or unsealed connectors. If DEF is spilled on a disconnected or unsealed connector, the connector must be removed immediately and replaced.

Things to know about spilled diesel exhaust fluid (DEF):

- If urea solution comes into contact with the skin, rinse with plenty of water and remove contaminated clothing.
- If urea solution comes into contact with the eyes rinse for several minutes and call for medical help if necessary.
- If inhaled breathe fresh air and call for medical help if necessary.
- Do not allow the DEF solution to come into contact with other chemicals.
- The DEF solution is not flammable. If the DEF solution is exposed to high temperatures, it breaks down into ammonia and carbon dioxide.
- The DEF solution is highly corrosive to certain metals, including copper and aluminum.
- If the DEF solution is spilled onto the vehicle, wipe off the excess and rinse with water. Spilled DEF solution can form concentrated white crystals on the vehicle. Rinse off these crystals with water.



#### CAUTION

##### DEF freezing and expansion

DEF will begin to crystallize and freeze at 12°F (-11°C). DEF expands by approximately 7% when frozen. During freezing weather, do not store a DEF container on the coach unless it is designed to allow for expansion.

Make sure the DEF container is not completely full. DEF expansion may split an inappropriate container, causing a spill and corrosion as a result.



#### WARNING

DEF spilled onto hot components will quickly vaporize. Turn your face away!



### Diesel Exhaust Fluid Consumption

DEF consumption is related to fuel consumption. In order to meet EPA requirements, DEF tanks are sized so one refill will be necessary for every two refills of the fuel tank.

### DRIVER WARNING AND INDUCEMENT MEASURES

Auxiliary Emission Control Device (EACD) defines as any element of design which senses temperature, vehicle speed, engine RPM, transmission gear, manifold vacuum, or any other parameter for the purpose of activating, modulating, delaying, or deactivating the operation of any part of the emission control system.













Disconnection of the following EACD produces immediate activation of the Malfunction Indicator Lamp MIL and **25% engine derate** after three (3) hours of a continuous open circuit condition.





- Intake throttle position sensor
- Ambient air temperature sensor
- Vehicle speed
- Engine oil pressure sensor
- Exhaust back pressure sensor
- Camshaft speed sensor
- EGR delta pressure
- Fuel rail pressure
- Engine timing sensor
- Engine coolant temperature
- EGR temperature sensor

Exhaust Aftertreatment System (EATS) components must not be removed, altered or modified in any way. In order to protect the emission control system from tampering, inducement measures will occur if the following states are detected:









- Disconnection of DEF tank level sensor
- Blocked DEF line or dosing valve
- Disconnection of DEF dosing valve
- Disconnection of DEF pump
- Disconnection of SCR wiring harness
- Disconnection of NOx sensor
- Disconnected exhaust temperature sensor
- Disconnected DEF temperature sensor
- Disconnected DEF quality sensor

## 5-8 Other Features

| DEF TANK LEVEL - DRIVER WARNINGS AND INDUCEMENTS |   |   |   |  |
|--|---|---|---|--|
| Conditions / Triggers                            |   | DEF Tank LOW LEVEL Indicator, DID Message and audible warning                                   |   | Inducement   |
| 1  | <b>Normal</b><br>DEF tank level sensor reads between 100% and 12%   | None  |   | None   |
| 2  | <b>Low DEF tank warning</b> <br>DEF tank level sensor reads between 12% and 0.1%   | <br>solid      | DEF TANK LEVEL LOW<br>REFILL DEF SOON TO PREVENT ENGINE DERATE<br> 3 beeps          | Warning message  |
| 3  | <b>DEF tank near empty</b> <br>DEF tank level sensor reads less than 0.1%  | <br>blinking   | DEF TANK EMPTY<br>REFILL DEF TO AVOID 5 MPH LIMIT<br>ENGINE IN DERATE<br> 3 beeps   | Engine torque reduction of 25%   |
| 4  | <b>DEF tank empty</b> and one (1) hour of operation in engine derate mode    | <br>blinking   | DEF TANK EMPTY<br>REFILL DEF TO AVOID 5 MPH LIMIT<br>ENGINE IN DERATE<br> 3 beeps | Engine torque reduction of 40%   |
| 5  | <b>DEF tank empty</b> and either  <ol style="list-style-type: none"> <li>Diesel fuel refueling done with a fuel level sensor reading increase of 15%, or more</li> <li>Vehicle stationary (speed=0) for 20 minutes with engine off or at idle</li> </ol> | <br>blinking | REFILL DEF TANK<br>VEHICLE SPEED LIMITED TO 5 MPH (8 KM/H)<br> constant tone      | Vehicle road speed limited (RSL) to 5 mph (8 km/h)<br><br>Note: The vehicle has to be stationary before 5 mph (8 km/h) road speed limit becomes active |

| DEF QUALITY - DRIVER WARNING AND INDUCEMENT |  |  |  |   |
|---|--|--|--|---|
| Conditions / Triggers                       |  | Amber Warning Light & DID Message And Audible Warning  |  | Inducement  |
| 1   | <b>Good DEF quality</b>  | None   |  | None  |
| 2   | <b>Poor DEF quality detected</b>   | <br>solid   | POOR DEF QUALITY DETECTED<br>SERVICE DEF SYSTEM AT NEXT STOP<br>🔊 🔄 🔄<br>3 cycles of 2 beeps                       | Warning message<br>Engine will derate 25% in < 60 mins  |
| 3   | <b>Poor DEF quality detected</b> and one (1) hour of operation with active diagnostic troubleshooting code   | <br>solid   | POOR DEF QUALITY DETECTED<br>ENGINE IN DERATE<br>5 MPH (8KM/H) LIMIT IN < XXX MINS<br>🔊 🔄 🔄<br>3 cycles of 2 beeps | Engine derated 25%<br>Engine will derate 40% in <240 mins   |
| 4   | <b>Poor DEF quality detected</b> and four (4) hours of operation with active diagnostic troubleshooting code   | <br>solid | SERVICE DEF<br>5 MPH (8KM/H) LIMIT NEXT 20MIN VEHICLE STOP<br>🔊 🔄 🔄<br>3 cycles of 2 beeps                         | Engine derated 40%<br>5 mph (8 km/h) limit after next 20 min vehicle stop   |
| 5   | <b>Poor DEF quality detected</b><br>Diesel fuel refueling done with a fuel level sensor increase of 15% or more<br>or<br>Vehicle stationary (speed=0) for 20 minutes with engine off or at idle<br>or<br>Key cycle trigger | <br>solid | SERVICE DEF<br>VEHICLE SPEED LIMITED TO 5 MPH (8 KM/H)<br>🔊 🔄 🔄 🔄 🔄 🔄<br>continuous cycle of 2 beeps               | Service DEF<br>Vehicle road speed limited (RSL) to 5 mph (8 km/h)<br><br>Note: The vehicle has to be stationary before 5 mph (8 km/h) road speed limit becomes active |

## 5-10 Other Features

| SCR SYSTEM TAMPERING - DRIVER WARNING AND INDUCEMENT |   |  |   |  |
|--|---|--|---|--|
| Conditions / Triggers                                |   | Amber Warning Light, DID Message And Audible Warning   |   | Inducement   |
| 1  | <b>Normal</b><br>No diagnostic troubleshooting code active  | None   |   | None   |
| 2  | <b>SCR system tampering</b><br>diagnostic troubleshooting code confirmed  | <br>solid   | SCR SYSTEM FAULT<br>ENGINE WILL<br>DERATE IN < XXX<br>MINS<br> constant tone                         | Warning message                                    |
| 3  | Reached one (1) hour of operation with active<br><b>SCR system tampering</b><br>diagnostic troubleshooting code confirmed   | <br>solid   | SCR SYSTEM FAULT<br>ENGINE IN DERATE<br>5 MPH (8KM/H) LIMIT<br>IN < XXX MINS<br> constant tone       | Engine torque reduction of 25%                     |
| 4  | Reached four (4) hours of operation with active<br><b>SCR system tampering</b><br>diagnostic troubleshooting code confirmed | <br>solid | SCR SYSTEM FAULT<br>REPAIR NEEDED<br>5 MPH (8KM/H) LIMIT<br>NEXT VEHICLE<br>STOP<br> constant tone | Engine torque reduction of 40%                     |
| 5  | Diesel fuel refueling done with a fuel level sensor increase of 15% or more   | <br>solid | SCR SYSTEM FAULT<br>VEHICLE SPEED<br>LIMITED TO 5 MPH (8<br>KM/H)<br> constant tone                | Vehicle road speed limited (RSL) to 5 mph (8 km/h) |

## DRIVER INFORMATION DISPLAY (DID) MENUS

There are Driving and Non-Driving menus. Several sub-menus are password-protected while the vehicle is parked. The Non-Driving menu is accessible only when the vehicle is parked.

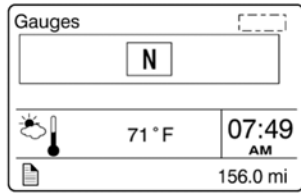
| DRIVING MODE MENUS   | NON-DRIVING / STATIONARY MODE MENUS   |
|--|---|
| <p><u>GAUGES</u></p> <ol style="list-style-type: none"> <li>1. Current Gear Position (I-Shift)</li> <li>2. Outside Temperature</li> <li>3. Engine Oil Temperature</li> <li>4. Transmission Fluid Temperature</li> <li>5. Prevost Liaison Compass</li> <li>6. Accessories Air Pressure</li> <li>7. Battery Voltage</li> <li>8. A/C Compressor Pressure</li> <li>9. Allison Transmission Oil Life</li> <li>10. Battery State Of Charge</li> <li>11. Electric Cooling Fan Status</li> </ol> | <p><u>DISPLAY SETTINGS</u></p> <ol style="list-style-type: none"> <li>1. Language</li> <li>2. Units</li> <li>3. Time/Date</li> <li>4. Favorite Display Setting</li> <li>5. Display Light</li> <li>6. Change Password</li> </ol>                           |
| <p><u>FUEL DATA</u></p> <ol style="list-style-type: none"> <li>1. Fuel Flow</li> <li>2. Fuel Flow / ECO %</li> <li>3. Trip Fuel Used</li> <li>4. Distance to Empty</li> </ol>  | <p><u>DIAGNOSTICS MENU</u></p> <ol style="list-style-type: none"> <li>1. View Active Faults</li> <li>2. View Inactive Faults</li> <li>3. Cluster Self-Test</li> <li>4. Part Number</li> <li>5. Reset Inactive Faults</li> <li>6. Vehicle Tests</li> </ol> |

## 5-12 Other Features

|   |  |
|---|--|
| <p><u>TIME/DISTANCE</u></p> <ol style="list-style-type: none"> <li>1. Time and Date</li> <li>2. Alarm Clock</li> <li>3. Trip Odometer 1 and 2</li> <li>4. Average Trip Speed</li> <li>5. Estimated Time of Arrival (ETA)</li> </ol> | <p><u>PRE-TRIP ASSISTANCE (OPTION)</u></p> <ol style="list-style-type: none"> <li>1. Exterior Light Inspection</li> <li>2. Air Leakage Monitor</li> </ol>  |
| <p><u>VEHICLE MESSAGES</u></p>  | <p><u>DATA LOG</u></p> <ol style="list-style-type: none"> <li>1. Vehicle ID</li> <li>2. Total Data</li> <li>3. Trip Data</li> <li>4. Reset Trip Data</li> </ol>  |
| <p><u>RESET TRIP DATA</u></p>   | <p><u>AFTERTREATMENT</u></p> <ol style="list-style-type: none"> <li>1. Request Parked REGEN</li> <li>2. ATS Status</li> <li>3. Cancel REGEN</li> </ol> <hr/> <p><u>PASSWORD</u></p> <ol style="list-style-type: none"> <li>1. Enter Password</li> </ol> <hr/> <p><u>PREVOST LIAISON (OPTION)</u></p> <ol style="list-style-type: none"> <li>1. Read Message</li> <li>2. Send Message</li> <li>3. Other Info</li> </ol> |

## GAUGES

There are several gauges in this menu. The gauges are used to view current status of important functions in the vehicle.



1. **Current Gear Position (I-Shift transmission only)**

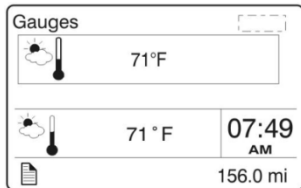
Indicates the current gear position selected on the I-Shift transmission.

D= drive

N= neutral

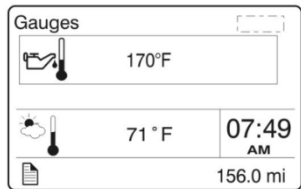
R= reverse

M= manual



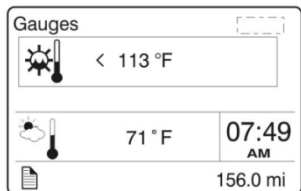
2. **Outside Temperature**

Selecting this gauge will display the engine oil temperature.

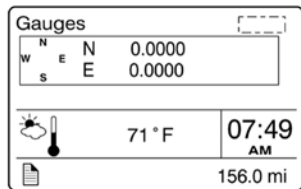


3. **Engine Oil Temperature**

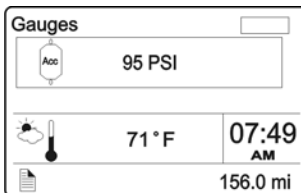
Selecting this gauge will display the engine oil temperature.



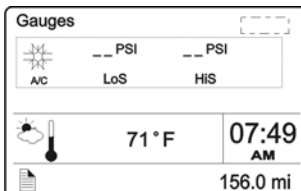
4. **Transmission Fluid Temperature**



5. **Prevost Liaison Compass**



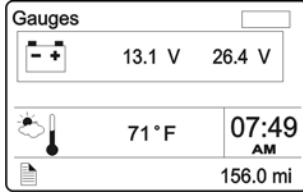
6. **Accessories Air Pressure**



7. **A/C Compressor Pressure**

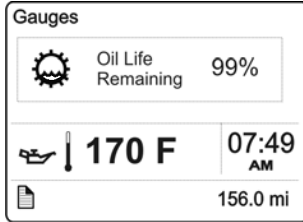
Displays the A/C compressor suction pressure value (LoS=low side) and discharge pressure value (HiS=high side).

## 5-14 Other Features



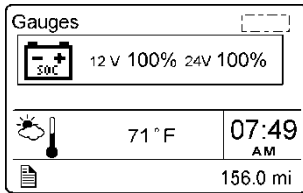
### 8. Battery Voltage

Displays current 12-volts and 24-volts systems voltage.



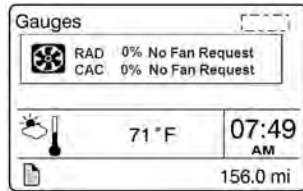
### 9. Allison Transmission Oil Life

Displays the percentage of the calculated remaining life of the transmission oil. New oil is displayed as 99%. Refer to Appendix C for more details.



### 10. Battery State Of Charge

Displays the state of charge of the 12-volt and 24-volt systems, expressed in percentage.

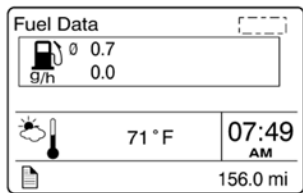


### 11. Electric Cooling Fan Status

Displays the speed and the state of both Charge Air Cooler and radiator cooling fans, expressed in percentage from 0 to 100%.

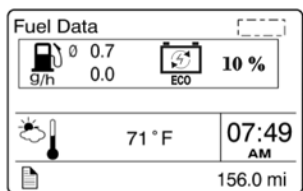
## FUEL DATA

The Fuel Data menu provides information on the fuel consumption of the vehicle in various situations. For example, how much fuel has been used, how much fuel is remaining before refueling the vehicle.



### 1. Fuel Flow (gph)

The lower numerical value (0.0) indicates the instantaneous fuel consumption. In this menu, you can reset the upper numerical value which is the average fuel consumption (0.7). To reset, hold ENTER button for 1 second.

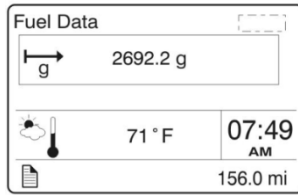


### 2. Fuel Flow/ ECO%

The lower numerical value (0.0) indicates the instantaneous fuel consumption. In this menu, you can reset the upper numerical value which is the average fuel consumption (0.7). To reset, hold ENTER button for 1 second.

This menu also displays the percentage of trip made on regenerated electricity (10%).



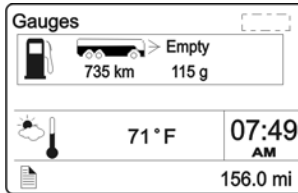


### 3. Trip Fuel Used

Indicates the total fuel consumption (gallons/liters) since the last reset.

Note: You should use Reset function before each new trip.

You can reset the fuel consumption value in this menu. To reset, hold ENTER button for 1 second.

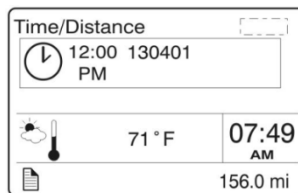


### 4. Distance To Empty

The left numerical value indicates the distance that can be traveled with the quantity of fuel that remains in the tank as indicated by the right numerical value.

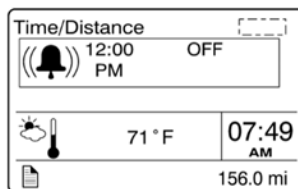
## TIME/DISTANCE

The time and date can be set in the Time/Distance menu. The alarm clock can also be set from this menu. Following the alarm clock menu is the Trip Odometer 1 and 2 selection, which allows the operator to see the distance traveled since the last reset. Average trip speed is also shown. By specifying the distance to your destination, the vehicle can calculate the estimated time of arrival (ETA).



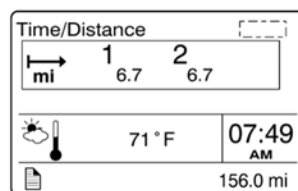
### 1. Time And Date

Adjust time and date with this menu. The instrument cluster has its own internal battery, so the date and date setting is keep in memory even if the vehicle's battery is disconnected.



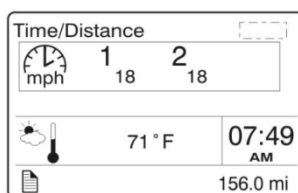
### 2. Alarm Clock

Use this function to program and activate an alarm on the instrument cluster clock. When the alarm clock goes off, a warning signal is sounded. The alarm shuts off after 60 seconds or if the ESCAPE button is depressed.



### 3. Trip Odometer 1 And 2

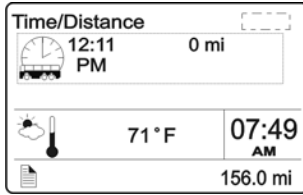
Allows the operator to see the distance traveled since the last reset. You can reset the trip odometer 1 or 2 in this menu. To reset, depress ENTER button, use UP/DOWN button to select between odometer 1 or 2 and then hold ENTER button for 1 second.



### 4. Average Trip Speed

This function displays the average speed for the current travel. The average trip speed is calculated as the distance traveled divided by the time the engine has been running (since the last reset). Two average trip speeds can be measured, corresponding to leg 1 and leg 2. Use Reset function before each new travel to start new measurements.

## 5-16 Other Features



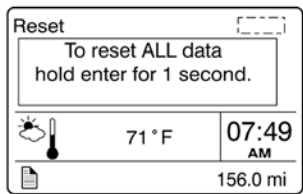
### 5. Estimated Time Of Arrival (ETA)

This function will display the estimated time of arrival if the distance to be traveled is entered first, in this menu. To set distance to be traveled, press ENTER and enter the distance left to drive in mile or km using ENTER and UP/DOWN buttons.

## VEHICLE MESSAGES

Use this function to consult the vehicle active messages that were previously displayed as pop-up messages and then acknowledged. When consulting a message, the corresponding STOP, CHECK or INFORMATION warning light will illuminate. Scroll through the messages using the up/down button. Press ESC button to return to main menu.

## RESET TRIP DATA

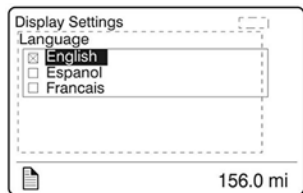


When the Reset Trip Data menu is open, pressing and holding down the Enter ↵ button for 1 second resets the functions listed below. This function will permit to the system to calculate new value from the point of resetting.

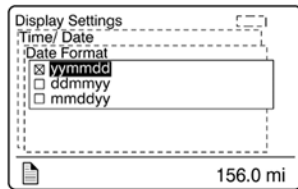
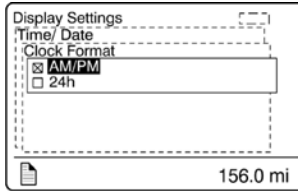
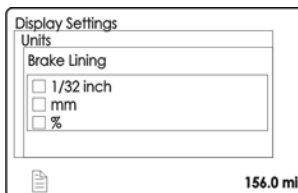
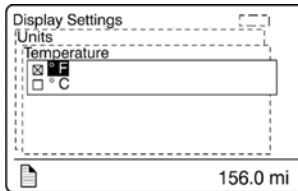
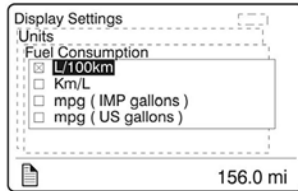
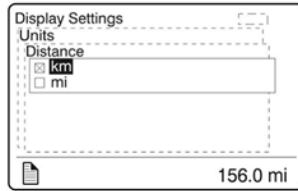
- Fuel flow
- Trip Fuel Used
- Average Trip Speed

## DISPLAY SETTINGS

The Display Settings menu is used to change languages and units. The password, time and date can also be changed. The backlight and contrast of the display screen can be adjusted.



### 1. Language



## 2. Units

Use this function to select desired unit formats for:

- Distance (miles or km);
- Fuel consumption (km/l, l/100km, mpg US or IMP);
- Temperature (°C or °F).
- Brake lining remaining (Brake calipers equipped with pad wear indicators): 1/32 inch, mm, %.

## 3. Time/Date

Select the time and date format using this function.

- am, pm, 24h
- yymmdd, ddmmyy, mmdyyy

## 5-18 Other Features



### 4. Favorite Display Setting

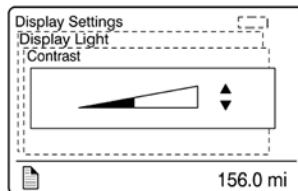
Use this menu to select your favorite display gauges 1, 2 and 3 and replace the default gauges.

On vehicles provided with the I-Shift transmission, Favorite Display Gauge 3 cannot be edited as it is kept for display of the transmission status.

Example: You wish to display the engine oil temperature at the Gauge 1 position.

1. Use UP/DOWN button until Gauge 1 position is selected.
2. Press ENTER button to confirm.

Use UP/DOWN button to scroll through the available gauges. When the engine oil temperature gauge is displayed, press ENTER button to confirm (repeat steps 1-3 to change Gauge 2 and Gauge 3 if needed).

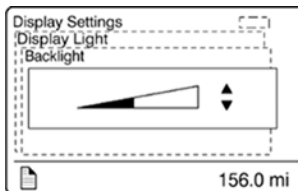


### 5. Display Light

The Display Light menu has three sub-menus:

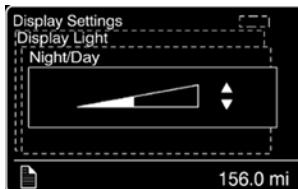
- Contrast

Adjust the contrast with the UP/DOWN button and press ENTER button to confirm.



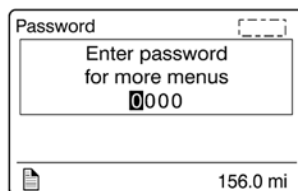
- Backlight

In this menu, the display lighting can be adjusted relative to other instrument lighting with the UP/DOWN button.



- Night/Day

Use the Night/Day menu to choose a dark background with light text and images or a light background with dark text and images. Press ENTER button to toggle between Night and Day.



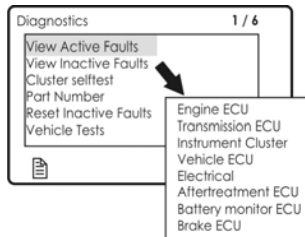
### 6. Change Password

Use this menu to change the current password. This menu is only accessible if the correct password is entered. The default password is 0000.

1. Mark which password is to be changed with the display UP/DOWN button.
2. Confirm with ENTER button.
3. Set the first digit with the UP/DOWN button.
4. Step to the next digit using ENTER button.
5. Step backwards with ESC button.

## DIAGNOSTICS MENU

The Diagnostics menu enables fault tracing on the control units in the vehicle to check for faults. Instrument tests are available to check the telltales, gauges, display and speaker. The part number of a control unit can be identified in the part number menu.



### 1. View Active Faults

A list of the control units on the vehicle is displayed. Use this function to check for active faults on specific control units.

### 2. View Inactive Faults

Use this function to check for inactive faults on specific control units.

### 3. Cluster Self-test

Use this menu to check proper functioning of the following components:

- Telltale lights
- Analog gauges
- Display
- Speakers

The following table describes the available tests. To cancel a test, press the ESC button).

|                      |  |
|----------------------|--|
| Telltale lights test | Telltales illuminate for approximately five seconds.<br>Press the Esc button to cancel the test.   |
| Analog gauges        | The indicators move forwards and backwards between the end positions. They do not show any particular value. This is just a check to confirm that the indicators move, and to make sure the operators are working.<br>Press the Esc button to cancel the test. |
| Display test         | The entire display lights up until the Esc button is pressed.  |
| Speaker Test         | A sound is emitted through the speakers. Press the Esc button to cancel the test.  |

### 4. Part Number

A list of the control units on the vehicle with their part numbers is displayed in the Part Number menu.

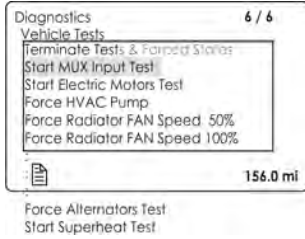
### 5. Reset Inactive Faults

Use this menu to delete an inactive fault for a particular control unit. Note: it is not possible to delete inactive faults of the Engine ECU.

### 6. Vehicle Tests

Use this menu to perform tests on several components and systems:

- Dashboard switches (Mux Input Test)
- Electric motors, valve and pump contactors (Electric Motors Test)



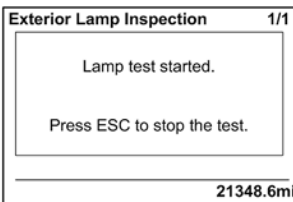
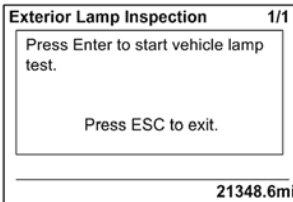
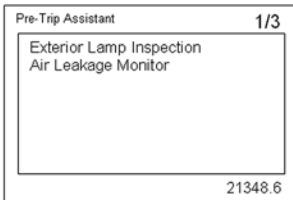
In case of overheating of the engine due to a malfunction of the radiator fan you can force activation of the fan using ACTIVATE RADIATOR FAN SPEED 50% or 100%.

The DID status line will show TEST to confirm that one of the test modes is active. To cancel an active test, turn the ignition switch to the OFF position or press ESCAPE button, select Terminate Tests & Forced States submenu and then press ENTER button twice. "TEST" will disappear from the DID status line.

For further information concerning these functions, refer to Maintenance Manual section 06: Electrical, under "Available Test Modes" and "Limp-home Modes".

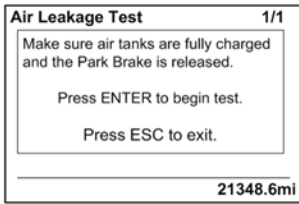
### PRE-TRIP ASSISTANCE (OPTION)

The Pre-Trip Assistance helps the driver in completing the pre-trip inspection of the vehicle. This feature is not a substitute for a complete pre-trip inspection. If any system of the vehicle does not pass inspection, the error must be corrected before operating the vehicle. The available pre-trip tests include the Exterior Light Inspection check, and the Air Leakage check.



#### 1. Exterior Light Inspection

The Exterior Light Inspection function turns on all the exterior lights simultaneously. This allows the operator to start the test, exit the vehicle and do a visual check that all exterior lights function properly. Press ESCAPE button to end the test and turn off all the exterior lights.

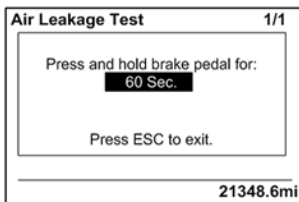
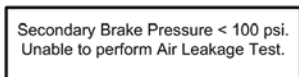
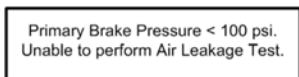


## 2. Air Leakage Monitor

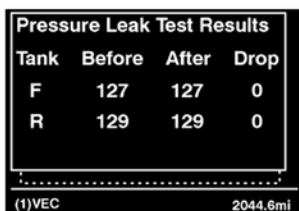
The Air Leakage check allows the driver to accurately measure the amount of air pressure drop in the front and rear brake air systems. After selecting this test from the DID, you are prompted to apply the service brake for 60 seconds. After applying and holding the service brake for 60 seconds, the DID will display the amount of pressure drop in the brake system.

Before starting the test through the DID, complete the following:

- A. Chock the wheels to prevent the vehicle from rolling.
- B. Start the engine and check that the brake systems air pressure is greater than 100 psi.
- C. Turn engine off.
- D. Release the parking and service brakes and allow the system to settle (air gauge needle stops moving).
- E. Press the ENTER button to start the test.
- F. If the air tanks pressure is too low to perform the test (pressure must be greater than 100 psi), the following messages will appear.
- G. You must press and hold brake pedal for 60 seconds, as instructed.



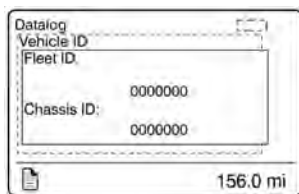
- H. Once the brake pressure test is completed the pressure leak test results are displayed.



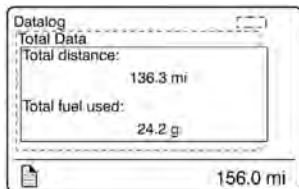
## 5-22 Other Features

---

### DATA LOG



#### 1. Vehicle ID



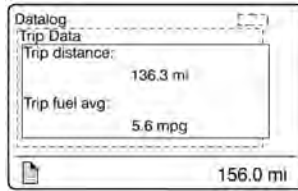
#### 2. Total Data

Total Data menu indicates the accumulated engine values that have been logged during the lifetime of the engine ECU.

Available information:

- Total distance traveled
- Total fuel used
- Total engine hours
- Total idle time
- Total PTO hours
- Total engine revolutions



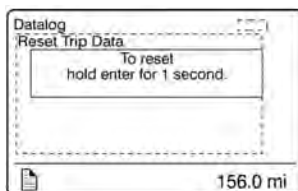


### 3. Trip Data

This menu displays the trip information listed below. This function must be reset before each measurement (before each new trip or leg) using the Reset Trip Data menu.

Available information for the trip or leg is:

- Trip distance (miles or km)
- Trip fuel average (mpg, liter/100km; km/liter)
- Trip fuel used (gallons or liters)
- Trip duration on cruise control (hours)
- Trip duration with engine rpm greater than economy rpm (hours)
- Trip duration while engine rpm is greater than the desired maximum rpm RPM Limit set in Fleet Limits sub-menu (hours)
- Trip fuel used with engine rpm greater than the economy rpm (gallons/liters)
- Trip average speed (mph, km/h)
- Trip duration with speed greater than the maximum desired speed as set in Fleet Limits sub-menu (hours)
- Trip engine hours
- Trip duration on engine idle (hours)
- Trip fuel used while in engine idle (gallons, liters)



### 4. Reset Trip Data

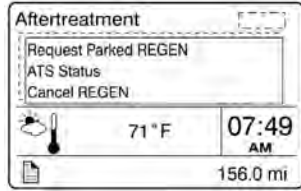
This menu can only be accessed if the correct password has been entered.

Use this function to reset measurements of the Trip Data menu before each new trip or leg.

## AFTERTREATMENT

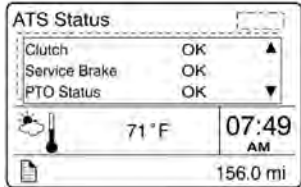
This menu permits the driver to initiate a stationary regeneration, to check the status of the aftertreatment system and to interrupt regeneration.

## 5-24 Other Features



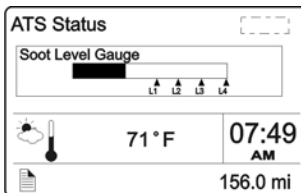
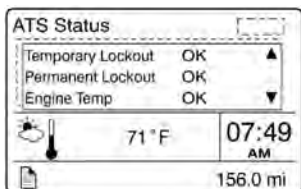
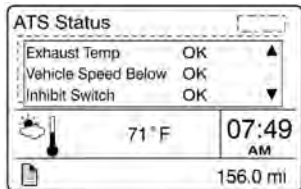
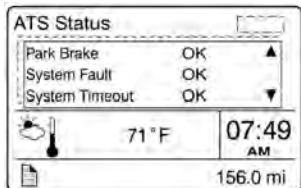
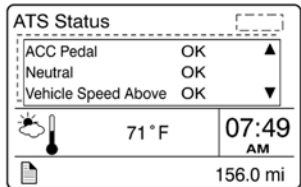
### 1. Request Parked REGEN

Use this function to initiate a stationary (parked) regeneration.



### 2. ATS Status

The Aftertreatment status sub-menus provide information about the conditions required for performing regeneration. The status can be OK (regeneration allowed), CHECK (regeneration not allowed) or N/A (not applicable). When ATS Status is selected, the following displays (images at left) will show.



### Soot Level Gauge

From the ATS Status sub-menu, you can view the soot level for the Aftertreatment system. When the soot level is high, regeneration is necessary. L1, L2, L3 and L4 under the scale correspond to Level 1 up to Level 4 (see ["DEF\\_CLOGGING\\_SEQUENCE\\_-\\_INSTRUMENT\\_CLUSTER\\_TELLTALE\\_LIGHT" on page 4](#)) in this section.



### 3. Cancel REGEN

From the Aftertreatment main menu, you can cancel a REGEN cycle.

## PASSWORD

Certain functions are password-protected. These passwords give the user access to all password-protected functions. The default password is 0000.

### 1. Password

The following menus are password-protected and marked with a key symbol in the menus:

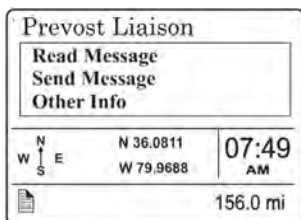
- Change Password
- Fleet ID
- Reset Trip Data
- Fault Diagnostics
- Inactive Faults

## PREVOST LIAISON (OPTION)

The Prevost Liaison system provides cellular communication between the driver and the fleet operator. The driver can send and receive short text messages, which are visible through the Driver Information Display.

## 5-26 Other Features

---



The following menus are available:

### 1. Read Message

- Quick Response (only available if there is a message available)

### 2. Send Message

- Driver & Equipment
- Dispatch Messages
- Free Text

### 3. Other Info

- Comm Liaison Info
- Mailbox Info
- GPS Info
- INI Info
- Configuration Info

## INTELLIGENT SLEEP MODE (ISM)

The ISM is a battery-saving mode designed to protect the battery State Of Charge (SOC). The ISM will automatically change the vehicle electrical system from normal functional state to sleep mode if the battery SOC falls below 65%.

Once the vehicle has entered into sleep mode, the only actions needed to put the vehicle back into its normal functional state are:

- To cycle the ignition key from OFF to ON;  
or
- To open the entrance door;  
or
- To turn on the hazard lights.

The ISM forces the vehicle to go into sleep mode if all the following conditions are met:

1. The engine is not running;
2. The parking brake is applied;
3. The ignition switch is at the ON, ACC positions or at the OFF position but the 15 minutes “wake up” period after engine shutdown is not expired;
4. The battery state of charge of 12V or 24V system falls below 65%.

The red ALTERNATOR telltale will turn on 30 seconds before activation of the sleep mode.



## TRANSMISSION RETARDER (OPTION)

The transmission retarder helps to reduce the speed of a vehicle. It improves vehicle control, increases driving safety and permits more economical operation. The retarder provides slowing power when it is most needed, such as when descending mountain roads, in stop-and-go traffic and on crowded freeways.

The transmission retarder is a vehicle-slowng device, not a vehicle-stopping device. It is not a

substitute for the service braking system. The service brake must be used to bring the vehicle to a complete stop.

### NOTE

*Extended use will raise the temperature of the transmission fluid.*

The retarder helps reduce speed on grades without using the vehicle's conventional service braking system. This virtually eliminates brake overheating and reduces the risk of a runaway vehicle. A retarder greatly increases the service life of brake pads and discs, resulting in reduced brake maintenance costs.

The retarder is provided with control buttons on the steering wheel and a lever on the steering column (refer to "[TRANSMISSION RETARDER](#)" on page 1 in Section 4 Controls and instruments).



### WARNING

Do not use the retarder during inclement weather or slippery road conditions.

### NOTE

*The stoplights automatically illuminate when the vehicle is slowing down after application of the transmission retarder.*

### NOTE

*For vehicles equipped with the Antilock Braking System (ABS), as the wheels start to lock up on slippery roads, the output retarder automatically deactivates until the wheels roll freely.*

## ENGINE BRAKE



### WARNING

A vehicle speed retarding device (such as engine brake) is not intended to replace the service brake systems on your vehicle nor intended to bring your vehicle to a stop. A vehicle speed retarding device is only intended to reduce the speed of your vehicle under certain conditions.

Several types of engine brake can be installed or are standard on certain engines. All are used to reduce wear on the vehicle brake linings.

## 5-28 Other Features



### WARNING

When descending significant grades, use the service brake as little as possible. If the engine does not slow the vehicle to a safe speed, apply service brake and shift to a lower range. Let the engine (and engine brake) slow the vehicle. Keep brakes cool and ready for emergency stopping.

### VOLVO ENGINE BRAKE (VEB)

On vehicles equipped with the Volvo Engine Brake (VEB), the engine brake mode is by default, set to the AUTO mode (A) at vehicle start-up.

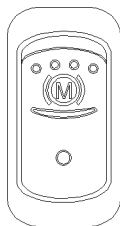
When running in AUTO (A) mode, the engine brake is gradually applied to 100% of the braking power when the driver pushes the brake pedal. Since AUTO (A) mode will not reduce vehicle momentum unless the brakes are applied, it will have no impact on fuel consumption.

The driver can also choose two other modes using the steering wheel switches; Engine brake LOW (1) and engine brake HIGH (2).

When set to the engine brake LOW (1) mode, 50% of the engine brake power will be applied when the driver releases the accelerator pedal. Using engine brake HIGH (2) will apply 100% of the braking power.

It must be noted that since engine brake LOW (1) and engine brake HIGH (2) will reduce vehicle speed upon release of the throttle pedal, they may negatively impact fuel consumption if used for extended periods of time.

On vehicles equipped with an engine brake switch, it is possible to deactivate the engine brake (OFF mode). To do so, the driver must press the engine brake switch located on the left side of the dashboard.



Engine Brake Switch

### NOTE

When using engine brake LOW (1) or HIGH (2) mode, pressing the steering switch OFF button will switch back to the default AUTO (A) mode.




| DRIVER PEDALS  | ENGINE BRAKE MODE | ENGINE BRAKE FORCE |
|--|-------------------|--------------------|
| ANY POSITION   | (OFF)             | 0%                 |
| ACCELERATOR PEDAL RELEASED<br>   | (A)               | 0%                 |
| BRAKE PEDAL PUSHED<br>          | (A)               | 100%               |
| ACCELERATOR PEDAL RELEASED<br> | (1)               | 50%                |
|  | (2)               | 100%               |

FIGURE 1: ENGINE BRAKE FORCE APPLIED ACCORDING TO SELECTED MODE AND DRIVER PEDAL POSITION

### NOTE

Engine brake is safe to use in any road conditions including adverse conditions.

### CRUISE CONTROL AND ENGINE BRAKE

When cruise control is enabled by the driver, the engine brake mode is forced to AUTO (A) mode

and the engine brake will progressively engage up to 100% if the selected cruise speed is exceeded by approximately 2 km/h (1.25 mph). Manually switching to engine brake LOW ① or HIGH ② using the steering wheel switches will deactivate the cruise control.

| CRUISE CONTROL & SPEED   | ENGINE BRAKE MODE | ENGINE BRAKE FORCE |
|--|-------------------|--------------------|
| <div style="border: 1px solid black; padding: 5px; text-align: center; font-weight: bold; font-size: 2em;">CRUISE</div><br>+<br>CRUISE SPEED SET<br>+ 2 Km/h | (OFF)             | 0%                 |
|  | (A)               | UP TO 100%         |
|  | ①                 | N/A                |
|  | ②                 | N/A                |

FIGURE 2: ENGINE BRAKE FORCE APPLIED WITH CRUISE CONTROL

**NOTE**

On vehicles equipped with the Allison transmission, if cruise control is enabled, the current engine brake mode is saved in the vehicle computer (MCM) memory and the engine brake mode is set to Auto mode (A). When the cruise control is disabled, the engine brake mode changes back to the mode saved in the MCM memory.

## ABS, TRACTION CONTROL SYSTEM (TCS) & ELECTRONIC STABILITY CONTROL (ESC)

### ANTILOCK BRAKING SYSTEM (ABS)

The purpose of the Antilock Braking System (ABS) is to maintain vehicle stability and control during braking and to minimize the stopping distance in any road condition.

On slippery roads and more generally in emergency, over-braking frequently induces wheel locking. Wheel locking greatly increases breaking distance on any road surface. Locked

wheels also impede directional control and cause severe tire abrasion. An antilock braking system provides maximum braking performance while maintaining adequate control on slippery roads.

The basis of ABS is constant monitoring of wheel parameters during braking. Sensors on each wheel of the front, drive and tag axles constantly measure wheel speed during braking. This information is transmitted to a six-channel electronic processor which senses when any wheel is about to lock. Modulating valves quickly adjust brake pressure (up to 5 times every second) to prevent wheel lock. Each wheel is therefore controlled according to the available grip.

In this way, the vehicle is brought to a stop in the shortest possible time while remaining stable and under the driver's control.

**WARNING**

Vehicles following ABS-equipped vehicles may not be able to brake as fast on slippery roads.

### TRACTION CONTROL SYSTEM (TCS)

TCS controls wheel spin during vehicle acceleration to improve traction.

- The TCS system will intervene automatically and apply braking pressure to a spinning wheel transferring engine power to the other drive wheel that has better traction. This feature is active only at speeds below 25 mph (40 km/h).
- If all of the drive wheels begin to spin, the TCS system will reduce engine throttle to improve traction at all of the drive wheels.

If drive wheels begin to lose traction during acceleration, TCS will engage automatically to assist the driver in accelerating the vehicle. The TCS icon in the DID will flash rapidly to let you know whenever TCS is actively functioning.

### ELECTRONIC STABILITY CONTROL (OPTION)

The Electronic Stability Control (ESC) is a feature for ABS-equipped vehicles that reduces the risk of rollovers and loss of control. The ESC system

## 5-30 Other Features

features include the RSP Roll Stability Program and Yaw Control.

The RSP system counteracts the tendency of a vehicle to tip over while changing direction (typically, while turning).

To reduce the risk of rollover, the RSP system detects potential rollover conditions and slows the vehicle both by reducing engine throttle (and hence, engine torque) and by applying service brakes as needed at the appropriate wheels.



### WARNING

During an RSP system intervention, the vehicle automatically decelerates. The RSP system can slow the vehicle with or without you applying the brake pedal, and even when you are applying the throttle.

During an RSP system intervention, you can always use your service brake pedal to increase the braking pressure that will be applied. However, if you were to apply less braking pressure than needed or even if you release the brake pedal entirely during an intervention, the RSP system will continue to apply the necessary amount of braking pressure automatically to the appropriate wheels to mitigate a potential rollover.

Yaw Control is a feature that reduces the risk of loss of control. If a vehicle's tires start to slide during a turn, Yaw Control counteracts the tendency of that vehicle to spin (or yaw), thereby reducing the risk of loss of control. Many factors, including road conditions, load distribution and driving behavior, can contribute to the development of a spin.



### WARNING

In the case where a vehicle equipped with the ESC system pulls a trailer, the latter must be equipped with ABS.



### WARNING

Even with ESC-equipped vehicles, the driver remains responsible for ensuring vehicle stability during operation.

### NOTE

*For further details, consult "Bendix ABS Operator's Manual"*

## DRIVER CONTROLLED DIFFERENTIAL LOCK (DCDL)

By actuating the dashboard switch, the driver can lock or unlock differential action.

The purpose of the DCDL is to provide maximum vehicle traction and control on unfavorable road surface conditions. When the DCDL is actuated, a clutch collar completely locks the differential case, gearing, and axle shafts together. This feature maximizes traction to both wheels. The lock position will also protect against spinout damage to the differential. The DCDL should not be actuated when favorable road conditions exist. DCDL is an optional feature.

### OPERATION TIPS

1. The DCDL can be locked or unlocked if the vehicle is standing still or moving at a constant low speed when the wheels are not spinning, slipping, or losing traction.
2. When the DCDL is locked, operate the vehicle at low speeds. DCDL will not engage and will disengage in speed higher than 5 MPH (8 km/h).
3. When the DCDL is locked, the vehicle's turning radius will increase. This condition is called "understeer." The driver must use caution, good judgment and drive at low speeds when operating the vehicle with the DCDL locked.
4. Always unlock the DCDL as soon as the need for maximum traction has passed and the vehicle is traveling on a good road.
5. Do not lock the DCDL when the wheels are slipping or losing traction, or damage to the axle can result.
6. Do not lock the DCDL when the vehicle is traveling down steep grades, or potential loss of vehicle stability could occur.



## LOCKING THE DCDL

When encountering poor road conditions where maximum traction is needed, follow the recommended procedures:

1. Without the wheels spinning, slipping or losing traction, flip the DCDL control switch to the "LOCK" position while maintaining a constant vehicle speed.
2. Let up momentarily on the accelerator to relieve torque on the gearing, allowing the DCDL to lock.
3. When the DCDL is fully locked, the vehicle will have an "understeer" condition when making turns. Proceed cautiously over poor road conditions.

## UNLOCKING THE DCDL

When the vehicle can safely operate and driving conditions have improved, disengage the DCDL following the recommended procedures:

1. Flip the control switch to the "UNLOCK" position, when the vehicle is stopped or when traveling at low speed while the wheels are not spinning, slipping or losing traction.
2. Let up momentarily on the accelerator to relieve torque on the gearing, allowing the DCDL to unlock.
3. Resume driving at normal speed using good driving judgment.

## KNEELING SYSTEM

This system lowers the front end, enabling passengers to get on and off the coach without any difficulty.

To operate:

1. Stop the coach and apply the parking brakes
2. Set the transmission to neutral (N) ;
3. Momentarily press the rocker switch downwards to lower the front end of the coach 4 inches (100 mm). Refer to "[CONTROL SWITCHES](#)" on page 7 in Section 4 Controls and Instruments.

A pictogram will appear in the DID status line indicating that the coach is being lowered.

To raise the front of the coach to normal height;

1. Momentarily press the rocker switch upwards. The front end will rapidly rise up.

### NOTE

*The parking brakes must be applied to allow the use of the kneeling.*

### NOTE

*Kneeling is disabled when the entrance door is open or when the wheel chair lift (WCL) is in function.*



### CAUTION

Avoid parking the coach too close to the sidewalk or to other obstacles which could damage the coach during kneeling.

## HIGH-BUOY

The coach may be equipped with the optional front High-Buoy or full High-Buoy. The front High-Buoy system has the same functions as the front kneeling. In addition it enables passengers to get on or off the coach easily by raising the front end about 4 inches (100 mm), which may prove useful when the dock is higher than usual. The front High-Buoy is combined with front kneeling to increase the flexibility of the system.

The full High-Buoy system raises the whole coach about 4 inches (100 mm). It can be used to enable passengers to get on or off the coach easily, and to safely travel roads with high obstacles.

See [High Buoy / Low Buoy](#) in Section 4 Controls and Instruments.

### NOTE

*The High-Buoy system does not operate when the coach is traveling over 5 mph (8 km/h). Consequently, the driver cannot inadvertently operate the High-Buoy system at higher speeds.*

## 5-32 Other Features

### LOW-BUOY

This system lowers the coach about 4 inches (100 mm). It enables the coach to drive under overhead obstacles.

Low-buoy operation is controlled by a rocker switch on the L.H. dashboard panel. Refer to [High Buoy / Low Buoy](#) in Section 4 Controls and Instruments. A pictogram appears in the Driver Information Display if the coach speed exceeds 12 mph (20 km/h) when lowered.



#### CAUTION

Avoid parking too close to the curb or other obstacles that could damage the coach during low-buoy operation.



#### WARNING

Use only below 5 mph (8 km/h).



#### WARNING

The Low-Buoy cannot be activated when the coach is traveling over 5 mph (8 km/h). Consequently, the driver cannot inadvertently operate the Low-Buoy system at higher speeds.

#### NOTE

*The Low-Buoy cannot be activated when the coach is traveling over 5 mph (8 km/h). Consequently, the driver cannot inadvertently operate the Low-Buoy system at higher speeds.*

### RETRACTABLE TAG AXLE

Tag axle is controlled by a valve located on the lateral control panel. The valve can be switched to either the wheels up or wheels down position. The axle will be automatically raised or lowered by air pressure according to the valve position. Refer to ["TAG AXLE CONTROL VALVE"](#) on [page 9](#) in Section 4, Controls and Instruments.

The tag axle service brakes operate only when the tag axle is in the wheels down position. Never lower the tag axle while the coach is moving. A pictogram appears in the Driver Information Display if the vehicle speed exceeds 12 mph (20 km/h) with tag axle raised. The tag axle can be

raised in tight maneuvering areas like in a parking lot or to make it easier to turn a short corner. The tag axle shortens the wheelbase and allows tighter turning. Raising the tag axle transfers extra weight and additional traction to the drive wheels providing improved control on slippery roads.



#### CAUTION

Do not use tag axle in raised position for an extended period. Raising tag axle increases load on the drive axle, suspension and tires.

Do not drive vehicle with tag axle raised when speed is exceeding 12 mph (20 km/h).

In order to prevent damage to the suspension, always raise the tag axle before lifting the coach.

### OPTIONAL AUTOMATIC TAG AXLE UNLOADING

To reduce the turning radius, the air springs pressure will be automatically reduced by 75% when the coach is moving at speed lower than 5 mph (8 km/h) and with more than 1½ turn from the steering

### PREHEATER

The optional auxiliary heating system is used for preheating and retaining the heat of water-cooled engines. It can be used before the start-up to ease starting and to provide rapid interior heat. It can also be used with the engine running to maintain coolant heat and interior temperature.


The heater operates independently of the engine. It is connected to the cooling system heating circuits and to the vehicle's fuel and electrical system.



#### WARNING

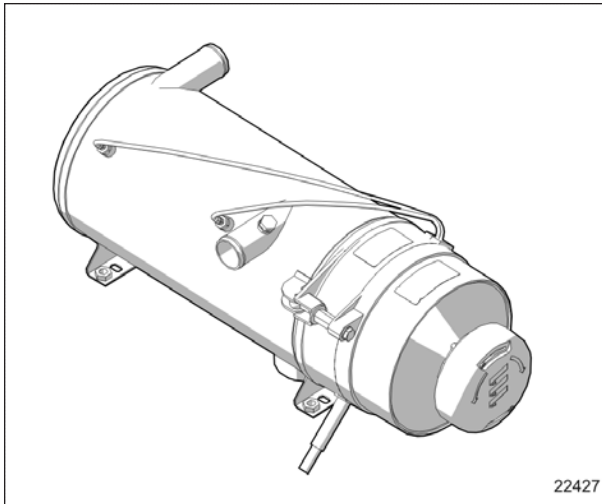
The preheater uses the same fuel as the engine. Do not operate in a closed building or while refueling. Operate only in a well-ventilated area.

## SWITCHING THE HEATER ON

The Heater "On"  symbol appears on the timer display when the heater is switched on. Air is forced in to flush out the combustion chamber of any residual gases and the water circulation pump begins operating. The fuel metering pump delivers fuel to the combustion chamber, where fuel and combustion air form a combustible mixture which is ignited by the ignition unit.

Once the flame sensor has signaled to the control unit that combustion has taken place, the ignition unit is switched off.

Hot combustion gases are diverted at the end of the flame pipe and are then forced through the indirect heating surfaces of the heat exchanger. The heat exchanger transfers the heat to the coolant water passing through the heat exchanger.



22427

**FIGURE 3: COOLANT PREHEATER**


The heater is thermostatically controlled and operates intermittently (i.e., the switched-on time of the burner varies depending on the heat requirement). The water temperature is controlled by the built-in water thermostat.

The water circulation pump remains in operation as long as the heater is operating, even during the regulated intervals and during the delayed cut-out of the heater. The pump can also be operated independently of the heater by means of an appropriate circuit. The heater can be switched on at any time (i.e., during the delayed cut-out period). Ignition takes place after the delayed cut-out time expires.

## SWITCHING THE HEATER OFF

The fuel supply is interrupted when the heater is switched OFF. This causes the flame to go out and a delayed cut-out of 2.5 minutes begins. The circulating combustion air flushes the remaining combustion gases out of the chamber and cools off the heated parts on the exhaust side of the heat exchanger. The water circulation pump continues to transfer the latent heat present in the heat exchanger, thus preventing hot spots. Once the delayed cut-out time expires, both the combustion air blower and the water circulation pump switch OFF automatically. A cut-out will automatically take place in case of heater failure. Refer to section *Technical Information* for additional information.

## COOLANT HEATER TIMER

The timer located on lateral control panel is used to program the starting and stopping time of the preheating system and to give Fault Codes. The Heater "On" symbol , located on the timer, appears when the system is in operation.

## 5-34 Other Features

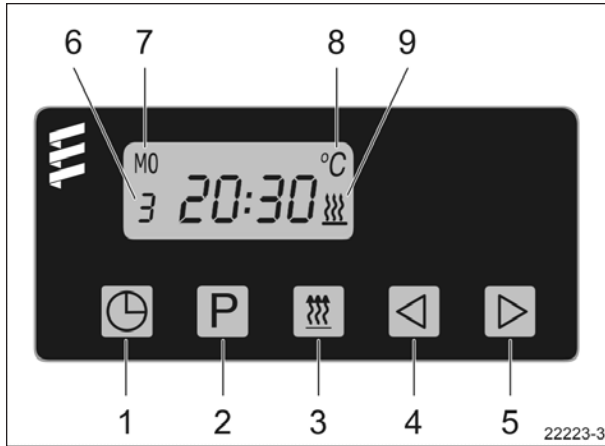


FIGURE 4: FIGURE 1: PREHEATER TIMER

1. Time set
2. Preheat time set
3. Heater "On"
4. Backward scan
5. Forward scan
6. Memory location
7. Time and day display
8. Air temperature display
9. Heater "On" symbol

Refer to the [7 day timer operating instructions](#) found on your Technical Publications USB flash drive, and on the Technical Publications Website for additional information.

### TIMER OPERATION

The most common timer operations are described. For additional details, refer to Eberspacher manual [Timer - Operating Instructions](#) found on Prevost Technical Publications site.

### Set Time And Day

Push button once. 12:00 will begin to flash (this will occur upon initial hook up to power).

Using or , set the present time of day (24-hour clock).

When the time stops flashing, the time has been stored.

The weekday will now begin to flash.

Use or to set the present weekday.

When the weekday stops flashing, the weekday has been stored.

When the vehicle ignition is turned "on" the time display will appear.

When the vehicle ignition is turned "off" the timer display will go off after 15 seconds.

### Changing Time And Day

Push and hold button until the time display begins to flash. Continue to set the time as listed in setting time and weekday.

### Using The Timer With The Vehicle Ignition "Off"

Push button.

will appear on the display as well as the operation countdown timer.

The running time is factory set to a maximum of 120 minutes. This

running time can be reset once or permanently as desired.

### Adjusting Preheat Time Once


Press button.

The will appear in the display and the preselected run time will appear in the display (maximum time of 120 minutes).

Use the or to adjust the desired run time.

## Using The Heater Manually With The Vehicle Accessory “On”


Push  button.


The  symbol will appear in the display next to the time of day.

The time of day will remain displayed during ignition on operation.

The heater will continually function as long as the vehicle ignition is “on”.

When the vehicle ignition is turned “off” the heater will continue to operate for an additional 15 minutes.

The run time can be altered by pressing the  or  buttons.

The heater can be turned off by pressing  button.

## To Turn Heater “Off” - All Modes

Press the  button once.

The heat signal to the heater will be turned “off”.




The heater will do a normal cooldown and turn itself “off”.

## PREHEATER TROUBLESHOOTING AND MAINTENANCE

Up to five fault codes are stored in the heater control box. They can be displayed on the timer.

### Query Fault Memory F1 – F5

Condition: The heater is switched off.


- Press  button → the heater is switched on.
- Press  button and keep it depressed, then press  button within 2 seconds.

The display is as follows:

AF = current fault

3 digit number = fault code

 flashes.

- Press  button once or several times, fault memory positions F1 – F5 are displayed.

For additional details, refer to the Maintenance Manual Section 22, under heading "Auxiliary Preheating System (Option)", also refer to supplier publications [Eberspacher Hydronic LII Troubleshooting and Repair manual](#) and [Eberspacher Hydronic L-II Installation Operating Maintenance manual](#) found on the Technical

Publications Website, and on the Technical Publications USB flash drive delivered with the vehicle.

### NOTE

*If there are no preheater faults, the preheater will go through a normal start cycle and regulate based on thermostat setting.*

### NOTE

*Switch on the preheating system 10 minutes about once a month, even during the warm season.*



### CAUTION

To avoid running down the batteries, do not turn on the preheating system for more than one hour before starting the engine. To run the heater for longer periods, connect the vehicle.



### WARNING

The preheating system uses the same fuel as the engine. Do not operate in a building or while refueling. Operate only in a well-ventilated area.

## 5-36 Other Features

### WHEELCHAIR LIFT SYSTEM

It is important to passenger safety that the lift operator be familiar with the operating instructions. Read and understand the RICON Mirage F9TF/F9TH Wheelchair lift Operator Manual before attempting to use the wheelchair lift. The instructions below are a quick reference only and not a replacement to the information provided by RICON.

**Watch the Prevest Wheelchair Lift Instruction video on Prevest's YouTube channel. To do so, type "Prevest Coach – YouTube" on your web browser and then select the proper link. Once on Prevest channel, select "Video" tab and then look for the video entitled "Prevest Wheelchair Instruction".**

### INTRODUCTION

Safe and easy access to the coach is provided by the Ricon Mirage F9TF and F9TH Public Use wheelchair lifts. The Mirage F9TF or F9TH is a dedicated entry model, which is intended for installation in a vehicle baggage compartment.

An electric-motor driven hydraulic pump provides a maximum platform lifting capacity of 660 pounds (300 kilograms) for **Mirage Model F9TF** and 800 pounds (363 kilograms) for **Mirage Model F9TH**.

A trained attendant or the vehicle operator operates the lift. For a boarding passenger, the operator uses control switches to withdraw the platform from the vehicle (deploy) and lower it to ground level. The passenger is placed on the platform and then lifted to floor height. After the passenger enters the vehicle, the operator lowers the platform and retracts it back into the vehicle (stow). For an existing passenger, the operator withdraws the platform from the vehicle (deploy) and raises it to floor height. The passenger is placed on the platform and then lowered to the ground. The passenger departs, and the operator returns the platform to the stowed position in the vehicle.

One individual can manually operate the lift when normal power is not present. A manual release mechanism is provided to ease the task of pulling the platform out of its enclosure. The hydraulic pump assembly includes a manually operated back-up pump to raise the platform, and a pressure release valve to lower it. The front platform rollstop, normally power operated, has a manual override knob for back-up use.

### OVERVIEW

#### Major Lift Components

|                          |  |
|--------------------------|--|
| Left, Right, Front, Rear | Reference points from outside vehicle looking inward at lift.  |
| Bridgeplate              | Plate bridges gap between platform and vehicle floor when platform is at floor level. Acts as a barrier during up and down platform motions to prevent wheelchair from rolling off rear of platform. |
| Carriage                 | Part of traveling frame that is mounted on rollers; moves on rails located inside enclosure. Supports lifting frame and platform.  |
| Controller               | Receives electrical input signals from pendant and lift sensors and sends control signals to lift electrical and hydraulic components.   |
| Control pendant          | Hand-held device used to control platform motions.   |
| Cycle counter            | Located on rear frame of carriage. Visible when platform is fully deployed. It records number of times platform has moved from floor to ground and back to floor.                                    |

## Other Features 5-37

|                         |  |
|-------------------------|--|
| Deployment system       | Located within carriage. Employs an electric gear-motor to propel platform out of enclosure, or pull it back into enclosure.   |
| Enclosure               | Travelling frame housing that is rigidly attached to vehicle chassis.  |
| Fluid reservoir         | Container holds hydraulic fluid that is used by hydraulic system.  |
| Folding handrail        | (left and right) Provides a handhold for standing passenger (standee).   |
| Front rollstop          | Front barrier prevents wheelchair from inadvertently rolling off platform during platform movement.  |
| Handrail release button | (left and right) Locks handrail in vertical position. Must be pushed inward to release handrail.   |
| Hydraulic cylinder      | Located within carriage and connected to lifting frame. Receives pressurized fluid from hydraulic pump to lift platform.   |
| Hydraulic pump assembly | Electro-hydraulic unit provides hydraulic pressure used to raise platform. Also mounts components for manual operation.  |
| Lifting frame           | Assembly is hinged to front of carriage and to center of platform; raised by single hydraulic cylinder attached to carriage.   |
| Manual pump handle      | Used to manually operate hydraulic backup pump and pressure release valve when electrical power is not available. Also used to rotate platform release shafts.                     |
| Platform                | Curbed area where passenger resides while being raised to vehicle or lowered to ground.  |
| Platform release shaft  | (left and right) Used during manual operation of lift. Disengages platform from enclosure to facilitate manual deployment. Engage and rotate either shaft with manual pump handle. |
| Pull box                | Houses electrical termination points to lift, and a hydraulic line disconnect point. Also accepts input harness from control pendant.  |
| Rollstop control knob   | Provides manual control of rollstop if electrical power is not available.  |
| Safety belt             | Safety restraint belt that spans between handrails to help confine passenger to platform area.   |
| Stow Lock               | Safety lock retains platform when in stowed position (retracted); releases when stow lock lever is raised.   |
| Traveling frame         | (not shown as unit) Assembly comprised of carriage, lifting frame, and platform.   |

## 5-38 Other Features

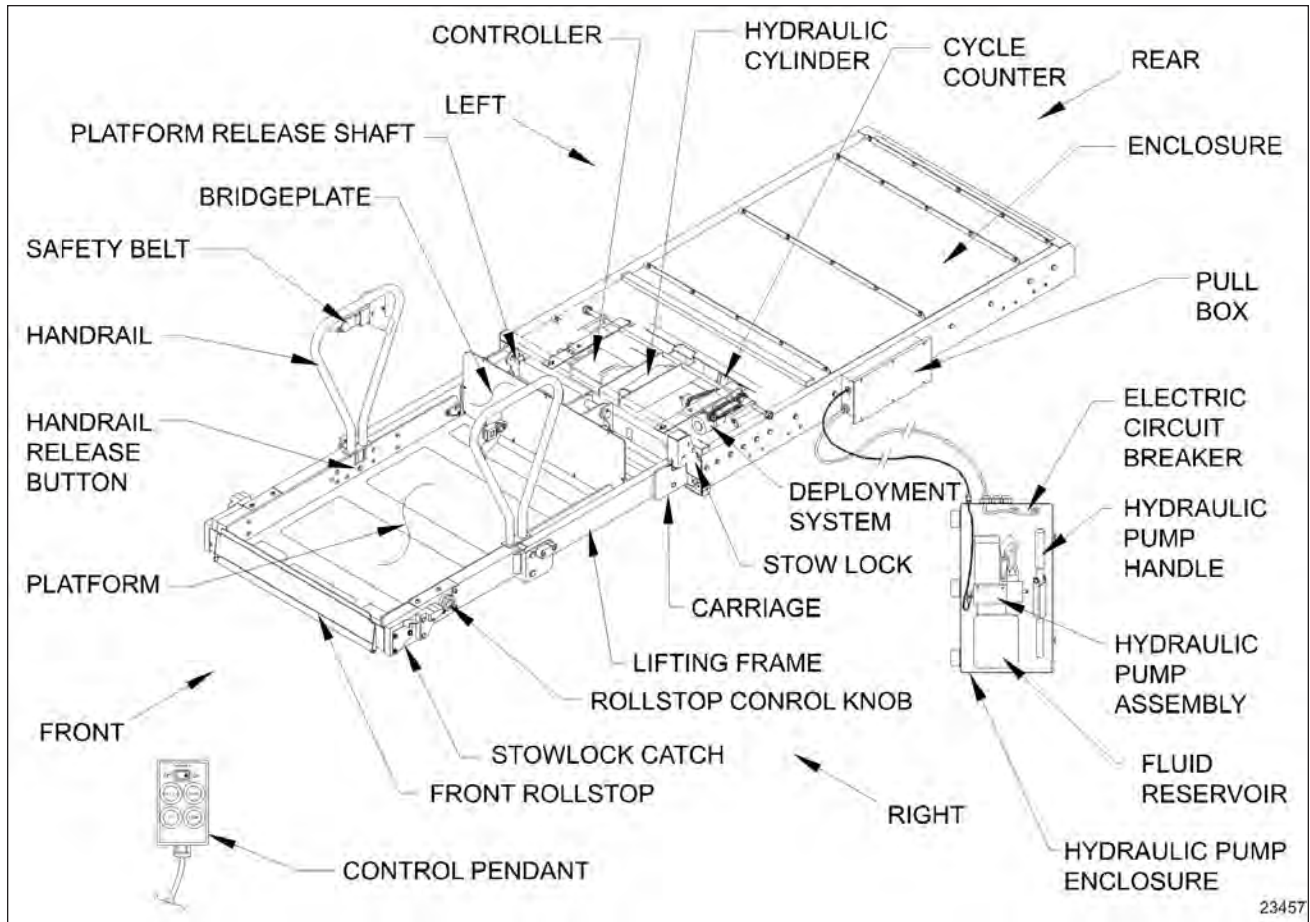


FIGURE 5: MAJOR LIFT COMPONENTS

## GENERAL SAFETY PRECAUTIONS

- To avoid injury, always exercise caution when operating and be certain that hands, feet, legs, and clothing are not in the path of product movement.
- Read and thoroughly understand the operating instructions before attempting to operate the wheelchair ramp.
- Inspect product before each use. If unsafe conditions, unusual noises or movements, do not operate lift until the problem is corrected.
- Stand clear of doors and platform and keep others clear during operation.

## OPERATING INSTRUCTIONS

### Safety Precaution

- To operate the wheelchair lift, the coach must be parked on a flat and level surface, with the parking brake applied.



- Inspect the lift before each use as described in the RICON Operator Manual 32DF9T15 under paragraph “Pre-Operation Lift Inspection”. If any unsafe condition exists, or if unusual noises or movements are noticed, DO NOT use and contact an authorized RICON dealer for repair.
- Read and comply with all warning labels and symbols affixed to the wheelchair lift.
- Wheelchair occupant should face outward when entering or exiting vehicle.
- Do not back onto platform when exiting vehicle. FACE OUTWARD, and verify that platform is at the same height as floor. Check that front rollstop is up and locked.
- The front rollstop is intended to prevent slow, unintentional, rolling off of platform.
- The front rollstop is not intended to stop a quick moving wheelchair. A quick moving wheelchair could tip if the small front wheels collide with the rollstop. Also, the large rear wheels of a quick moving wheelchair could roll over the rollstop. Possible injury to the occupant might occur in either case.
- Verify that wheelchair fits safely on platform; it must not extend beyond edges or interfere with operation of rollstop.
- Do not operate with a load in excess of 660 lbs (300 kg) for Mirage Model F9TF and 800 pounds (363 kilograms) for Mirage Model F9TH.
- Keep arms, legs, and clothing away from moving lift parts.
- The lift is intended for one wheelchair and its occupant, or one standee. Do not overload lift.
- Keep others clear while operating lift.
- Do not allow an untrained person to operate lift.
- Do not allow anyone to stand on bridgeplate. A bent bridgeplate can interfere with the platform as it raises and lowers.
- Lock wheelchair brakes before raising or lowering platform (power chair users should turn off power and set brake).
- Use great care in wet conditions; the wheelchair brakes are less effective if its tires or the platform are wet.
- Do not leave deployed platform unattended. Return to stowed position after use.

## 5-40 Other Features

### Hand-Held Control Pendant And Motion

The lift is operated with a hand-held, hard-wired remote-control pendant. Turn on the POWER ENABLE switch and then control each lift motion by pressing an appropriate button.

The POWER ENABLE switch provides power to the pendant and thereby enables the lift. When turned on, the power switch and each button illuminate.

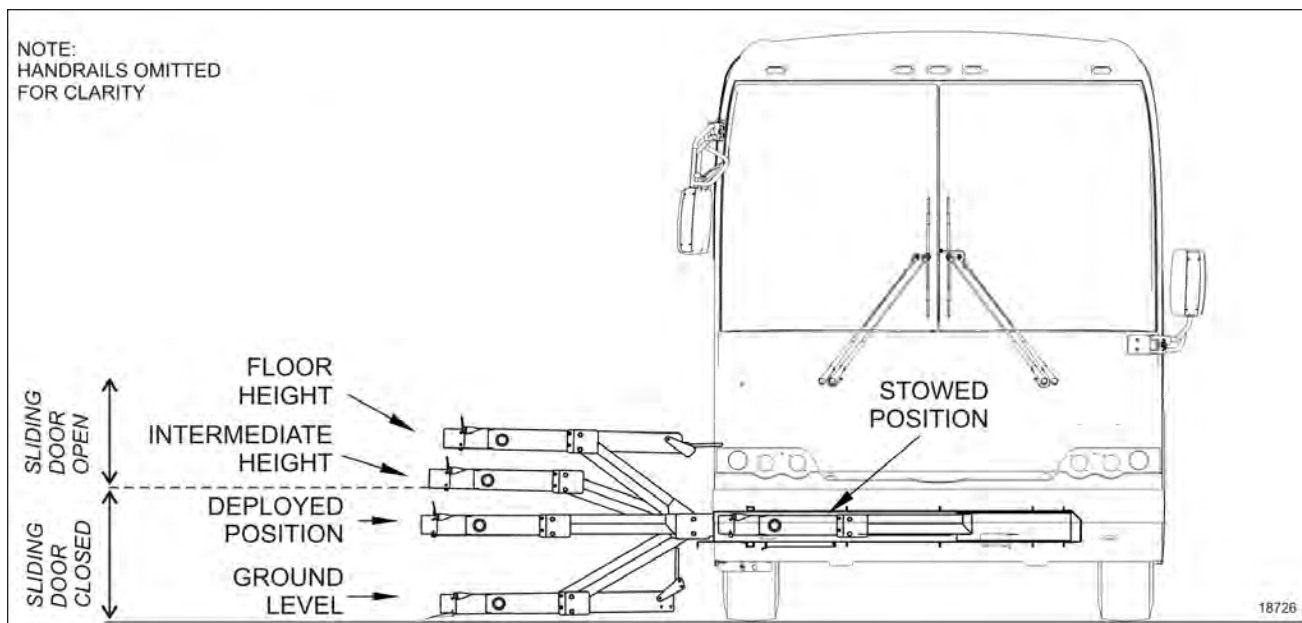
Pressing the DEPLOY/OUT button extends the platform from the lift storage compartment, and pressing the STOW button retracts the platform back into the storage compartment. Pressing the DOWN button lowers the platform towards the ground, and pressing the UP button raises the platform towards the vehicle floor.

A button must be held depressed until the motion is completed. Movement of the platform can be halted at any time by releasing the button.



**FIGURE 6: HAND-HELD CONTROL PENDANT**

| MOTION |              | DESCRIPTION   |
|--------|--------------|---|
|        | DEPLOY / OUT | Platform extends out of vehicle, or deploys.  |
|        | DOWN         | Platform lowers from present height towards ground; front rollstop lowers when platform contacts ground |
|        | UP           | Platform rises from present height towards vehicle floor; rollstop rises before platform leaves ground. |
|        | STOW / IN    | Platform retracts into vehicle, or stows.   |



**FIGURE 7: PLATFORM POSITION WITH INTERMEDIATE HEIGHT (OPTIONAL FEATURE)**

## Normal Lift Operation – To Enter Vehicle

- Before operating lift, be certain vehicle is safely parked on a level area away from traffic. Provide at least 10 feet (3 meters) space for lift operation and passenger boarding.
- The lift operator must take special care to ensure that area is clear before deploying platform. Be certain there are no obstacles beneath platform.
- Open lift compartment door completely.

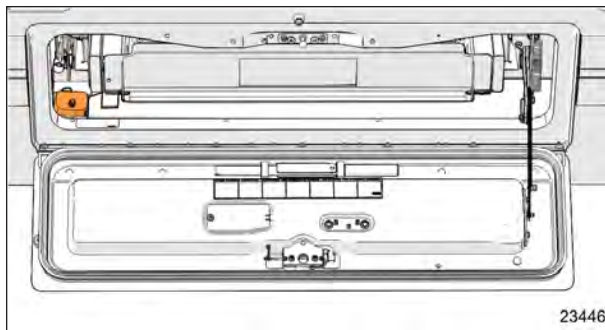


FIGURE 8: X3 SERIES SHOWN

- Open sliding door directly above lift compartment. This does not apply to models that stop upward platform movement prior to reaching floor level. The sliding door on these models is opened after the platform reaches intermediate height.
- The vehicle and lift are equipped with a safety interlock system (i.e. transmission into neutral, parking brake applied). Be certain that it is in the proper mode before attempting to operate lift. The lift will not operate until this feature has been properly engaged.
- Supply power to the wheelchair lift system first by depressing the power switch located on the dashboard.



FIGURE 9: WHEELCHAIR LIFT POWER SWITCH

### NOTE

*Whenever the wheelchair lift power switch is in the ON position, an interlock system prevents releasing of the parking brake and a transmission inhibit feature prevents gear selection when either the lift compartment door or the sliding door is open.*

- Enable lift control pendant by turning on POWER switch located on pendant.
- A person that uses the wheelchair lift while standing (does not require mobility aid equipment) is referred to in this manual as a Standee.

1. **ACTIVATE INTERLOCK:** Make sure parking brake is set and transmission is in neutral.
2. **DEPLOY PLATFORM:** Press and hold DEPLOY/OUT button until platform is fully deployed. NOTE: Platform cannot be moved up or down unless platform is fully extended.
3. **RAISE HANDRAILS:** Lift right handrail to vertical and push firmly down into its socket. Repeat for left handrail. Verify that both handrails are latched in place by attempting to pull upward on them.
4. **BUCKLE SAFETY BELT (to enable lift controller):** Insert belt tongue into buckle and listen for audible “click” then tug belt to confirm belt is securely fastened.

### NOTE

*The safety belt acts as a safety device and it prevents raising or lowering the lift when not buckled.*

## 5-42 Other Features

5. LOWER PLATFORM: Press and hold DOWN button until platform stops at ground level and rollstop opens completely.
6. BUCKLE SAFETY BELT.
7. BOARD PLATFORM: Position wheelchair in center of platform, facing outward and advise occupant to lock wheelchair brakes. Power must be turned off on electric-powered wheelchairs.
12. EXIT PLATFORM: Advise passenger to carefully enter vehicle.
13. BUCKLE SAFETY BELT.
14. LOWER HANDRAILS: Press release button at base of handrail and lift the left handrail upward out of its socket. Lower handrail to platform. Repeat for right handrail.

### NOTE

*Standee must stand near the center of the platform, facing in the direction of travel (into vehicle), and firmly grasp handrails. Do not stand on bridgeplate.*

8. BUCKLE SAFETY BELT (to enable lift controller): Insert belt tongue into buckle and listen for audible “click” then tug belt to confirm belt is securely fastened.

### NOTE

*The next two steps apply only to F9TF/F9TH models that stop upward platform movement at an intermediate level. Other models continue at step 11.*

9. PARTIALLY RAISE PLATFORM: Press and hold UP button until platform stops at intermediate height.
10. OPEN SLIDING DOOR: Fully open vehicle sliding door located above lift. The lift operator, or attendant should do this.
11. RAISE PLATFORM: Press and hold UP button until platform stops at floor height and bridgeplate lowers onto vehicle floor.



### WARNING

Verify that rear edge of bridgeplate lies flat on floor along its entire edge and does not create a tripping hazard.

15. STOW PLATFORM: Press and hold STOW/IN button. Close sliding door at intermediate height. Press and hold STOW/IN button until platform reaches STOW height and then fully retracts into vehicle.

### NOTE

*Do not use DOWN button to lower platform partway prior to stowing, and then complete the stowing process by using IN button. This method may not properly stow platform.*

16. CLOSE DOOR. Close the lift compartment door.

### Normal Lift Operation – To Exit Vehicle

1. ACTIVATE INTERLOCK: Make sure parking brake is set and transmission is in neutral.
2. DEPLOY PLATFORM: Press and hold DEPLOY/OUT button until platform is fully deployed.
3. RAISE HANDRAILS: Lift right handrail to vertical and push firmly down into its socket. Repeat for left handrail. Verify that both handrails are latched in place by attempting to pull upward on them.
4. BUCKLE SAFETY BELT (to enable lift controller): Insert belt tongue into buckle and listen for audible “click” then tug belt to confirm belt is securely fastened.

### NOTE

*The next two steps apply only to F9TF/F9TH models that stop upward platform movement at an intermediate level. Other models continue at step 7.*

5. PARTIALLY RAISE PLATFORM: Press and hold UP button until platform stops at intermediate height.
6. OPEN SLIDING DOOR: Fully open vehicle sliding door located above lift. The lift operator, or attendant should do this.
7. RAISE PLATFORM: Press and hold UP button until platform stops at floor height and bridgeplate lowers onto vehicle floor.



**WARNING**

Verify that rear edge of bridgeplate lies flat on floor along its entire edge and does not create a tripping hazard.

8. BOARD PLATFORM: Position wheelchair in center of platform, facing outward and advise occupant to lock wheelchair brakes. Power must be turned off on electric-powered wheelchairs.

**NOTE**

*Standee must stand near the center of the platform, facing in the direction of travel (into vehicle), and firmly grasp handrails. Do not stand on bridgeplate.*

9. LOWER PLATFORM: Press and hold DOWN button until platform stops at ground level and rollstop opens completely.
10. UNBUCKLE SAFETY BELT.
11. EXIT PLATFORM: Carefully assist passenger off of platform.
12. LOWER HANDRAILS: Press release button at base of handrail and lift the left handrail upward out of its socket. Lower handrail to platform. Repeat for right handrail.
13. STOW PLATFORM: Press and hold IN button until platform reaches STOW height and then fully retracts into vehicle.

## 5-44 Other Features

### MANUAL LIFT OPERATION

The lift can be operated manually if it loses electrical power. The following sections describe important safety preparations to be followed before using the lift, and operating procedures to deploy, raise, lower, and stow the lift. Ricon recommends that manual operation be used only to exit from vehicle, not to enter vehicle.

#### Preparation

- Park vehicle on a level surface, away from traffic. Allow sufficient space for lift operation and passenger boarding.
- The operator must summon assistance to move vehicle to a safe operating area if a breakdown situation exists and vehicle cannot be moved under its own power.
- Check to be certain obstacles are not in path of platform movement.
- Open vehicle doors by hand and secure.
- Caution people in vicinity that platform is about to deploy.
- Follow the "Safety Precautions".

#### Manual Lift Controls

Manual operation components used are a hydraulic backup pump and pump handle, platform release mechanism, and a rollstop control knob.

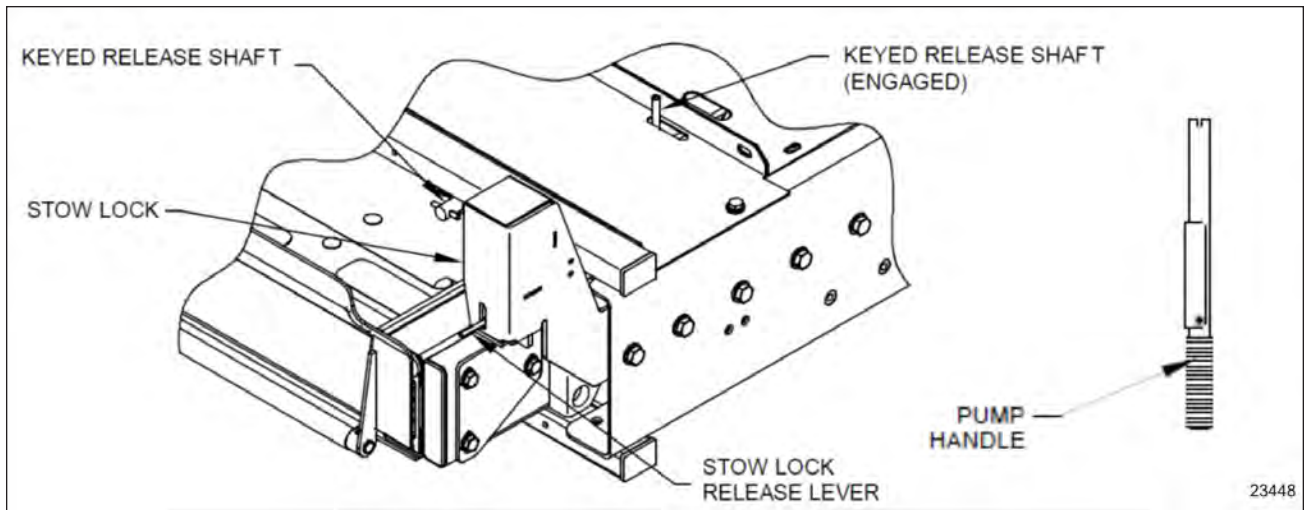


FIGURE 10: MANUAL LIFT CONTROLS

**To Deploy The Platform Manually**

1. Fully open sliding door and lift compartment door. Ensure that there are no obstacles in the path of the lift.
2. Take the manual backup pump handle attached to the inner side of the lift compartment door.
3. Engage either keyed release shaft with the pump handle.
4. Rotate the keyed release shaft ¼-turn (as indicated on adjacent decal) while lifting stow lock lever simultaneously.

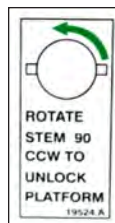
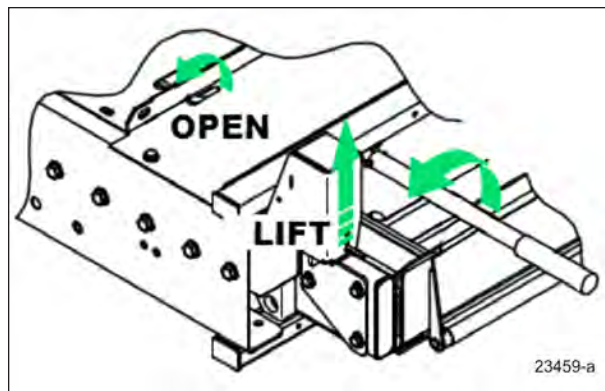
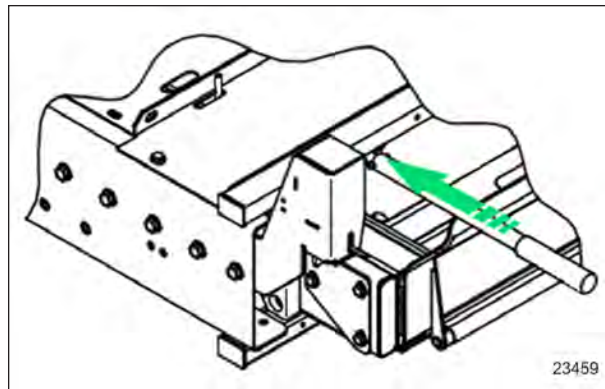
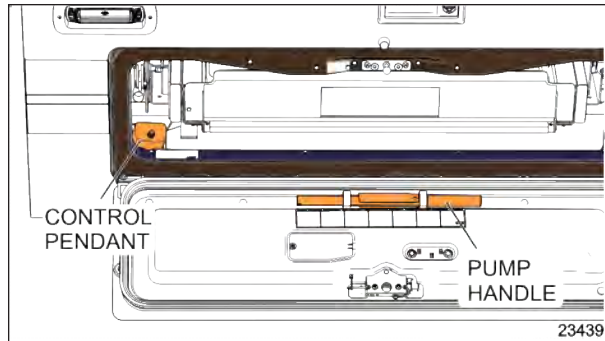
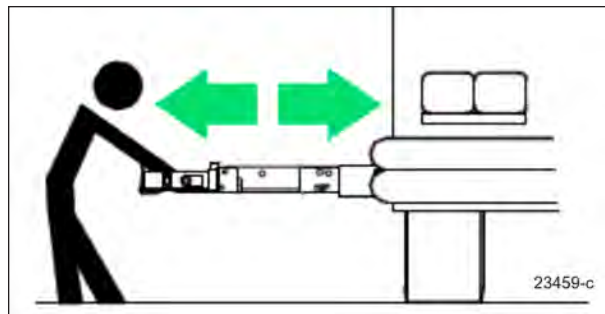


FIGURE 11: DECAL

5. Grasp the top edge of the front rollstop with two hands and pull firmly. The platform moves smoothly after an initial resistance. Pull platform straight out to the end of its travel.

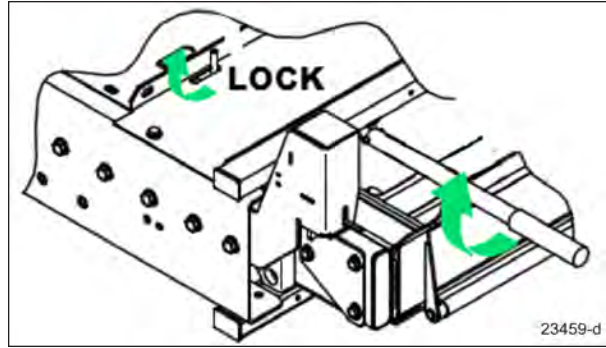


## 5-46 Other Features



### CAUTION

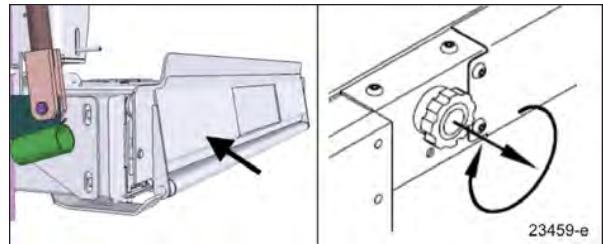
Ensure that release shaft re-engages and locks when platform is fully extended. If release shaft does not engage, use manual pump handle and turn ¼-turn (direction opposite to orientation shown on adjacent decal) to re-engage release shaft.



6. Lift right handrail to vertical and push firmly down into its socket. Repeat for left handrail.

### To Raise The Platform Manually

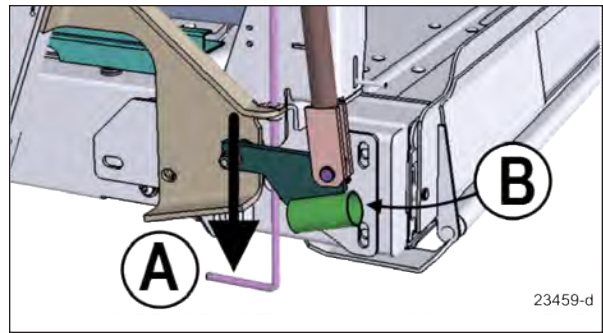
1. Verify that rollstop is up (closed). Pull rollstop control knob out and rotate fully clockwise, if it isn't up.



2. Close the backup pump release valve by pushing the actuating rod (A) DOWN (release valve should already be closed).

### NOTE

*Pumping the handle raises the platform when the release valve is closed.*



3. Insert pump handle into backup pump socket (B), then pump handle to raise the platform to the floor level.
4. Position wheelchair in center of platform, facing outward, and advise occupant to lock wheelchair brakes. Power must be turned off on electric-powered wheelchairs.

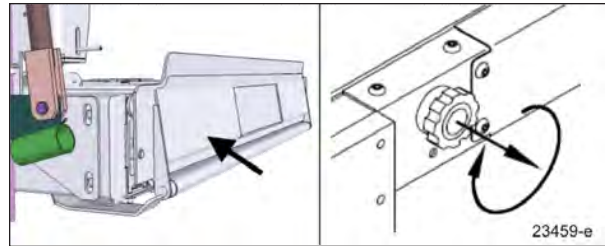
### NOTE

*Standee must stand near the center of the platform, facing in the direction of travel (into vehicle), and firmly grasp handrails. Do not stand on bridgeplate.*

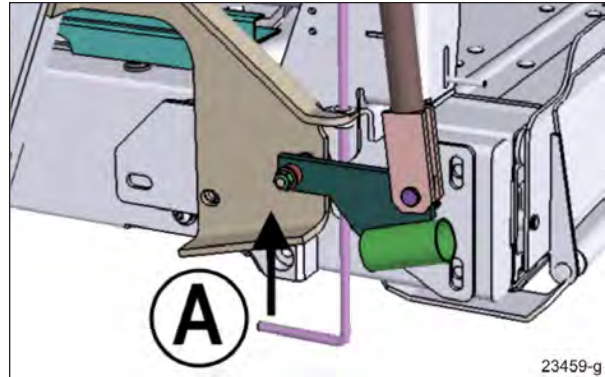


### To Lower The Platform Manually

1. Verify that rollstop is up (closed). Pull rollstop control knob out and rotate fully clockwise, if it isn't up.

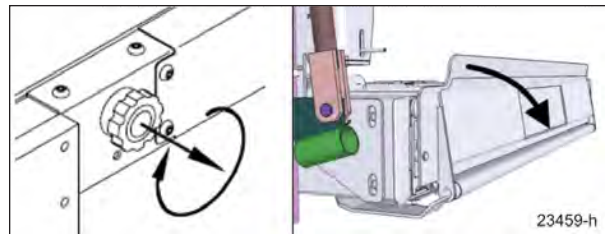


2. Slowly pull the manual backup pump release valve actuating rod (A) UP until the platform begins to lower (opening the release valve lowers platform).

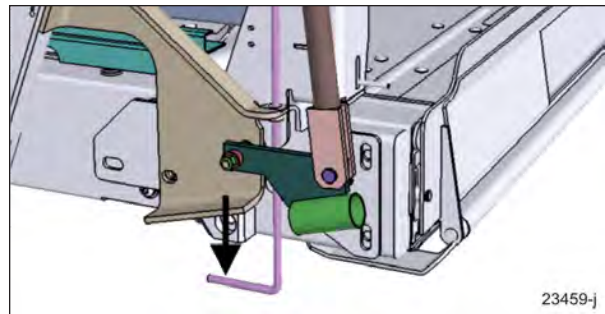


3. Allow the platform to reach ground level.

4. Pull rollstop control knob out and rotate fully counterclockwise. Rollstop must lie flat on ground.

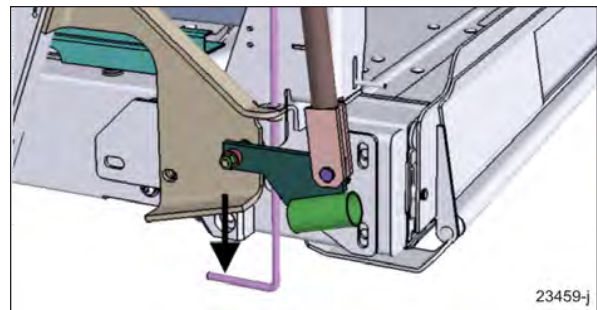


5. Carefully assist passenger off of platform.
6. Push the backup pump release valve actuating rod back DOWN until lightly-snug.



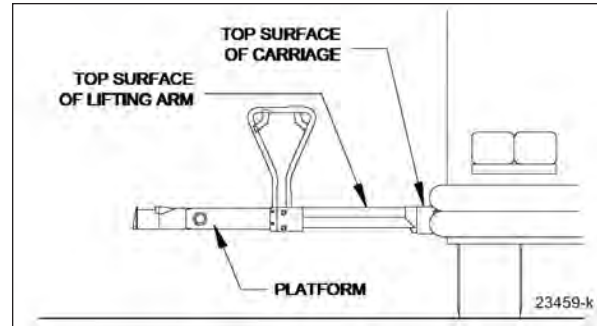
### To Stow The Platform Manually

1. Verify that the backup pump release valve is closed (actuating rod (A) pushed DOWN).



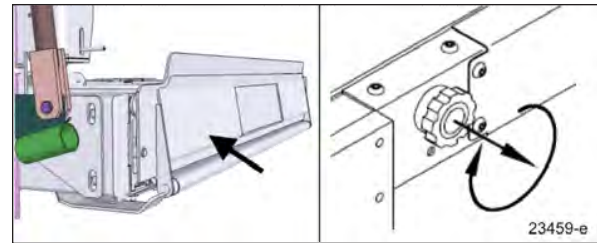
## 5-48 Other Features

2. Raise the platform to stow height; position the top surface of the platform lifting frame arm at the same height as the top surface of the carriage. If the exact height cannot be obtained, a slightly low platform is preferred to slightly high. This alignment eliminates interference between the platform and enclosure when pushing the platform into the enclosure.



**FIGURE 12: LIFTING ARM AND CARRIAGE AT SAME HEIGHT**

3. Verify that rollstop is up (closed). Pull rollstop control knob out and rotate fully clockwise, if it isn't up.

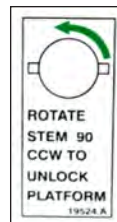


4. Lift the left handrail upward out of its socket. Lower handrail to platform. Repeat for right handrail.

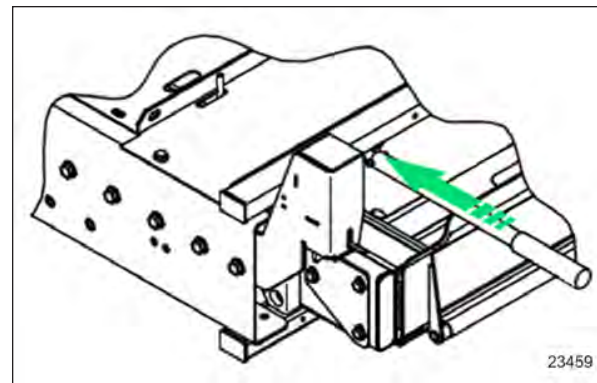
### CAUTION

An able-bodied person must stow the platform. Use caution and avoid injury.

5. Engage either keyed release shaft with the pump handle.
6. Rotate the shaft  $\frac{1}{4}$ -turn (as indicated on adjacent decal).



**FIGURE 13: DECAL**

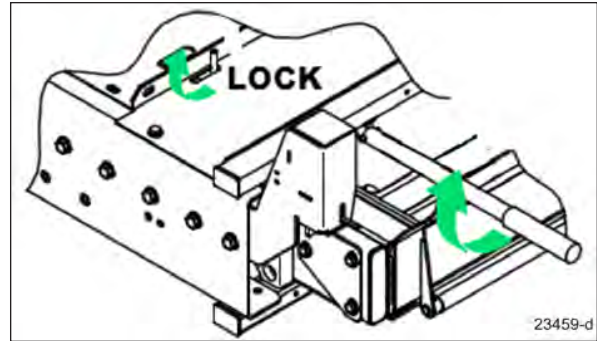


7. Grasp the top edge of the rollstop, or the handrails, with two hands and push firmly. The platform moves smoothly after an initial resistance. Push platform in fully.

### CAUTION

The platform must lock in place when fully stowed. Check platform retention by attempting to pull platform outward; it must not move.

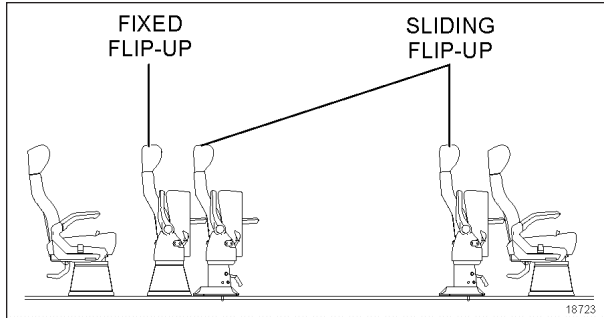
8. If platform does not lock, rotate either platform release shaft  $\frac{1}{4}$ -turn (direction opposite to orientation shown on adjacent decal) to re-engage (lock) release shaft. Platform must be fully stowed before rotating shaft.
9. Verify that stow lock striker is engaged and platform is securely stowed.



## 5-50 Other Features

### SEATS RECONFIGURATION

To accommodate a wheelchair, one row of seats must be folded and two rows must be folded and slide away. Seats may be folded on both sides of the coach to make room for a second wheelchair.



**FIGURE 14: POSSIBLE SEATING ARRANGEMENT**

Electrical wheelchair or tri-wheeler may require moving the sliding seats on both sides of the coach to allow enough turnaround space.

To fold a set of seats, raise the seat back then lift up the seat cushion by pulling the yellow handle under the cushion.



**FIGURE 15: FOLDING AND SLIDING SEATS**

To slide a row of seats, remove the black covers from the floor tracks. Pull up both orange levers (items 1), push down the pedal (secondary lock item 2) and move the row of seats until it clicks at the final position.



**FIGURE 16: SLIDING THE SEATS**

The secondary lock indicator shows that the row of seats is locked at the right position. Push down both orange levers (item 1) before moving to next step.



**FIGURE 17: SECONDARY LOCK INDICATOR**

## WHEELCHAIR RESTRAINT SYSTEMS

Two types of wheelchair restraint systems may be found, depending on the type of seats:

- 4- point wheelchair and occupant securement with floor anchorage.
- 4- point wheelchair and occupant securement with anchorage to passengers seat pedestals.

Refer to Q'Straint publications included in the wheelchair restraint plastic pouches for further details.

### 4-POINT SECUREMENT WITH FLOOR ANCHORAGE

This securement system includes:

- 4 wheelchair tiedown retractors to secure wheelchair to vehicle floor.
- Occupant securements: lap and shoulder belts that integrate to the rear wheelchair restraints.
- Floor anchorages; installed on the vehicle floor.

Two complete sets of wheelchair restraints are kept in plastic pouches and stowed in an overhead compartment. To secure each wheelchair, four tiedown retractors must be used (at all four corners).

Two of the four tiedown retractors have attaching pins to secure the occupant's lap belt. They must be placed at the rear of the wheelchair. Each tiedown retractor slots into a mounting floor pocket.

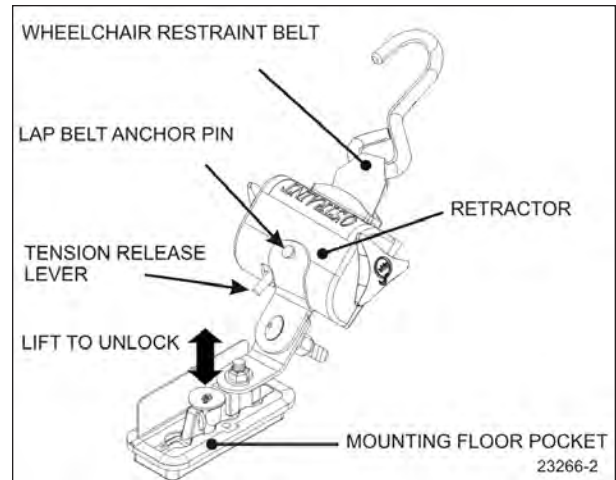


FIGURE 18: WHEELCHAIR ANCHORAGE SYSTEMS

To anchor the retractors, lift the floor pocket cover, push in the retractor anchor then slide it until it locks in place. Hook one wheelchair restraint belt to each corner of the wheelchair frame (not the wheels) and allow the retractors to tension the belts.

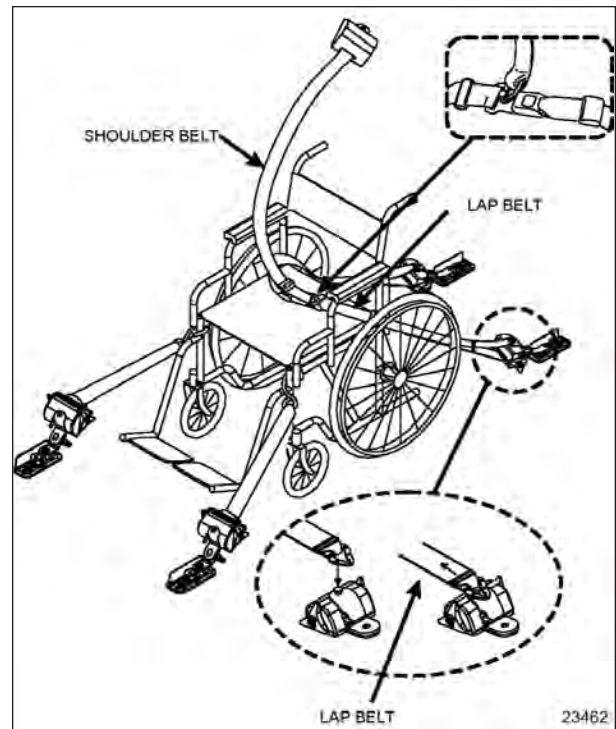
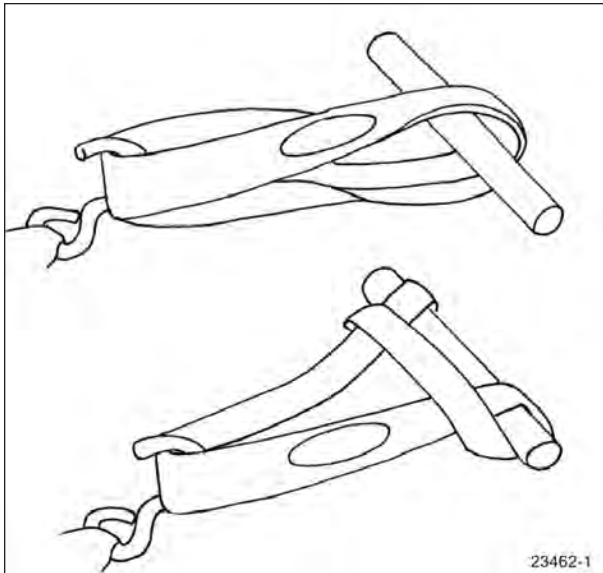


FIGURE 19: WHEELCHAIR RESTRAINTS AND ACCESSORIES

Use the blue webbing loops whenever the wheelchair restraint belt hook cannot reach a stiff member of the wheelchair chassis.

## 5-52 Other Features



**FIGURE 20: TYPICAL USE OF THE BLUE WEBBING LOOPS**

To remove the restraint belts, release tension in the locking mechanism by tightening the belt slightly more with the retractor knob before pushing down the tension release lever found on the retractor. Unhook the wheelchair and allow the belts to retract. Guide the belts in, making sure they remain untwisted as they retract.

Release the anchor by lifting the lock pin then sliding out and up the anchor from the floor pocket. Close the lid to prevent dirt from entering the pocket cavity.



### WARNING

Do not let restraint belts or occupant safety belts rub against sharp edges. Do not bleach or dry clean.

### Wheelchair Occupant Restraint

Secure the wheelchair occupant in the following manner:

Fix the lap belt to the pins on the retractors of the rear restraint belts. Adjust the lap belt so it sits snug across the hips. Make sure that you place the lap belt buckle on the center aisle side. Fasten the shoulder belt to the pin on the lap belt buckle. A retractor adjusts shoulder belt length automatically.



### WARNING

A snug fit with the lap belt positioned low on the hips is necessary to maximize safety. The belt should not be worn or twisted. Avoid pinching the belt and/or hardware. Do not wear over rigid or breakable objects such as eyeglasses, pens or keys as these may cause injuries.



### CAUTION

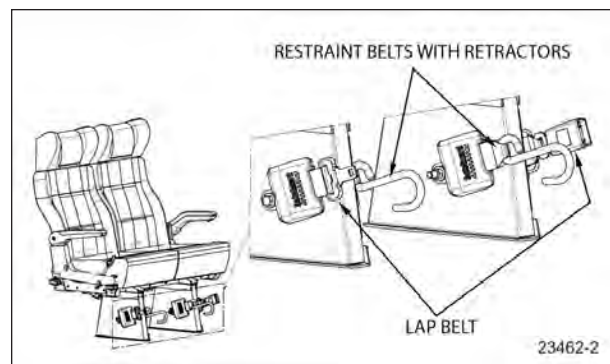
The safety belt buckle provided with the red release button must always be located on the center aisle side.

To release the belts, unfasten the shoulder belt then press the red release button found on the lap belt buckle.

### 4-POINT SECUREMENT WITH ANCHORAGE TO PASSENGERS SEAT PEDESTALS

This securement system includes:

- 4 wheelchair restraint belts and retractors with anchorage to passengers seat pedestals.
- Occupant securements: lap and shoulder belt.



**FIGURE 21: WHEELCHAIR AND OCCUPANT RESTRAINT SYSTEM**

To secure the wheelchair, four restraint belts must be used (at all four corners). Hook one wheelchair restraint belt to each corner of the wheelchair frame (not the wheels) and allow the retractors to tension the belts.

To remove the restraint belts, push down on the tension release lever found on the retractor. Unhook the wheelchair and allow the belts to

retract. Guide the belts in, making sure they remain untwisted as they retract.

### Wheelchair Occupant Restraint

Secure the wheelchair occupant in the following manner:

Fasten and adjust the lap belts so it sits snug across the hips. Make sure that you place the lap belt buckle on the center aisle side. Fasten the shoulder belt by inserting the lap belt tab into the shoulder belt buckle. A retractor adjusts shoulder belt length automatically.



#### WARNING

A snug fit with the lap belt positioned low on the hips is necessary to maximize safety. The belt should not be worn or twisted. Avoid pinching the belt and/or hardware. Do not wear over rigid or breakable objects such as eyeglasses, pens or keys as these may cause injuries.



#### CAUTION

The safety belt buckle provided with the red release button must always be located on the center aisle side.

To unfasten the belts, press the red release button on the shoulder belt buckle first and then unfasten the lap belt by pressing the red release button on the lap belt buckle.

## WHEELCHAIR LIFT SYSTEM - THRESHOLD WARNING SYSTEM (TWS) ADJUSTMENT

There are three verifications to perform;

1. Adjust Aiming of Acoustic Sensor Beam,
2. Test Aim of Acoustic Sensor Beam, and
3. Adjust Acoustic Sensor Timing.

Adjustment of the sensor timing is done at the factory and should not need to be repeated in the field. Readjustment should only be considered if the sensor aiming could not be adjusted to ignore

both the wheelchair in the aisle and the platform during its normal movement.

### ADJUST AIMING OF ACOUSTIC SENSOR BEAM

1. Place wheelchair with passenger in center aisle of coach, pointed at doorway where Threshold Warning System (TWS) is installed. The TWS should not detect a wheelchair and passenger when they are located this far from doorway.

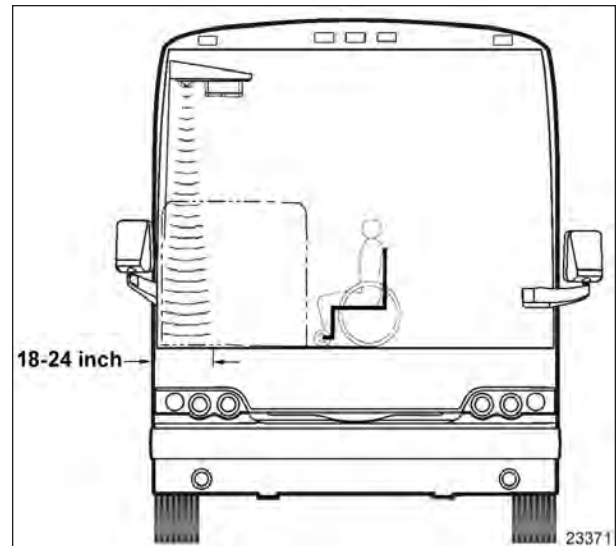


FIGURE 22: TWS AREA

2. Place wheelchair with passenger in center aisle of coach, pointed at doorway where Threshold Warning System (TWS) is installed. The TWS should not detect a wheelchair and passenger when they are located this far from doorway.
3. Place wheelchair with passenger in center aisle of coach, pointed at doorway where Threshold Warning System (TWS) is installed. The TWS should not detect a wheelchair and passenger when they are located this far from doorway.

#### NOTE

*Only in rare instances will adjustment be needed in the counterclockwise direction*

## 5-54 Other Features

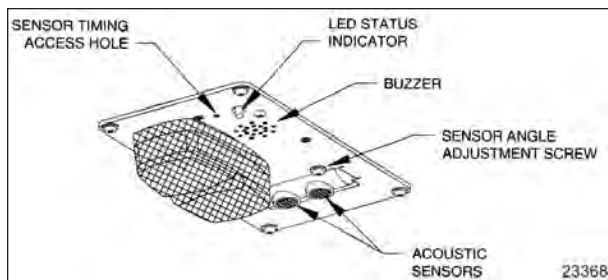


FIGURE 23: TWS MODULE DETAIL

### TEST AIM OF ACOUSTIC SENSOR BEAM (WHEELCHAIR ACCESS)

1. Move wheelchair and passenger slowly towards doorway. TWS should detect wheelchair and passenger (LED will flash, buzzer will sound and the module red light will flash) when centerline of front wheels is between 18 and 24 inches from doorway.
2. Open vehicle access door above lift. Lower platform to ground and place wheelchair and passenger at rear of platform. Rollstop (rear barrier) should be up. Raise platform to floor level. This normal platform motion with wheelchair and passenger aboard should not actuate TWS. If LED does flash (buzzer will also sound and module red light will flash), turn sensor adjustment screw slightly counterclockwise.

#### NOTE

*If an adjustment is made, repeat the previous step where wheelchair is between 18 and 24 inches from doorway.*

### ADJUST ACOUSTIC SENSOR TIMING

1. Support a flat sheet of cardboard, or similar material, directly beneath TWS module at a distance of 4½ feet below module. Sheet must be facing sensors.

#### NOTE

*Before proceeding, visually inspect sensors to verify that they are pointing directly at floor, or nearly, and are not pointing off at an extreme angle.*

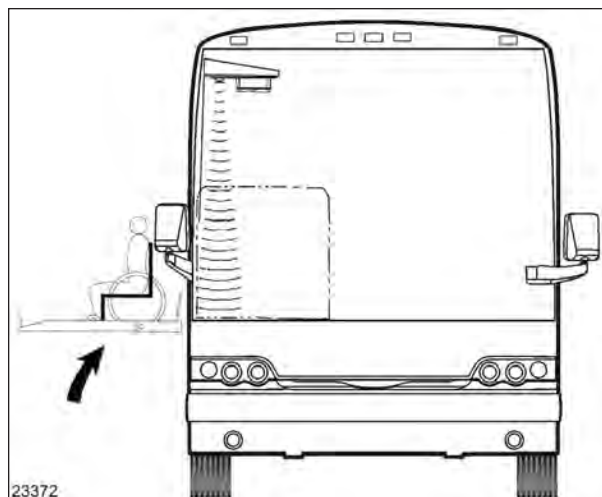


FIGURE 24: CHECKING NORMAL PLATFORM POSITION

2. Note the sensor timing access hole. This hole provides access to a plunger-actuated switch that sets the sensor timing. Insert a 1/16-inch diameter wire-like object into the access hole and press the plunger inward. The LED will flash momentarily while the module establishes the distance and then remain on steady. Release the plunger when the LED ceases to flash.

#### NOTE

*It is important that objects, such as your body, tools, seats, etc, do not interfere with the beam while the adjustment is being made*

### WCL CASSETTE INSTALLATION AND REMOVAL

Refer to section 23 of the Maintenance manual for the WCL installation or removal procedure.



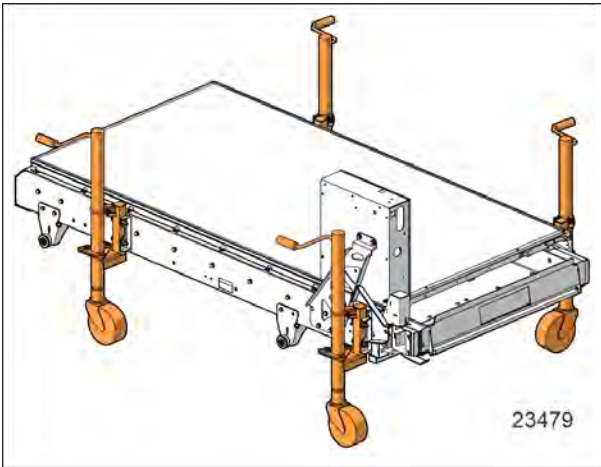


FIGURE 25: WCL CASSETTE WITH JACKS



## SECTION 6 - STARTING AND STOPPING PROCEDURES

|  |          |
|--|----------|
| <b>IGNITION SWITCH</b> .....                         | <b>2</b> |
| <b>STARTING THE ENGINE</b> .....                     | <b>4</b> |
| STARTING FROM THE DRIVER'S SEAT .....                | 4        |
| STARTING FROM THE ENGINE COMPARTMENT .....           | 5        |
| COLD WEATHER STARTING .....                          | 6        |
| JUMP STARTING .....                                  | 6        |
| <b>ENGINE PROTECTION SYSTEM</b> .....                | <b>8</b> |
| AUTOMATIC ENGINE SHUTDOWN .....                      | 8        |
| <b>IDLE SHUTDOWN TIMER</b> .....                     | <b>8</b> |
| <b>ENGINE BLOCK HEATER</b> .....                     | <b>9</b> |
| <b>ENGINE WARM-UP</b> .....                          | <b>9</b> |
| <b>ALLISON TRANSMISSION WARM-UP</b> .....            | <b>9</b> |
| <b>STARTING THE VEHICLE AFTER A FIRE ALARM</b> ..... | <b>9</b> |

## 6-2 Starting and Stopping Procedures

### IGNITION SWITCH

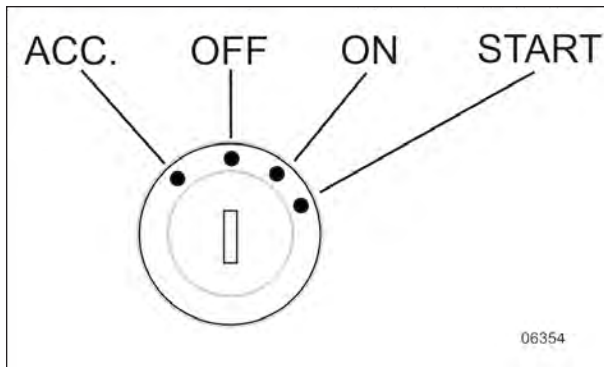


FIGURE 1: IGNITION SWITCH KEY POSITIONS

Coaches may be equipped with an ignition lever instead of an ignition key.

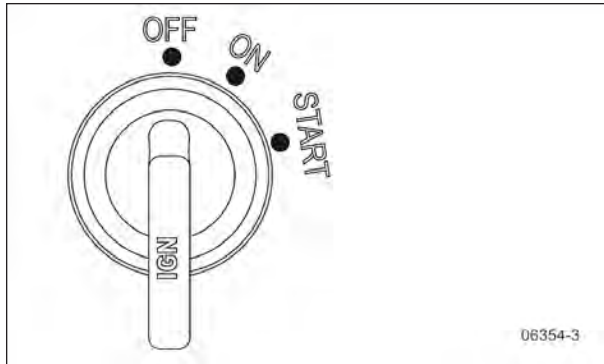


FIGURE 2: IGNITION SWITCH LEVER POSITIONS

The ignition switch is located on the lower left side of the dashboard. The keyed ignition switch has four positions. The ignition lever has three positions or four (ACC.) depending on the vehicle configuration:

**OFF** - In the off position, ignition cannot take place. The key can be removed when in this position.

The electrical circuits are not activated when the switch is in this position. Only the accessories connected directly to the batteries can be activated. These are:

- The preheater, the preheater timer and the water pump
- The battery master switch
- The entrance door

- The baggage compartments central locking system
- The battery equalizer
- The engine and transmission control unit
- The fire detection and suppression system

Maintain the switch in this position when parked overnight or for an extended period.



#### CAUTION

When the vehicle is parked overnight or for an extended period of time, the battery master switch should be set to the OFF position.

#### NOTE

The battery master switch is ON when the hazard flashers are activated, even if the key is in the OFF position.

**ACCESSORIES** - To operate the accessories only, turn the ignition key or lever counterclockwise to the **ACC position**. The key cannot be removed in this position.

The electrical circuits are activated when the switch is in this position or when the hazard flashers are activated.

The features enabled when the key is in the **ACC position** are all those linked directly to the battery plus the exterior temperature display, the radio or entertainment system, exterior and interior lighting.

**ON** - Set the ignition to on by turning the key or lever clockwise to the first position. The key cannot be removed in this position.

The following additional electrical circuits are activated when the switch is in the **ON position**: transmission, engine and accessories, ABS system, wipers, dashboard cluster gauges and buzzers, air horn and air dryer heater. Do not leave the key in this position unless the engine is running.

### **NOTE**

*To prevent discharge of the batteries when the engine is not running, some functions are automatically switched off if the battery voltage drops below 24.0 volts for more than 30 seconds. A pictogram and a message will appear in the DID while this protection mode is active. Set the ignition key to the OFF position and then turn the ignition key to the ON position to reactivate the functions for a period of 30 seconds before they switch off again. If a prolonged use of the functions with the engine not running is necessary, connect the battery to a charger.*

**START** – Use this position to crank the engine. The ignition switch is equipped with a starter protection which inhibits turning the lever to the START position if the lever has not previously been turned to the **OFF position**.

The features activated when the engine is running are all those described above plus the HVAC system and daytime running lights.

## 6-4 Starting and Stopping Procedures

### STARTING THE ENGINE

In normal circumstances, the engine should be started from the driver's seat. However, a rear-start panel in the engine compartment allows starting the engine from that location, typically for maintenance operations.

#### STARTING FROM THE DRIVER'S SEAT

- Make sure the engine STOP interlock button located in the engine compartment is reset (twist and pull) to enable starting from the front and that the main electrical shut-off switch is set to the ON position;

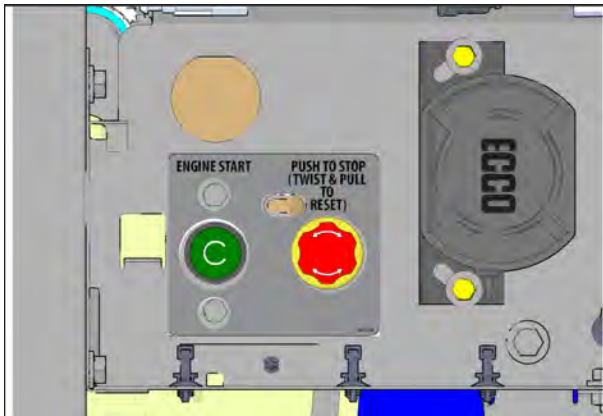


FIGURE 3: TYPICAL ENGINE STOP/ IGNITION INTERLOCK BUTTON

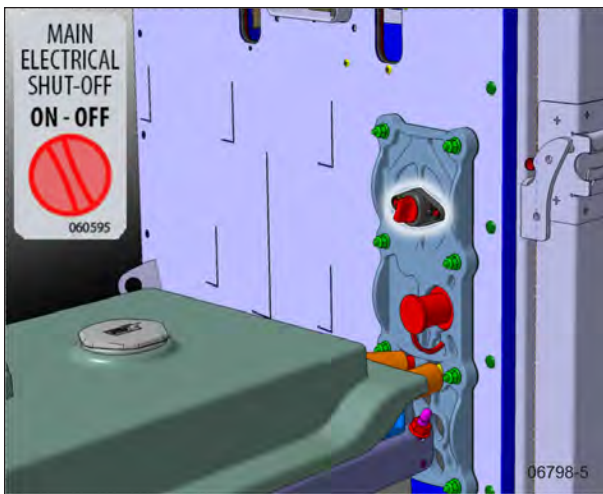


FIGURE 4: MAIN ELECTRICAL SHUT-OFF SWITCH

- Apply the spring-loaded parking brake by pulling the parking brake control button all

the way up;

- Place transmission in neutral;
- Turn ignition key to START position (refer to ["IGNITION SWITCH" on page 4](#) in Controls and Instruments chapter), release the key after the engine starts;

#### NOTE

*When the ignition is turned to ON, the M32QR ABS Pressure Modulator Valve solenoids are briefly energized. This can be audibly detected by a rapid cycling of the PMVs. If the air system is fully charged and the service brake pedal is depressed when ignition is turned to ON, the modulator valves create a sharp audible "chuff" of air pressure.*

- Brake pedal must be applied when selecting Drive (D) otherwise the transmission will stay in neutral (N);



#### CAUTION

Do not engage starter for more than 15 seconds at a time. If engine does not start within 15 seconds, release ignition key and let starter cool for one minute before attempting to restart.



#### CAUTION

Do not press the accelerator pedal before starting. This could result in an electronic control unit fault and degrade the fuel system control.



#### CAUTION

Special precautions are necessary with turbocharged engines to avoid possible turbine damage. After starting, run the engine at normal idle for two minutes to allow lubricating oil to reach the turbocharger. Then run the engine at fast idle. Let oil pressure reach normal operating range before driving.

#### NOTE

*If engine does not start, return key to OFF position before attempting to restart.*

### NOTE

If the accelerator pedal is depressed before starting, release and wait 30 seconds before attempting to restart.



### WARNING

Do not use ether or other combustible starting aid fluid on any engine equipped with an intake air preheater. If the engine is equipped with a preheater, introduction of ether or similar starting aids could cause a fire or explosion resulting in severe property damage, serious personal injury or death.

### Stopping The Engine

1. Apply parking brake and place transmission in neutral (N);
2. Allow engine to idle for at least two minutes before shutting down the engine. This ensures that the turbine speed drops and allows time for the engine exhaust gas temperature to drop to about 300°F (150°C);
3. Shut off all electrical loads;
4. Turn the ignition key to the OFF position.



### CAUTION

Do not shut off the engine when running above normal idle.



### CAUTION

Set the main electrical shut-off switch to the OFF position after parking and when left unattended for an extended period of time.

### NOTE

To prevent discharge of the batteries when the engine is not running, some functions are automatically switched off if the battery voltage drops below 24.0 volts for more than 30 seconds. A pictogram and a message will appear in the DID while this protection mode is active. Set the ignition key to the OFF position and then turn the ignition key to the ON position to reactivate the functions for a period of 30 seconds before they switch off again. If a prolonged use of the functions with the engine not running is necessary, connect the battery to a charger.



### CAUTION

When the vehicle is parked overnight or for an extended period of time, the main electrical shut-off switch should be set to the OFF position.

### STARTING FROM THE ENGINE COMPARTMENT

Push buttons to start and stop the engine from the engine compartment are located on the R.H. side of engine compartment.



### DANGER

Apply parking brake and place transmission in neutral (N) before starting engine from inside the engine compartment.

1. Set the main electrical shut-off switch and ignition switch to the ON position.
2. Press the rear start push button to start engine from the engine compartment.

When servicing the engine, push the engine stop/ignition interlock button to prevent the engine from being started from the driver's area or the rear start push button.

Once servicing is done, twist and pull the button to allow normal engine start.



### CAUTION

Refer to cautions in "STARTING FROM THE DRIVER'S SEAT" in this section.

## 6-6 Starting and Stopping Procedures

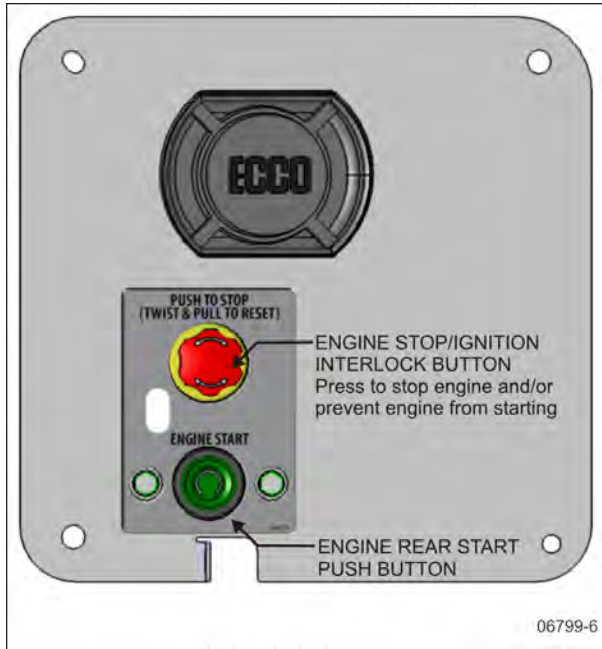


FIGURE 5: REAR START PANEL



### DANGER

Do not wear loose clothing when working near engine. Stand clear of rotating components.



### DANGER

Rotating shafts can be dangerous. They can snag cloth, skin, hair and hands, causing serious injury or death. Do not work on a shaft or other rotating parts of the vehicles (with or without guard) when the engine is running.

### Stopping The Engine

Press the red engine STOP/ignition interlock button while the engine is running to stop the engine from the engine compartment.

### COLD WEATHER STARTING

When starting a cold engine, the intake air will be warmed up with the intake air preheater. Turn the ignition switch to the ON position. The intake air preheater will not engage at coolant temperature above 54°F (12°C). If the coolant temperature is below 54°F (12°C), the intake air preheater will engage and will light the preheater telltale between 0 and 50 seconds, depending on the engine coolant temperature. Wait before the

preheater telltale has turned off before starting the engine.



Intake Air Preheater Telltale

If necessary, once the engine has started, the preheater will re-engage (post heating) for the same length of time as the preheat time.



### WARNING

Volvo D13 Engine

This engine is equipped with an intake air preheater. Never use ether or other combustible starting aid fluid. Introduction of ether or similar starting aids could cause a fire or explosion resulting in severe property damage, serious personal injury or death.

### JUMP STARTING

In order to avoid damage to solid-state electrical components, it is important that jumper (booster) cables are used correctly and only in emergencies. To jump start, use another 24 volt DC, negative grounded, power source. Use only jumper cables rated at 500 cranking amperes.



### DANGER

Injury, explosion, battery acid damage or charging system overload may result if these jump starting procedures are not precisely followed.



### WARNING

Wear eye protection and remove rings, metal jewelry and watches with metal bands.



### DANGER

The battery could rupture or explode if jump started when the run-down battery fluid is frozen or if the battery fluid level is low. Check condition of run-down battery before attempting to jump start.





### DANGER

The gases given off by batteries while jump starting are explosive. Do not smoke near batteries.



### CAUTION

Do not let the two vehicles touch. Keep a walk-through distance between the two vehicles. Make sure positive (red) and negative (black) jumper cable clamps do not touch.



### CAUTION

Never connect the jumper cable to the negative terminal post of the run-down battery.



### CAUTION

Do not jump-start if a maintenance-free battery has a yellow test indicator. Have the battery replaced.



### WARNING

Before attempting to jump-start, make sure the parking brake is applied and the transmission is in neutral (N). Turn off all lights, heaters and other electrical accessories.



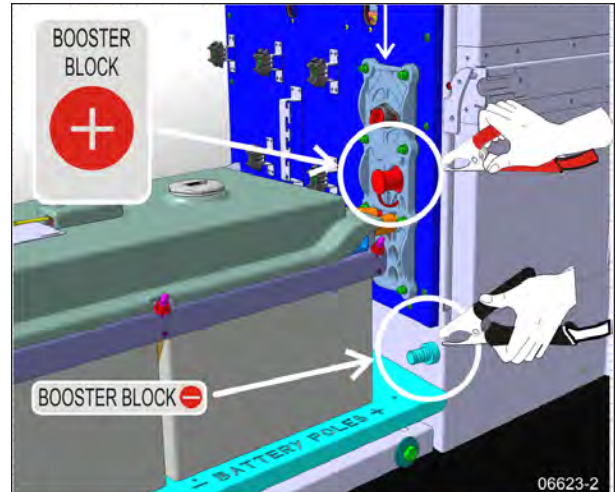
### CAUTION

Choose a booster vehicle which produces comparable amperage as your vehicle.



### CAUTION

Off-board battery charger with a start boost facility must not be used to jump-start the vehicle. This could damage the electrical system.



**FIGURE 6: BOOSTER BLOCK TERMINALS LOCATION (X3 SERIES)**

To jump-start, proceed as follows:

1. Remove the protective cap from the booster block terminal located in the R.H. side engine compartment;
2. If the good battery is in another vehicle, that donor vehicle's engine must be shut off before connecting. Shut off all electrical equipment on both vehicles.
3. Connect one end of the red jumper cable to the positive (+) post of the donor vehicle battery (or booster power source).
4. Connect the other end of the red jumper cable to the positive (+) terminal on the booster block;
5. Connect one end of the black jumper cable to the negative (-) post on the donor vehicle battery (or booster power source);
6. Connect the other end of the black jumper cable to the negative (-) terminal on the booster block;
7. Start the engine of the donor vehicle and increase the engine rpm speed slightly and maintain at that level for approximately 5 minutes to recharge

## 6-8 Starting and Stopping Procedures

- dead batteries and then, shut the engine off;
8. Start the vehicle with the dead battery;
  9. Disconnect the jumper cables in reverse order given in steps 2 through 5;
  10. Install protective cap on the booster block terminal.

### NOTE

*Jumper cables must be rated at 500 cranking amperes. If jumper cable length is 20 feet (6 m) or less, use 2/0 (AWG) gauge wires. If cable length is between 20 and 30 feet (6 to 9 m), use 3/0 (AWG) gauge wires.*

## ENGINE PROTECTION SYSTEM

The engine protection will automatically derate or stop the engine when certain engine conditions reach a critical stage.

In the event of a serious fault, the red STOP telltale light comes on and an audible alarm will sound if the engine is running.



An illuminated STOP telltale light indicates a serious problem has been detected, and the driver must respond immediately to the problem. The vehicle must be safely pulled off the road and stopped. In some instances, the engine must be switched off immediately.

## AUTOMATIC ENGINE SHUTDOWN

Prior to an actual automatic shutdown, the engine will automatically derate, go to idle, and then stop as the vehicle speed gets below 2 mph (3 km/h).

The engine shutdown protection will automatically derate and stop the engine when one or more of the conditions listed below reaches a critical point:

- High engine coolant temperature
- High engine oil temperature
- Low engine oil pressure
- High crankcase pressure

After the automatic engine shutdown sequence, the engine may be restarted. To do so, turn the ignition switch to the OFF position for 7 seconds and then turn it back to ON. However, it will only operate for 30 seconds unless the problem is resolved.

Use this function sparingly and in order to move the vehicle to a safe parking place only. Excessive use may result in severe engine damage.



### WARNING

Failure to take necessary action when the STOP telltale light is on can ultimately result in automatic engine derate and shutdown.

## IDLE SHUTDOWN TIMER

The idle shutdown timer (optional) is programmed to shut down the engine after a specific engine idling time. The idling time cannot be changed by the driver but can be changed with the use of a laptop computer and Premium Tech Tool. In this case, the engine idling time can be set from 30 seconds up to 1 hour.

The engine will shut down at the set time under the following conditions:

- Vehicle speed is 0;
- Engine is running at normal idle speed;
- Engine coolant temperature above 120°F (49°C);
- Temperature inside vehicle is between 59°F (15°C) and 81°F (27°C);
- Parking brake applied;
- Transmission into neutral (N);
- Wheelchair lift system is not in use;

Pressing the fuel pedal will prevent engine shutdown and restart countdown.

### ENGINE BLOCK HEATER

The vehicle may be equipped with an engine immersion-type electric block heater to assist cold weather starting. A connector is on the rear pillar of the curbside engine compartment door frame. Using an extension cord, connect to a 120-V outlet.



#### CAUTION

Connect only to a 120-V power source. Use only grounded (three prongs) extension cords with a minimum rated capacity of 15 A. Disconnect the extension cord before starting. Before driving, make sure the extension cord is disconnected.

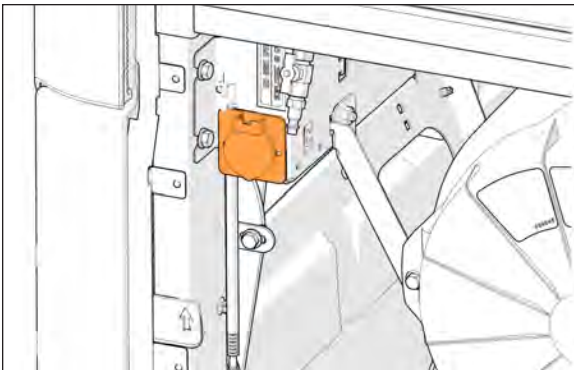


FIGURE 7: ENGINE BLOCK HEATER CONNECTOR (TYPICAL)

### ENGINE WARM-UP

After starting the engine, keep the parking brake applied and let the engine run at normal idle for two minutes to allow lubricating oil to reach the turbocharger. Increase engine speed to fast idle, using the fast idle switch located on the dashboard for five minutes, without loading the engine. Monitor the gauges and indicator lights to make sure all conditions are normal. If an abnormal condition is observed, stop the engine immediately and have the condition corrected.

#### NOTE

*The engine will reach normal operating temperature shortly after driving. Avoid driving at full throttle until engine coolant temperature reaches 140°F (60°C).*



#### DANGER

Never let the engine run in an enclosed, non-ventilated area. Engine exhaust fumes contain dangerous gases which can be fatal if inhaled. Before warming up the engine, open the door (s) or move the vehicle outside.

### ALLISON TRANSMISSION WARM-UP

With an automatic transmission, when the temperature falls below -20°F (-29°C), the CHECK telltale light illuminates after the engine is started, and a reminder tone will sound. In this case, the transmission will be locked in neutral (N) until the transmission temperature rises above -20°F (-29°C) and the CHECK telltale light goes out. The transmission will only operate in first or reverse gears until it reaches normal operating temperature.

### STARTING THE VEHICLE AFTER A FIRE ALARM

The vehicle may be started after a fire alarm without resetting the system. Refer to "[Starting The Vehicle After A Fire Alarm](#)" on page 1 in Section 7 Safety Features and Equipment for the complete procedure.



## SECTION 7 - SAFETY FEATURES AND EQUIPMENT

|   |           |
|---|-----------|
| <b>EMERGENCY EXITS</b> .....  | <b>2</b>  |
| SIDE WINDOWS .....  | 2         |
| ROOF HATCH .....  | 2         |
| EMERGENCY ENTRANCE DOOR OPENING .....   | 3         |
| <b>EMERGENCY EQUIPMENT</b> .....  | <b>4</b>  |
| FIRE EXTINGUISHERS .....  | 4         |
| FIRST-AID KIT .....   | 4         |
| FIRE HATCHET .....  | 5         |
| WARNING REFLECTORS .....  | 5         |
| JACK AND TOOLS X3 SERIES .....  | 5         |
| SPARE PARTS KIT .....   | 5         |
| AUTOMATIC FIRE SUPPRESSION SYSTEM (AFSS) .....                                      | 5         |
| TIRE PRESSURE MONITORING SYSTEM .....   | 6         |
| <b>LIMP-HOME BELT</b> .....   | <b>9</b>  |
| LOWER ALTERNATOR FAILURE .....  | 9         |
| <b>SPARE WHEEL</b> .....  | <b>10</b> |
| CHANGING A WHEEL .....  | 10        |
| SUPER SINGLE TIRE REPLACEMENT .....   | 11        |
| <b>EMERGENCY AIR-FILL VALVES</b> .....  | <b>11</b> |
| <b>EMERGENCY AND PARKING BRAKES</b> .....   | <b>12</b> |
| <b>VEHICLE JACKING POINTS</b> .....   | <b>12</b> |
| HYDRAULIC JACK .....  | 12        |
| <b>TOWING THE VEHICLE</b> .....   | <b>13</b> |
| <b>DAYTIME RUNNING LIGHTS</b> .....   | <b>13</b> |
| <b>FOG LIGHTS</b> .....   | <b>13</b> |
| <b>PERIMETER LIGHTS</b> .....   | <b>13</b> |
| <b>COMPARTMENT LIGHTING</b> .....   | <b>14</b> |
| <b>MUD FLAPS AND SPLASH GUARDS</b> .....  | <b>14</b> |
| <b>BACK-UP CAMERA</b> .....   | <b>14</b> |
| <b>BACK-UP ALARM</b> .....  | <b>14</b> |
| <b>ESSENTIAL FUNCTIONS TO OPERATE THE VEHICLE (BASIC LIMP-HOME FUNCTIONS)</b> ..... | <b>14</b> |
| AVAILABLE FUNCTIONS .....   | 14        |

## 7-2 Safety Features and Equipment

### EMERGENCY EXITS

Locate and learn how to use all possible emergency exits. It is good practice to inform passengers of the location of exits and how to use them in case of an emergency.

#### SIDE WINDOWS

All side windows (except the wheelchair lift door window) can be opened from the inside and used as emergency exits.

To open a side window emergency exit, tilt up the release bar and push the bottom of the window outwards, as illustrated below. The window is hinged from the top and will not fall out.

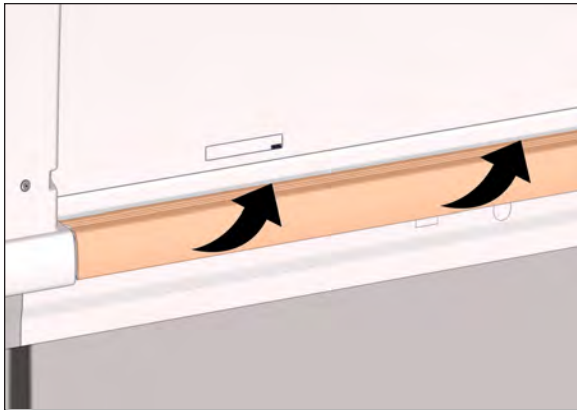


FIGURE 1: SIDE WINDOW EMERGENCY EXIT



FIGURE 2: SIDE WINDOW EMERGENCY EXIT

A pictogram on the dashboard illuminates when a window is opened. Refer to [PICTOGRAMS DISPLAYED ON THE DRIVER INFORMATION DISPLAY \(DID\)](#) for more information .

To close the window, tilt up the release bar and pull the window back. Push down the release bar to lock shut.

### ROOF HATCH

Two roof hatches serve as emergency exits. They are designed to be opened by occupants and are installed on the roof at the front and the rear of the vehicle. In case of an emergency, push the ventilation hatch upward (1). Turn knob ¼ turn (arrow pointing “TO EXIT”) and then push knob to release the hatch (2). Push the escape hatch outwards (3). A decal with operating instructions is located on the hatch.

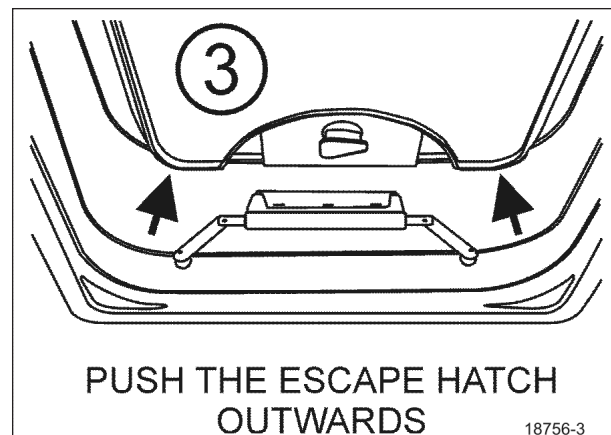
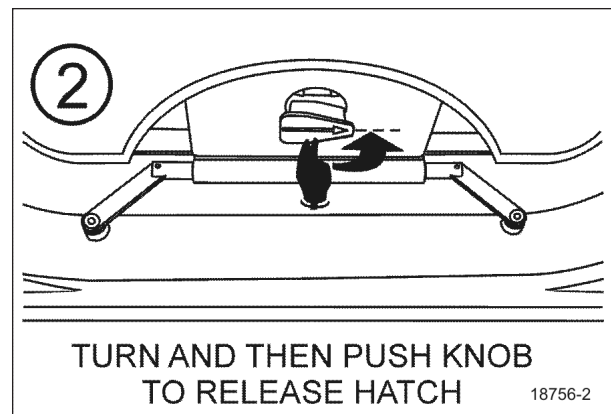
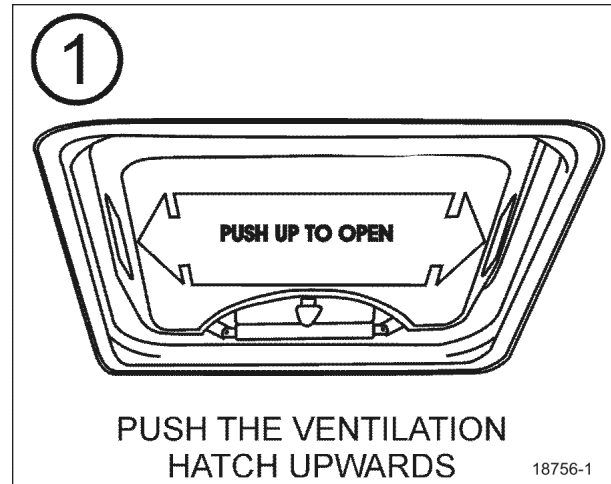


FIGURE 3: EMERGENCY ROOF ESCAPE OPENING

### NOTE

*In the event of ventilation blower motor failure, the roof hatch may be used to aid ventilation by pushing the hatch upward.*



### CAUTION

Be aware of reduced vehicle overhead clearance when driving under overpasses with an open roof hatch.

To latch escape hatch after use, vent arms must be pushed upright in FULL OPEN VENT position. Insert edge firmly between the two sections of the bracket and then return knob to original position (arrow pointing "LATCHED") to lock the hatch. Finally, pull the hatch into closed position, one side at a time.

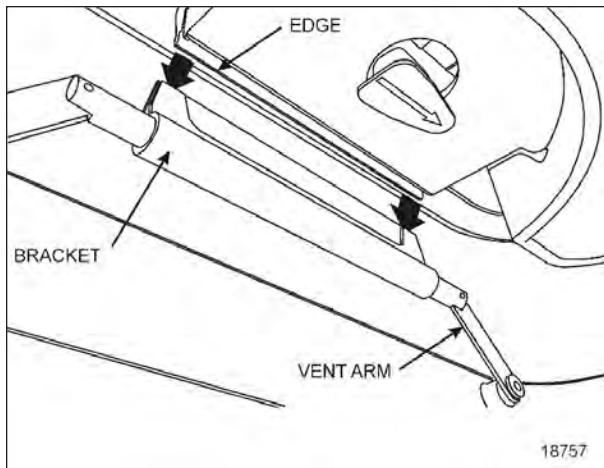


FIGURE 4: ROOF ESCAPE LATCHING

### NOTE

*Hatches may be equipped with fan. The switch to run the fans is located on the right side of the dashboard. Keep the hatches closed when running the fans.*

## EMERGENCY ENTRANCE DOOR OPENING

An unlatch air valve located on the front wall, close to the entrance door allows emergency depletion of the door and locking cylinders. Another unlatch valve is located in the front service compartment and allows emergency opening from outside the vehicle. To open the door in an emergency, first turn the unlatch valve in the direction of the arrows and push (or pull) the door open. To close the door after emergency

opening, return the valve to its initial position, open the door using the door operating switch and close the door normally.

### NOTE

*To be able to open the entrance door in an emergency, the entrance door must first be unlocked using the key or locking lever before unlatching the door from the outside or the inside.*



FIGURE 5: INTERIOR UNLATCH AIR VALVE

## 7-4 Safety Features and Equipment

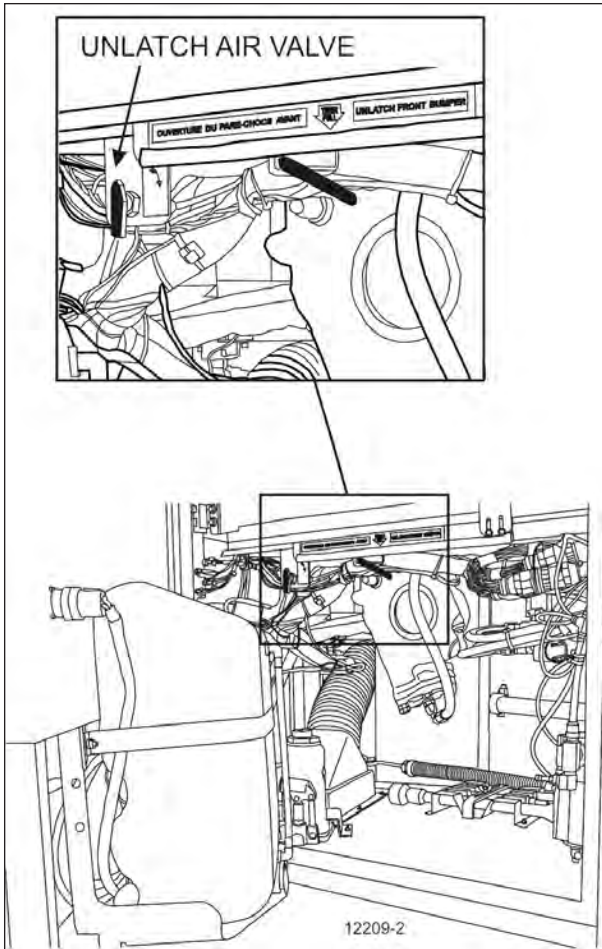


FIGURE 6: UNLATCH AIR VALVE LOCATION (X3 SERIES)

### EMERGENCY EQUIPMENT

The vehicle is equipped with numerous safety features and equipment. Verify the equipment regularly and keep on hand and in good condition at all times. Following is the enumeration and description of safety equipment found on board.

#### FIRE EXTINGUISHERS

Fire extinguishers can be found at different locations in the coach according to the owner's choice.

##### Under The First Row Seats

Depending on selected options, two fire extinguishers may be located under the first row seats. A decal at the bottom of each of the trapezoidal windows in the first row indicates the

location of fire extinguishers. Instructions for use are found on the extinguishers.



### WARNING

Make sure you know how to operate the fire extinguishers in case of an emergency.

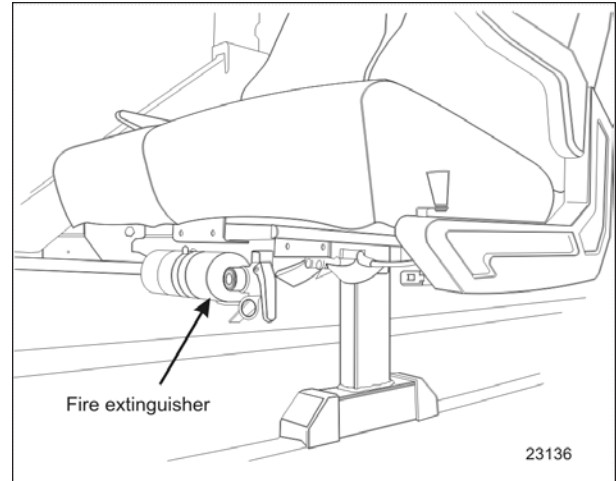


FIGURE 7: FIRE EXTINGUISHER UNDER FIRST ROW SEAT

##### In An Overhead Compartment

An optional fire extinguisher can be located in an overhead compartment. A decal on the door of the compartment confirms the presence of a fire extinguisher.



FIGURE 8: A DECAL INDICATES THAT A FIRE HATCHET, A FIRE EXTINGUISHER AND A FIRST-AID KIT ARE LOCATED IN THIS OVERHEAD COMPARTMENT

##### FIRST-AID KIT

The optional first-aid kit is stored in the first curbside overhead storage compartment. A white cross over red background decal identifies the kit.



### FIRE HATCHET

An optional fire hatchet may be installed in the first curbside overhead storage compartment.

### WARNING REFLECTORS

A box containing three triangular reflectors is provided to warn other drivers on the road in case of a breakdown. The box is located at the ceiling of the first baggage compartment, on the R.H. side. The reflectors provide visible warning of an emergency. The three reflectors should be placed as indicated on the box cover. These reflectors comply with FMVSS 125 (Federal Motor Vehicle Safety Standards).

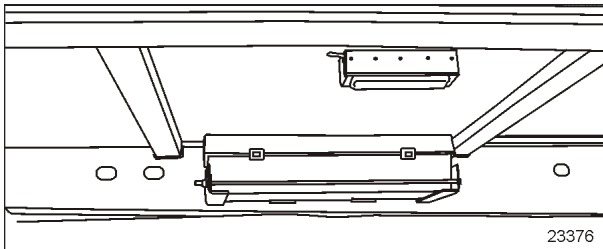


FIGURE 9: WARNING REFLECTORS LOCATION (X3 SERIES)

### JACK AND TOOLS X3 SERIES

For X3 Coach, a kit for jacking up the vehicle and changing wheels is stored in the front service compartment. The kit includes a:

- 12-ton bottle jack;
- Wheel nut wrench and lever.

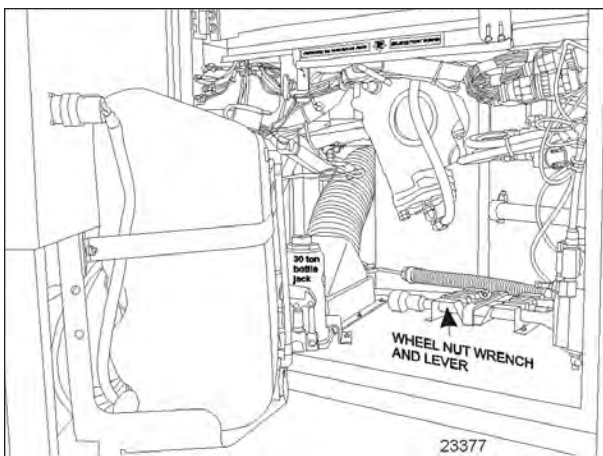


FIGURE 10: JACK/TOOLS LOCATION X3 SERIES

### SPARE PARTS KIT

The vehicle may be equipped with a spare parts kit (optional). The kit contains parts such as bulbs, circuit breakers, belts, etc. The spare parts kit is stored in the first baggage compartment.

### AUTOMATIC FIRE SUPPRESSION SYSTEM (AFSS)

The vehicle may be equipped with the optional Automatic Fire Detection and Suppression System (AFSS).

#### System Operation

When a fire is detected inside the engine compartment, the system sends a fire alarm signal to the **Protection Panel** located in the driver's area near the lateral control panel. The **Protection Panel** immediately turns on the fire "ALARM" lamp and sounds the audio alarm. After a 15-second time delay the engine is automatically shut down. The fire extinguisher is discharged simultaneously with engine shutdown.

#### NOTE

*The Protection Panel continuously monitors system integrity and displays the information via the "SYSTEM OK" and fire "TROUBLE" indicators.*

#### NOTE

*The Manual Activation Switch is used when the immediate discharge of the fire extinguisher and engine shutdown is desired.*

#### Operational Sequence (Fire)

1. A fire detector or linear thermal detector detects a fire in the engine compartment and sends a signal to the **Protection Panel** in the driver's area.
2. The fire "ALARM" lamp on the **Protection Panel** will illuminate solid red and an audible alarm will sound.
3. The operator shall bring the vehicle to a safe stop.
4. The system automatically shuts down the vehicle engine and discharges the extinguisher into the

## 7-6 Safety Features and Equipment

engine compartment 15 seconds after the fire alarm starts unless advanced or delayed by the operator.

- If the operator presses the **Manual Activation Switch**, all delays will terminate and the engine shutdown and extinguisher discharge will occur immediately.
- If the operator presses and releases the **Delay Engine Stop** switch once, the engine shutdown and extinguisher discharge will be delayed by an additional 15 seconds.



### WARNING

The engine will stop 15 seconds after the fire alarm starts. The operator must be prepared to bring the vehicle to a safe stop as soon as the alarm sounds. Steering may become difficult after engine shutdown. If more time is required, the “DELAY ENGINE STOP” switch may be pressed and released for an additional 15 second delay.



### WARNING

The extinguisher discharge may cause an obscuring cloud behind and near the vehicle.

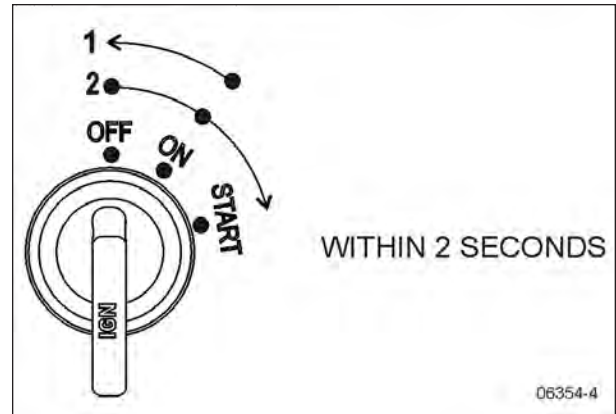
5. The red fire “ALARM” lamp and audible alarm will stay on. The yellow fire “TROUBLE” lamp will also be on indicating a discharged extinguisher.
6. The system must be reset and the fire extinguisher removed and replaced in accordance with the System Reset portion of the Kidde Dual Spectrum Operation & Maintenance Manual.

### Starting The Vehicle After A Fire Alarm

The vehicle may be started after a fire alarm without resetting the system. Refer to ignition switch sequence below. This will not reset the system; rather it will instruct the vehicle’s multiplex system to ignore vehicle interface outputs from the Protection Panel. This feature is intended to be used only in emergencies that require the vehicle to be restarted and moved a short distance prior to system reset. It should not be performed if the cause of the fire has not been clearly identified and corrected.

To start the vehicle, perform this ignition switch (key) sequence.

- From the **ON** position,
- Turn to **OFF**, return to **ON** and **START** vehicle within 2 seconds.



### TIRE PRESSURE MONITORING SYSTEM

The vehicle may be equipped with an optional Tire Pressure Monitoring System (TPMS).

#### Description

System includes the following elements:

- Special tire valves;
- RF sensor inside each tire, fixed to the valve. Sensors provide continuous tire pressure and temperature reading. The normal sensor battery lifespan is 5 years. The remaining lifespan is displayed as a percentage in the TPMS display;
- 3 antennas to receive the sensors RF signal (one in the front spare tire compartment, one above the L.H. side rear wheels and one above the R.H. side rear wheels);
- A TPMS receiver connected to the antennas and located in the front electrical compartment, above the CECM;
- A TPMS display built in the L.H. dashboard panel (with On-Screen TPMS version);
- A “Tire Pressure Warning” indicator.

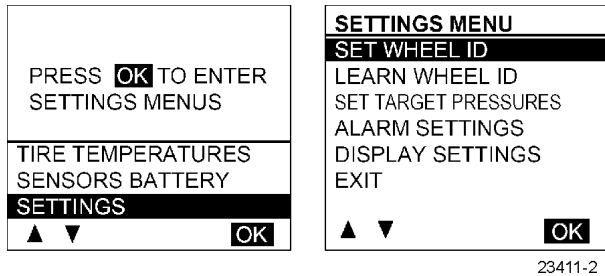
**NOTE**

*It is recommended to check the remaining battery lifespan when changing the tires in order to replace the sensors at the same time if they are due for replacement before the next change.*

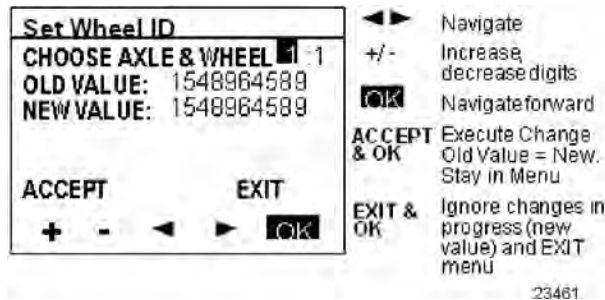
The telltale panel indicator illuminates for 3 seconds when the ignition switch is turned ON to check the display operation and the communication between the display and the vehicle multiplex system. This confirms the communication between the TPMS display and CECM.

**Setting The On-Screen TPMS**

- Set Wheel ID



23411-2



23461

- Learn Wheel ID

This menu allows learning new wheel sensors ID. The user can learn only one wheel, several wheels or all wheels of the vehicle. The sequence automatically jumps to the next wheel such that a user can initiate all wheels without having to come back to the display between each wheel.

The display uses a pressure change as the criteria to recognize which wheel sensor the operator wants to get assigned to a given location. The amount of pressure change required is established at 2 PSI.

A pressure change of about 3 PSI is needed to wake up a sensor and then an extra amount of

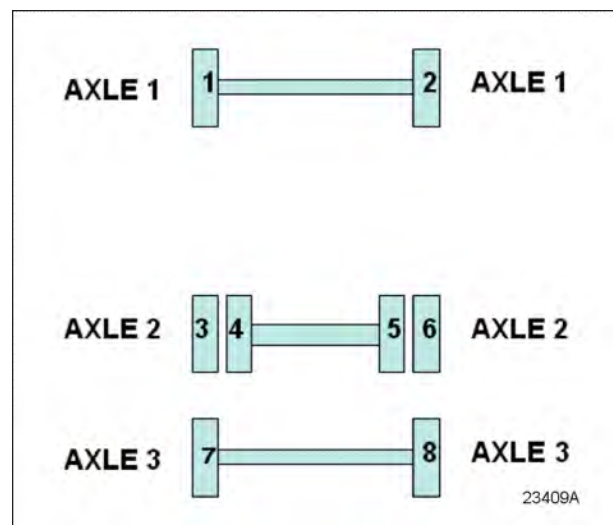
pressure change of 2 PSI is needed to trigger the display. The operator has to create a pressure change by at least 6 PSI and then wait for the display to recognize the pressure change. The wait time corresponds to the sensor sampling rate.

When entering the menu, the axle 1, wheel 1 is selected by default as a starting point for the learning. The user can select another axle with +/- , move the cursor to the wheel number with the right arrow and select another wheel with the +/- or move the cursor down to the start learning button.

After the start learning button is selected, the display stores the first transmission it gets from each sensor ID into the "initial pressure" for that sensor ID. Then it compares each subsequent pressure received for that sensor ID with the initial one and when the comparison shows a delta pressure exceeding the defined level required, this sensor ID is assigned to the selected tire location.

Once a wheel ID has been assigned, the display increments the number of wheels done and it moves to the next axle/wheel in the sequence, waiting for another sensor to come up with a pressure change. Within one learning session, the display remembers which sensor has been assigned and it will not assign it twice.

The sequence increments the display of the next wheel on the same axle, counting wheels from left to right, and then moves to the next axle, counting axles from front to rear.



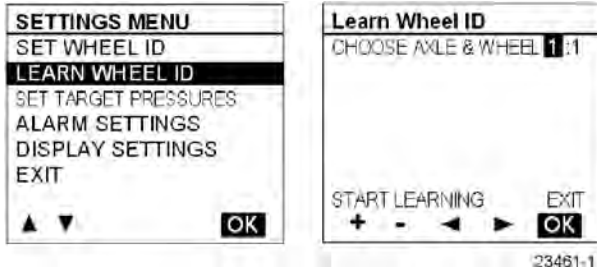
23409A

It activates the next wheel parameter each time a wheel is done. This setting is integrated with the

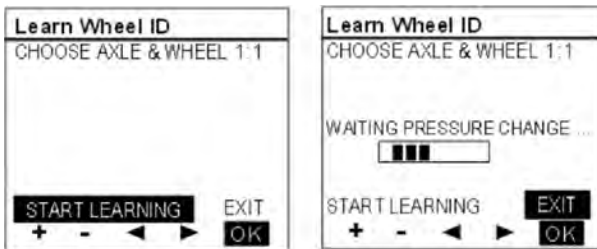
## 7-8 Safety Features and Equipment

vehicle electronic, activating an audible signal on the vehicle, thus providing feedback to the user that he can move on to the next wheel.

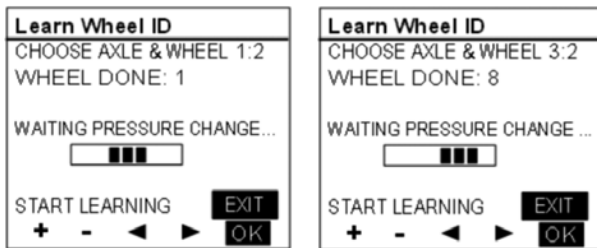
The spare tire can be done by selecting the axle/wheel “spare” which is internally encoded to 15:1.



23461-1



23461-2



23461-3

- Set Target Pressures

This menu allows the end user to fine-tune the target pressure setting, taking account for the specific operating conditions (cold weather operation or unloaded operation). The end user can readjust the target pressure within +30% and -20% of the factory set target pressure but not outside this range.

The factory set target pressure is always kept in permanent memory into the TPMS display and cannot be edited by the end user.

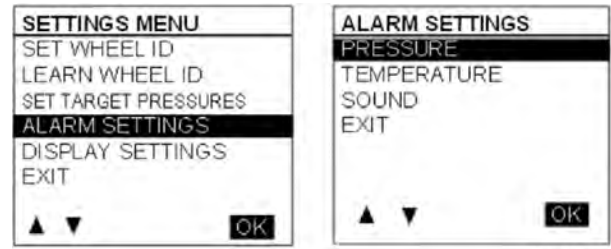
When the user sets a new target value, the selection can't be made outside the valid range.



23461-4

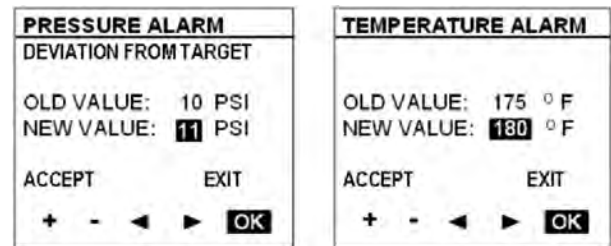
- Alarm Settings

When selecting the Alarm Settings Menu, a submenu containing Pressure Alarm and Temperature Alarm appears.

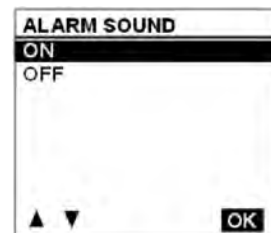


23461-5

When selecting Pressure, the following pressure alarm screen appears. A similar screen is displayed for temperature settings. The cursor can be moved to highlight the data beside “new value” and the “accept / exit” option. +/- allows increasing or decreasing the “new value” data. Pressure alarm changes are made by steps of 1 PSI, in the range from 5 to 20 PSI. Temperature alarm is done by steps of 5°F (2°C) in the range from 150 °F to 180 °F (64 °C to 82 °C). Pressing OK with “accept” highlighted applies changes and exits to the previous menu, while pressing OK while the “exit” option is highlighted exits without changes.



23461-6



23461-7

- Display Settings



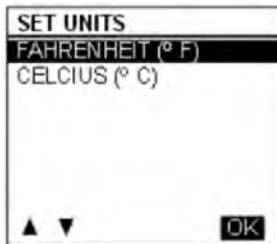
23461-8



23461-12

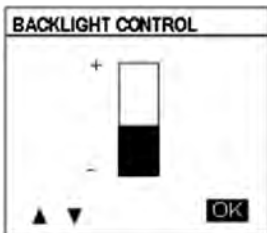
Refer to TPMS Troubleshooting Guide in Appendix D.

- Units & Language



23461-9

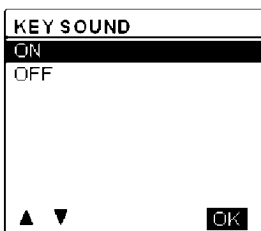
- Backlight Intensity



23461-10

- Key Sound

Turns ON/OFF the sound of keys each time they are pressed.



23461-11

- Tire / Axle Configuration

Pressing the up / down arrows allows to select the option of 2 or 4 tires, which are the choices for the drive axle on the vehicle.

## LIMP-HOME BELT

In case of mechanical failure of the lower alternator, install the limp-home belt on the upper alternator. The installation of the belt allows the coach to be driven to a repair facility after only minor manipulations.

### NOTE

*Because of the alternators arrangement and the belt tensioner, a limp-home belt on the lower alternator is not possible.*

## LOWER ALTERNATOR FAILURE

1. Raise the belt tensioner. Use a breaker bar with a  $\frac{3}{4}$  inch drive to rotate the tensioner pulley upward and relieve alternator belt tension. Remove belt;
2. Install the limp-home drive belt on the drive and top alternator pulleys first;
3. Complete installation of the limp-home belt as shown;
4. Slide the belt on the idler pulley;
5. Gently release the belt tensioner;

### NOTE

*To prevent the batteries from being discharged, the HVAC system will turn OFF automatically if the battery state of charge falls below 50%.*

## 7-10 Safety Features and Equipment

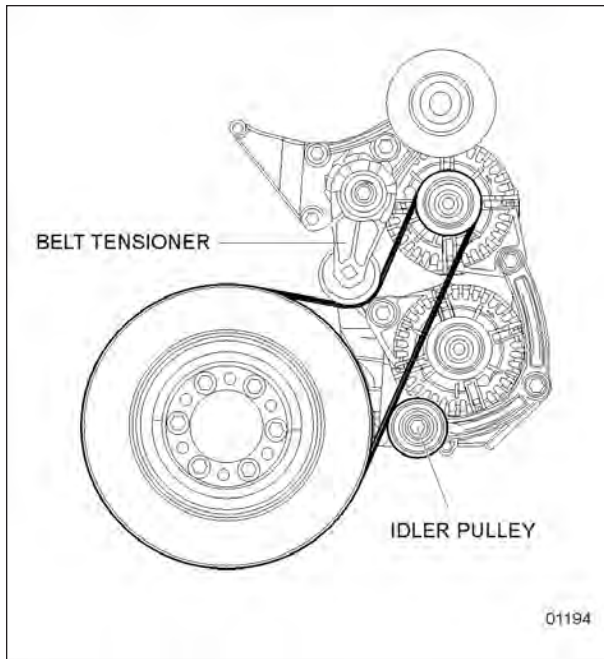


FIGURE 11: LIMP-HOME BELT ON TOP ALTERNATOR

### SPARE WHEEL

The spare wheel and tire are located in a compartment behind the reclining front bumper.

In case of a flat tire:

1. Turn ON the hazard flashers;
2. Bring the coach to a stop on the side of the road;
3. Apply the parking brake;
4. Make sure the coach is parked safely away from traffic;
5. Set up the triangular reflectors in accordance with applicable highway regulations.

### CHANGING A WHEEL

To access the spare wheel compartment, lower the front reclining bumper.

To do so, pull on the release handle located in the front electrical and service compartment.

The bumper will lower gradually. When closing the compartment, be sure the bumper is firmly in place.

#### NOTE

*The bumper is equipped with spring hinges to allow handling by one person.*

#### To Remove The Spare Wheel From The Compartment:

1. Loosen the screw holding the tire in place (see image).
2. Remove the wave pin and the clevis pin.
3. Pull the spare wheel out of the compartment using the strap.

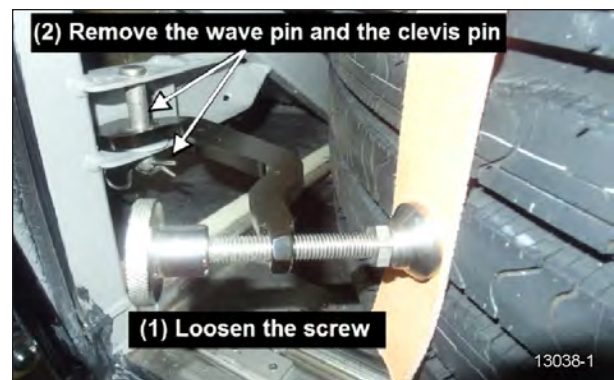


FIGURE 12: REMOVING THE SPARE WHEEL

#### Installation Of The Spare Wheel

#### NOTE

*The jack and tools are located in the first baggage compartment.*

1. Loosen the wheel nuts about one turn;
2. Raise the vehicle by the closest jacking point (refer to Maintenance information [MI18-18](#) for jacking points);
3. Remove the wheel nuts and remove the wheel;
4. Mount the spare wheel over the studs, being careful not to damage the stud threads;
5. Screw in the wheel nuts according to the sequence shown in the following figure and tighten slightly more and repeat the sequence a few times to position the wheel correctly. Once tightening induces wheel spin, lower the coach for final tightening;

- Tighten the nuts progressively in the sequence shown. Final tightening should be done using a torque wrench. Dry tightening torque is 450 – 500 lbf-ft (610 – 680 Nm) for steel as well as for aluminum wheels.



FIGURE 13: TIGHTENING SEQUENCE

FIGURE 14:

**NOTE**

Periodically check the spare tire inflation pressure. Tire pressure should be the maximum pressure specified in the chart.

**NOTE**

Periodically check that the spare is securely fastened in its compartment.



**CAUTION**

Before driving, be sure the flat tire, track, jack and tools are securely reinstalled in their respective compartments.



**CAUTION**

Check that the bumper is securely closed shut before driving.

**SUPER SINGLE TIRE REPLACEMENT**

Increase tire pressure to 125 PSI (862 kPa) if you are using the supplied 365/70 R 22.5 spare tire to replace a super single tire on the drive axle.

In this particular configuration, the spare wheel is to be used for emergencies only and for temporary use.



**WARNING**

- Spare tire pressure should be increased to 125 PSI.
- Do not exceed 80km/h (50 MPH)
- Repair and reinstall original super-single wheel and tire **as soon as possible**.
- While the spare tire is installed, avoid sharp turns, sudden acceleration and braking.



**WARNING**

Before driving, be sure the flat tire, track, jack and tools are securely reinstalled in their respective compartments. Check that the bumper is securely closed shut before driving.

**EMERGENCY AIR-FILL VALVES**

The vehicle is equipped with two air system emergency fill valves to supplement the air system when air pressure is low and the engine cannot be operated. One valve is located inside the front service compartment. The other valve is located inside the engine compartment.

Both air system emergency fill valves are fitted with standard tire valve stems. The air systems can be filled using any standard external air supply line. The fill valve located in the engine compartment supplies air for all systems (brakes, suspension and accessories). The fill valve located in the front service compartment supplies air for accessories only.



**CAUTION**

Air filled through the two emergency fill valves will pass through the standard air filtering-drying system. Do not fill air at any other location. Do not exceed 120 psi (827 kPa).

## 7-12 Safety Features and Equipment

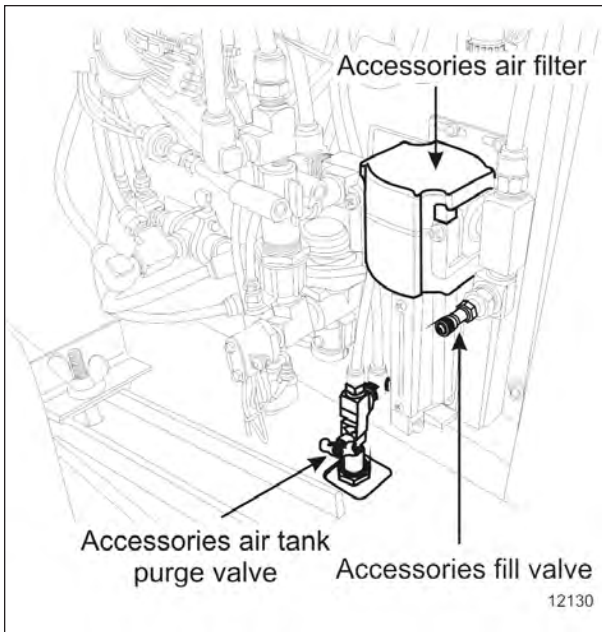


FIGURE 15: FRONT SERVICE COMPARTMENT

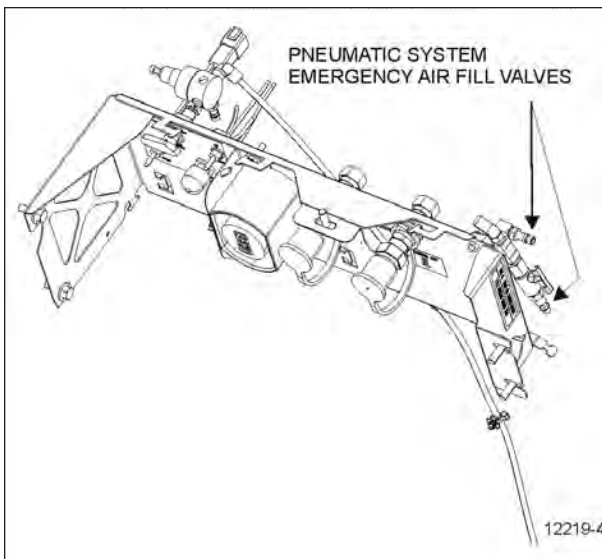


FIGURE 16: FILL FITTING IN ENGINE COMPARTMENT

### EMERGENCY AND PARKING BRAKES

During normal operation, if air pressure in any brake circuit drops below 60 psi (414 kPa), spring-loaded emergency brake will be immediately applied at full capacity to the drive axle wheels to stop the vehicle.

Spring-loaded parking brake is applied by pulling the control valve knob.

Parking brake is not designed to be used as a service brake. For normal driving conditions, the control valve knob must remain depressed.



#### WARNING

Always apply the parking brake before leaving the driver's seat.

#### NOTE

Only use the parking brake to supplement the service brake to stop the vehicle in emergency conditions. The stopping distance will be considerably longer than when using normal service brake.

#### NOTE

Before releasing the parking brake by pushing down the control valve knob, check the pressure gages to make sure that the brake system air pressure is greater than or equal to 95 psi (655 kPa).

#### NOTE

The alarm will sound if the ignition switch has been turned to OFF without applying the parking brake. The same beep will sound if pressure is still applied to the service brake pedal.

#### NOTE

The stop lights automatically turn on when the parking brake is applied and the engine is running.

### VEHICLE JACKING POINTS

For detailed instructions, refer to Maintenance information [MI18-18](#), available on the technical publications website.

### HYDRAULIC JACK

**To raise:** turn release valve clockwise. Insert handle in socket and raise vehicle by pumping.

**To lower:** remove handle and turn the release valve slowly counterclockwise.



Always keep ram and extension screw retracted when jack is not in use.

**Service:** Check oil level when jack fails to raise to full height. Lower ram completely with release valve open and jack in upright position, remove filler plug and refill to level of filler hole with hydraulic jack oil. Never use brake fluid.



### DANGER

Jack is intended for lifting only. Do not get under the vehicle or load for any reason unless it is properly supported with safety stands and securely blocked.



### DANGER

Do not overload jack above rated capacity. Prevent "side loading", make sure load is centered on ram. Do not push or tilt load off jack.

## TOWING THE VEHICLE

For detailed instructions, refer to Maintenance information [MI18-18](#), available on the technical publications website.

## DAYTIME RUNNING LIGHTS

The daytime running lights system provides added safety by making the front of the vehicle more visible to other drivers during the day.

The daytime running lights system turns the headlights on when:

- Engine is running;
- Parking brake is released;
- The exterior lighting switch is set to the OFF position or pressed to the first position.



### WARNING

At night, do not drive using the daytime running lights. When in use, the tail and rear marker lights are not turned on.

For night driving, turn the headlights lighting rocker switch to the second position.

## FOG LIGHTS

Optional halogen fog lights are available. They provide better visibility in fog and precipitation. They improve visibility immediately in front of the vehicle. They also provide added safety.

### NOTE

*Some states or provinces may restrict the use of fog lights. Verify local state or provincial regulations before using.*

## PERIMETER LIGHTS

The vehicle may be equipped with perimeter lights installed at the edge of the roof. These lights increase pedestrian safety when cornering at low speed as well as when boarding and disembarking passengers.

These lights turn on automatically under one of the following conditions:

1. The transmission is put in reverse.
2. The front door is open and the headlight switch is in the first position.
3. The parking brake is applied, the ignition is in the ON position and the headlight switch is in the first position.
4. The left or right turn signals are activated and the vehicle's speed is less than 12 mph (20 km/h).

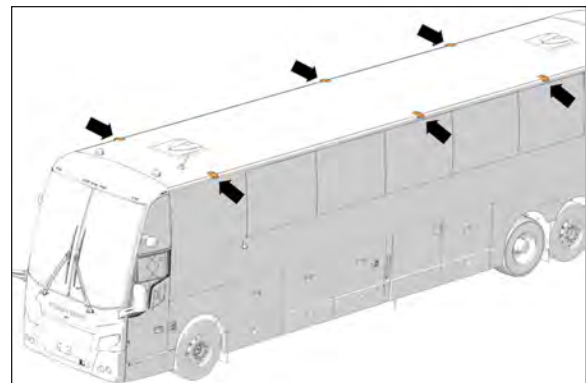


FIGURE 17: PERIMETER LIGHTS

## 7-14 Safety Features and Equipment

### COMPARTMENT LIGHTING

Baggage compartments and the service compartment lights are automatically turned on when the corresponding compartment door is opened.

### MUD FLAPS AND SPLASH GUARDS

Mud flaps are installed behind each front wheel and the tag axles. Mud flaps minimize dirt on the lower panels of the vehicle and prevent stones and debris from being thrown at vehicles traveling behind the vehicle.

Splash guards may be installed behind each dual wheel of the drive axle to prevent stone projectiles from being thrown at the tag axle wheels.

### BACK-UP CAMERA

An optional back-up camera is available which provides the driver with visual assistance when backing-up. The monitor switches on automatically when the transmission is in the reverse (R) range.

### BACK-UP ALARM

The back-up alarm alerts pedestrians and other drivers when the vehicle is being backed-up. Take extra precautions whenever backing-up. If necessary, use a guide to provide directions when backing-up. The back-up alarm is automatically activated when the transmission is put into reverse gear (R).

### ESSENTIAL FUNCTIONS TO OPERATE THE VEHICLE (BASIC LIMP-HOME FUNCTIONS)

Even with a defective CECM (Chassis Electronic Control Module) or a CAN network problem, essential base functions are maintained to rear start the vehicle from the engine compartment and drive in a secure manner.

### AVAILABLE FUNCTIONS

- Startup: Turn on the ignition in the driver's area and rear start the vehicle from the engine compartment,
- Headlights: Low beams only,
- Stoplights: 2 upper stoplights + high-mounted stoplight are functional,
- Opening the door: Functions normally,
- Closing the door: Manually pull on the door and it will lock automatically,
- Windshield wipers: Wipers functions at 1st speed only
- Directional signals: Rear and front only,
- HVAC: Functional with a set point fixed at 70°F (22°C), evaporator and condenser fixed at speed 1, defroster fixed at speed 4.



#### CAUTION

The following directives must be followed.

- Never connect a battery charger when the ignition is at the ON position on a vehicle with a defective CAN or certain functions will start up by themselves,
- Disconnect the charger before starting the vehicle, if not the default functions will not activate,
- If the default mode does not activate, try to turn the ignition OFF while ensuring that no charger is connected and then restart the vehicle.

## SECTION 8 - CARE AND MAINTENANCE

|  |           |
|--|-----------|
| <b>CLEANING</b> .....                                  | <b>3</b>  |
| SEAT UPHOLSTERY .....                                  | 3         |
| PLASTIC AND VINYL .....                                | 4         |
| WINDOWS .....  | 4         |
| STAINLESS STEEL .....                                  | 4         |
| HIGH PRESSURE LAMINATE .....                           | 4         |
| CARPET .....   | 4         |
| RUBBER COMPONENTS .....                                | 4         |
| FLOOR CLEANING .....                                   | 4         |
| EXTERIOR SURFACES .....                                | 5         |
| WINDSHIELD .....                                       | 5         |
| WIPER BLADES .....                                     | 5         |
| <b>LAVATORY MAINTENANCE</b> .....                      | <b>5</b>  |
| FILLING THE SUMP TANK .....                            | 5         |
| DRAINING THE SUMP TANK .....                           | 6         |
| <b>FLUID LEVEL VERIFICATION</b> .....                  | <b>6</b>  |
| ENGINE OIL LEVEL .....                                 | 6         |
| TRANSMISSION FLUID LEVEL .....                         | 7         |
| POWER STEERING FLUID LEVEL .....                       | 9         |
| DRIVE AXLE WHEEL BEARING OIL LEVEL .....               | 9         |
| FRONT AND TAG AXLE WHEEL HUBS .....                    | 9         |
| COOLANT FLUID LEVEL .....                              | 9         |
| WINDSHIELD WASHER & HEADLIGHTS WASHER RESERVOIRS ..... | 11        |
| <b>OTHER VERIFICATION</b> .....                        | <b>11</b> |
| ELECTRIC COOLING FANS .....                            | 11        |
| AIR TANK PURGE .....                                   | 12        |
| FIRE EXTINGUISHERS .....                               | 12        |
| PRIMARY FUEL FILTER .....                              | 12        |
| DRIVER'S A/C COMPRESSOR BELT .....                     | 13        |
| CENTRAL A/C COMPRESSOR BELTS .....                     | 13        |
| ALTERNATOR DRIVE BELTS .....                           | 14        |
| BACK-UP CAMERA .....                                   | 14        |
| ENGINE AIR FILTER RESTRICTION INDICATOR .....          | 14        |
| A/C AND HEATING SYSTEM AIR FILTERS .....               | 14        |
| HOSE INSPECTION .....                                  | 16        |
| LUBRICATION .....                                      | 16        |
| WHEELS AND TIRES VERIFICATIONS .....                   | 16        |
| WHEEL BEARINGS .....                                   | 17        |

## 8-2 Care and Maintenance

---

|  |           |
|--|-----------|
| SERVICE BRAKE TEST .....                               | 17        |
| PARKING BRAKE TEST .....                               | 17        |
| EXTERIOR LIGHTING VERIFICATION WITH TEST MODE .....    | 18        |
| <b>GENERAL RECOMMENDATIONS .....</b>                   | <b>21</b> |
| <b>WALKAROUND INSPECTION (BEFORE EVERY TRIP) .....</b> | <b>25</b> |
| APPROACHING THE VEHICLE .....                          | 26        |
| PREPARATION .....                                      | 26        |
| STEP 1: RIGHT SIDE .....                               | 26        |
| STEP 2: ENGINE COMPARTMENT RIGHT SIDE AREA .....       | 26        |
| STEP 3: ENGINE COMPARTMENT .....                       | 26        |
| STEP 4: REAR LEFT SIDE .....                           | 26        |
| STEP 5: FRONT LEFT SIDE .....                          | 27        |
| STEP 6: FRONT .....                                    | 27        |
| STEP 7: FRONT RIGHT SIDE .....                         | 27        |
| STEP 8: INSIDE THE VEHICLE .....                       | 27        |
| WITH ENGINE RUNNING .....                              | 27        |

## CLEANING

The cleaning information provided in this section is regarded as recommended cleaning practices. Cleaning results may vary depending on the condition of the stain. Always clean stains promptly for the best results.

### NOTE

*Use only approved cleaning products such as Prevost A.P.C., all-purpose cleaner (Prevost # 683664). Never use stain protection products on new fabrics. To prevent permanent staining of fabrics, clean stains soon after they occur. Incorrect treatment of stains can worsen them. Get help from a cleaning specialist to remove stubborn stains.*



### CAUTION

Custom fabrics and materials may require different cleaning and maintenance practices. Consult your supplier.

## SEAT UPHOLSTERY

Firmly beat the fabric with a blunt object, such as a wooden paddle, to release dust and dirt. Vacuum the seat fabric in the direction of the stitching using an upholstery nozzle.

### NOTE

*The abrasive nature of dirt and grit will reduce upholstery life expectancy. Vacuum regularly.*

### Removal Of Stains And Marks

Depending on the nature of the stain, apply one of the two methods explained below to remove stains and marks on wool plush.

#### Method One:

Apply a nonflammable solvent to stained area with a clean, white absorbent rag;

Clean stain by starting at the outer edges of the stain and working in toward the center;

Blot affected area frequently with a clean, dry absorbent cloth to prevent stain rings caused by excess solvent.



### WARNING

Use solvents in a well-ventilated area. Open all windows and doors.

#### Method Two:

Wet the stain with a solution of household detergent and lukewarm water. Do not soak the stain;

Rub the stain with a damp cloth;

Rinse cloth after each application.



### CAUTION

Do not use soap, soap powder, ammonia, soda, bleach or cleaning products containing any of these compounds.

### Beverage Stains

Remove beverage stains by following method one. If stain persists, repeat method one using methylated spirits instead of solvent.

### Alcoholic Beverage Stains

Remove alcoholic beverage stains by wetting the stain with water, then cleaning following method two.

### Burns

Scrape burnt area using a knife or razor blade then clean following method two. Consult an upholstery specialist when dealing with extensive burns.

### Cosmetic Stains

Remove stains left by cosmetics by following method one then, method two.

### Ink Stains

Remove ink stains following method two. If stain persists, apply a warm oxalic acid solution. Rinse with water.

### Blood, Urine Or Vomit Stains

Remove such stains by following method two.

### Copying Ink - Ball-Point Pen Ink

Treat with methylated spirits, blotting frequently to avoid spreading stain, followed by method two.

## 8-4 Care and Maintenance

### Marking Ink (Felt-tip Pens)

Treat with Methyl Ethyl Ketone (MEK) followed by method two.

### Oil, Grease And Paint

Remove excess using a knife. Treat with method one followed by method two. If stain persists, repeat procedure.

### Rust Stains

Remove rust stains by following method two. Apply a warm oxalic acid solution to stained area. Rinse with water.

### Tar

Soften tar with mineral spirits, then treat using method one followed by method two.

### Chewing Gum

Soften gum with cyclohexane. Carefully scrape off stains using a sharp knife or razor blade.

### PLASTIC AND VINYL

Clean plastic and vinyl trim using a clean damp cloth or sponge. For vinyl trim marks, use a lukewarm all-purpose cleaner or a mild saddle soap. Remove water spots and soap traces using a clean damp cloth or sponge. Dry with a clean soft cloth.

Remove grease, tar or oil stains with a clean cloth or sponge and an all-purpose or solvent-type vinyl cleaner.

Apply a colorless vinyl or leather protective product to maintain the luster and pliability of the plastic or vinyl surface.

### WINDOWS

Clean the inside of the windows with a solution of one part vinegar to ten parts water.

### STAINLESS STEEL

Use a stainless steel cleaner and follow the manufacturer's instructions. Stainless steel cleaning solution may be ordered from Prevest quoting part number 680356.

### HIGH PRESSURE LAMINATE

Remove stains on laminated surfaces (Formica) with a household detergent, methylated spirits or mineral spirits. Clean with a mild liquid abrasive and water solution if stain persists.

### CARPET

Vacuum carpets regularly to prolong carpet life.

### RUBBER COMPONENTS

Use only pure water or glycerin to clean stains on rubber components.



#### CAUTION

Never use solvents on rubber components.

### FLOOR CLEANING

To keep its original appearance, wash the floor regularly. Clean vinyl floors with a quality nonionic detergent cleaner or a household all-purpose cleaner. Follow the manufacturer's recommendations for cleaning.

Remove any excess detergent solution using a wet/dry vacuum or mop. Rinse floor with a solution of one part Clorox to ten parts warm water.

Polish dry floor using a high-speed buffer and a smooth red 3-M polishing pad.

Mop floor periodically with a solution of 5 percent Clorox in warm water.

#### NOTE

*For custom or special floor covering materials, consult the manufacturer or your converter for information on how to clean and maintain these types of floors.*



#### CAUTION

Using a water hose to clean the floor is prohibited since it could cause electrical shorts or damage the electrical system.

## EXTERIOR SURFACES

Frequent washing and waxing of the vehicle exterior will help protect the finish and luster. The paint finish is attacked by the abrasive effects of airborne particles and corrosive pollutants.

Before washing the exterior of the vehicle, close the fresh air dampers using the “REC” button located on HVAC control panel and on the air intake duct in the evaporator compartment. Install keyhole protectors to prevent water from penetrating. Rinse vehicle with water to remove all loose dirt. Wash vehicle using quality brand car wash soap. Follow manufacturer's recommendations for cleaning. Rinse well with water.

The vehicle exterior should be cleaned, waxed and buffed when water droplets no longer form on the painted surfaces.



### CAUTION

Hot water can damage paint. Keep water cool or lukewarm.



### CAUTION

Make sure cleaning solutions are not harmful to painted surfaces. Read the manufacturer's instructions before using.



### CAUTION

Do not spray water jet directly into fresh air inlet dampers.



### CAUTION

Do not aim high-pressure water jet at radiator or condenser doors. This could damage the fins.

To prevent corrosion, remove caked-on dirt and road salt from the vehicle underbody using a high-pressure water jet. Clean wheel housings, bumpers, muffler, tailpipe and brackets.

Carry out corrosion prevention cleaning at least twice a year. Spray underneath of the vehicle and let soak before cleaning. Let engine and exhaust system cool down before cleaning.

## Tar Or Oil

Remove tar or oil as soon as possible with an approved automotive tar and oil remover or

turpentine. Thoroughly clean area with car wash soap and water. Let dry, then wax.

## Insects

Remove insect stains as soon as possible with lukewarm soap and water or insect remover.

## Tree Sap

Remove tree sap or bird droppings with lukewarm soap and water. Do not allow to harden.

## WINDSHIELD

To prevent windshield wiper streaking, keep silicone sprays away from windshield. Remove road film and wax build-up from windows with lukewarm soap and water or with an alcohol-based cleaning agent. If a chamois is used to dry and polish glass, use it exclusively for that purpose.

## WIPER BLADES

To avoid tearing frozen wiper blades, loosen them before removing. Remove and clean wiper blades periodically with an alcohol-based cleaning solution. Clean wiper blades using a sponge or soft cloth.

## LAVATORY MAINTENANCE

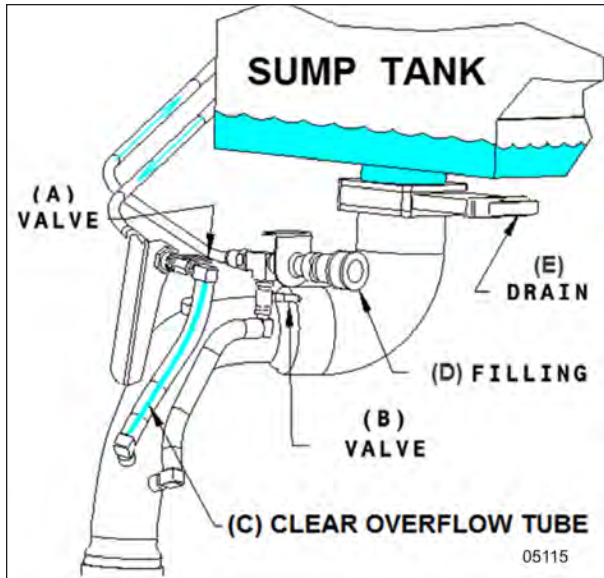
Flush water in the lavatory is recirculated from the sump tank. When the sump tank water is too soiled to be recirculated, the driver can dump it into a suitable dump location.

Routine draining and filling of lavatory tanks should be performed by maintenance personnel only, and should be done before parking the coach overnight in freezing temperature.

## FILLING THE SUMP TANK

Open the sump tank overflow valve (A) and connect a fresh water supply hose to the toilet sump tank fill connection (D). The sump tank is full when water starts flowing through the clear fill process overflow tube (C). Close sump tank overflow valve (A) when the tank is full and drain fresh water fill tube using drain valve (B) to avoid ice damage during cold weather operation.

## 8-6 Care and Maintenance



### DRAINING THE SUMP TANK

When recirculating water in the toilet is soiled, drain sump tank. Pull the drain slide valve handle (e) and allow contents to drain. Flush tank with clean water. To close, push the slide valve (e) back into closed position.

#### CAUTION

Lavatory tanks should be serviced only at suitably equipped stations.

#### NOTE

*It is unlawful to dump sump tank contents in any location other than those designated as such.*

When a thorough tank draining is required, clean sump tank by repeating the draining and filling operations several times. Close valves and drop in a packet of commercial toilet deodorant (Prevost part #900329) in toilet before starting final filling of the sump tank.

#### WARNING

The toilet deodorant contains compounds which can be very irritating to skin. Use rubber gloves when handling and then clean toilet seat.

#### CAUTION

When cold weather is expected, sump tank must be drained if the coach is parked overnight or for an extended period of time.

#### NOTE

*Due to the heat it produces, there is less risk of freezing in the tanks when the engine is operating.*

#### NOTE

*New coaches are delivered with the sump tank empty. Fill with water before putting the coach in service.*

## FLUID LEVEL VERIFICATION

Periodic inspection of oil and fluid levels is the most economical and easiest way to help your vehicle perform at its best. Rigorous oil level inspection and replacement will greatly help minimize expensive and unscheduled repairs.

### ENGINE OIL LEVEL

#### WARNING

Check the engine oil level with vehicle parked on a level surface and with the parking brake engaged.

Check engine oil level when engine is still warm. Shut off engine and wait at least 10 minutes for oil to drain into oil pan before checking. Check engine oil level daily or before each trip. Add oil as required. Do not overfill. Remove dipstick, wipe clean and fully reinsert to ensure an accurate reading. Remove dipstick and check engine oil level.

**Do not** let the oil level fall below the marking on the dipstick. **Do not** overfill so the level is above the upper marking on the dipstick. Add oil through the oil filler pipe as required in order to maintain level within the safe range.



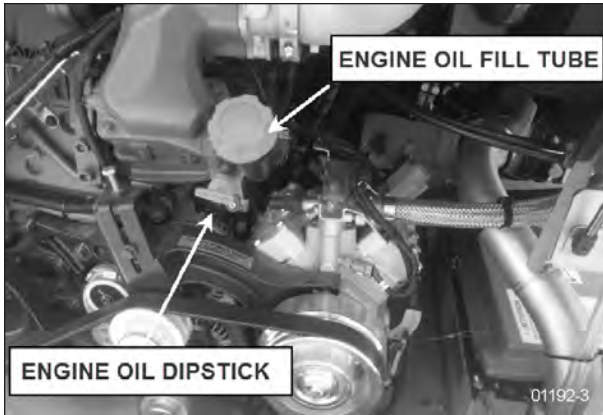


FIGURE 1: ENGINE OIL DIPSTICK - VOLVO D13 ENGINE

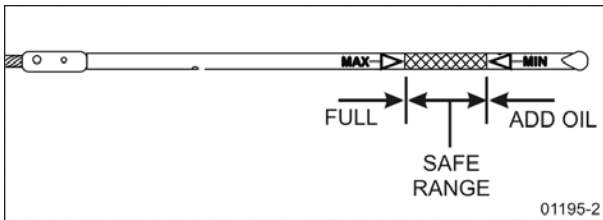




FIGURE 2: VOLVO D13 ENGINE OIL LEVEL DIPSTICK


## TRANSMISSION FLUID LEVEL

 **DANGER**

To prevent personal injury, do not service transmission wearing loose clothing. Stand clear of the engine and rotating components while checking the oil level.

 **CAUTION**

Do not mix fluid types or brands because of possible incompatibility.

 **CAUTION**

Use clean fluid and containers when filling transmission. Never use containers that have contained water or antifreeze (Glycol).

### Allison Automatic Transmission Fluid Level

The transmission fluid level can be checked with the dipstick or with the use of the shift selector display. For more information on how to use the shift selector display to check the transmission oil level, refer to the Allison transmission Appendix .

The transmission fluid level dipstick is accessible through the engine compartment rear door and is located on the left side of the engine.

To check the transmission fluid level, a "cold check" and a "hot check" must be performed. A cold check must be made when the transmission fluid is between 60°F and 120°F (16°C and 50°C).

#### NOTE

*Perform the cold check first to verify the transmission fluid level before performing the hot check.*

To prevent dirt and foreign matter from entering the transmission, clean the end of the oil fill tube before removing dipstick. To remove dipstick, unscrew filler cap approximately three turns and pull out dipstick.



FIGURE 3: ENGINE L. H. SIDE (X3 SERIES)

#### • Cold Check

Run the engine until the transmission fluid temperature is between 60°F and 120°F (16°C and 50°C). With the engine idling, make sure the parking brake is applied and the transmission is in neutral (N). Shift transmission from forward (D) to reverse (R) and back into neutral (N) to fill clutch cavities with fluid. Remove and wipe the dipstick with a clean cloth. Check fluid level. If the fluid level is within the COLD RUN band, the fluid level is correct and a hot check can be performed. If the fluid level is on or below the lower line of the COLD RUN band, add fluid until the level lies within the COLD RUN band. If the fluid level is above the COLD RUN band, drain fluid until the level is within the band.

## 8-8 Care and Maintenance

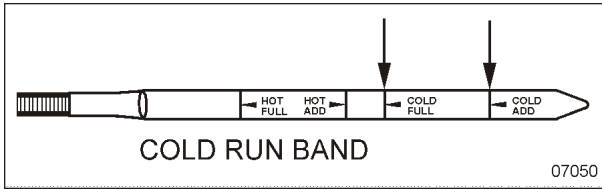


FIGURE 4: TRANSMISSION FLUID LEVEL DIPSTICK (TYPICAL)



### CAUTION

The fluid level rises as fluid temperature rises. Do not add fluid above the "cold run" band before the transmission reaches 180°F to 220°F (82°C to 104°C).

#### • Hot Check

Make sure the transmission fluid temperature is between 160°F and 200°F (71°C and 93°C) before performing the hot check. With the engine idling between 500 and 800 RPM and the parking brake applied, shift transmission into neutral (N). Remove and clean dipstick, then check fluid level. If the fluid level is on or under the lower HOT RUN line, add just enough fluid to bring up the level to the middle of the HOT RUN band.

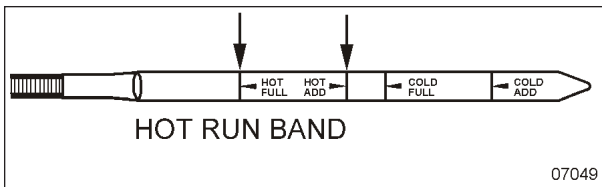


FIGURE 5: TRANSMISSION FLUID LEVEL DIPSTICK (TYPICAL)

Replace dipstick and tighten the filler tube cap until the rubber seal is correctly seated.



### CAUTION

Do not overfill transmission fluid reservoir. Severe damage may result.

### I-Shift Transmission Fluid Level

Check the transmission fluid level at each service interval. Park the vehicle on a level surface. Check the fluid level through the sight glass on the side of the transmission. Add fluid as necessary. Only use VOLVO-approved synthetic transmission fluid in the I-Shift transmission. Refer to section 24 of the Maintenance Manual for more information about oils approved by Volvo;

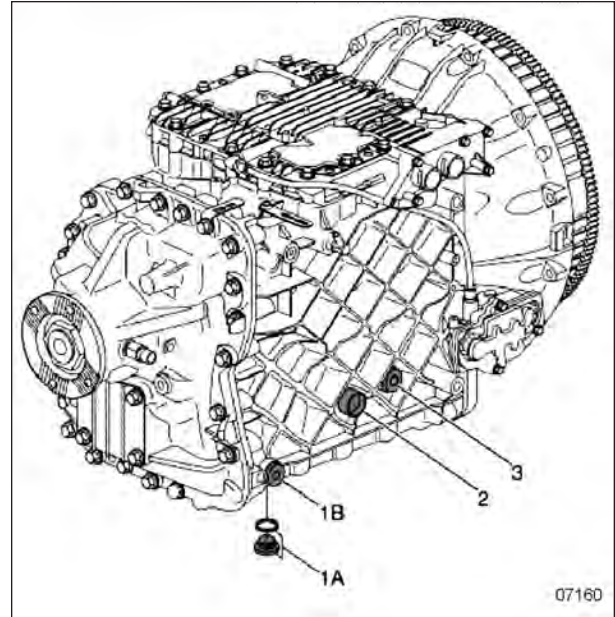


FIGURE 6: I-SHIFT TRANSMISSION FLUID CHANGE

- Vehicle should be on horizontal ground when fluid is changed;
- Do not check fluid level straight after a journey (incorrect measurement). Undertake the check once the transmission fluid has cooled down (lower than 104°F or 40 °C);
- Check fluid level using transmission sight glass (2);

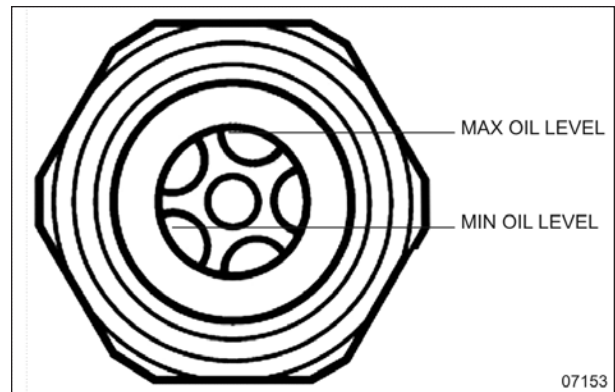


FIGURE 7: SIGHT GLASS FOR CHECKING OIL LEVEL

- Add fluid through the oil filling point if necessary (3);
- Torque tighten fill plug to 26±4 lb-ft (35±5 Nm).

## POWER STEERING FLUID LEVEL

The power steering reservoir is located on the R.H. side of the engine compartment.

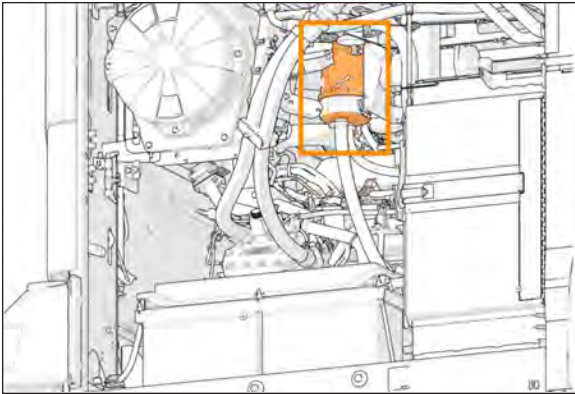


FIGURE 8: POWER STEERING RESERVOIR

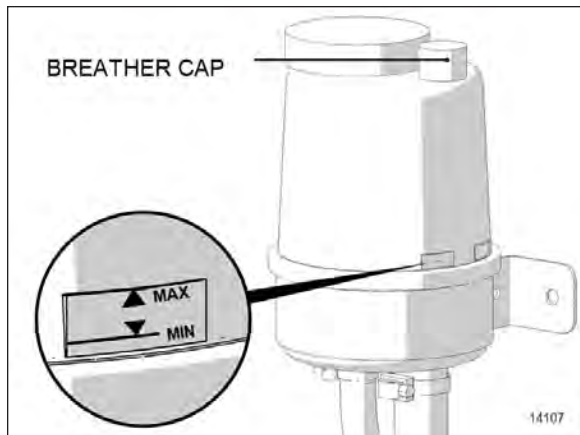


FIGURE 9: POWER STEERING FLUID TANK

Check fluid level as follows:

1. Stop engine;
2. Open compartment door;
3. Thoroughly clean the reservoir and its immediate vicinity to protect the fluid from being soiled by impurities;
4. Check fluid level through the clear bowl and compare with the MIN & MAX marking affixed on the bowl;
5. Remove the breather cap and top up level to "MAX" mark;
6. Reinstall the breather cap.

## DRIVE AXLE WHEEL BEARING OIL LEVEL

Drive axle wheel bearings are lubricated by the differential oil. Maintain differential oil at correct level to ensure adequate lubrication of drive axle wheel bearings at all times.

## FRONT AND TAG AXLE WHEEL HUBS

The unitized hub bearings used on the NDS range of axles are non-serviceable items. Bearings are pre-adjusted, lubricated and have seals fitted as part of the manufacturing process. The bearings are greased for life and there is no need or facility for re-lubrication.

## COOLANT FLUID LEVEL

The cooling system has two tanks; the surge tank (A) and the recovery tank (B).

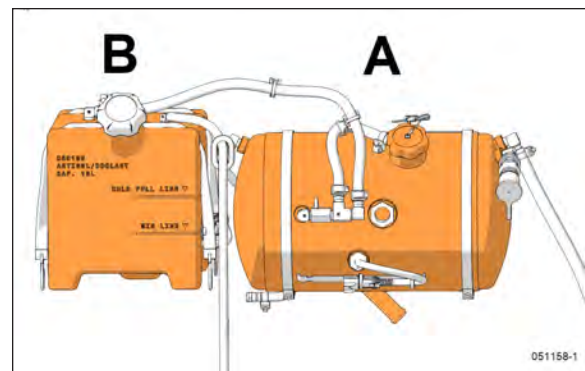


FIGURE 10: SURGE TANK (A) AND THE RECOVERY TANK (B)

Checking of the coolant level is done with the recovery tank (B), when the engine is cold (ambient temperature).

- If the coolant level into the recovery tank is lower than MIN LINE, use the recovery tank filler cap to add coolant up to FULL LINE.

## 8-10 Care and Maintenance



**FIGURE 11: RECOVERY TANK**

Fill the recovery tank with the same 50/50 water-antifreeze mixture already in the cooling system. Do not mix two different types of coolant. Refer to the Maintenance Manual for proper coolant type specifications or see the label affixed near the coolant surge tank on the vehicle.

### Coolant Level Switch

Both tanks are equipped with a coolant level switch. A message appears on the cluster according to which switch is activated.

The table below shows the message and the description.

| MESSAGE                                 | DESCRIPTION   |
|---|---|
| Check Engine Coolant Level at next stop | Low engine coolant level<br>Warns the driver that the engine coolant level has reached the recovery tank low level switch. Add coolant whenever possible. Use recovery tank filler cap. |
| Engine Coolant Level critically Low     | Critically low coolant level<br>Warns the driver that the engine coolant level has reached the surge tank low level switch. Stop and add coolant. Use recovery tank filler cap.         |

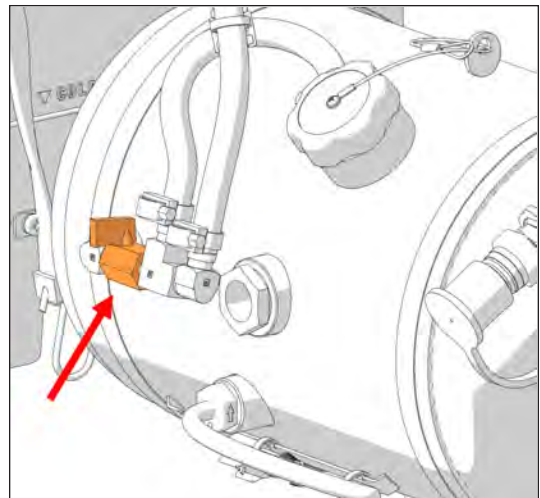
Level reading from the level switches does not match with the level lines on the recovery tank.

|                           |  |
|---------------------------|--|
| <b>Green light</b>        |  |
| <b>Flashing red light</b> |  |
| <b>Solid red light</b>    |  |



### WARNING

Allow engine to cool down before adding coolant. There is no pressure into the recovery tank. If necessary, use the valve attached to the surge tank to release the pressure into the surge tank and the cooling system. Close the valve after releasing the pressure.



### WINDSHIELD WASHER & HEADLIGHTS WASHER RESERVOIRS

The windshield washer reservoir and headlights washer reservoir are located in the front service compartment door. The windshield washer reservoir has a capacity of 5.3 US gallons (20 liters) while the headlights washer reservoir has a capacity of 2.6 US gallons (10 liters). Check fluid level regularly.

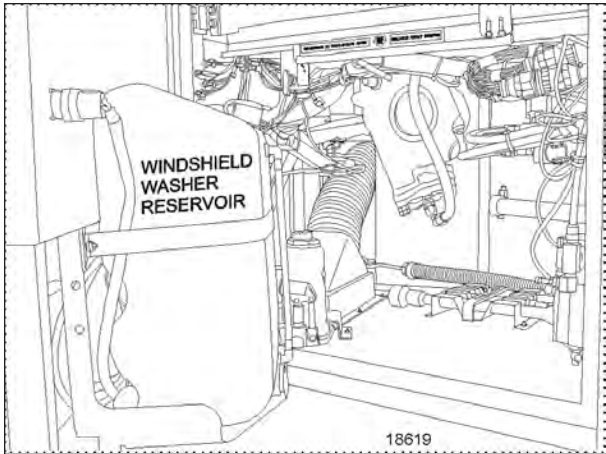


FIGURE 12: WINDSHIELD WASHER RESERVOIR

The windshield spray jets are located on the windshield wipers and are angled to spray towards the center of the windshield.

Adjust the headlights washer nozzles according to the instructions found in section 23 of the maintenance manual. You may use water or windshield washer fluid as well.

|  |                |
|--|----------------|
|  | <b>CAUTION</b> |
| During cold weather days, use windshield washer fluid suitable for freezing temperature. |                |

### OTHER VERIFICATION

It is good practice to regularly inspect the vehicle for signs of component wear and to perform safety and maintenance routines.

### ELECTRIC COOLING FANS

Inspect fan blades regularly, check for dirt or grime accumulations on the blade that could cause vibrations, clean as necessary using water and regular strength degreaser:

Check for cracks and signs of abrasion on the blades that could indicate contact with debris or obstruction during operation;

Check the bottom of the shroud cover and remove debris that could have accumulated. In sub-zero winter area, also check for snow and ice accumulation that could block the fan blades rotation;

Open the fan shroud as necessary (remove top and bottom hex screws) to facilitate cleaning and debris removal;

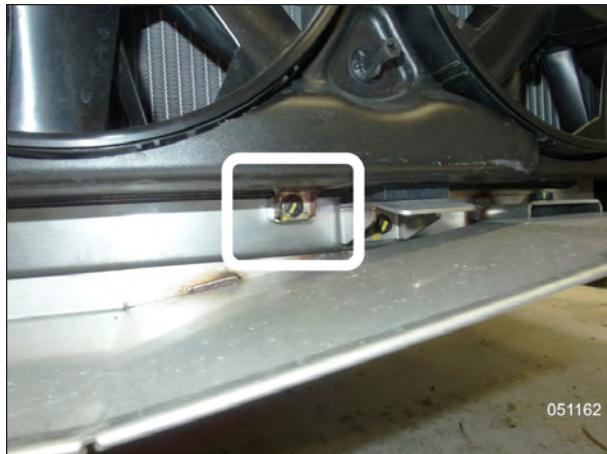


FIGURE 13: FAN SHROUD TOP & BOTTOM HOLD-DOWN SCREWS

|  |
|--|
| <b>NOTE</b>  |
| <i>Electric cooling fan motors are sealed and certified IP6K9K and IP68. They can therefore be safely power/pressure washed.</i> |

## 8-12 Care and Maintenance

### AIR TANK PURGE

The vehicle is equipped with several air tanks. Purge the accessory air tank before each trip. The accessory air tank drain cock is accessible from the front service compartment.

The wet, primary, secondary and optional air tanks must be purged at every oil change or at least every 12,500 miles (20 000 km). They are equipped with a drain cock underneath the tank. Drain tanks by turning cocks counterclockwise.

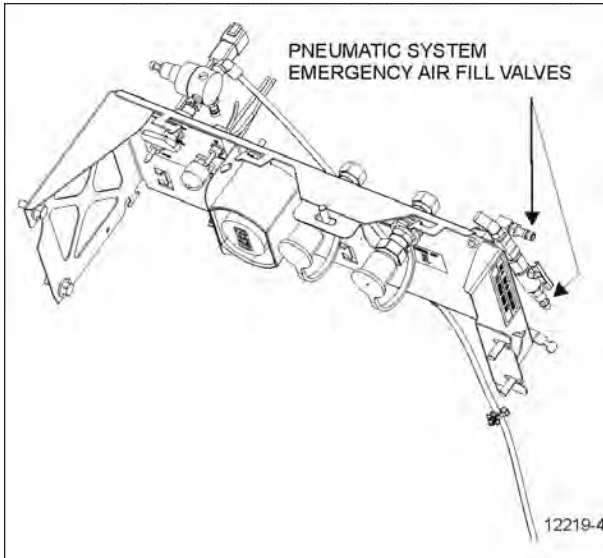


FIGURE 14: AIR FILL VALVES

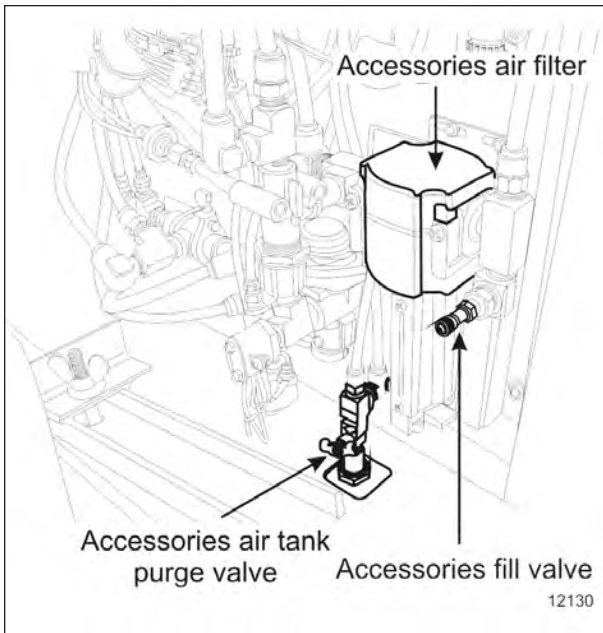


FIGURE 15: FRONT SERVICE COMPARTMENT

### FIRE EXTINGUISHERS

Inspect fire extinguishers monthly to ensure operation in emergency situations.

On extinguishers with a pressure gauge, the needle should be in the green or NORMAL range. Refill or replace extinguisher if pressure is below normal;

Check that seal on handle is intact;

Check that hose nozzle is in good condition and the nozzle is free of obstructions;

Keep fire extinguishers clean.

### PRIMARY FUEL FILTER

A primary fuel filter is installed on the engine. This filter may consist of a filter cartridge with a drain valve at the bottom, or a filter cartridge, a water separation bowl and may have a fuel heater built in. It is used to prevent water from entering the fuel system. The primary fuel filter should be drained periodically or when the telltale light on the dashboard illuminates if equipped with this system. To drain water, loosen the drain valve below the separator. Close the drain valve when finished.

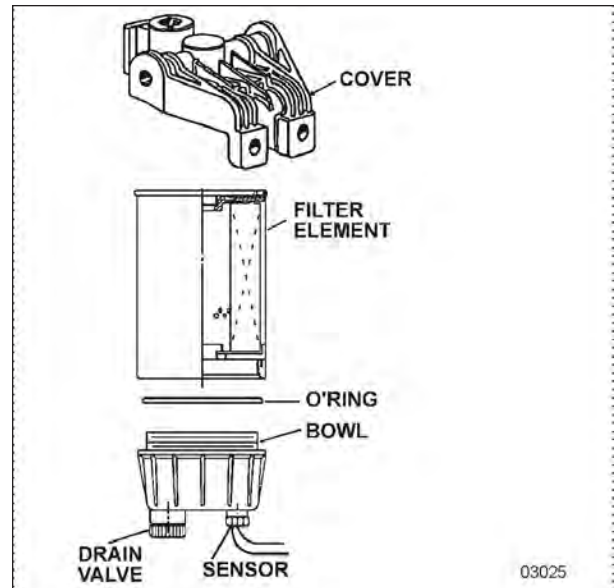
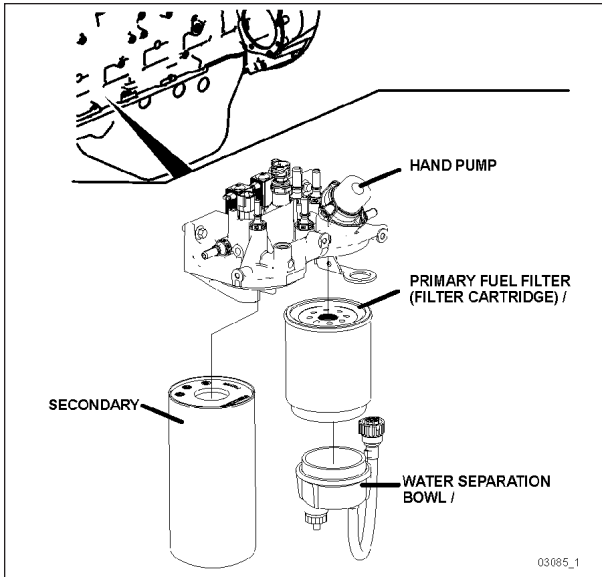
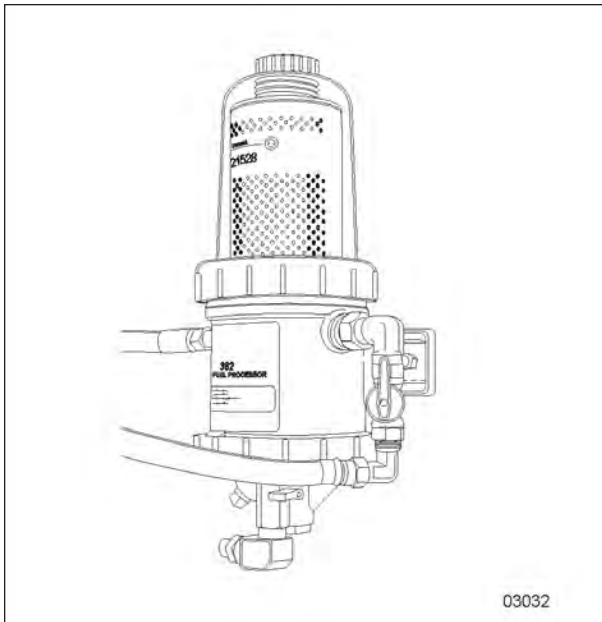


FIGURE 16: FUEL FILTER/WATER SEPARATOR



**FIGURE 17: FUEL FILTERS WITH VOLVO D13 ENGINE**

The optional Fuel Pro diesel fuel filter system consists of a permanently mounted fuel processor, a replaceable filter element, a filter element cover and collar and a fluid filter base assembly. This system is installed between the fuel tank and the fuel pump and replaces the primary fuel filter. The filter serves as a water separator as well as a fuel filter. To drain water, loosen the drain valve below the separator one quarter turn. Close the drain valve when finished.

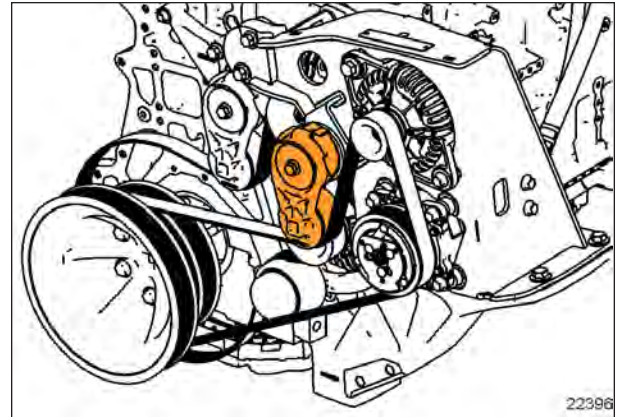


**FIGURE 18: DAVCO FUEL PRO INSTALLATION**

### DRIVER'S A/C COMPRESSOR BELT

For vehicles equipped with driver's A/C, the air conditioning compressor is driven by a multi-V-belt.

Belt tension is achieved by an automatic belt tensioner. No adjustment is required.

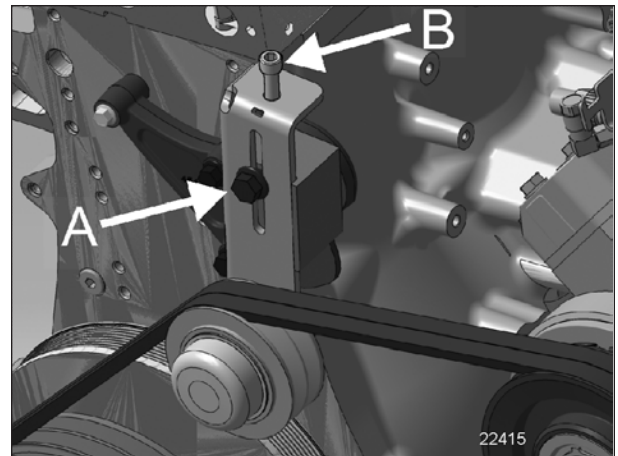


**FIGURE 19: BELT TENSIONER**

- Do not treat belts with any compounds. Keep belts dry.
- Periodically inspect belt and pulleys for wear or damage;

### CENTRAL A/C COMPRESSOR BELTS

The air conditioning compressor is driven by two V-belts.



**FIGURE 20: BELT TENSIONER**

Belt tensioning is applied through the tensioner adjustment screw B. Loosen lock bolt A prior adjustment. Tighten lock bolt A to 43 lbf-ft once completed.

## 8-14 Care and Maintenance

Belt tension should be within the following values:

- New belts: 90-100 lbs.
- Used belts: 75-85 lbs.

Check belt tension using a belt strand tension gauge.

- Once adjustment completed, allow the engine to run for about ten minutes. Check belt tension and adjust if needed.
- Do not treat belts with any compounds. Keep belts dry.
- Periodically inspect belt and pulleys for wear or damage;

### ALTERNATOR DRIVE BELTS

Automatic belt tensioners keep the correct tension so these belts do not require adjustment.

### BACK-UP CAMERA

The optional back-up camera is located on the rear cap. As soon as the transmission is put in reverse (R), back-up camera and monitor are turned on automatically. To clean the camera's protective glass, spray with soapy water. Wipe with a clean damp rag or wiper blade.



#### WARNING

To avoid injury, do not clean camera with transmission in reverse (R). Shut off engine and apply parking brake before cleaning.



#### CAUTION

To prevent scratches to the camera protective glass, do not wipe with dry rag. Use a clean damp rag.

### ENGINE AIR FILTER RESTRICTION INDICATOR

An air filter restriction indicator is used to monitor the vacuum level between the air filter and the turbocharger inlet. A red marker is displayed when the air filter is clogged. Replace the air filter when a red marker is displayed or after a

maximum of two years. Reset by pressing on the indicator's extremity.

The air filter restriction indicator is located on the engine air intake duct.

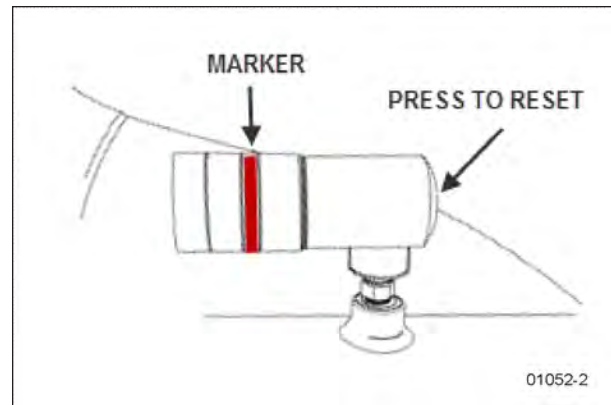


FIGURE 21: AIR FILTER RESTRICTION INDICATOR

### A/C AND HEATING SYSTEM AIR FILTERS

For maximum air conditioning and heating system efficiency, air filters should be inspected and cleaned as required in maintenance schedule to ensure proper ventilation of the evaporator and heating radiator cores.

To clean filters, remove lint using a nylon brush, back flush with water, then dry with air.



#### CAUTION

Do not use high pressure water jet to avoid damaging filter.



#### CAUTION

Be sure not to reverse filter upon installation.

### Driver's Area Air Filter

The driver HVAC system's air filter is located behind the dashboard R.H. side and it can be removed for cleaning or replacement. To gain access to the A/C filter, unscrew the grill located at the top step of the entrance door steps, remove the plastic cover holding the filter and slide out the air filter.

#### NOTE

*If the windshield is continuously fogged, check that the driver's air filter is not clogged*



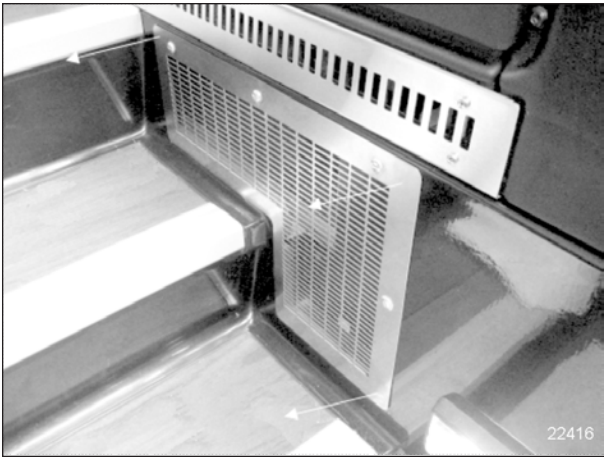


FIGURE 22: DRIVER'S AREA AIR FILTER GRILL REMOVAL



FIGURE 23: REMOVING DRIVER'S SECTION AIR FILTER

### Cabin Area Air Filter

The central HVAC system's air filters are located in the evaporator compartment on driver's side of the vehicle. To access open the evaporator compartment. An access panel labeled "AIR FILTER" is located above the evaporator and heating coils. It is held shut by quarter-turn screws. Slide out the filters for maintenance purposes.



FIGURE 24: CABIN AREA AIR FILTER

|   |                |
|---|----------------|
|  | <b>CAUTION</b> |
| Be sure not to install filter in inverted position.                               |                |

### Air Filters In The Overhead Compartments

Remove, clean or replace the air filter located behind each overhead baggage compartment fan. Slide the filter in and out using the loop fixed on the side of the filter.

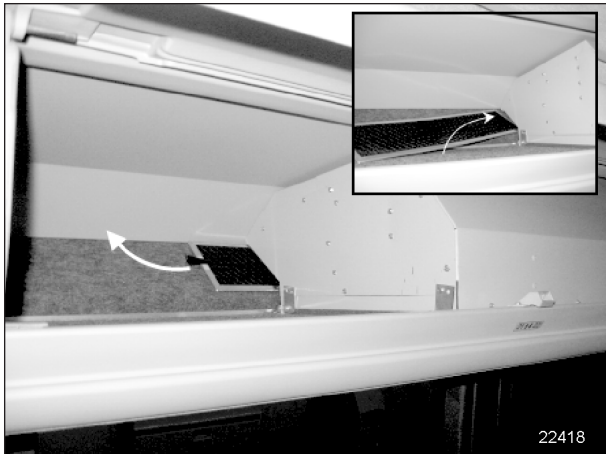


FIGURE 25: OVERHEAD COMPARTMENT FAN AIR FILTER

## 8-16 Care and Maintenance

### HOSE INSPECTION

Inspect hoses for leaks regularly to ensure efficient, economical and safe operation of the engine and related equipment. Carefully inspect all fittings, clamps and ties. To prevent chafing, make sure hoses are not touching shafts, couplings, heated surfaces, sharp edges or other parts. Since hose clamps and ties can vibrate loose or fail over time, frequently inspect and tighten or replace as necessary.

Correct leaking hoses immediately. Failure to correct leaks can cause severe damage to the equipment, as well as increase operating costs due to lost fluids. Treat fuel and oil leaks as an immediate fire hazard.



#### WARNING

Personal injury and property damage may result from fire caused by leaking flammable fluids.

### Hose Service Life

Hoses have a limited service life. Thoroughly inspect hoses annually. Look for surface damage or indications of twisted, worn, crimped, cracked or leaking lines. Replace damaged hoses immediately.

Hoses should be replaced during major overhaul or after a maximum of seven service years. Be certain replacement hoses are matching the original equipment manufacturer's specifications.

### LUBRICATION

Grease all lubrication points during scheduled maintenance. For heavy loads or extended use, lubricate more often. Refer to the Maintenance Manual, section 24 for information on lubrication.

### WHEELS AND TIRES VERIFICATIONS

Check for loose wheel nuts. Inspect all types of rims for cracks. Cracks can appear in many places but typically radiate out from where a load is applied. Both aluminum alloy and steel wheel nuts should be tightened to 450 to 500 foot-pounds (610 to 680 N.m.) torque.

Keep the tires inflated to the recommended inflation pressure to prolong tire life and for safety.

#### NOTE

*For coaches, recommended tire inflation pressures are given in the "Coach Final Record", placed in the technical publications package supplied with the vehicle. The cold tire inflation pressures are on the Department of Transport certification plate located on the L.H. console besides the driver's seat. When special tires are installed by Prevost on a new vehicle, a special tire inflation chart is added next to the certification plate.*



#### WARNING

Do not exceed maximum inflation pressure. Incorrect tire pressure increases tire wear and could lead to loss of driving control because of reduced road handling. Check tire pressure regularly.



#### WARNING

If replacement tires are different from those specified on the certification plate, pressure must be adjusted following manufacturer recommendations.

- Vehicles equipped with TPMS

On vehicles equipped with the Beru Tire Pressure Monitoring System (TPMS), it is better to use the TPMS display as the primary reference to judge when tire pressure needs adjustment.

The TPMS presents pressure readings of each tire as a +/- deviation from the wanted target.

If a tire reads within +/- 3 PSI no adjustment is needed.

If a tire reads -4 PSI and below, re-inflate by the marked amount.

If a tire reads +4 PSI and above, deflate by the marked amount.

Relying on the TPMS system is better than relying on a hand gage since the TPMS is temperature compensated and remain accurate no matter if the tires are cold or hot.

Tires take up to 3 hours to get down to ambient temperature after a ride. A common mistake consists of checking pressure while the tires have not fully cooled down which leads into under-inflated tires. Relying on the TPMS eliminate this mistake.

Running tires at optimal pressure reduce tire wear, improve safety and fuel economy.

and that the emergency brakes apply (the control valve knob lifts up). Allow air pressure to reach 95 psi (655 kPa) before releasing parking brake.

Driving the vehicle while the parking brake is applied should not be possible.

### WHEEL BEARINGS

Check wheel bearing cover for overheating (especially after using the service brakes) during fuel stops by touching the wheel bearing cover.

### SERVICE BRAKE TEST

Check for correct pressure build-up. Stop engine and check pressure gauge. Pressure loss should not exceed 3 psi/min (21 kPa/min) with engine stopped and without brake pedal applied. Air loss should not exceed 7 psi/min (48 kPa/min) with engine stopped and brake pedal fully applied.

A convenient way to proceed to the service brake test is with the use of the DID Air Leakage Monitor function .

### PARKING BRAKE TEST

Release parking/emergency brake. Pump service brake pedal until air pressure drops to 65 psi (448 kPa). Make sure the warning buzzer operates

## 8-18 Care and Maintenance

---

### EXTERIOR LIGHTING VERIFICATION WITH TEST MODE

This useful function allows quick verification of the vehicle exterior lights.

#### Activating The Test Mode:

When the vehicle is stationary (parking brake applied), pull up the multi-function lever 3 times within 3 seconds to activate the test mode. This test can be done when the engine is not running, providing that the battery charge is sufficient (above 24.0 volts).

This test can be done when the engine is not running, providing that the battery charge is sufficient (above 24.0 volts).

The telltale panel alarm emits a sound each second to remind that the test mode is in progress.

#### **NOTE**

*Lighting test mode can also be initiated and stopped using the DID menu.*

#### Stopping The Test Mode:

To stop the test mode, pull up the multi-function lever once or turn the ignition OFF or remove the parking brake.

#### **NOTE**

*The test mode is useful to check the operation of the multiplex outputs and the exterior lights. It doesn't test the functionality of the commands related to the exterior lighting. For a complete testing, the directional signal commands, the headlights commands and the brake pedal have to be checked before. Once these commands tested, activate the test mode to check the exterior lighting.*

#### Using The Test Mode:

First, test the functionality of the commands related to the exterior lighting:

- Activate the right directional signal and check that the corresponding cluster telltale light illuminates.
- Activate the left directional signal and check that the corresponding cluster telltale light illuminates.
- Activate the hazard warning flashers and check that the corresponding cluster telltale lights illuminate.
- Press the headlights rocker switch in first position and confirm that the instrument panel illuminates.
- Press the headlights rocker switch in second position and confirm that the headlights illuminate.
- Turn on the high beams and check that the corresponding cluster telltale light illuminates.
- Press on the brake pedal and check that the STOP telltale light illuminates

Once these commands tested, activate the test mode to check the exterior lighting.

Go to the front of the vehicle and check the lights:

- Left and right directional signals.
- Identification lights and clearance lights.
- Low beams.
- High beams.

Left side and right side of the vehicle:

- Directional signals.
- Marker lights.

Rear of the vehicle:

- Directional signals.
- Identification lights and clearance lights.
- Stoplights and tail lights.
- Back-up light.
- Center High mounted Stop Light (CHSL)

## 8-20 Care and Maintenance

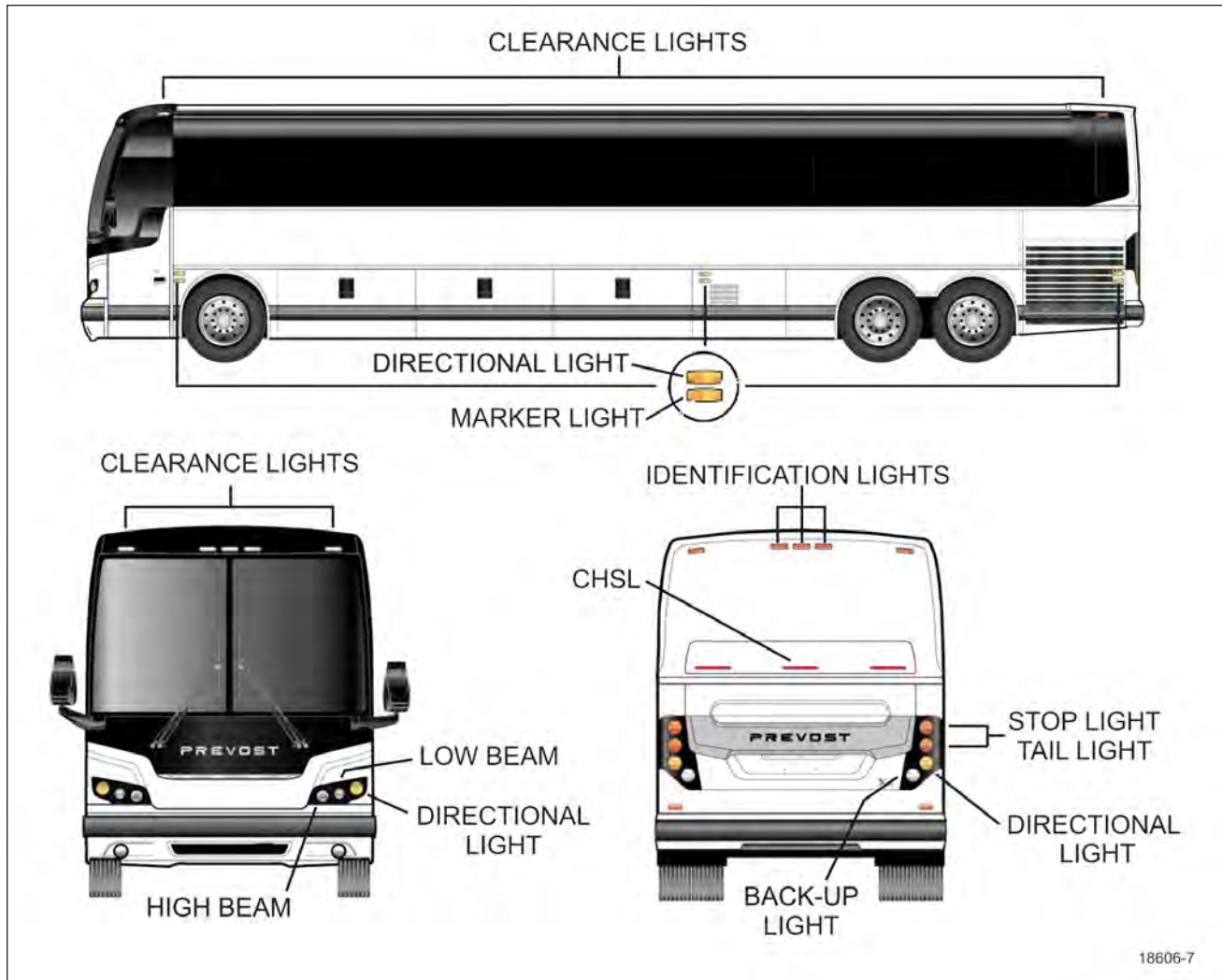


FIGURE 26: EXTERIOR LIGHTING (X3 SERIES)

## GENERAL RECOMMENDATIONS

- Understand the basic principles of vehicle operation;
- Always maintain the vehicle in good running condition;
- Do not drive with low fuel. If the fuel tank runs dry, the engine will not start until the air is bled from the fuel system. Refer to "Maintenance Manual" for more information;
- Allow engine to run for at least two minutes at normal idle before shutting off;
- Engine should be at idle when shifting from neutral (N) to forward (D) or from neutral (N) to reverse (R);



### CAUTION

Fast idle should always be turned off before releasing the parking brake and putting the coach in gear. Driveline damage can result if the fast idle switch is always left on.

- The automatic transmission does not have a park (P) position. Place transmission in neutral (N) position and apply parking brake when the vehicle is stopped. A warning buzzer will sound if the engine is stopped and the parking brake has not been applied when foot pressure is removed from the brake pedal;
- Always follow the procedures described in this manual;
- Unless stated otherwise, shut off the engine before performing all servicing, lubrication and maintenance tasks;
- Do not attempt to push or pull-start the coach;
- The vehicle may be damaged if towed with the axle shafts or driveshaft connected;

- Two chemical fire extinguishers are provided with the vehicle. Placement may vary depending on options and models. Take a moment to locate them in your vehicle.
- In case of fire, immediately evacuate all occupants. Occupant safety is the first priority. Do not attempt to extinguish the fire if there is immediate danger or risk for personal injury;
- When driving on ice and snow, accelerate and decelerate gradually;



### WARNING

Report all problems affecting passenger or driver safety to a Prevost service center. Have problems corrected immediately.

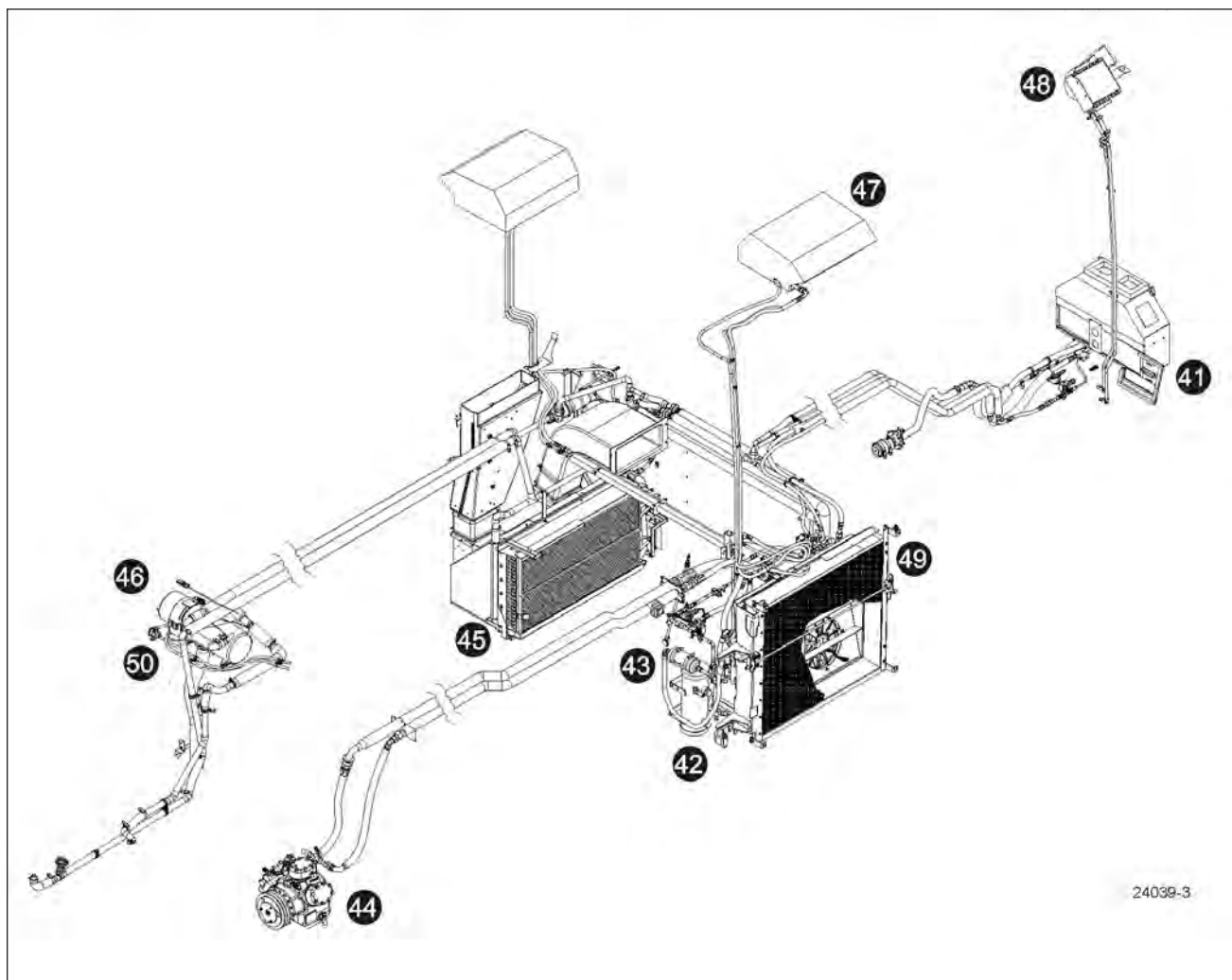


24039-7

FIGURE 27: X3 SERIES COMPONENT IDENTIFICATION (MAY DIFFER SLIGHTLY FROM THE ACTUAL VEHICLE)



|    |                                 |    |   |
|----|---------------------------------|----|---|
| 1  | Accessories air tank drain cock | 21 | Primary fuel filter                     |
| 2  | Accessories air filter          | 22 | Secondary fuel filter                   |
| 3  | Steering drag link              | 23 | Power steering fluid tank               |
| 4  | Height control valve (front)    | 24 | Engine oil filter                       |
| 5  | Steering tie rod                | 25 | Road Side Alternator                    |
| 6  | Accessories air tank            | 26 | Allison transmission oil dipstick       |
| 7  | Steering column U-joints        | 27 | Engine coolant surge tank               |
| 8  | Steering knuckle pins           | 28 | Coolant filter & conditioner            |
| 9  | Steering damper cylinder        | 29 | Engine air filter restriction indicator |
| 10 | Secondary air tank              | 30 | Engine air filter                       |
| 11 | Kneeling air tank               | 31 | Engine oil dipstick and filler tube     |
| 12 | Air dryer                       | 32 | DEF tank                                |
| 13 | Height control valve (rear)     | 33 | Diesel particulate filter               |
| 14 | Wet air tank                    | 34 | SCR catalytic converter                 |
| 15 | Primary air tank                | 35 | Diesel fuel tank                        |
| 16 | Differential                    | 36 | Davco Fuel Pro fuel filter              |
| 17 | Propeller shaft                 | 37 | Power steering pump                     |
| 18 | Tag axle lever pivot            | 38 | Air compressor                          |
| 19 | Transmission                    | 39 | Curb Side Alternators                   |
| 20 | Starter                         | 40 | Cooling Assembly (Radiator & CAC)       |



24039-3

**FIGURE 28: HVAC SYSTEM - MAIN COMPONENTS**

- |    |                                    |    |   |
|----|------------------------------------|----|---|
| 41 | HVAC air filter – driver's unit    | 46 | Coolant preheater                         |
| 42 | A/C receiver tank                  | 47 | A/C system – passenger's overhead console |
| 43 | Refrigerant moisture indicator     | 48 | Upper windshield defrost unit             |
| 44 | A/C compressor                     | 49 | Condenser coil                            |
| 45 | HVAC air filter – passenger's unit |    |   |

## WALKAROUND INSPECTION (BEFORE EVERY TRIP)

It is good practice to make a visual inspection of key areas on the vehicle every day (or before every trip for private coaches) and to correct any problem found.

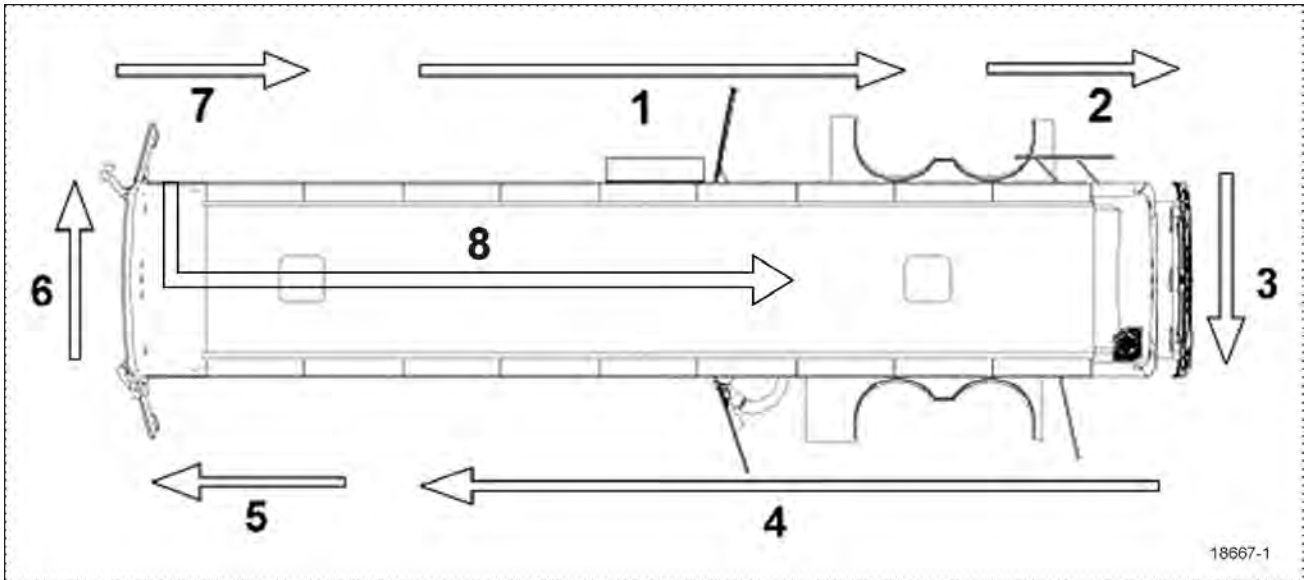


FIGURE 29: X3 SERIES WALKAROUND INSPECTION

### **NOTE**

*Inspect the coach in a circular manner as shown in the illustration.*

## 8-26 Care and Maintenance

---

### APPROACHING THE VEHICLE

- Check under the coach for oil, fuel or coolant leaks or other signs of damage.
- Check exterior body surfaces for signs of damage.

### PREPARATION

- Close air tank drain valves.
- Start the engine and let the air pressure build up to normal. Stop engine.
- Switch on hazard warning flashers.
- Make sure parking brakes are applied.

### STEP 1: RIGHT SIDE

- Check that the vehicle is equipped with a wheel nut wrench, spare door keys, spare belts, reflectors and jack.
- Check that baggage and service compartment doors are properly latched and locked.
- Check condition of wheels and rims. Especially look for cracks, missing nuts, bent or broken studs.
- Check condition of tires: properly inflated, no serious cuts, bulges, tread wear or any signs of misalignment; valve stems not touching wheels or rims; valve caps in place and no objects stuck between the wheels.

### STEP 2: ENGINE COMPARTMENT RIGHT SIDE AREA

- Check engine and surrounding areas for coolant, oil and fuel leaks.
- Check primary fuel filter/water separator and drain if necessary. Close drain valve after draining.

- Check power steering reservoir fluid level, add if necessary.
- Check wiring harness for signs of damage.

### STEP 3: ENGINE COMPARTMENT

- Check engine and surrounding areas for coolant, oil and fuel leaks.
- Check wiring harness for signs of damage.
- Check for loose, worn or broken belts.
- Check belts tension adjustment.
- Check engine crankcase oil level, add if necessary.
- Check Allison transmission fluid level (can also be checked from push-button shift selector), add if necessary.
- Check coolant surge tank fluid level, add if necessary.
- Check air cleaner restriction indicator, replace air cleaner when red signal locks in full view.
- Check stop light, tail light, directional signal light and back-up light assembly, they should be clean.

### STEP 4: REAR LEFT SIDE

- Check condition of wheels and rims. Especially look for cracks, missing nuts, bent or broken studs.
- Check condition of tires: properly inflated, no serious cuts, bulges, tread wear or any signs of misalignment; valve stems not touching wheels or rims; valve caps in place and no objects stuck between the wheels.
- Check that baggage and service compartment doors are properly latched and locked.

- Check optional auxiliary coolant heater for fuel leaks.

### STEP 5: FRONT LEFT SIDE

- Check condition of wheel rim. Especially look for cracks, missing nuts, bent or broken studs.
- Check condition of tire: properly inflated, no serious cuts, bulges, tread wear or any signs of misalignment; valve stem not touching wheel or rim; valve cap in place.
- Check windshield washer reservoir fluid level and add as necessary.
- If equipped, check headlights washer reservoir fluid level and add as necessary

### STEP 6: FRONT

- Check windshield for damage and clean if dirty.
- Check windshield wiper arms for proper spring tension.
- Check wiper blades for any damage, “dead” rubber and attachment to arm.
- Check clearance and identification lights, they should be clean.
- Check high and low beams, they should be clean. If equipped, check fog lights.
- Check left and right directional signals, they should be clean.
- Check to see that there is no mud, snow, ice build-up or other obstruction in front of the ACB radar sensor if applicable.

### STEP 7: FRONT RIGHT SIDE

- Check condition of wheel rim. Especially look for cracks, missing nuts, bent or broken studs.

- Check condition of tire: properly inflated, no serious cuts, bulges, tread wear or any signs of misalignment; valve stem not touching wheel or rim; valve cap in place.

### STEP 8: INSIDE THE VEHICLE

- Check for proper operation of the entrance door.
- Check steps; clean them if there is any substance that makes them slippery, which makes coach entry/exit hazardous.
- Adjust and clean mirrors for adequate rear view vision.
- Verify proper operation of windshield wiper/washer.
- Check for fire extinguishers to make sure they are ready for operation.
- Check that emergency exit windows and roof escape hatches can be opened then close all windows and hatches securely.

### WITH ENGINE RUNNING

- Start engine and check for proper operation of all gauges. Perform a telltale light test (see [DIAGNOSTICS MENU](#) under Cluster Selftest in Section 5 Other Features) . Indicator lights and buzzers should all be OFF before driving.
- Using the message center display, perform a system diagnostic to check if error codes and anomalies were recorded in the vehicle electronic modules.
- Check for proper operation of electric and air horns and back-up alarm.
- Check automatic transmission oil level, using the pushbutton shift selector (see the Allison transmission Appendix).
- Check that there is enough fuel in the tank.

## 8-28 Care and Maintenance

---

- Perform a parking brake test. Check both primary and secondary pressure gauges. Refer to “Other Verifications” in this section.
- Perform the exterior lighting verification using the test mode. Refer to ["OTHER VERIFICATION" on page 11](#) in this section.
- Walk around the vehicle and listen for air leaks.
- Check for leaks and listen for unusual sounds coming from the turbocharger.

## SECTION 9 - TECHNICAL INFORMATION

|  |           |
|--|-----------|
| <b>DIMENSIONS AND WEIGHTS</b> .....  | <b>3</b>  |
| <b>CAPACITIES</b> .....  | <b>6</b>  |
| <b>TURNING RADIUS</b> .....  | <b>7</b>  |
| <b>FUEL TYPE</b> .....   | <b>8</b>  |
| BIODIESEL FUEL .....   | 8         |
| <b>WHEELS AND TIRES</b> .....  | <b>8</b>  |
| RECOMMENDED TIRE INFLATION PRESSURE AT MAXIMUM COLD LOAD .....                     | 8         |
| <b>BELTS</b> .....   | <b>9</b>  |
| <b>VOLVO D13 ENGINE</b> .....  | <b>9</b>  |
| <b>ALLISON TRANSMISSION</b> .....  | <b>9</b>  |
| GEAR RATIOS .....  | 9         |
| <b>VOLVO I-SHIFT TRANSMISSION</b> .....  | <b>9</b>  |
| <b>PROPELLER SHAFT</b> .....   | <b>10</b> |
| <b>BRAKES</b> .....  | <b>10</b> |
| BRAKE CHAMBER EFFECTIVE AREA .....   | 10        |
| <b>AIR SYSTEM</b> .....  | <b>10</b> |
| <b>ANTILOCK BRAKING SYSTEM (ABS)</b> .....   | <b>10</b> |
| <b>AUTOMATIC TRACTION CONTROL (ATC) – ELECTRONIC STABILITY CONTROL (ESC)</b> ..... | <b>10</b> |
| <b>STEERING</b> .....  | <b>11</b> |
| <b>ELECTRICAL SYSTEM</b> .....   | <b>11</b> |
| <b>AXLES</b> .....   | <b>11</b> |
| I-BEAM FRONT AXLE .....  | 11        |
| FRONT AXLE - INDEPENDENT FRONT SUSPENSION (IFS) .....                              | 11        |
| DRIVE AXLE .....   | 11        |
| TAG AXLE .....   | 12        |
| <b>SUSPENSION</b> .....  | <b>12</b> |
| I-BEAM AXLE FRONT SUSPENSION .....   | 12        |
| INDEPENDENT FRONT SUSPENSION .....   | 12        |
| DRIVE AXLE .....   | 12        |
| TAG AXLE .....   | 12        |
| <b>ALIGNMENT SPECIFICATIONS</b> .....  | <b>12</b> |
| <b>COOLING SYSTEM</b> .....  | <b>13</b> |
| <b>FUEL SYSTEM</b> .....   | <b>13</b> |
| <b>EXHAUST SYSTEM</b> .....  | <b>14</b> |
| <b>HEATING AND AIR CONDITIONING</b> .....  | <b>14</b> |
| <b>OIL SPECIFICATIONS</b> .....  | <b>14</b> |
| ENGINE .....   | 14        |
| ALLISON TRANSMISSION .....   | 14        |

## 9-2 Technical Information

---

|  |           |
|--|-----------|
| I-SHIFT TRANSMISSION .....                       | 15        |
| DIFFERENTIAL .....                               | 15        |
| POWER STEERING RESERVOIR .....                   | 15        |
| <b>PRE-HEATING SYSTEM .....</b>                  | <b>15</b> |
| <b>PLATES AND CERTIFICATION .....</b>            | <b>15</b> |
| SAFETY CERTIFICATION .....                       | 16        |
| DOT CERTIFICATION PLATE .....                    | 16        |
| <b>EPA ENGINE LABEL .....</b>                    | <b>17</b> |
| <b>VEHICLE IDENTIFICATION NUMBER (VIN) .....</b> | <b>17</b> |
| VIN DEFINITION .....                             | 18        |
| <b>COACH FINAL RECORD .....</b>                  | <b>19</b> |



## DIMENSIONS AND WEIGHTS

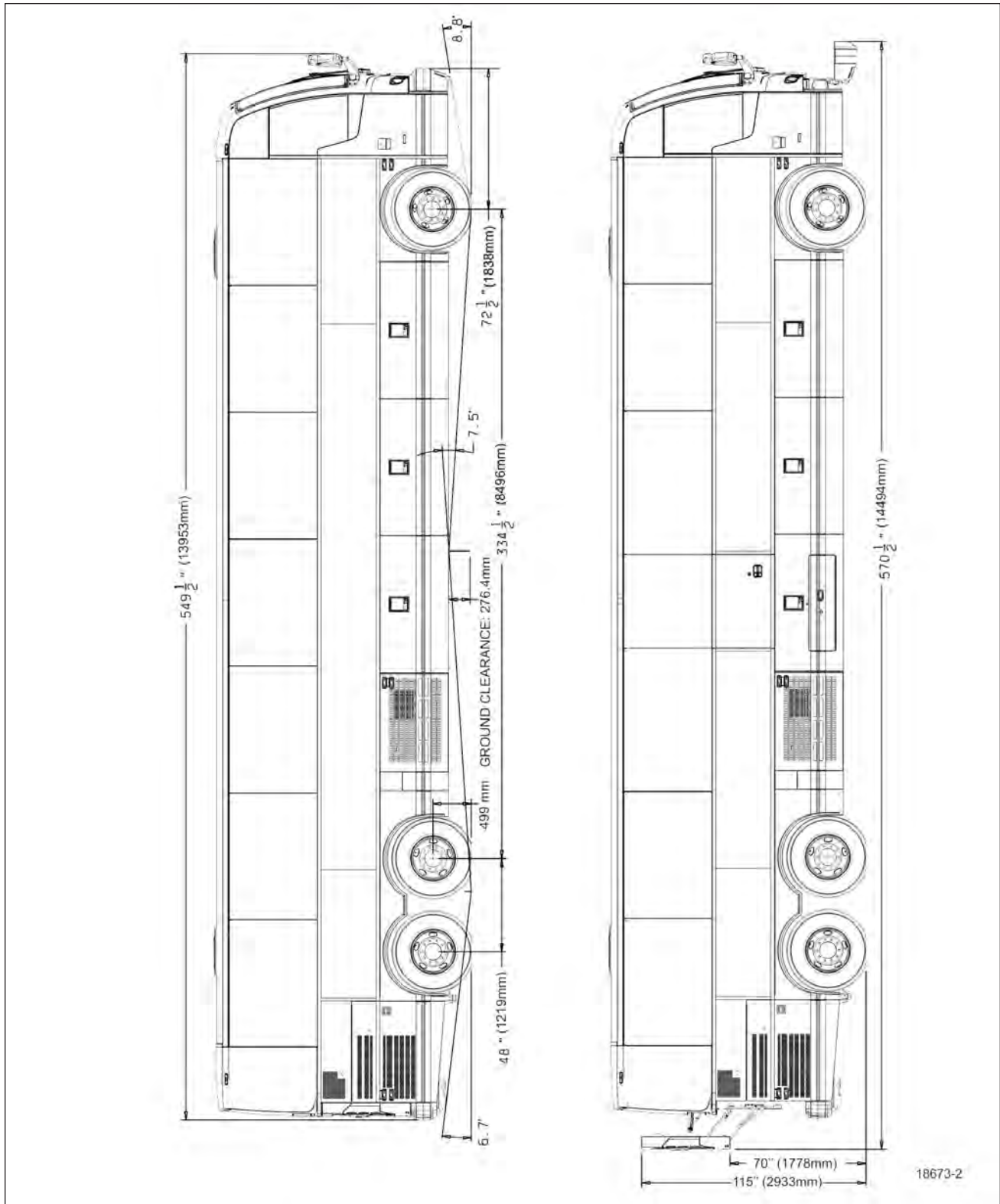


FIGURE 1: X3-45 OVERALL DIMENSIONS (SIDE ELEVATION)

# 9-4 Technical Information

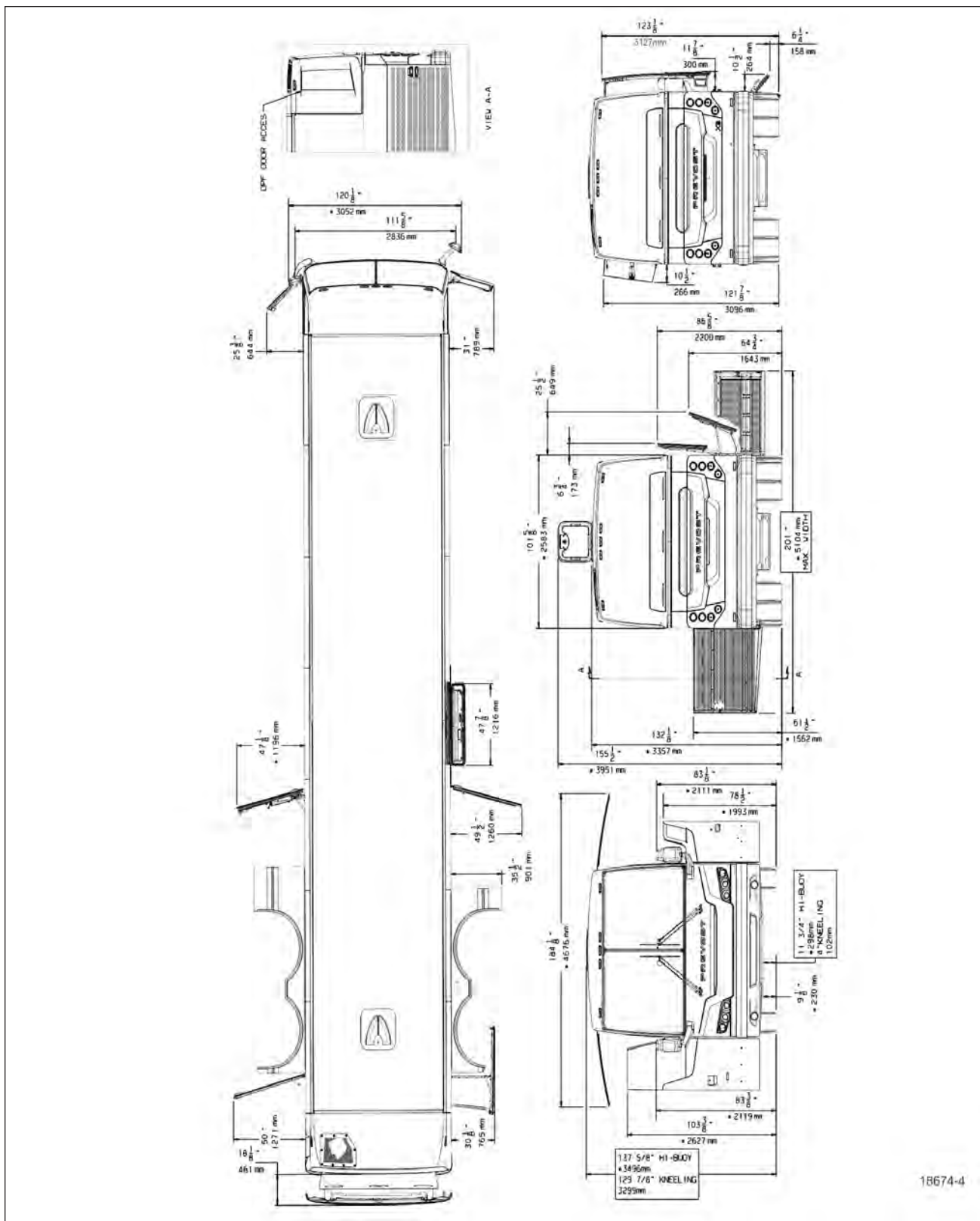


FIGURE 2: X3-45 OVERALL DIMENSIONS (TOP, FRONT AND REAR VIEWS)

| DIMENSIONS AND WEIGHTS   | X3-45                                   |
|--|---|
| Overall length<br>(including bumpers)                          | 45' (13,7 m)                            |
| Overall width  | 101.5 (2.57 m)                          |
| Overall height   | 133 7/8" (3.4 m)                        |
| Wheelbase<br>(center of front axle<br>to center of drive axle) | 334.4" (8494 mm)                        |
| Floor height from ground                                       | 49" (1,24 m)                            |
| Ground clearance   | 10 7/8" (276.4 mm)                      |
| Step height from ground (approx)                               | 14" (359 mm)<br>9 3/8" (239 mm) kneeled |
| Step height (other steps)                                      | 7" (178 mm)                             |
| Headroom   | 79 1/2" ( 1988 mm)                      |
| Entrance door opening width                                    | 30 1/4" (768 mm)                        |
| Front overhang   | 71.2" (1809.3 mm)                       |
| Rear overhang  | 86.6" (2.201 m)                         |
| Front track  | 85.2" (2.162 m)                         |
| Drive track  | 74.3" (1.888 m)                         |
| Rear track (Tag axle)  | 83.8" (2,128 m)                         |
| Curb weight  | 37100 lb. (16828 kg)                    |
| Gross Vehicle Weight Rating (G.V.W.R.)                         | 53 000 lb (24 040 kg)                   |
| Front axle Gross Axle Weight Rating (G.A.W.R.)                 | 16 500 lb (7 500 kg)                    |
| Drive axle (G.A.W.R.)  | 22 500 lb (10 206 kg)                   |
| Tag axle (G.A.W.R.)  | 14 000 lb (6 350 kg)                    |

**NOTE**

*Curb weight is given as an indication only and is subject to vary from coach to coach, mostly due to optional equipment*

The actual Gross Vehicle Weight Rating (G.V.W.R.) and the Gross Axle Weight Rating (G.A.W.R.) for front, drive and tag axles are listed on a certification plate located on the L.H. control panel in driver's section.

## 9-6 Technical Information

### CAPACITIES

| CAPACITIES   | X3-45   |
|--|---|
| Volvo D13 Engine oil (refill volume with filter change)            | 40 US quarts (38 l)   |
| Fuel tank<br>(legal capacity equal to 95% of volume)               | 203 US gal (768 l)  |
| Diesel Exhaust fluid tank (DEF)                                    | 16 US gal (60 l)  |
| Cooling system (excluding heating syst.)                           | 27.5 US gal 104 liters  |
| Allison Automatic Transmission (does not include external circuit) | 10.03 US gal (38 l) initial<br>6 US gal (23 l) refill<br>6.9 US gal (26.5 l) refill with retarder |
| I-Shift Transmission   | 16 US qts (15 l)  |
| Differential oil   | 20.5 US qts (19.4 l) Meritor axle<br>19.5 US qts (18.5 l) ZF A-132 axle                           |
| Power steering reservoir   | 4.0 US qts (3,7 l)  |
| A/C compressor oil   | 2.8 US quarts (2.6 liters)  |
| Windshield washer reservoir  | 5.3 US gal (20 l)   |
| Refrigerant  | 24 lb (11 kg)<br>26 lb (11.8 kg) with parcel rack cooling   |
| Toilet sump tank   | 15.6 US gal<br>(59 liters)  |
| Baggage compartment  | Total volume:<br>380 ft <sup>3</sup><br>Loading capacity:<br>2500 lbs/compartment                 |

## TURNING RADIUS

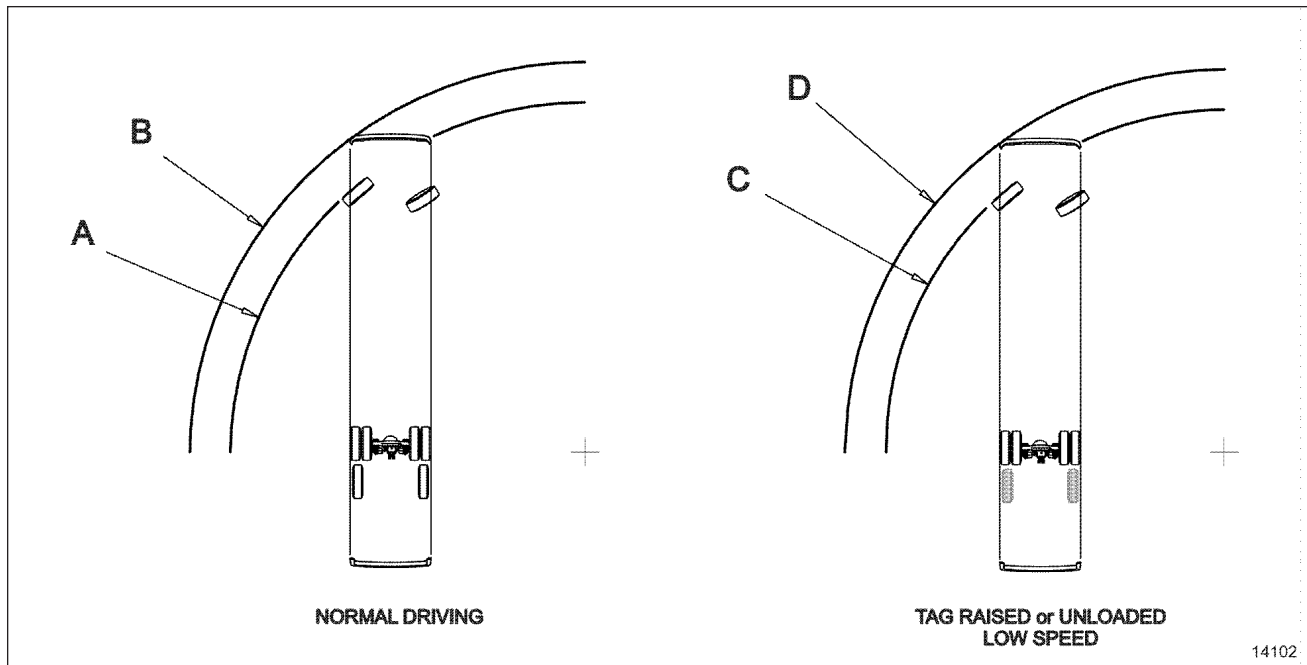


FIGURE 3: TURNING RADIUS DIAGRAM

Table below shows the turning radius values. The values are presented in by model and front axle type. Values A and B are for normal driving. Values C and D show values for low speed maneuvering where the tag axle is raised or unloaded .





### CAUTION

Do not drive vehicle with tag axle raised at speeds exceeding 12 mph (20 km/h). For additional details, refer to ["TAG AXLE CONTROL VALVE" on page 9](#) in Section 4 Controls and Instruments and ["RETRACTABLE TAG AXLE" on page 32](#) in Section 5 Other Features.

### NOTE

*Supplied values are theoretical. Factors such as ground surface, vehicle speed and road conditions may significantly affect the turning radius.*

| Turning Radius 1, 2  | X Series<br>w/ I-beam Axle | X Series<br>with Front Independent Suspension |
|--|----------------------------|---|
| A (Curb to Curb)   | 13.37m (43'11")            | 12.00m (39'5")                                |
| B (Wall to Wall)   | 14.50m (47'7")             | 13.20m (43'4")                                |
| C (Curb to Curb)  | 12.80m (42'0")             | 11.50m (37'9")                                |
| D (Wall to Wall)  | 13.94m (45'9")             | 12.70m (41'8")                                |

<sup>1</sup>Curb to Curb value corresponds to the outer tire's track on the ground.

<sup>2</sup>Wall to Wall value includes the vehicle's body overhang.

## 9-8 Technical Information

### FUEL TYPE

Your Prevost vehicle is powered by a diesel engine designed to operate only with Ultra Low Sulfur Diesel (ULSD) fuel, which can contain no more than 15 ppm sulfur.



#### WARNING

ULSD fuel is necessary to avoid fouling the engine's Exhaust Aftertreatment System. Use of fuel other than ULSD will reduce the efficiency and durability of the engine.

### BIODIESEL FUEL

Biodiesel with up to a maximum of 5% biofuel (B5) may be used and will not affect the manufacturer's mechanical warranty as to engine and emissions system related components. The biofuel used in the various blends must conform to ASTM D6751; therefore B1 to B5 blends conforming to ASTM D975. Also, any engine performance problem related to the use of biodiesel fuel would not be recognized nor considered as Volvo or Prevost's responsibility.

However, Volvo engines are certified to comply with U.S. EPA and California emissions standards based upon the use of test fuels with specifications established by these regulatory agencies.

Alternative fuels, including biodiesel, that are not substantially similar to the required test fuels may adversely affect engine emissions compliance. As a result, Volvo does not warrant the engine will conform to applicable Federal or California emissions limits when operated on biodiesel or other alternative fuels that are not substantially similar to specified test fuels used for certification.

Additional maintenance is required and is covered in Section 03: FUEL SYSTEM of the maintenance manual.

### WHEELS AND TIRES

#### WHEELS DIMENSION

Accuride steel wheels: 9" X 22½"

Inner drive axle steel wheels : 8¼" X 22½"

Alcoa aluminum wheels (front, drive, tag axles): 9" X 22½"

Alcoa super single wheels (drive axle): 14" X 22½"

#### TIRE DIMENSIONS

Front & auxiliary axles: 315/80 R22.5 load range L tires on both axles or 365/70 R22.5 load range L tires on both axles

Drive axle: 315/80 R22.5 load range L tires

Drive axle: super single 455/55 R22.5 load range L tire

#### RECOMMENDED TIRE INFLATION PRESSURE AT MAXIMUM COLD LOAD

The recommended tire inflation pressures are given in the applicable documents supplied with the vehicle. In addition, minimum cold tire inflation pressures are listed on the Department of Transport (DOT) certification plate, affixed on the left wall near the driver's seat.

Vehicles equipped with TPMS: The TPMS target pressures are factory set to equal the prevailing tire pressure at delivery time. When tire pressures are increased to account for higher vehicle weight, the TPMS set point needs to be increased accordingly.



#### CAUTION

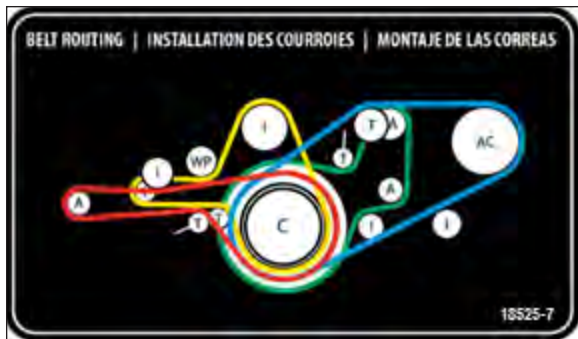
These tire pressures are established in accordance with the maximum allowable load on each axle. A lower pressure is recommended if the axle load is less than the above specifications. Weigh vehicle fully loaded and pressurize according to tire manufacturer's recommendations. For non-standard tire and wheel specifications, see Prevost tire pressure tabulation in "Coach Final Record" or special specification chart affixed next to the DOT certification plate.



#### WARNING

Special tire selection may lower the maximum allowable speed limit, even below posted speed limit. For maximum safety, check with the tire manufacturer.

## BELTS



A: Alternator    I: Idler    T: Tensioner  
 C: Crank    WP: Water pump    AC: A/C compressor

| Belt application   | Type                      | Qty |
|--|---------------------------|-----|
| A/C compressor - high capacity HVAC system                 | V Belt BX71               | 2   |
| Alternator - twin Bosch, curb side                         | Multi-V-8 Rib 8PK1575     | 1   |
| Alternator - emergency belt on upper alternator, curb side | Multi-V-8 Rib 8PK1512     | 1   |
| Alternator - single Bosch, street side                     | Multi-V-10 Rib 10PK1695   | 1   |
| Coolant pump   | Multi- V- 10 Rib 10PK1512 | 1   |

### NOTE

*Belts specifications and configurations may vary. For proper belt selection, always consult your vehicle "Coach Final Record".*

## VOLVO D13 ENGINE

Type: . . . . . 4-stroke / inline 6-cylinders  
 Displacement: 12.8 l, SOHC, 4-valve /cylinder  
 Power: . . . . . 435 HP  
 Torque: . . . . . 1665 lbf-ft (2257 Nm) @1050 TO 1300 RPM  
 Cruise speed range: . . . . . 1300-1500 rpm  
 Full dress, dry weight: . . . . .2582 lb / 1174 kg

## ALLISON TRANSMISSION

Allison B500 (B500R with the optional output retarder) electronically controlled 6- speed automatic transmission.

### GEAR RATIOS

|                                     |                     |
|-------------------------------------|---------------------|
| 1st .....                           | 3.51                |
| 2nd .....                           | 1.91                |
| 3rd .....                           | 1.43                |
| 4th .....                           | 1.00                |
| 5th .....                           | 0.74                |
| 6th .....                           | 0.64                |
| Reverse:                            | 4.80                |
| Converter:                          | 1.90                |
| Differential ratio                  | 3.91                |
| Differential ratio (optional):      | 3.58                |
| Differential ratio (ZF A-132 axle): | 3.54                |
| Maximum input torque:               | 1700 lb-ft (2304Nm) |

## VOLVO I-SHIFT TRANSMISSION

Electronically automated twelve speed automatic transmission

### Gear & Ratio

|            |       |
|------------|-------|
| 1st .....  | 14.94 |
| 2nd .....  | 11.73 |
| 3rd .....  | 9.04  |
| 4th .....  | 7.09  |
| 5th .....  | 5.54  |
| 6th .....  | 4.35  |
| 7st .....  | 3.44  |
| 8nd .....  | 2.70  |
| 9rd .....  | 2.08  |
| 10th ..... | 1.63  |

## 9-10 Technical Information

|                                     |                       |
|-------------------------------------|-----------------------|
| 11th .....                          | 1.27                  |
| 12th .....                          | 1.00                  |
| Reverse 1st:                        | 17.48                 |
| Reverse 2nd:                        | 13.73                 |
| Differential ratio (ZF A-132 axle): | 2.50                  |
| Maximum input torque:               | 1920lb-ft<br>(2603Nm) |

### PROPELLER SHAFT

Dana Spicer SPL250 type tubular shaft, provided with heavy-duty universal joints.

### BRAKES

The features of the braking system include a dual system where the front and rear circuits are completely independent from each other. The brakes are air operated disc type brakes. The emergency/parking brakes are located on the drive axle. To ensure a constant running clearance between pads and disc, the brakes are equipped with a non-wearing, automatic adjuster mechanism.

#### BRAKE CHAMBER EFFECTIVE AREA

Front axle: . . . . . 24 in<sup>2</sup>

Drive axle: . . . . . 24/24 in<sup>2</sup> (service /emergency)

Tag axle: . . . . . 16 in<sup>2</sup>

### AIR SYSTEM

Compressed air is provided by a twin cylinder, 31.8 cfm Wabco, gear-driven, water-cooled and engine oil lubricated air compressor.

### ANTILOCK BRAKING SYSTEM (ABS)

The antilock braking system has one Electronic Control Unit (ECU) controlling a 6-sensor/5-modulator (6s/5m) system. A wheel slip sensor is mounted at each wheel.

The Electronic Control Module (ECM) is maintenance free. Its operating voltage is 24 ± 6 volts DC. The thermal operating range for the ECM is from -40 to 167°F (-40 to 75°C).

The solenoid control valves are maintenance free. Their operating voltage is 24 (+4.8, -2.4) volts DC. The rated current draw is 1.65 amps. The thermal operating range of the solenoid control valves is from -40 to 176°F (-40 to 80°C).

### AUTOMATIC TRACTION CONTROL (ATC) – ELECTRONIC STABILITY CONTROL (ESC)

In addition to the ABS function, vehicle is equipped with a Traction Control System (TCS) feature. This feature is provided by the Bendix ESP EC-80 controller. Bendix refers to this feature as Automatic Traction Control (ATC). Bendix ATC can improve vehicle traction during acceleration, and lateral stability while accelerating through curves. ATC utilizes Engine Torque Limiting (ETL) where the ECU communicates with the engine's controller and/or Differential Braking (DB) where individual wheel brake applications are used to improve vehicle traction.

The ESP EC-80 model controller also provides an ABS-based Electronic Stability Control (ESC) feature. Bendix refers to it as ESC Electronic Stability Control.

The Bendix ESC system is an ABS-based stability system that enhances vehicle stability by both reducing engine throttle and by applying vehicle braking based on actual vehicle dynamics.



#### CAUTION

Even with ESC-equipped vehicles, the driver remains responsible for ensuring vehicle stability during operation.



#### DANGER

ESC may reduce the vehicle speed automatically.

ESC can make the vehicle decelerate automatically. ESC can slow the vehicle with or without the operator applying the brake, and even when the throttle is being applied



## STEERING

ZF 8098 integral hydraulic assisted steering gear

- Hydraulic pump gear driven from engine.
- ZF Servocomtronic variable ratio and variable assistance in function of vehicle speed available.
- Hydraulic reservoir and dipstick accessible from the engine compartment.
- System pressure: 2175 psi (150 bars).
- Steering wheel diameter 18". Tilt steering wheel and telescopic steering column; pneumatically locked with foot-operated switch for adjustment.
- Number of turns: 5¾.

## ELECTRICAL SYSTEM

- 24-volt, negative ground;
- 12-volt exterior lighting;
- Three 24 volts, 150 amp, self-regulated, belt-driven, air-cooled HD 10 Bosch alternators;
- Four 12 Volts, group 31 AGM type batteries connected in series/parallel. Each one has a reserve capacity of 200 minutes and a cold cranking capacity of 800 amps.
- 100 amp battery equalizer.

## AXLES

### I-BEAM FRONT AXLE

- Dana Spicer model S84U with forged "I" beam
- Reverse Elliot type

- Unitized wheel bearings (maintenance free)
- Factory pre-adjusted caster

### FRONT AXLE - INDEPENDENT FRONT SUSPENSION ( IFS)

- Prevost independent front suspension with calibrated air springs for improved comfort
- 19 000 lbs capacity (loading limit could be less depending on the wheel and tire selection)
- Wide apart double V -arm design mounted on ball joints with torque link
- Double sealed taper roller bearings bell crank and idler steering arm
- Unitized wheel bearing (maintenance-free bearing)
- Factory pre-adjusted caster

### DRIVE AXLE

- Meritor model RC23-165 full banjo type dual tire drive or ZF A-132 dual tire cast axle
- Optional ZF A-132 dual tire cast axle capacity ratio: 3.54 or 3.82
- Meritor RC23-165 with Allison transmission ratio: 3.91 (standard), 3.58 & 4.10 (optional)
- Meritor RC23-165 with I-Shift transmission ratio: 2.50
- Oil lubricated wheel bearings on Meritor RC23-165
- Factory pre-adjusted caster

## 9-12 Technical Information

### TAG AXLE

- Prevost hollow square beam
- FAG Unitized wheel bearings (maintenance free)
- Tag axle may be unloaded to provide better traction in snow, mud and reduce the turning radius and tire scrub at low cornering speed

### SUSPENSION

Goodyear rolling lobe type air springs (bellows) are used throughout.

#### I-BEAM AXLE FRONT SUSPENSION

- 2 Bellows;
- 2 Shock absorbers;
- 4 Radius rods;
- 1 Transverse radius rod;
- 1 Height control valve;
- 1 sway bar;

#### INDEPENDENT FRONT SUSPENSION

- 2 Bellows;
- 2 Shock absorbers;
- 2 Upper V-arms;
- 2 Lower V-arms;
- 2 Torque rods;
- 2 Steering Levers;
- 1 Height control valve;
- 1 sway bar;

#### DRIVE AXLE

- 4 Bellows;
- 4 Shock absorbers;
- 3 Radius rods;
- 1 Panhard rod;
- 2 Height control valves;
- 1 Anti-roll bar;

### TAG AXLE

- 2 Bellows;
- 2 Shock absorbers;
- 3 Radius rods;
- 1 Panhard rod;

### ALIGNMENT SPECIFICATIONS

Use static wheel alignment systems which work with angle measurements only, such as Josam or Hunter systems. Static alignment specifications are listed in the following tables:

| FRONT I-BEAM AXLE |               |               |               |
|-------------------|---------------|---------------|---------------|
|                   | Minimum value | Nominal value | Maximum value |
| Right camber      | -0.25°        | 0.125°        | 0.375°        |
| Left camber       | -0.25°        | 0.125°        | 0.375°        |
| Right caster      | 2.0°          | 2.75°         | 3.5°          |
| Left caster       | 2.0°          | 2.75°         | 3.5°          |
| Total toe         | 0.04°         | 0.06°         | 0.08°         |

**INDEPENDENT FRONT SUSPENSION**

|              | Minimum value | Nominal value | Maximum value |
|--------------|---------------|---------------|---------------|
| Right camber | 0.0°          | 0.150°        | 0.30°         |
| Left camber  | 0.0°          | 0.150°        | 0.30°         |
| Right caster | 2.35°         | 2.6°          | 2.85°         |
| Left caster  | 2.35°         | 2.6°          | 2.85°         |
| Total toe    | 0.04°         | 0.06°         | 0.08°         |

**DRIVE AXLE - MERITOR**

|              | Minimum value   | Nominal value | Maximum value    |
|--------------|-----------------|---------------|------------------|
| Thrust angle | ±0.11°          |               |                  |
| Total toe    | 0.18°<br>toe-in | 0°            | 0.18°<br>toe-out |

**DRIVE AXLE - ZF A132**

|              | Minimum value   | Nominal value | Maximum value    |
|--------------|-----------------|---------------|------------------|
| Thrust angle | ±0.11°          |               |                  |
| Total toe    | 0.15°<br>toe-in | 0°            | 0.15°<br>toe-out |

**TAG AXLE**

|               | Minimum value   | Nominal value | Maximum value    |
|---------------|-----------------|---------------|------------------|
| Thrust angle* | -0.02°          | 0             | 0.02°            |
| Total toe     | 0.12°<br>toe-in | 0°            | 0.02°<br>toe-out |

(\* ) Use the drive axle as reference

**COOLING SYSTEM**

- Extra capacity, Aluminum radiator and aluminum charge air cooler arranged side by side.
- Eight 24V speed controlled by ECU electrical cooling fans.
- Radiator fans: pusher type, 6 high power 24 Volts electrical fans, 12-inch diameter.
- CAC fans: pusher type, 2 high power 24 Volts electrical fans, 12-inch diameter.
- Rubber insulated from the body.
- Expansion & recovery tanks above radiator and remote mounted.
- System pressure 15 psi.
- Factory-fill coolant: -Volvo VCS2B ELC (Extended life coolant), color orange.
- Thermostat: 82 / 92 °C (180 / 198 °F) – (cracking / fully open).
- Full system capacity 27.5 US gal (104 l).
- Coolant filter without Supplemental Coolant Additive (SCA).

**FUEL SYSTEM**

Polyethylene 203 US gallons (768 liters) fuel tank centrally located.

- Anti-spill device.
- Safety filler cap on right side of coach.
- Pressure relief valve.
- Electric fuel gauge.
- Low level signal at 26 US gallons (98.4 liters).
- Primary filter 10 microns (standard).

## 9-14 Technical Information

- Primary fuel filter with electrical water indicator (Volvo D13).
- Fuel Pro filter available as an optional primary filter.
- Secondary filter 3 to 5 microns.
- Shut-off valve on fuel supply line.

### EXHAUST SYSTEM

One all stainless steel exhaust & aftertreatment system including:

- Catalytic converter to reduce NOx.
- Aftertreatment system made of a DPF (Diesel Particulate Filter), DOC (Diesel Oxidation Catalyst) and SCR system. Noise & vibration damped, this ATD is mounted to the vehicle structure and is accessible through an exterior access door.
- Tail pipe diffuser and rain deviation device.
- Exhaust pipe with flexible section.
- Exhaust to rear rooftop.
- Diesel exhaust fluid (DEF) tank (60 liters) and injection system.

### HEATING AND AIR CONDITIONING

A large capacity central HVAC system provides enough conditioned and filtered air for all climatic conditions. Fresh air is drawn into the system from the evaporator compartment on driver's side of the vehicle. Return air is taken from the middle of the vehicle. The driver's heater and defogger are controlled separately from the passenger's unit. An air mixture selector enables air to be drawn into the system from outside the vehicle or recirculated.

Optionally, condensers installed in the overhead storage compartments provide cool air to the seated passengers from the overhead registers.

| CENTRAL HVAC SYSTEM                  |                                      |
|--------------------------------------|--------------------------------------|
| Air conditioning capacity            | 9 tons                               |
| Refrigerant type                     | 134A                                 |
| Heating capacity                     | 150 000 Btu/h                        |
| Air flow                             | 2 600 cfm (73,6 m <sup>3</sup> /min) |
| Air flow, overhead compartment, opt. | 450 cfm (12,7 m <sup>3</sup> /min)   |

| COMPRESSOR (central HVAC system) |                            |
|----------------------------------|----------------------------|
| Number of cylinders              | 4                          |
| Operating speed                  | 500 to 3500 rpm            |
| Oil capacity                     | 2.8 US quarts (2.6 liters) |
| Approved oil                     | Bitzer BSE55 (POE)         |

#### NOTE

*The above oils are suitable for use with reciprocating compressors using refrigerant R134a and with evaporator temperatures above 40°F (-40°C).*

### OIL SPECIFICATIONS

Oil specifications for the vehicle's systems.

#### ENGINE

##### Volvo D13N (EOBD-U24)

Recommended: SAE Viscosity Grade 5W-30 meeting Volvo specification VDS-5 or API FA-4.

Minimum requirement: Volvo specification VDS-4.5 or API CK-4 oils

#### ALLISON TRANSMISSION

Allison Transmission recommends the following fluids:

- Castrol TranSynd™ or TES668 or TES-295 specification equivalent fluid;
- TES-389 specification equivalent fluid.

## I-SHIFT TRANSMISSION

Only use VOLVO- approved synthetic transmission oil in the I-Shift transmission. Refer to section 24 of the Maintenance Manual for more information about oils approved by Volvo;

## DIFFERENTIAL

Multigrade gear oil meeting MIL-PRF-2105E: 85W-140 is recommended for use in the Meritor drive axle. This lubricant performs well over a broad temperature range, providing good gear and bearing protection in a variety of climates. If temperature drops below 10°F (-12°C), 80W-90 should be used, and below -15°F (-26°C), 75W-90 should be used. In extreme conditions or for better performance, full synthetic gear oil should be used.

For vehicles equipped with the ZF A-132 drive axle, use ZF Ecofluid 80W-90 (ZF lubricant class 12M) or refer to ZF List of lubricants TE-ML 12 for other approved lubricants.

## POWER STEERING RESERVOIR

Use Automatic Transmission Fluid (ATF) Dexron-III (F, G or H) or Dexron-IV for this system.

## PRE-HEATING SYSTEM

Depending on options chosen, a coolant heater may be installed on the coolant circuit. The heater can be used as a pre-heater or as an auxiliary heat source.

The heater is controlled by a 7- day programmable timer. Refer to ["PREHEATER" on page 32](#) in *Other Features* for information on how to use the timer.

| PRE-HEATER       |                               |
|------------------|-------------------------------|
| Make             | Eberspächer                   |
| Model            | Hydronic L30                  |
| Heating output   | 30 kW                         |
| Fuel type        | Same as engine                |
| Fuel consumption | 0.96 US Gal/hr<br>(3.65 l/hr) |

| PRE-HEATER                                    |               |
|---|---------------|
| Rated voltage                                 | 24 V DC       |
| Operating voltage                             | 20-30 V DC    |
| Electric power consumption without water pump | 105 watts     |
| Weight  | 40 lb (18 kg) |

## PLATES AND CERTIFICATION

The main components of the vehicle such as engine, transmission, axles and chassis are identified by different serial numbers. It may be necessary to locate these numbers for warranty purposes.

The engine data plate is located on the rocker cover. The engine serial and model number and a list of the optional engine equipment are written on this plate. Refer to this information when ordering replacement parts. Also the engine data plate certifies that the engine conforms to federal and any state exhaust emissions regulations.

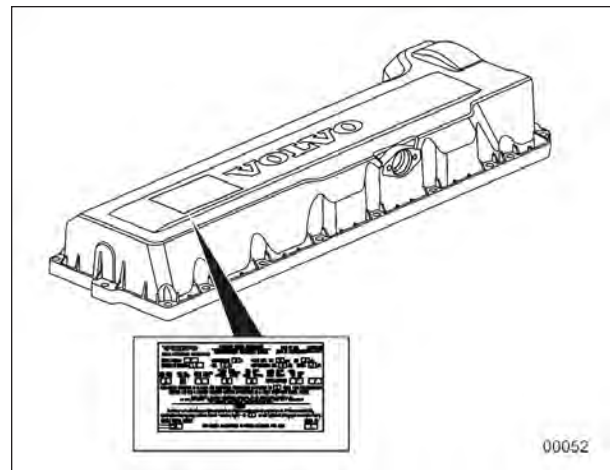


FIGURE 4: VOLVO D13 ENGINE DATA PLATE

## 9-16 Technical Information

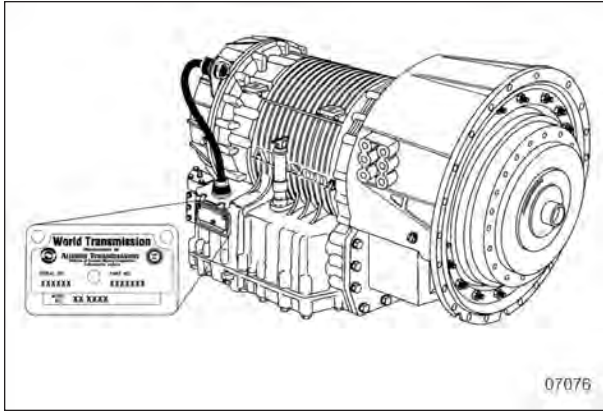


FIGURE 5: ALLISON TRANSMISSION

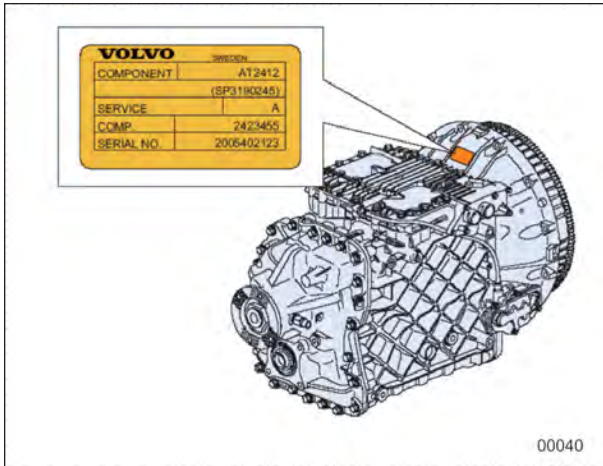


FIGURE 6: I-SHIFT TRANSMISSION

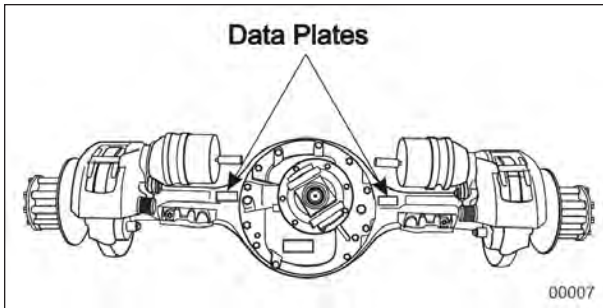


FIGURE 7: MERITOR DRIVE AXLE

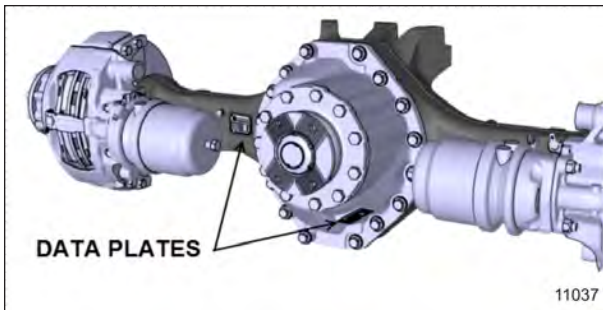


FIGURE 8: ZF A-132 DRIVE AXLE

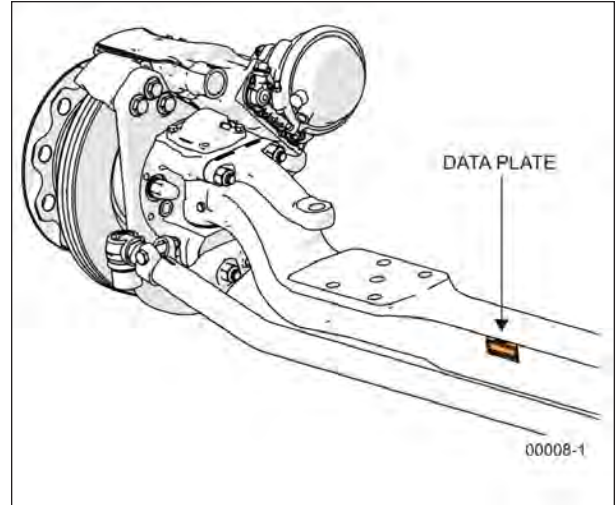


FIGURE 9: I-BEAM FRONT AXLE

### SAFETY CERTIFICATION

Vehicle components meet specifications and standards as follows:

- Material and parts conform to ASTM and/or SAE standards in effect at the time of manufacture.
- All factory-installed interior materials meet FMVSS 302 for fire resistance.
- Certified according to Provincial, State and Federal Safety standards (Canadian and US) BMCSS, FMVSS and CMVSS.
- Other applicable certification labels are affixed to the component.

### DOT CERTIFICATION PLATE

This certifies that vehicles manufactured by Prevost comply with all Federal Motor Vehicle Safety Standards at the time of manufacture. Information such as the date of manufacture, model year, gross vehicle weight rating, tire types and inflation pressure is also etched on this plate.

The DOT Certification plate is affixed to L.H. control panel.


|   |                              |   |                 |  |   |
|---|------------------------------|---|-----------------|--|---|
| <b>PREVOST</b> ®  |                              | MANUFACTURED BY : GROUPE VOLVO CANADA INC.<br>FABRIQUE PAR : STE-CLAIRE, QUE. |                 | <b>E</b>  |   |
| G.V.W.R. : 21772 KG. (48000 LBS).   |                              | DATE OF MFG. : <input type="text"/>   |                 |  |   |
| P.N.B.V. :  |                              | DATE DE FAB. :  |                 |  |   |
| AXLES/<br>ESSEUX  | G. A. W. B. /<br>P. N. B. E. | TIRES/<br>PNEUS   | RIMS/<br>JANTES | COLD<br>INFLATION<br>PRESS. /<br>PRESS. A<br>PROTO   | SINGLE<br>OR DUAL<br>SIMPLE<br>OU<br>DOUBLE |
|   | KG (LBS)                     |   |                 | KPA (PSI)  |   |
| FRONT:<br>AVANT:  | 7484 (16500)                 | 315/80R22.5 (J)   | 22.5X9          | 827 (120)  | S   |
| INT.<br>DIFF. :   | 10206 (22500)                | 315/80R22.5 (J)   | 22.5X9          | 586 (85)   | D   |
| REAR:<br>TANDEM:  | 6350 (14000)                 | 315/80R22.5 (J)   | 22.5X9          | 689 (100)  | S   |
| THIS VEHICLE CONFORMS TO ALL APPLICABLE U.S. FEDERAL MOTOR VEHICLE SAFETY STANDARDS IN EFFECT ON THE DATE OF MANUFACTURE SHOWN ABOVE. |                              |   |                 |  |   |
| VEHICLE IDENTIFICATION NO. <input type="text"/>   |                              |   |                 |  |   |
| NO. IDENTIFICATION VEHICULE <input type="text"/>  |                              |   |                 |  |   |
| TYPE: BUS   |                              | 406898  |                 |  |   |

FIGURE 10: EXAMPLE OF CERTIFICATION PLATE

### EPA ENGINE LABEL

The emissions certification label affixed in the engine compartment certifies that the engine conforms to federal and any state exhaust emissions regulations.

|   |   |
|---|---|
| <b>PREVOST</b>  | <b>VEHICLE EMISSION CONTROL INFORMATION</b> |
| PREVOST, A DIVISION OF VOLVO GROUP CANADA INC.  |   |
| VEHICLE FAMILY IDENTIFICATION: $\gamma$ VPT2VOCVF00 VIN: <u>XXXXXXXXXXXXXXXXXX</u>                  |   |
| REGULATORY SUB-CATEGORY: Compression-ignition Heavy HDV vocational                                  |   |
| DATE OF MANUFACTURE: <u>mm/yyyy</u>   |   |
| VEHICLE EMISSION CONTROL SYSTEM: <u>xxxx</u>  |   |
| THIS VEHICLE COMPLIES WITH CALIFORNIA AND U.S. EPA REGULATIONS FOR <u>yyyy</u> MODEL YEAR VEHICLES. |   |
| 010303  |   |
| 00064   |   |

FIGURE 11: EPA CERTIFICATION LABEL

### VEHICLE IDENTIFICATION NUMBER (VIN)



FIGURE 12: VEHICLE IDENTIFICATION NUMBER (X3 SERIES)

The Vehicle Identification Number is stamped on the DOT certification plate and also on a plate located on the windshield frame pillar (driver's side). The VIN is visible from the outside of the vehicle. Make sure the correct vehicle identification number is given when ordering replacement parts. Using the VIN when ordering parts will facilitate processing.

#### NOTE

Record the VIN in the vehicle documentation and keep with company records. The VIN will normally be used for vehicle registration, service reference needs and for obtaining vehicle insurance coverage.

# 9-18 Technical Information

## VIN DEFINITION

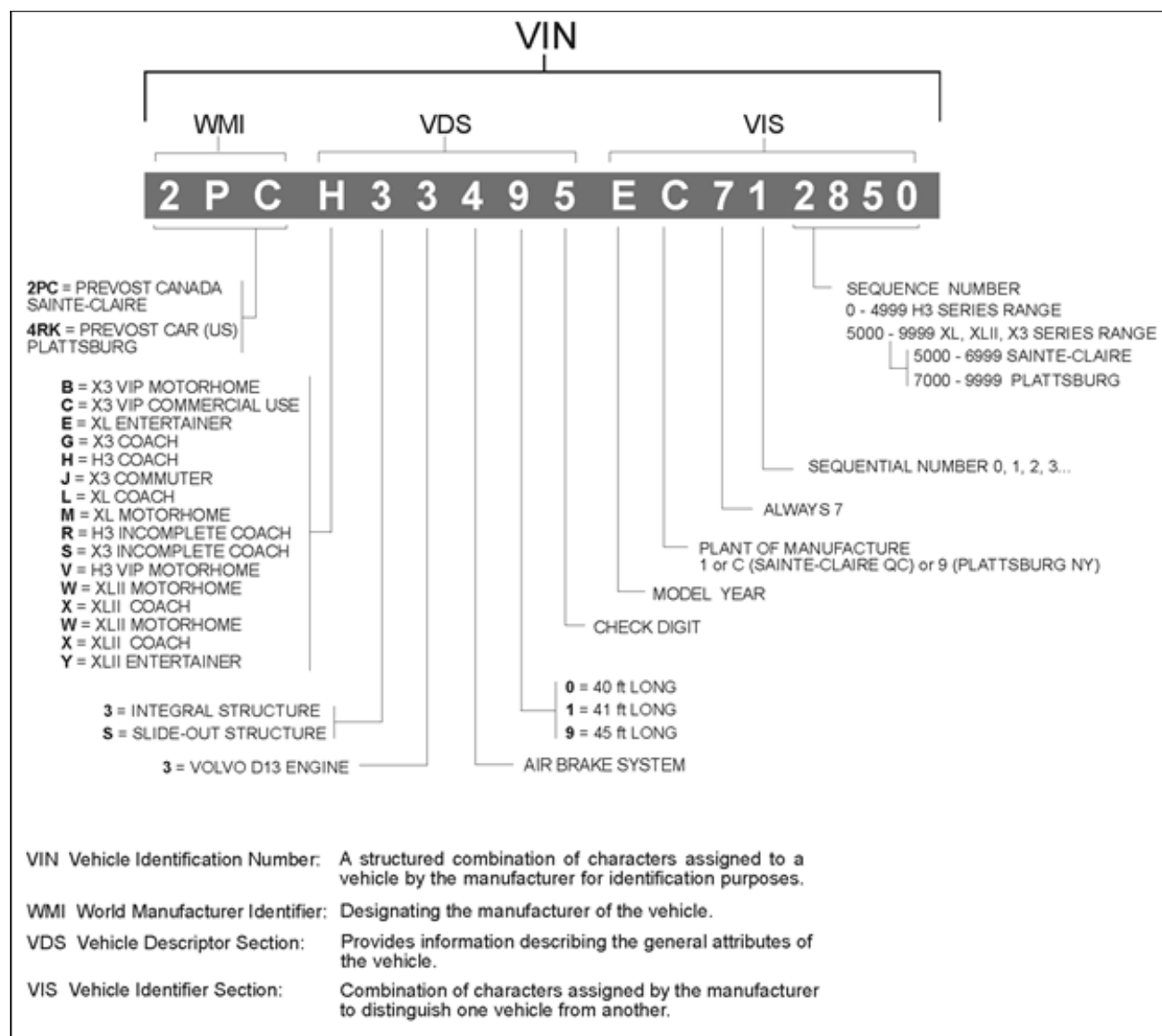


FIGURE 10: VEHICLE IDENTIFICATION NUMBER

00057\_5

| YEAR | CODE | YEAR | CODE | YEAR | CODE |
|------|------|------|------|------|------|
| 2001 | 1    | 2009 | 9    | 2017 | H    |
| 2002 | 2    | 2010 | A    | 2018 | J    |
| 2003 | 3    | 2011 | B    | 2019 | K    |
| 2004 | 4    | 2012 | C    | 2020 | L    |
| 2005 | 5    | 2013 | D    | 2021 | M    |
| 2006 | 6    | 2014 | E    | 2022 | N    |
| 2007 | 7    | 2015 | F    | 2023 | P    |
| 2008 | 8    | 2016 | G    | 2024 | R    |



## COACH FINAL RECORD

The Coach Final Record is a record of all data pertaining to the assembly of the vehicle. This record is shipped to the new customer via a courier company. Retain this record in the company records office for reference and safe-keeping.



## ABBREVIATIONS

|       |   |
|-------|---|
| ABLE  | Automated Bus Lane Enforcement                        |
| ABS   | Antilock Brake System                                 |
| A/C   | Air Conditioning                                      |
| ACB   | Adaptive Cruise With Braking (also Referenced As ACC) |
| ACM   | Aftertreatment Control Module                         |
| AFSS  | Automatic Fire Suppression System                     |
| APC   | Automatic Passenger Counter                           |
| ATC   | Automatic Traction Control (Bendix)                   |
| CC    | Cruise Control  |
| CECM  | Chassis Electronic Control Module                     |
| DCDL  | Driver Controlled Differential Lock                   |
| DDR   | Diagnostic Data Reader                                |
| DEF   | Diesel Exhaust Fluid                                  |
| DID   | Driver Information Display                            |
| D-MIC | Driver Microphone                                     |
| DPF   | Diesel Particulate Filter                             |
| DTC   | Diagnostic Troubleshooting Code                       |
| ECM   | Electronic Control Module                             |
| ECU   | Electronic Control Unit                               |
| EECU  | Engine Electronic Control Unit                        |
| EGR   | Exhaust Gas Recirculation                             |
| ELD   | Electronic Logging Device                             |
| ESC   | Electronic Stability Control                          |
| ESC   | Escape  |
| ESP   | Electronic Stability Program (Bendix)                 |
| E+    | Eco-Roll  |
| FCM   | Forward Collision Mitigation                          |
| FDA   | Following Distance Alert                              |
| GAW   | Gross Axle Weight                                     |
| GECU  | Gear Selector Electronic Control Unit                 |
| G-MIC | Guide Microphone                                      |
| GVW   | Gross Vehicle Weight                                  |
| HVAC  | Heating, Ventilation And Air Conditioning             |
| HUD   | Head-up Display                                       |
| IA    | Impact Alert  |
| IFS   | Independent Front Suspension                          |
| LDW   | Lane Departure Warning                                |
| LED   | Light Emitting Diode                                  |
| LLS   | Level Low System                                      |
| LPR   | License Plate Recognition                             |
| MCM   | Master Chassis Module                                 |
| MPH   | Miles Per Hour  |
| PPT   | Premium Tech Tool                                     |
| PRIME | Power Recovery By Intelligent Management Of Energy    |
| PTO   | Power Take Off  |
| SCR   | Selective Catalytic Reduction                         |

## 10-2 Abbreviations

---

|       |   |
|-------|---|
| SID   | Secondary Information Display             |
| TCM   | Transmission Control Module               |
| TCS   | Traction Control System                   |
| TECU  | Transmission Electronic Control Unit      |
| TPMS  | Tire Pressure Monitoring System           |
| TWS   | Threshold Warning System                  |
| ULSD  | Ultra Low Sulfur Diesel                   |
| VCADS | Volvo Computer Assisted Diagnostic System |
| VEB   | Volvo Engine Brake                        |
| VECF  | Vehicle Electrical Center Front           |
| VECR  | Vehicle Electrical Center Rear            |
| VECU  | Vehicle Electronic Control Unit           |
| VSS   | Video And Sound Selector                  |
| WCL   | Wheelchair Lift                           |

# APPENDIX A - SERVICE LITERATURE

**SERVICE LITERATURE** ..... 2

**NOTICE** ..... 2

DECLARATION OF THE MANUFACTURING DEFECTS TO THE GOVERNMENT OF THE UNITED STATES ..... 2

DECLARATION OF THE MANUFACTURING DEFECTS TO THE CANADIAN GOVERNMENT ..... 3

DECLARATION OF THE MANUFACTURING DEFECTS TO PREVOST ..... 3

## A-2 Service Literature

---

### SERVICE LITERATURE

Visit our web site at [www.prevostcar.com](http://www.prevostcar.com) for on-line product information and technical publications!

Additional copies of the following service literature are available on request and at low cost. These can be helpful to mechanics and drivers alike.

- Maintenance Manual
- Operator's Manual
- Parts Manual
- Service Center Directory

To order, call Prevost Parts toll free 1-800-463-8876 or write to:

#### PREVOST PARTS

2955-A Watt Street  
Sainte-Foy, (Quebec)  
Canada G1X 3W1

Specify the complete vehicle serial number (VIN). Allow 30 days for delivery

### NOTICE

#### DECLARATION OF THE MANUFACTURING DEFECTS TO THE GOVERNMENT OF THE UNITED STATES

If you believe that your vehicle has defect which could cause a crash or could cause injury or death, you should immediately inform the National Highway Traffic Safety Administration (NHTSA) in addition to notifying Prevost.

If NHTSA receives similar complaints, it may open an investigation, and if it finds that a safety defect exists in a group of vehicles, it may order a recall and remedy campaign.

However, NHTSA cannot become involved in individual problems between you, your dealer, or Prevost.

To contact NHTSA you may either call the Auto Safety Hotline toll-free at 1-800-424-9393 (or 366-0123 in Washington, D.C. area) or write to:

**NHTSA**  
**U.S. Department of Transportation**  
**Washington, D.C. 20590**

You can also obtain other information about motor vehicle safety from the Hotline.

## **DECLARATION OF THE MANUFACTURING DEFECTS TO THE CANADIAN GOVERNMENT**

If you live in Canada, and if you believe that your vehicle has a safety defect, you should immediately inform Transport Canada and Prevest. You may write to:

**Transport Canada  
Box 8880  
Ottawa, Ontario, K1G 3J2**

## **DECLARATION OF THE MANUFACTURING DEFECTS TO PREVOST**

In addition to NHTSA (or Transport Canada) notification, please contact Prevest at 1-418-831-2046. Or write to:

**Prevest  
After-sales service department  
850 ch. Olivier,  
Lévis (Quebec)  
Canada, G7A 2N1**





# APPENDIX B - MULTIPLEX TROUBLESHOOTING

MULTIPLEX TROUBLESHOOTING GUIDE ..... 2

## B-2 Multiplex Troubleshooting

### MULTIPLEX TROUBLESHOOTING GUIDE

| Problem / Symptom  | Probable Causes  | Actions   |
|--|--|---|
| Vehicle does not Start from the dashboard                          | <p>The Engine Stop pushbutton located on the rear start panel is depressed</p> <p>Main electrical shut- off switch is in the OFF position</p>  | <ol style="list-style-type: none"> <li>1. Twist and pull the Engine Stop pushbutton to place it in normal operating position, check that the main electrical shut-off switch is in the ON position and retry cranking from the ignition switch</li> <li>2. Start the vehicle from the engine compartment using the rear start button</li> </ol>   |
| Vehicle does not Start from the dashboard <i>and</i> from the rear | <p>DL0 (BBUS MUX) network problem (Multiplex)</p> <p>Module AE52 not powered or is defective</p> <p>Engine ECM does not receive the ignition signal</p> <p>Engine ECM is not powered</p> | <ol style="list-style-type: none"> <li>1. Verify that module AE52 is powered:               <ol style="list-style-type: none"> <li>a. Check the DIAGNOSTICS menu of Driver Information Display (DID). Select VIEW ACTIVE FAULTS and ELECTRICAL. The message “No Response ModA52, Active”, indicates a power problem on the module or a DL0 (BBUS MUX) network problem.</li> <li>b. Check / reset circuit breaker CB5</li> <li>c. Check / replace fuse F65</li> <li>d. Probe gray connector on module to see if it is powered.</li> </ol> </li> <li>2. Verify that the engine ECM is powered and gets the ignition signal               <ol style="list-style-type: none"> <li>a. Check / reset circuit breaker CB8 Check / replace fuse F74</li> <li>b. Check / reset circuit breaker CB2 Check / replace fuse F78</li> </ol> </li> </ol> |

## Multiplex Troubleshooting B-3

| Problem / Symptom   | Probable Causes   | Actions   |
|---|---|---|
| <p>None of the Multiplexed functions are operating, including the basic limp-home functions (door opening, flashers, wipers in speed 1)</p> <p>“FLIP REAR BREAKER TO INITIATE I/O MODULES PROGRAMMING” pop-up message appears in the DID</p> <p>Note: The sunshades are still functioning since these are not multiplexed</p> | <p>The program version in the MCM is different than the program in the I/O modules and the MCM is forcing all I/O modules to stay inactive</p>  | <ol style="list-style-type: none"> <li>1. Engage the auto-programming of the I/O modules: Turn the ignition key to the ON position, trip and reset circuit breaker CB6.</li> <li>2. The DID indicates "MUX AUTOPROGRAMMING I/O MODULE PLEASE WAIT" until the reprogramming is complete.</li> </ol>  |
| <p>Many of the non-essential secondary functions are not functioning (interior lighting, driver's area lighting, wiper speed 2 and intermittent).</p> <p>Marker lights and clearance lights are turned ON when setting ignition to the ON position.</p>   | <ol style="list-style-type: none"> <li>1. The MCM module does not receive 24 V power.</li> <li>2. The DL0 (BBUS MUX) network is not working. It could be caused by a short on the network, an open circuit, a problem with the MCM or the MCM being disconnected from the network.</li> </ol> | <ol style="list-style-type: none"> <li>1. Check / reset circuit breaker CB6. Check / replace fuse F1</li> <li>2. Operate in limp-home mode by starting the vehicle from the engine compartment (REAR START). All functions essential to drive are available</li> </ol> <p>To close and lock the door, pull the door manually up to its closed position and it will lock by itself. The door opening button is still functioning</p> |
| <p>No temperature control in the passenger area</p> <p>Passenger temperature display indicates two dashes "--"</p>  | <p>Problem with the temperature sensor located in the evaporator compartment air intake or the sensor wiring</p>  | <p>Instruct the driver to manually control the temperature by playing with the passenger set point. Set above 22°C (72°F) to heat and below 22° C (72°F) to cool</p>  |

## B-4 Multiplex Troubleshooting

| Problem / Symptom   | Probable Causes                                | Actions   |
|---|--|---|
| <p>Entrance door does not open nor close using the control buttons</p> <p>Defroster fan not functioning</p> <p>Windshield wipers not functioning in speed 1 or intermittent</p> | <p>Module AE47 is not powered or is faulty</p> | <ol style="list-style-type: none"> <li>1. Check the DIAGNOSTICS menu of Driver Information Display (DID). Select VIEW ACTIVE FAULTS and ELECTRICAL. The message "No Response ModA47, Active" indicates a power problem on the module. (A DLO (BBUS MUX) network problem would show the same message but doesn't produce these symptoms).</li> <li>2. Check / reset circuit breaker CB1</li> <li>3. Check / replace fuse F45</li> <li>4. Probe gray connector on module to see if it is powered.</li> <li>5. Use the air release valves near the entrance door and in the front service compartment to lock / unlock the door</li> </ol> |
| <p>Windshield wipers not functioning in speed 1 or intermittent</p>   | <p>No power on R27</p>                         | <p>Check CB48 (VECF)</p>  |
| <p>HVAC condenser fans not functioning in speed 1</p>   | <p>Circuit breaker CB7 tripped</p>             | <p>Check / reset circuit breaker CB7</p>  |
| <p>HVAC condenser fans not functioning in speed 2</p>   | <p>Circuit breaker CB7 tripped</p>             | <p>Check / reset circuit breaker CB7</p> <p>Check / replace fuse F135</p>   |
| <p>Windshield washer not functioning</p> <p>Windshield upper section de-icing system not functioning</p>  | <p>Module AE44 is not powered or is faulty</p> | <ol style="list-style-type: none"> <li>1. Check the DIAGNOSTICS menu of Driver Information Display (DID). Select VIEW ACTIVE FAULTS and ELECTRICAL. The message "No Response ModA44, Active" indicates a power problem on the module. (A DLO (BBUS MUX) network problem would show the same message but doesn't produce these symptoms).</li> <li>2. Check / reset circuit breaker CB1</li> <li>3. Check / replace fuse F44</li> <li>4. Probe gray connector on module to see if it is powered.</li> </ol>  |

## Multiplex Troubleshooting B-5

| Problem / Symptom   | Probable Causes                         | Actions   |
|---|---|---|
| Defroster fan is functioning but no heat or cooling available in the driver area.                             | Module AE47 is not powered or is faulty | <ol style="list-style-type: none"> <li>1. Check the DIAGNOSTICS menu of Driver Information Display (DID). Select VIEW ACTIVE FAULTS and ELECTRICAL. The message “No Response ModA47, Active” indicates a power problem on the module. (A DL0 (BBUS MUX) network problem would show the same message but doesn't produce these symptoms).</li> <li>2. Check / reset circuit breaker CB1</li> <li>3. Check / replace fuse F45</li> <li>4. Probe gray connector on module to see if it is powered.</li> </ol>  |
| <p>Low beam headlamps and front flasher on left side not functioning</p> <p>Electric horn not functioning</p> | Module AE46 is not powered or is faulty | <ol style="list-style-type: none"> <li>1. Check the DIAGNOSTICS menu of Driver Information Display (DID). Select VIEW ACTIVE FAULTS and ELECTRICAL. The message “No Response ModA46, Active” indicates a power problem on the module. (A DL0 (BBUS MUX) network problem would show the same message but doesn't produce these symptoms).</li> <li>2. Check / reset circuit breaker CB10</li> <li>3. Check / replace fuse F19</li> <li>4. Probe gray connector on module to see if it is powered.</li> </ol> |
| Low beam headlamps and flasher on right side not functioning  | Module AE48 is not powered or is faulty | <ol style="list-style-type: none"> <li>1. Check the DIAGNOSTICS menu of Driver Information Display (DID). Select VIEW ACTIVE FAULTS and ELECTRICAL. The message “No Response ModA48, Active” indicates a power problem on the module. (A DL0 (BBUS MUX) network problem would show the same message but doesn't produce these symptoms).</li> <li>2. Check / reset circuit breaker CB10</li> <li>3. Check / replace fuse F21</li> <li>4. Probe gray connector on module to see if it is powered.</li> </ol> |

## B-6 Multiplex Troubleshooting

| Problem / Symptom  | Probable Causes  | Actions   |
|--|--|---|
| <p>Rear flashers not functioning</p> <p>Stoplights and center stoplights not functioning</p> | <p>Module AE51 is not powered or is faulty</p>           | <ol style="list-style-type: none"> <li>1. Check the DIAGNOSTICS menu of Driver Information Display (DID). Select VIEW ACTIVE FAULTS and ELECTRICAL. The message "No Response ModA51, Active" indicates a power problem on the module. (A DL0 (BBUS MUX) network problem would show the same message but doesn't produce this symptom).</li> <li>2. Check / reset circuit breaker CB8</li> <li>3. Check / replace fuse F107</li> <li>4. Probe gray connector on module to see if it is powered.</li> </ol> |
| <p>Engine is overheating and radiator fans do not engage</p>                                 | <p>Module AE52 or AE49 is not powered or is faulty</p>   | <ol style="list-style-type: none"> <li>1. Check the DIAGNOSTICS menu of Driver Information Display (DID). Select VIEW ACTIVE FAULTS and ELECTRICAL. The message "No Response ModA52/ ModA49, Active" indicates a power problem on the module. (A DL0 (BBUS MUX) network problem would show the same message but doesn't produce this symptom).</li> <li>2. Check circuit breaker CB5</li> <li>3. Check / replace fuse F133, F134</li> <li>4. CB201-CB208</li> </ol>                                       |
| <p>The A/C compressor clutch does not engage</p>   | <p>Module AE54 (or AE52) is not powered or is faulty</p> | <ol style="list-style-type: none"> <li>1. Check the DIAGNOSTICS menu of Driver Information Display (DID). Select VIEW ACTIVE FAULTS and ELECTRICAL. The message "No Response ModA54, Active" indicates a power problem on the module. (A DL0 (BBUS MUX) network problem would show the same message but doesn't produce this symptom).</li> <li>2. Check / reset circuit breaker CB5</li> <li>3. Check / replace fuse F135</li> <li>4. Probe gray connector on module to see if it is powered.</li> </ol> |

## Multiplex Troubleshooting B-7

| Problem / Symptom                              | Probable Causes   | Actions   |
|--|---|---|
| Evaporator fan not functioning                 | <p>Circuit breaker CB3 tripped</p> <p>Module AE54 is not powered or is faulty</p> | <ol style="list-style-type: none"> <li>1. Check circuit breaker CB3</li> <li>2. Check relay R12</li> <li>3. Check the DIAGNOSTICS menu of Driver Information Display (DID). Select VIEW ACTIVE FAULTS and ELECTRICAL. The message “No Response ModA54, Active” indicates a power problem on the module. (A DL0 (BBUS MUX) network problem would show the same message but doesn't produce this symptom).</li> <li>4. Check / reset circuit breaker CB5</li> <li>5. Check / replace fuse F135</li> <li>6. Probe gray connector on module to see if it is powered.</li> </ol> |
| HVAC condenser fans not functioning in speed 1 | <p>Module AE54 is not powered or is faulty</p>                                    | <ol style="list-style-type: none"> <li>1. Check the DIAGNOSTICS menu of Driver Information Display (DID). Select VIEW ACTIVE FAULTS and ELECTRICAL. The message “No Response ModA54, Active” indicates a power problem on the module. (A DL0 (BBUS MUX) network problem would show the same message but doesn't produce this symptom).</li> <li>2. Check / reset circuit breaker CB5</li> <li>3. Check / replace fuse F135</li> <li>4. Check / replace fuse F141-F144</li> <li>5. Probe gray connector on module to see if it is powered.</li> </ol>                        |
| Sound system not functioning                   | <p>Circuit breaker CB11 tripped</p>   | <ol style="list-style-type: none"> <li>1. Check CB11</li> <li>2. Check / replace fuse F148, F200</li> </ol>   |

## B-8 Multiplex Troubleshooting

| Problem / Symptom  | Probable Causes   | Actions   |
|--|---|---|
| Fire alarm telltale light and audible alarm always ON and there is no fire or high temperature in the engine compartment     | Short-circuited fire sensor or defective sensor   | Prior to start the vehicle, cycle the ignition key to the ON position, OFF position and then ON position again and then start the vehicle. This will deactivate the fire alarm function. This has to be repeated each time the vehicle is restarted.  |
| The vehicle is parked and the electrical horn is activated to indicate a fire in the engine compartment but there is no fire | Short-circuited fire sensor or defective sensor   | Cycle the ignition key between the ON and OFF position twice within 3 seconds. This will deactivate the fire alarm function. This has to be repeated each time the vehicle is parked  |
| A single light, a group of LED lights or another function of the vehicle is not functioning                                  | The multiplex outputs are protected in current by an internal "soft fuse". When an output is shorted, it turns OFF and stays OFF until the "soft fuse" is reset | turn the ignition key to the OFF position and turn to the ON position again. This resets all "soft fuses"   |
| No backlighting in the instrument cluster  | Circuit breaker CB10 is tripped or fuse F10/F29 blown   | <p>Check circuit breaker CB2, CB10</p> <p>Check / replace fuse F10, F29</p> <p>Check / replace relay R22, R23</p>   |
| The radiator/CAC electric fans do not function and the engine is overheating   |   | <p>You can manually engage the radiator/CAC fans half-speed (50%) or full speed (100%).</p> <ol style="list-style-type: none"> <li>1. On the Driver Information Display, select DIAGNOSTICS menu. Select VEHICLE TESTS submenu and then FORCE RADIATOR FAN SPEED 50% or FORCE RADIATOR FAN SPEED 100%.</li> <li>2. The DID status line will show TEST to confirm the forced activation of the radiator fans. To cancel, turn the ignition switch to the OFF position or press ESCAPE button, select TERMINATE TESTS &amp; FORCED STATES submenu and then press ENTER button twice. TEST will disappear from the DID status line.</li> </ol> |



## APPENDIX B - ALLISON TRANSMISSION OTHER FEATURES

|  |           |
|--|-----------|
| <b>OIL LEVEL CHECK USING THE PUSHBUTTON SHIFT SELECTOR</b> .....                                     | <b>2</b>  |
| <b>CONTROL SYSTEM PROGNOSTICS</b> .....  | <b>3</b>  |
| NORMAL PROGNOSTICS INDICATION AT ENGINE START .....  | 3         |
| OIL LIFE MONITOR .....   | 3         |
| FILTER LIFE MONITOR .....  | 4         |
| TRANSMISSION HEALTH MONITOR .....  | 5         |
| <b>DIAGNOSTIC TROUBLESHOOTING CODES (DTC) — ALLISON 5TH GENERATION CONTROLS</b> .....                | <b>7</b>  |
| DIAGNOSTIC TROUBLESHOOTING CODES (DTC) OVERVIEW .....  | 7         |
| USING SHIFT SELECTOR FOR ACCESSING DIAGNOSTIC INFORMATION .....                                      | 7         |
| <b>DIAGNOSTIC CODE DISPLAY AND CLEARING PROCEDURE</b> .....  | <b>8</b>  |
| EXITING DIAGNOSTIC MODE .....  | 8         |
| <b>DIAGNOSTIC TROUBLE CODE RESPONSE</b> .....  | <b>9</b>  |
| <b>DIAGNOSTIC TROUBLESHOOTING CODES (DTC) LIST - ALLISON 5TH &amp; 6TH GENERATION CONTROLS</b> ..... | <b>10</b> |

## C-2 Allison Transmission Other Features

### OIL LEVEL CHECK USING THE PUSHBUTTON SHIFT SELECTOR

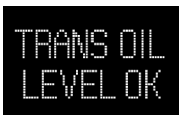
**NOTE:** You will find the complete transmission operation instructions and driving tips in the Allison 5th & 6th Generation Operator's Manual 3000\_4000 Series available on the Prevost Technical Publications site.

The oil level sensor (OLS) is standard in your transmission. With the OLS and Allison 5<sup>th</sup> & 6<sup>th</sup> generation shift selector, you can get a more accurate electronic fluid level check than with a dipstick.

Oil level codes are obtained as follows:

1. Park vehicle on a level surface, select «N» (neutral) on the pushbutton shift selector and apply parking brake.
2. Wait for at least 2 minutes to allow the oil to settle;
3. Press simultaneously the ▲ (Upshift) and ▼ (Downshift) arrow buttons once.
4. Oil level codes are displayed once the following parameters are met:
  - The vehicle has been stationary for approximately 2 minutes to allow the oil to settle;
  - Engine at idle;
  - Oil at normal operating temperature, between 104°F (40°C) and 220°F (104°C);
  - Transmission in «N» (Neutral);
  - Transmission output shaft stopped;
  - Oil level sensor present and working.

5. *Correct fluid level* is displayed as shown.



6. *Low fluid level* is displayed as shown. The number indicates the number of quarts of fluid the transmission requires.



7. *High fluid level* condition with the number of quarts in excess is displayed as shown.



#### NOTE

Confirm a low fluid level condition by making a manual fluid level check.

8. To exit the Oil Level Display Mode, press any range button «R», «N» or «D» at any time.

#### NOTE

The OLS has a detection range of LO4 to HI 3 that can display on the selectors.

The actual oil level to add may be greater than 4 liters (4.22 quarts) if the transmission is more than 4 liters (4.22 quarts) low from the full mark.

The actual fluid volume to drain may be more than 3 liters (3.17 quarts) if the transmission is overfilled by more than 3 liters (3.17 quarts).

If the fluid level check cannot be completed, an Invalid for Display fault is reported. Refer to table below to review the codes and conditions.

| CODE              | CAUSE OF FAULT CODE             |
|-------------------|---------------------------------|
| SETTLING OK       | Settling time too short         |
| ENG RPM TOO LOW   | Engine speed (rpm) too low      |
| ENG RPM TOO HIGH  | Engine speed (rpm) too high     |
| MUST BE IN NEU    | N (Neutral) must be selected    |
| OIL TEMP TOO LOW  | Sump fluid temperature too low  |
| OIL TEMP TOO HIGH | Sump fluid temperature too high |
| VEH SPD TOO HI    | Output shaft speed              |

| CODE          | CAUSE OF FAULT CODE |
|---------------|---------------------|
| SENSOR FAILED | Sensor failure      |

## CONTROL SYSTEM PROGNOSTICS

The transmission control system includes the provision for the user to monitor various transmission operating parameters. Transmission operating parameters monitored by the prognostics feature are:

- Oil Life Monitor (OM)
- Filter Life Monitor (FM)
- Transmission Health Monitor (TM)

### NOTE


*The prognostics package requires the use of **TranSynd™** or an Allison approved **TES295**, **TES668** or **TES389** licensed fluid in the transmission and **Allison High Capacity filters**.*



*If any other fluids or filters are used, Prognostic mode must be **disabled**.*

*Prognostic information will not be accurate with any other fluids or filters and could result in missed maintenance activities resulting in transmission damage.*

*Refer to **TES295**, **TES668** or **TES389 Approved Fluids list**, found under the **Service/Fluids** heading on the home page of the Allison Transmission web site.*




*[www.allisontransmission.com](http://www.allisontransmission.com)*

When a specified threshold is detected for any of the serviceable conditions, the TRANSMISSION SERVICE indicator  is illuminated to alert the operator. Failure to attend to the service condition and reset the TRANSMISSION SERVICE indicator within a defined operating period will result in illumination of the CHECK light with associated message in the DID, indicating the increased probability that the service condition will develop into a more serious condition.

To access the Prognostic Mode functions, simultaneously press the  (Upshift) and .

(Downshift) arrow buttons repeatedly. See the REFERENCE TABLE ( ) in this section.

## NORMAL PROGNOSTICS INDICATION AT ENGINE START


- A system bulb check illuminates the TRANSMISSION SERVICE indicator  approximately 0.5 seconds.
- If Prognostics features are enabled, the TRANSMISSION SERVICE indicator  illuminates again for 3 seconds after the bulb check. If Prognostics features are disabled, the TRANSMISSION SERVICE indicator  does not illuminate again after the bulb check.

## OIL LIFE MONITOR

The display message denotes the calculated remaining life of the transmission fluid. This value is based on the established life for the required baseline fluid, and then is continuously adjusted for cumulative effects of such operating parameters as operating time, retarder operation, output shaft revolutions and shift frequency.

### Display

The display is a two-digit number, denoting percentage of the fluid life which remains. New fluid is displayed as 99%.

The TRANSMISSION SERVICE indicator  will be illuminated, denoting a required change of transmission fluid, when the remaining fluid life reaches approximately 1 %. The indicator will be lit steadily upon each initialization of the TCM, and will remain on steady for approximately 2 minutes after the first selection of "D" (drive) range each time, until service is performed and the indicator is reset.

Failure to perform maintenance and reset the TRANSMISSION SERVICE indicator within a defined period will result in the illumination of the CHECK light with associated message in the DID and diagnostic code P0897 Transmission Fluid Deteriorated.

## C-4 Allison Transmission Other Features

### Reset

The TRANSMISSION SERVICE indicator can be reset by a message over the SAE J1939 communication interface, with the Allison DOC™ for PC diagnostic program, or by depressing and holding the MODE button for ten (10) seconds while the Oil Life Monitor function is displayed. It may also be reset by selecting N-D-N-D-N-R-N on the shift selector, pausing briefly (less than 3 seconds) between each selector movement, with the ignition ON and the engine not running. The TRANSMISSION SERVICE indicator illuminates briefly following a reset to acknowledge the reset was successful.

### Setting Fluid Type For Prognostics

The fluid type can be programmed if the specific calibration allows it. The operator can do the following:

With the engine off and the ignition on, perform the following sequence on the selector, N-R-N-D-N-R-N-D-N-R-N-D-N.

The TRANSMISSION SERVICE indicator flashes if TES389 is the current setting and illuminates solidly if TES295 or TES668 is the current setting. To change the transmission fluid type, wait 5 seconds after entering transmission fluid type mode and perform the following sequences to select the proper transmission type:

N-R-N to select TES295 or TES668

N-D-N to select TES389

The selector exits 30 seconds after entering transmission fluid type mode or the ignition may be turned off to exit earlier. Only one transmission fluid type selection may be made after entering transmission fluid type mode. All other attempts will be ignored. Transmission fluid type mode needs to be entered again if the wrong type of fluid is selected.



### CAUTION

Verify prognostic fluid type setting matches transmission fluid type. Oil Life Monitor notifications will be inaccurate when mismatched. This could result in transmission damage from running a TES389 fluid too long or cause shortened TES295/TES668 fluid changes to occur.



### CAUTION


Required calendar-based oil & filter change intervals (based on months) still apply because Oil Life Monitor function cannot measure time while ignition power is OFF.

If the Oil Life Monitor function has not indicated the need for a fluid change before 60 months have passed when using TES295/TES668 fluid type or before 24 months have passed when using TES389 fluid type, it will be necessary to change the fluid and filters per calendar requirements and reset the system.


### FILTER LIFE MONITOR


This feature provides an alert when the transmission's fluid filters need to be replaced. It helps extend filter change intervals to reduce routine maintenance downtime while providing maximum protection for the transmission.

The filter life indicator pressure switch signals the transmission control module when fluid exiting the main filter drops below a predetermined pressure.

*Both the main and lube filters must be changed* when the TRANSMISSION SERVICE indicator  shows the main filter should be changed.

### Filter Change Notification

The TRANSMISSION SERVICE indicator  will flash for 2 minutes after the first selection of "D" (drive) range. Once the Filter Monitor mode has been accessed via the shift selector, the "OIL FILTER OK" or "REPLACE FILTERS" message is displayed in the selector display window. An acceptable filter life status is displayed as "OIL FILTER OK". An unacceptable filter life status is displayed as "REPLACE FILTERS".


Once the programmed threshold for maximum filter pressure drop has been observed and verified, the diagnostic code P088A Transmission Filter Maintenance Alert will be recorded to indicate that the filter has reached the end of its designed life. At the next initialization of the TCM, the TRANSMISSION SERVICE indicator  will flash for 2 minutes after the first selection of "D" (drive) range. Thereafter, the indicator will illuminate and flash upon each TCM initialization, continuing to flash for 2 minutes after the first

selection of a drive range each time, until service is performed and the indicator is reset.

Failure to perform maintenance and reset the monitor after a calibration-defined number of warnings will result in the illumination of the CHECK light with associated message in the DID and diagnostic code P088B will be recorded to indicate a highly deteriorated filter.

### Read And Reset Filter Life Monitor From Selector

To enter the filter life monitor, press simultaneously the ▲ (Upshift) and ▼ (Downshift) arrows three times. An acceptable filter life status is displayed as "OIL FILTER OK". An unacceptable filter life status is displayed as "REPLACE FILTERS".

The feature will reset automatically when the main fluid filter has been changed and the pressure drop across the filter no longer exceeds the threshold value. A manual reset can be performed by depressing and holding the MODE button for ten (10) seconds while the Filter Life Monitor function is displayed. It may also be reset by selecting N-R-N-R-N-D-N on the shift selector, pausing briefly (less than 3 seconds) between each selector movement, with the ignition ON and the engine not running. The TRANSMISSION SERVICE indicator  illuminates briefly following a reset to acknowledge the reset was successful.

## TRANSMISSION HEALTH MONITOR

This prognostic feature determines clutch life status of the transmission's clutches and alerts you when clutch maintenance is required. The clutch life status is determined by monitoring changes and the calculated running clearance of the transmission clutches.

### Clutch Maintenance Notification

The transmission health monitor feature determines when clutch maintenance is needed. If any of the clutches (except lockup) reaches a remaining life of approximately 10% or if any of the clutch running clearances exceeds a maximum value, then the TRANSMISSION SERVICE indicator is steadily illuminated from just after ignition on until ignition is turned off. Thereafter, the indicator will be lit upon each initialization of the TCM, and will remain on steady during all vehicle operation until service is

performed and the indicator is reset. If the transmission health monitor mode has been accessed via the shift selector, a "TRANS HEALTH OK" or "TRANS HEALTH LO" is displayed. An acceptable clutch life status is displayed as "TRANS HEALTH OK". An unacceptable clutch life status is displayed as "TRANS HEALTH LO".

## C-6 Allison Transmission Other Features

### Read And Reset Transmission Health Monitor From Selector

To enter the transmission health monitor, press simultaneously the ▲ (Upshift) and ▼ (Downshift) arrows four times. An acceptable clutch life status is displayed as “TRANS HEALTH OK”. An unacceptable clutch life status is displayed as “TRANS HEALTH LO”.

The feature will reset automatically upon elimination of the clutch clearance condition which initiated it. The indicator can also be manually reset using the Allison DOC™ for PC diagnostics program if necessary.

#### REFERENCE TABLE

| ▲ (Upshift) & ▼ (Downshift) arrow buttons pressed simultaneously * | Description  | Message                 |                         |
|--|--|-------------------------|-------------------------|
| 1 <sup>st</sup> press  | Allison transmission oil level check                                 |                         |                         |
| 2 <sup>nd</sup> press  | Oil Life Monitor   | " O "                   | " M "                   |
|  | Oil life remaining will range from 99% down to 00%                   | Some number from 9 to 0 | Some number from 9 to 0 |
| 3 <sup>rd</sup> press  | Filter Life Monitor  | " F "                   | " M "                   |
|  | Present life of filter is acceptable                                 | OIL FILTER OK           |                         |
|  | Present life of filter is unacceptable                               | REPLACE FILTERS         |                         |
| 4 <sup>th</sup> press  | Transmission Health Monitor  | " T "                   | " M "                   |
|  | An acceptable clutch life status is displayed as “TRANS HEALTH OK”   | TRANS HEALTH OK         |                         |
|  | An unacceptable clutch life status is displayed as “TRANS HEALTH LO” | TRANS HEALTH LO         |                         |
| 5 <sup>th</sup> press  | Display of diagnostic codes  |                         |                         |

\* With the engine off and ignition on.

## DIAGNOSTIC TROUBLESHOOTING CODES (DTC) — ALLISON 5TH GENERATION CONTROLS

Diagnostic features are provided with the transmission control system to assist in troubleshooting of malfunctions and/or the monitoring of specific operating parameters.

**NOTE:** You will find the complete transmission operation instructions and driving tips in the Allison 5th & 6th Generation Operator's Manual 3000\_4000 Series available on the [Prevost Technical Publications site](#)

### DIAGNOSTIC TROUBLESHOOTING CODES (DTC) OVERVIEW

When a control system malfunction is detected, a series of Diagnostic Trouble Codes (DTCs) are used to identify and clarify the nature of the malfunction. These DTCs are each named by a 5 character alphanumeric string that refers to a diagnostic algorithm running pass/fail tests to help identify a malfunction in the transmission or vehicle operation. Most DTCs have some kind of diagnostic response that the operator notices, such as an illuminated CHECK light, selector display change, lock in range, or inhibit shifts condition.

DTCs are logged in the Transmission Control Module (TCM) memory by severity and by their active/inactive status with the most severe and active codes listed first. A maximum of five DTCs (numbered d1- d5) from most recent to oldest may be read from the shift selector. As DTCs are added, the oldest inactive DTC (historic) is dropped from the list. If all DTCs are active, the DTC with the lowest priority is dropped from the list.

An active code is any code that is current in the TCM decision-making process and has failed the DTC test(s) associated with that specific diagnostic algorithm. Historical codes, which are by definition inactive, are codes that are no longer failing their algorithm but are retained in the TCM in order to help the technician analyze possible causes and provide them direction if the vehicle is brought in before they are cleared from the queue.

DTCs can be cleared manually by the operator or they clear automatically from last (d5) to first (d1) in the queue after a number of engine starts, without becoming active again.

### USING SHIFT SELECTOR FOR ACCESSING DIAGNOSTIC INFORMATION

DTCs can be displayed on the display portion of the shift selector. A DTC is either active or historic. An active DTC is a DTC that is current in the TCM decision-making process. Historic DTCs are retained in the TCM memory and do not necessarily affect the TCM decision-making process.

#### Display Sequence

Up to five DTCs may be displayed one at a time from the selector once the diagnostic display mode has been initiated by the operator. Each DTC is 5 characters in length. The DTC status active or inactive is shown below the DTC.



Shows active DTC P0730

The operator presses the MODE button to read the next DTC in the queue (if any) or requests to exit diagnostics mode. The diagnostic mode times out and returns the selector to normal operating mode after approximately 10 minutes of operator inactivity.

## C-8 Allison Transmission Other Features

---

### DIAGNOSTIC CODE DISPLAY AND CLEARING PROCEDURE

Diagnostic codes can be read and cleared by two methods:

- Using an Allison DOC™ diagnostic tool. For specific instructions on how to use an Allison DOC™ diagnostic tool, refer to the User Guide.
- Using the pushbutton shift selector.

To begin the diagnostic process:

1. Bring the vehicle to a stop at a safe location.
2. Apply the parking brake.

To display stored codes:

1. Simultaneously press the ▲ (Upshift) and ▼ (Downshift) arrow buttons five times (Prognostics enabled) to access the Diagnostic Display Mode. With Prognostics disabled, press the ▲ (Upshift) and ▼ (Downshift) arrow buttons twice.
2. Press the MODE button to read the next code in the queue, if any.

To clear all active stored codes:

While in Diagnostic Mode, clear all active codes by pressing and holding the MODE button for approximately three seconds until the MODE message flashes. Release the MODE button. The MODE message should not remain illuminated if the active DTC shown in the display has cleared.

While in Diagnostic Mode, press and hold the MODE button for 10 seconds to clear both active codes and inactive codes. The MODE message flashes a second time indicating all codes are cleared from the queue.

### EXITING DIAGNOSTIC MODE

Exit the diagnostic mode by one of the following methods:

1. Press simultaneously the ▲ (Upshift) and ▼ (Downshift) arrow buttons at the same time on the push button shift selector.
2. Press any range button «D», «N» or «R» on the push button shift selector.
3. After approximately 10 minutes of inactivity at the push button shift selector, the diagnostic mode automatically exits and returns to normal operating mode.
4. Turn off power to the TCM (shut off the engine using the ignition key).

|  |
|--|
| <b>NOTE</b>  |
| <i>Be sure to record all codes displayed before they are cleared. This is essential for troubleshooting.</i> |



**NOTE**

*If clearing a code while locked in a «D» (Drive) or «R» (Reverse) position (fail-to-range), the transmission will still be in «D» (Drive) or «R» (Reverse) when the clearing procedure is completed. «N» (Neutral) must be manually selected.*

**DIAGNOSTIC TROUBLE CODE RESPONSE**

The electronic control system is programmed to inform the operator of a problem with the transmission system via the CHECK light and shift selector display while it automatically takes action to protect the operator, vehicle, and transmission. When the Transmission Control Module (TCM) flags a Diagnostic Trouble Code (DTC) as active, the TCM may take a combination of diagnostic responses as listed in the table below.

| RESPONSE CATEGORY              | ACTIONS TAKEN  |
|--------------------------------|--|
| DNS - Do Not Shift             | Release lock up (LU) clutch and inhibit lock up operation.<br>Inhibit shifts from the current attained range.<br>Turn on the CHECK light.<br>Display the current attained range in the MONITOR window of the shift selector.<br>Blank the SELECT window of the shift selector.<br>Ignore any range selection inputs from the shift selector. |
| SOL OFF - Solenoid OFF         | All solenoids are commanded off, resulting in hydraulic default operation of the transmission – PCS1 & PCS2 are on hydraulically when off electrically.  |
| RPR - Return to Previous Range | When the speed sensor ratio or PS1 tests do not pass, the TCM commands the same range as commanded before the shift.   |
| NNC - Neutral No Clutches      | When certain speed sensor ratio or PS1 tests do not pass, the TCM commands a neutral condition with no clutches applied.   |
| DNA - Do Not Adapt             | The TCM stops adaptive shift control while the code is active.   |

## C-10 Allison Transmission Other Features

### DIAGNOSTIC TROUBLESHOOTING CODES (DTC) LIST - ALLISON 5<sup>TH</sup> & 6<sup>TH</sup> GENERATION CONTROLS

| DTC    | Description  | CHECK Light | Inhibited Operation Description   |
|--------|--|-------------|---|
| C1312  | Retarder Request Sensor Failed Low                     | No          | May inhibit retarder operation if not using J1939 datalink  |
| C1313  | Retarder Request Sensor Failed High                    | No          | May inhibit retarder operation if not using J1939 datalink  |
| P0122  | Pedal Position Sensor Circuit Low Voltage              | No          | Use default throttle values. Freezes shift adapts.  |
| P0123  | Pedal Position Sensor Circuit High Voltage             | No          | Use default throttle values. Freezes shift adapts.  |
| P0218  | Transmission Fluid Over Temperature                    | Yes         | Use default sump temp   |
| P0562  | System Voltage Low                                     | No          | Inhibit TCC Operation, DNA  |
| P060C  | Internal Control Module Main Processor Performance     | Yes         | TCM returns to the boot program, Transmission operates in hydraulic default: N (Neutral), 3 (Third Range), 4 (Fourth Range) and 5 (Fifth Range) |
| P0600  | Internal Serial Peripheral Interface (SPI) Diagnostics | Yes         | Transmission operates in hydraulic default: N (Neutral), 3 (Third Range), 4 (Fourth Range) and 5 (Fifth Range)                                  |
| P0602  | TCM Not Programmed                                     | Yes         | Lock in Neutral   |
| P0603  | Internal Control Module Keep Alive Memory Error        | Yes         | Lock in Neutral   |
| P0604  | Control module random access memory (RAM)              | Yes         | TCM returns to the boot Program, Transmission operates in hydraulic default: N (Neutral), 3 (Third Range), 4 (Fourth Range) and 5 Fifth Range)  |
| P0607  | Control Module Performance                             | No          | Use alternate DSS data  |
| P0610* | Transmission Control Hardware Incompatible             | Yes         | No Range Inhibit Use Learned TID Level  |
| P0614  | Torque Control Data Mismatch ECM/TCM                   | Yes         | Allows operation only in reverse and second range.  |
| P0634  | TCM Internal Temperature Too High                      | Yes         | SOL OFF (hydraulic default)   |
| P0642  | Sensor Reference Voltage "A" Circuit Low               | Yes         | Default sensor data used  |
| P0643  | Sensor Reference Voltage "A" Circuit High              | Yes         | Default sensor data used  |

## Allison Transmission Other Features C-11

| DTC    | Description   | CHECK Light | Inhibited Operation Description  |
|--------|---|-------------|--|
| P0652  | Sensor Reference Voltage "B" Circuit Fault                | Yes         | NonE   |
| P0657  | Actuator Supply Circuit Voltage 1 Open (HSD 1)            | Yes         | SOL OFF, DNA, Inhibit TCC operation, Inhibit main modulation   |
| P0658  | Actuator Supply Voltage 1 (HSD1) Low                      | Yes         | DNS, SOL OFF (hydraulic default)   |
| P0659  | Actuator Supply Voltage 1 (HSD1) High                     | Yes         | DNS, SOL OFF (hydraulic default)   |
| P0702* | Transmission Control Hardware Not Determined              | Yes         | No Range Inhibit Use Current Key-Cycle TID Level   |
| P0703  | Brake Switch Circuit Malfunction                          | No          | No Neutral to Drive shifts for refuse packer. TCM inhibits retarder operation if a TPS code is also active.                                      |
| P0708  | Transmission Range Sensor Circuit High Input              | Yes         | Ignore defective strip selector inputs   |
| P070C  | Transmission Fluid Level Sensor Circuit – Low Input       | No          | None   |
| P070D  | Transmission Fluid Level Sensor Circuit – High Input      | No          | None   |
| P0711  | Transmission Fluid Temperature Sensor Circuit Performance | Yes         | Use default sump temp  |
| P0712  | Transmission Fluid Temperature Sensor Circuit Low Input   | Yes         | Use default sump temp  |
| P0713  | Transmission Fluid Temperature Sensor Circuit High Input  | Yes         | Use default sump temp  |
| P0715  | Turbine Shaft Speed Sensor Circuit                        | Yes         | DNS, Lock in current range   |
| P0716  | Turbine Shaft Speed Sensor Circuit Performance            | Yes         | DNS, Lock in current range   |
| P0717  | Turbine Shaft Speed Sensor Circuit No Signal              | Yes         | DNS, Lock in current range   |
| P071A  | Neutral at Stop Input Failed On                           | No          | Neutral at Stop operation  |
| P071D  | General Purpose Input Fault                               | Yes         | None   |
| P0720  | Output Shaft Speed Sensor Circuit                         | Yes         | Shift not in process, LIR Shift in process, complete shift then LIR. TCM forces VMMS off. TCM inhibits TCC engagement. TCM freezes shift adapts. |

## C-12 Allison Transmission Other Features

| DTC   | Description                                       | CHECK Light | Inhibited Operation Description   |
|-------|---|-------------|---|
| P0721 | Output Shaft Speed Sensor Circuit Performance     | Yes         | TCM freezes shift adapts. TCM inhibits TCC engagement.                            |
| P0722 | Output Speed Sensor Circuit No Signal             | Yes         | TCM freezes shift adapts. TCM inhibits TCC engagement. DNS, Lock in current range |
| P0725 | Engine Speed Sensor Circuit                       | No          | Default to turbine speed  |
| P0726 | Engine Speed Sensor Circuit Performance           | No          | Default to turbine speed  |
| P0727 | Engine Speed Sensor Circuit No Signal             | No          | Default to turbine speed  |
| P0729 | Incorrect 6 <sup>th</sup> Gear Ratio              | Yes         | DNS, Attempt 5 <sup>th</sup> , then 3 <sup>rd</sup>                               |
| P0731 | Incorrect 1 <sup>st</sup> Gear ratio              | Yes         | DNS, Attempt 2 <sup>nd</sup> , then 5 <sup>th</sup>                               |
| P0732 | Incorrect 2 <sup>nd</sup> Gear ratio              | Yes         | DNS, Attempt 3 <sup>rd</sup> , then 5 <sup>th</sup>                               |
| P0733 | Incorrect 3 <sup>rd</sup> Gear ratio              | Yes         | DNS, Attempt 4 <sup>th</sup> , then 6 <sup>th</sup>                               |
| P0734 | Incorrect 4 <sup>th</sup> Gear ratio              | Yes         | DNS, Attempt 5 <sup>th</sup> , then 3 <sup>rd</sup>                               |
| P0735 | Incorrect 5 <sup>th</sup> Gear ratio              | Yes         | DNS, Attempt 6 <sup>th</sup> , then 3 <sup>rd</sup> , then 2 <sup>nd</sup>        |
| P0736 | Incorrect Reverse Gear ratio                      | Yes         | DNS, Lock in Neutral  |
| P0741 | Torque Converter Clutch System Stuck Off          | Yes         | None  |
| P0752 | Shift Solenoid 1 Valve Performance-Stuck On       | Yes         | DNS   |
| P0776 | Pressure Control Solenoid (PCS) 2 Stuck Off       | Yes         | DNS, RPR  |
| P0777 | Pressure Control Solenoid 2 Stuck On              | Yes         | DNS, RPR  |
| P077F | Incorrect Reverse 2 Ratio                         | Yes!        | DNS, Lock in Neutra   |
| P07CE | Neutral At Stop Not Functioning                   | No          | TCM inhibits Neutral at Stop operation  |
| P0796 | Pressure Control Solenoid 3 Stuck Off             | Yes         | DNS, RPR  |
| P0797 | Pressure Control Solenoid 3 Stuck On              | Yes         | DNS, RPR  |
| P0842 | Transmission Fluid Pressure Switch 1 Circuit Low  | Yes         | DNS, Lock in current range  |
| P0843 | Transmission Fluid Pressure Switch 1 Circuit High | Yes         | DNS, Lock in current range  |
| P0847 | Transmission Fluid Pressure Switch 2 Circuit Low  | Yes         | None  |
| P0848 | Transmission Fluid Pressure Switch 2 Circuit High | Yes         | None  |
| P085D | Gear Shift Module 1 Performance                   | Yes         | Lock in Neutral   |

## Allison Transmission Other Features C-13

| DTC   | Description   | CHECK Light | Inhibited Operation Description   |
|-------|---|-------------|---|
| P085E | Gear Shift Module 1 Performance al                      | Yes         | Lock in Neutral   |
| P088A | Transmission Fluid Filter Maintenance Alert             | No          | None  |
| P088B | Transmission Fluid Filter Maintenance Required          | No          | None  |
| P0880 | TCM Power Input Signal                                  | No          | None  |
| P0881 | TCM Power Input Signal Performance                      | No          | None  |
| P0882 | TCM Power Input Signal Low                              | Yes         | DNS, SOL OFF (hydraulic default)  |
| P0883 | TCM Power Input Signal High                             | No          | None  |
| P0894 | Unexpected Mechanical Gear Disengagement                | Yes         | DNS, Lock in first  |
| P0897 | Transmission Fluid Deteriorated                         | No          | None  |
| P0960 | Main Pressure Modulator Solenoid Control Circuit Open   | Yes         | None  |
| P0961 | Main Pressuer Modulation Solenoid System Performance    | No          | Full Main Pressure is Commanded   |
| P0962 | Main Pressure Modulator Solenoid Control Circuit Low    | Yes         | DNS, SOL OFF (hydraulic default)  |
| P0963 | Main Pressure Modulator Solenoid Control Circuit High   | Yes         | None  |
| P0964 | Pressure Control Solenoid 2 (PCS2) Control Circuit Open | Yes         | DNS, SOL OFF (hydraulic default)  |
| P0965 | Pressure Control Solenoid (PCS2) System Performance     | Yes         | TCM forces VMM off, TCM inhibits TCC engagement. Hydraulic default: N (Neutral)3 (Third Range)4 (Fourth Range)5 (Fifth Range) |
| P0966 | Pressure Control Solenoid 2 (PCS2) Control Circuit Low  | Yes         | DNS, SOL OFF (hydraulic default)  |
| P0967 | Pressure Control Solenoid 2 (PCS2) Control Circuit High | Yes         | DNS, SOL OFF (hydraulic default)  |
| P0968 | Pressure Control Solenoid 3 (PCS3) Control Circuit Open | Yes         | DNS, SOL OFF (hydraulic default)  |
| P0969 | Pressure Control Solenoid (PCS3) System Performance     | Yes         | TCM forces VMM off, TCM inhibits TCC engagement.  |
| P0970 | Pressure Control Solenoid 3 (PCS3) Control Circuit Low  | Yes         | DNS, SOL OFF (hydraulic default)  |
| P0971 | Pressure Control Solenoid 3 (PCS3) Control Circuit High | Yes         | DNS, SOL OFF (hydraulic default)  |

## C-14 Allison Transmission Other Features

| DTC   | Description  | CHECK Light | Inhibited Operation Description                              |
|-------|--|-------------|--|
| P0973 | Shift Solenoid 1 (SS1) Control Circuit Low             | Yes         | DNS, SOL OFF (hydraulic default)                             |
| P0974 | Shift Solenoid 1 (SS1) Control Circuit High            | Yes         | DNS, SOL OFF (hydraulic default)                             |
| P0976 | Shift Solenoid 2 (SS2) Control Circuit Low             | Yes         | 7-speed: Allow 2 through 6, N, R<br>Inhibit TCC operation    |
| P0977 | Shift Solenoid 2 (SS2) Control Circuit High            | Yes         | 7-speed: Allow 2 through 6, N, R                             |
| P097A | Shift Solenoid 1 (SS1) Control Circuit Open            | Yes         | Lock in range  |
| P097B | Shift Solenoid 2 (SS2) Control Circuit Open            | Yes         | 7-speed: Allow 2 through 6, N, R                             |
| P0989 | Retarder Pressure Sensor Circuit Low                   | No          | None   |
| P0990 | Retarder Pressure Sensor Circuit High                  | No          | None   |
| P1739 | Incorrect Low Gear Ratio                               | Yes         | Command 2 <sup>nd</sup> and allow shifts 2 through 6, N, R   |
| P1790 | Gear Shift Module 1 Calibrated Invalid                 | Yes         | Shift selector language or units incorrect                   |
| P1791 | Gear Shift Module 2 Calibrated Invalid                 | Yes         | Shift selector language or units incorrect                   |
| P1891 | Throttle Position Sensor PWM Signal Low                | No          | Use default throttle values                                  |
| P1892 | Throttle Position Sensor PWM Signal High               | No          | Use default throttle values                                  |
| P2184 | Engine Coolant Temperature Sensor 2 Circuit Low Input  | No          | Use default engine coolant values                            |
| P2185 | Engine Coolant Temperature Sensor 2 Circuit High Input | No          | Use default engine coolant values                            |
| P2637 | Torque Management Feedback Signal (A)                  | Yes         | Inhibit SEM  |
| P2641 | Torque Management Feedback Signal (B)                  | Yes         | Inhibit LRTP   |
| P2669 | Actuator Supply Circuit Voltage 2 Open (HSD2)          | Yes         | SOL OFF, Inhibit TCC operation, Inhibit Main modulation, ONA |
| P2670 | Actuator Supply Voltage 2 (HSD2) Low                   | Yes         | DNS, SOL OFF (hydraulic default)                             |
| P2671 | Actuator Supply Voltage 2 (HSD2) High                  | Yes         | DNS, SOL OFF (hydraulic default)                             |

## Allison Transmission Other Features C-15

| DTC   | Description  | CHECK Light | Inhibited Operation Description  |
|-------|--|-------------|--|
| P2684 | Actuator Supply Circuit Voltage 3 Open (HSD3)                  | Yes         | SOL OFF, Inhibit TCC operation, Inhibit Main modulation, ONA   |
| P2685 | Actuator Supply Voltage 3 (HSD3) Low                           | Yes         | DNS, SOL OFF (hydraulic default)   |
| P2686 | Actuator Supply Voltage 3 (HSD3) High                          | Yes         | DNS, SOL OFF (hydraulic default)   |
| P27B2 | Internal Control Module Transmission Range Control Performance | Yes         | Hydraulic default. Transmission is restricted to N (Neutral)3 (Third Range)4 (Fourth Range)5 (Fifth Range)                                       |
| P27B4 | Output Shaft Direction Plausibility                            | Yes         | Shift not in process, LIR Shift in process, complete shift then LIR. TCM forces VMMS off. TCM inhibits TCC engagement. TCM freezes shift adapts. |
| P27B6 | Internal Control Module Transmission Speed Sensor Performance  | Yes         | Shift not in process, LIR Shift in process, complete shift then LIR. TCM forces VMMS off. TCM inhibits TCC engagement. TCM freezes shift adapts. |
| P2714 | Pressure Control Solenoid 4 (PCS4) Stuck Off                   | Yes         | DNS, RPR   |
| P2715 | Pressure Control Solenoid 4 (PCS4) Stuck On                    | Yes         | DNS, SOL OFF (hydraulic default)   |
| P2718 | Pressure Control Solenoid 4 (PCS4) Control Circuit Open        | Yes         | DNS, SOL OFF (hydraulic default)   |
| P2719 | Pressure Control Solenoid (PCS) 4 System Performance           | Yes         | TCM forces VMM off, TCM inhibits TCC engagement  |
| P2720 | Pressure Control Solenoid 4 (PCS4) Control Circuit Low         | Yes         | DNS, SOL OFF (hydraulic default)   |
| P2721 | Pressure Control Solenoid 4 (PCS4) Control Circuit High        | Yes         | DNS, SOL OFF (hydraulic default)   |
| P2723 | Pressure Control Solenoid 1 (PCS1) Stuck Off                   | Yes         | DNS, RPR   |
| P2724 | Pressure Control Solenoid 1 (PCS1) Stuck On                    | Yes         | DNS, RPR   |
| P2727 | Pressure Control Solenoid 1 (PCS1) Control Circuit Open        | Yes         | DNS, SOL OFF (hydraulic default)   |
| P2728 | Pressure Control Solenoid (PCS) 1 System Performance           | Yes         | TCM forces VMM off, TCM inhibits TCC engagement. Hydraulic default: N (Neutral)3 (Third Range)4 (Fourth Range)5 (Fifth Range)                    |

## C-16 Allison Transmission Other Features

| DTC   | Description  | CHECK Light | Inhibited Operation Description  |
|-------|--|-------------|--|
| P2729 | Pressure Control Solenoid 1 (PCS1) Control Circuit Low               | Yes         | DNS, SOL OFF (hydraulic default)   |
| P2730 | Pressure Control Solenoid 1 (PCS1) Control Circuit High              | Yes         | DNS, SOL OFF (hydraulic default)   |
| P2736 | Pressure Control Solenoid 5 (PCS5) Control Circuit Open              | Yes         | Inhibit retarder operation   |
| P2738 | Pressure Control Solenoid 5 (PCS5) Control Circuit Low               | Yes         | Allow 2 through 6, N, R. Inhibit retarder and TCC operation  |
| P2739 | Pressure Control Solenoid 5 (PCS5) Control Circuit High              | Yes         | Inhibit retarder operation   |
| P273F | Retarder Oil Temperature Sensor Over Temperature Condition           | No          | None   |
| P2742 | Retarder Oil Temperature Sensor Circuit – Low                        | No          | Use default retarder temp values   |
| P2743 | Retarder Oil Temperature Sensor Circuit – High                       | No          | Use default retarder temp values   |
| P2761 | TCC PCS Control Circuit Open   | Yes         | Inhibit TCC operation  |
| P2763 | TCC PCS Control Circuit High   | Yes         | Inhibit TCC operation  |
| P2764 | TCC PCS Control Circuit Low  | Yes         | 7-speed: Allow 2 through 6, N, R. Inhibit TCC operation  |
| P2789 | Transmission Clutch Life Expired (Clutch Adaptive Learning at Limit) | No          | None   |
| P2793 | Gear Shift Direction Circuit   | Yes         | *Ignores PWM input from shift selector<br>**Depending on OEM configuration, may or may not allow direction changes during faults |
| P2808 | Pressure Control Solenoid 6 (PCS6) Stuck Off                         | Yes         | DNS, RPR   |
| P2809 | Pressure Control Solenoid 6 (PCS6) Stuck On                          | Yes         | DNS, RPR   |
| P2812 | Pressure Control Solenoid 6 (PCS6) Control Circuit Open              | Yes         | DNS, SOL OFF (hydraulic default)   |
| P2813 | Pressure Control Solenoid (PCS) 6 System Performance                 | Yes         | TCM forces VMM off, TCM inhibits TCC engagement  |



## Allison Transmission Other Features C-17

| DTC   | Description   | CHECK Light | Inhibited Operation Description  |
|-------|---|-------------|--|
| P2814 | Pressure Control Solenoid 6 (PCS6) Control Circuit Low          | Yes         | DNS, SOL OFF (hydraulic default)   |
| P2815 | Pressure Control Solenoid 6 (PCS6) Control Circuit High         | Yes         | DNS, SOL OFF (hydraulic default)   |
| U0073 | CAN Communication Bus 1 Off                                     | No          | Use default values   |
| U0074 | CAN Communication Bus 2 Off                                     | No          | Use default values   |
| U0100 | Lost Communications with ECM A                                  | Yes         | Use default values   |
| U0103 | Lost Communication with Gear Shift Module (Shift Selector) 1    | Yes         | *Maintain range selected, observe gear shift direction circuit<br>**Depending on OEM configuration, may or may not allow direction changes during faults |
| U0291 | Lost Communication with Gear Shift Module (Shift Selector) 2    | Yes         | *Maintain range selected, observe gear shift direction circuit<br>**Depending on OEM configuration, may or may not allow direction changes during faults |
| U0304 | Incompatible Gear Shift Module 1 (Shift Selector)               | Yes         | Ignore shift selector inputs   |
| U0333 | Incompatible Gear Shift Module 2 (Shift Selector)               | Yes         | Ignore shift selector inputs   |
| U0400 | Invalid Communication Link Data Received (J1939 Brake Switch)   | Yes         | None   |
| U0404 | Invalid Data Received From Gear Shift Module (Shift Selector) 1 | Yes         | *Maintain range selected, observe gear shift direction circuit<br>**Depending on OEM configuration, may or may not allow direction changes during faults |
| U0592 | Invalid Data Received From Gear Shift Module (Shift Selector) 2 | Yes         | *Maintain range selected, observe gear shift direction circuit<br>**Depending on OEM configuration, may or may not allow direction changes during faults |

## C-18 Allison Transmission Other Features

---

| DTC   | Description  | CHECK Light | Inhibited Operation Description |
|-------|--|-------------|---------------------------------|
| U1401 | J1939 TSC1 Engine Message Impostor Detected            |             | None                            |
| U1402 | J1939 TSC1 Compression Brake Message Impostor Detected |             | None                            |
| U1403 | J1939 TSC1 Exhaust Brake Message Imposter Detected     |             | None                            |

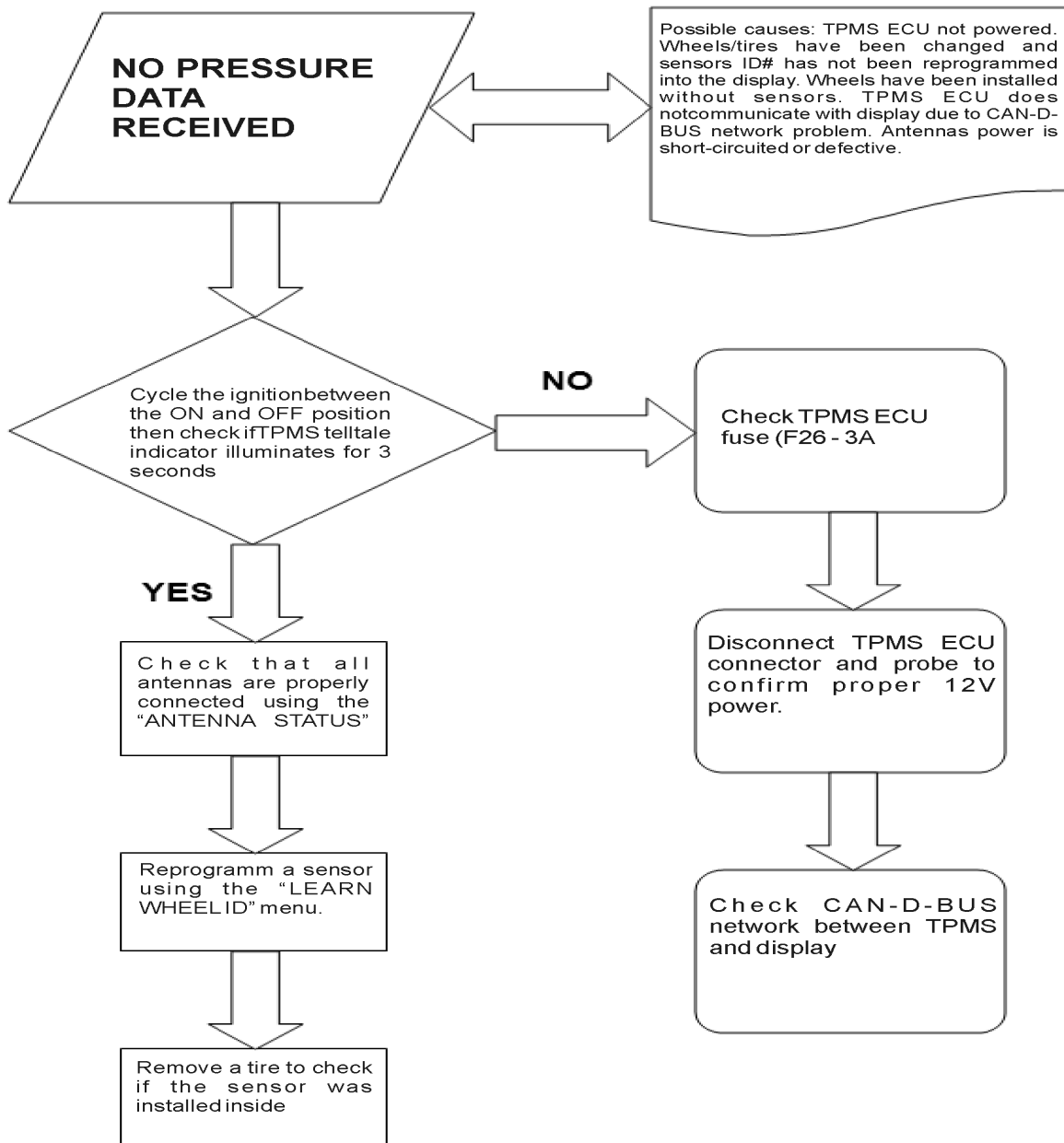
\*5th Generation only

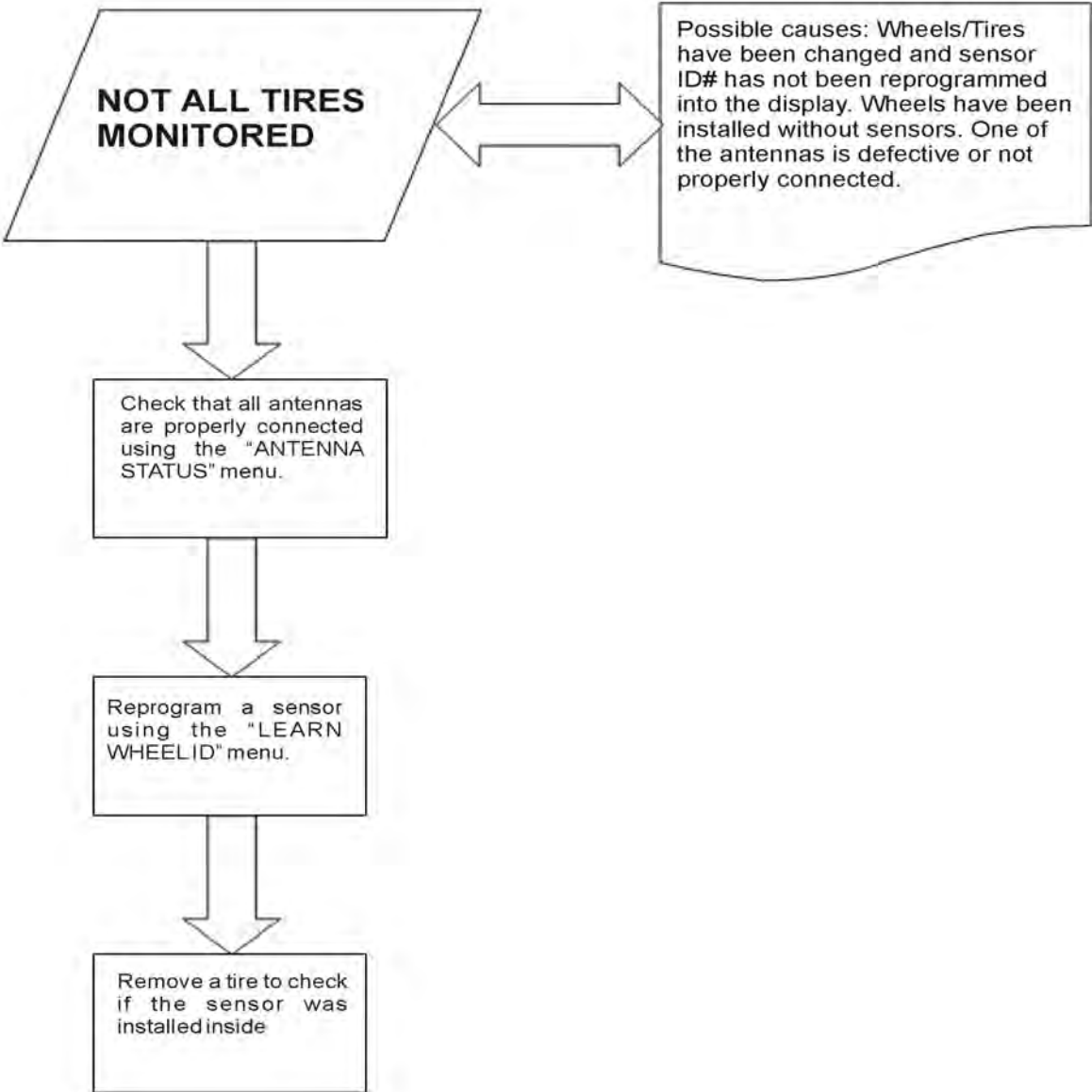
\*\*6th Generation only

# APPENDIX D - TPMS TROUBLESHOOTING

ON-SCREEN TPMS ..... 2  
TPMS-LITE ..... 4

## ON-SCREEN TPMS

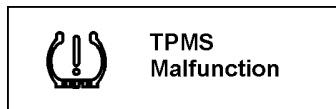




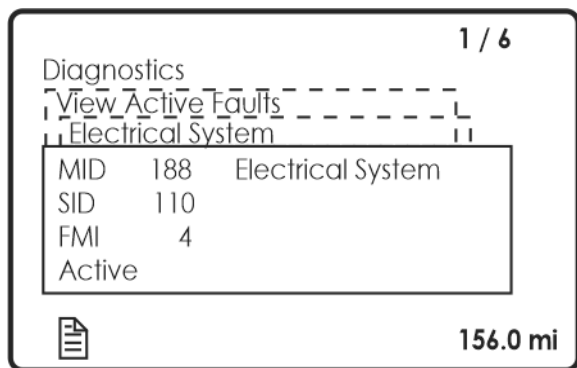
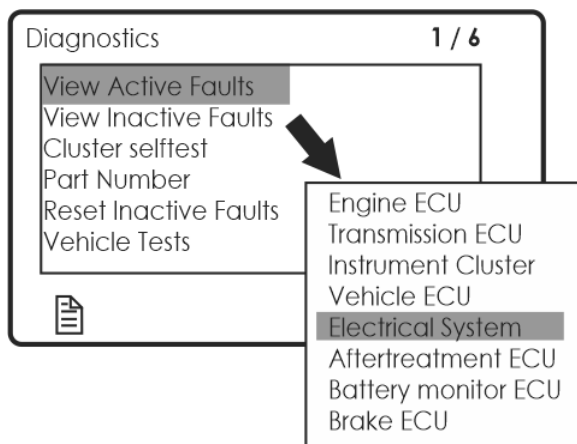
## D-4 TPMS Troubleshooting Guide

### TPMS-LITE

In case of TPMS malfunction, the following warning pop-up message will show on the DID to warn the driver that the TPMS might be disabled or unreliable. To determine the possible cause of the anomaly, check the diagnostic codes on the DID display.



In the DIAGNOSTICS menu, select VIEW ACTIVE FAULTS sub-menu or VIEW INACTIVE FAULTS and then select ELECTRICAL SYSTEM. See the list of diagnostic codes listed for the MID 188 Electrical System. Identify the SID and FMI digital codes and see the description in the following table below.



#### TPMS-LITE DIAGNOSTIC CODES

| SID | FMI | DESCRIPTION                      | TROUBLESHOOTING INSTRUCTION  |
|-----|-----|----------------------------------|--|
| 55  | 1   | Tire pressure too low            | Visually check low pressure tire                                     |
| 106 | 0   | Tire temperature too high        | Feel temperature on each tire  |
| 106 | 13  | Tire temperature critically high | Feel temperature on each tire  |
| 107 | 2   | Tire sensor not responding       | Always associated with SID faults 110 to 115. Troubleshoot 2nd fault |
| 110 | 4   | Sensor low battery power         | Connect Cantrak and perform sensor learn ID                          |
| 111 | 2   | LIN Bus power fault              | Troubleshoot CAN/LIN communication error                             |

**TPMS-LITE DIAGNOSTIC CODES(continued)**

| <b>SID</b> | <b>FMI</b> | <b>DESCRIPTION</b>       | <b>TROUBLESHOOTING INSTRUCTION</b>          |
|------------|------------|--------------------------|---|
| 112        | 2          | Front antenna fault      | Check front antenna                         |
| 113        | 2          | Rear left antenna fault  | Check rear left antenna                     |
| 114        | 2          | Rear right antenna fault | Check rear right antenna                    |
| 115        | 1          | Low sensor counts        | Connect Cantrak and perform sensor learn ID |