

SAFETY RECALL

SR24-81

Date Expiration Group No. Page
09.2024 NA 1(9)

First Release

09-16-2024

WHEELCHAIR LIFT SYSTEM – THRESHOLD WARNING SENSOR LIGHT REPLACEMENT

9700 (B13R)

MODEL YEAR(S) AND VEHICLE SERIAL NUMBERS (VIN) INVOLVED

NOTICE TO SERVICE CENTERS	
Verify vehicle eligibility by checking recall status with SAP or via ONLINE WARRANTY SYSTEM available on Service / Warranty tab of Prevest website.	
Model	VIN
Volvo 9700 us/can Model Year : 2013 - 2021	From 3CET2S228D <u>5160296</u> up to 3CET2W427M <u>5204874</u> incl.
This recall does not necessarily apply to all the above-mentioned vehicles, some vehicles may have been modified before delivery. The owners of the vehicles affected by this recall will be advised by a letter indicating the Vehicle Identification Number (VIN) of each vehicle concerned.	

DESCRIPTION

On vehicles affected by this recall, replace the threshold warning sensor (TWS) light which does not meet the FMVSS requirement 49 CFR 571.403.

MATERIAL

Order kit **SR24-03-81** which includes the following parts:

Description	Qty
TWS LIGHT ADAPTER, BEACON	1
LIGHT UNIT, STROBE, RED, 6X LED, 24V, TWS RETROFIT	1
SCREW, RHP, 4-20x5/8, ZN, THDF	2
WIRE SPLICE, LEVER ACTUATED, 24- 12AWG, WAGO	2
WASHER, FLAT, .128x.313x.032	2

NOTE

Material to be obtained through Prevest.

Tools required:

- Philips screwdriver #1
- Small prybar
- Wire stripper – 22 AWG, 24 AWG
- Wire cutter

SAFETY PRECAUTIONS

- Eye protection should always be worn when working in a shop.
- Rules for Personal Protection Equipment should always be respected. Wear your PPE including but not limited to the following:



**Safety
First!**



PROCEDURE



DANGER

Park vehicle safely, apply parking brake, stop the engine. In the battery box, set the battery cut-off switch to the OFF position prior to working on the vehicle.

Lockout & Tag out (LOTO) must be performed during set-up, maintenance or repair activities. Refer to your local procedure for detailed information regarding the control of hazardous energy.

1. Cut the electrical power to the wheelchair lift system using the dashboard WCL switch.
2. Use a small prybar to remove red lens from TWS light, and discard. Figure 1.



Figure 1 : Red lens cover to be removed

3. Use wire cutters to cut the yellow and blue wires as close as possible to the terminals on light unit. Figure 2.

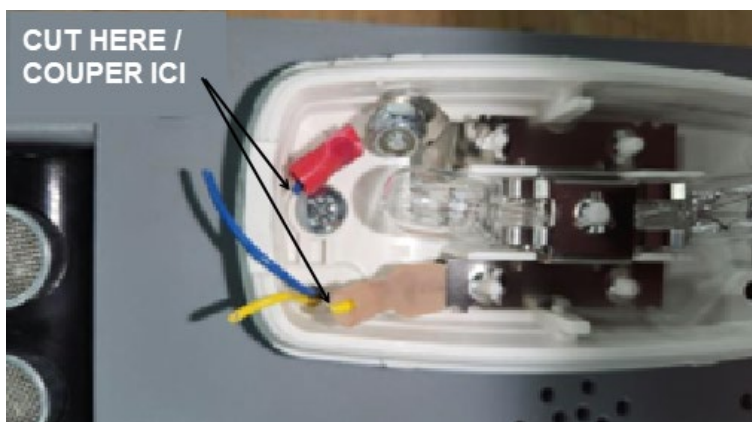

Figure 2

- Using a #1 Phillips screwdriver, remove the two (2) screws shown. Retain screws for use in reassembly. Figure 3.



Figure 3

- Remove the light from the faceplate. Wires will slide out as light is removed. Ensure that previously cut wires always remain accessible. Discard removed light. Figure 4.

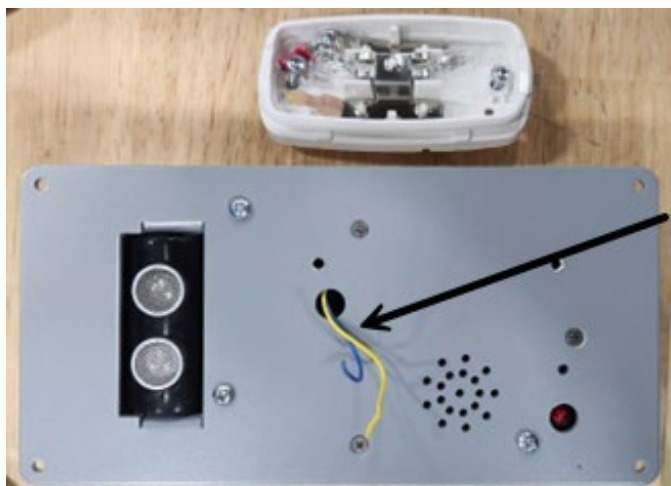

Figure 4: Wires are accessible and not under the faceplate

- Use a 22 AWG wire stripper to strip black and red wires on the replacement light unit to 11 mm. Use the indicator on the side of wire splice connector included in the kit. Figure 5.

SAFETY RECALL

SR24-81

Date	Expiration	Group	No.	Page
04.2024	NA			5(9)

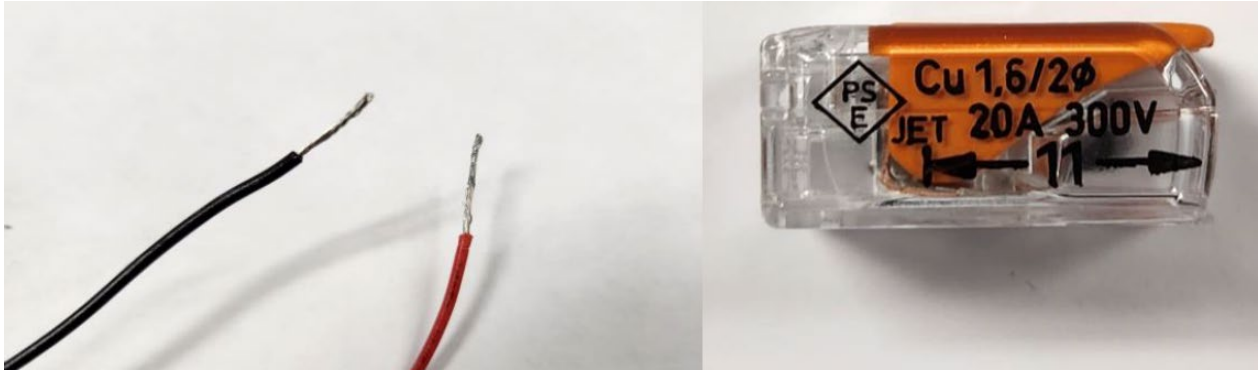

Figure 5: Black and red wire stripped. 11 mm indicator shown

7. Repeat the previous step for yellow and blue wires protruding from the faceplate using a 22 AWG wire stripper. Figure 6.

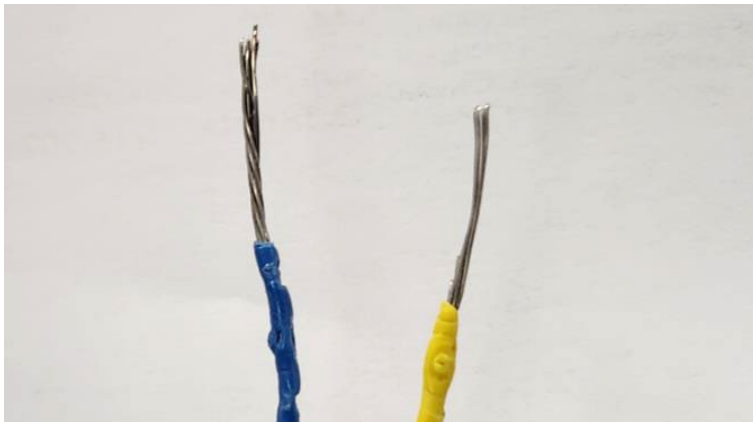

Figure 6: Blue and yellow wires stripped

8. Guide red and black wires from light unit through the opening of the TWS light adapter. Figure 7.



Figure 7: Red and black wires guided through the TWS light adapter

9. Raise both levers on 2 wire splice connectors, then insert red wire into one connector slot and yellow wire into other slot. Push both levers down to fasten wires. Repeat the previous step for black and blue wires. Figures 8 and 9.

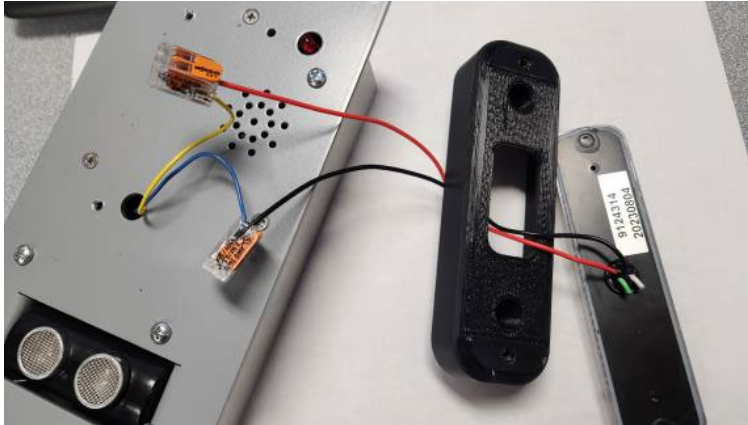

Figure 8: All wires properly connected using 2 wire splice connectors

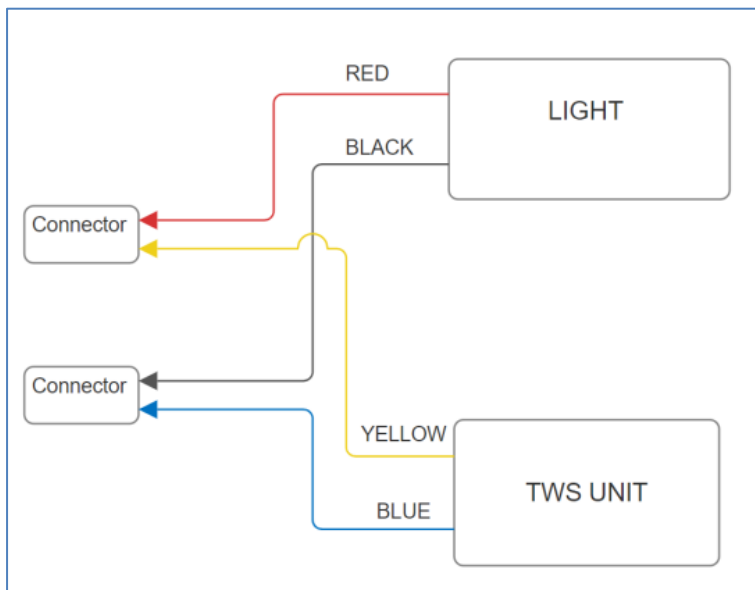

Figure 9: Wiring diagram

10. Lodge both connectors firmly into the 2 corners on either end of TWS light adapter. Figure 10.

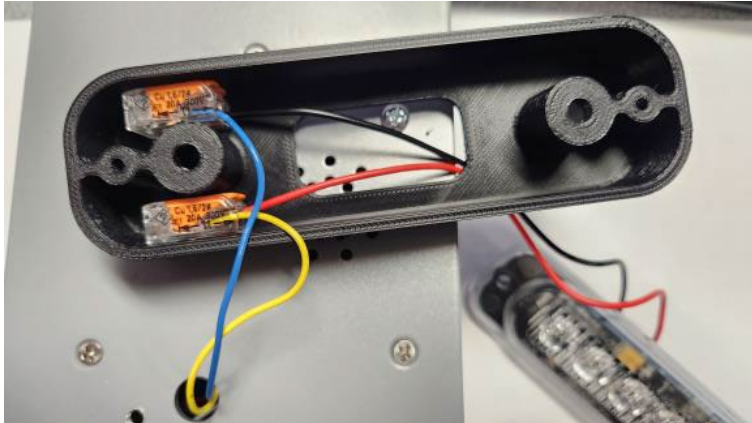

Figure 10: Wire splice connectors properly secured

11. Place the TWS light adapter on the faceplate aligned with the same hole locations from Step 4. Use previously removed screws from Step 4 to screw the adapter to the faceplate. Conceal both wires inside the TWS light adapter. Figure 11.

BE CAREFUL WITH THE PLASTIC PART. DO NOT USE A POWER SCREWDRIVER



Figure 11: TWS adapter placed and installed to faceplate

12. Align the new light with the small holes on either end of the TWS light adapter. Conceal any wires inside TWS light adapter.
13. Using a Phillips screwdriver #1, proceed to screw in TWS light to TWS adapter with 2 screws and 2 washers. **Take care not to tighten too hard as the lens may break.** Figure 12.

BE CAREFUL WITH THE PLASTIC PART. DO NOT USE A POWER SCREWDRIVER



Figure 12

14. Connect power to the TWS unit.
15. Turn power to the lift system on (LED on TWS module will light steady).
16. Following lift operating procedure, raise lift platform to 1" below bus floor height. Ensure that bus side door is open.
17. Stand or place a large object in the threshold area to confirm that TWS buzzer sounds off and new light unit flashes in unison.
18. Remove obstruction from the threshold area, then fully stow lift and close bus side door.

PARTS / WASTE DISPOSAL

DO NOT RETURN THE REPLACED PARTS. Discard waste according to applicable environmental regulations (Municipal/State[Prov.]/ Federal)

WARRANTY

This modification is covered by Prevest's normal warranty.

We will reimburse you the parts and 1/2 hour(s) (0.5) of labor upon receipt of a completed A.F.A. Please submit claim via our Online Warranty System, available at www.prevestcar.com (under service \ warranty section).

- Use Claim Type: "Bulletin/Recall" and select "Safety Recall SR24-81".

Should you only wish to close the safety recall (without reimbursement), fill-in the "Safety Recall Certification Sheet" provided with this bulletin and return it to our warranty department by Email at prevost.warranty@volvo.com or by fax at 418-831-9301.

OTHER

VBC Bulletin	C0366
Fail Code	25.03
Defect Code	09
Syst.Cond.	R
Causal Part	563945

Access all our Service Bulletins on

<http://techpub.prevestcar.com/en/> or scan the QR-Code with your smart phone.

E-mail us at technicalpublications_prev@volvo.com and type "ADD" in the subject to receive our warranty bulletins by e-mail.



Prevest engages in a continuous program of testing and evaluating to provide the best possible product. Volvo Bus, however, is not committed to, or liable for updating existing products.