

# Ground Distribution

## Electronic gnd to Dash harness

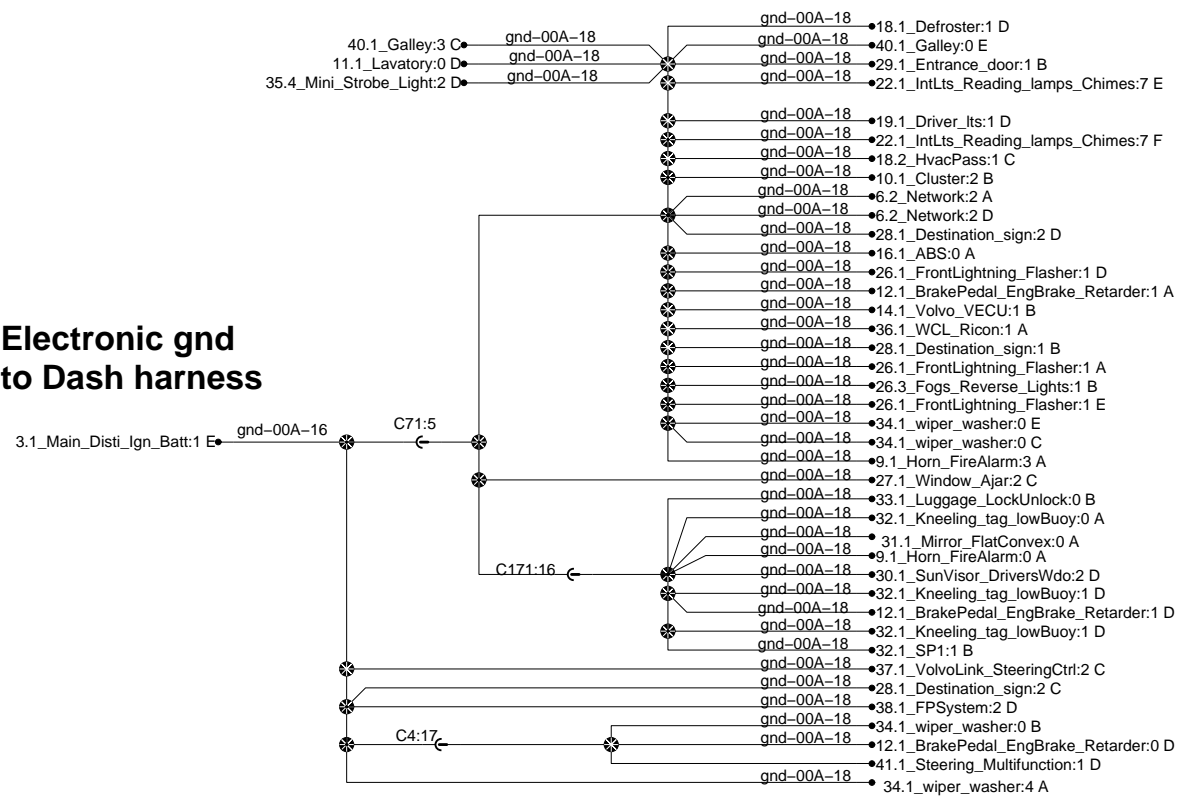

## Dash stud

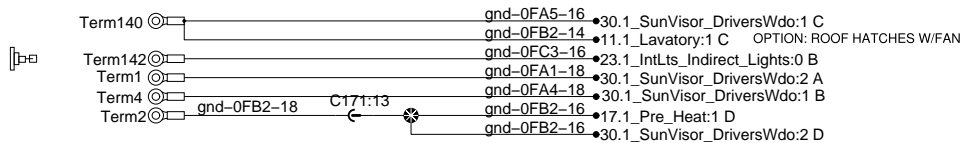

## OPTION:ELECT CHAIR



## Electronic gnd to FJB

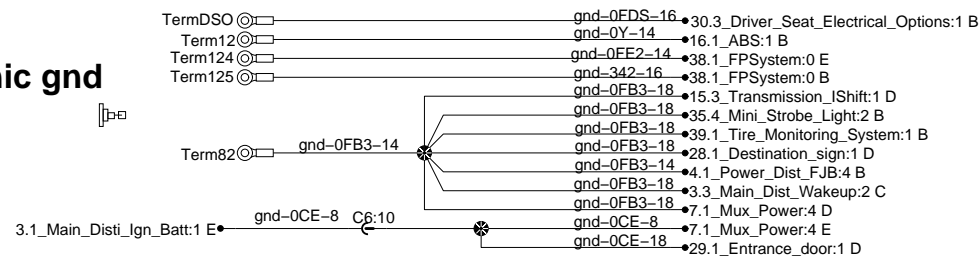

## Front stud

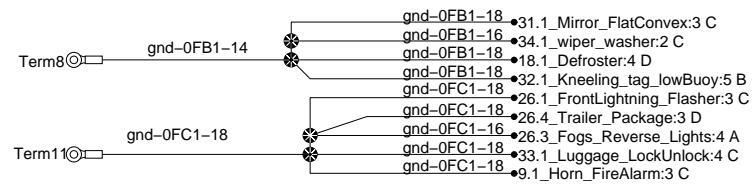

## RH Console stud

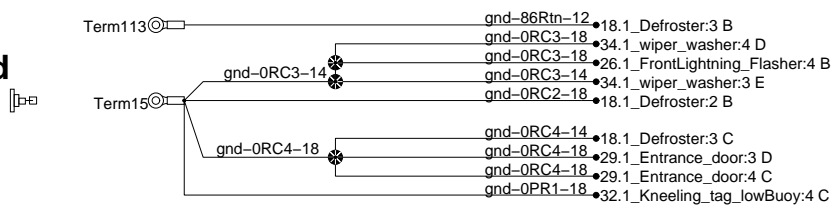

## Chassis gnd Parcel Rack stud



## Condensor cmpt. stud

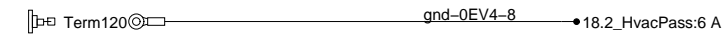

## Evaporator cmpt. stud

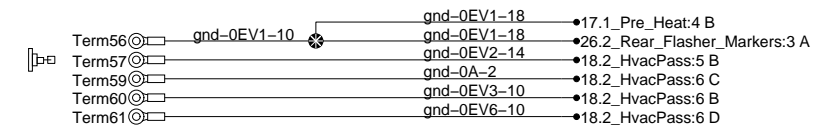

## Electronic gnd to Rr mux 0G

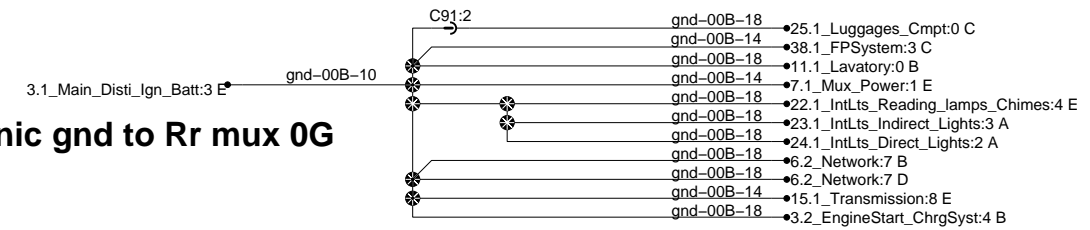

## RJB stud Chassis Gnd

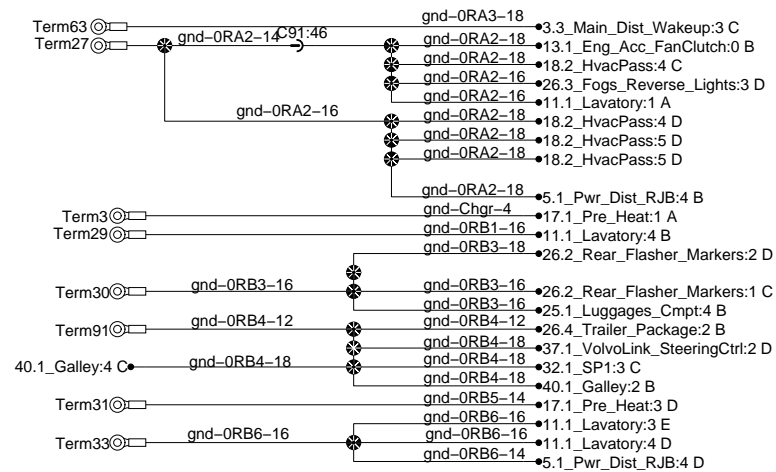

## OPTION:plug 12V add

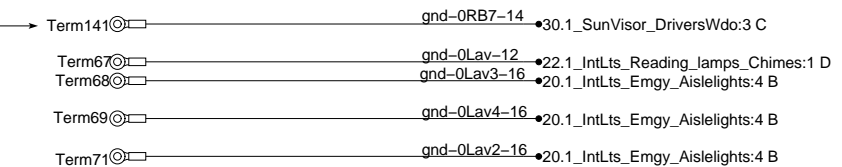

## Lavatory Stud

## Eng. cmpt gnd stud

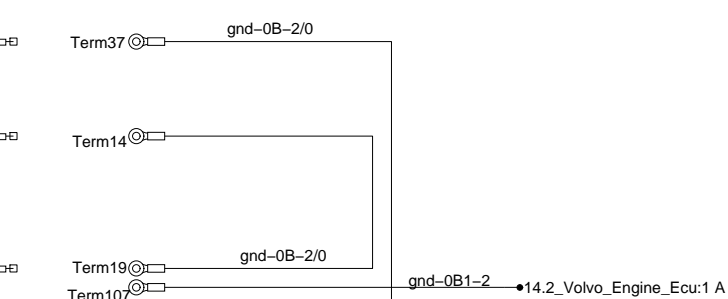

## Engine

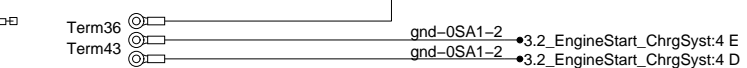

## Engine

