

# FANS, BLINDERS & MIRRORS

JA

# WIRING DIAGRAM

## SWITCH, DRIVER AND GUIDE FAN

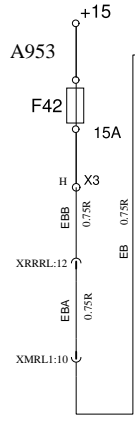
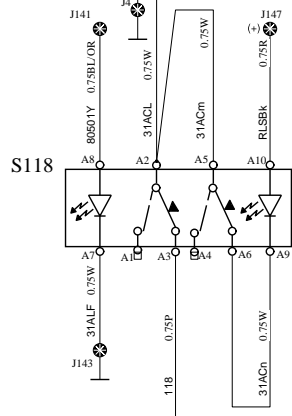

## S1166

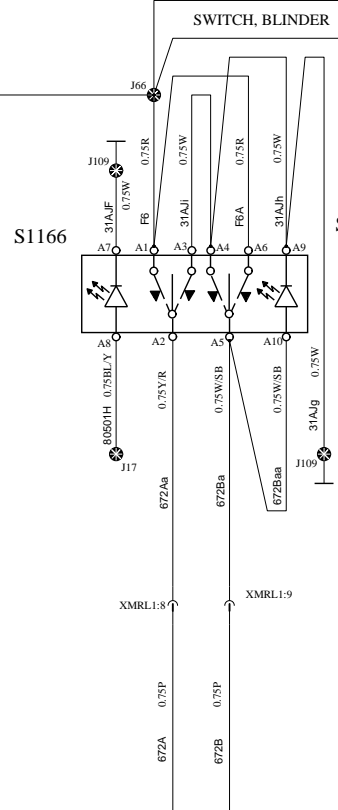

## S1165B

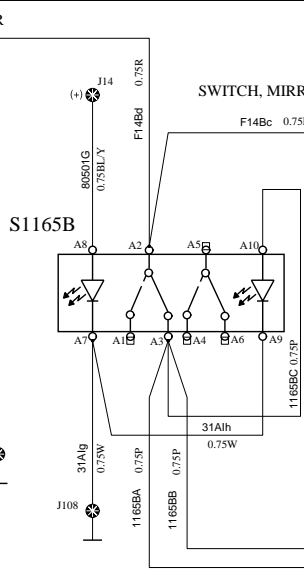

## SWITCH, MIRROR HEATER

## S1165

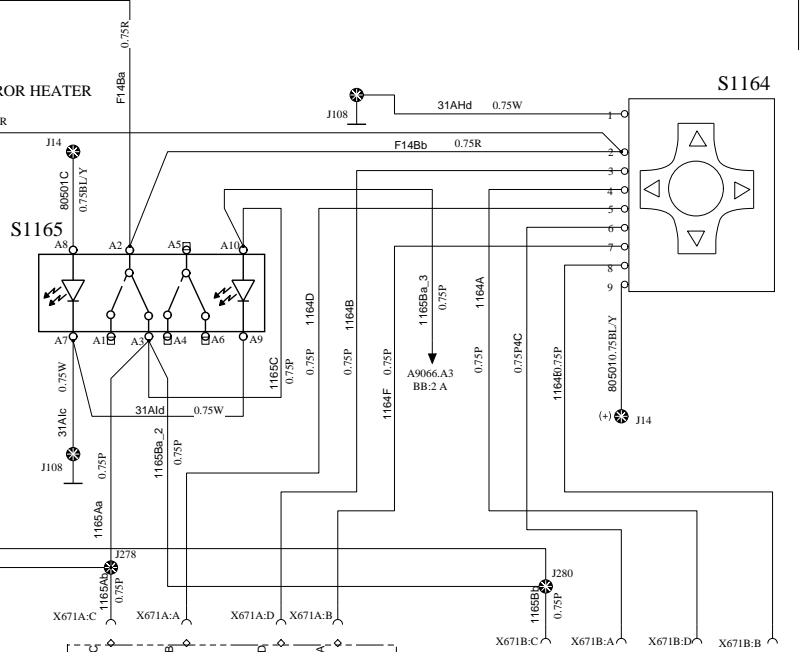

## S1164



## main harness

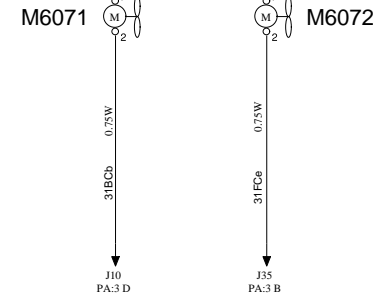
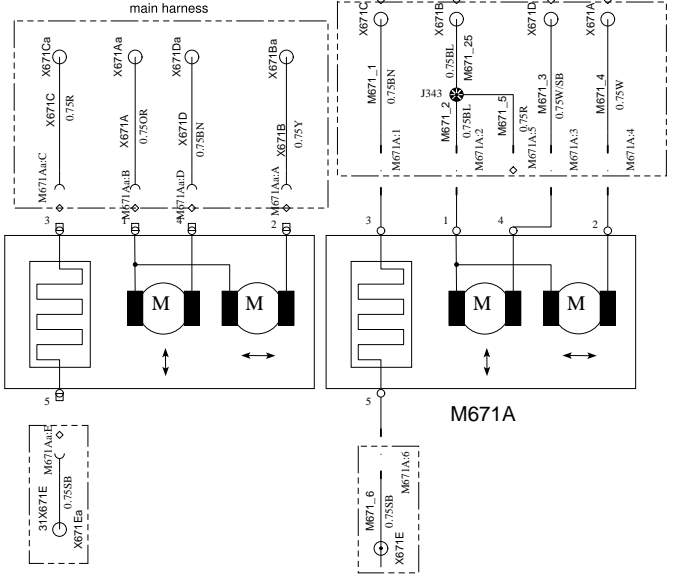

Volvo Bus Corporation

Document title WIRING DIAGRAM
Document type PRODUCT SCHEMATIC

Document No 22600119	Issue 01	Volume 01	Page 47/74
-------------------------	-------------	--------------	---------------