

# TIRE PRESSURE MONITORING SYSTEM

IF

# WIRING DIAGRAM

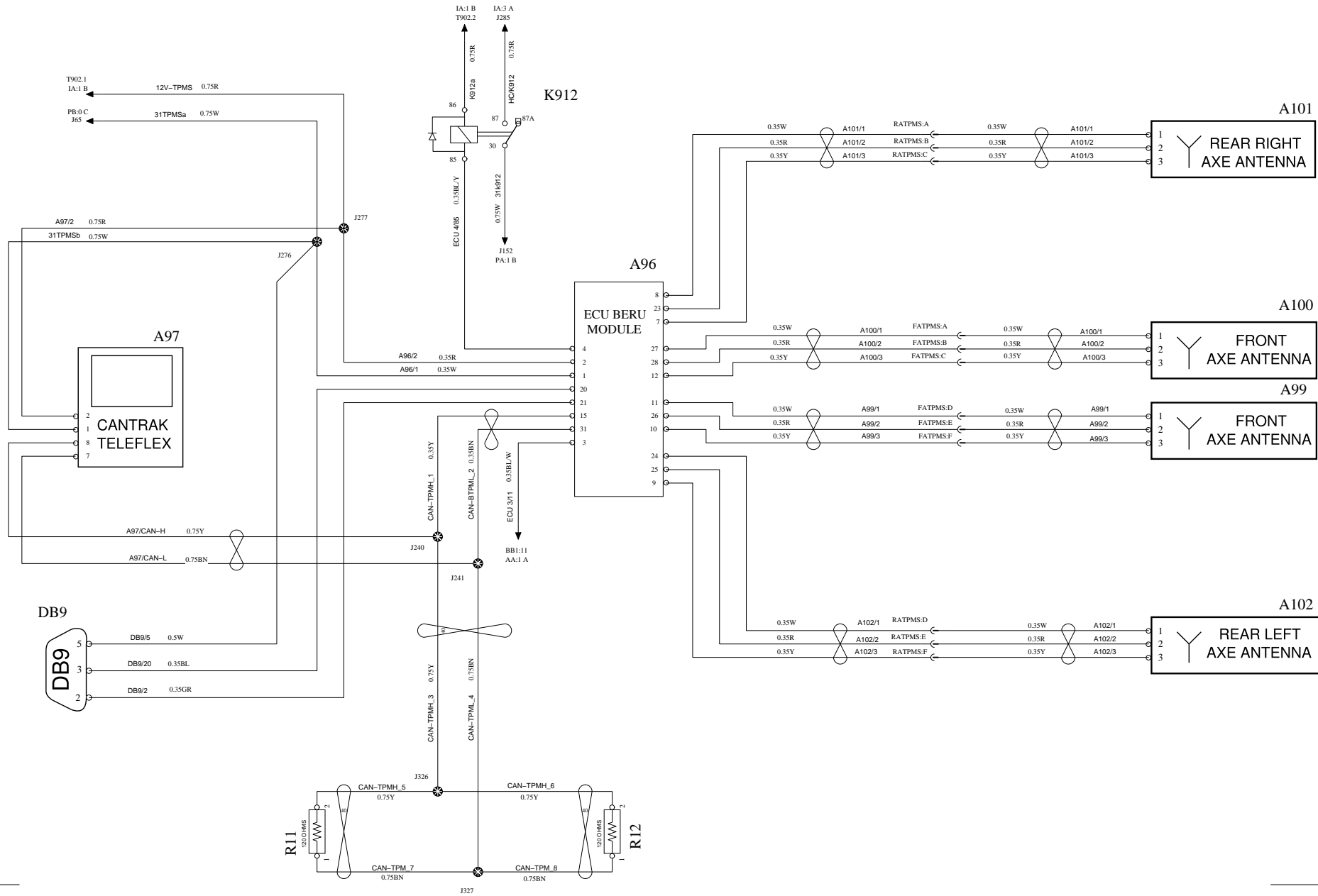

Volvo Bus Corporation

Document title  
WIRING DIAGRAM

Document type  
PRODUCT SCHEMATIC

Document No

21894999

Issue

02

Volume

01

Page

35/65