



Volvo Bus Corporation

VOLVO 9700 US/CAN

**WIRING DIAGRAM
HEATING SYSTEM
PNEUMATIC SYSTEM**

**Chassis number
B13R_133287-133296_ENG**



Volvo Bus Corporation

Document Description

Document	Revision	Description
21250316	1	Wiring Diagram, BEA-Body9700-DOT
21069210	5	Dashboard
21253835	3	Electrical Distribute Unit
21351112	1	Heating System
21289798	1	Heater Installation Drawing
70366809	7	Control System, Pneumatic Body
21375565	1	Wiring Diagram EC Cooper Bussman

Engineering Release Notice (ERN)	Location	Change Description	A = Added U = Deleted	W = Was	Document Release Status RELEASED
E-23113-43					Date 2008-05-27 Modification Count

WIRING DIAGRAM INDEX, BUS BEA BODY 9700 24V MEXICO

NAME	DESCRIPTION	PAGE
AA	BODY BUILDERS	3
AB	ELECTRIC CENTER	4
AC	ELECTRIC CENTER	5
AD	ELECTRIC CENTER	6
AE	ELECTRIC CENTER	7
AF	ELECTRIC CENTER	8
AG	ELECTRIC CENTER	9
BA	CONTROL MODULES	10
BB	CONTROL MODULES	11
BC	CONTROL MODULES	12
BD	CONTROL MODULES	13
BE	CONTROL MODULES	14
BF	CONTROL MODULES	15
CA	INTERIOR LIGHTS	16
CB	INTERIOR LIGHTS	17
CC	LUGGAGE LIGHTS	18
DA	POSITION LIGHTS	19
EA	TOILET	20
EB	LEFT TOILET	21
FA	KITCHEN	22
GA	DRC	23
HA	DOOR CONTROL	24
HB	EXTRA STEP & TELLTALES	25
HC	FEED CENTRAL DOOR & TOILET	26
IA	ACCESSORIES & CA's	27
IB	ACCESSORIES & CA's	28
IC	TD7 TACHOGRAPH	29
JA	FAN, BLINDER & MIRRORS	30
JB	ELECTRIC WINDOW AND ROOF HATCHES	31
JC	EMERGENCY WINDOWS	32
KA	CODRIVER, VIGIA, PARK PILOT & MOBITEC CONTROL	33
LA	AUDIO & VIDEO SUPPLY, 12V & 24 OUTPUTS	34
LB	AUDIO	35
MA	WIPER & WASHER	36
NA	AIR CONDITIONING, SYSTEM 0	37
NB	AIR CONDITIONING, SYSTEM 1	38

The copying, distribution and utilization of this document as well as the communication of its contents to others without expressed authorization is prohibited. Offenders will be held liable for payment of damages. All rights reserved in the event of the grant of a patent, utility model or ornamental design registration.

Document Title
WIRING DIAGRAM
BEA – BODY 9700 - DOT

VOLVO

Volvo Bus Corporation

Document Type
PRODUCT SCHEMATIC

Owner Domain:Document Prefix

Document No 21250316	Issue Index 01	Volume No 01	Page No 1(47)
--------------------------------	--------------------------	------------------------	-------------------------

NC	RE-HEATING SYSTEM	39
ND	AIR CONDITIONING, SYSTEM 1, THERMOKING	40
NE	AUXILIARY HEATER	41
OA	REAR LIGHTS	42
OB	BOTTOM POSITION LIGHTS	43
PA	GROUNDS	44
PB	GROUNDS	45
QA	AUXILIARY LINES	46
RA	FUSES & RELAYS	47

Volume No.	Content	Pages
01	Wiring Diagram	47
02	Reference name	11

VOLVO

Volvo Bus Corporation

Document Title

WIRING DIAGRAM

Document Type

Document No

21250316

Issue Index

01

Volume No

01

Page No

2(47)

BODY BUILDERS

AA

WIRING DIAGRAM

BB1

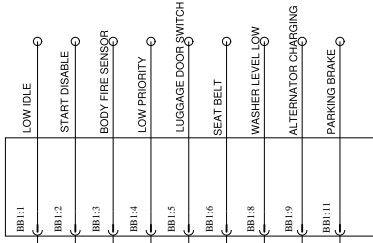

BB2

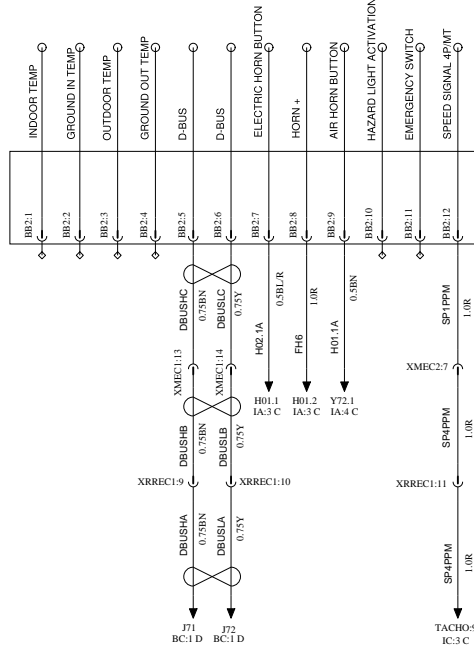

BB3

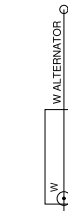
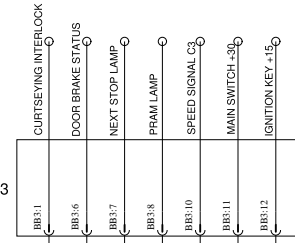

BB4

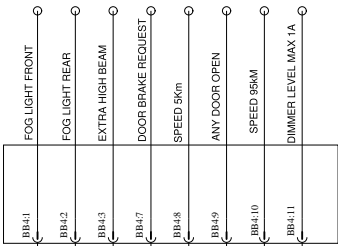

BB5

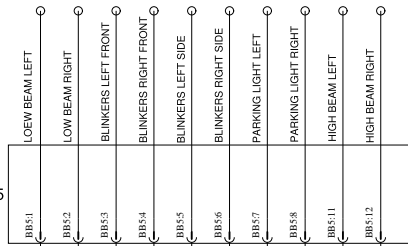

BB7

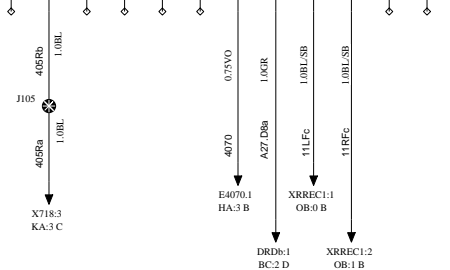
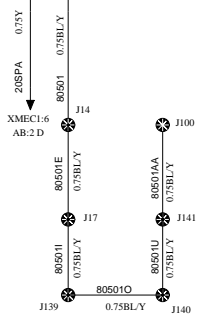
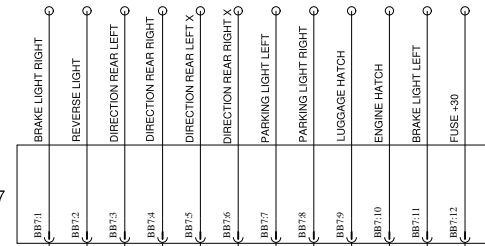

Volvo Bus Corporation

Document title
WIRING DIAGRAM
Document type
PRODUCT SCHEMATIC

Document No	Issue	Volume	Page
21250316	01	01	3/47

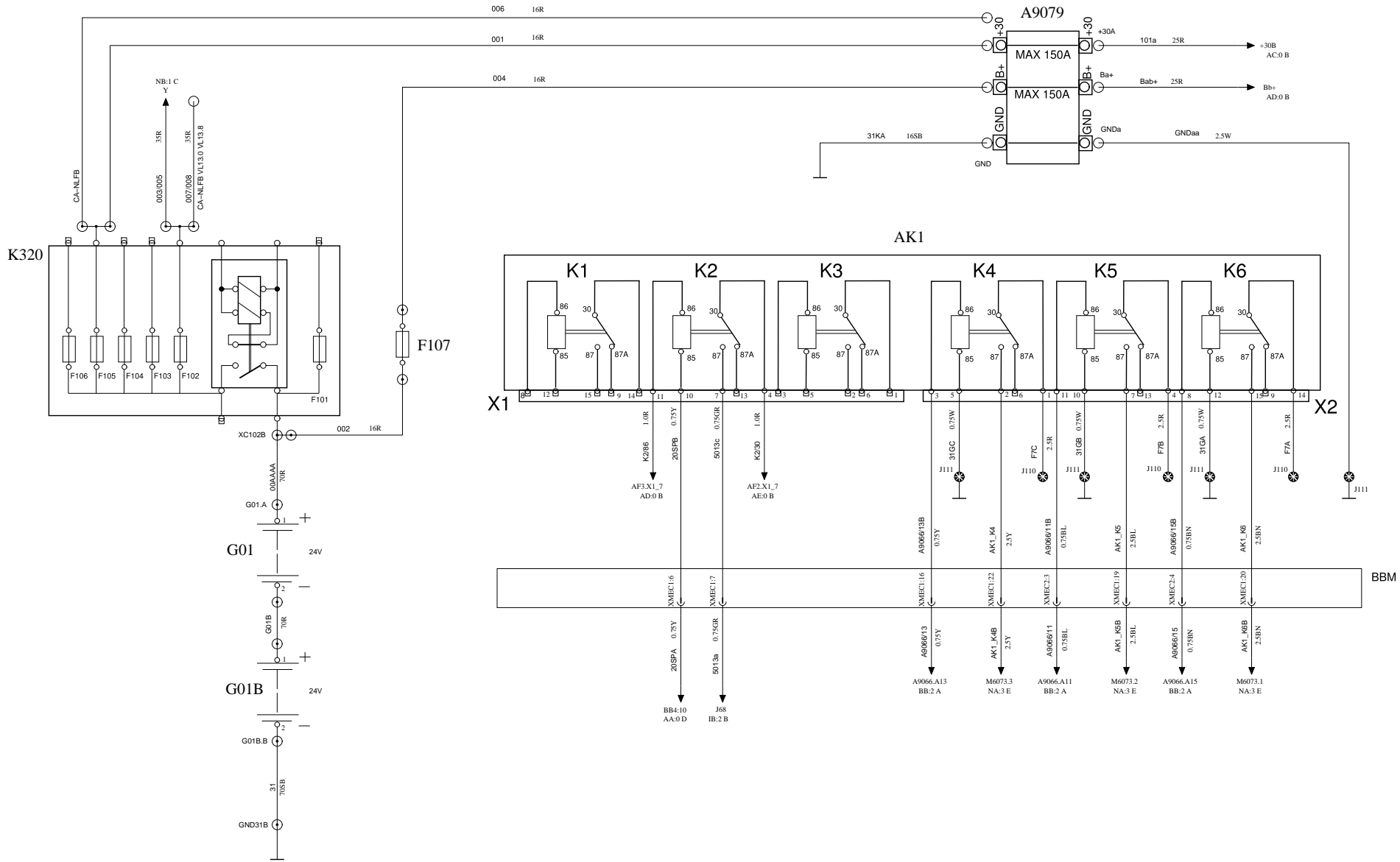

MAX. 100A +30

AF1

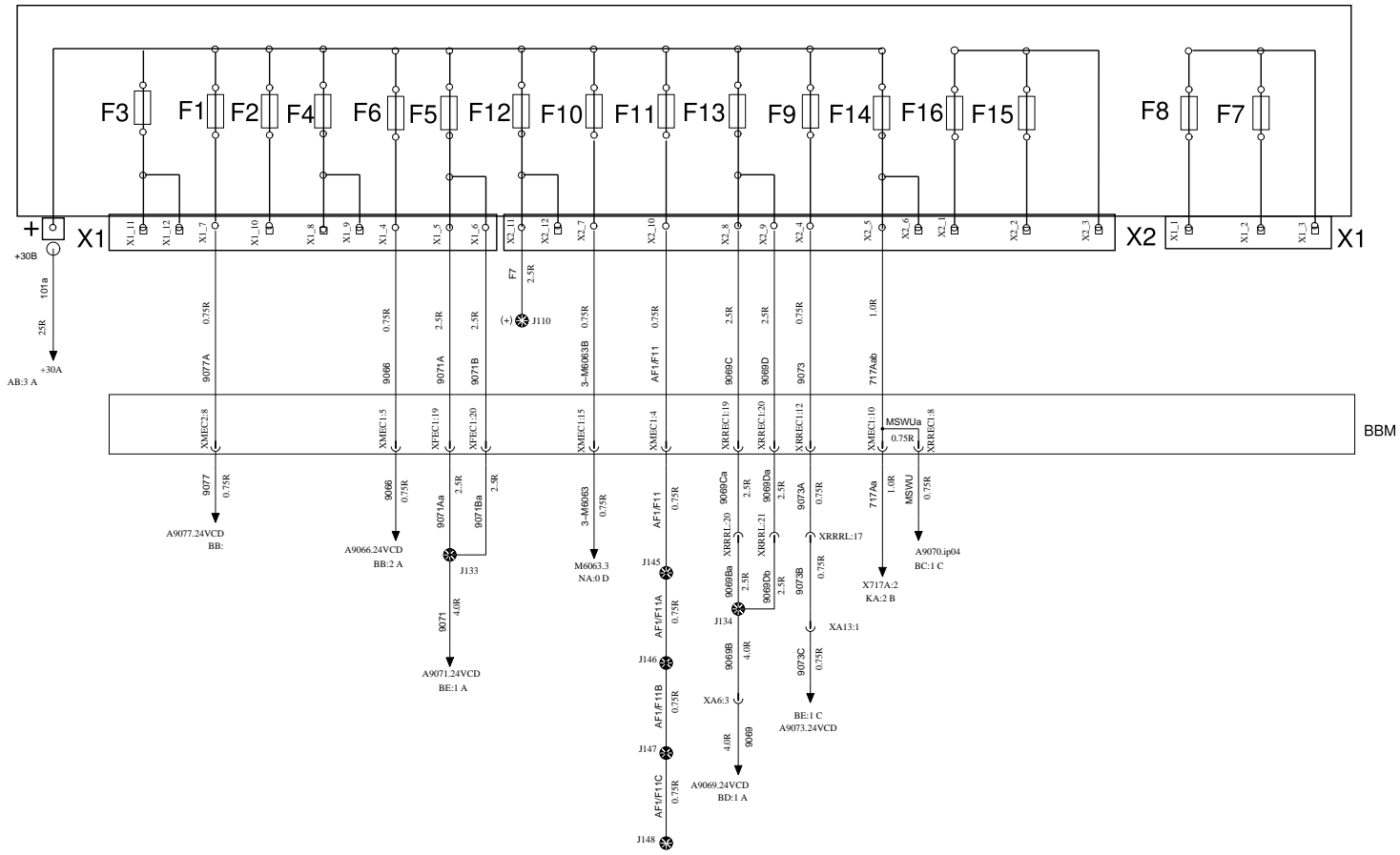

B+
MAX. 100A

AF3

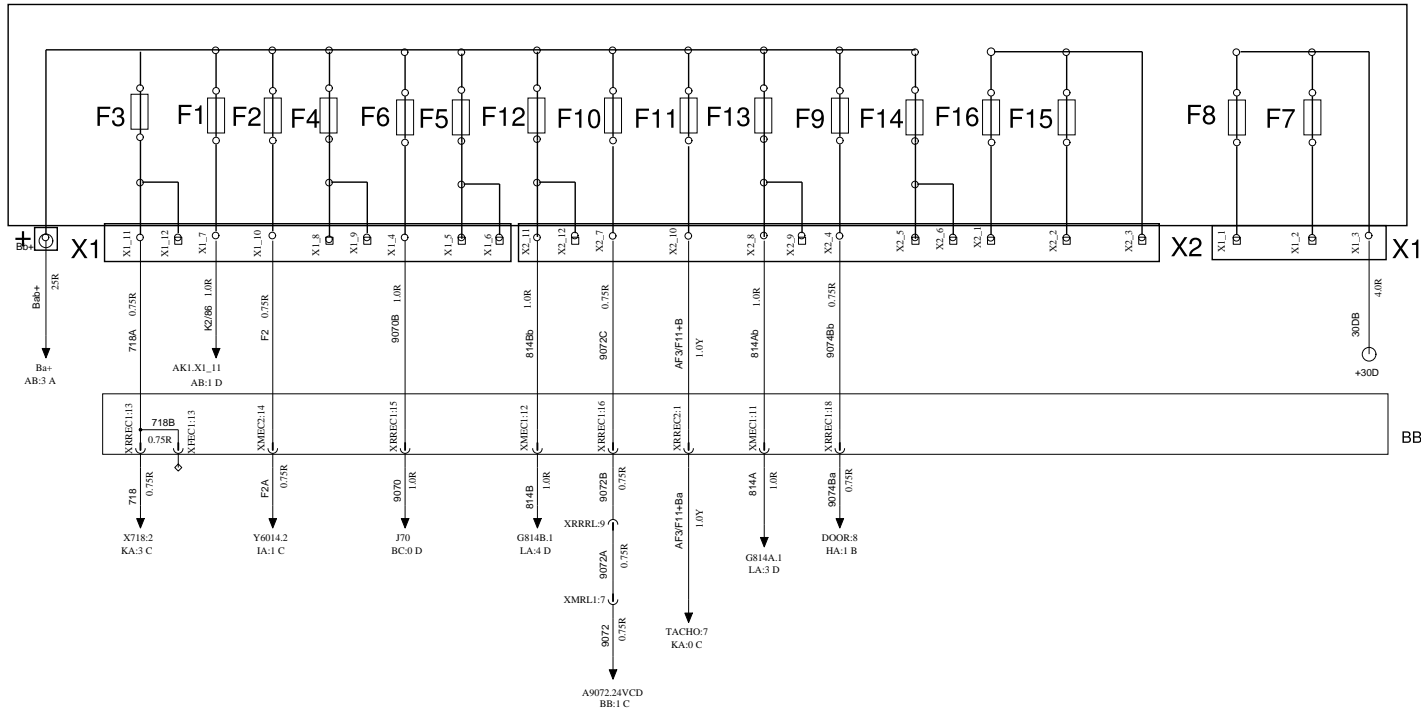

+30
MAX. 100A

AF2

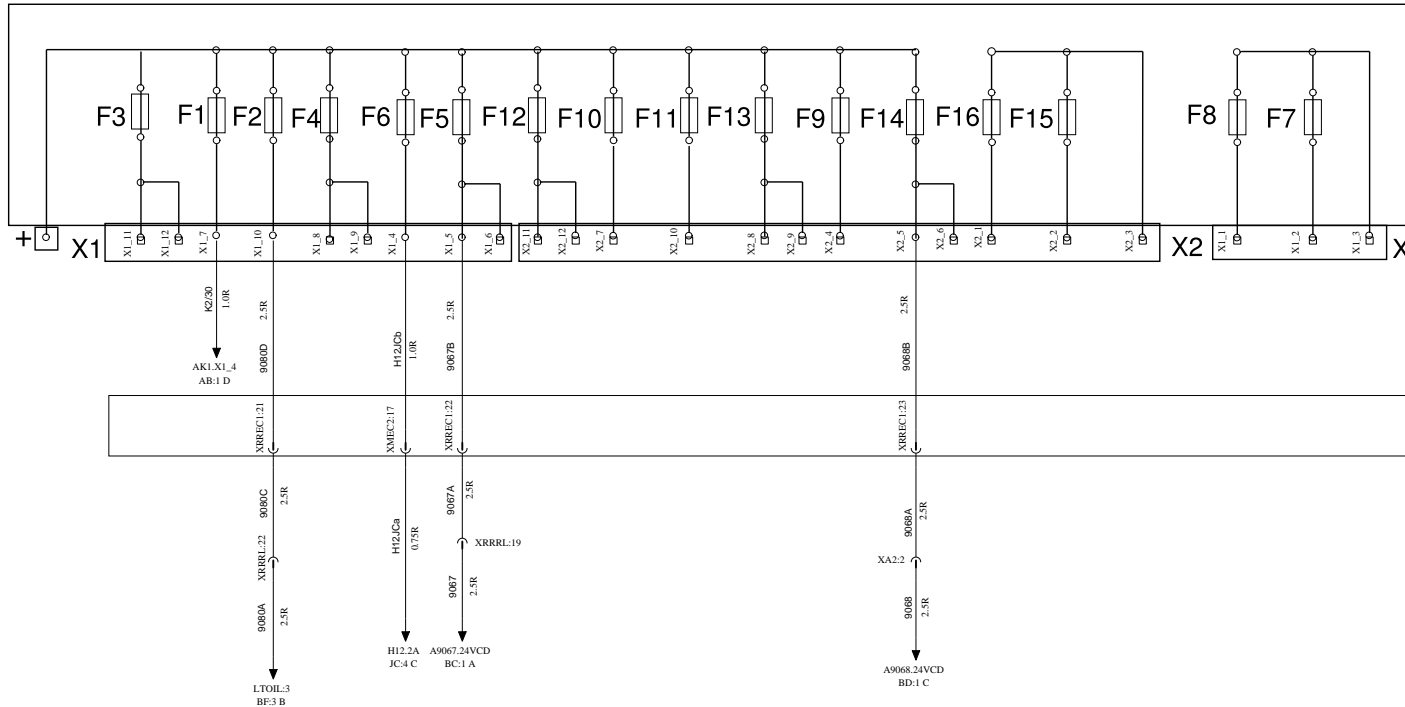

Volvo Bus Corporation

Document title
WIRING DIAGRAM

Document type
PRODUCT SCHEMATIC

Document No

21250316

Issue

01

Volume

01

Page

7/47

+15
MAX. 50A

AF4

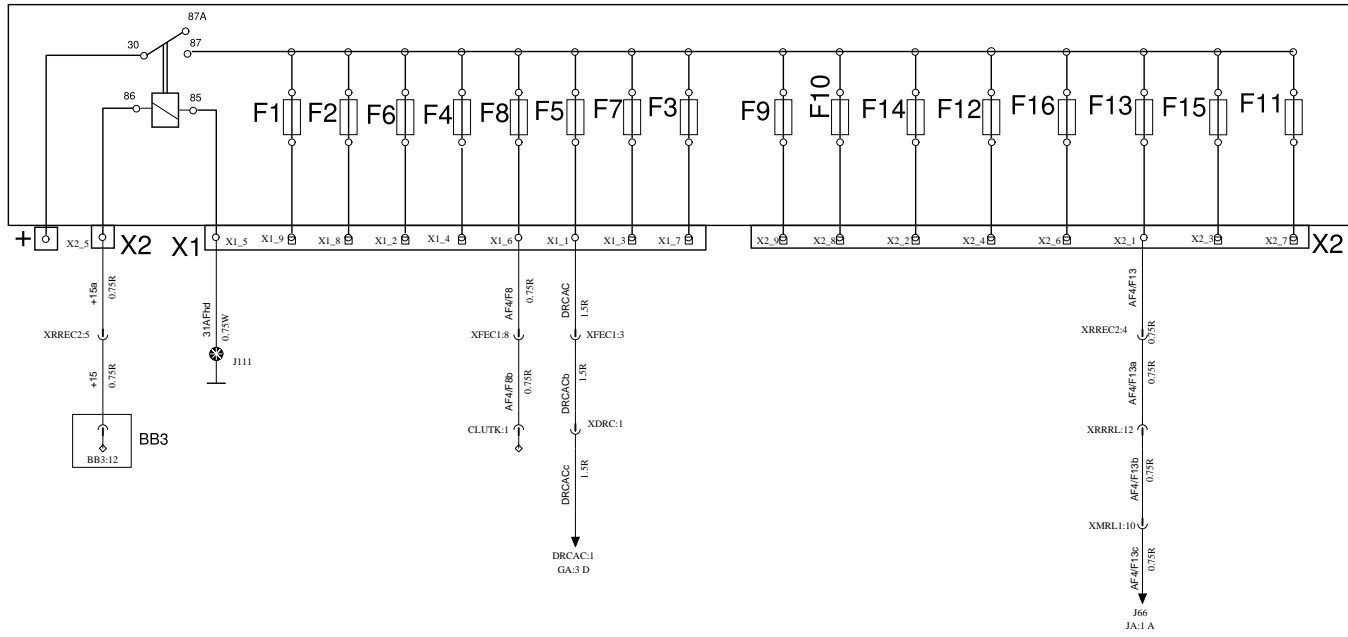

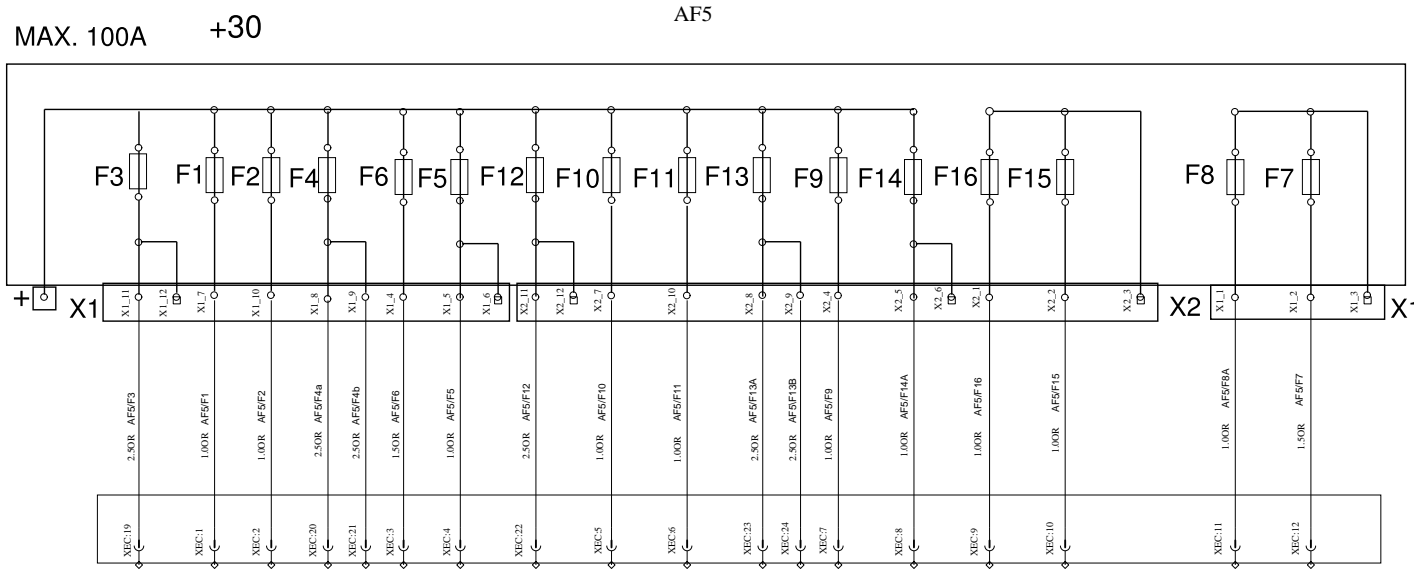

CONTROL MODULES

BA

WIRING DIAGRAM

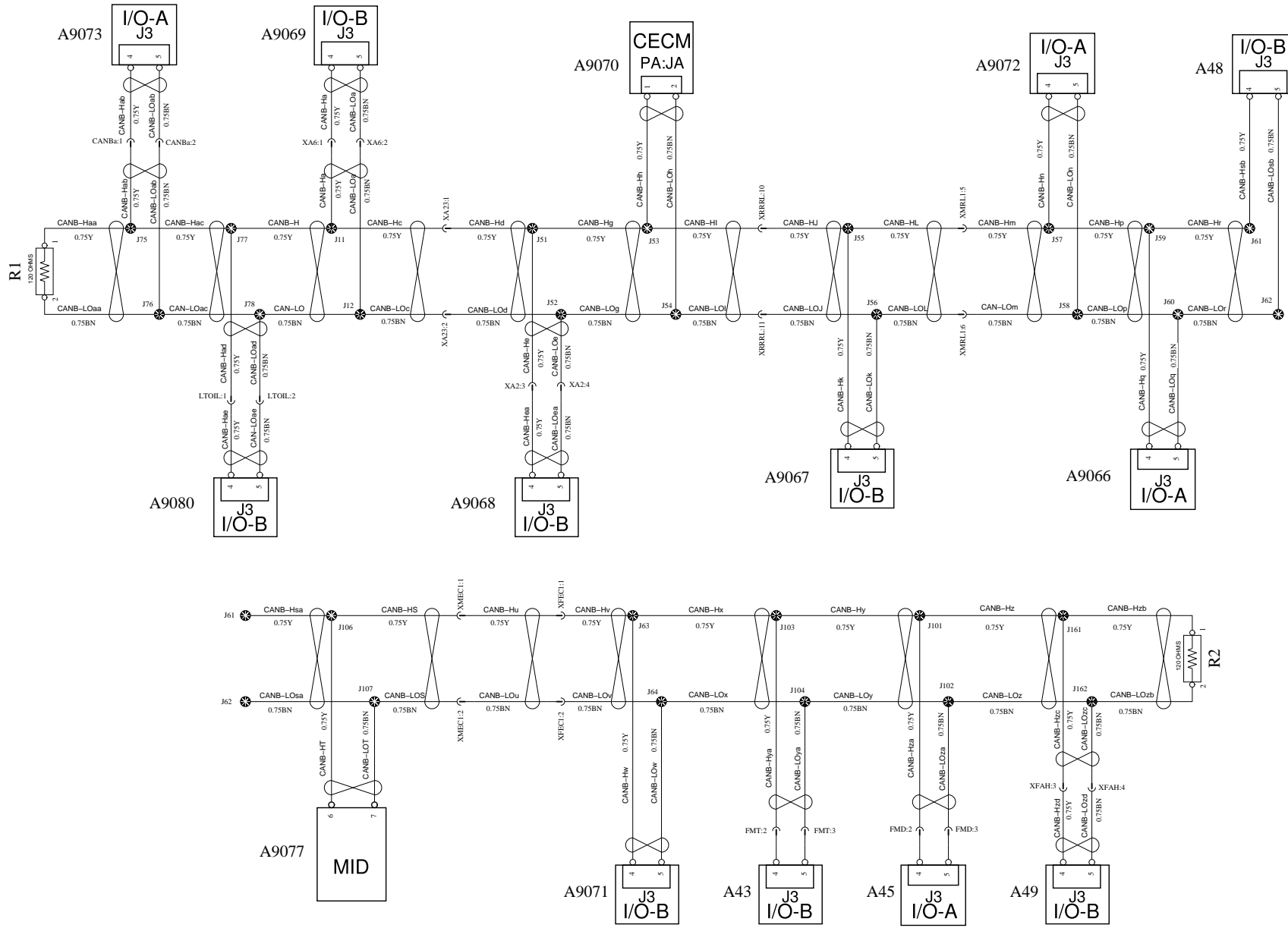

Volvo Bus Corporation

Document title
WIRING DIAGRAM

Document type
PRODUCT SCHEMATIC

Document No

21250316

Issue

01

Volume

01

Page

10/47

CONTROL MODULES

BB

WIRING DIAGRAM

CONTROL UNIT MASTER ID

CONTROL UNIT I/O-A
CLIMATE CONTROL

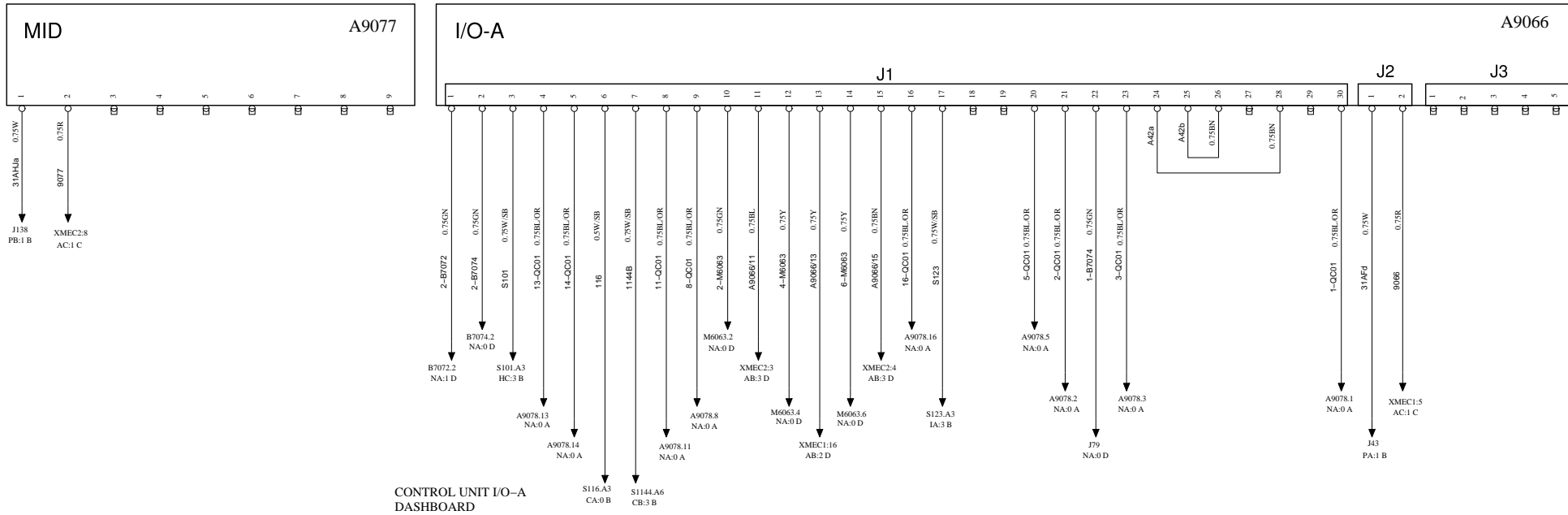

CONTROL UNIT I/O-A
DASHBOARD

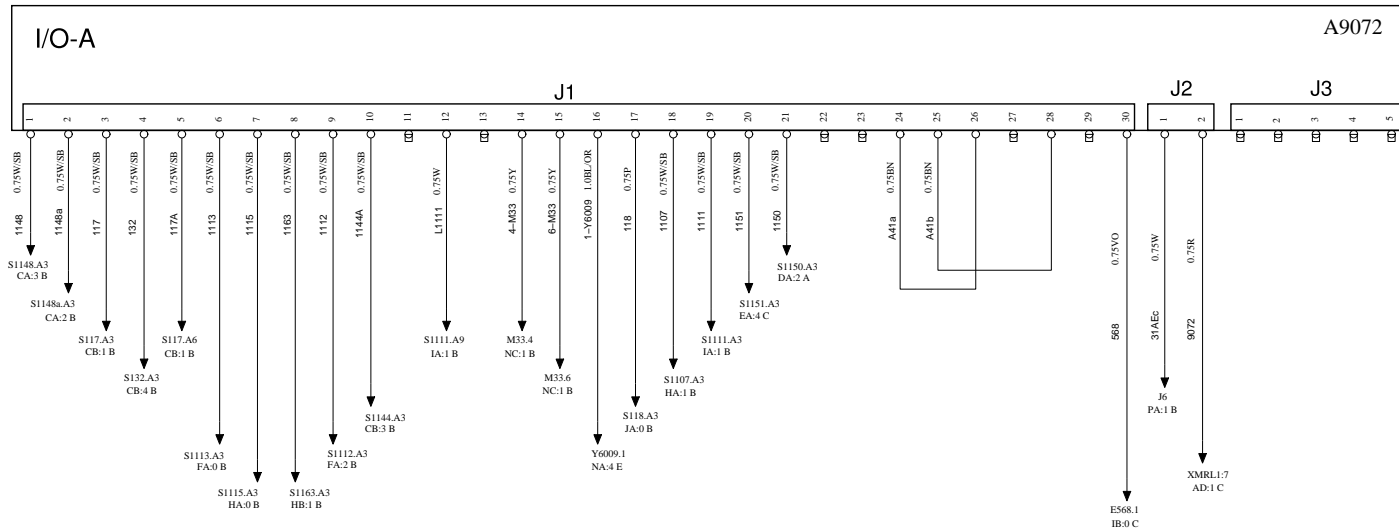

Volvo Bus Corporation

Document title
WIRING DIAGRAM
Document type
PRODUCT SCHEMATIC

Document No	Issue	Volume	Page
21250316	01	01	11/47

CONTROL UNIT I/O-B
ROOF LEFT

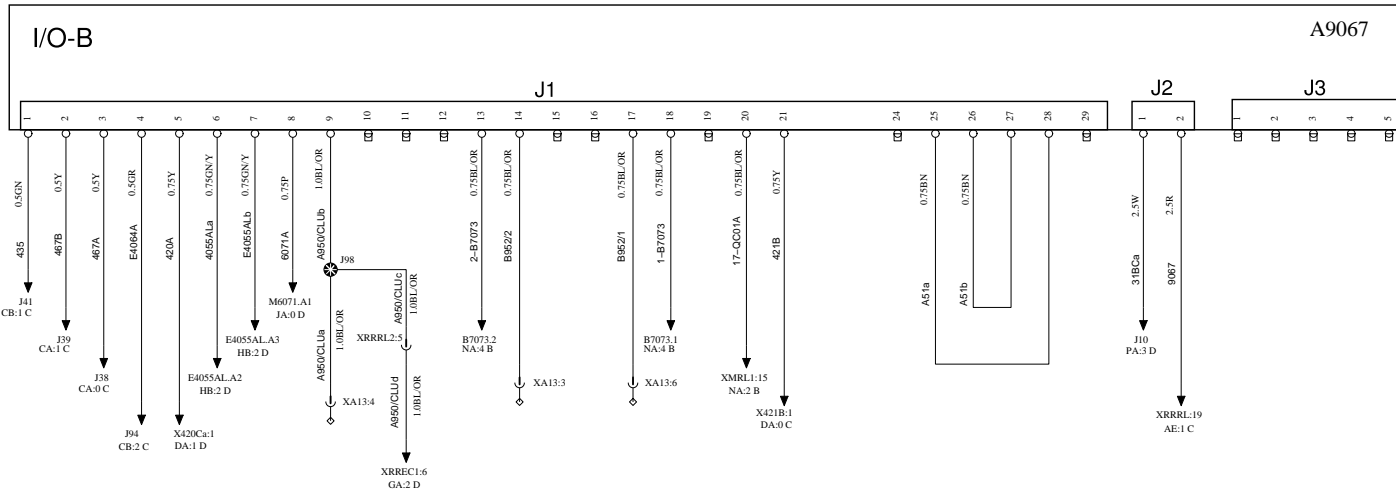

CONTROL UNIT CECM-B
ROOF RIGHT

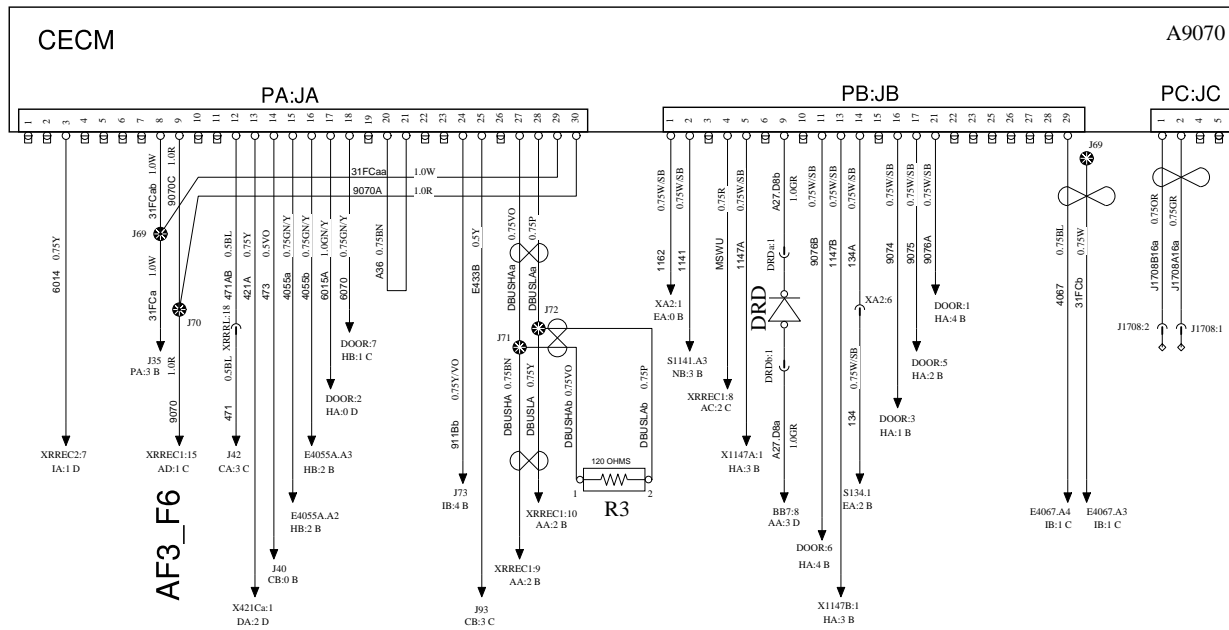

CONTROL UNIT I/O-B
KITCHEN

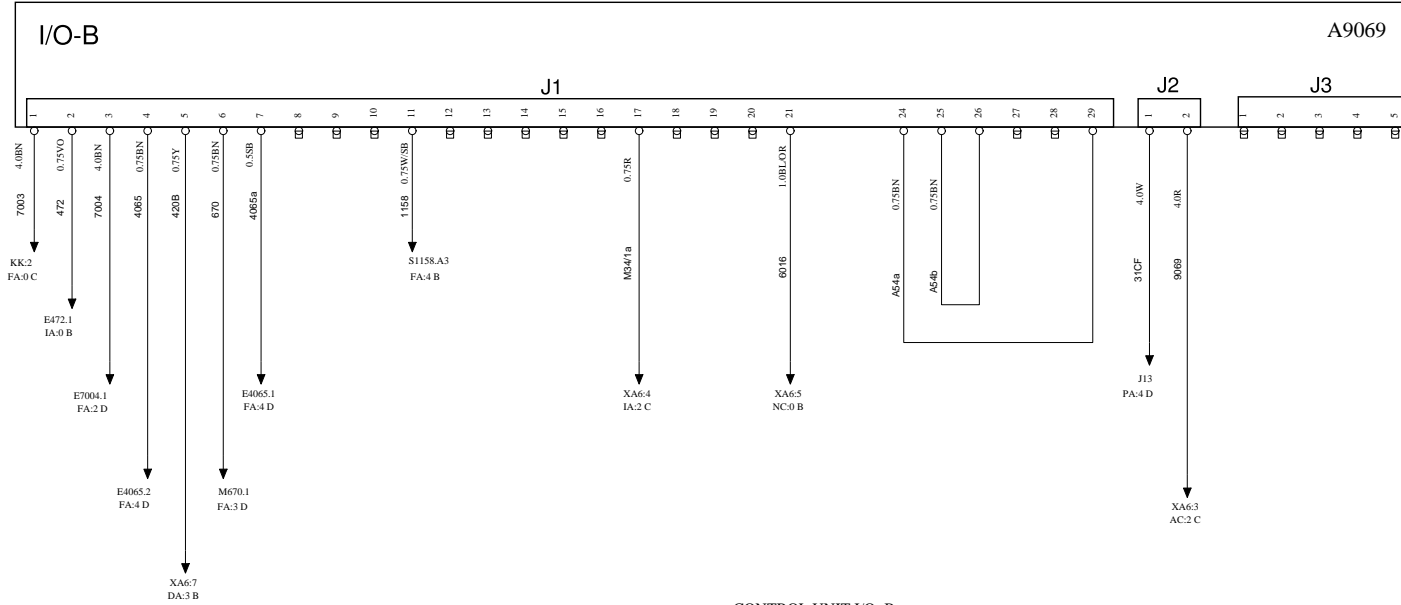

CONTROL UNIT I/O-B
TOILET

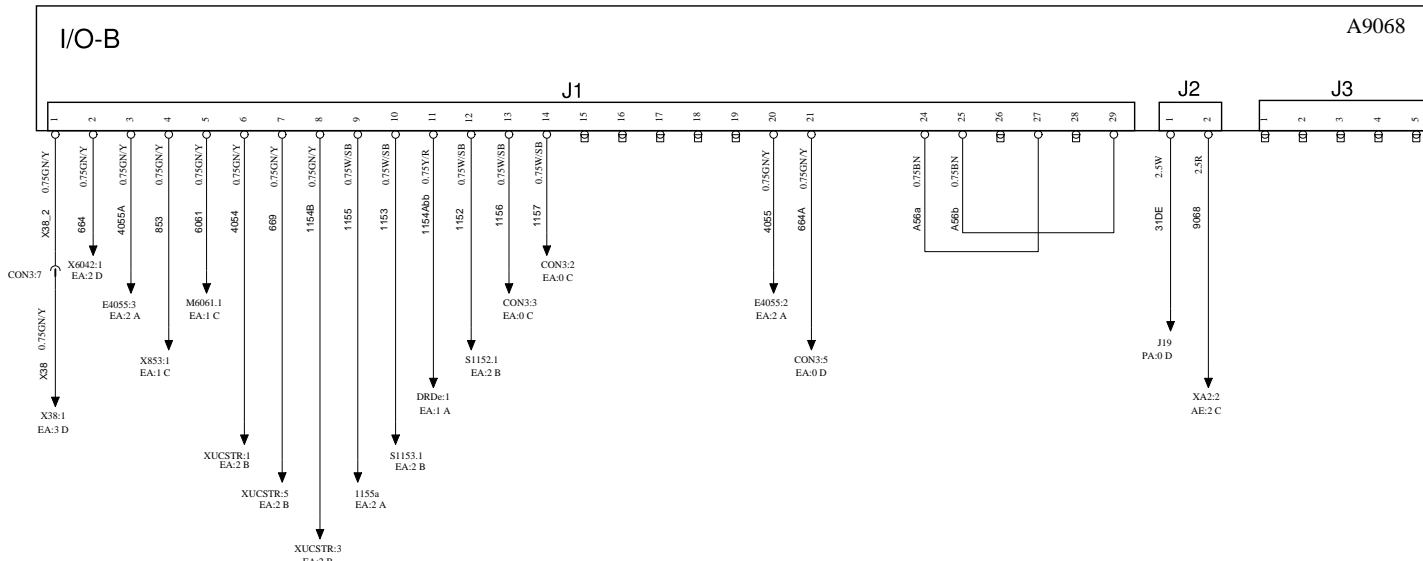

CONTROL UNIT I/O-B
FLOOR

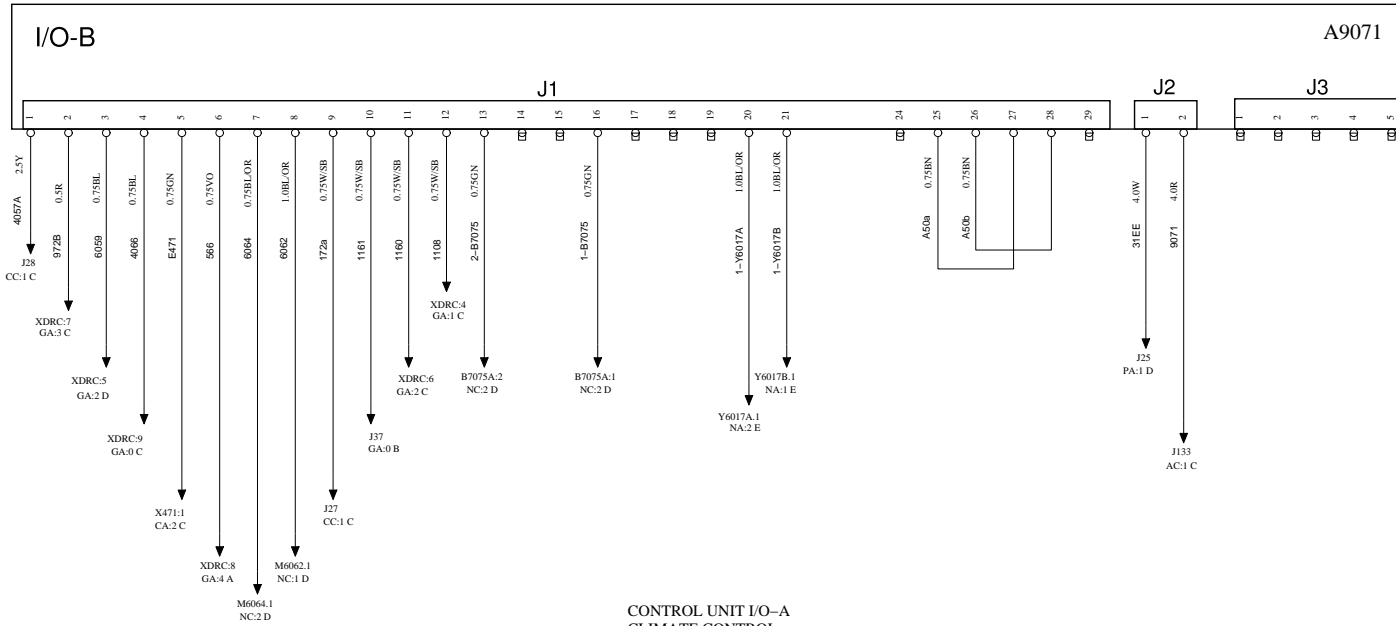

CONTROL UNIT I/O-A
CLIMATE CONTROL

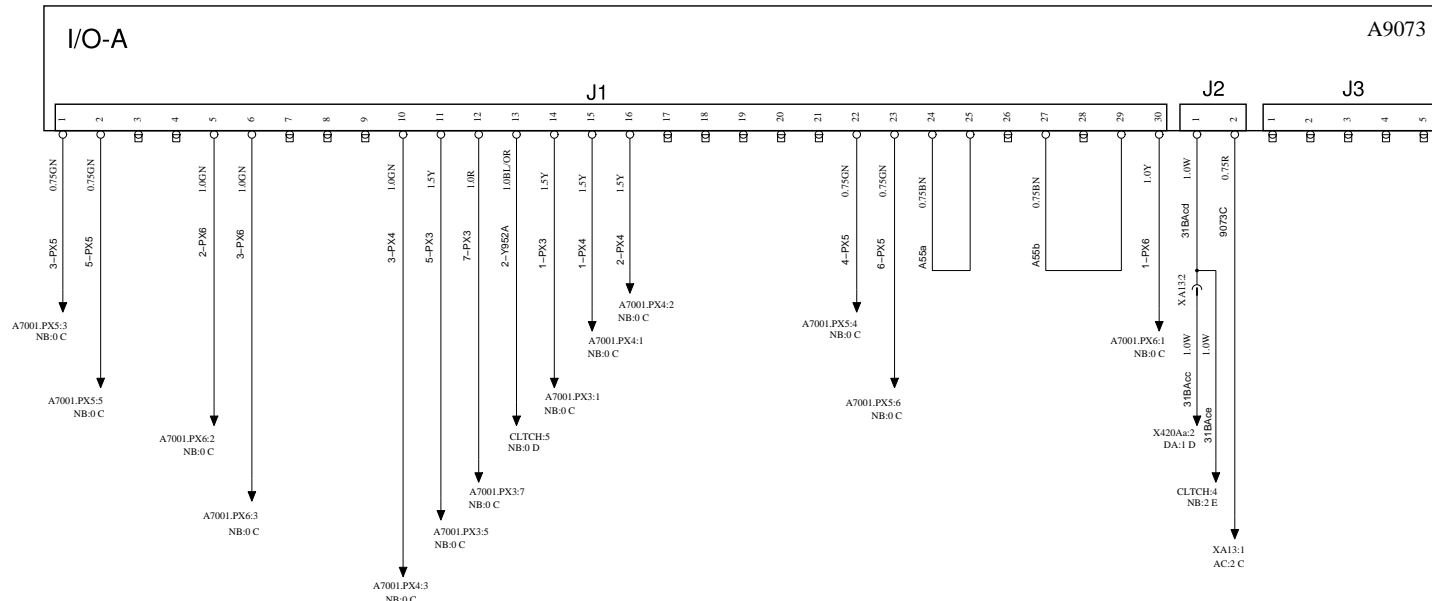

Volvo Bus Corporation

Document title
WIRING DIAGRAM

Document type
PRODUCT SCHEMATIC

Document No

21250316

Issue

01

Volume

01

Page

14/47

CONTROL UNIT I/O-B
LEFT TOILET

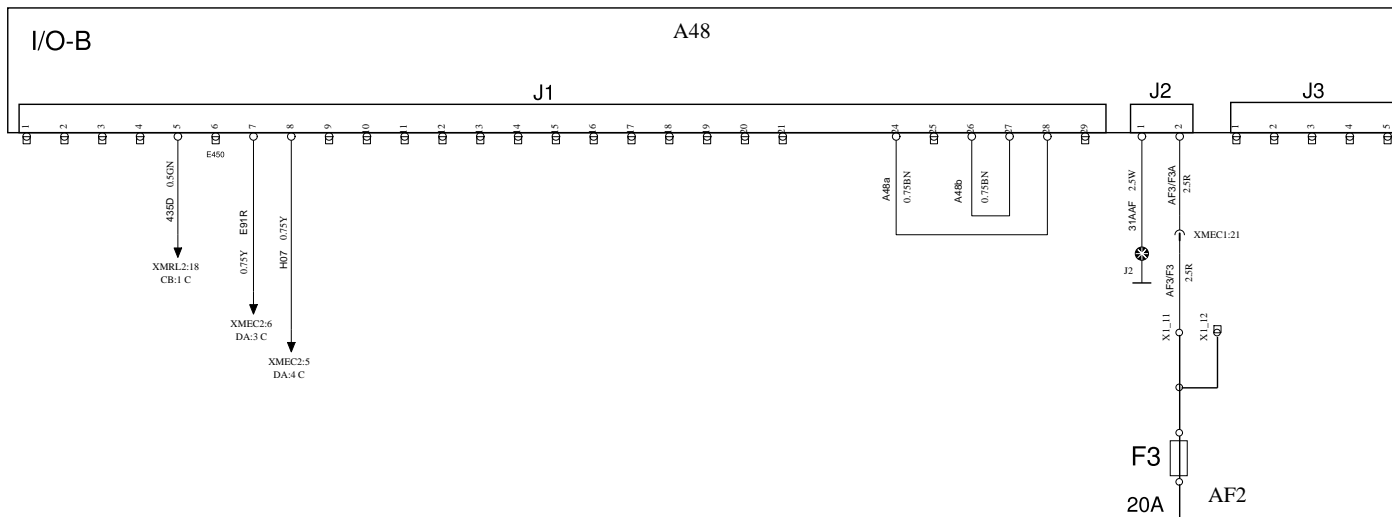
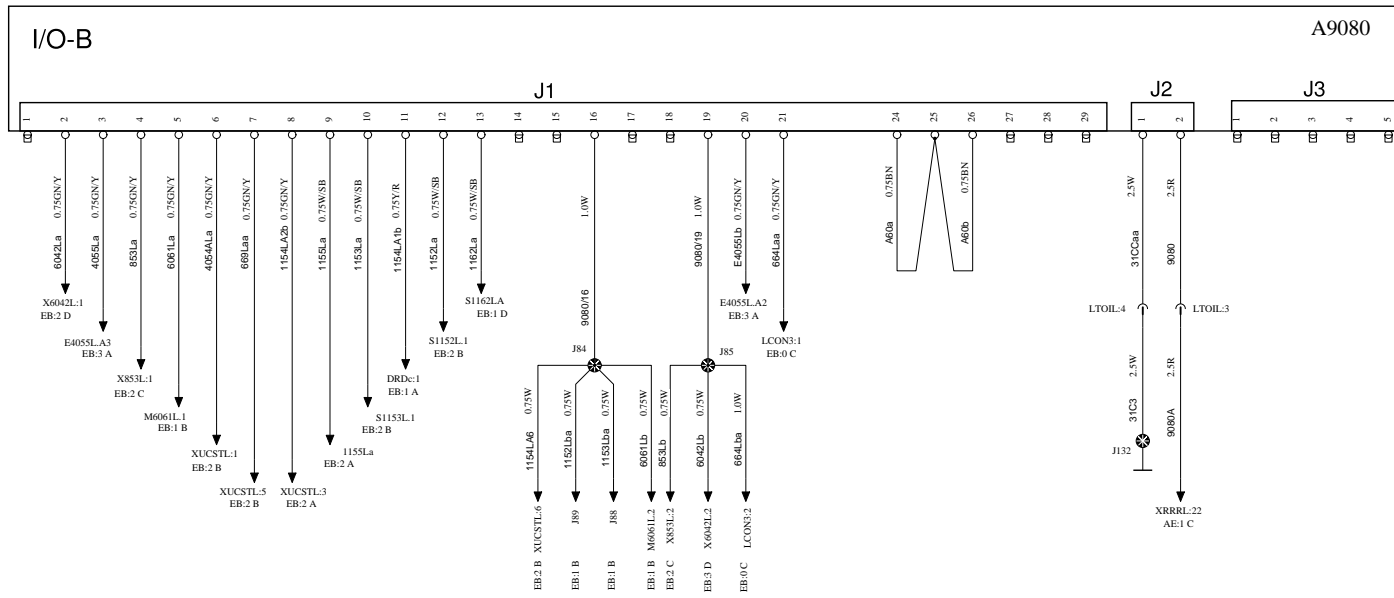

INTERIOR LIGHTS

INTERIOR LIGHTS

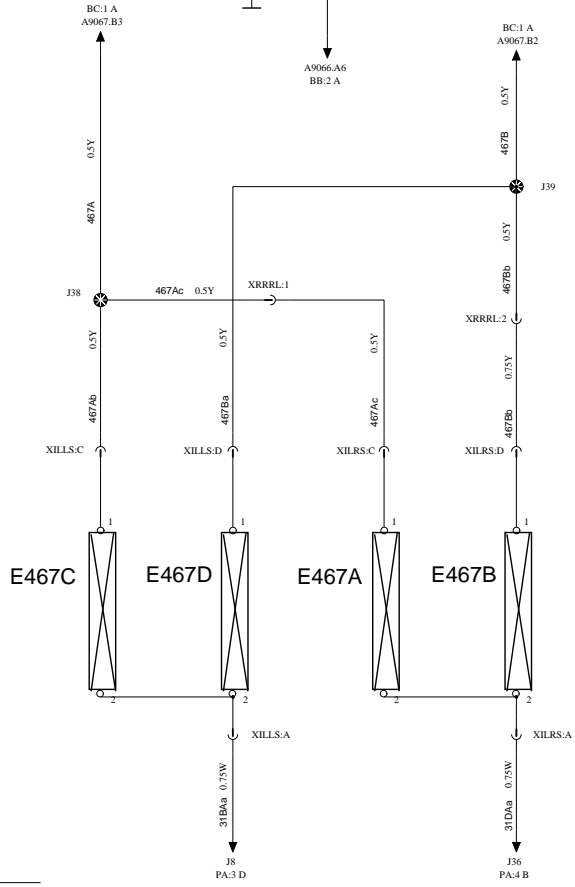
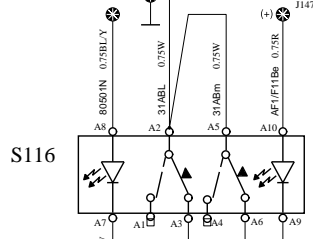

CA

SEAT NIGHT LIGHT

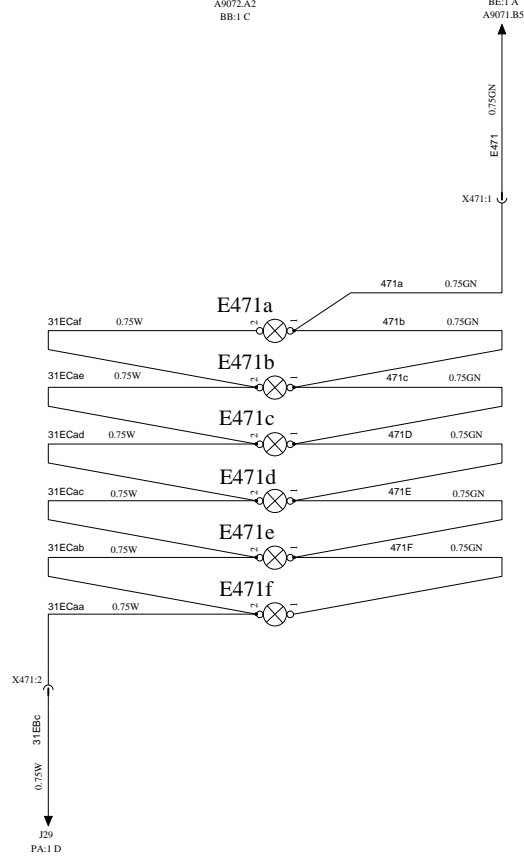
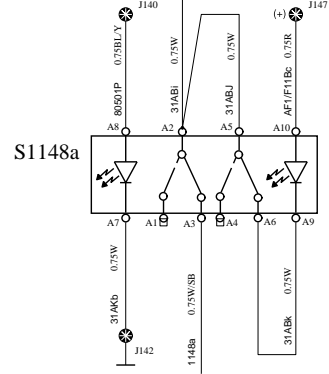

WIRING DIAGRAM

NIGHT LIGHT

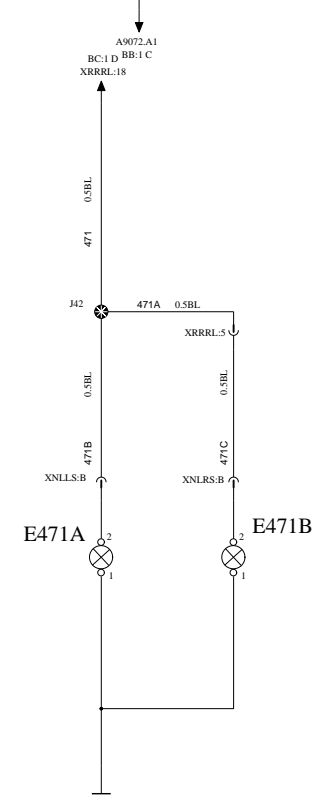
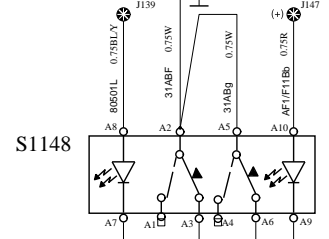

INTERIOR LIGHTS

LUMINESCENCE LAMP, BAND1

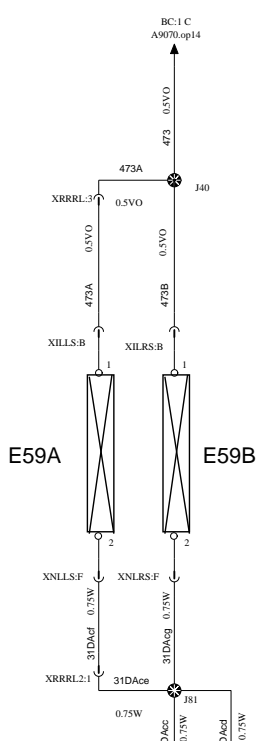

LUMINESCENCE LAMP, BAND2

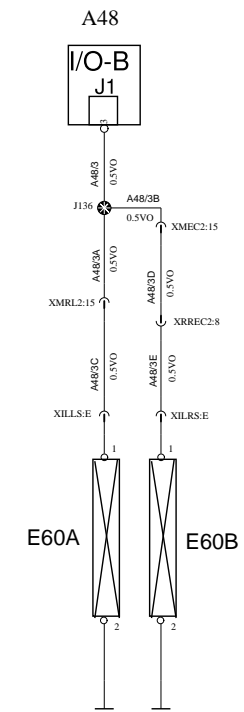

CB

READING LIGHTS

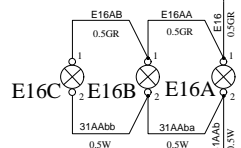
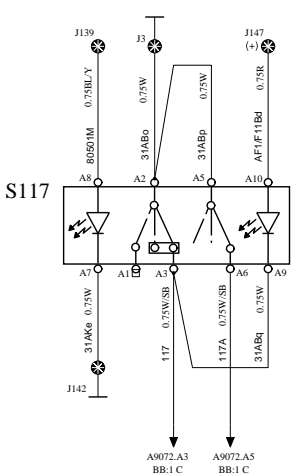

DRIVER & GUIDE LIGHT

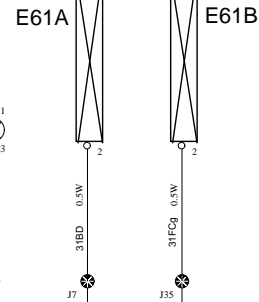
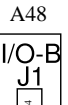
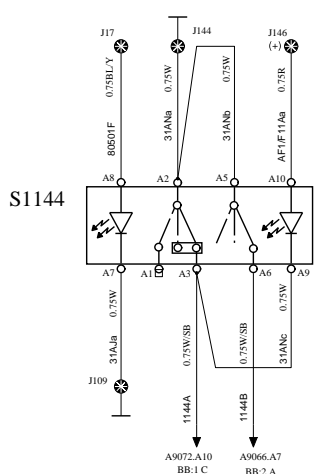

DESTINATION SIGN LIGHT

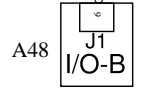
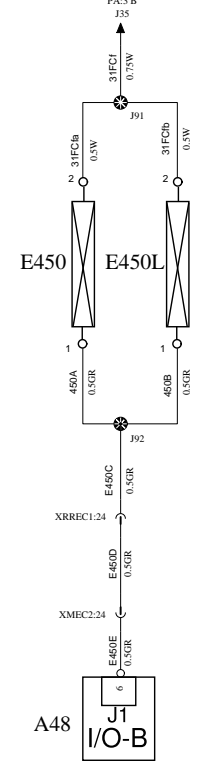
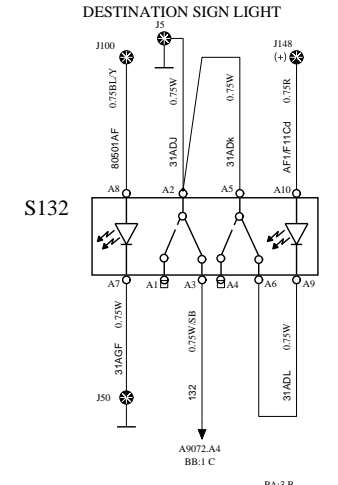

WIRING DIAGRAM

LUGGAGE LIGHTS

CC

WIRING DIAGRAM

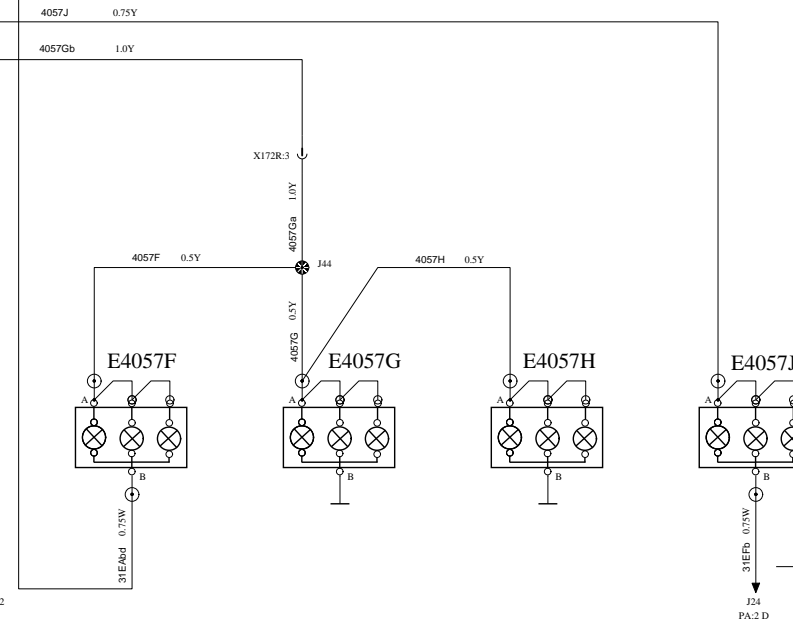
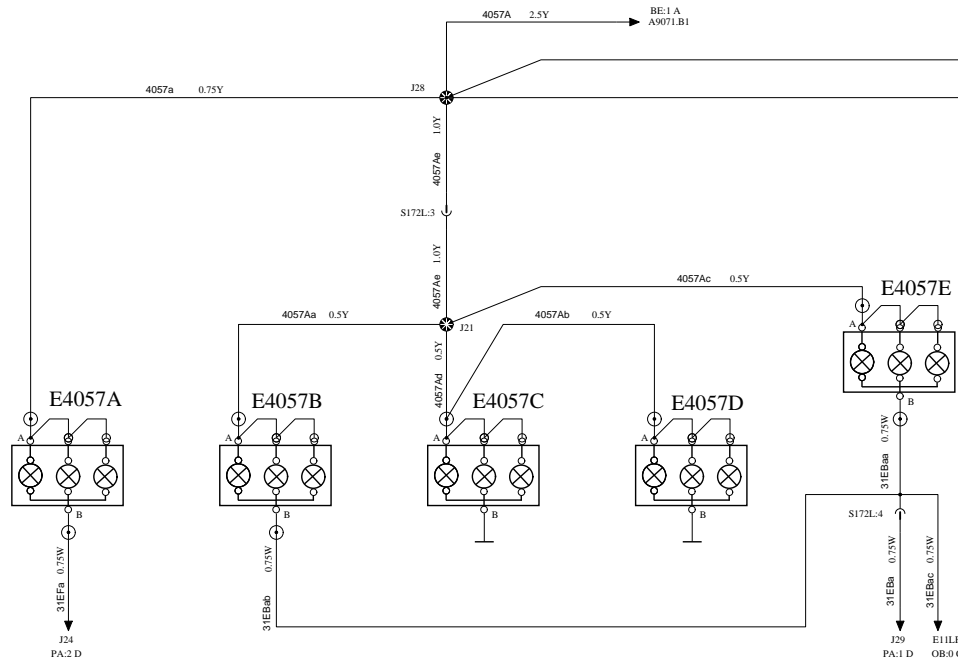
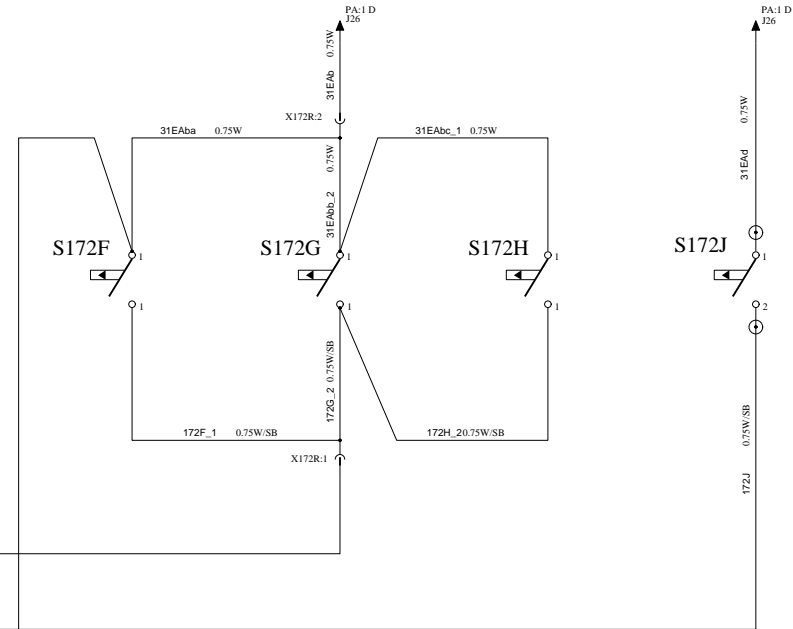
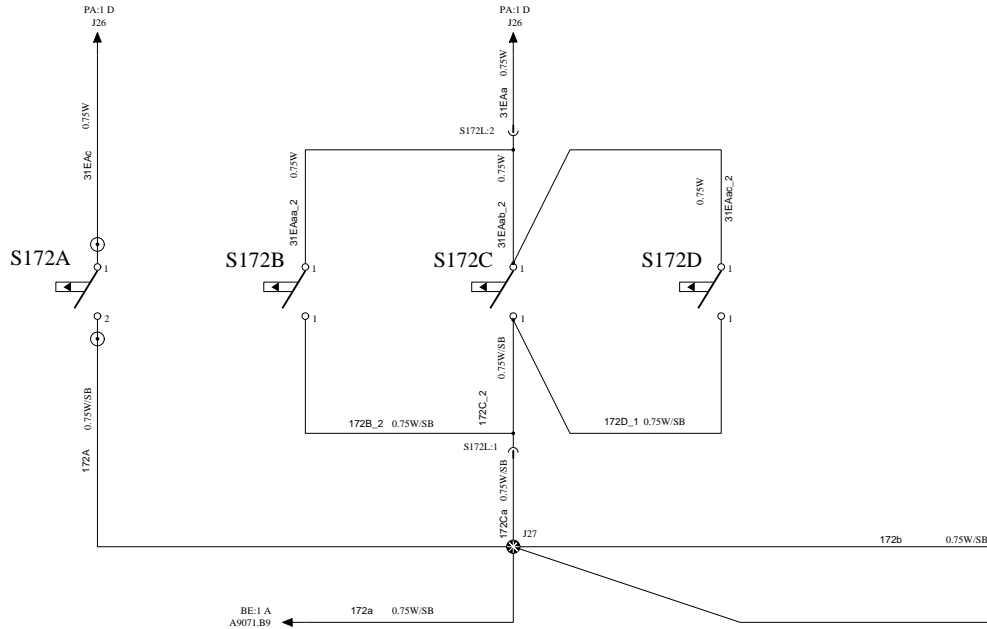

Volvo Bus Corporation

Document title
WIRING DIAGRAM
Document type
PRODUCT SCHEMATIC

Document No
21250316

Issue	Volume	Page
01	01	18/47

POSITION LIGHTS

DA

POSITION LIGHTS

WIRING DIAGRAM

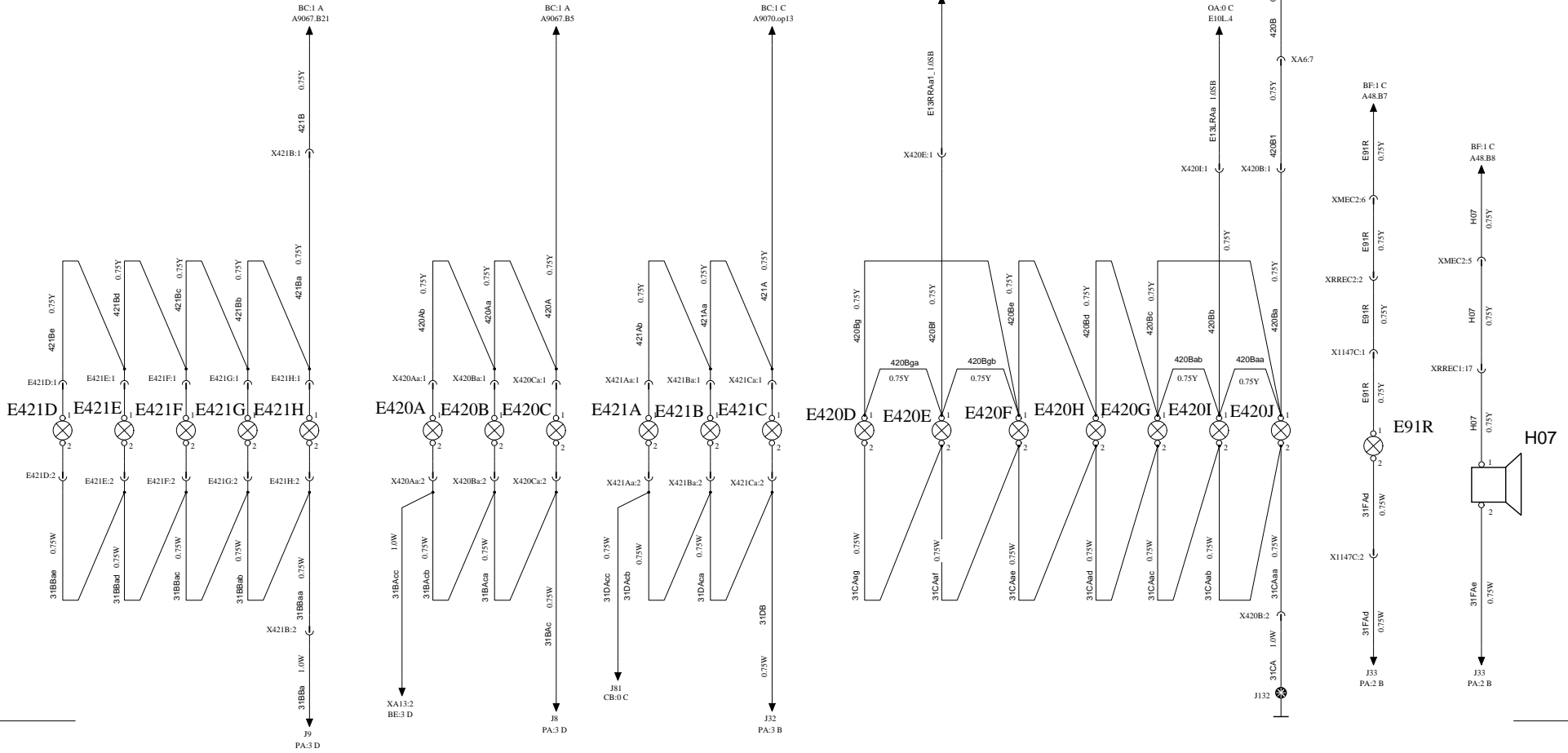
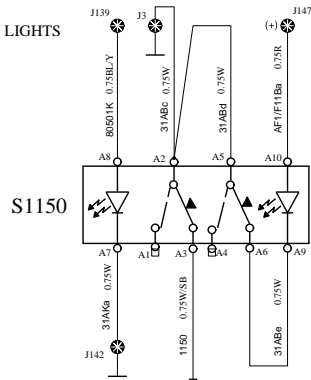

Volvo Bus Corporation

Document title
WIRING DIAGRAM
Document type
PRODUCT SCHEMATIC

Document No
21250316

Issue
01

Volume
01

Page
19/47

TOILET

WIRING DIAGRAM

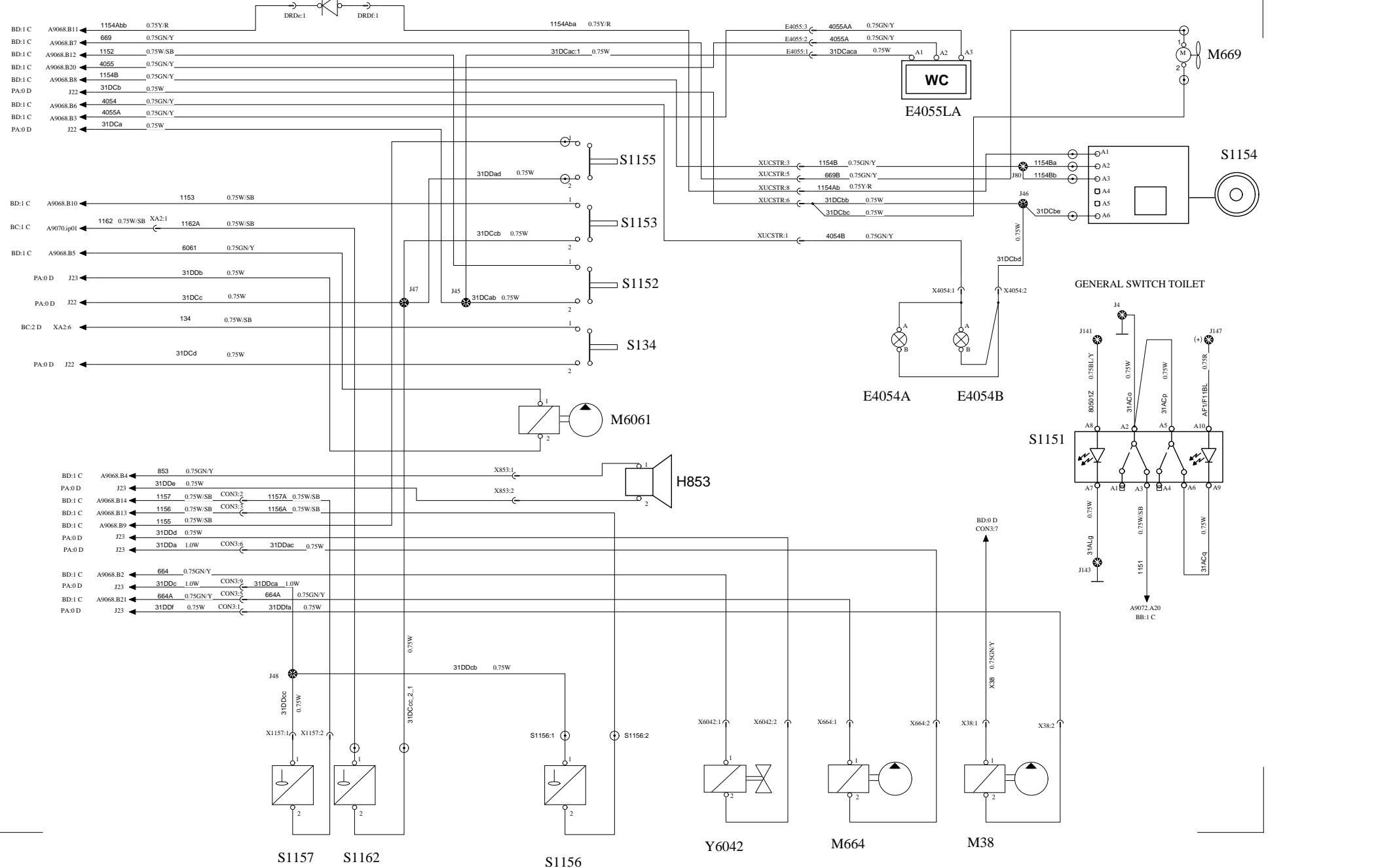

LEFT TOILET

WIRING DIAGRAM

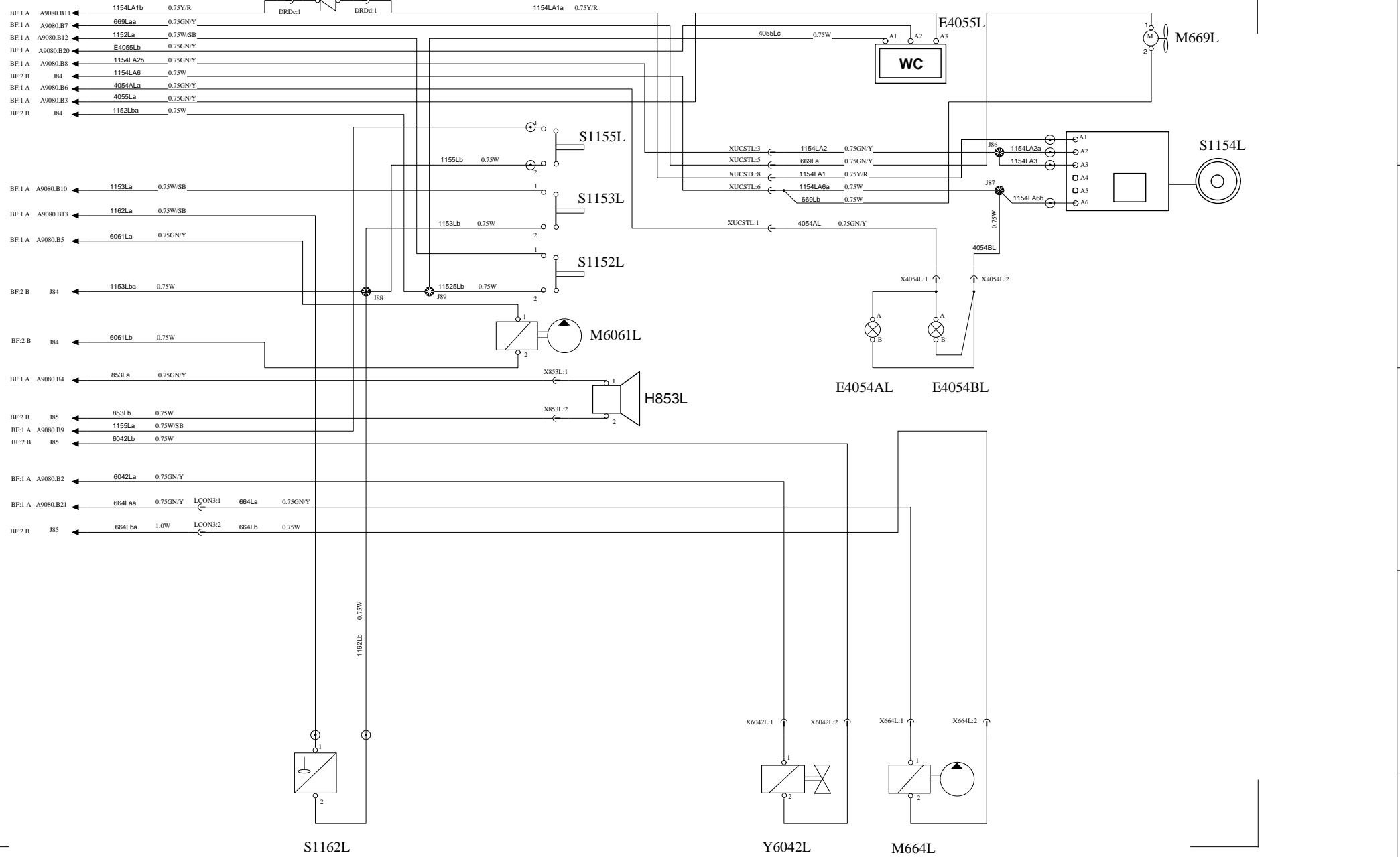

Volvo Bus Corporation

Document title WIRING DIAGRAM
Document type PRODUCT SCHEMATIC

Document No	Issue	Volume	Page
21250316	01	01	21/47

KITCHEN

FA

WIRING DIAGRAM

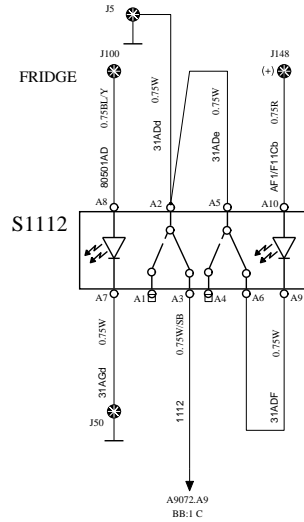
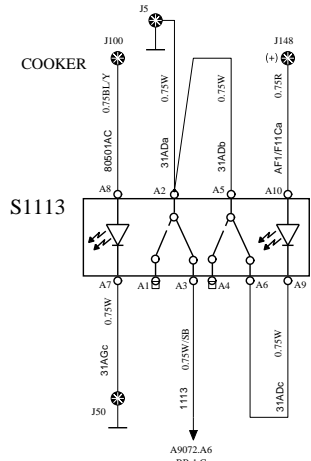

KITCHEN LIGHT

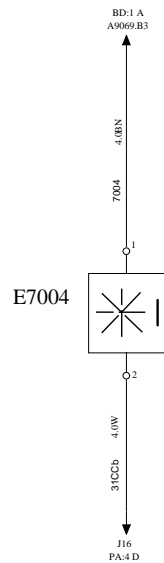
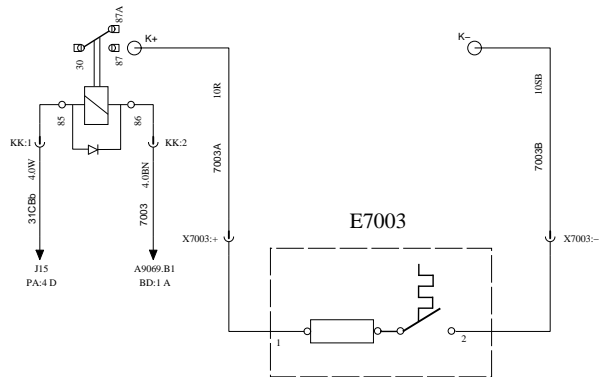
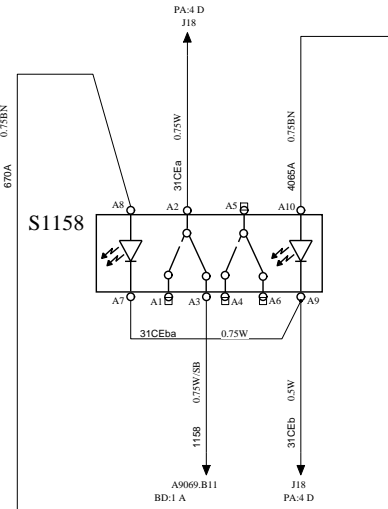

M670

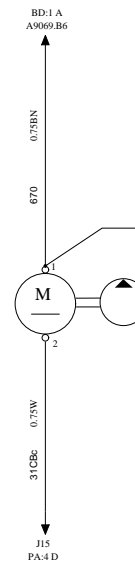

E4065

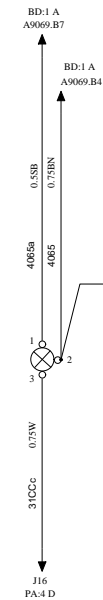

DRC

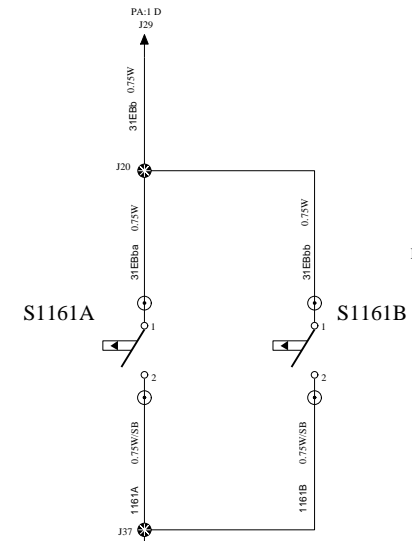

GA

LIGHTING SLEEPER CAB

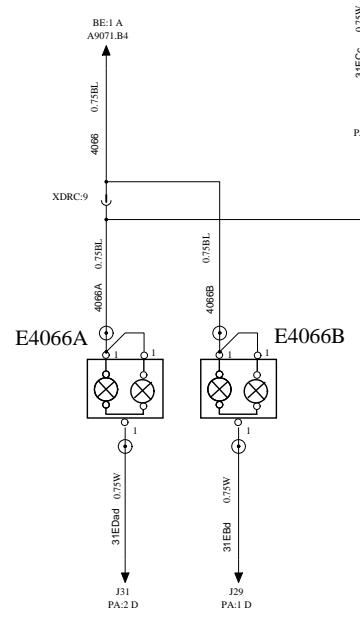

BERTH FAN

S1160

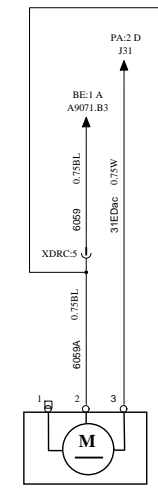

WIRING DIAGRAM

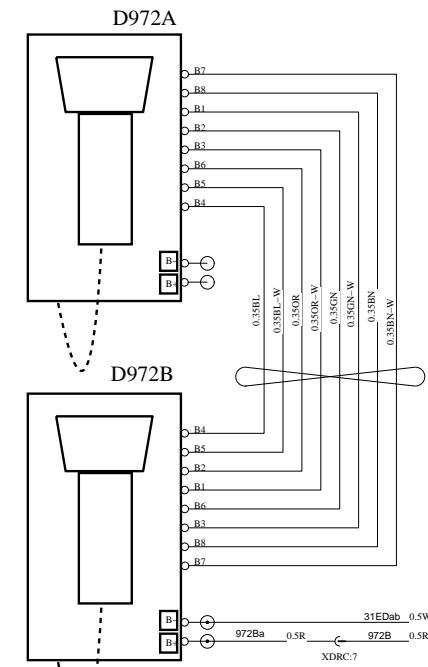

E566

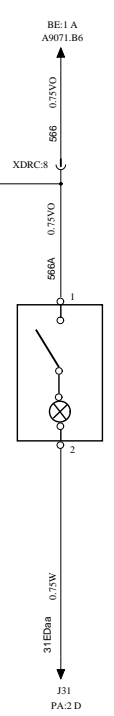

M6059

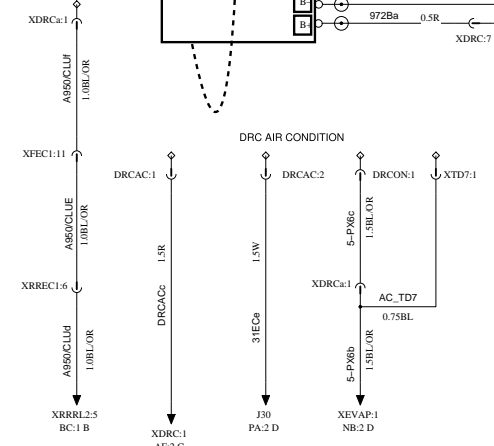
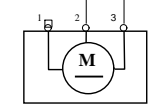

DOOR CONTROL

HA

WIRING DIAGRAM

SERVICE DOOR

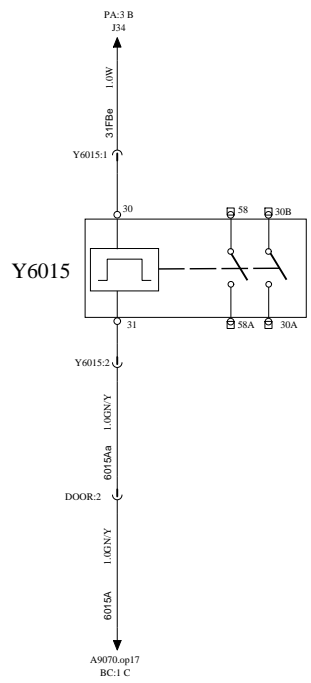
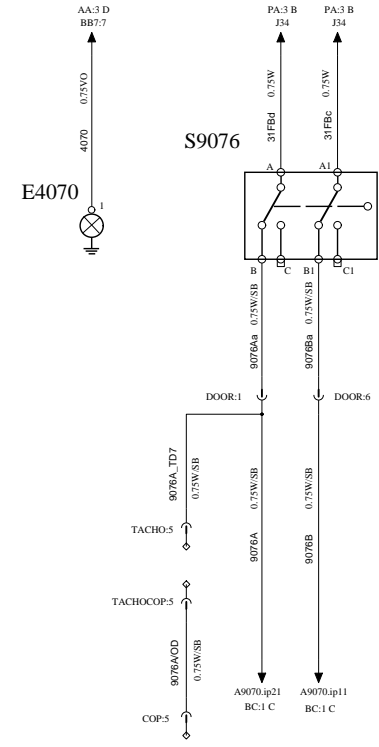
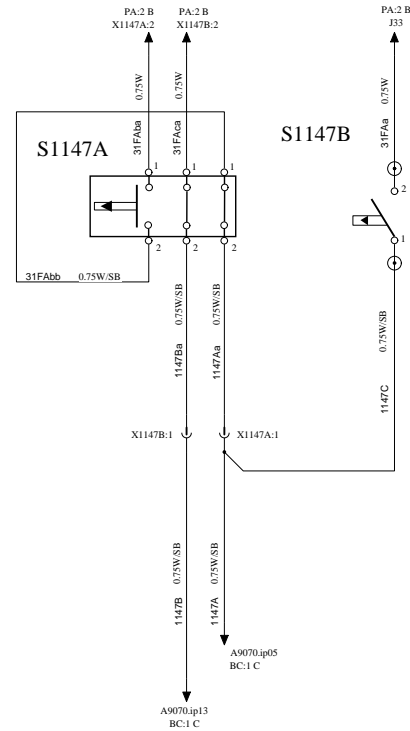
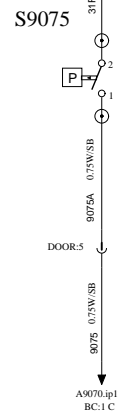
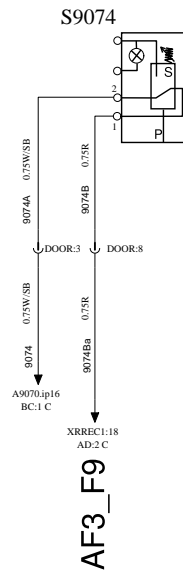
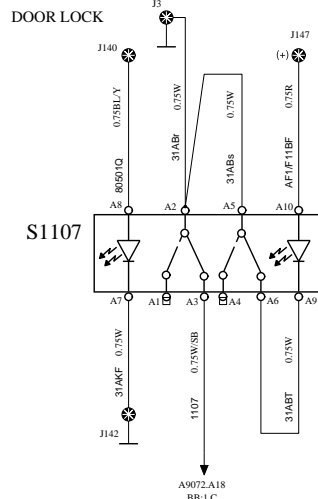
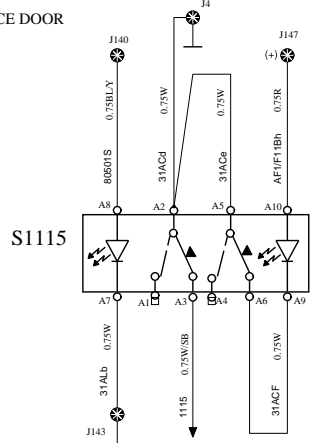

AUXILIARY STEP

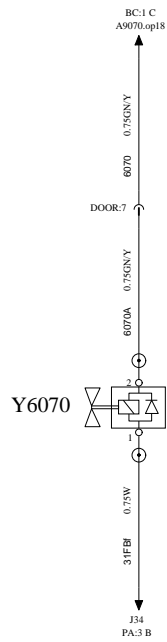
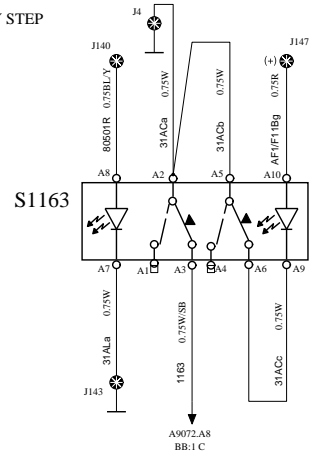

E4055A

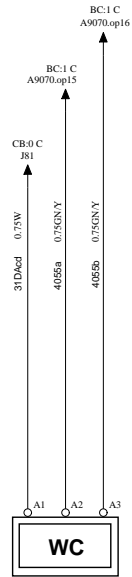

E4055AL

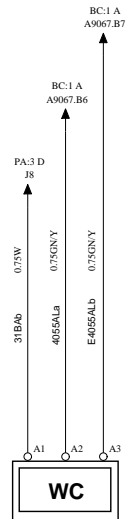

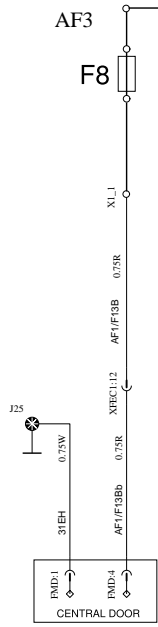
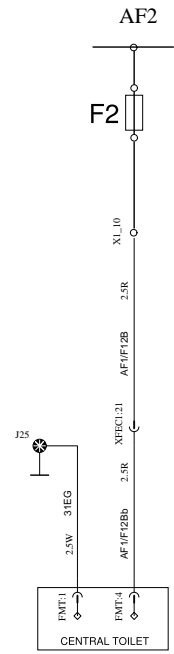

Switch, Middle Door

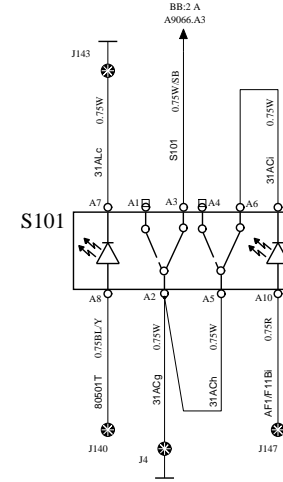

ACCESORIES

IA

WIRING DIAGRAM

BULB, ENGINE COMPARTMENT

CENTRAL LOCK

Switch, Extractor Roof Hatch

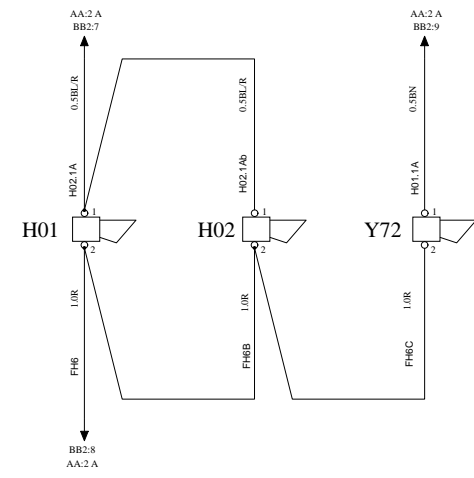
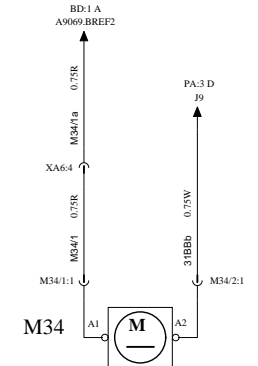
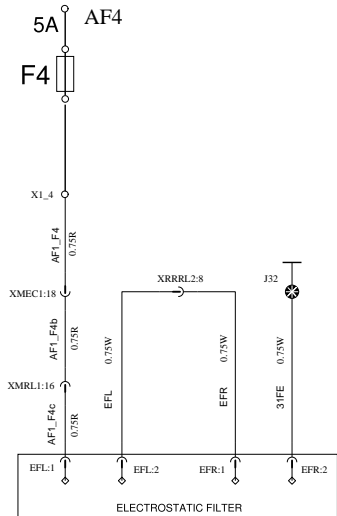
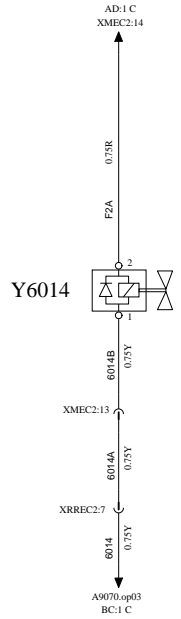
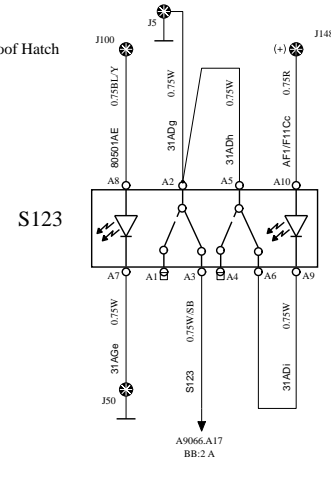
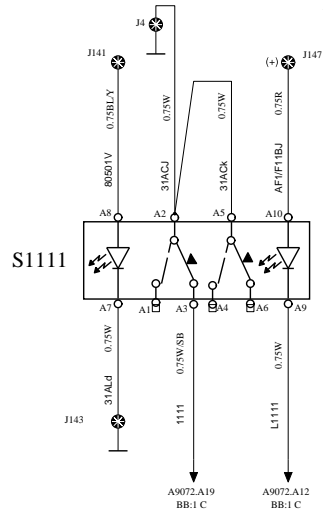
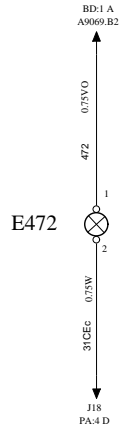

Volvo Bus Corporation

Document title
WIRING DIAGRAM
Document type
PRODUCT SCHEMATIC

Document No	Issue	Volume	Page
21250316	01	01	27/47

SNAKE LAMP, ELECTRIC CENTRE

SNAKE LAMP, MAP LIGHT

TIME & TEMPERATURE DISPLAY

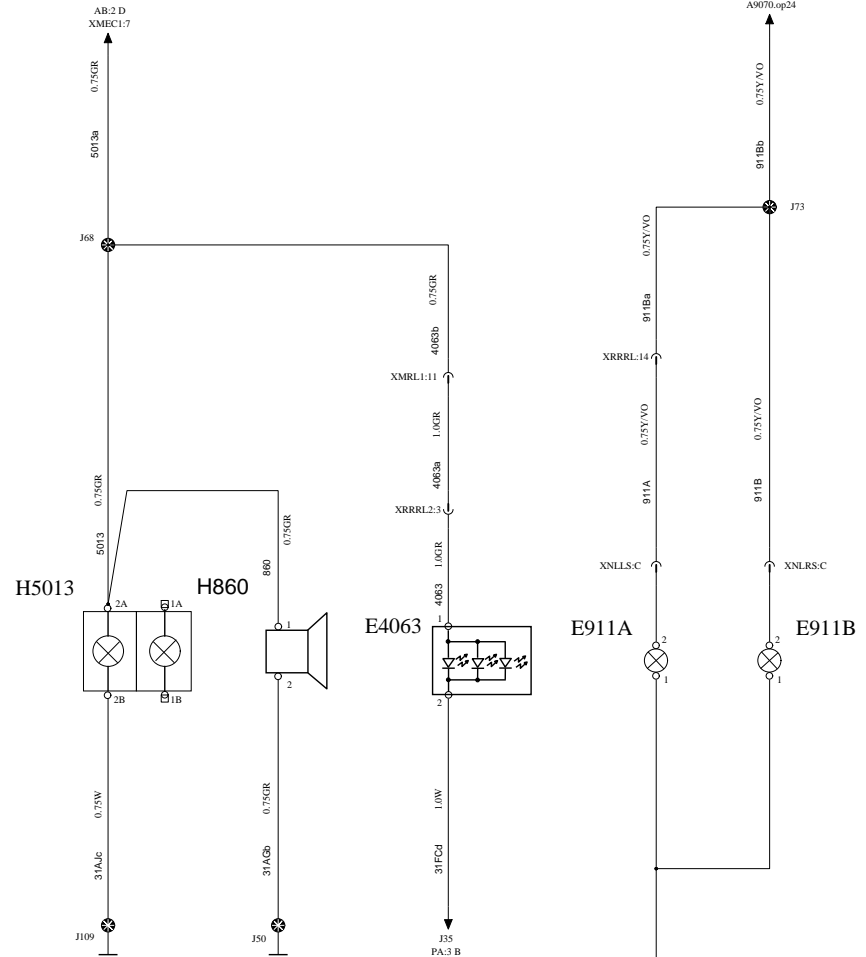
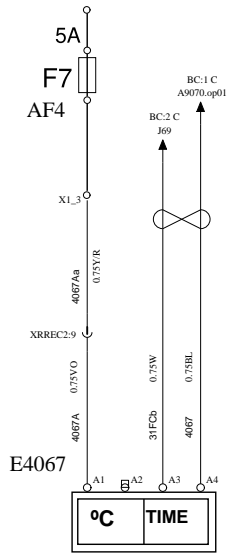
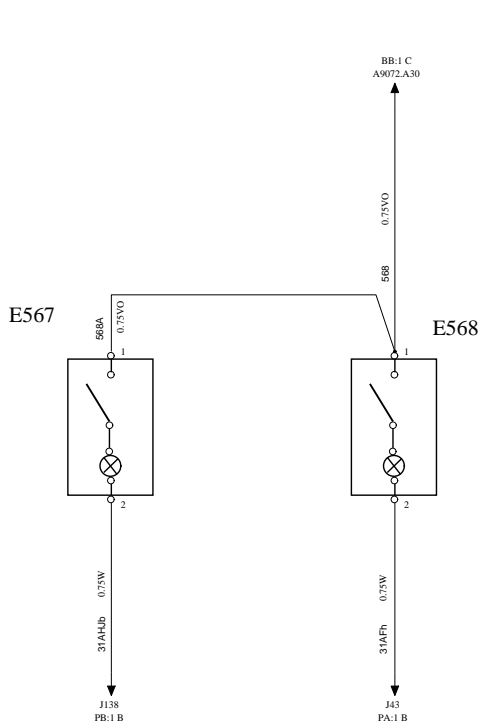

TD7 TACHOGRAPH

IC

WIRING DIAGRAM

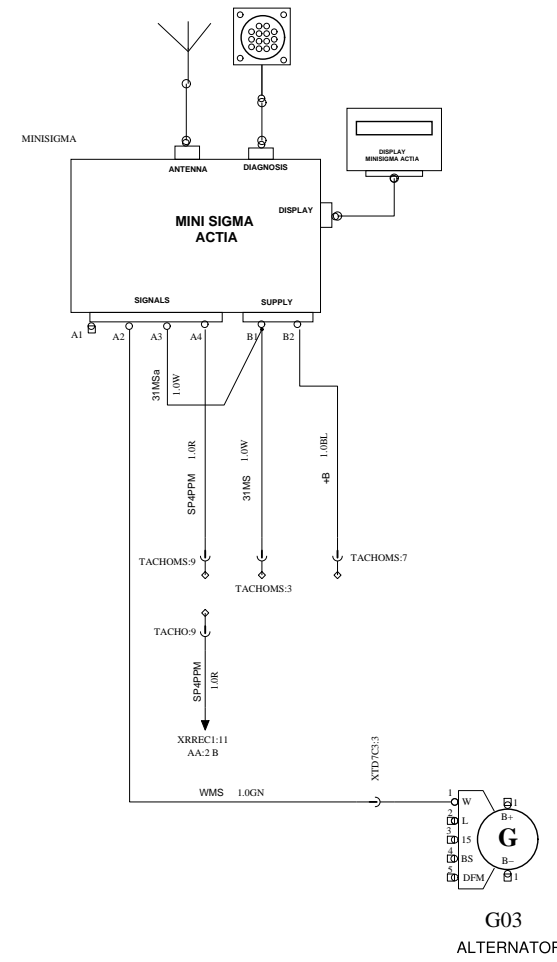
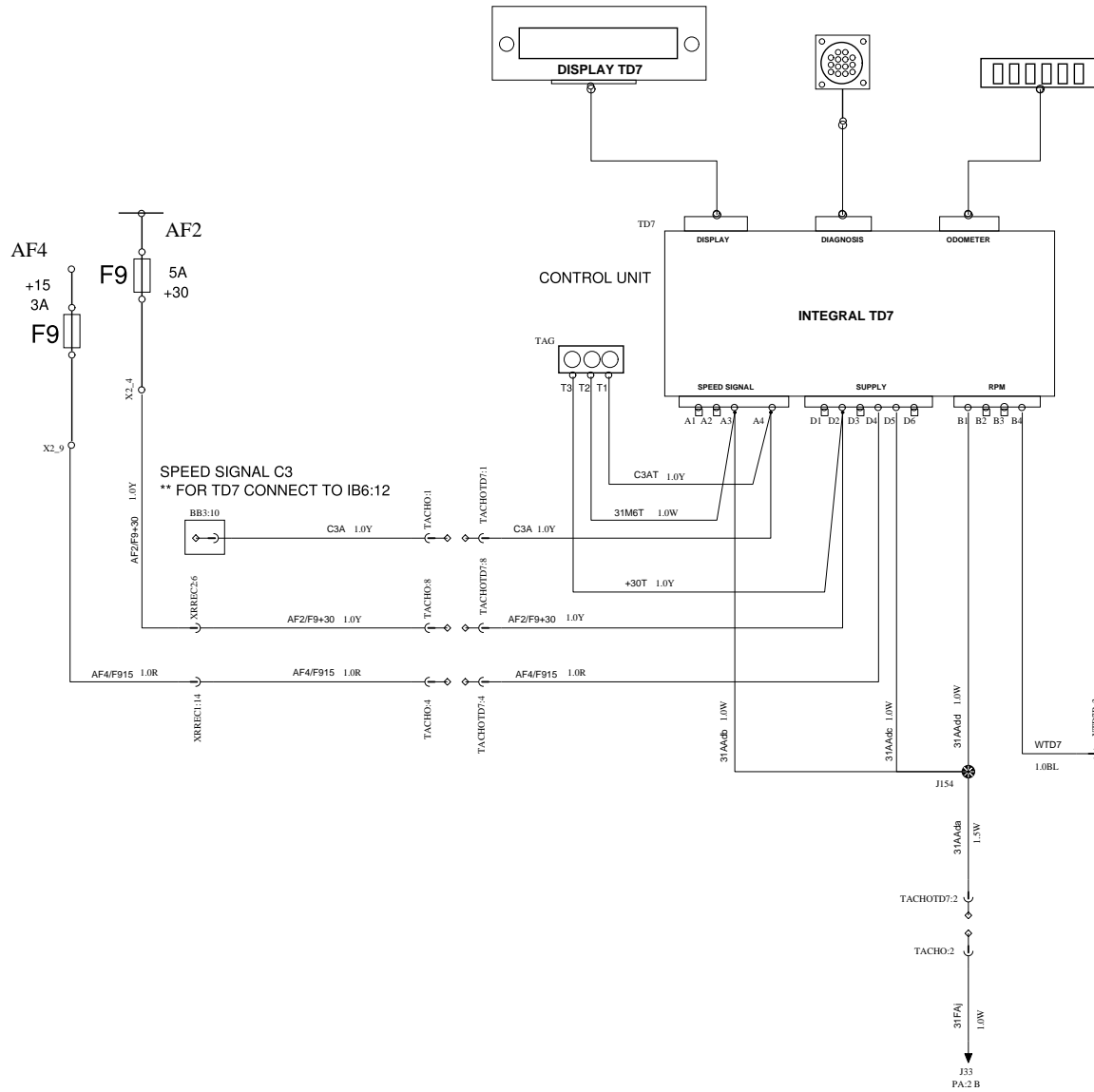

FANS, BLINDERS & MIRRORS

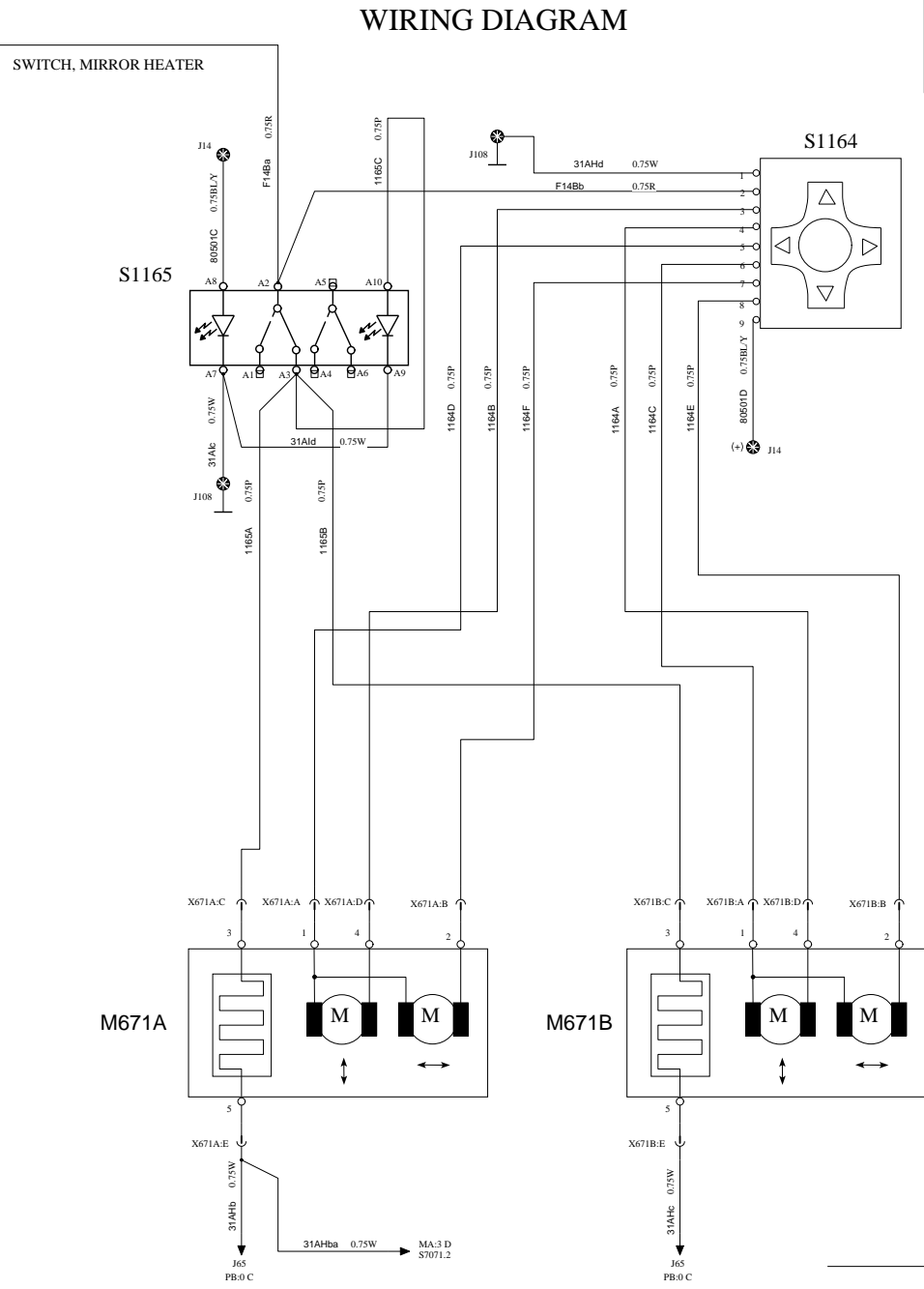
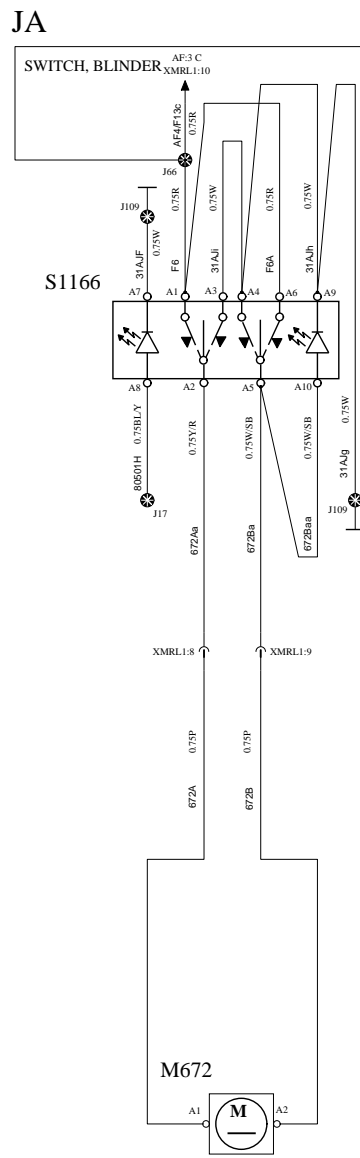
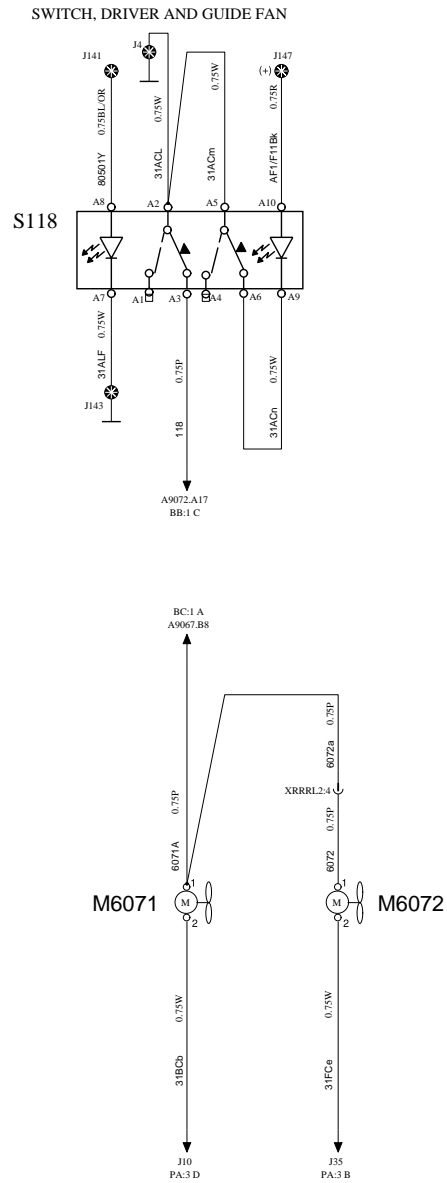

ELECTRIC WINDOW & ROOF HATCHES

JB

WIRING DIAGRAM

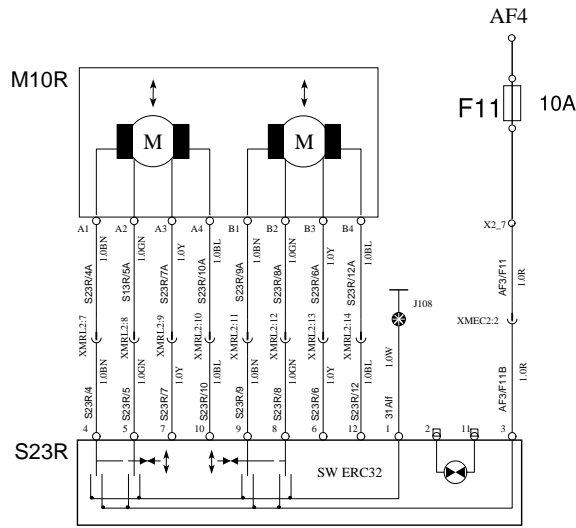
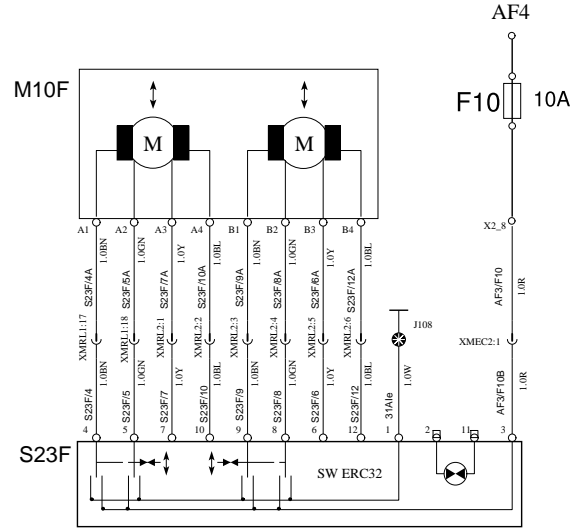

S127 SWITCH, WINDOW HEATER

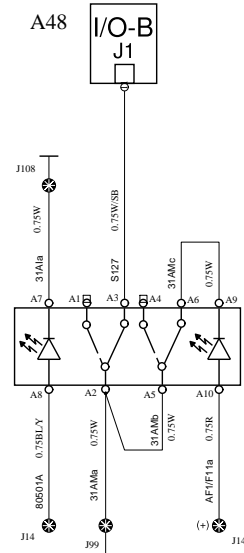

S126 SWITCH, DRIVER WINDOW

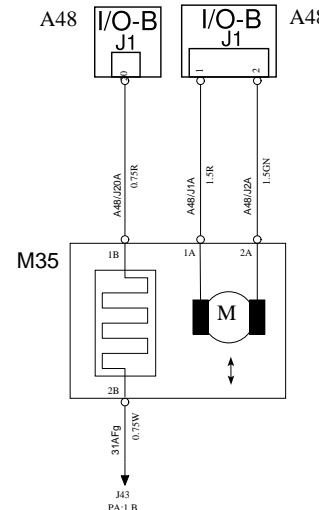
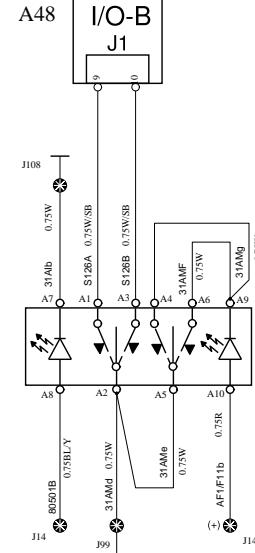

EMERGENCY WINDOWS

JC

WIRING DIAGRAM

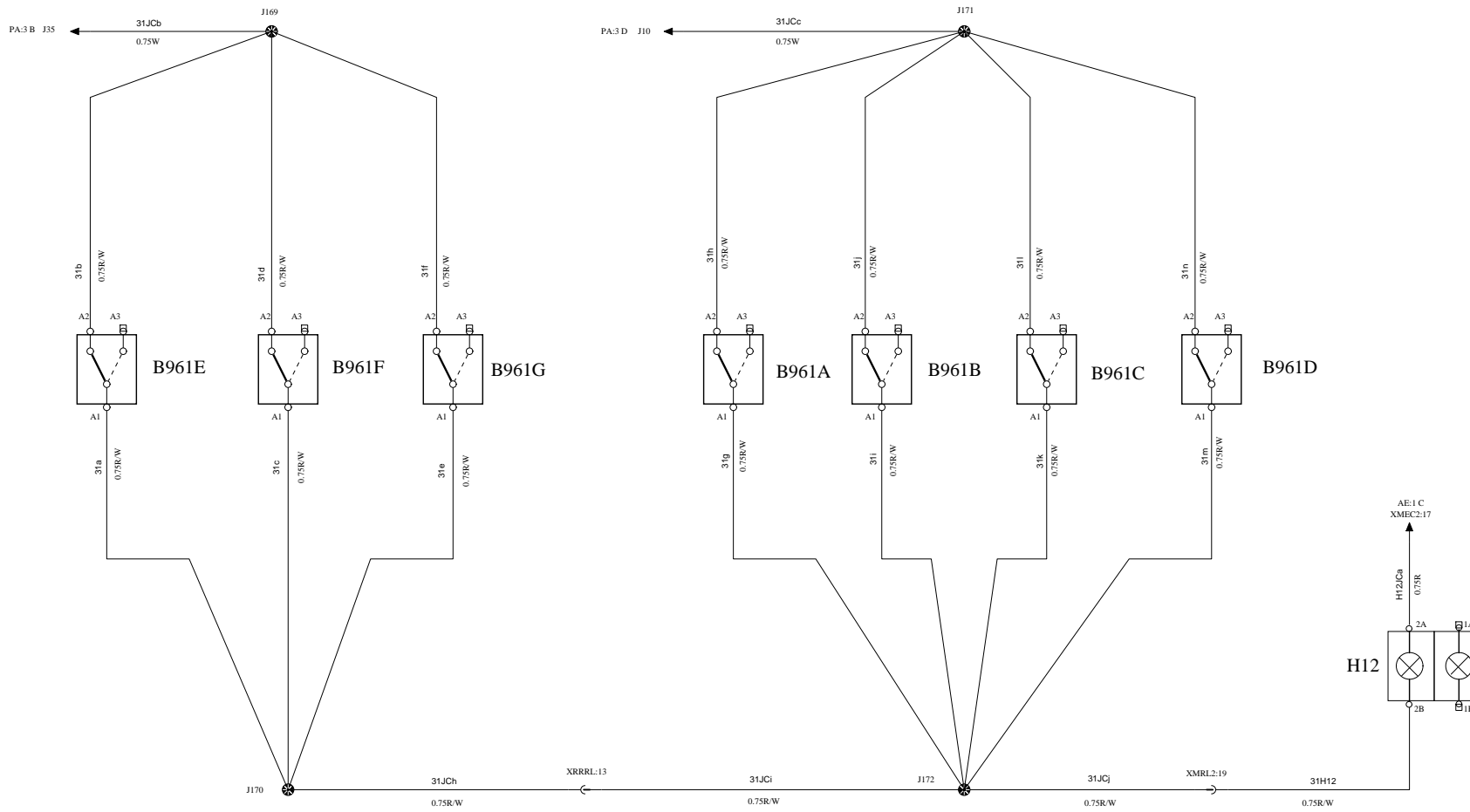

Volvo Bus Corporation

Document title WIRING DIAGRAM
Document type PRODUCT SCHEMATIC

Document No 21250316	Issue 01	Volume 01	Page 32/47
--------------------------------	--------------------	---------------------	----------------------

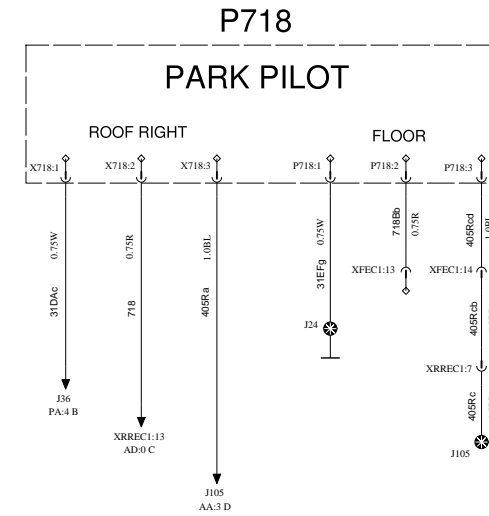
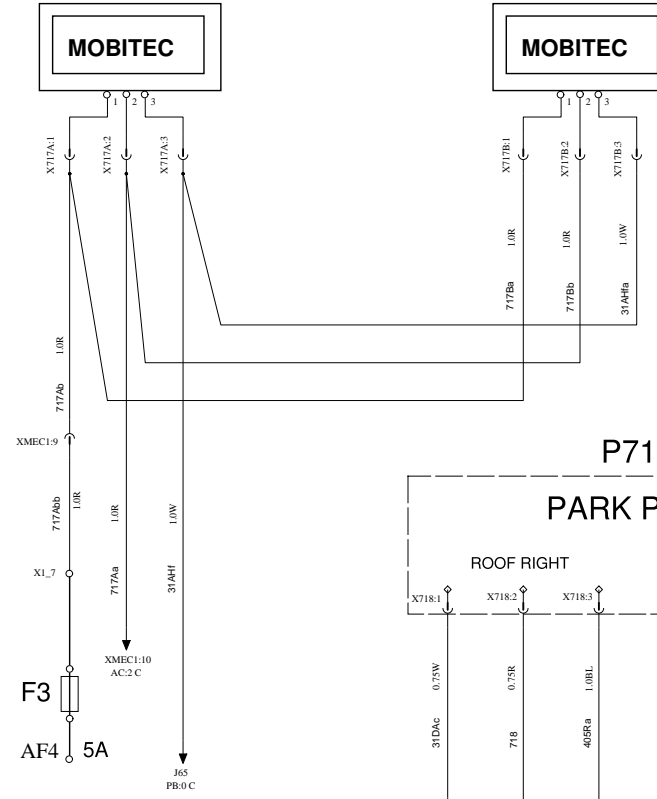
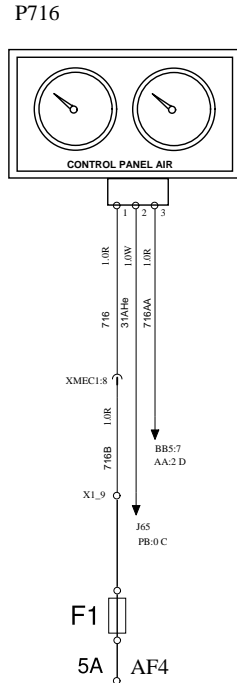
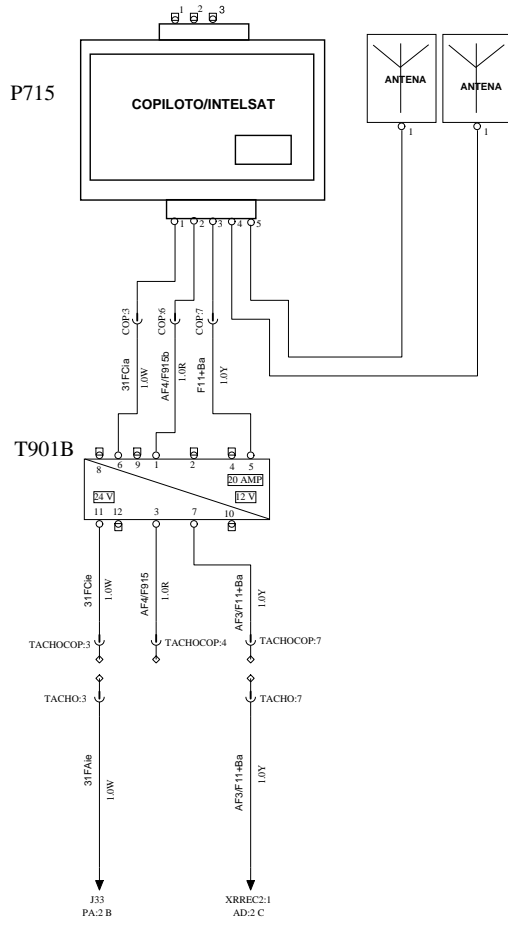

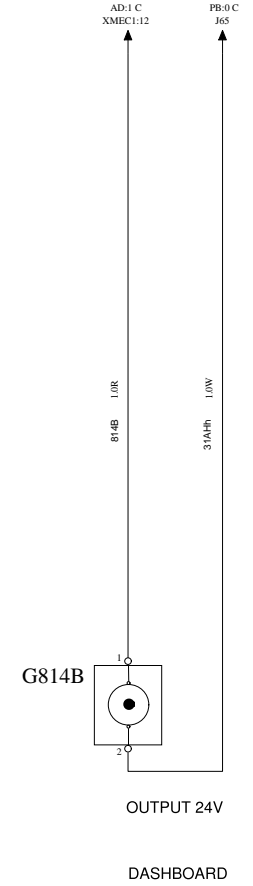
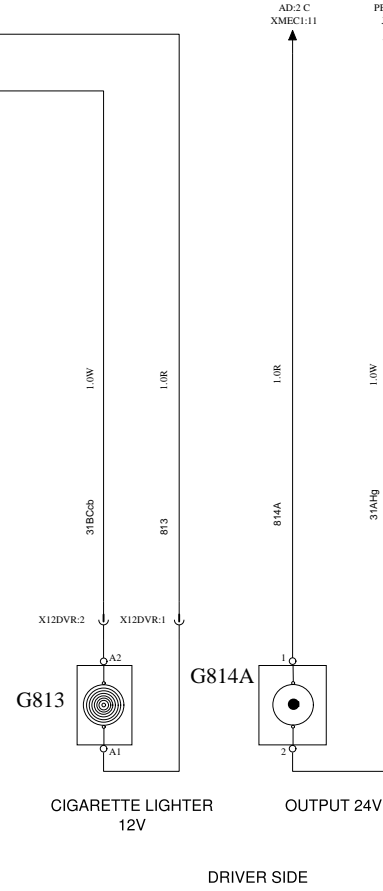
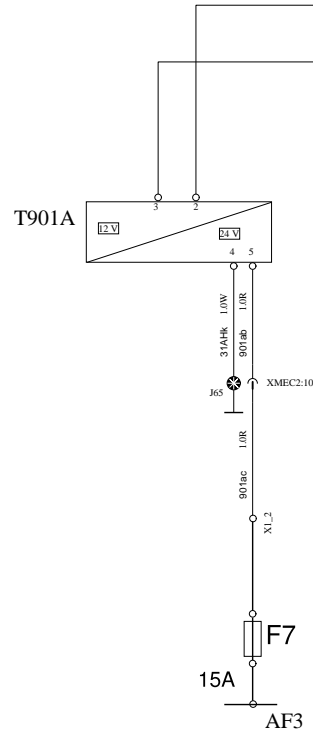
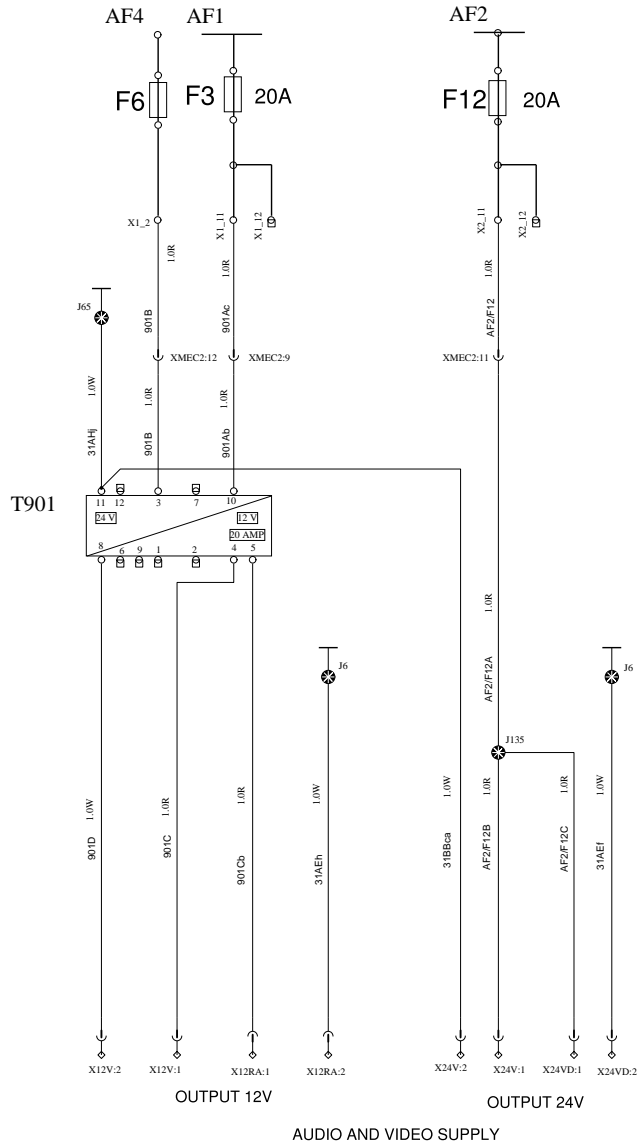

AUDIO

LB

WIRING DIAGRAM

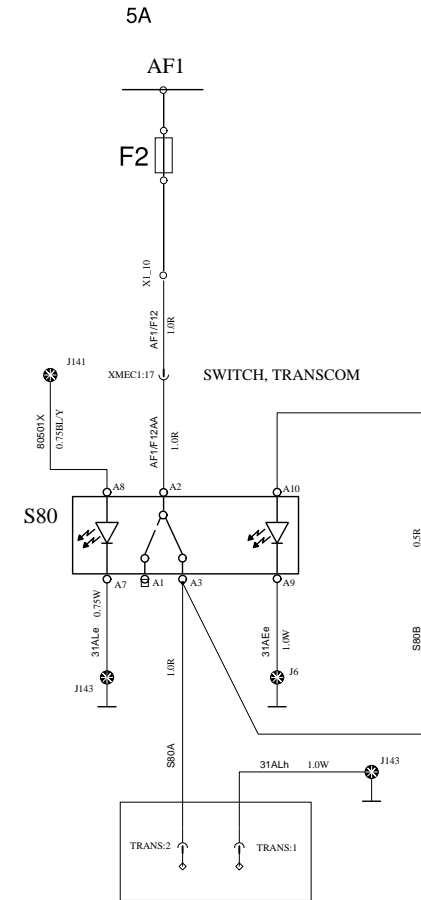
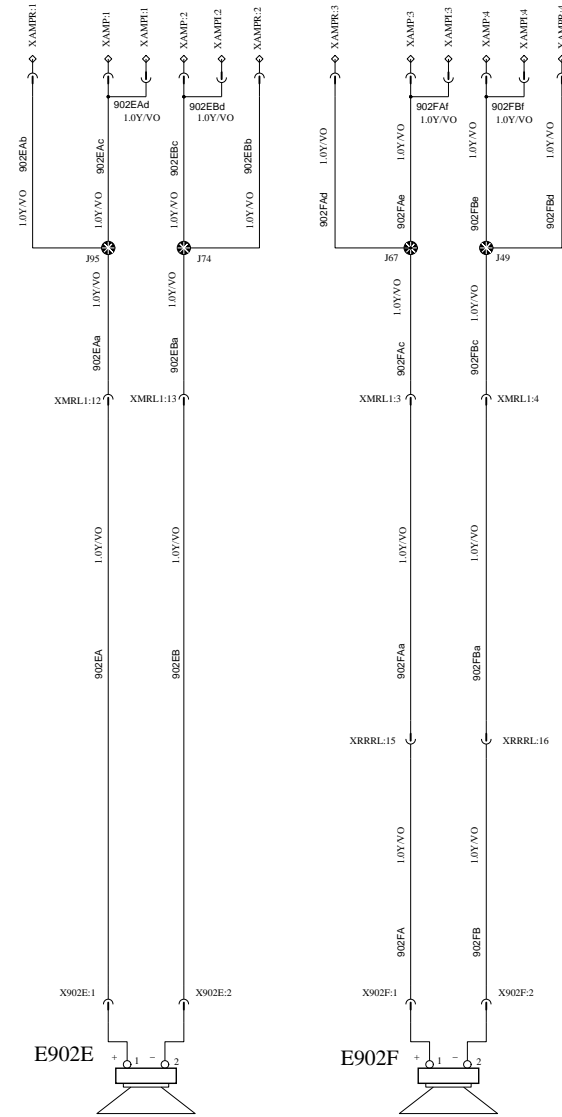
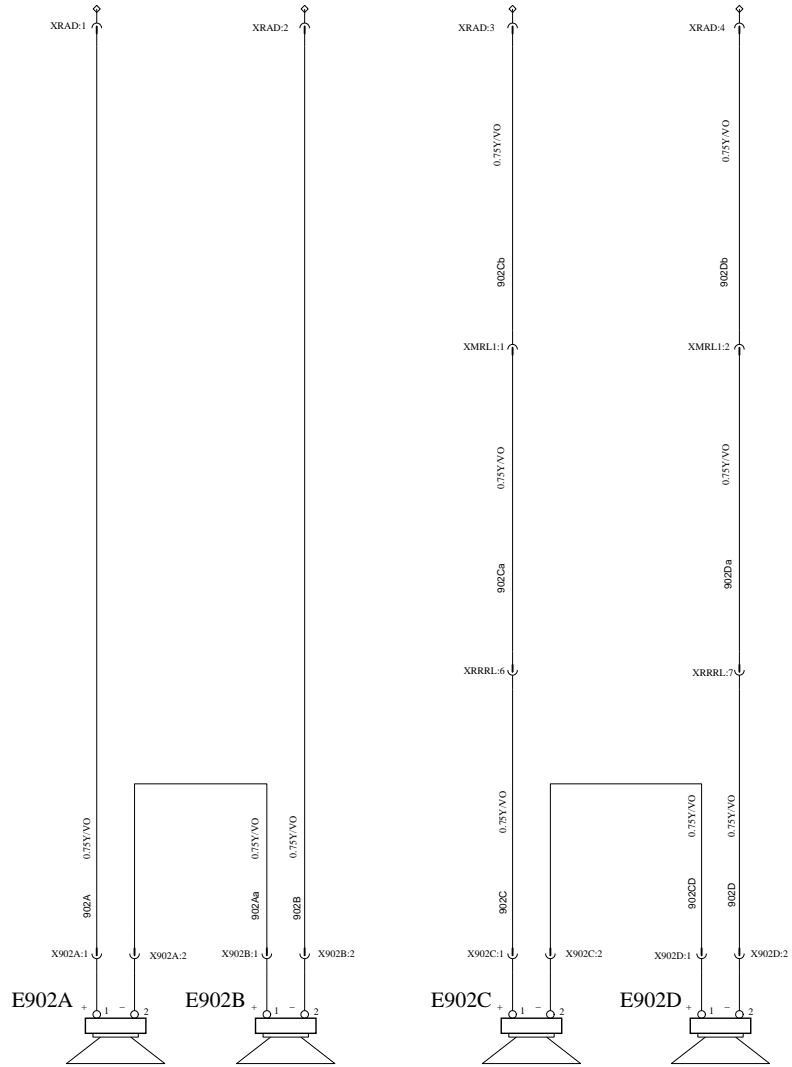

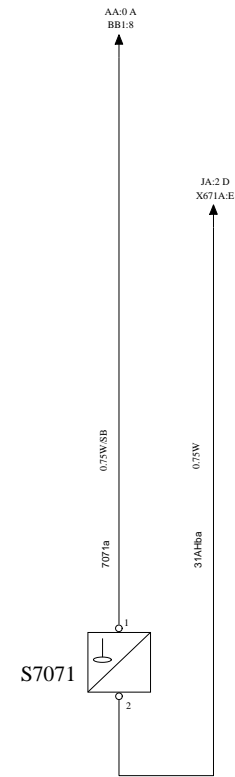
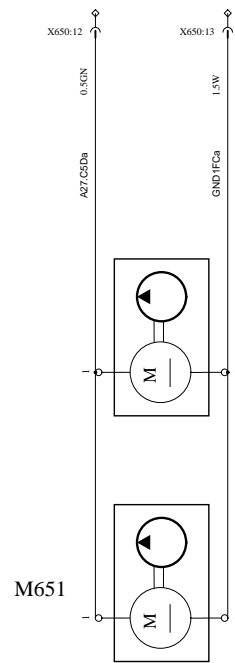
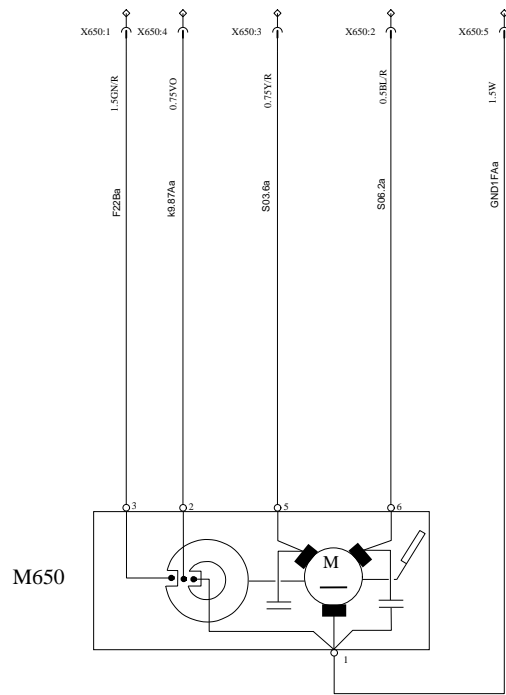

CONTROL UNIT, CLIMATE DISPLAY

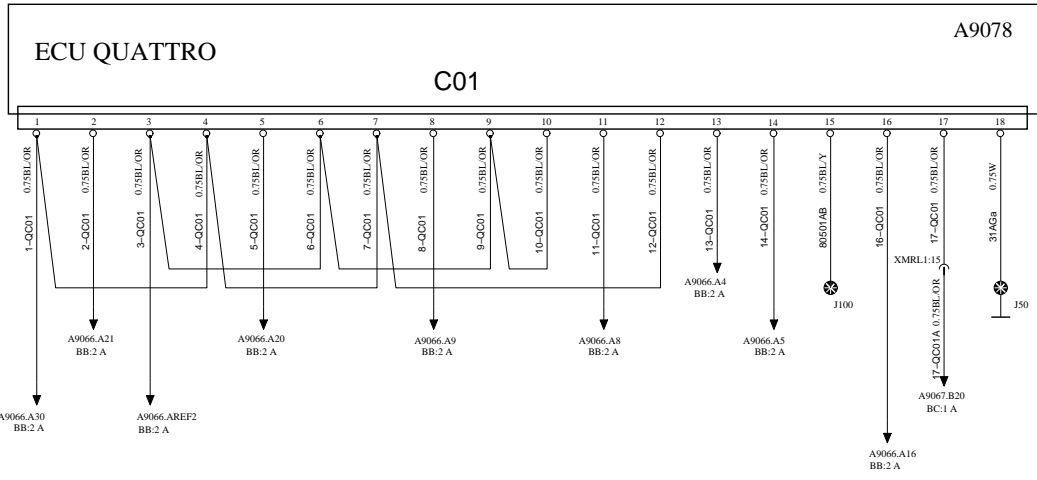

DRIVER TEMP. SENSOR

DEFROSTER TEMP. SENSOR

OUTSIDE TEMP. SENSOR

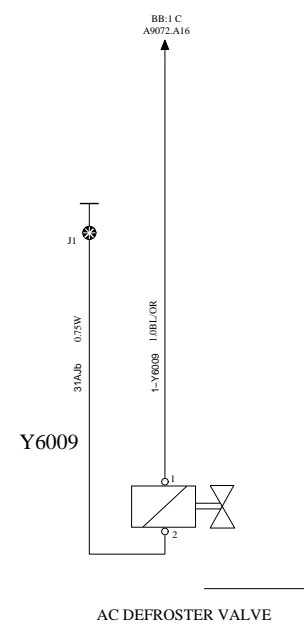
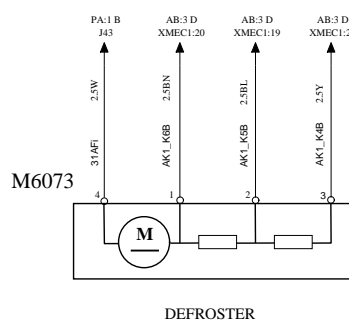
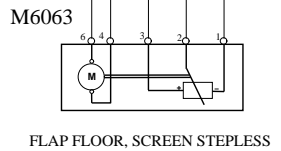
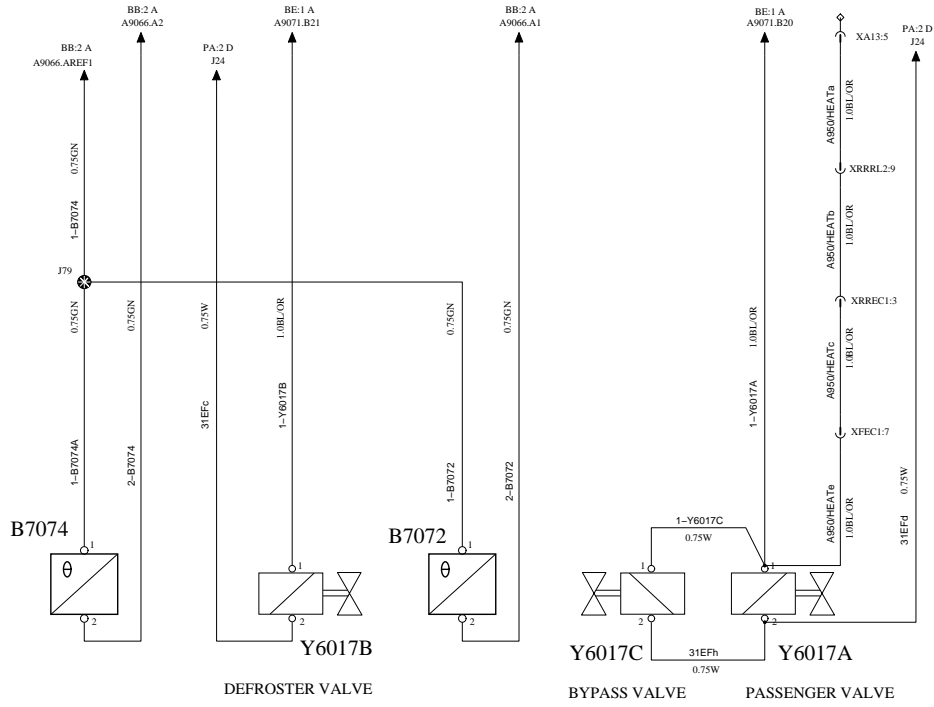

AIR CONDITIONING, SYSTEM 1

NB

WIRING DIAGRAM

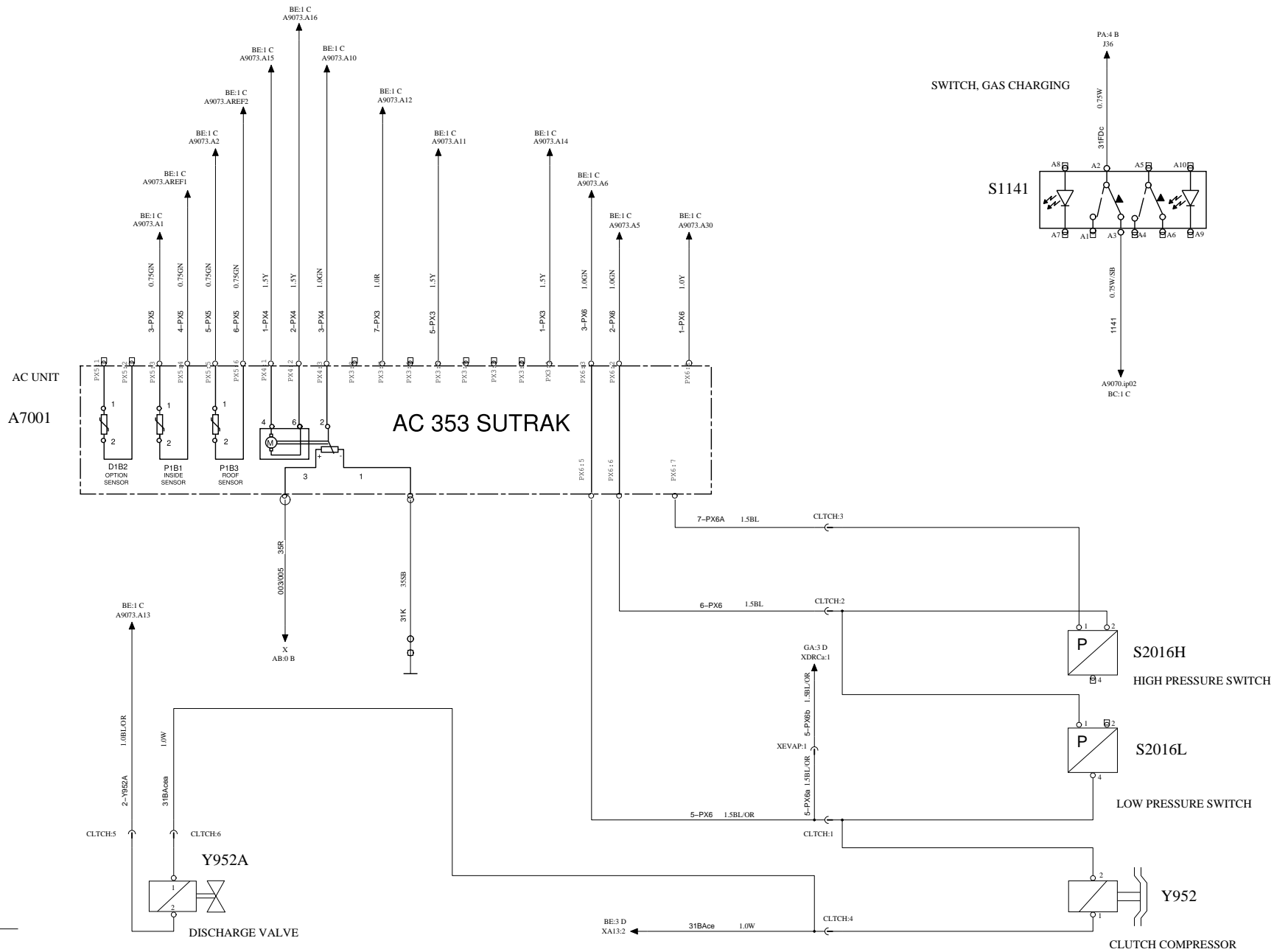

Volvo Bus Corporation

Document title
WIRING DIAGRAM

Document type
PRODUCT SCHEMATIC

Document No

21250316

Issue

01

Volume

01

Page

38/47

RE-HEATING SYSTEM

NC

WIRING DIAGRAM

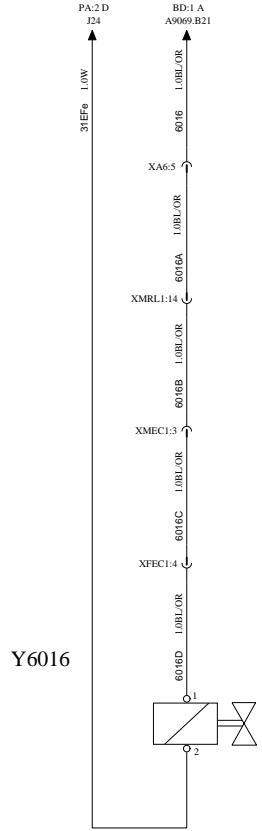

ROOF VALVE, REHEATING SYSTEM

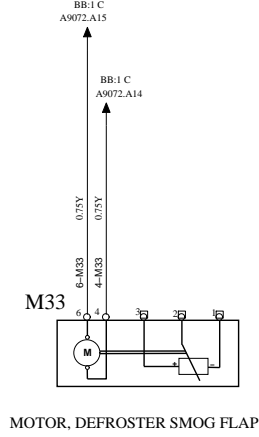

MOTOR, DEFROSTER SMOG FLAP

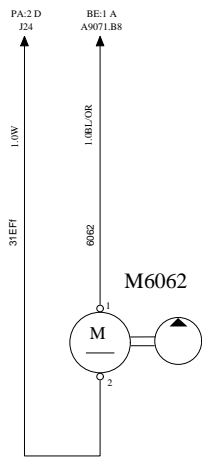

CIRCULATION PUMP, REHEATING SYS

This is included in Webasto

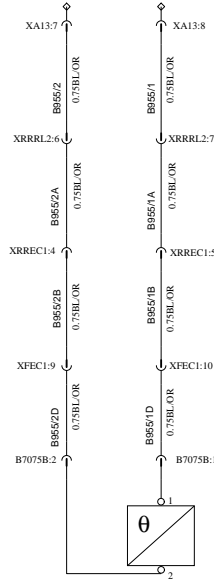

PASSENGER SENSOR, REHEATING SYS

*This is for Thermo King variant

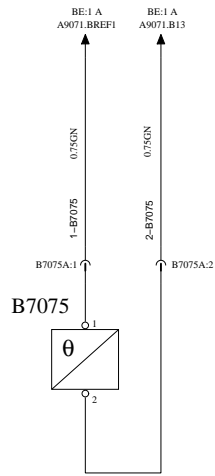

FAN, REHEATING SYSTEM

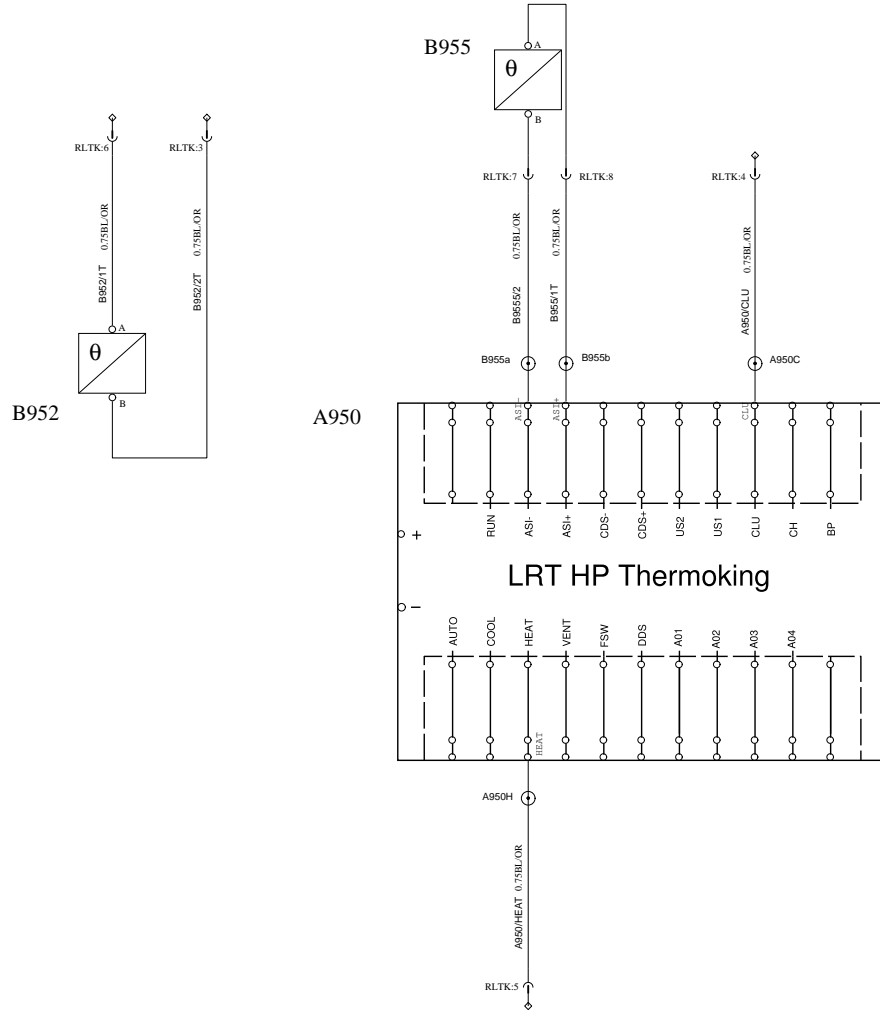

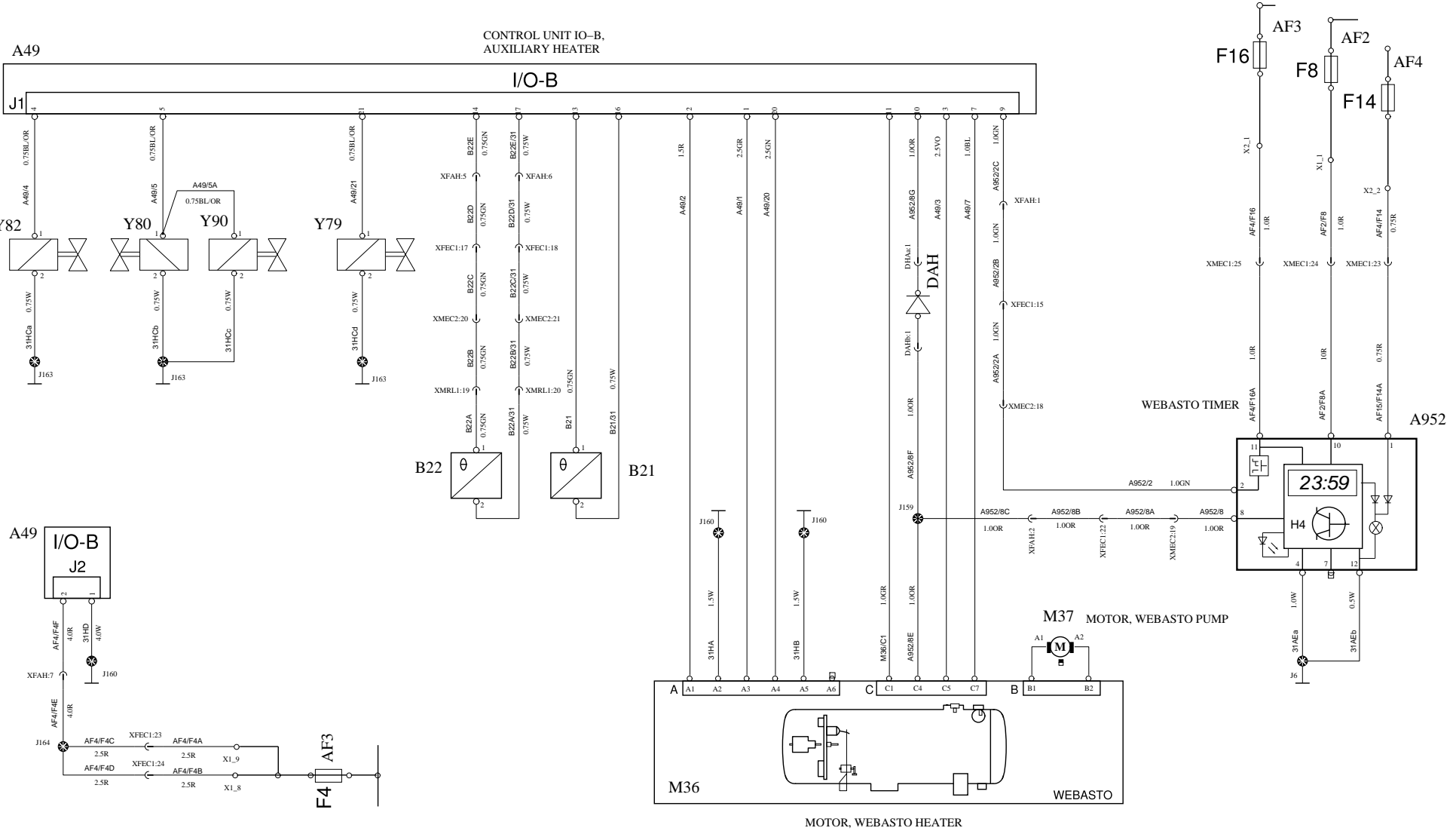

REAR LIGHTS

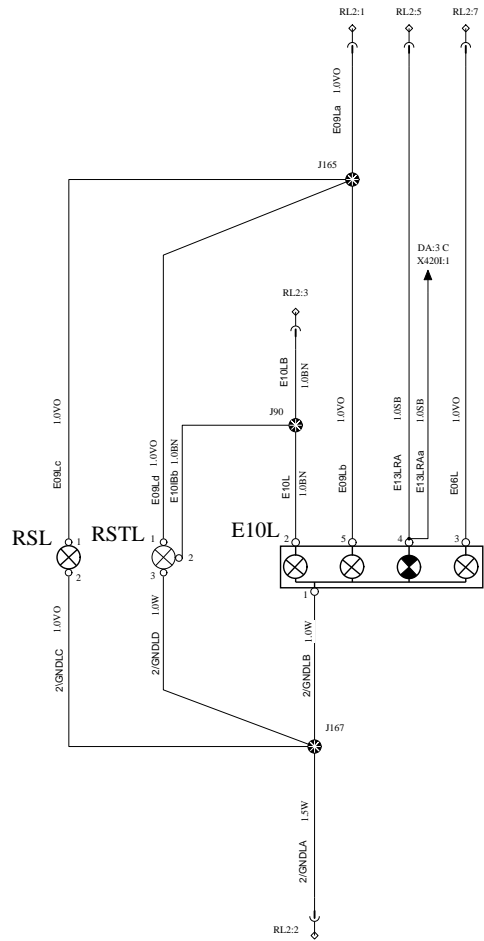

OA

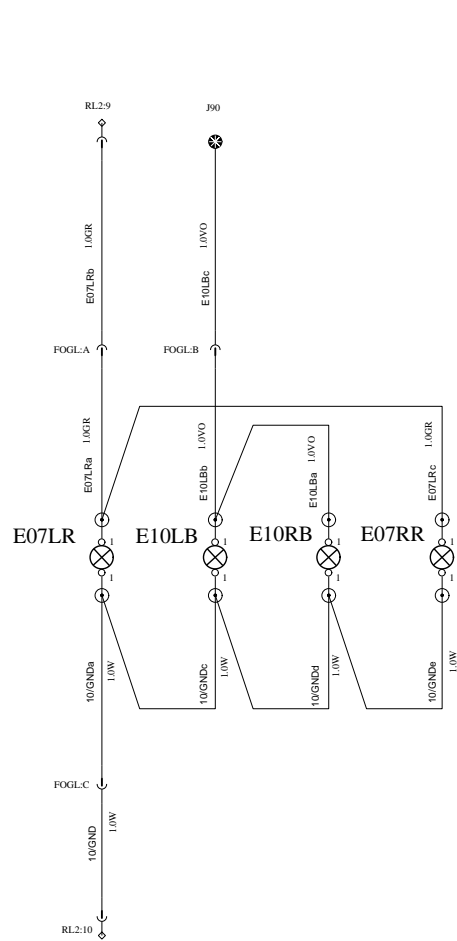

WIRING DIAGRAM

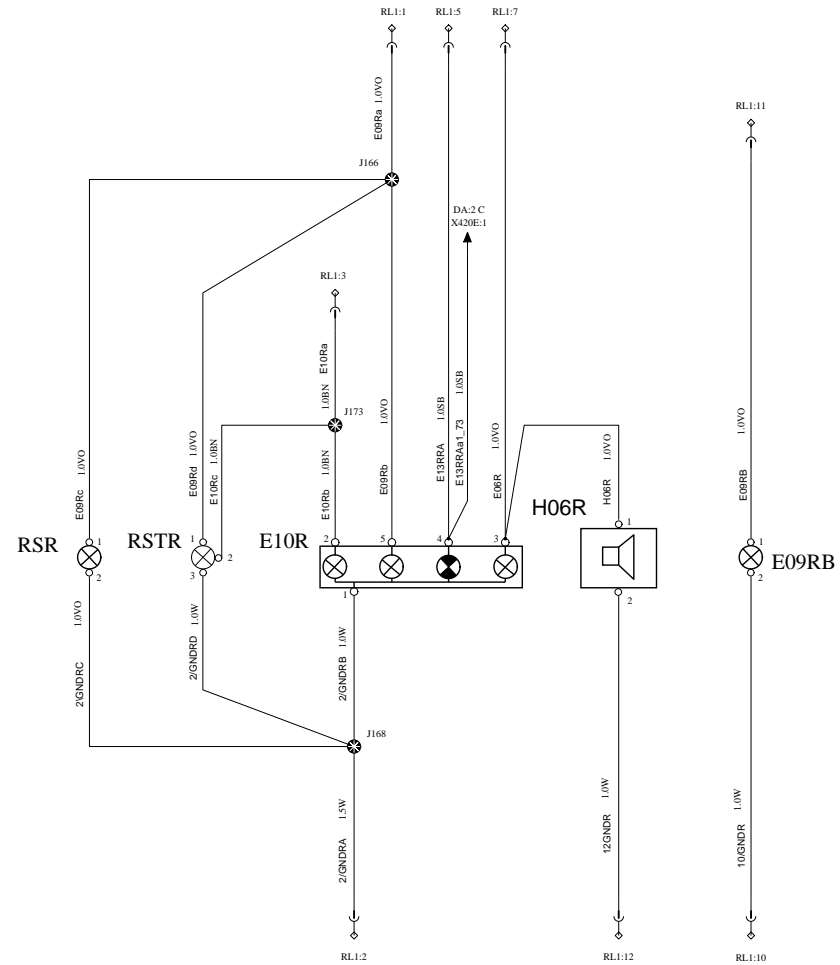

BOTTOM POSITION LIGHTS

OB

WIRING DIAGRAM

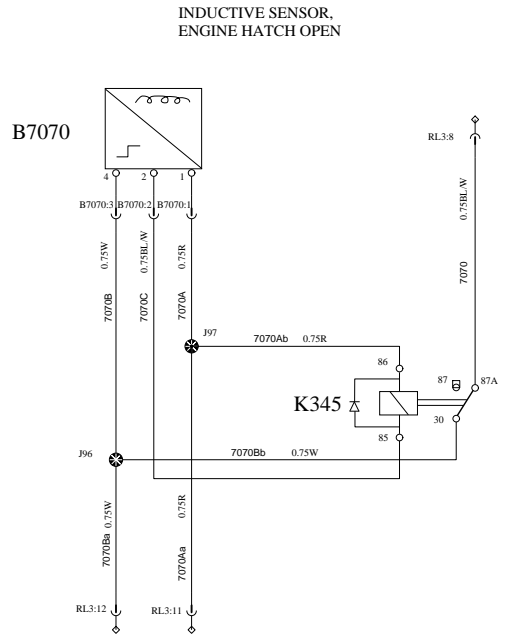
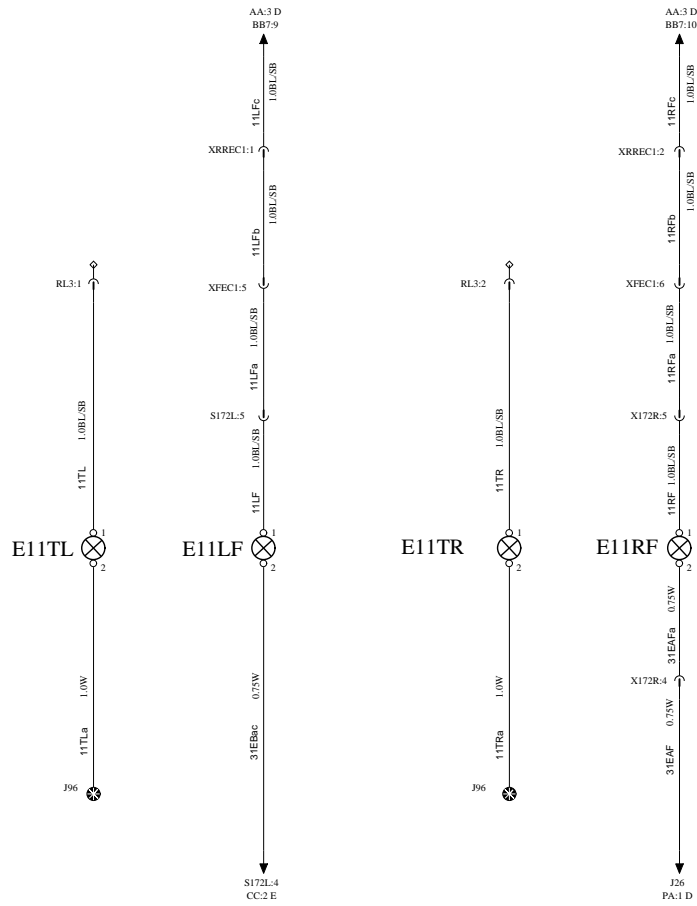

GROUND

PA

WIRING DIAGRAM

SWITCHES LED_GND

SWITCHES CONTROL_GND

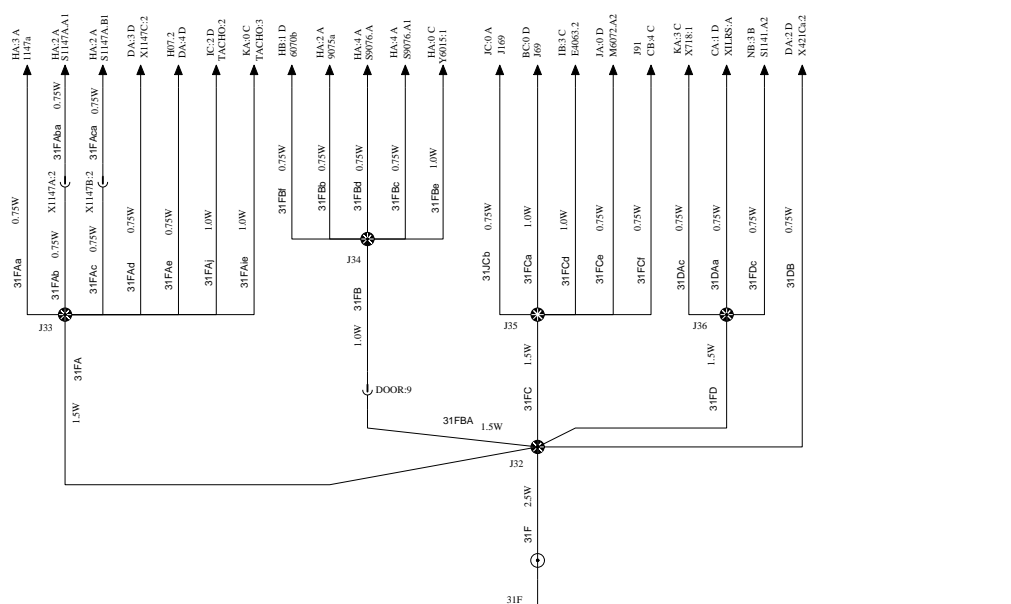
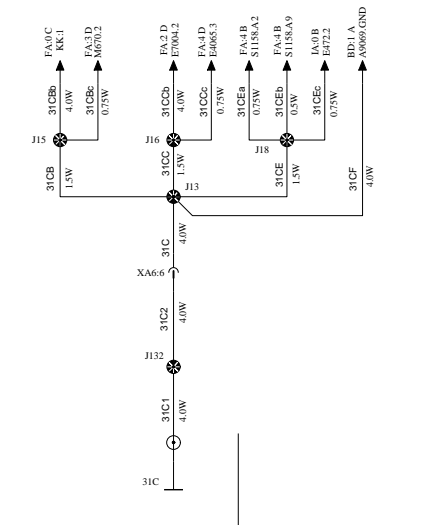
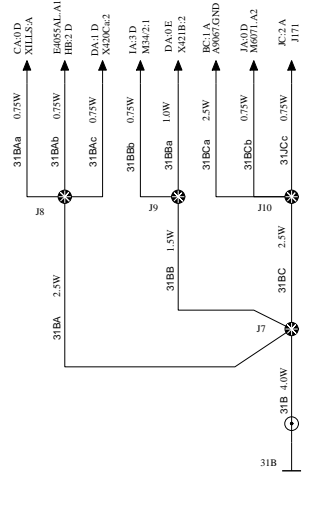
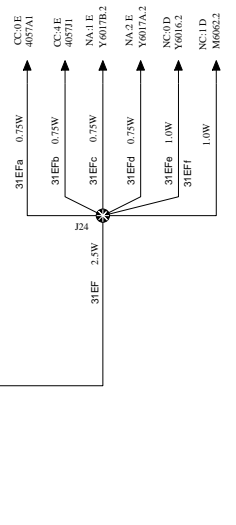
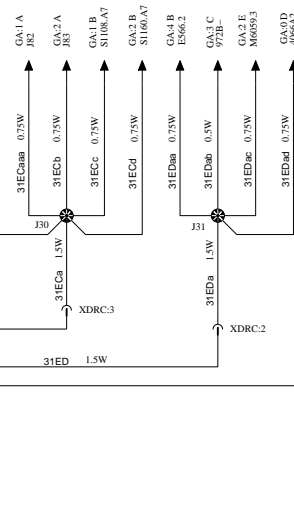
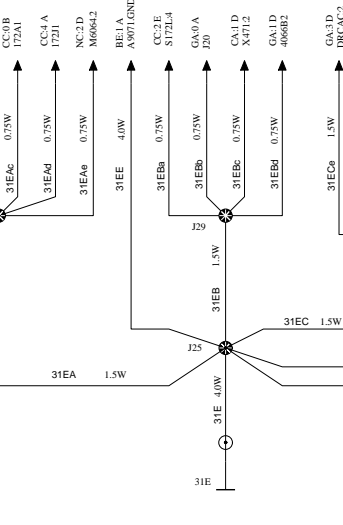
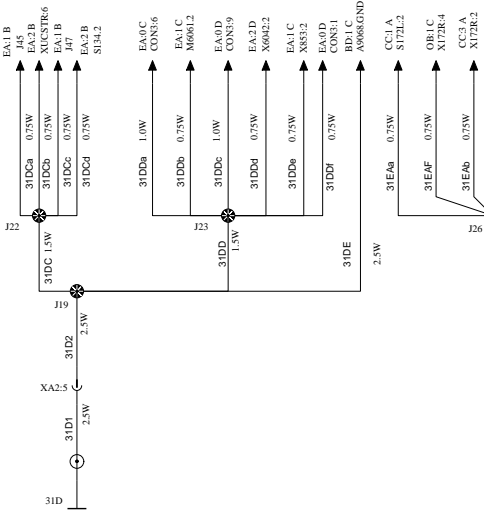
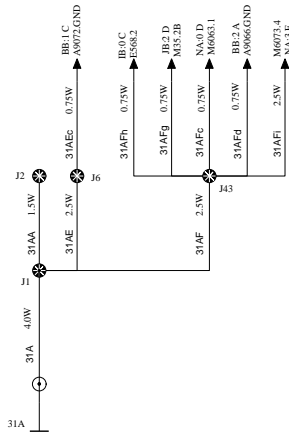
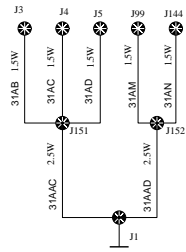
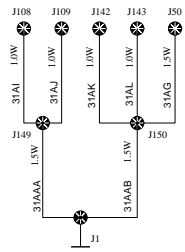

0 1 2 3 4

A

B

C

D

E

GROUNDS

PB

WIRING DIAGRAM

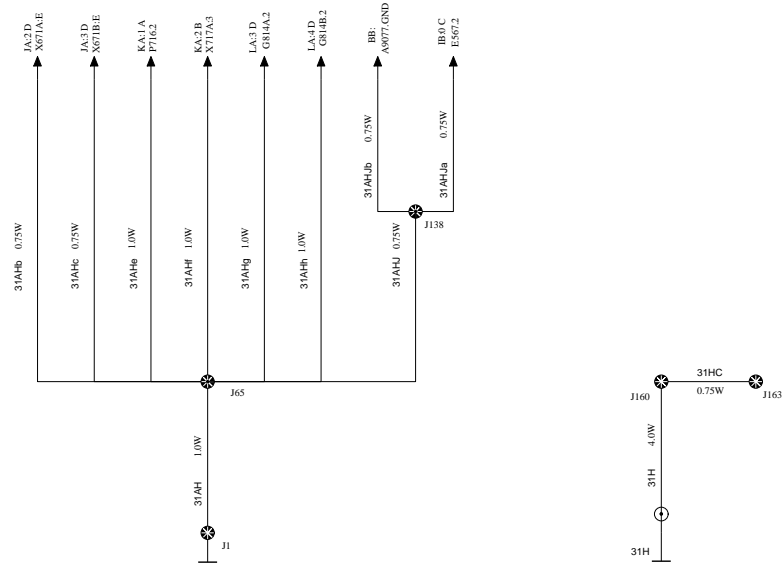

Volvo Bus Corporation

Document title
WIRING DIAGRAM

Document type
PRODUCT SCHEMATIC

Document No

21250316

Issue

01

Volume

01

Page

45/47

AUXILIARY LINES

QA

WIRING DIAGRAM

FLOOR HARNESS

ROOF LEFT HARNESS

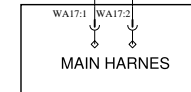
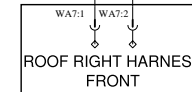
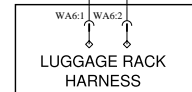
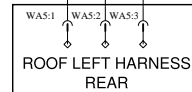
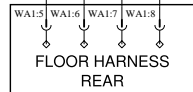
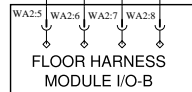
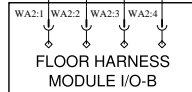
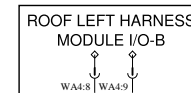
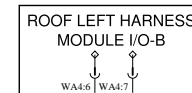
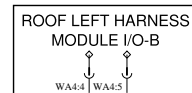
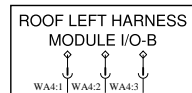
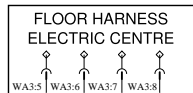
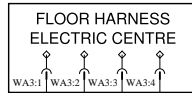
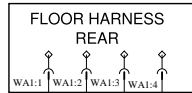

ROOF RIGHT HARNESS

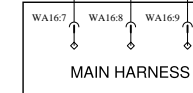
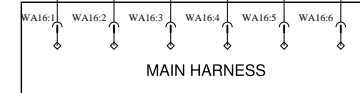
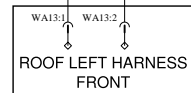
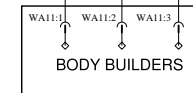
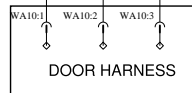
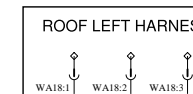
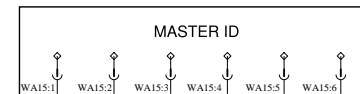
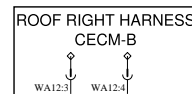
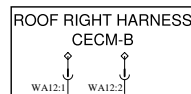
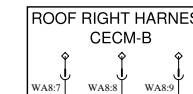
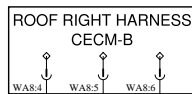
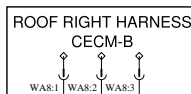

Volvo Bus Corporation

Document title
WIRING DIAGRAM

Document type
PRODUCT SCHEMATIC

Document No

21250316

Issue

01

Volume

01

Page

46/47

FUSES & RELAYS

RA

WIRING DIAGRAM

FUSES

FUSE	DESCRIPTION	AMPERES	FUSE	DESCRIPTION	AMPERES
AF1_F1	FEED MASTER ID	3A	AF3_F1	RELAYS	3A
AF1_F2	TRANSCOM	5A	AF3_F2	LIGHT UNDER SEATS	5A
AF1_F3	AUDIO & VIDEO 12V	20A	AF3_F3	PARK PILOT	10A
AF1_F4	EMPTY		AF3_F4	EMPTY	
AF1_F5	FLOOR IO B MODULE	30A	AF3_F5	EMPTY	
AF1_F6	CLIMATE IO A MODULE	5A	AF3_F6	CECM B	15A
AF1_F7	EMPTY		AF3_F7	DASHBOARD CONVERTER, CIGARETTE OUTPUT	15A
AF1_F8	EMPTY		AF3_F8	MIDDLE DOOR, IO A MODULE	5A
AF1_F9	CLIMATE UNIT IO A	5A	AF3_F9	PRESOSTATO	5A
AF1_F10	DEFROSTER FLAP	5A	AF3_F10	DASHBOARD IO A MODULE	5A
AF1_F11	RED LED SWITCHES	5A	AF3_F11	COPILOTO	3A
AF1_F12	DEFROSTER	20A	AF3_F12	24 VCD OUTPUT IN DASHBOARD	15A
AF1_F13	ROOF LEFT 2, IO B MODULE	30A	AF3_F13	24 VCD OUTPUT IN DRIVER SIDE	30A
AF1_F14	MOBITEC CONTROL & CECM MSW SIGNAL	7.5A	AF3_F14	EMPTY	
AF1_F15	EMPTY		AF3_F15	EMPTY	
AF1_F16	EMPTY		AF3_F16	EMPTY	
AF2_F1	OVER SPEED WARNING, RELAY K2	3A	AF4_F1	CONTROL PANEL AIR	5A
AF2_F2	TOILET IO B MODULE, LEFT & CENTRAL TOILET	7.5A	AF4_F2	EMPTY	
AF2_F3	ELECTRIC WINDOW	20A	AF4_F3	MOBITEC (+15)	5A
AF2_F4	FLAT SCREENS	30A	AF4_F4	ELECTROSTATIC FILTER	10A
AF2_F5	ROOF LEFT IO B MODULE	15A	AF4_F5	DRC AIR CONDITIONING	15A
AF2_F6	EMERGENCY WINDOW SIGN	3A	AF4_F6	AUDIO & VIDEO (+15)	3A
AF2_F7	EMPTY		AF4_F7	TIME AND TEMPERATURE DISPLAY	5A
AF2_F8	EMPTY		AF4_F8	PCB THERMO KING'S CLUTCH	5A
AF2_F9	COPILOTO,TD7	5A	AF4_F9	FEED +15 TD7	3A
AF2_F10	EMPTY		AF4_F10	ROOF HATCH FRONT	7.5A
AF2_F11	EMPTY		AF4_F11	ROOF HATCH REAR	7.5A
AF2_F12	AUDIO & VIDEO 24V	20A	AF4_F12	EMPTY	
AF2_F13	FLAT SCREENS	30A	AF4_F13	ELECTRICAL BLINDER	15A
AF2_F14	TOILET IO B MODULE	7.5A	AF4_F14	EMPTY	
AF2_F15	EMPTY		AF4_F15	EMPTY	
AF2_F16	EMPTY		AF4_F16	EMPTY	

RELAYS

Relay	Description
AK1_K1	FLAT SCREENS
AK1_K2	OVER SPEED 95KM CONTROL
AK1_K3	FLAT SCREENS
AK1_K4	DEFROSTER, SPEED 1
AK1_K5	DEFROSTER, SPEED 2
AK1_K6	DEFROSTER, SPEED 3

DOT ADDITIONAL FUSES

FUSE	DESCRIPTION	AMPERES
AF5_F1	FREE FUSE +30	3A
AF5_F2	FREE FUSE +30	10A
AF5_F3	FREE FUSE +30	20A
AF5_F4	FREE FUSE +30	30A
AF5_F5	FREE FUSE +30	7.5A
AF5_F6	FREE FUSE +30	15A
AF5_F7	FREE FUSE	15A
AF5_F8	FREE FUSE	5A
AF5_F9	FREE FUSE +30	5A
AF5_F10	FREE FUSE +30	5A
AF5_F11	FREE FUSE +30	10A
AF5_F12	FREE FUSE +30	20A
AF5_F13	FREE FUSE +30	30A
AF5_F14	FREE FUSE +30	7.5A
AF5_F15	FREE FUSE	7.5A
AF5_F16	FREE FUSE	3A



Volvo Bus Corporation

Document title
WIRING DIAGRAM

Document type
PRODUCT SCHEMATIC

Document No

21250316

Issue

01

Volume

01

Page

47/47

Engineering Release Notice (ERN)	Location	Change Description	A = Added U = Deleted	W = Was	Document Release Status
E-23113-43					Date 2008-05-27 Modification Count

**REFERENCE NAME INDEX, BUS BEA BODY 9700 24V
MEXICO**

REFERENCE	COORDINATE	DESCRIPTION
+30D	AD 3 B	+30 SIGNAL
31A	PA 1 B	GROUND DASHBOARD
31B	PA 3 B	GROUND, ROOF LEFT FRONT
31C	PA 4 C	GROUND, ROOF LEFT REAR
31D	PA 0 E	GROUND, ROOF RIGHT REAR
31E	PA 1 E	GROUND, FLOOR
31F	PA 4 E	GROUND, EXTRA
31H	PB 1 C	GROUND, AUXILIARY HEATER
669B	EA 4 A	TOILET FAN
1155a	EA 2 A}	EMERGENCY BUTTON
1155b	EA 2 B}	EMERGENCY BUTTON
A2	EA 3 B	PIR SENSOR A2
A2L	EB 3 A	PIR SENSOR A2, LEFT TOILET
A3	EA 3 B	PIR SENSOR A3
A3L	EB 3 B	PIR SENSOR A3, LEFT TOILET
A6	EA 3 B	PIR SENSOR A6
A6L	EB 3 B	PIR SENSOR A6, LEFT TOILET
A43	BA 0 E	Body I/O Module, Middle Toilet
A45	BA 0 E	Body I/O Module, Middle Toilet
A48	CB 1 A	Body I/O Module 48
A49	NE 3 A	CONTROL UNIT IO-B, AUXILIARY HEATER
A53	BG 1 A	BODY I/O MODULE 53
A950	ND 1 C	PCB THERMOKING LRT_HP
A950C	ND 2 B	CLUTCH SIGNAL
A950H	ND 1 D	HEAT VALVE
A952	NE 4 C	WEBASTO TIMER
A7001	NB 0 C	AC UNIT
A9066	BB 2 A	CONTROL UNIT I/O-A CLIMATE CONTROL
A9067	BC 1 A	CONTROL UNIT I/O-B ROOF LEFT
A9068	BD 1 C	CONTROL UNIT I/O-B TOILET
A9069	BD 1 A	CONTROL UNIT I/O-B KITCHEN
A9070	BC 1 C	CONTROL UNIT CECM-B ROOF RIGHT
A9071	BE 1 A	CONTROL UNIT I/O-B FLOOR
A9072	BB 1 C	CONTROL UNIT I/O-A DASHBOARD
A9073	BD 1 C	CONTROL UNIT I/O-A CLIMATE CONTROL
A9077	BA 0 A	CONTROL UNIT MASTER ID

The copying, distribution and utilization of this document as well as the communication of its contents to others without expressed authorization is prohibited. Offenders will be held liable for payment of damages. All rights reserved in the event of the grant of a patent, utility model or ornamental design registration.

Document Title
WIRING DIAGRAM
BEA – BODY 9700 - DOT



Volvo Bus Corporation

Document Type
PRODUCT SCHEMATIC

Owner Domain: Document Prefix

Document No 21250316	Issue Index 01	Volume No 02	Page No 1(11)
--------------------------------	--------------------------	------------------------	-------------------------

A9078	NA 0 A	CONTROL UNIT, CLIMATE DISPLAY
A9079	AB 2 C	PCB, TIP
A9080	BF 1 A	CONTROL UNIT I/O-B LEFT TOILET
AF1	AC 0 B	FUSES MODULE
AF2	LA 0 B	FUSES MODULE
AF3	AD 0 B	FUSES MODULE
AF4	IA 0 D	FUSES MODULE
AF5	AG 0 C	FREE FUSE MODULE
AK1	AB 1 D	RELAYS MODULE
B21	NE 1 C	SENSOR, OUTDOOR TEMPERATURE
B22	NE 1 C	SENSOR, OUTDOOR TEMPERATURE
B952	ND 0 B	SENSOR, OUTSIDE TEMPERATURE
B955	ND 1 A	SENSOR ,PASSENGER TEMPERATURE
B961A	JC 1 B	SENSOR EMERGENCY WINDOWS
B961B	JC 2 B	SENSOR EMERGENCY WINDOWS
B961C	JC 2 B	SENSOR EMERGENCY WINDOWS
B961D	JC 3 B	SENSOR EMERGENCY WINDOWS
B961E	JC 0 B	SENSOR EMERGENCY WINDOWS
B961F	JC 0 B	SENSOR EMERGENCY WINDOWS
B961G	JC 1 B	SENSOR EMERGENCY WINDOWS
B7070	OB 3 B	INDUCTIVE SENSOR,ENGINE HATCH OPEN
B7072	NA 1 D	DEFROSTER TEMP. SENSOR
B7073	NA 4 B	OUTSIDE TEMP. SENSOR
B7074	NA 0 D	DRIVER TEMP. SENSOR
B7075	NC 2 D	PASSENGER SENSOR, REHEATING SYS
Ba+	AB 3 A	B+ SIGNAL, FREE TERMINAL
Bb+	AD 0 B	B+ SIGNAL, FREE TERMINAL
COP	KA 0 B	FEED COPILOTO
D972A	GA 2 B	DRIVER INTERPHONE
D972B	GA 2 C	CABIN INTERPHONE
DAH	NE 2 B	DIODE, AUXILIARY HEATER
DRD	BC 2 D	DIODE
E10LB	OA 1 C	LICENSE PLATE LEFT
E1ORB	OA 2 C	LICENSE PLATE RIGHT
E07LR	OA 1 C	FOG LIGHT LEFT REAR
E07RR	OA 2 C	FOG LIGHT RIGHT REAR
E09RB	OA 3 C	BREAK LIGHT MIDDLE
E10L	OA 0 C	TAIL AND BREAK LIGHT LEFT
E10LB	OA 1 C	LICENSE PLATE LEFT
E10R	OA 2 C	TAIL AND BREAK LIGHT RIGHT
E10RB	OA 2 C	LICENSE PLATE RIGHT
E11LF	OB 0 C	SIDE-MARKER LAMP MIDDLE LEFT
E11RF	OB 1 C	SIDE-MARKER LAMP MIDDLE RIGHT
E11TL	OB 0 C	SIDE-MARKER LAMP REAR LEFT
E11TR	OB 1 C	SIDE-MARKER LAMP REAR RIGHT
E13	OB 2 C	DIRECTION INDICATOR

 Volvo Bus Corporation	Document Title			
	WIRING DIAGRAM			
	Document Type			
	PRODUCT SCHEMATIC			
Document No	Issue Index	Volume No	Page No	
21250316	01	02	2(11)	

E16A	CB 2 D	LAMP, STEP
E16B	CB 2 D	LAMP, STEP
E16C	CB 2 D	LAMP, STEP
E59A	CB 0 C	LUMINESCENCE LAMP, BAND1
E59B	CB 0 B	LUMINESCENCE LAMP, BAND1
E60A	CB 0 C	LUMINESCENCE LAMP, BAND2
E60B	CB 0 C	LUMINESCENCE LAMP, BAND2
E61A	CB 2 D	LAMP, ROOF HEAD
E61B	CB 3 D	LAMP, ROOF HEAD
E91R	DA 3 D	LAMP, KNEELING WARNING
E420A	DA 1 D	POSITION LIGHTS, UPPER FRONT LEFT SIDE
E420B	DA 1 D	POSITION LIGHTS,UPPER CENTRE LEFT SIDE
E420C	DA 1 D	POSITION LIGHTS,UPPER REAR LEFT SIDE
E420D	DA 2 D	POSITION LIGHTS,UPPER REAR
E420E	DA 3 D	POSITION LIGHTS,UPPER REAR
E420F	DA 3 D	POSITION LIGHTS,UPPER REAR
E420G	DA 3 D	POSITION LIGHTS,UPPER REAR
E420H	DA 3 D	POSITION LIGHTS,UPPER REAR
E420I	DA 4 D	POSITION LIGHTS,UPPER REAR
E420J	DA 4 D	POSITION LIGHTS,UPPER REAR
E421A	DA 2 D	POSITION LIGHTS, UPPER FRONT RIGHT SIDE
E421B	DA 2 D	POSITION LIGHTS, UPPER CENTRE RIGHT SIDE
E421C	DA 2 D	POSITION LIGHTS, UPPER REAR RIGHT SIDE
E421D	DA 0 D	POSITION LIGHTS, UPPER FRONT
E421E	DA 0 D	POSITION LIGHTS, UPPER FRONT
E421F	DA 0 D	POSITION LIGHTS, UPPER FRONT
E421G	DA 0 D	POSITION LIGHTS, UPPER FRONT
E421H	DA 1 D	POSITION LIGHTS, UPPER FRONT
E433	CB 3 D	GUIDE LAMP
E435A	CB 1 D	READING LAMPS LEFT SIDE
E435B	CB 1 D	READING LAMPS RIGHT SIDE
E450	CB 3 D	DESTINATION SIGN LAMP
E450L	CB 3 D	DESTINATION SIGN LAMP
E467A	CA 0 D	FLUORESCENT TUBE, DIM LIGHT RIGHT SIDE
E467B	CA 0 D	FLUORESCENT TUBE, FULL LIGHT RIGHT SIDE
E467C	CA 0 D	FLUORESCENT TUBE, DIM LIGHT LEFT SIDE
E467D	CA 0 D	FLUORESCENT TUBE, FULL LIGHT LEFT SIDE
E471A	CA 3 D	NIGHT LIGHT, LEFT SIDE
E471B	CA 3 D	NIGHT LIGHT RIGHT SIDE
E472	IA 0 B	BULB, ENGINE COMPARTMENT
E566	GA 4 B	REST COMPARTMENT SNAKE LAMP
E567	IB 0 C	SNAKE LAMP, ELECTRIC CENTRE
E568	IB 0 C	SNAKE LAMP, MAP LIGHT
E902A	LB 0 D	DRIVER LOUDSPEAKER
E902B	LB 0 D	DRIVER LOUDSPEAKER
E902C	LB 1 D	GUIDE LOUDSPEAKER

VOLVO

Volvo Bus Corporation

Document Title

WIRING DIAGRAM

Document Type

PRODUCT SCHEMATIC

Document No

21250316

Issue Index

01

Volume No

02

Page No

3(11)

E902D	LB 1 D	GUIDE LOUDSPEAKER
E902E	LB 2 D	LOUDSPEAKERS, ROOF RIGHT
E902F	LB 3 D	LOUDSPEAKERS, ROOF LEFT
E911A	IB 4 C	PASSENGER SPEAKERS, LEFT SIDE
E911B	IB 4 C	PASSENGER SPEAKER, RIGHT SIDE
E4054A	EA 3 B	LIGHT INTO THE TOILET
E4054AL	EB 3 B	LIGHT INTO THE LEFT TOILET
E4054B	EA 3 B	LIGHT INTO THE TOILET
E4054BL	EB 3 B	LIGHT INTO THE LEFT TOILET
E4055A	HB 2 B	OCCUPIED & VACANT DISPLAY
E4055AL	HB 2 D	OCCUPIED & VACCANT DISPLAY, LEFT SIDE
E4055L	EB 3 A	OCCUPIED & VACCANT DISPLAY, LEFT SIDE
E4055LA	EA 3 A	OCCUPIED & VACANT LAMP WC
E4057A	CC 0 D	TOOL BOX COMPARTMENT LAMPS LEFT SIDE
E4057B	CC 0 D	LUGGAGE LAMPS LEFT SIDE
E4057C	CC 1 D	LUGGAGE LAMPS LEFT SIDE
E4057D	CC 1 D	LUGGAGE LAMPS LEFT SIDE
E4057E	CC 2 D	EXTRACOMPARTMENT LAMPS LEFT SIDE
E4057F	CC 2 D	LUGGAGE LAMPS RIGHT SIDE
E4057G	CC 3 D	LUGGAGE LAMPS RIGHT SIDE
E4057H	CC 3 D	LUGGAGE LAMPS LEFT SIDE
E4057J	CC 4 D	TOOL BOX COMPARTMENT LAMPS RIGHT SIDE
E4063	IB 3 C	OVER SPEED LAMP
E4064	CB 2 D	DRIVER LAMP
E4065	FA 4 D	KITCHEN LIGHT
E4066A	GA 0 D	REST COMPARTMENT LEFT LIGHT
E4066B	GA 1 D	REST COMPARTMENT RIGHT LIGHT
E4067	IB 1 C	TIME & TEMPERATURE DISPLAY
E4070	HA 3 B	EMERGENCY LAMP
E7003	FA 0 D	COFFEE MACHINE
E7004	FA 2 D	FRIDGE
EFL	IA 1 D	ELECTROSTATIC FILTER
EFR	IA 1 D	ELECTROSTATIC FILTER
F101A	AB 1 A	FUSE 50 AMP, + 30
F101B	AB 1 B	FUSE 30 AMP, B+
F104	AB 1 A	FUSE 125 AMP, A/C
F107	AB 1 B	FUSE 30 AMP, +B
FMD	HC 1 D	CENTRAL DOOR
FMT	HC 0 D	CENTRAL TOILET
G01.A	AB 0 C	BATTERY TERMINAL
G01B.B	AB 0 D	BATTERY TERMINAL
FOGL	OA 1 B	FOG PLATE LIGHTS
G01	AB 0 C	BATTERY 12 VCD
G01B	AB 0 D	BATTERY
G03	IC 4 D	ALTERNATOR
G813	LA 3 D	OUTPUT 12V

VOLVO

Volvo Bus Corporation

Document Title

WIRING DIAGRAM

Document Type

PRODUCT SCHEMATIC

Document No

21250316

Issue Index

01

Volume No

02

Page No

4(11)

G814A	LA 3 D	OUTPUT 24V
G814B	LA 4 D	OUTPUT 12V
GND	AB 3 B	GROUND
GND31B	AB 0 E	GROUND TERMINAL
GNDa	AB 3 B	GROUND
H01	IA 3 C	ELECTRIC HORN A
H02	IA 3 C	ELECTRIC HORN B
H06R	OA 3 C	BUZZER REVERSE
H07	DA 4 D	HORN, KNEELING ALARM
H12	JC 4 C	INDICATOR LAMP, EMERGENCY WINDOWS
H853	EA 2 C	BUZZER
H853L	EB 2 C	BUZZER, LEFT TOILET
H860	IB 3 C	OVER SPEED BUZZER
H5013	IB 3 C	OVER SPEED TELLTALE
J1	PA 1 B	SPLICE
J2	CB 2 E	SPLICE
J3	CA 0 A	SPLICE
J4	EA 4 B	SPLICE
J5	CB 4 A	SPLICE
J6	PA 1 B	SPLICE
J7	CB 3 E	SPLICE
J8	PA 2 B	SPLICE
J9	PA 3 B	SPLICE
J10	PA 3 B	SPLICE
J11	BC 3 C	SPLICE
J12	BC 4 C	SPLICE
J13	PA 4 B	SPLICE
J14	AA 0 D	SPLICE
J15	PA 3 A	SPLICE
J16	PA 4 A	SPLICE
J17	AA 0 E	SPLICE
J18	PA 4 A	SPLICE
J19	PA 0 D	SPLICE
J20	GA 0 A	SPLICE
J21	CC 1 D	SPLICE
J22	PA 0 D	SPLICE
J23	PA 0 D	SPLICE
J24	PA 2 D	SPLICE
J25	PA 1 D	SPLICE
J26	PA 1 D	SPLICE
J27	CC 1 C	SPLICE
J28	CC 1 C	SPLICE
J29	PA 1 D	SPLICE
J30	PA 2 D	SPLICE
J31	PA 2 D	SPLICE
J32	PA 4 D	SPLICE

VOLVO

Volvo Bus Corporation

Document Title

WIRING DIAGRAM

Document Type

PRODUCT SCHEMATIC

Document No

21250316

Issue Index

01

Volume No

02

Page No

5(11)

J33	PA 3 D	SPLICE
J34	PA 3 D	SPLICE
J35	CB 3 E	SPLICE
J36	PA 4 D	SPLICE
J37	GA 0 B	SPLICE
J38	CA 0 C	SPLICE
J39	CA 1 C	SPLICE
J40	CB 0 B	SPLICE
J41	CB 1 C	SPLICE
J42	CA 3 C	SPLICE
J43	PA 1 B	SPLICE
J44	CC 3 D	SPLICE
J45	EA 1 B	SPLICE
J46	EA 3 B	SPLICE
J47	EA 1 B	SPLICE
J48	EA 1 D	SPLICE
J49	LB 3 B	SPLICE
J50	CB 3 B	SPLICE
J51	BA 1 B	SPLICE
J52	BA 1 B	SPLICE
J53	BA 2 B	SPLICE
J54	BA 2 B	SPLICE
J55	BA 2 B	SPLICE
J56	BA 2 B	SPLICE
J57	BA 3 B	SPLICE
J58	BA 3 B	SPLICE
J59	BA 3 B	SPLICE
J60	BA 3 B	SPLICE
J61	BA 3 B	SPLICE
J62	BA 4 B	SPLICE
J63	BA 2 C	SPLICE
J64	BA 2 D	SPLICE
J65	PB 0 C	SPLICE
J66	JA 1 A	SPLICE
J67	LB 2 B	SPLICE
J68	IB 2 B	SPLICE
J69	BC 0 D	SPLICE
J70	BC 0 D	SPLICE
J71	BC 1 D	SPLICE
J72	BC 1 D	SPLICE
J73	IB 4 B	SPLICE
J74	LB 2 B	SPLICE
J75	BA 0 B	SPLICE
J76	BA 0 B	SPLICE
J77	BA 0 B	SPLICE
J78	BA 0 B	SPLICE

 Volvo Bus Corporation	Document Title			
	WIRING DIAGRAM			
	Document Type			
	PRODUCT SCHEMATIC			
Document No	Issue Index	Volume No	Page No	
21250316	01	02	6(11)	

J79	NA 0 D	SPLICE
J80	EA 3 B	SPLICE
J81	CB 0 C	SPLICE
J82	GA 1 A	SPLICE
J83	GA 2 A	SPLICE
J84	BF 2 B	SPLICE
J85	BF 2 B	SPLICE
J86	EB 3 A	SPLICE
J87	EB 3 B	SPLICE
J88	EB 1 B	SPLICE
J89	EB 1 B	SPLICE
J90	OA 0 B	SPLICE
J91	CB 4 C	SPLICE
J92	CB 4 D	SPLICE
J93	CB 3 C	SPLICE
J94	CB 2 C	SPLICE
J95	LB 2 B	SPLICE
J96	OB 3 C	SPLICE
J97	OB 3 C	SPLICE
J98	BC 1 B	SPLICE
J99	PA 1 A	SPLICE
J100	AA 1 D	SPLICE
J101	BA 2 C	SPLICE
J102	BA 3 D	SPLICE
J103	BA 2 C	SPLICE
J104	BA 2 D	SPLICE
J105	AA 3 D	SPLICE
J106	BA 1 C	SPLICE
J107	BA 1 D	SPLICE
J108	PA 0 A	SPLICE
J109	CB 2 B	SPLICE
J110	AC 1 B	SPLICE
J111	AB 4 C	SPLICE
J132	DA 4 E	SPLICE
J133	AC 1 C	SPLICE
J134	AC 2 C	SPLICE
J135	LA 1 C	SPLICE
J136	CB 0 B	SPLICE
J137	CB 3 C	SPLICE
J138	PB 1 B	SPLICE
J139	AA 0 E	SPLICE
J140	AA 1 E	SPLICE
J141	AA 1 E	SPLICE
J142	CA 2 B	SPLICE
J143	EA 3 D	SPLICE
J144	CB 2 A	SPLICE

 Volvo Bus Corporation	Document Title			
	WIRING DIAGRAM			
	Document Type			
	PRODUCT SCHEMATIC			
Document No	Issue Index	Volume No	Page No	
21250316	01	02	7(11)	

J145	AC 2 C	SPLICE
J146	AC 2 C	SPLICE
J147	AC 2 D	SPLICE
J148	AC 2 D	SPLICE
J149	PA 0 B	SPLICE
J150	PA 0 B	SPLICE
J151	PA 0 B	SPLICE
J152	PA 1 B	SPLICE
J153	CB 1 C	SPLICE
J154	IC 3 D	SPLICE
J159	NE 2 C	SPLICE
J160	PB 1 C	SPLICE
J161	BA 3 C	SPLICE
J162	BA 3 D	SPLICE
J163	PB 2 C	SPLICE
J164	NE 0 D	SPLICE
J165	OA 0 B	SPLICE
J166	OA 3 B	SPLICE
J167	OA 0 C	SPLICE
J168	OA 3 C	SPLICE
J169	JC 0 A	SPLICE
J170	JC 0 D	SPLICE
J171	JC 2 A	SPLICE
J172	JC 2 D	SPLICE
J173	OA B 3	SPLICE
J1708	BB 3 D	CECM PC:JC
K+	FA 0 C	KITCHEN SUPPLY
K-	FA 1 C	KITCHEN GROUND
K320	AB 0 C	POWER BOX
K345	OB 3 C	RELAY, START INHIBITOR
KK	FA 0 C	KITCHEN RELAY
M10F	JB 0 B	MOTOR, FRONT ROOF HATCH
M10R	JB 0 D	MOTOR, REAR ROOF HATCH
M33	NC 1 B	MOTOR, DEFROSTER SMOG FLAP
M34	IA 2 D	Motor, Extractor Roof Hatch
M35	JB 2 D	MOTOR, DRIVER WINDOW
M36	NE 2 D	MOTOR, WEBASTO HEATER
M37	NE 3 D	MOTOR, WEBASTO PUMP
M38	EA 3 E	MOTOR, URINAL PUMP
M650	MA 0 D	WINDSCREEN WIPER MOTOR
M651	MA 2 C	WINDSCREEN WASHER MOTOR
M664	EA 3 E	WC FLUSHING WATER PUMP
M664L	EB 3 D	WATER PUMP, WC FLUSH, LEFT TOILET
M669	EA 4 A	FAN
M669L	EB 4 A	FAN, TOILET
M670	FA 3 D	FRESH WATER PUMP

 Volvo Bus Corporation	Document Title			
	WIRING DIAGRAM			
	Document Type			
	PRODUCT SCHEMATIC			
Document No	Issue Index	Volume No	Page No	
21250316	01	02	8(11)	

M671A	JA 2 D	MIRROR MOTOR
M671B	JA 3 D	MIRROR MOTOR
M672	JA 1 D	BLINDER MOTOR
M6059	GA 2 E	REST COMPARTMENT FAN
M6061	EA 2 B	HANDWASH WATER PUMP
M6061L	EB 1 B	WATER PUMP, HW, LEFT TOILET
M6062	NC 1 D	CIRCULATION PUMP, REHEATING SYS
M6063	NA 0 D	FLAP FLOOR, SCREEN STEPLESS
M6064	NC 2 D	FAN, REHEATING SYSTEM
M6071	JA 0 D	DRIVER FAN
M6072	JA 0 D	GUIDE FAN
M6073	NA 3 E	DEFROSTER
MINISIGMA	3 B	CONTROL UNIT MINISIGMA
P715	KA 0 A	CODRIVER/INTELSAT
P716	KA 1 A	CONTROL PANEL AIR/VIGIA
P718	KA 4 C	PARK PILOT FLOOR
R1	BA 0 B	RESISTOR 120ohms, START CANB
R2	BA 3 D	RESISTOR 120ohms, START CANB
R3	BC 1 D	RESISTOR 120 ohms, end CAND
RSL	OA 0 C	REAR STOP LIGHT LEFT
RSR	OA 2 C	REAR STOP LIGHT RIGHT
RSTL	OA 0 A	LAMP, REAR STOP TAIL DOT
RSTR	OA 2 C	LAMP, REAR STOP TAIL DOT
S23F	JB 0 B	SWITCH, FRONT ROOF HATCH
S23R	JB 0 E	SWITCH, REAR ROOF HATCH
S80	LB 3 C	SWITCH, TRANSCOM
S101	HC 3 B	SWITCH, MIDDLE DOOR
S116	CA 0 B	INTERIOR LIGHTS
S117	CB 1 B	READING LIGHTS
S118	JA 0 B	SWITCH, DRIVER AND GUIDE FAN
S123	IA 3 B	SWITCH, EXTRACTOR ROOF HATCH
S126	JB 3 B	SWITCH, DRIVER WINDOW
S127	JB 2 B	SWITCH, WINDOW HEATER
S132	CB 4 B	DESTINATION SIGN LIGHT
S134	EA 2 B	PUSH BUTTON, URINAL PUMP
S172A	CC 0 B	TOOL BOX COMPARTMENT LEFT SIDE MSW
S172B	CC 0 B	LUGGAGE LIGHTS LEFT SIDE MSW
S172C	CC 1 B	LUGGAGE LIGHTS LEFT SIDE MSW
S172D	CC 1 B	LUGGAGE LIGHTS LEFT SIDE MSW
S172F	CC 2 B	LUGGAGE LIGHTS RIGHT SIDE MSW
S172G	CC 3 B	LUGGAGE LIGHTS RIGHT SIDE MSW
S172H	CC 3 B	LUGGAGE LIGHTS RIGHT SIDE MSW
S172J	CC 4 B	TOOL BOX COMPARTMENT RIGHT SIDE MSW
S1107	HA 1 B	DOOR LOCK
S1108	GA 1 B	LIGHTING SLEEPER CAB
S1111	IA 1 B	CENTRAL LOCK

VOLVO

Volvo Bus Corporation

Document Title

WIRING DIAGRAM

Document Type

PRODUCT SCHEMATIC

Document No

21250316

Issue Index

01

Volume No

02

Page No

9(11)

S1112	FA 2 B	FRIDGE
S1113	FA 0 B	COOKER
S1115	HA 0 B	SERVICE DOOR
S1141	NB 3 B	SWITCH, GAS CHARGING
S1144	CB 3 B	DRIVER & GUIDE LIGHT
S1147A	HA 2 A	SWITCH, INSIDE FRONT DOOR
S1147B	HA 3 B	SWITCH, OUTSIDE FRONT DOOR
S1148	CA 3 B	NIGHT LIGHT
S1148a	CA 2 B	SEAT NIGHT LIGHT
S1150	DA 2 A	POSITION LIGHTS
S1151	EA 4 C	GENERAL SWITCH TOILET
S1152	EA 2 B	HANDWASH BUTTON
S1152L	EB 2 B	HANDWASH BUTTON, LEFT TOILET
S1153	EA 2 B	WC FLUSHING BUTTON
S1153L	EB 2 B	WC FLUSHING BUTTON, LEFT TOILET
S1154	EA 3 A	MOVEMENT SENSOR
S1154L	EB 3 A	MOVEMENT SENSOR, LEFT TOILET
S1155	EA 2 A	EMERGENCY BUTTON
S1155L	EB 2 A	EMERGENCY BUTTON, LEFT TOILET
S1156	EA 2 D	PRINCIPAL TANK SENSOR
S1157	EA 1 D	SOIL TANK SENSOR
S1158	FA 4 B	KITCHEN LIGHT
S1160	GA 2 B	BERTH FAN
S1161A	GA 0 B	SLEEPER CAB LEFT
S1161B	GA 0 B	SLEEPER CAB RIGHT
S1162	EA 1 D	HANDWASH TANK SENSOR
S1162L	EB 1 D	HANDWASH TANK SENSOR, LEFT TOILET
S1163	HB 1 B	AUXILIARY STEP
S1164	JA 4 A	SWITCH, MIRRORS
S1165	JA 3 B	SWITCH, MIRROR HEATER
S1166	JA 2 B	SWITCH, BLINDER
S2016H	NB 3 D	HIGH PRESSURE SWITCH
S2016L	NB 3 D	LOW PRESSURE SWITCH
S7071	MA 3 D	WINDSHIELD WIPER TANK LEVEL SENSOR
S9074	HA 2 A	PRESOSTATO
S9075	HA 2 A	PRESSURE SENSOR
S9076	HA 4 A	MICRO-SWITCHES BERTH
T901	LA 0 B	VOLTAGE CONVERTER
T901A	LA 2 B	VOLTAGE CONVERTER
T901B	KA 0 C	VOLTAGE CONVERTER
TACHO	IC 1 C	TACHOGRAPH FEED CONNECTION
TACHOCOP	KA 0 C	TACHOGRAPH FEED COPILOTO
TACHOMS	IC 3 C	TACHOGRAPH FEED MINISIGMA
TACHOTD7	IC 1 C	TACHOGRAPH FEED TD7
W	AA 4 A	W ALTERNATOR SIGNAL
XC102B	AB 0 C	POWER BOX TERMINAL

VOLVO

Volvo Bus Corporation

Document Title

WIRING DIAGRAM

Document Type

PRODUCT SCHEMATIC

Document No

21250316

Issue Index

01

Volume No

02

Page No

10(11)

Y	AB 3 A	DEVICE TERMINAL
Y72	IA 4 C	AIR HORN
Y79	NE 1 B	VALVE, ROOF HEATING SYSTEM
Y80	NE 0 B	VALVE, PASSENGER HEATING SYSTEM
Y82	NE 0 B	VALVE, DEFROSTER HEATING SYSTEM
Y90	NE 0 B	VALVE, BYPASS
Y952	NB 3 E	CLUTCH COMPRESSOR
Y952A	NB 0 E	DISCHARGE VALVE
Y6009	NA 4 E	AC DEFROSTER VALVE
Y6014	IA 1 C	SOLENOID VALVE
Y6015	HA 0 C	SOLENOID VALVE DOOR
Y6016	NC 0 D	ROOF VALVE, REHEATING SYSTEM
Y6017A	NA 2 E	PASSENGER VALVE
Y6017B	NA 1 E	DEFROSTER VALVE
Y6017C	NA 2 E	BYPASS VALVE
Y6042	EA 2 E	ISONIC PNEUMATIC VALVE
Y6042L	EB 2 D	PNEUMATIC VALVE, LEFT TOILET
Y6070	HB 1 D	SOLENOID VALVE AUXILIARY STEP
Y6017A	NA 2 E	PASSENGER VALVE
Y6017B	NA 1 E	DEFROSTER VALVE
Y6017C	NA 2 E	BYPASS VALVE
Y6042	EA 2 E	ISONIC PNEUMATIC VALVE
Y6042L	EB 2 D	PNEUMATIC VALVE, LEFT TOILET
Y6070	HB 1 D	SOLENOID VALVE AUXILIARY STEP

 Volvo Bus Corporation	Document Title			
	WIRING DIAGRAM			
	Document Type			
PRODUCT SCHEMATIC				
Document No	Issue Index	Volume No	Page No	
21250316	01	02	11(11)	