



# INDEX

INDEX \_\_\_\_\_ PAGE A

HARNESS ARRANGEMENT \_\_\_\_\_ PAGE B

CABLE ARRANGEMENT \_\_\_\_\_ PAGE C

CIRCUIT BREAKER CODE \_\_\_\_\_ PAGE D1 & D2

CONNECTOR CODE \_\_\_\_\_ PAGE E1 TO E5

DIODE CODE \_\_\_\_\_ PAGE F

RELAYS CODE \_\_\_\_\_ PAGE G

RESISTOR CODE \_\_\_\_\_ PAGE H

SWITCH CODE \_\_\_\_\_ PAGE I

TELL-TALE LITE CODE \_\_\_\_\_ PAGE J

ACCESSORIES SYMBOL \_\_\_\_\_ PAGE K

WIRING DIAGRAM INDEX \_\_\_\_\_ PAGE L

SPARE WIRES \_\_\_\_\_ PAGE M

WIRING DIAGRAM \_\_\_\_\_ PAGE 1 TO 24

	<b>LEGEND</b> FRONT JUNCTION PANEL REAR JUNCTION PANEL BATTERY COMPARTMENT CIRCUIT BREAKER HARNESS CONNECTOR BATTERY JUNCTION BLOCK SINGLE CONNECTOR DIODE (RECTIFIER) OPTION		<small>THIS AGREEMENT IS THE EXCLUSIVE PROPERTY OF THE MOST AND NO PART OF IT MAY BE REPRODUCED OR TRANSMITTED IN ANY FORM OR BY ANY MEANS, ELECTRONIC OR MECHANICAL, INCLUDING PHOTOCOPYING, RECORDING, OR BY ANY INFORMATION STORAGE AND RETRIEVAL SYSTEM WITHOUT THE EXPRESS WRITTEN PERMISSION OF THE MOST.</small>			C 88-06 PAGE M AJOUTE ML B 88-04 C D # 13883 B.C. A 88-02 LANCE D.V. ITEM DATE REVISION PAR	TITRE: <h2 style="text-align: center;">INDEX</h2>	DESS: <i>D.T.</i> VER. - <i>ke</i>	DATE - 88-02 APPR. - <i>ke</i>	APPL: EFF. W/J001 PRIOR TO J009 REF: H5-60 NO: D-060566 PA C
--	--	--	---	--	--	--	--	---------------------------------------	-----------------------------------	---

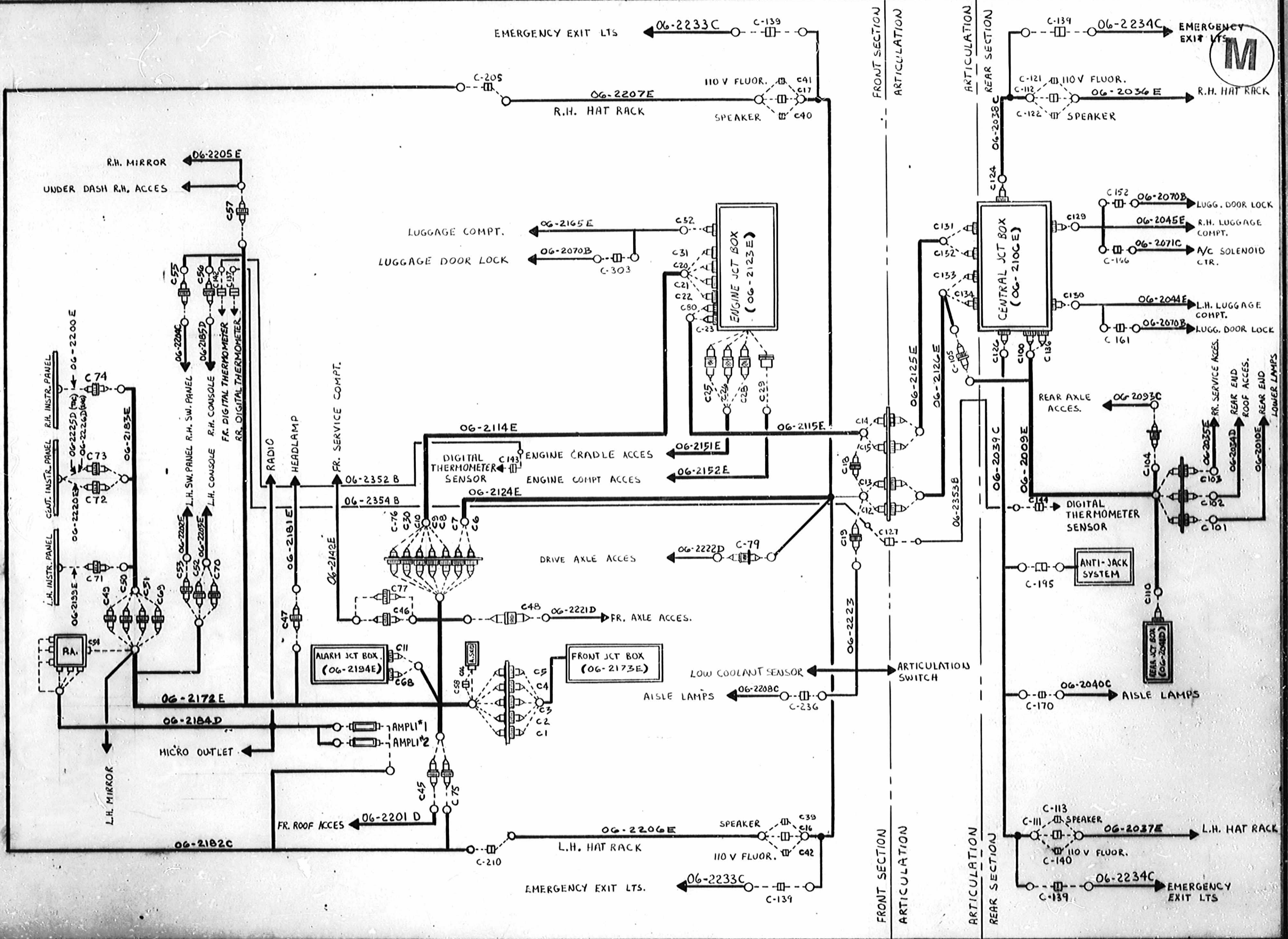

C. 89-02			a.c. #89033, C.D.#16188	Rev	TITRE: HARNESS ARRANGEMENT DESS: <i>lc</i> DATE: 87-10-13 VER.- APPR.- <i>R</i>	
B. 88-02			C.D. # 13311	BC		
A. 88-02			LANCE	DT		
ITEM	DATE	REVISION	PAR	APPL: EFF. W/3001 PRIOR TO 3009	REF: H5-60	NO: D-060566 p. B C

M

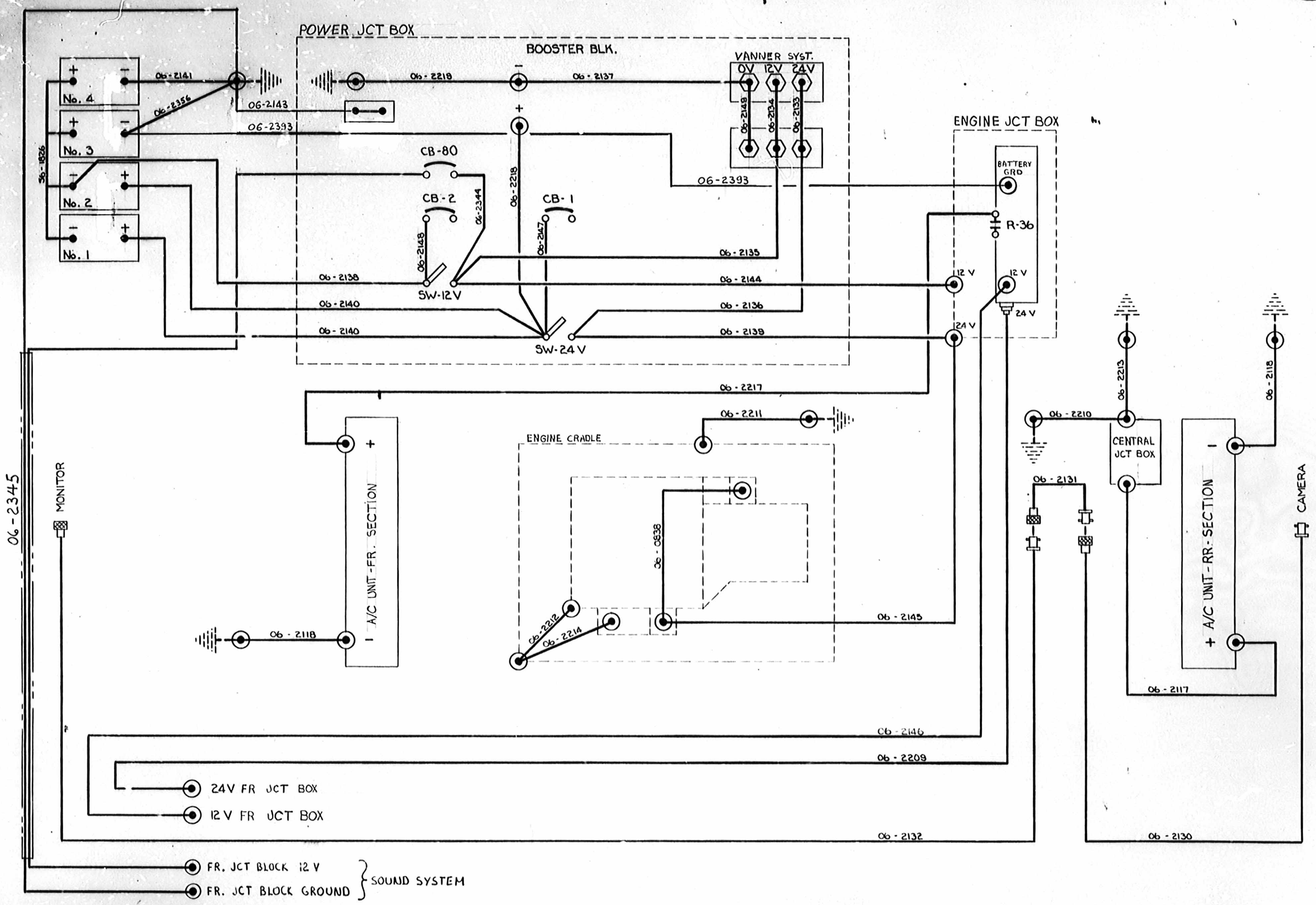

● 24V FR JCT BOX  
● 12V FR JCT BOX

● FR. JCT BLOCK 12 V  
● FR. JCT BLOCK GROUND } SOUND SYSTEM

BINOSTA		LEGEND				TITRE:		DESS:		DATE-	
□	FRONT JUNCTION PANEL	⊙	BATTERY JUNCTION BLOCK				SCHEMA DES CABLES H5-60	D.	TURCOTTE		DEC. 1987
⊙	REAR JUNCTION PANEL	○	SINGLE CONNECTOR					VER.-		APPR.-	
⊙	BATTERY COMPARTMENT	⊙	DIODE (RECTIFIER)								
⊙	CIRCUIT BREAKER	⊙	OPTION				APPL: EFF. W/J001 PRIOR TO J009	REF: H5-60			
⊙	HARNESS CONNECTOR			ITEM	DATE	REVISION	PAR				NO: D-060566 p.C



# CIRCUIT BREAKER CODE

CIRCUIT BREAKER					
CB #	AMP	VOLT	DIAG. PAGE	LOCATION	FUNCTION
1	30	24	1	FRONT JCT. BOX	24 V HOT WIRE
2	30	12	1	"	12 V HOT WIRE
3	90	24	1	ENG. JCT. BOX	24V FEED FRONT JCT. BOX
4	70	24	1	"	24V FEED CENTRAL JCT. BOX
5	70	12	1	"	12V FEED FRONT JCT. BOX
6	8	24	1	FR. JCT. BOX	FEED MASTER SWITCH
7	8	24	1	ENG. JCT. BOX	ENGINE RR START SW & SERV LT
8	8	24	1	"	RR ENGINE CTR SW
9	8	24	1	FR. JCT. BOX	WIPASTO SW.
10	15	24	1	ENG. JCT. BOX	WIPASTO
11	15	12	2	"	E.D.U. (DDEC)
12	15	12	2	"	E.D.U. (DDEC)
13	5	12	2	"	E.C.M. (DDEC)
14	8	12	3	"	ATEC CTR
15	10	12	3	"	BACK-UP ATEC CTR
16	8	24	4	FR. JCT. BOX	ALARM BUZZER & INSTRUMENT
17	10	24	4	"	ELECT. HORN
18	5	24	4	"	FIRE ALARM
19	5	12	4	"	12V VOLTMETER
20	5	24	4	"	FOG LT SW
21	15	12	4	"	FOG LT
22	20	12	4	"	HEADLAMP (HI)
23	15	12	4	"	HEADLAMP (LO)
24	5	24	5	"	HEAD LAMP SW & MULTI-FUNC SW
25	10	24	5	"	MULTI-FUNC SW (WIPER, WASHER)
26	20	12	6	"	FLASHER & HAZARD UNIT
27	15	24	7	ENG. JCT. BOX	FRONT BAGGAGE LT.
28	15	12	5	CENT. JCT. BOX	REAR ID TAIL & LICENCE LT
29	8	12	5	"	REAR CLEARANCE LT
30	8	12	5	"	REAR TAIL & MARKER LT
31	5	12	5	"	LICENCE PLATE LT
32	15	12	5	"	STOP LT
33	5	24	7	FR. JCT. BOX	STOP LT SW
34	5	24	7	"	PARK BRAKE SW

CIRCUIT BREAKER					
CB #	AMP	VOLT	DIAG. PAGE	LOCATION	FUNCTION
35	8	12	7	FR. JCT. BOX	FR. CLEARANCE LT.
36	5	24	8	CENT. JCT. BOX	EXIT LAMP
37	8	12	7	FR. JCT. BOX	FR. SECTION MARKER LT.
38	10	24	7	ENG. JCT. BOX	RR BAG. COMPT LT.
39	10	24	8	FR. JCT. BOX	FR SERV. COMPT LT & DOOR AJAR
40	5	110	9	ALARM JCT. BOX	110-V FLUOR - RR
41	5	"	"	"	110-V FLUOR - FR. FH
42	15	24	"	ENG. JCT. BOX	FRONT FLOOR EXENT (24V)
43	8	24	"	FR. JCT. BOX	HAT RACK LTS SW
44	15	"	"	ENG. JCT. BOX	FRONT READING LTS - RH.
45	15	"	"	"	" " " - LH.
46	8	"	"	ENG. JCT. BOX	REAR " - RH.
47	8	"	"	"	" " " - LH
48	10	"	9	ENG. JCT. BOX	FRONT GENERAL LTS
49	10	"	10	FR. JCT. BOX	DASH LT REOSTAT U/SEAT LT.
50	8	"	"	"	DASH LT REOSTAT
51	10	"	"	"	U/SEAT LT
52	5	"	"	"	PASS & HOSTESS CHIME SW
53	8	"	"	"	A/C & HEAT SW
54	8	"	"	"	A/C LOCK PANEL
55	5	24	13	FR. JCT. BOX	LOWER HTR FAN SW & CTR
56	15	24	"	ENG. JCT. BOX	REAR WATER PUMP
57	15	"	"	"	FRONT WATER PUMP
58	8	"	"	"	A/C COMPR CLUTCH & COND FAN SOL
59	90	"	"	"	FRONT EVAP FAN MOTOR
60	40	"	"	R.E.F.M.	" " " " RH
61	40	"	"	"	" " " " LH
62	40	"	"	ENG. JCT. BOX	FRONT EVAP. FAN MOTOR
63	40	"	"	R.E.F.M.	" " " " RH
64	40	"	"	"	" " " " LH
65	5	"	"	ENG. JCT. BOX	HUMIDISTAT CTR.
66	10	"	"	FR. JCT. BOX	DRIVER'S HTR FAN SW
67	8	24	14	"	REAR VIEW MIRROR
68	15	12	14	"	DRIV. WINDOW LIFTER & CIGAR LIG

	<b>LEGEND</b>	THIS DOCUMENT IS THE PROPERTY OF POLARIS CORP. IT IS TO BE USED ONLY FOR THE PURPOSES SPECIFIED HEREIN. IT IS NOT TO BE REPRODUCED, COPIED, OR TRANSMITTED IN ANY FORM OR BY ANY MEANS, ELECTRONIC OR MECHANICAL, INCLUDING PHOTOCOPYING, RECORDING, OR BY ANY INFORMATION STORAGE AND RETRIEVAL SYSTEM.	D 88-05 C 88-04 B 88-01 A 87-05 ITEM DATE	CB27 EMIT 10A CB42 & CB65 EMIT 8A C.D. 13883 LANCE CORR. PRELIMINAIRE REVISION	M 3C DV PC PW	TITRE : <h2 style="text-align: center;">CIRCUIT BREAKER CODE</h2>	CLASS: P.C. VER.	DATE - 87-05 APPR. -
	FRONT JUNCTION PANEL REAR JUNCTION PANEL BATTERY COMPARTMENT CIRCUIT BREAKER HARNESS CONNECTOR		BATTERY JUNCTION BLOCK SINGLE CONNECTOR DIODE (RECTIFIER) OPTION		AMPL: EFF. W/ J001 PRIOR TO J009 REF: H5-60		NO: D-060566 P.D1 C	

D-060566  
 8.5"  
 11"

11  
 11  
 9.8  
 8.5"  
 11"  
 17"

11  
 11  
 9.8  
 11"



# CIRCUIT BREAKER CODE

CIRCUIT BREAKER					
CB#	AMP	VOLT.	DIAG. PAGE	LOCATION	FUNCTION
69	5	24H	16	FR. JCT. BOX	TACHOGRAPH CLOCK
70	3	24I	16	"	LOW FUEL SENSOR & TT LT
71	8	24	16	CENT. JCT. BOX	TOILET PUMP
72	8	"	"	"	TOILET LTS
73	"	"	"	"	TOILET FAN
74	10	24I	17	FR. JCT. BOX	UPPER WIND. DEFROST
75	10	24	15	"	L.H. CONSOLE SWITCH
76	10	"	17	"	UPPER WIND WIPER & WASHER
77	8	"	18	"	RR & FR DOOR CONTROL
78	3	12I	3	"	RETARDER SW.
79	8	24	18	CENT. JCT. BOX	RR CTR DOOR
80	30	12	21	POWER JCT. BOX	SOUND SYSTEM
81	16	24	19	FR. JCT. BOX	FR E.C.U. ANTI SKID
82	16	"	19	"	" " " "
83	5	"	19	"	" " " "
84	70	12	1	ENG JCT BOX	FEED CENTRAL JCT. BOX
85	8	24I	8	ENG. JCT. BOX	HATRACK COMPT. LT.
86	5	24	21	FR. JCT. BOX	KNEELING SYSTEM
87	5	24I	21	ENG. JCT. BOX	ARTICULATION SW
88	8	24	22	FR. JCT. BOX	ARTICULATION BRAKE
89	8	24I	"	ENG. JCT. BOX	AIR DRYER
90	5	"	22	FR. JCT. BOX	BACK UP MONITOR CONVERTER
91	8	24I	18	FR. JCT. BOX	SPEED LIMITER SW
92	"	24I	22	FR. JCT. BOX	DRIVER'S SEAT HEATER & DG-THERM
94	10	12	23	FR. JCT. BOX	LUGGAGE DOOR LOCK
95	15	12	24	"	RADIO
97	5	24	16	CENT. JCT. BOX	aisle LTS
98	10	12	7	"	BACK-UP LIGHT & BACK UP ALARM
99	"	"	7	"	BACK-UP LT
100	8	24	9	"	GENERAL LT - REAR SECTION
101	5	"	"	"	24V FLUOR LT - REAR SECTION
102	5	12I	22	"	CAMERA HEATER
103	5	12	16	"	LAV. NIGHT LIGHT
105	5	110	9	ALARM JCT. BOX	110-V FLUORESCENT - FR. L.H.

CIRCUIT BREAKER					
CB#	AMP	VOLT.	DIAG. PAGE	LOCATION	FUNCTION
106	5	110	23	ALARM JCT. BOX	WATER HEATER TANK
107	20	110	23	"	ENGINE BLOCK HEATER
108	3	24	3	ENG. JCT. BOX	RETARDER ATEC CTR
109	10	12	6	FR. JCT. BOX	CORNERING LTS
110	15	12	24	"	AUDIO AMPLI - FR. SECT.
111	15	12	24	"	" - RR SECT.
112	5	24	15	FR. JCT. BOX	FR. DESTINATION SIGN
113	20	24	23	CENT. JCT. BOX	LH LUGGAGE DOOR LOCK - RR
114	20	24	23	"	RH LUGGAGE DOOR LOCK - RR
115	25	24	23	ENG. JCT. BOX	FR. LUGGAGE DOOR LOCK

**LEGEND**

	FRONT JUNCTION PANEL		BATTERY JUNCTION BLOCK
	REAR JUNCTION PANEL		SINGLE CONNECTOR
	BATTERY COMPARTMENT		DIODE (RECTIFIER)
	CIRCUIT BREAKER		OPTION
	HARNESS CONNECTOR		

ITEM	DATE	REVISION
E	88-05	CB85 ETAP 5A
D	88-01	CD# 13883
C	88-02	C.O. 13311
B	88-01	LANCE
A	87-05	CORR. PRELIMINAIRE

TITRE: **CIRCUIT BREAKER CODE**

DESS: P.C. DATE: 87-05

VER: *lc* APPR: *[Signature]*

APPL: EFF. W/J001 PRIOR TO J003 REF: H5-60

NO: D-060566 p-D2 C

# CONNECTOR CODE

CONNECTOR			
C#	LOCATION	DESIGNATION	NO. CAVITY
C1	FR. JCT. BOX COMPT.	FR. JCT. BOX TO INTERFACE HARNESS	24
C2	" " " "	" " " " " " " "	22
C3	" " " "	" " " " " " " "	37
C4	" " " "	" " " " " " " "	37
C5	" " " "	" " " " " " " "	37
C6	FR. SERVICE COMPT.-UNDERNEATH	FROM ARTICULATION TO INTERFACE HARNESS	37
C7	" " " "	" " " " " " " "	24
C8	" " " "	FROM ENGINE JCT BOX TO INTERFACE HARNESS	37
C9	" " " "	" " " " " " " "	16
C10	" " " "	" " " " " " " "	37
C11	ALARM JCT. BOX.	ALARM JCT. BOX TO INTERFACE HARNESS	37
C12	ARTICULATION	FROM FR. SERVICE COMPT TO ARTICULATION HARN.	24
C13	"	" " " " " " " "	37
C14	"	FROM ENG. JCT BOX TO ARTICULATION HARN.	6
C15	"	" " " " " " " "	24
C16	FR. SECT. LH HAT RACK - RR	FEED LH HAT RACK ACCESSORIES	9
C17	FR. SECT. RH HAT RACK - RR	FEED RH HAT RACK ACCESSORIES	9
C18	ARTICULATION	FR. COMPT. TO ENGINE COMPT.	24
C19	ARTICULATION	FEED ARTICULATION ACCESSORIES	22
C20	ENGINE JCT. BOX	FROM FR. SERVICE COMPT. TO ENGINE JCT. BOX	37
C21	" " " "	" " " " " " " "	16
C22	" " " "	" " " " " " " "	37
C23	" " " "	FROM ARTICULATION TO ENGINE JCT. BOX	24
C24			
C25	ENGINE JCT. BOX - ENGINE COMPT.	ENG. JCT. BOX TO ENGINE CRADLE HARNESS	35
C26	" " " " " " " "	" " " " " " " "	47
C27			
C28	ENGINE JCT. BOX - ENGINE COMPT.	ENG. JCT. BOX TO ENGINE CRADLE HARNESS	26
C29	" " " " " " " "	ENG. JCT. BOX TO ENGINE COMPT. HARNESS	22
C30	FR. SERVICE COMPT.	FROM ENGINE JCT. BOX TO INTERFACE HARNESS	16
C31	ENGINE JCT. BOX	FROM FR. SERVICE COMPT. TO ENGINE JCT. BOX	16
C32	" " " "	ENG. JCT. BOX TO LUGGAGE COMPT. LTS.	22
C33			
C34			
C35			
C36			
C37			
C38			

-CONNECTOR				
C#	LOCATION	DESIGNATION	NO. CAVITY	
C39	FR. SECT. LH HAT RACK - RR	FEED LH SPEAKER	2	
C40	FR. SECT. RH HAT RACK - RR	FEED RH SPEAKER	2	
C41	FR. SECT. RH HAT RACK - RR	FEED RH 110V FLUORESCENT	2	
C42	FR. SECT. LH HAT RACK - RR	FEED LH 110V FLUORESCENT	2	
C43				
C44	FR. JCT BOX COMPT.	ANTI-SKID E.C.U. MODULE	35	
C45	ALARM JCT BOX COMPT.	FEED FR. ROOF ACCESSORIES	24	
C46	FR. SERVICE COMPT.	FEED FR. SERVICE COMPT. ACCESSORIES	24	
C47	FR. SERVICE COMPT.	FEED HEAD & FOG LAMP	7	
C48	FR. AXLE	FEED FR. AXLE ACCESSORIES	22	
C49	ALARM JCT BOX COMPT.	FEED INSTRUMENT PANEL	37	
C50	" " " "	" " " " " " " "	37	
C51	" " " "	" " " " " " " "	24	
C52	" " " "	FEED LH CONSOLE	37	
C53	" " " "	FEED LH SW. PANEL	37	
C54	UNDER DASH - LH CORNER	FEED P.A. UNIT	3	
C55	UNDER DASH - CENTER	FEED RH SW. PANEL	9	
C56	" " " "	FEED RH CONSOLE	24	
C57	" " " "	FEED UNDER DASH ACCESSORIES - RH	22	
C58	FR JCT BOX COMPT.	OPTION SLIP DRIVE CONTROL	3	
C59	LH CONSOLE	CRUISE ON OFF SW.	8	
C60	" "	CRUISE SET SW.	8	
C61	" "	CRUISE RESUME SW.	8	
C62				
C63				
C64				
C65				
C66				
C67				
C68	ALARM JCT BOX	ALARM JCT. BOX TO INTERFACE HARNESS	16	
C69	" " " "	FEED DASH INSTRUMENT PANEL	16	
C70	" " " "	FEED LH CONSOLE	24	
C71	UNDER INSTRUMENT PANEL - LH	FEED INSTRUMENT PANEL - LH	37	
C72	UNDER INSTRUMENT PANEL	FEED CENTRAL INSTRUMENT PANEL	37	
C73	" " " "	" " " " " " " "	16	
C74				
C75	ALARM JCT BOX COMPT.	FEED FR. ROOF ACCESSORIES	22	
C76	FR. SERVICE COMPT.	FROM ENGINE JCT. BOX TO INTERFACE HARNESS	14	

**PREVOST**

**LEGEND**

<p>□ FRONT JUNCTION PANEL</p> <p>○ REAR JUNCTION PANEL</p> <p>○ BATTERY COMPARTMENT</p> <p>○ CIRCUIT BREAKER</p> <p>○ HARNESS CONNECTOR</p>	<p>⊙ BATTERY JUNCTION BLOCK</p> <p>○ SINGLE CONNECTOR</p> <p>⊖ DIODE (RECTIFIER)</p> <p>--- OPTION</p>
---	--

CE DOCUMENT EST LA PROPRIÉTÉ EXCLUSIVE DE PREVOST CAR INC. TOUT REPRODUCTION, EN TOUT OU EN PARTIE, EST INTERDITE SANS LAutorisation ÉCRITE DE PREVOST CAR INC. CE DOCUMENT IS THE EXCLUSIVE PROPERTY OF PREVOST CAR INC. ANY REPRODUCTION, IN WHOLE OR IN PART, IS PROHIBITED WITHOUT THE WRITTEN CONSENT OF PREVOST CAR INC.

A	88-02	LANCE					
ITEM	DATE	REVISION					

TITRE: **CONNECTOR CODE**

APPL: EFF. W/J001 PRIOR TO J008      REF: H5-60

DESS: *M.J.*      DATE: 88/02

VER.-      APPR.-

NO: D-060566 P. E1 C

# CONNECTOR CODE

CONNECTOR			
C #	LOCATION	DESIGNATION	NO. CAVITY
C77	FR. SERVICE COMPT.	FEED FR. SERVICE COMPT. ACCESSORIES	16
C78			
C79	DRIVE AXLE	FEED DRIVE AXLE ACCESSORIES	22
C80	ENGINE JCT BOX COMPT.	FROM ARTICULATION TO ENGINE JCT. BOX	14
C81	" " " "	ELECTRONIC CONTROL MODULE ENGINE	30
C82	" " " "	" " " "	30
C83	" " " "	ELECTRONIC CONTROL UNIT (TRANSMISSION)	30
C84	" " " "	" " " "	30
C85	FR. JCT BOX COMPT.	SPEED LIMITE SW.	9
C86	FR. SERVICE COMPT.	SIDE FLASHER RH	2
C87	" " " "	SIDE MARKER	2
C88	" " " "	DRIVER'S LIQUID SOL. VALVE	2
C89	" " " "	DRIVER'S WATER VALVE	2
C90	" " " "	THROTTLE POSITION SENSOR	3
C91	" " " "	INSTRUMENT PANEL RHEOSTAT	2
C92	" " " "	AIR RETURN SENSOR	2
C93	" " " "	SIDE FLASHER LH	2
C94	" " " "	BRAKE INTERLOCK SOL. VALVE	2
C95	" " " "	FRESH AIR DAMPER SOL. VALVE	2
C96	" " " "	ELECTRICAL HORN	2
C97	" " " "	BELLOWS CTR. VALVE	2
C98	" " " "	EXHAUST CTR. SOL. VALVE	2
C99	" " " "	STEERING COMPT. LTS	2
C100	CENTRAL JCT. BOX	CENTRAL JCT BOX TO RR SERVICE COMPT.	22
C101	RR SERVICE COMPT.	FEED RR LOWER LAMP	16
C102	" " " "	FEED RR ROOF ACCESSORIES	22
C103	" " " "	FEED RR SERVICE COMPT. ACCESSORIES	24
C104	RR AXLE ACCESSORIES	FEED RR AXLE ACCESSORIES	22
C105	ARTICULATION	FROM ARTICULATION TO RR SERVICE COMPT.	14
C106	RR END LH SIDE	RR LH LOWER LAMP	9
C107	RR END CENTER	CYCLOP LT.	2
C108	" " " "	LICENCE PLATE LT.	2
C109	RR END RH SIDE	RR RH LOWER LAMP	9
C110	RR SERVICE COMPT.	RR JCT BOX	24
C111	RR SECT. LH HAT RACK - FR.	FEED LH HAT RACK ACCESSORIES	9
C112	RR SECT. RH HAT RACK - FR.	FEED RH HAT RACK ACCESSORIES	9
C113	RR SECT. LH HAT RACK - FR.	FEED LH SPEAKER	4
C114	RR & FR LH HAT RACK	FOR READING LTS	2

CONNECTOR			
C #	LOCATION	DESIGNATION	NO CAVITY
C115	HAT RACK	FLUORESCENT	4
C116	" "	BALLAST DISTRIBUTION	6
C117	" "	BALLAST FEEDING	4
C118	" "	FEED GENERAL & HAT RACK LTS	3
C119	" "	FLUORESCENT	4
C120	" "	BALLAST DISTRIBUTION	6
C121	RR SECT. RH HAT RACK - FR.	FEED 110-V FLUOR.	2
C122	" " " " " "	FEED SPEAKER	4
C123	RR & FR. RH HAT RACK	READING LTS	2
C124	CENTRAL JCT. BOX	FROM CENTRAL JCT. BOX TO RR RH HAT RACK	24
C125			
C126	CENTRAL JCT. BOX	FROM CENTRAL JCT. BOX TO RR LH HAT RACK	24
C127	ARTICULATION	RR DIGITAL THERMOMETER FEEDING	3
C128			
C129	CENTRAL JCT. BOX	FROM CENTRAL JCT. BOX TO RH LUGGAGE COMPT.	14
C130	" " " "	" " " " " LH " "	9
C131	" " " "	FROM CENTRAL JCT. BOX TO ARTICUL. HARN.	6
C132	" " " "	" " " " " " " "	24
C133	" " " "	" " " " " " " "	37
C134	" " " "	" " " " " " " "	16
C135			
C136	CENTRAL JCT. BOX	FROM CENTRAL JCT. BOX TO RR SERVICE COMPT.	16
C137	RH CONSOLE	RR DIGITAL THERMOMETER	2
C138	aisle R R. STEP WELL	AIR RETURN SENSOR	2
C139	LH & RH ROOF ARTICULATION	FEED EMERGENCY EXIT LTS	2
C140	RR SECT. LH HAT RACK - FR.	FEED 110-V FLUOR.	2
C141	FR. SERVICE COMPT.	KNEELING LT	2
C142	RH CONSOLE	FR. DIGITAL THERMOMETER	2
C143	FR LUGGAGE COMPT.	" " " " " SENSOR	2
C144	ARTICULATION - LH	RR DIGITAL THERMOMETER SENSOR	2
C145	RR SECT. LUGGAGE COMPT. - RH	LUGGAGE LTS	2
C146	" " " " " "	" " " " " "	2
C147	" " " " " "	FEED LUGGAGE DOOR LOCK	6
C148	" " " " " "	LUGGAGE LTS	2
C149	" " " " " "	FEED LUGGAGE DOOR LOCK	6
C150	" " " " " "	LUGGAGE LTS	2
C151	" " " " " "	AIR RETURN SENSOR	2
C152	" " " " " "	FEED LUGGAGE DOOR LOCK	6

<b>PREVOST</b> <input type="checkbox"/> FRONT JUNCTION PANEL <input type="checkbox"/> REAR JUNCTION PANEL <input type="checkbox"/> BATTERY COMPARTMENT <input type="checkbox"/> CIRCUIT BREAKER <input type="checkbox"/> HARNESS CONNECTOR	<b>LEGEND</b> <input type="checkbox"/> BATTERY JUNCTION BLOCK <input type="checkbox"/> SINGLE CONNECTOR <input type="checkbox"/> DIODE (RECTIFIER) <input type="checkbox"/> OPTION	THIS DOCUMENT IS THE EXCLUSIVE PROPERTY OF PREVOST CAR INC. IT IS LOANED TO YOU BY THE VENDOR OF THE VEHICLE OR EQUIPMENT. IT IS NOT TO BE REPRODUCED OR TRANSMITTED IN ANY FORM OR BY ANY MEANS, ELECTRONIC OR MECHANICAL, INCLUDING PHOTOCOPYING, RECORDING, OR BY ANY INFORMATION STORAGE AND RETRIEVAL SYSTEM, WITHOUT THE EXPRESS WRITTEN PERMISSION OF PREVOST CAR INC.	ITEM	DATE	REV.	PAR	<b>CONNECTOR CODE</b>	DESS: <i>M.J</i> VER.	DATE: 88/02 APPR.
			B 88-02 C.D. # 13311 A 88-02 LANCE TEM	B.C. <i>M.J</i> PAR	APPL: EFF. W/J001 PRIOR TO J008 REF: H5-60	NO: D-060566 P.E2 C			

P.E2



# CONNECTOR CODE

CONNECTOR			
C #	LOCATION	DESIGNATION	NO. CAVITY
C153	RR SECT. LUGGAGE COMPT. LH	LUGGAGE LTS	2
C154	" " " " "	AIR AMBIENT SENSOR	2
C155	" " " " "	LUGGAGE LTS	2
C156	" " " " "	FEED LUGGAGE DOOR LOCK	6
C157	" " " " "	LUGGAGE LTS	2
C158	" " " " "	FEED LUGGAGE DOOR LOCK	6
C159	" " " " "	LUGGAGE LTS	2
C160	" " " " "	AIR RETURN SENSOR	2
C161	" " " " "	LUGGAGE DOOR LOCK	6
C162	RR SECT. LUGGAGE COMPT.	ST1 WATER VALVE	2
C163	" " " " "	ST2 WATER VALVE	2
C164	" " " " "	ST3 WATER VALVE	2
C165	" " " " "	LIQUID SOLENOID VALVE	2
C166	" " " " "	FEED WATER VALVE	9
C167	RR END ROOF	CLEARANCE LTS	2
C168	" " " " "	WATCH YOUR STEP	2
C169	" " " " "	LAVATORY OCCUPIED SW.	2
C170	RR SECT. UNDER LH SEAT	FEED. LH UNDER SEAT ACCESSORIES	4
C171	" " " " "	ACCELEROMETER	2
C172	" " " " "	AISLE LTS	2
C173	" " " " "	RUNNING LTS	2
C174	UNDER DASH - RH	DRIVERS HTR SPEED CTR MODULE	9
C175	" " " " "	" " " " "	9
C176	" " " " "	LOWER WIND. WIPER PULSE GENERATOR	6
C177	" " " " "	LOWER WINDSHIELD WIPER MOTOR	6
C178	" " " " "	DRIVER'S HTR & DEFROSTER LH FAN	2
C179	" " " " "	" " " " RH "	2
C180	RR END ROOF - CENTER	CAMERA	4
C181	" " " " - LH	LAVATORY FLUORESCENT	2
C182	" " " " - LH	WATER TANK HEATER	3
C183	RR SERVICE COMPT.	SIDE MARKER	2
C184	" " " " "	SIDE DIRECTIONAL LTS LH	2
C185	" " " " "	FRESH AIR DAMPER SOL. VALVE	2
C186	" " " " "	FRESH AIR SENSOR	2
C187	" " " " "	CAMERA DOOR SOLENOID	2
C188	" " " " "	CAMERA DOOR CTR. SW.	4
C189	" " " " "	LAVATORY PUMP	2
C190	" " " " "	BACK-UP ALARM	2

CONNECTOR			
C #	LOCATION	DESIGNATION	NO. CAVITY
C191	RR SERVICE COMPT.	TOILET VENTILATION	2
C192	" " " " "	SIDE DIRECTIONAL LTS-RH	2
C193	" " " " "		
C194	" " " " "		
C195	ARTICULATION	ANTI-JACK SYSTEM	2
C196	" " " " "		
C197	" " " " "		
C198	" " " " "		
C199	" " " " "		
C200	FR. SECT. HAT RACK	FLUORESCENT	4
C201	" " " " "	"	4
C202	" " " " "	BALLAST FEEDING	4
C203	" " " " "	BALLAST DISTRIBUTION	6
C204	" " " " "	FEED GENERAL & HAT RACK LTS	3
C205	FR. SECT. RH HAT RACK - FR.	SPEAKER	4
C206	" " " " "		
C207	" " " " "		
C208	FR. SECT. - LH HAT RACK	BALLAST FEEDING	4
C209	" " " " "	READING LTS	2
C210	FR. SECT. LH HAT RACK - FR.	SPEAKER	4
C211	FRONT ROOF	DRIVER'S STORE-LH	2
C212	" " " " "	DRIVER'S STORE-RH	2
C213	" " " " "	CLEARANCE LTS	2
C214	" " " " "	AMPLIFIER RH SPEAKER CONNECTION	2
C215	" " " " "	" LH " "	2
C216	UNDER DASH - LH CORNER	P.A. DISTRIBUTION	9
C217	" " " " "	P.A. MICRO OUTLET	3
C218	" " " " "	P.A. VOLUME	3
C219	" " " " "	P.A. DRIVER'S SPEAKERS CONNECTION	4
C220	" " " " "	P.A. AMPLIFIER CONNECTION	7
C221	" " " " "	P.A. RADIO CONNECTION	7
C222	ALARM JCT BOX COMPT.	MICRO OUTLET	4
C223	" " " " "	DRIVER'S SPEAKERS FEEDING	4
C224	RH SWITCH PANEL	RADIO	7
C225	" " " " "		
C226	FR. ROOF - LH	AMPLIFIER	7
C227	RH SWITCH PANEL	SPEAKER SELECTOR SW.	8
C228	" " " " "	MICRO OUTLET	4

<b>PREVOST</b>	<b>LEGEND</b>	CE DOCUMENT EST LA PROPRIETE EXCLUSIVE DE PREVOST CAR INC. IL NE PEUT ETRE REPRODUIT OU COMMUNIQUE EN TOUTE MANIERE SANS LE CONSENTEMENT ECRIT DE PREVOST CAR INC.			
<input type="checkbox"/> FRONT JUNCTION PANEL <input type="checkbox"/> REAR JUNCTION PANEL <input type="checkbox"/> BATTERY COMPARTMENT <input type="checkbox"/> CIRCUIT BREAKER <input type="checkbox"/> HARNESS CONNECTION	<input type="checkbox"/> BATTERY JUNK OR BLOCK <input type="checkbox"/> SINGLE CONNECTOR <input type="checkbox"/> DIODE (RECTIFIER) <input type="checkbox"/> OPTION	THIS DOCUMENT IS THE EXCLUSIVE PROPERTY OF PREVOST CAR INC. IT MAY NOT BE REPRODUCED OR TRANSMITTED IN ANY FORM OR BY ANY MEANS WITHOUT THE EXPRESS WRITTEN PERMISSION OF PREVOST CAR INC.	B 89-02 A 88-02 REV DATE	o.c.#89033, c.o.#16182 LANCE REVISION	Rob M/L PAR
<b>CONNECTOR CODE</b>			APPL: EFF. W/J001 PRIOR TO J009 REF: H5-60	PREP: M.J VER: APPR:	DATE: 88/02 REF: D-060566 P.E3 C



# CONNECTOR CODE

CONNECTOR			
C #	LOCATION	DESIGNATION	NO. CAVITY
C229	RH SWITCH PANEL	P.A. VOLUME CONTROL	4
C230	" " "	LH DRIVER'S SPEAKER	2
C231	" " "	RADIO FEEDING	4
C232	" " "	RH DRIVER'S SPEAKER	2
C233	FR. SECTION ARTICULATION	ARTICULATION VERTICAL SAFETY SW.	2
C234	" " "	ARTICULATION HORIZONTAL SAFETY SW.	6
C235	" " "	LOW COOLANT SENSOR	3
C236	" " "	" " "	"
C237	FR. SECT. UNDER SEAT - LH	AISLE LTS FEEDING	2
C238	" " " " "	AISLE LTS	2
C239	FR. AXLE	FUEL TANK LEVEL GAUGE	4
C240	" " "	KNEELING SW.	2
C241	FR. SERVICE COMPT.	FOG RESISTOR BOX	3
C242	" " "	FR. L.H. MARKER & DIRECT. LT.	3
C243	" " "	HEADLAMPS	3
C244	" " "	L.H. FOG LAMP	2
C245	" " "	R.H. FOG LAMP	2
C246	" " "	FR. R.H. MARKER & DIRECT. LT.	3
C247	ALARM JCT. BOX	DIAGNOSTIC DDEC & ATEC	12
C248	" " "	UPPER WIND. WIPER PULSE GENERATOR	12
C249	" " "	CONVERTER 12V TO 5V (8/U MONITOR)	3
C250	" " "	DASH LTS REGULATOR CTR	6
C251	LT SWITCH PANEL	FAST IDLE SW.	8
C252	" " "	SWITCH LTS.	2
C253	" " "	ETHER SW.	8
C254	" " "	WEBASTO SW.	8
C255	" " "	RETARDER SW.	8
C256	" " "	STOP ENGINE OVERRIDE SW.	8
C257	" " "	" " "	"
C258	LT SWITCH PANEL	MULTI - FUNCTION SW.	8
C259	" " "	MULTI - FUNCTION SW.	6
C260	INSTR. PANEL - CENTER PLATE	TACHOGKAPH HEAD RPM	4
C261	" " " " "	TACHOGRAPH HEAD ANTI-JACK	4
C262	" " " " "	TACHOGRAPH HEAD FEEDING	4
C263	" " " " "	TACHOGRAPH HEAD SPEEDO	4
C264	" " " " "	ENGLER TACHO HEAD	6
C265	" " " " "	ENGLER SPEEDO HEAD	6
C266	ENGINE CRADLE	HANUAL TRANSMISSION ACCES.	4

CONNECTOR			
C #	LOCATION	DESIGNATION	NO. CAVITY
C267	ENGINE CRADLE	SPEED SENSOR	3
C268	" " "	RPM SENSOR	3
C269	" " "	JACOB L.H. BANK BRAKE	1
C270	" " "	FEED DDEC MOTOR ACCES.	22
C271	" " "	JACOB R.H. BANK BRAKE	1
C272	" " "	DDEC E.D.U	16
C273	" " "	MOTOR BLOCK HEATER	3
C274	" " "	DDEC POWER CONN. E.D.U.	6
C275	" " "	DDEC OPTION	4
C276	" " "	CONDENSER FAN SOL. VALVE	2
C277	ENGINE CRADLE	RACOR FUEL FILTER	2
C278	" " "	WEBASTO	6
C279	" " "	FR. WATER PUMP	2
C280	" " "	FR. ST3 WATER VALVE	2
C281	" " "	FR. ST2 WATER VALVE	2
C282	" " "	FR. ST1 WATER VALVE	2
C283	" " "	ATEC SPEED SENSOR	2
C284	" " "	ATEC THROTTLE SENSOR N/A	3
C285	" " "	ATEC TRANSMISSION	23
C286	RH SWITCH PANEL	A/C & HEAT SW.	1
C287	" " "	A/C FAN ONLY	1
C288	" " "	FRESH AIR SW.	1
C289	" " "	SWITCH LTS	2
C290	" " "	" " "	"
C291	FR. SECTION LUGGAGE COMPT.	LUGGAGE LTS	2
C292	" " " "	" " "	2
C293	" " " "	" " "	2
C294	" " " "	" " "	2
C295	" " " "	AIR AMBIENT SENSOR	2
C296	" " " "	LUGGAGE LTS	2
C297	FR. SECTION LUGGAGE COMPT.	AIR RETURN SENSOR	2
C298	" " " " "	" " " "	2
C299	" " " " "	LUGGAGE LTS	2
C300	" " " " "	FRESH AIR SENSOR	2
C301	" " " " "	" " " "	2
C302	FR. SECTION LUGGAGE COMPT.	LIQUID SOLENOID VALVE	2
C303	" " " " "	LUGGAGE DOOR LOCK FEEDING	6
C304	" " " " "	" " " " "	6

		<b>LEGEND</b> BATTERY JUNCTION BLOCK SINGLE CONNECTOR DIODE (RECTIFIER) OPTION		THIS DOCUMENT IS THE EXCLUSIVE PROPERTY OF PREVOST CAN INC. IT IS CLASSIFIED AS CONFIDENTIAL AND IS NOT TO BE REPRODUCED OR DISSEMINATED IN ANY MANNER WITHOUT THE EXPRESS WRITTEN PERMISSION OF PREVOST CAN INC.				TITLE: <b>CONNECTOR CODE</b>		DESS: <i>M.L.</i>	DATE: 88/02
FRONT JUNCTION PANEL REAR JUNCTION PANEL BATTERY COMPARTMENT CIRCUIT BREAKER HARNESS CONNECTOR				B 88-02 A 88-02 ITEM DATE	C.D. # 13311 LANCE REVISION	B.C. <i>M.L.</i> PAR	APPL: EFF. W/J001 PRIOR TO J008		REF: H5-60	VER.- APPR.-	NO: D-060566 P.E4 C

# CONNECTOR CODE

CONNECTOR			
C #	LOCATION	DESIGNATION	NO. CAVITY
C 305	FR SECTION LUGGAGE COMPT.	LUGGAGE DOOR LOCK FEEDING	6
C 306	" " " "	" " " "	6
C 307	L.H. CONSOLE	DRIVER'S SEAT HEATER	4
C 308	" "	DASH LT. RHEOSTAT	
C 309	" "	GALLEY SW.	8
C 310	" "	LUGGAGE DOOR LOCK SW.	8
C 311	" "	HOTSTESS & PASS. CHIME SW.	8
C 312	" "	READING LT. SW.	8
C 313	" "	GENERAL LT. & 24V FLUOR. SW.	8
C 314	" "	FR. DESTINATION SIGN SW.	8
C 315	" "	L.H. STORE SW.	8
C 316	ENGINE COMPT.	ETHER QUICKSTART VALVE	2
C 317	L.H. CONSOLE	R.H. STORE SW.	8
C 318	" "	DRIVER'S WINDOW LIFTER	
C 319	" "	DRIVER'S SEAT HEATER SW.	8
C 320	" "	DRIVER'S LT. SW.	8
C 321	" "	SHIFTER SELECTOR	16
C 322	" "	DRIVER'S WINDOW LIFTER MOTOR	2
C 323	" "	CRUISE CONTROL SW. PANEL	14
C 324	" "	ARTICULATION BRAKE SW.	8
C 325	" "	KNEELING SW.	8
C 326	" "	RR. & FR. ENTRANCE DOOR SW.	8
C 327	ENGINE COMPT.	ENGINE CONTROL SWITCHES	9
C 328	" "	WATER PUMP	2
C 329	" "	SERVICE LTS.	1
C 330	ENGINE COMPT. - AT A/C COMPR.	UNDER LOADER SOL. VALVE	2
C 331	" " " "	" " " "	2
C 332	" " " "	A/C COMPR. CLUTCH	2
C 333	" " " "	A/C LO-PRESSURE SW.	2
C 334	" " " "	A/C HI-PRESSURE SW.	2
C 335	ENGINE COMPT.	RETARDER SOL. VALVE	2
C 336	INSTRUMENT PANEL - LH SECT.	INSTRUMENT & SW. LTS	
C 337	" " " "	UPPER WIND. WIPER MOTOR CONTROL SW.	8
C 338	" " " "	UPPER WINDSHIELD DEFROST SW.	8
C 339	" " " "	UPPER WINDSHIELD WASHER CTR. SW.	8
C 340	" " " "	L.H. MIRROR ADJUSTING SW.	8
C 341	" " " "	HEATED MIRROR SW.	8
C 342	" " " "	R.H. MIRROR ADJUSTING SW.	8

CONNECTOR			
C #	LOCATION	DESIGNATION	NO. CAVITY
C 343	INSTRUMENT PANEL - LH. SECT.	HEADLAMP SW.	8
C 344	" " " "	HAZARD WARNING LTS SW.	8
C 345	" " " "	FOG LT. SW.	8
C 346	" " " "	SWITCH LTS.	2
C 347	" " " "	DASH LT. SW.	2
C 348	INSTRUMENT PANEL - CENTER	RACOR FILTER T.T. LT. MODULE	6
C 349	R.H. CONSOLE	RED LED INDICATOR - FR. SECT. (HTR)	2
C 350	" "	DIGITAL THERMOMETER	3
C 351	" "	RED LED INDICATOR - RR. SECT. (HTR)	2
C 352	" "	DRIVER'S TEMP. CONTROL SENSOR	3
C 353	INSTRUMENT PANEL - RH	DRIVER'S HTR. FAN SPEED CTR. RHEOSTAT	6
C 354	" " " "	DRIVER'S TEMP. CONTROL	6
C 355	" " " "	FRONT TEMP. CONTROL	3
C 356	" " " "	REAR TEMP. CONTROL	3
C 357	" " " "	WATER TEMP. GAUGE	3
C 358	" " " "	FUEL LEVEL GAUGE	3
C 359	" " " "	INSTRUMENT PANEL LIGHTING	2
C 360	" " " "	B/U MONITOR	2
C 361	FR. ROOF	UPPER WIPER MOTOR	6
C 362	" "	LAVATORY OCCUPIED SIGN	2
C 363	" "	WATCH YOUR STEP SIGN	2
C 364	" "	FR. DESTINATION SIGN	3
C 365	" "	UPPER WINDSHIELD DEFROST	3
C 366	R.H. CONSOLE	GREEN LED INDICATOR - FR. SECT. (A/C)	2
C 367	" "	GREEN LED INDICATOR - RR. SECT. (A/C)	2

<b>PRIVOST</b>	<b>LEGEND</b>	CE DOCUMENT EST LA PROPRIETE EXCLUSIVE DE PRIVOST CAR INC. IT IS THE PROPERTY OF PRIVOST CAR INC. THIS DOCUMENT IS THE EXCLUSIVE PROPERTY OF PRIVOST CAR INC. NO PART OF THIS DOCUMENT IS TO BE REPRODUCED OR TRANSMITTED IN ANY FORM OR BY ANY MEANS, ELECTRONIC OR MECHANICAL, INCLUDING PHOTOCOPYING, RECORDING, OR BY ANY INFORMATION STORAGE AND RETRIEVAL SYSTEM, WITHOUT THE EXPRESS WRITTEN PERMISSION OF PRIVOST CAR INC.	TITRE:	DESS: D.T.	DATE: 88-02
<input type="checkbox"/> FRONT JUNCTION PANEL <input type="checkbox"/> REAR JUNCTION PANEL <input type="checkbox"/> BATTERY COMPARTMENT <input type="checkbox"/> CIRCUIT BREAKER <input type="checkbox"/> HARNESS CONNECTOR	<input type="checkbox"/> BATTERY JUNCTION BLOCK <input type="checkbox"/> SINGLE CONNECTOR <input type="checkbox"/> DIODE (RECTIFIER) <input type="checkbox"/> OPTION		CONNECTOR CODE	VER.:	APPR.:
		A 88-02 LANCE ITEM DATE REVISION	DY. PAR	APPL. EFF. W/J001 PRIOR TO J008	REF: H5-60
				NO: D-060566 p.E5 C	

# DIODE CODE

DIODE					
D <sup>n</sup>	AMP.	VOLT	DIAG. PAGE	LOCALISATION	FONCTION
1		24	4	FR. JCT. BOX	LO-AIR SEC.
2		24	4	"	LO-AIR PRIM.
3		"	5	"	HEAD LAMP CTR
4		24	1	ENG. JCT. BOX	NEUTRAL GROUND
5		"	9	ENG. JCT. BOX	RR ELECTRONIC TRANSMITTER
6		"	12	"	A/C CTR MODUL - REAR
7		"	10	"	FR ELECTRONIC TRANSMITTER
8		"	12	"	A/C CTR MODUL - REAR
9		"	12	"	" " " "
10		"	11	"	A/C CTR
11		"	11	FR. JCT. BOX	" "
12		"	11	"	" "
13		"	16	CENT. JCT. BOX	TOILET
14		"	18	FR. JCT. BOX	REAR & FRONT CTR DOOR
15		"	18	"	" " " "
16		"	18	"	" " " "
17		"	21	"	KNEELING CTR
18		"	21	"	" "
19		"	21	"	" "
20		12	21	ENG. JCT. BOX	ARTICULATION SW # 3
21		24	13	"	FAN A/C ONLY
22		24	5	FR. JCT. BOX	HAZARD - FLASHER RH.
23		24	5	"	" " LH
24		24	5	"	(BRAKE TT LT) SW
25		24	5	"	(FASTIDE SW) STOP SW.
26		24	13	ENG. JCT. BOX	FAN A/C ONLY
29		24	22	CENT. JCT. BOX	ARTICULATION BRAKE SYSTEM
31		24	22	CENT. JCT. BOX	ARTICULATION BRAKE SYSTEM
32	20	24	23	ENG. JCT. BOX	LUGGAGE DOOR LOCK FR.
33	20	24	23	"	" " " "
34	20	24	23	CENT. JCT. BOX	LUGGAGE DOOR LOCK RR
35	20	24	23	"	" " " "
36	20	24	23	"	" " " "
37	20	24	23	"	" " " "
38	3	24	5	FR. JCT. BOX	BACK-UP CORNERING "SPECIAL VOYAGEUR"

DIODE					
D <sup>n</sup>	AMP.	VOLT	DIAG. PAGE	LOCALISATION	FONCTION
39	3	12	5	FR. JCT. BOX	BACK-UP CORNERING "SPECIAL VOYAGEUR"
40	3	12	5	"	" " " "
41	3	24	5	"	" " " "

**LEGEND**

- FRONT JUNCTION PANEL
- REAR JUNCTION PANEL
- BATTERY COMPARTMENT
- CURTAIN BREAKER
- HARNESSE CONNECTOR
- BATTERY JUNCTION BLOCK
- SINGLE CONNECTOR
- DIODE (RECTIFIER)
- OPTION

REVISIONS

1	87-01	D32 & D37 AJOUTES OC# 69012	M/
2	88-03	D-4 AJOUTE	M/
3	88-01	LANCE	DT
4	87-05	CORR. PRELIMINAIRE	PC.

F	89-01	D38 & D41 AJOUTES OC# 89162	M/
E	89-02	O.C. #89033, C.D. #16183	R/b.
D	89-01	D32 & D37 AJOUTES OC# 69012	M/
C	88-03	D-4 AJOUTE	M/
B	88-01	LANCE	DT
A	87-05	CORR. PRELIMINAIRE	PC.
ITEM	DATE	REVISION	PAR

TITRE: DIODE CODE

APPL: EFF. W/J001 PRIOR TO J009 REF: H5-60

DRESS: P.C. DATE- 87-05

VER.- APPR.-

NO: D-060566 p.F C



# RELAYS CODE

RELAYS							
R#	DIAG. PAGE		AMP	CATEGORY	VOLT.	LOCATION	FUNCTION
	COIL	CONT.					
1	1	4		MAGNETIC	24	FR. JCT. BOX	ENGINE RUN (24V)
2	1	1		"	"	ENG. JCT. BOX	" " (24V)
3	1	16		BOSH N.C.	"	CENT. JCT. BOX	" " (24V)
4	1	1		MAGNETIC	"	ENG. JCT. BOX	STARTING MOTOR
5	1	11		BOSH N.C.	12	FR. JCT. BOX	BLOWER CUT IN
6	3	2		BOSH N.O.	24	ENG. JCT. BOX	BRAKE SW CRUISE CTR.
7	3	2		BOSH N.C.	"	"	FAST IDLE DDEC CTR
8	3	3		"	"	"	CUT IN 12V ATEC
9	3	3		BOSH N.O.	"	"	CHECK TRANSM ATEC
10	3	3		"	"	"	BACK UP ATEC SIGNAL
11	3	3		"	12	"	RETARDER ATEC
12	4	4		"	24	FR. JCT. BOX	ELECTRICAL HORN
13	4	4		"	"	"	FRONT FOG LT
14	5	4		"	"	"	HEADLAMPS CONTROL
15	5	4		"	"	"	HEADLAMPS (HI)
16	5	4		"	"	"	" (Lo)
17	5	7		"	"	"	FRONT CLEARANCE LT
18	5	10		"	"	"	U/SEAT LT & DASH RHEOSTAT
19	5	6		"	"	"	RH. DIRECTIONAL LT
20	5	6		"	24	"	LH. " "
21	5	5		BOSH N.C.	"	"	BLINKER
22	5	5		BOSH N.O.	"	CENT. JCT. BOX	RR CLEAR MARKER & LIC. LT
23	7	5		"	"	"	STOP LT
24	9	9		"	"	ENG. JCT. BOX	FRONT FLUORESCENT (24V)
25	9	9		"	"	"	FRONT READING LTS
26	9	9		"	"	CENT. JCT. BOX	REAR " "
27	9	9		"	"	ENG. JCT. BOX	GENERAL LTS
28	9	9		"	24	"	A/C LOGIC PANEL
29	11	13		"	"	"	REAR WATER PUMP
30	13	11		"	"	"	REAR ELECTRONIC TRANSMIT.
31	12	13		" N.C.	"	"	FRONT WATER PUMP
32	13	12		" N.O.	"	"	FRONT ELECTRONIC TRANSMIT.
33							
34	12	13		BOSH N.O.	"	ENG. JCT. BOX	A/C COMPRESSOR CLUTCH
35	12	13		"	"	"	COND. FAN SOL. VALVE
1A	1	22		"	12	FR. JCT. BOX	12V IGNITION -FR
2A	1	1		"	"	ENG. JCT. BOX	12V IGNITION -ENG
3A	1	22		"	"	CENT. JCT. BOX	12V IGNITION -CENT

RELAYS							
R#	DIAG. PAGE		AMP	CATEGORY	VOLT.	LOCATION	FUNCTION
	COIL	CONT.					
36	13	13		MAGNETIC	24	ENG. JCT. BOX	EVAP. FAN MOTOR -FR.
37	13	13		"	"	"	" " " -RR.
38	13	13		BOSH N.O.	"	FR. JCT. BOX	DEFROSTER CTR
39	8	8		"	"	"	DOOR AJAR
40	18	18		"	"	"	RR & FR DOOR SPEED SW CTR.
41	19	19		"	"	"	ANTI SKID CTR
42	19	19		"	"	"	" " "
43	19	19		"	"	"	" " "
44	19	7		BOSH N.O.	"	"	" " "
45	21	21		BOSH N.O.	"	"	KNEELING CTR
46	21	21		" N.C.	"	"	" "
47	21	21		" N.O.	12	ENG. JCT. BOX	ARTICULATION SW
48	6	6		BOSH N.O.	24	FR. JCT. BOX	DOOR AJAR IGNITION
49	23	23		"	12	"	RADIO & AMPLI.
50	23	23		"	"	"	" "
51	2	2		"	12	ENG. JCT. BOX	"KILL SW" CRUISE CTR
52							
53	7	7		"	12	CENT. JCT. BOX	BACK-UP LT
54	9	9		"	24	"	GENERAL LT (REAR SECTION)
55	9	9		"	24	"	24V FLUOR (REAR SECTION)
56	5	5		"	24	CENT. JCT. BOX	SIDE MARKER TAIL & LICENCE LT
57	1	1		"	"	ENG. JCT. BOX	VOLTAGE REGULATOR IGN
58	16	16		"	"	CENT. JCT. BOX	TOILET FLUORESCENT
59	5	6		"	"	FR. JCT. BOX	CORNERING LT RH
60	5	6		"	"	"	" " LH
61	5	5		"	"	"	" " CUT-OUT
62	5	7		"	"	"	MARKER LT-FR SECTION
63	5			"	"	CENT. JCT. BOX	EXIT LT
64	22	22		"	12	RR STEP LT	CAMERA DOOR SYST. - SERVICE
65	23	23		"	24	ENG. JCT. BOX	LUGGAGE DOOR LOCK -FR
66	23	23		"	"	"	" " " -FR
67	23	23		"	"	CENT. JCT. BOX	LH LUGGAGE DOOR LOCK-RR.
68	23	23		"	"	"	" " " " -"
69	23	23		"	"	"	RH LUGGAGE DOOR LOCK-RR.
70	23	23		"	"	"	" " " " -"
71	22	22		"	12	FR. JCT. BOX	BACK UP MONITOR
72							
73							

<b>LEGEND</b> 	FRONT JUNCTION PANEL REAR JUNCTION PANEL BATTERY COMPARTMENT CIRC. CIR. BREAKER HARNESS CONNECTOR	BATTERY JUNCTION BLOCK SINGLE CONNECTOR DIODE (RECTIFIER) OPTION	C 88-04 C.O. # 13803 B.C. B 88-02 LANCE D.T. A 87-05 CORR. PRELIMINAIRE P.C.	TITLE: RELAYS CODE DESS: P.C. DATE: 87-05 VER. APPR.
	ITEM DATE REVISION PAR APPL: EFF. W/J001 PRIOR TO J009 REF: H5-60 NO: D-060566 p. G C			

M

# RESISTOR CODE

RESISTOR							
RS #	VOLTAGE		WATT	CATEGORY	DING. PAGE	LOCATION	FUNCTION
	BEFORE	AFTER					
1	12		1/4	1.2K	2	B.J.M	E.C.M. DDEC
2	12		1/4	1.3K	2	"	" "
3	12		1/4	2.4K	2	"	" "
4	24		1/2	470 K	12	"	1/2 TIME DELAY RELAY.
5	12		10	F-101	6	B.J.A.	CORNERING LTS
6	12		10	F-101	7	B.J.A.R.	DOCKING LT-RH
7	12		10	F-101	7	B.J.A.R.	DOCKING LT-LH
8	12		10	F-101	4	FR. SERV. CPT.	FR. FOG-LH
9	12		10	F-101	4	FR. SERV. CPT.	FR. FOG-RH

RESISTOR							
RS #	VOLTAGE		WATT	CATEGORY	DING. PAGE	LOCATION	FUNCTION
	BEFORE	AFTER					

<b>LEGEND</b> FRONT JUNCTION PANEL REAR JUNCTION PANEL BATTERY COMPARTMENT CIRCUIT BREAKER HARNESS CONNECTOR	BATTERY JUNCTION BLOCK SINGLE CONNECTOR BOND (RECTIFIER) OPTION	<b>REV. HISTORY</b> C 88-04 C.D. #13883 B.C. B 88-02 LANCE DT A 87-05 CORR. PRELIMINAIRE PC. ITEM DATE REVISION PAR	TITRE:	DESS: P.C.	DATE- 87-05
			RESISTOR CODE	VER.-	APPR.-
APPL: EFF.W/JO01 PRIOR TO JO09			REF: HS-60	NO: D-060566	p.H C



# SWITCH CODE

SWITCH						
SW#	AMP.	VOLT.	DIAG. PAGE	LOCATION	DESCRIPTION	TYPE SYMBOL
1		24	1	B.J. P	CUT OUT SW 24V	
2		12	1	"	" " " 12V	
3		24	1	DASH	FAST IDLE SW	SWF
4		"	1	"	WEBASTO SW	"
5		12	2	"	STOP ENGINE OVERRIDE	"
6		12	2	"	CRUISE CTR ON/OFF	"
7		"	"	"	CRUISE "RESUME" SW	"
8		"	3	STEER CPT	ATEC TEST SW	
9		24	4	DASH	FOG LT	SWF
10		"	"	STEER WHEEL	HORN BUTTON	
11		24	5	DASH	HEAD LAMP	
12		"	"	STEER WHEEL	MULTI-FUNCTION LEVEL	
13		24	"	DASH	HAZARD SW	SWF
14		24	7	STEER CPT	STOP 'LT SW	
15		"	"	B.J MOT	ENG. CPT LT SW	
16		"	"	CPT MOT	" " " "	
17		"	8	CPT STEER	STEERING CPT LT SW	
18		"	7	LUG CPT	BAGGAGE COMPT SW	
19		"	9	DASH CONS. GA	GENERAL LTS SW AND 24V FLUOR. SW	SWF
20		"	9	" " "	READING LT SW (DRIVER'S)	SWF
21						
22		24	9	DASH CONS. GA	DRIVER'S LT SW	SWF
23		"	9	HAT RACK	READ LT SW (PASS)	IKI
24		"	10	DASH	RHEOSTAT	
25		"	"	DASH CONS. GA	PASS. & HOSTESS CHIME (DRIVER'S)	SWF
26		"	"	HAT RACK	PASS CHIME SW	
27		"	"	" "	HOSTESS CHIME SW	
28		"	11	DASH	FRESH AIR SW	SWF
29		"	"	"	A/C & HEAT SW	SWF
30		"	"	"	RHEOSTAT RR,CTR,T°	
31		"	12	"	RHEOSTAT FR,CTR,T°	
32						
33		"	13	"	RHEOSTAT - DRIV. HTR FAN	
34		"	13	"	" - DRIV. TEMP CTR	
35		"	14	"	REAR VIEW MIRROR ADJUSTING SW-LH	
36		"	14	"	REAR VIEW MIRROR ADJUSTING SW-RH	
37		"	14	"	HEATED MIRROR SW	SWF

SWITCH						
SW#	AMP.	VOLT.	DIAG. PAGE	LOCATION	DESCRIPTION	TYPE SYMBOL
38		24	14	DASH	DRIVER'S LIFTER WINDOW	SWF
39		"	16	TOILET	TOILET DOOR LOCK SW	
40		"	"	"	FLUSHING SW	
41		"	"	"	TOILET EMERGENCY SW	
42		"	"	"	DIFFERENTIAL LOCK SW	
43		"	3	CPT MOT	RETARDER SW	
44		"	17	DASH	UPPER DEFROSTER	SWF
45		"	"	"	UPPER WINDSHIELD WIPER MOTOR CTR SW	
46		"	"	"	UPPER WINDSHIELD WASHER CTR SW	SWF
47		"	18	"	RR & FR DOOR CTR SW	SWF
48						
49		24	18	FR DOOR	FR DOOR CTR - DOOR PIVOT	
50		"	"	RR DOOR	RR DOOR CTR - DOOR PIVOT	
51		24	21	DASH	ETHER SW	SWF
52		24	"	"	KNEELING	SWF
53		"	"	ARTICULATION	ARTICULATION-TELL-TALE	
54		"	"	"	" - ALARM	
55		"	"	"	" - PARK	
56		"	"	"	" - VERTALARM	
57		"	22	DASH	ARTICULATION BRAKE	SWF
58		"	"	"	SEAT HEATER	SWF
59		"	23	"	LUGGAGE DOOR LOCK SW	"
60		"	"	LUG. CPT	LUGGAGE LOCK SW	HANDBRAKE CUTLER HAMMER
61		"	23	DASH	SPEAKER CTR SW	
62		"	"	"	RHEOSTAT P.A. VOLUME	
63			7	CPT STEERING	PARKING TTLT SW	
64		12	2	DASH	CRUISE "SET" SW	SWF
65		12	2	"	CRUISE "KILL" SW	
66		24	22	RR STEP CPT	CAMERA DOOR SYST.	JOG
67						
68						

**LEGEND**

	FRONT JUNCTION PANEL		BATTERY JUNCTION BLOCK
	REAR JUNCTION PANEL		SINGLE CONNECTOR
	BATTERY COMPARTMENT		DIODE (RECTIFIER)
	CIRCUIT BREAKER		OPTION
	HARNESS CONNECTOR		

C	88-04	CD. 13883	B.C.
B	88-02	LANCE	DT
A	87-05	CORR. PRELIMINAIRE	RC.
ITEM	DATE	REVISION	PAR

TITRE: SWITCH CODE

DESS: P.C. DATE: 87-05

VER.- APPR.-

APPL: EFF. W/JO01 PRIOR TO JO09 REF: H5-60

NO: D-060566 p.I C







# WIRING DIAGRAM CODE H5-60

			BATTERY		CIRCUIT BREAKER		
			GROUND		FUSE		
			METER GAUGE		DIODE		
			MOMENTARY CONTACT PUSH BUTTON SWITCH		JUNCTION TERMINAL BLOCK		
			BUZZER		THERMOSTAT		
			SOLENOID		PUMP		
			BELL		LIGHT		
			VALVE		FLASHER		
			HEATER				
			MAGNETIC SWITCH RELAY N.O.				
			MINI-RELAY N.O.				
			MINI-RELAY N.O. (87) AND N.C. (87A)				
			MINI-RELAY N.C.				
			WIRES CROSSING				
			WIRES WELDING				
	CONNECTOR SOCKET PIN						

<small>REVISIONS</small> 1. 88-02 VOIR C.D. 13386 2. 88-02 LANCE 3. 87-04 CORR. PRELIMINAIRE	<small>REVISIONS</small> 1. 88-02 VOIR C.D. 13386 2. 88-02 LANCE 3. 87-04 CORR. PRELIMINAIRE	TITRE:	WIRING DIAGRAM H5-60	DESS: P.C.	DATE: 87-04
		APPL: EFF. W/3001 PRIOR TO J009	REF: H5-60	VER.:	APPR.:
ITEM DATE	REVISION	PAR		NO: D-060566-p. K	C

# WIRING DIAGRAM INDEX H5-60

A/C AND HEAT SYSTEM	PAGE	11,12,13	INTERIOR LIGHTING	PAGE	7,8,9,10
AIR DRYER	P.	22	KNEELING	P.	21
ALARM AND SIGNAL	P.	4	LOWER WINDSHIELD (WIPER & WASHER)	P.	17
ANTI-SKID	P.	19,20	LUGGAGE DOOR LOCK	P.	23
ARTICULATION BRAKE	P.	22	MOTOR HEATER	P.	23
ARTICULATION SWITCH	P.	21	PASSENGER CHIME	P.	10
BACK UP MONITOR	P.	22	QUICK START	P.	21
CHARGING SYSTEM	P.	1	REAR VIEW MIRROR	P.	14
CIGAR LIGHTER	P.	14	RETARDER	P.	3
CRUISE CONTROL	P.	2	SOUND SYSTEM	P.	24
DIFFERENTIAL LOCK	P.	16	TACHOGRAPHE	P.	16
DIGITAL THERMOMETER	P.	23	TOILET	P.	16
DRIVER'S SEAT HEATER	P.	22	UPPER WINDSHIELD DEFROST	P.	17
DRIVER'S WINDOW	P.	14	UPPER WINDSHIELD (WIPER & WASHER)	P.	17
ENGINE CONTROL	P.	1	WATER TANK HEATER	P.	23
ENTRANCE DOOR CONTROL (FRONT & REAR)	P.	18	LOW FUEL	P.	16
EXTERIOR LIGHTING	P.	4,5,6,7	FRONT DESTINATION SIGN.	P.	15
HEATED MIRROR	P.	14	STORE	P.	15
HOSTESS CHIME	P.	10	RACOR FUEL FILTER	P.	21

<b>PREVOST</b>	<b>LEGEND</b>	<small>CE DOCUMENT EST LA PROPRIETE EXCLUSIVE DE PREVOST CAR INC. ...</small>	TITRE:	DESS: P.C.	DATE- 87-04
<div style="display: flex; flex-direction: column; gap: 5px;"> <div><input type="checkbox"/> FRONT JUNCTION PANEL</div> <div><input type="checkbox"/> REAR JUNCTION PANEL</div> <div><input type="checkbox"/> BATTERY COMPARTMENT</div> <div><input type="checkbox"/> CIRCUIT BREAKER</div> <div><input type="checkbox"/> HARNESS CONNECTOR</div> </div>	<div style="display: flex; flex-direction: column; gap: 5px;"> <div><input type="checkbox"/> BATTERY JUNCTION BLOCK</div> <div><input type="checkbox"/> SINGLE CONNECTOR</div> <div><input type="checkbox"/> DIODE (RECTIFIER)</div> <div><input type="checkbox"/> OPTION</div> </div>	<small>THIS DOCUMENT IS THE EXCLUSIVE PROPERTY OF PREVOST CAR INC. ...</small>	<b>WIRING DIAGRAM H5-60</b>	VER.-	APPR.-
		B 88-02 LANCE	DT		
		A 87-04 CORR. PRELIMINAIRE	RC.		
		ITEM DATE REVISION	PAR		
			APPL: EFF. W/J001 PRIOR TO J008	REF: H5-60	NO: D-060566 p.L
					C

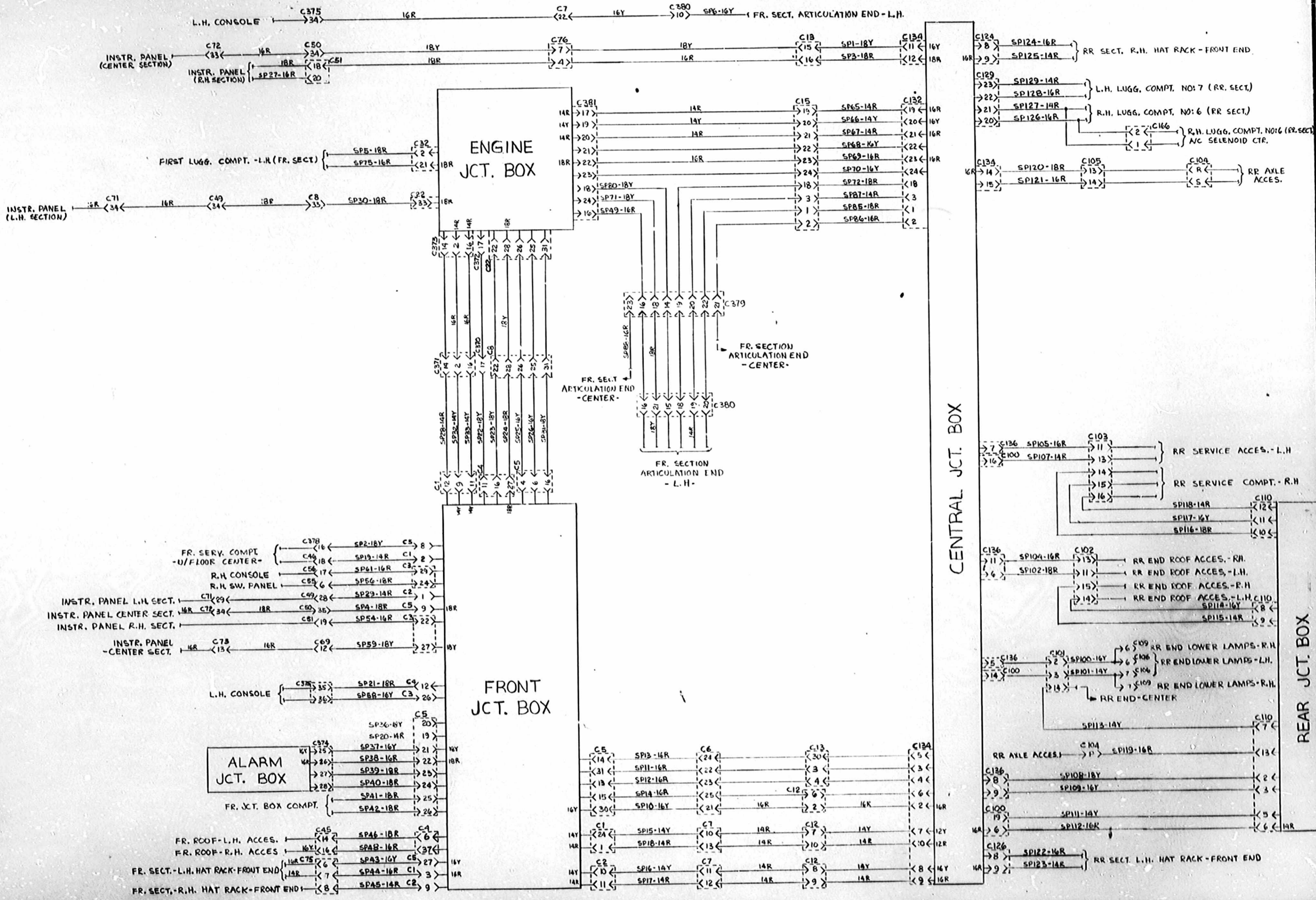

DESCRIPTION: SPARE WIRES

DR. - M.J. DATE - 88/05/30

CK. - KC APPR. - [Signature]

APPL: EFF. W/ J001 PRIOR TO J009 REF: NO: D-060566 P.M. C

ITEM	DATE	REVISION	BY



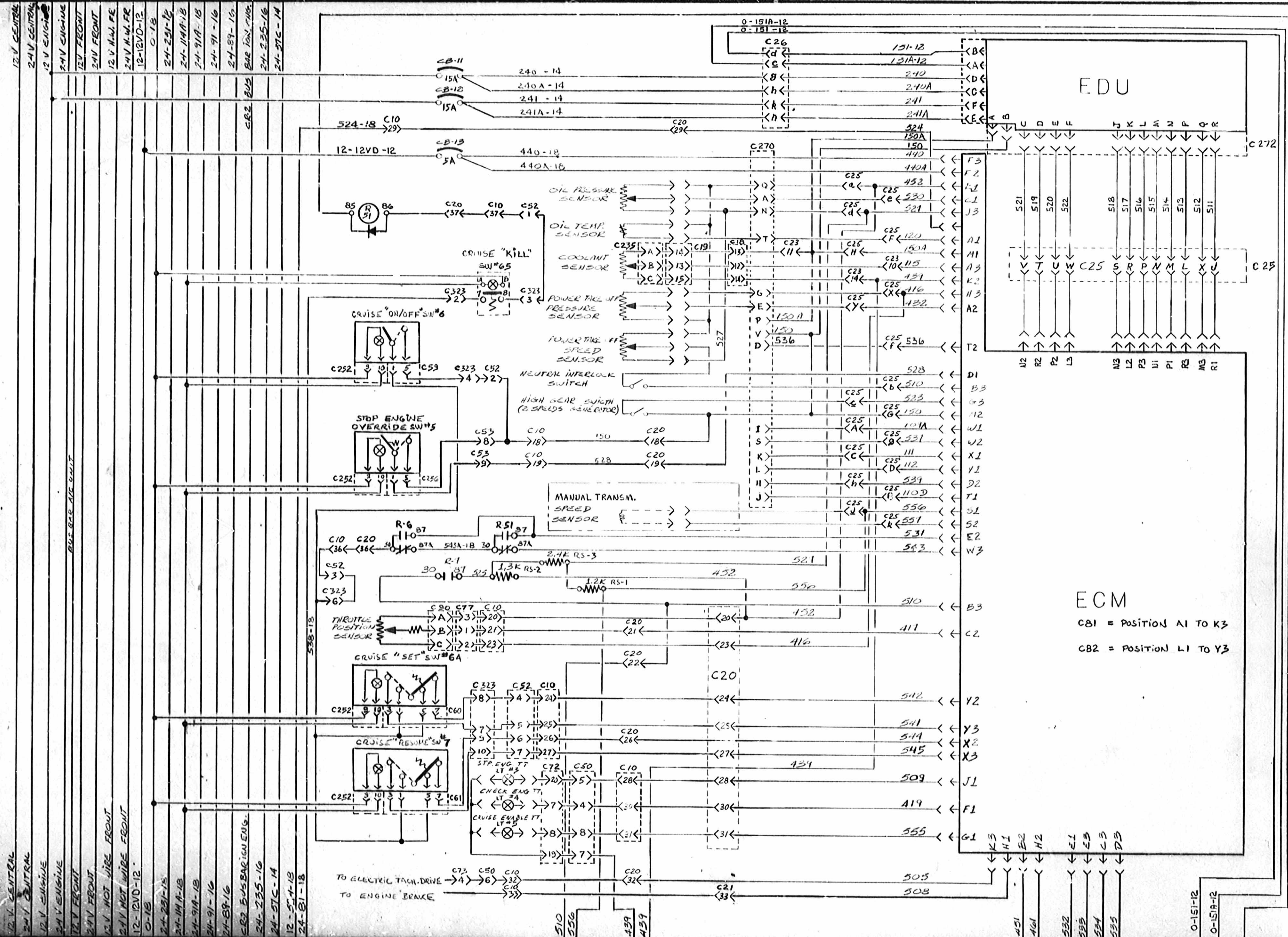

DDEC I

D	88-05	MISE A JOUR	B.C	TITRE:	DESS:	A. B.	DATE:	86-09	
C	87-12	LANCÉ	AB	WIRING DIAGRAM H5-60	VER.-		APPR.-		
B	87-04	CORR. PRELIMINAIRE	PC.		APPL:	H5-60	REF:		
A	87-02	CORR. PRELIMINAIRE	KC.		VEH EFF:	J001			
ITEM	DATE	REVISION	PAR		PRIOR TO	J003			
							NO:	D-060566 2/24	C

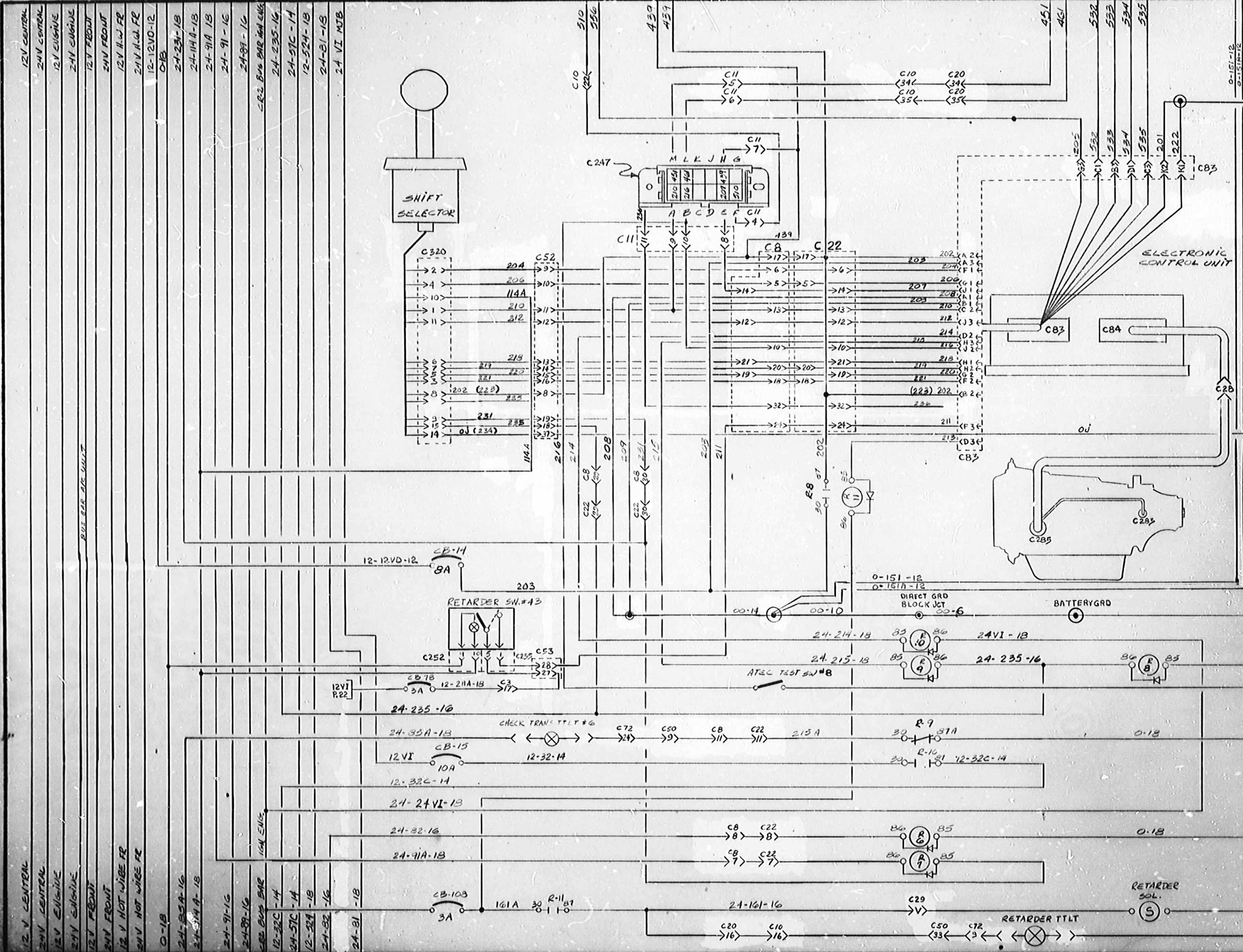

A.T.E.C.  
ELECTRONIC  
TRANSMISSION

RETARDER

- 12V CENTRAL
- 24V CENTRAL
- 12V ENGINE
- 24V ENGINE
- 12V FRONT
- 24V FRONT
- 12V HOT WIRE FR
- 24V HOT WIRE FR
- 0-18
- 24-231-18
- 24-114A-18
- 24-91A-18
- 24-91-16
- 24-89-16
- CR-2 BUS BAR AND CABLE
- 24-235-16
- 24-57C-14
- 12-524-18
- 24-81-18
- 24 VI MTB

ITEM	DATE	REVISION	PAR
D	88-06	MISE A JOUR	M.A.
C	88-05	MISE A JOUR	B.C.
B	87-12	LANCÉ	A.P.
A	87-04	CORR. PRELIMINAIRE	P.C.

TITRE: **WIRING DIAGRAM H5-60**

APPL: H5-60

VEN EFF JOOI  
PRIOR TO JOOG

REF:

DESS: A.B.	DATE: 86.09
VER.-	APPR.-
NO: D-060566	3/24 C



12V CENTRAL  
24V CENTRAL  
12V ENGINE  
24V ENGINE  
12V FRONT  
24V FRONT

12V CENTRAL  
24V CENTRAL  
12V ENGINE  
24V ENGINE  
12V FRONT  
24V FRONT  
12V NOT WIRE FRONT  
24V NOT WIRE FRONT

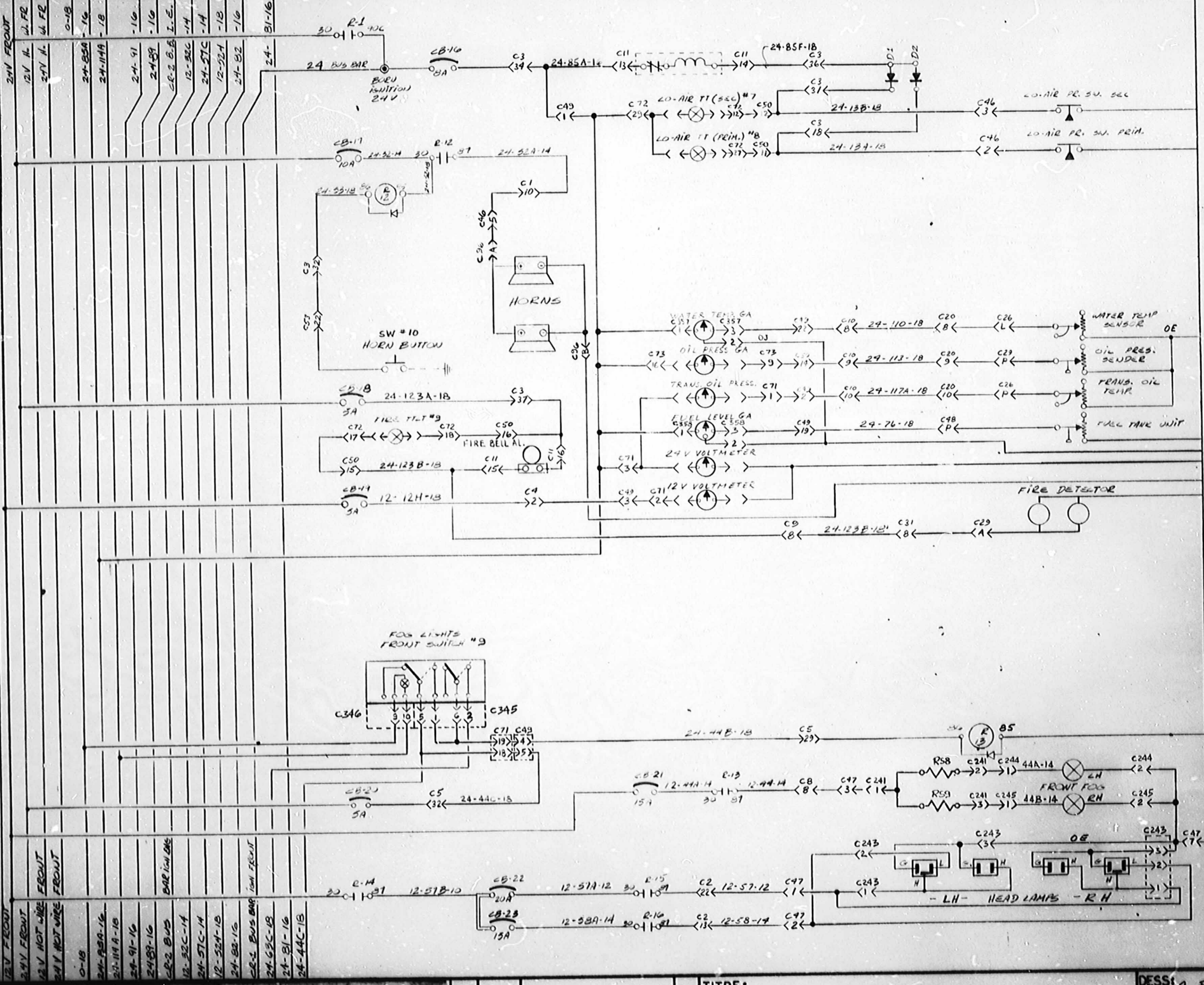

ALARM & SIGNAL

EXTERIOR LIGHTING

ITEM	DATE	REVISION	PAR
C	88-06	MISE A JOUR	MJ
B	87-12	LANCÉ	AB
A	87-04	CORR. PRELIMINAIRE	RC

TITRE: WIRING DIAGRAM H5-60  
 APPL: H5-60 VEIL EFF. J001 PRIOR TO J009 REF:

DESS: A.B. DATE: 86-09  
 VER: APPR:  
 NO: D-060568

24

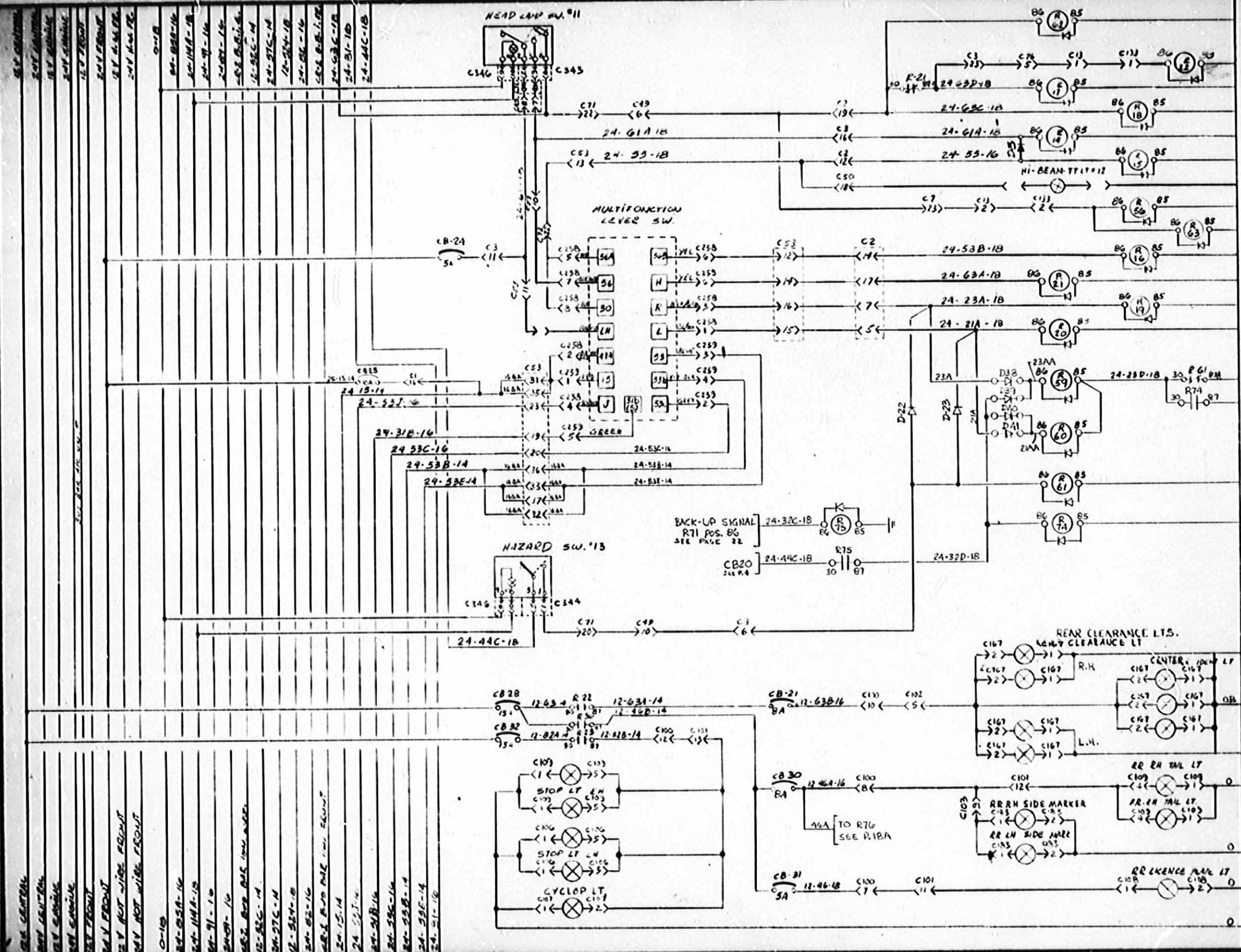

EXTERIOR LIGHTING

2554

TITLE: WIRING DIAGRAM H5-60			DESS: M	DATE: 87-09
APPL: H5-60			VER:	APPR:
90/11	FIL 46A (TOR 76 ROUTE)	M/	REF: H5-60 "SPECIAL" VOYAGEUR	
83/09	LANCE OC 2, 87162	M/	NO: D-060566 EN/29 C	
ITEM DATE	REVISION	PAR	VEN. EFF. J001 PRIOR TO J099	



M

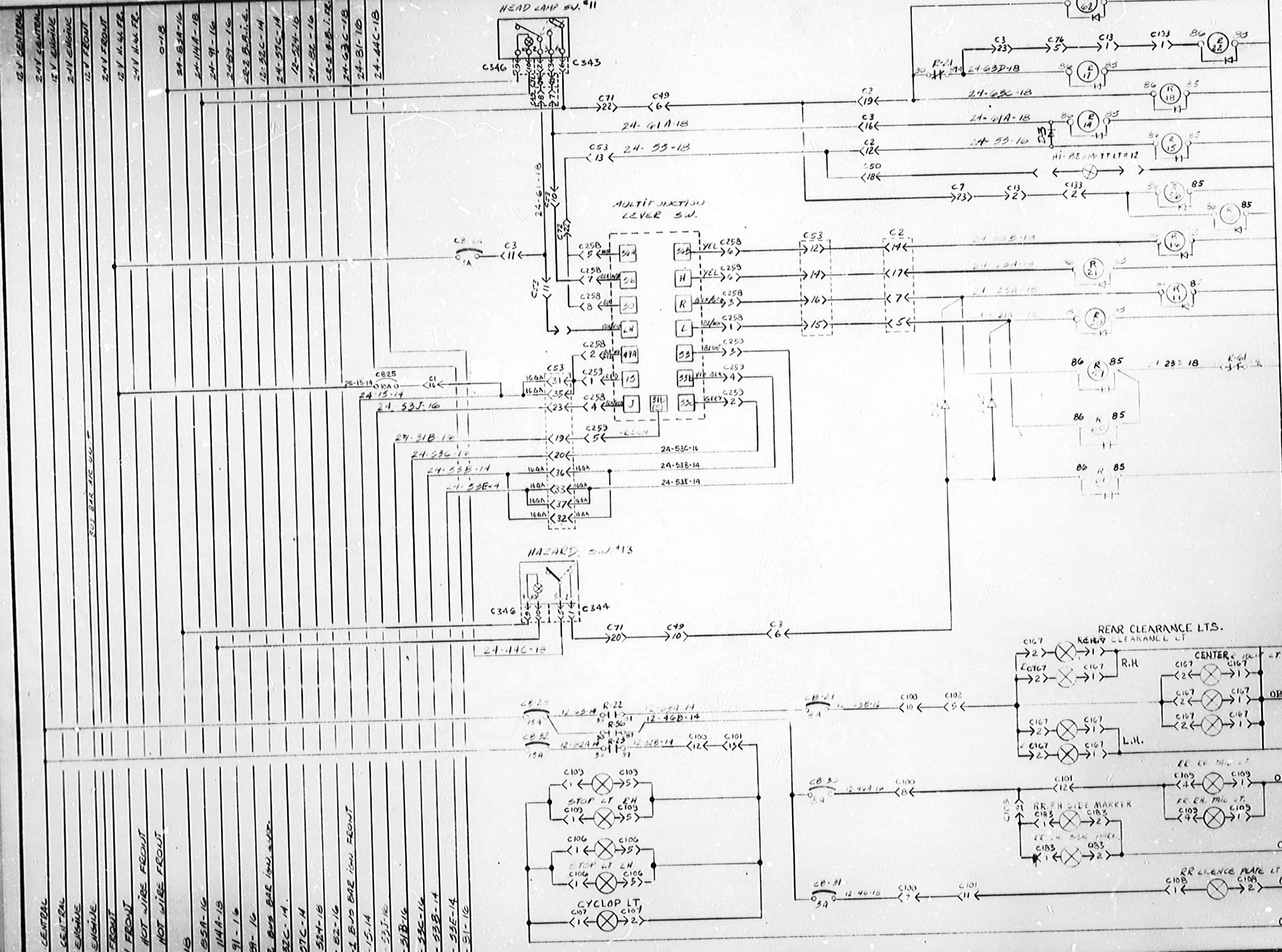

EXTERIOR LIGHTING

ITEM	DATE	REVISION	PAR	TITRE:	APPL:	VEH. EFF.	REF:	DESS:	DATE
D	88-06	MISE A JOUR	M1	WIRING DIAGRAM H5-60	H5-60	J001	PRIOR TO J009	A. B.	86-09
C	88-02	C.D. # 13311	B.C.					VER.-	APPR.-
B	87-12	LANCÉ	AB						
A	87-04	CORR. PRELIMINAIRE	PC.						
								NO: D-060566	5/24 C

**LEGEND**

- STOP LIGHT
- TAILLIGHT
- TURN SIGNAL
- HAZARD LIGHT
- RELAY
- FUSE
- SWITCH
- WIRE HARNESS
- GROUND

12V CENTRAL	12V CENTRAL
24V CENTRAL	24V CENTRAL
12V ENGINE	12V ENGINE
24V ENGINE	24V ENGINE
12V FRONT	12V FRONT
24V FRONT	24V FRONT
12V HOT WIRE FRONT	12V HOT WIRE FRONT
24V HOT WIRE FRONT	24V HOT WIRE FRONT
0-18	0-18
24-85A-16	24-85A-16
24-114A-13	24-114A-13
24-91-16	24-91-16
24-89-16	24-89-16
CR-2 BUS BAR IGN ENG	CR-2 BUS BAR IGN ENG
12-32C-14	12-32C-14
24-57C-14	24-57C-14
12-524-18	12-524-18
24-82-16	24-82-16
CR-1 BUS BAR IGN FE	CR-1 BUS BAR IGN FE
24-15-14	24-15-14
24-53J-16	24-53J-16
24-51B-16	24-51B-16
24-53C-16	24-53C-16
24-53B-14	24-53B-14
24-53E-14	24-53E-14
24-81-16	24-81-16

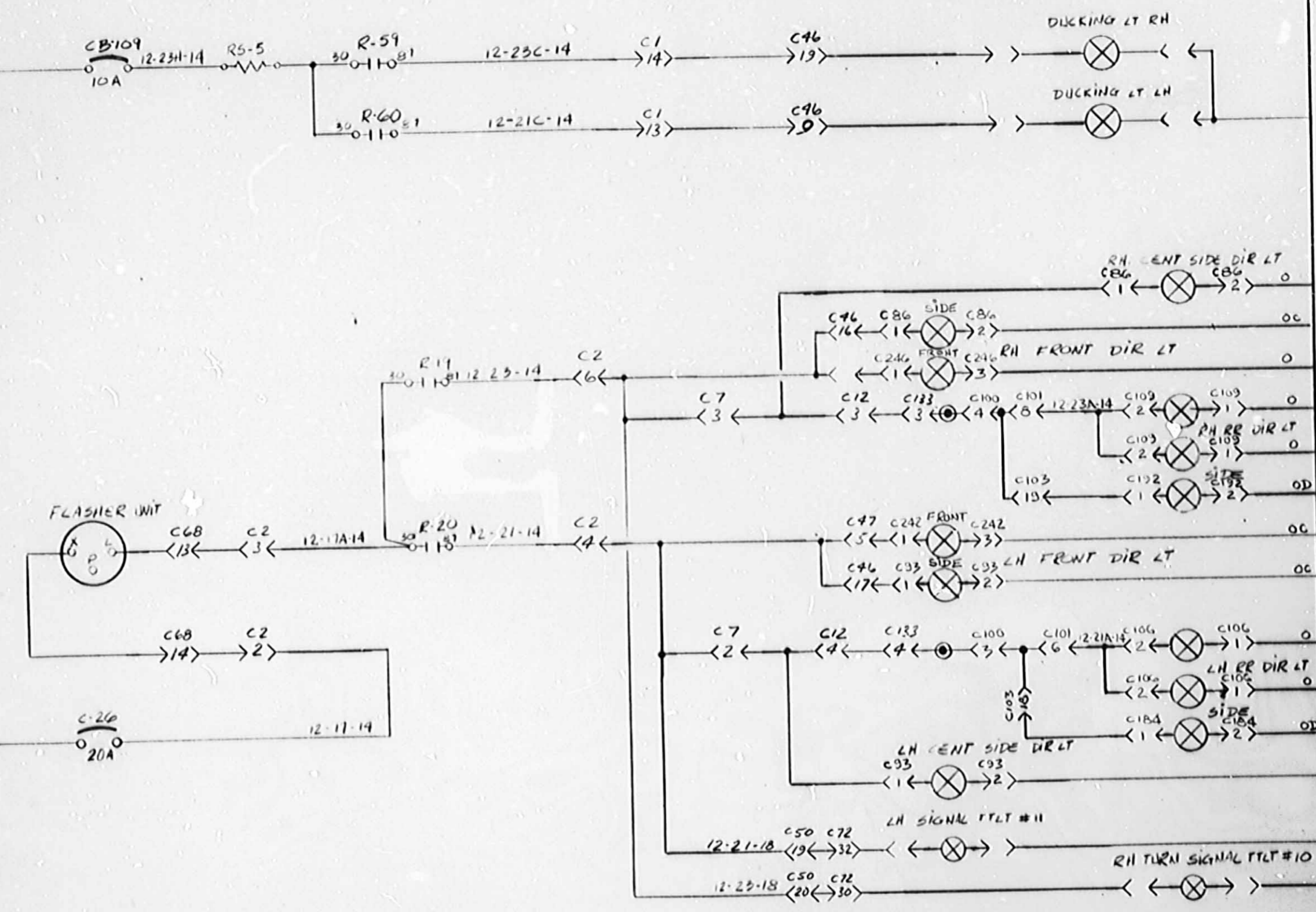

EXTERIOR LIGHTING

FRONT JUNCTION PANEL
REAR JUNCTION PANEL
BATTERY COMPARTMENT
CIRCUIT BREAKER
MARKED CONNECTOR

BATTERY JUNCTION BLOCK
SINGLE CONNECTOR
BASE (RECTIFIER)
OPTION

ITEM	DATE	REVISION	PAR
B	88-09	C.D. 13883	BC
A	87-12	LANCE	AB

TITRE: WIRING DIAGRAM H5-60  
 APPL: H5-60  
 VEH. EFF. 3001 PRIOR TO 3009  
 REF:

DESS: AB  
 VER: -  
 DATE: 87-12  
 APPR: -  
 NO: D-060566 4/24

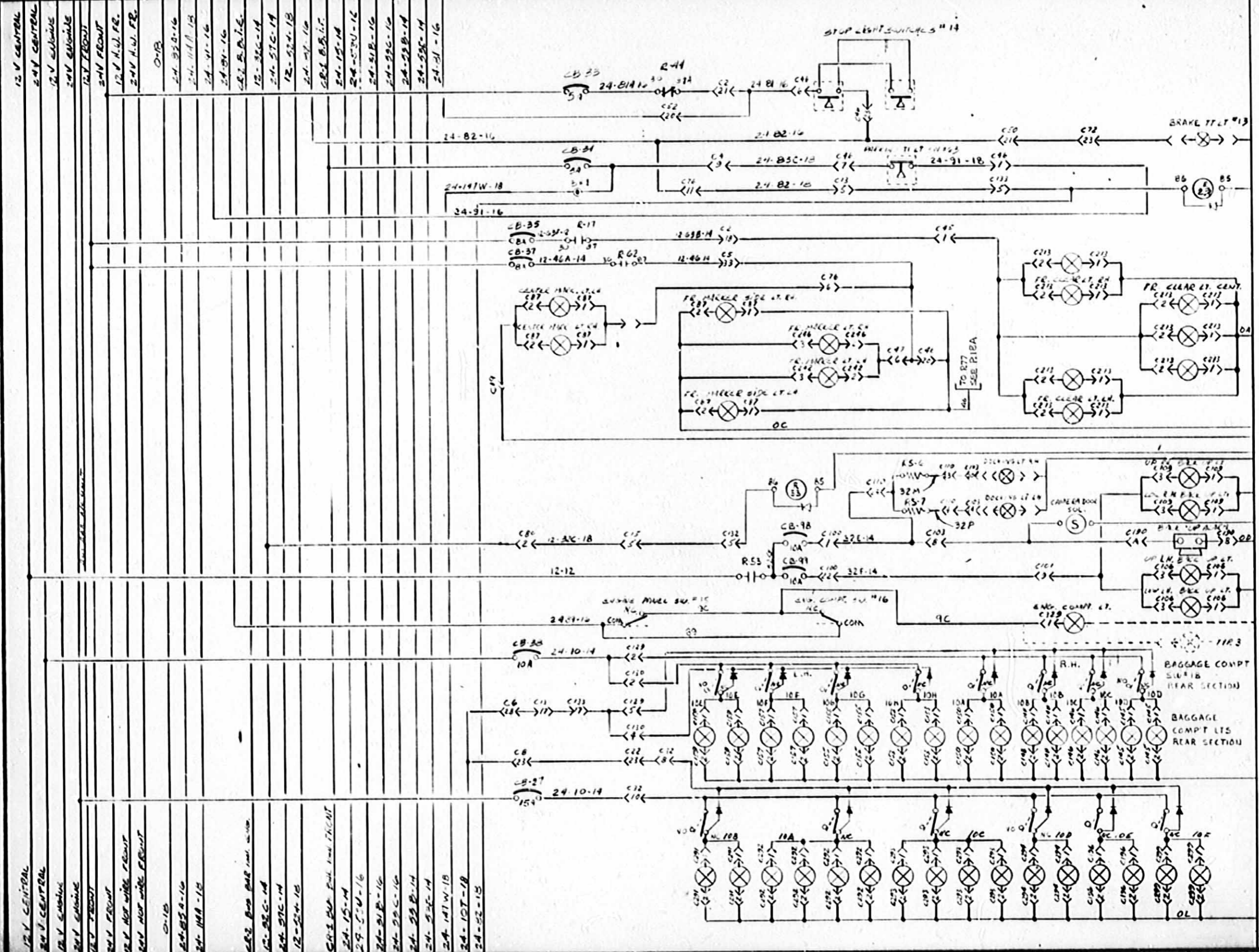

EXTERIOR LIGHTING

INTERIOR LIGHTING

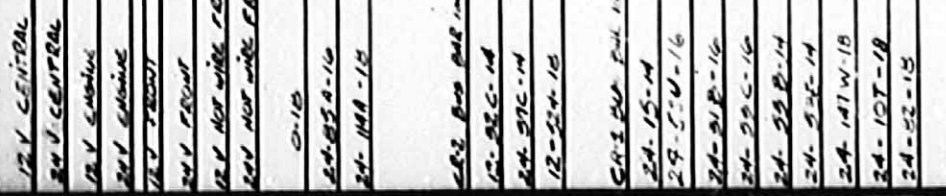

E	90-11	FIL 46 (TO RTJ ADJUTE)	MZ
D	88-05	CB27 ETAT 10A	MZ
C	88-02	CO. # 13311	B.C.
B	87-12	LANCÉ	AD
A	87-04	CORR. PRELIMINAIRE	PC.
ITEM	DATE	REVISION	PAR

TITRE: WIRING DIAGRAM H5-60

APPL: H5-60 VEH EFF. J001 PRIOR TO J003

REF:

DESS: A.B. DATE: 86-09

VER: APPR:

NO: D-060566 1/24 C



12V CENTRAL	CR-2 B.B.I.E.
24V CENTRAL	12-32C-14
12V ENGINE	24-57C-14
24V ENGINE	12-524-18
12V FRONT	CR-1 B.B.I.E.
24V FRONT	24-15-14
12V H.W. FR.	24-53J-16
24V H.W. FR.	24-31B-16
0-18	24-53C-16
24-95A-16	24-53B-14
24-14A-18	24-53E-14
	24-147W-18
	24-10T-18
	24-82-18
12V CENTRAL	CR-2 BUS BAR IGN. ENG.
24V CENTRAL	24-15-14
12V ENGINE	24-53J-16
24V ENGINE	24-31B-16
12V FRONT	24-53C-16
24V FRONT	24-53B-14
12V HOT WIRE FRONT	24-53E-14
24V HOT WIRE FRONT	24-147W-18
0-18	24-82-18
24-95A-16	
24-14A-18	
CR-2 BUS BAR IGN. ENG.	
12-32C-14	
24-57C-14	
12-524-18	
CR-1 BUS BAR IGN. FRONT	
24-15-14	
24-53J-16	
24-31B-16	
24-53C-16	
24-53B-14	
24-53E-14	
24-147W-18	
24-82-18	

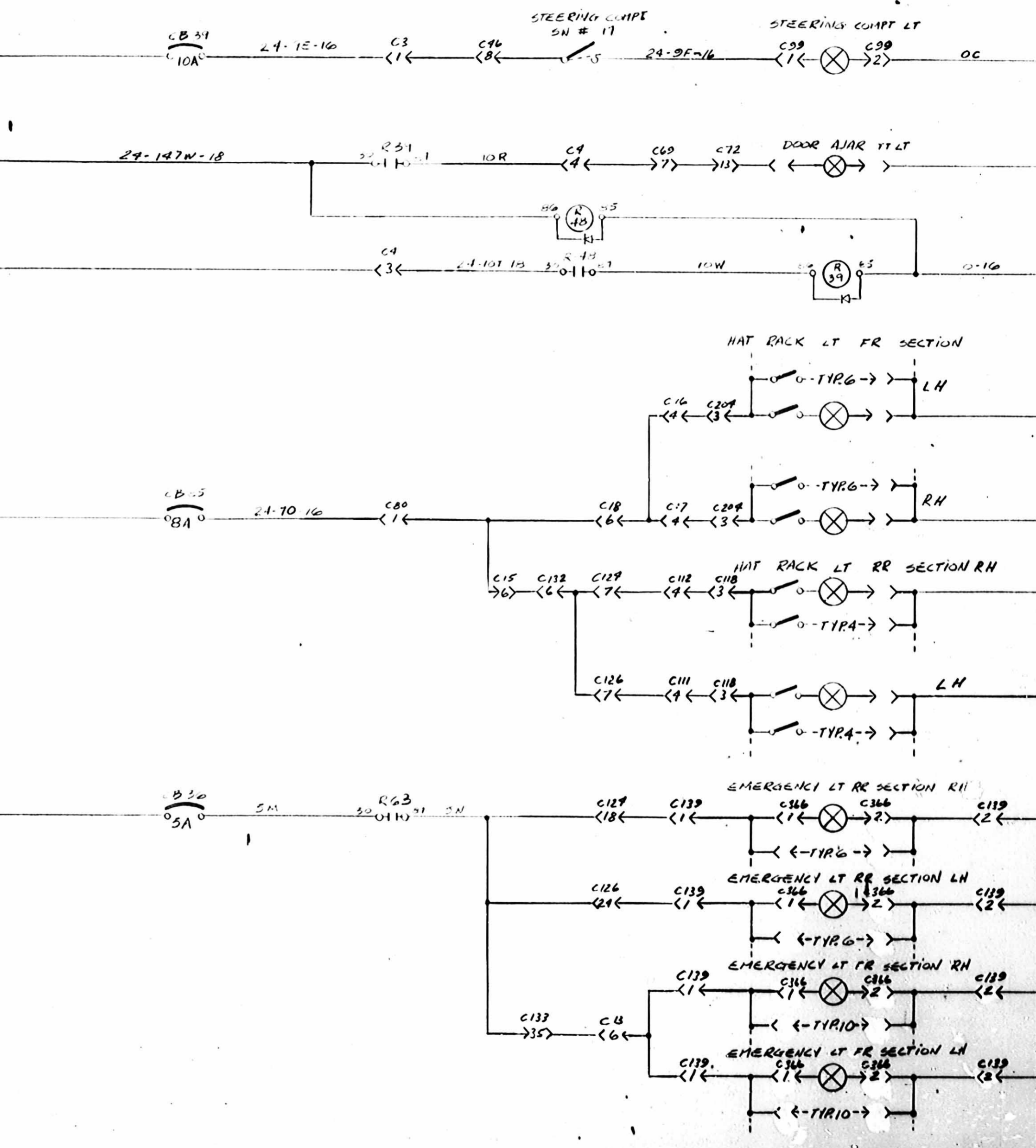

INTERIOR LIGHTING

LEGEND			
	BATTERY JUNCTION BLOCK		
	SHIELD CONNECTION		
	CHISEL (GUSTAFER) OPTION		
	REVISION		

ITEM	DATE	REVISION	PAR
C	88-05	C885 ETAT SA	MA
B	88-02	C.D. 13311	B.C.
A	87-12	LANCER	AB

TITRE: **WIRING DIAGRAM H5-60**

APPL: 115-60 VEH. EFF. 3001 PRIOR TO 3003 REF:

DESS: AB	DATE: 87-12-09
VER: -	APPR: -
NO: D-060566.8/4	C

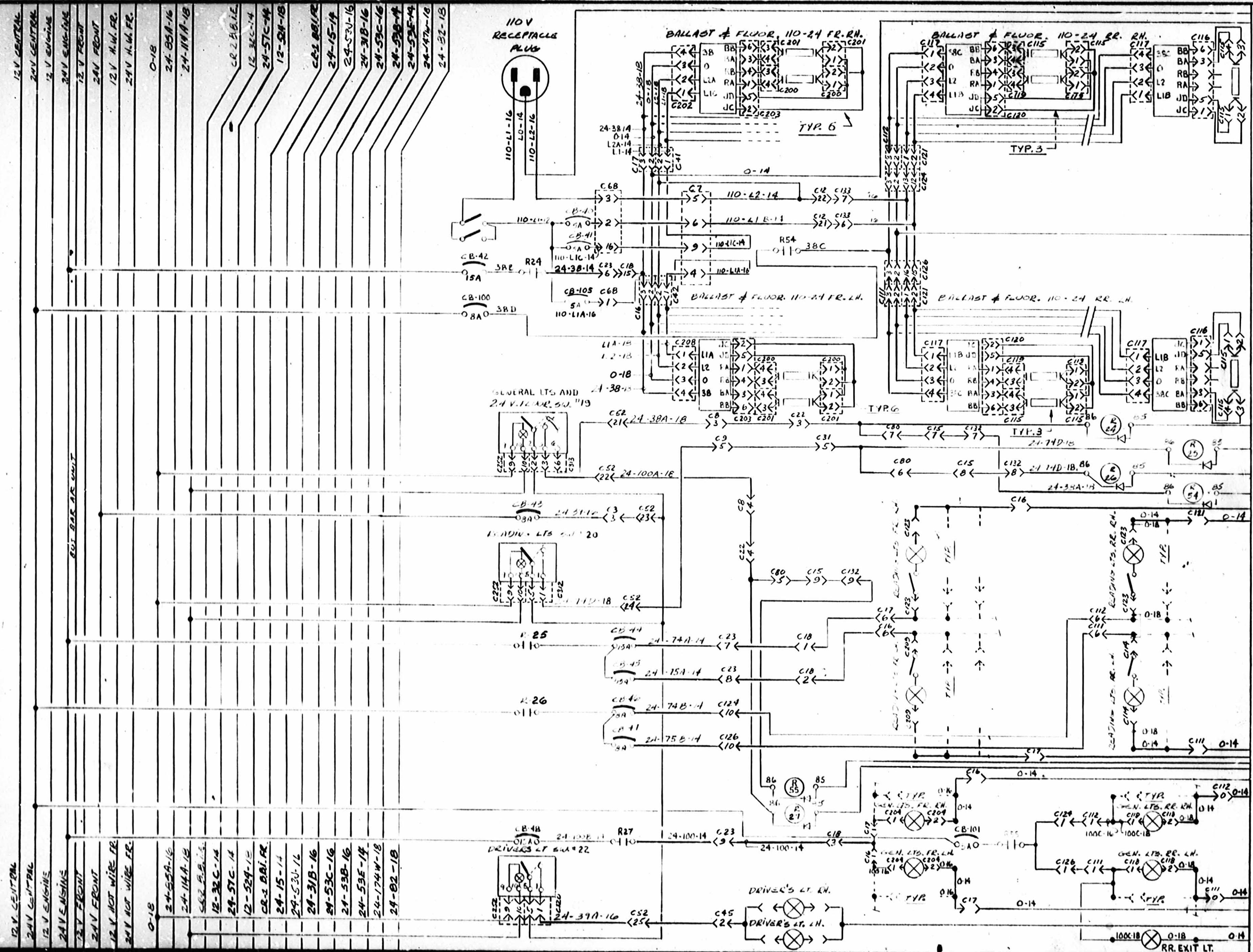

INTERIOR LIGHTING

**LEGEND**

12V CENTRAL  
24V CENTRAL  
12V ENGINE  
24V ENGINE  
12V FRONT  
24V FRONT  
12V HOT WIRE FR.  
24V HOT WIRE FR.

0-18  
24-55A-16  
24-11A-18  
24-32C-14  
24-57C-14  
12-52A-18  
24-15-14  
24-31B-16  
24-53C-16  
24-53B-16  
24-53E-14  
24-174W-18  
24-02-18

DRIVER'S LT. LH.  
DRIVER'S LT. RH.  
RR. EXIT LT.

O	88-04	C.D. #13883	B.C	TITRE:
C	88-02	C.D. #13311	B.C	
B	87-12	LINK	AB	
A	87-04	CORR. PRELIMINAIRE	PC.	
ITEM	DATE	REVISION	PAR	

APPL: H5-60		VEN. EFF. J001	REF:	NO: D-060566 9/24
VEH. EFF. PRIOR TO J009		DATE: 86-09		C
WIRING DIAGRAM H5-60		DESS: A.B.		APPR.:
VER.:		APPR.:		



12V CENTRAL	0-13
24V CENTRAL	24-25A-16
12V ENGINE	24-11A-10
24V ENGINE	24-11A-10
12V FRONT	12-22C-14
24V FRONT	24-57C-14
12V HOT WIRE FRONT	12-52A-18
24V HOT WIRE FRONT	24-52A-18
12V N.W. FE	24-15-14
24V N.W. FE	24-53U-16
	24-31B-16
	24-59C-16
	24-59B-16
	24-53E-14
	24-147W-18
	24-82-18

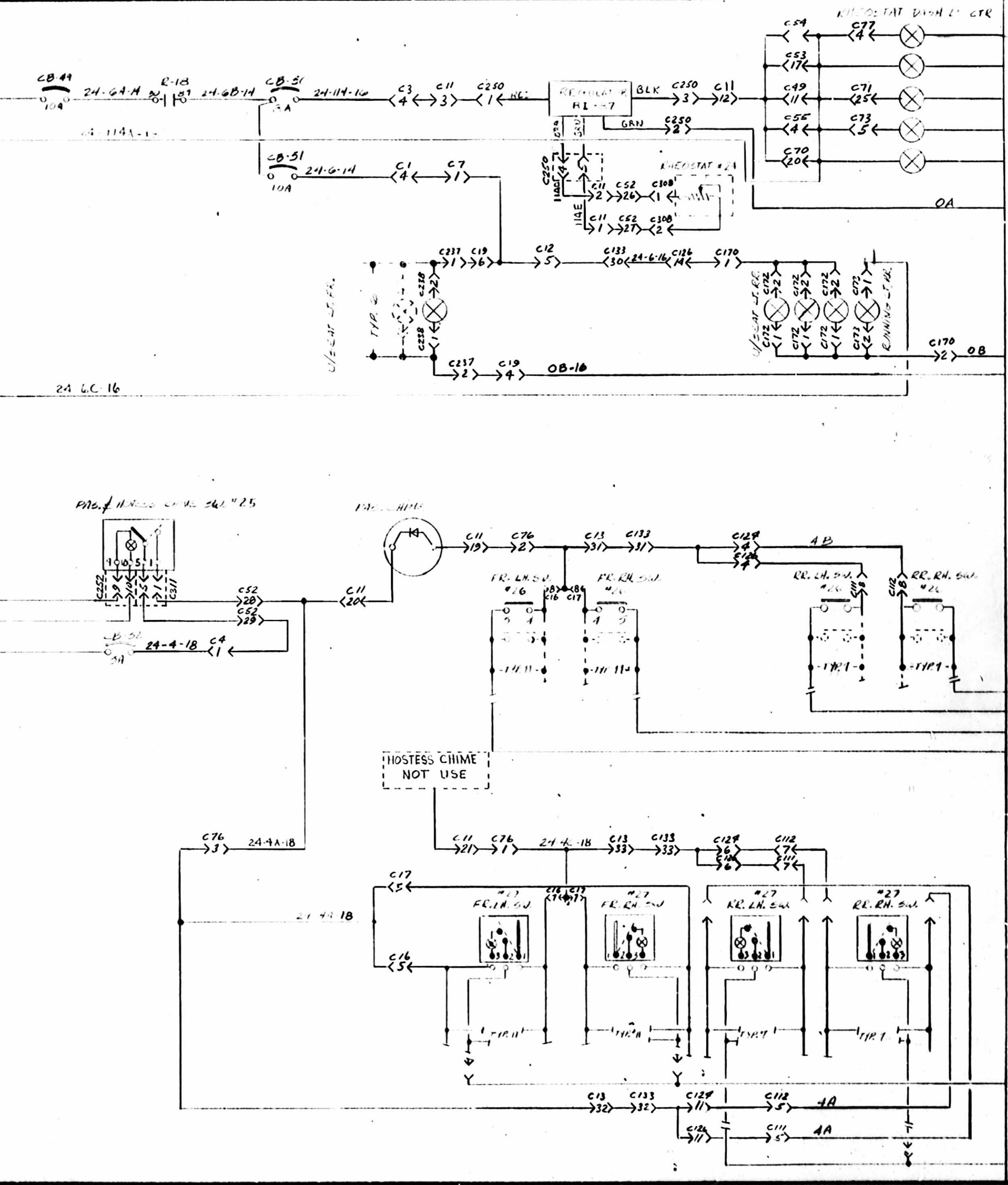

INTERIOR LIGHTING

PASSENGER CHIME

HOSTESS CHIME

LEGEND

	SWITCH
	LAMP
	RELAY
	FUSE
	TERMINAL
	GROUND

D	88-04	C.D. # 13683	BC	TITRE:
C	88-02	C.D. # 13311	B.C	
B	87-12	LANCÉ	AB	
A	87-04	CORR. PRELIMINAIRE	RC	
TEM	DATE	REVISION	PAR	

BC	TITRE:
B.C	
AB	
RC	
PAR	

APPL:	H 5-60	VER. EFF. J001	REF:
		PRIN. TO J009	

DESS:	A. B.	DATE:	86-09
VER.:		APPR.:	
NO:	D-060566 1/24		C

WIRING DIAGRAM H5-60



12V CENTRAL	24V CENTRAL	12V ENGINE	24V ENGINE	24V FRONT	24V REAR	24V WIRE	24V WIRE	0-10	24-55A-16	24-114A-18	CR2-BA-16	12-82C-14	24-57C-14	12-55A-18	24-15-14	24-53-16	24-51B-16	24-53C-14	24-53B-14	24-53E-14	24-147A-18	24-6C-16	24-67A-16	24-31F-18	24-2-18	24-21A-18	24-91G-12	24-67H-18	24-82-15	24-67A-16
-------------	-------------	------------	------------	-----------	----------	----------	----------	------	-----------	------------	-----------	-----------	-----------	-----------	----------	----------	-----------	-----------	-----------	-----------	------------	----------	-----------	-----------	---------	-----------	-----------	-----------	----------	-----------

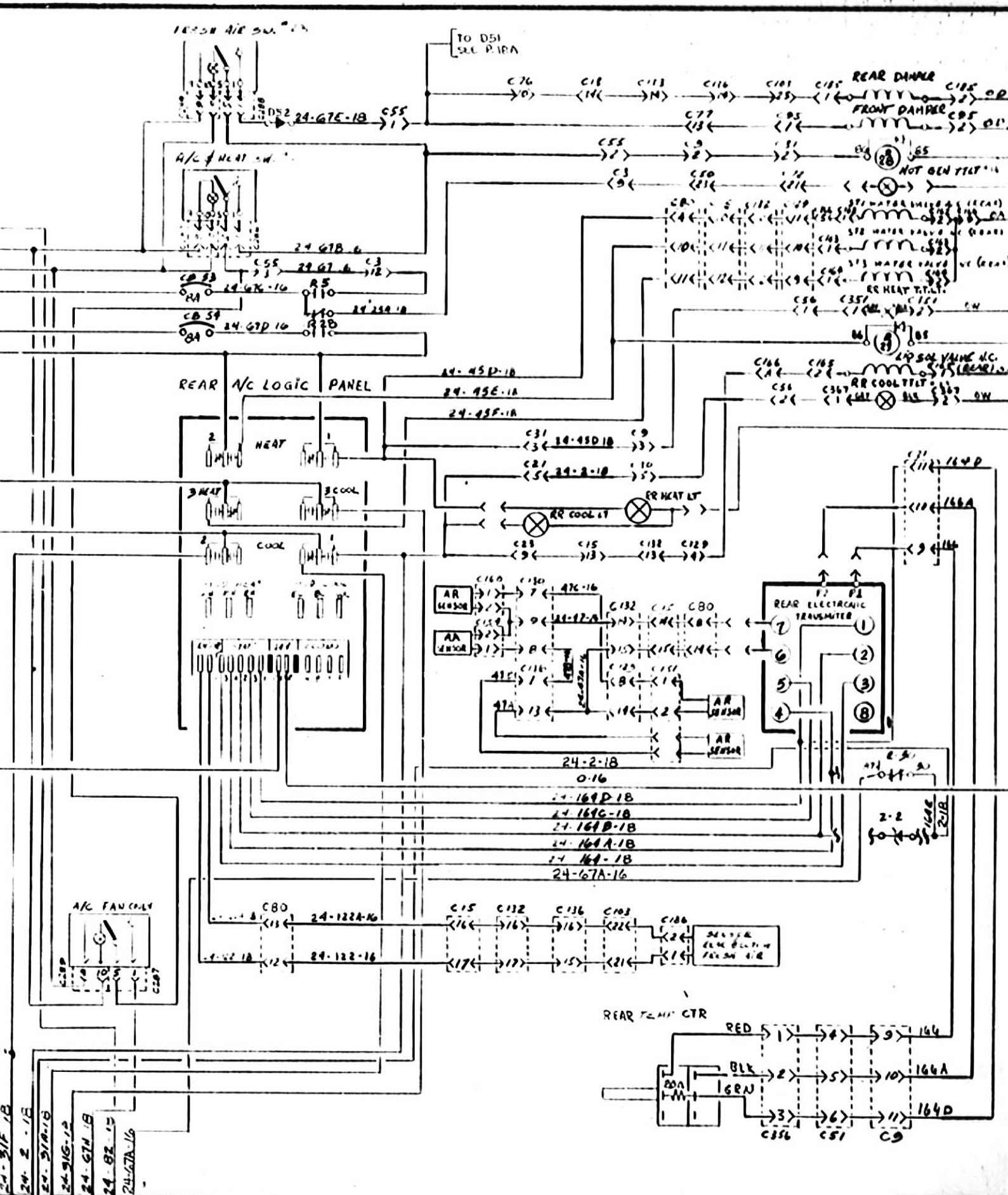

A/C & HEAT SYSTEM

TITLE:	WIRING DIAGRAM H5-60		DESS:	S.B.	DATE:	89/11	
VER:	1/C		APP:	11/24			
APPL:	H5-60	VEH. EFF.:	J001	PRG. TO:	J009	REF:	SPECIAL VOYAGEUR RETROFIT
NO:	D-060566		11/24 C				

ITEM	DATE	REVISION	PAR
A	89/11	LANCE	S.B.

0-18
24-25A-16
24-114A-18
C8-2 B.S.C.
12-32C-14
24-57E-14
12-52A-18
C8-3 B.S.C. I.R.
24-15-14
24-53J-16
24-31B-16
24-53C-16
24-53B-14
24-53E-14
24-147W-18
24-6C-16
24-32-18

0-18
24-25A-16
24-114A-18
C8-2 B.S.C. I.R. I.M.T. C.M.T.
12-32C-14
24-57E-14
12-52A-18
C8-3 B.S.C. I.R. I.M.T. C.M.T.
24-15-14
24-53J-16
24-31E-16
24-53C-16
24-53B-14
24-53E-14
24-147W-18
24-6C-16
24-67A-14
24-21F-18
24-2-18
24-31A-18
24-31G-18
24-31H-18
24-31J-18

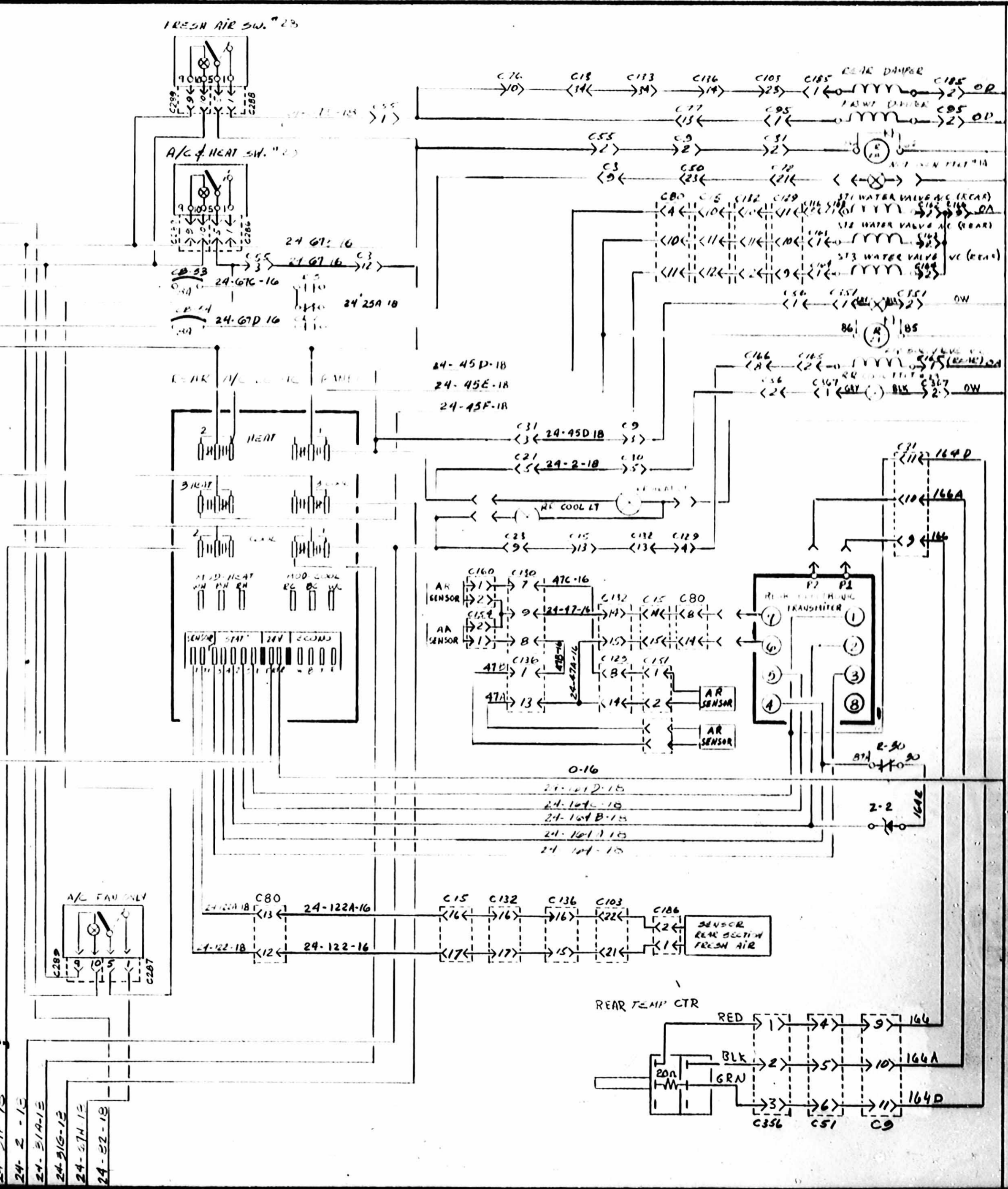

A/C & HEAT SYSTEM

E	88-09	CD# 15247	O.C.

D	88-03	Z-2 TOURNE DE COTE	M.A.
C	88-02	C.D. # 13311	B.C.
B	87-12	LANCÉ	A.B.
A	87-04	CORR. PRELIMINAIRE	P.C.
ITEM	DATE	REVISION	PAR

TITRE: WIRING DIAGRAM H5-60

APPL: H5-60 VER. EFF. J001 PRIOR TO J003 REF:

DESS: A. B.	DATE: 86-09
VER: 1/0	APP: 1/0
NO: D-060566 1/24 C	





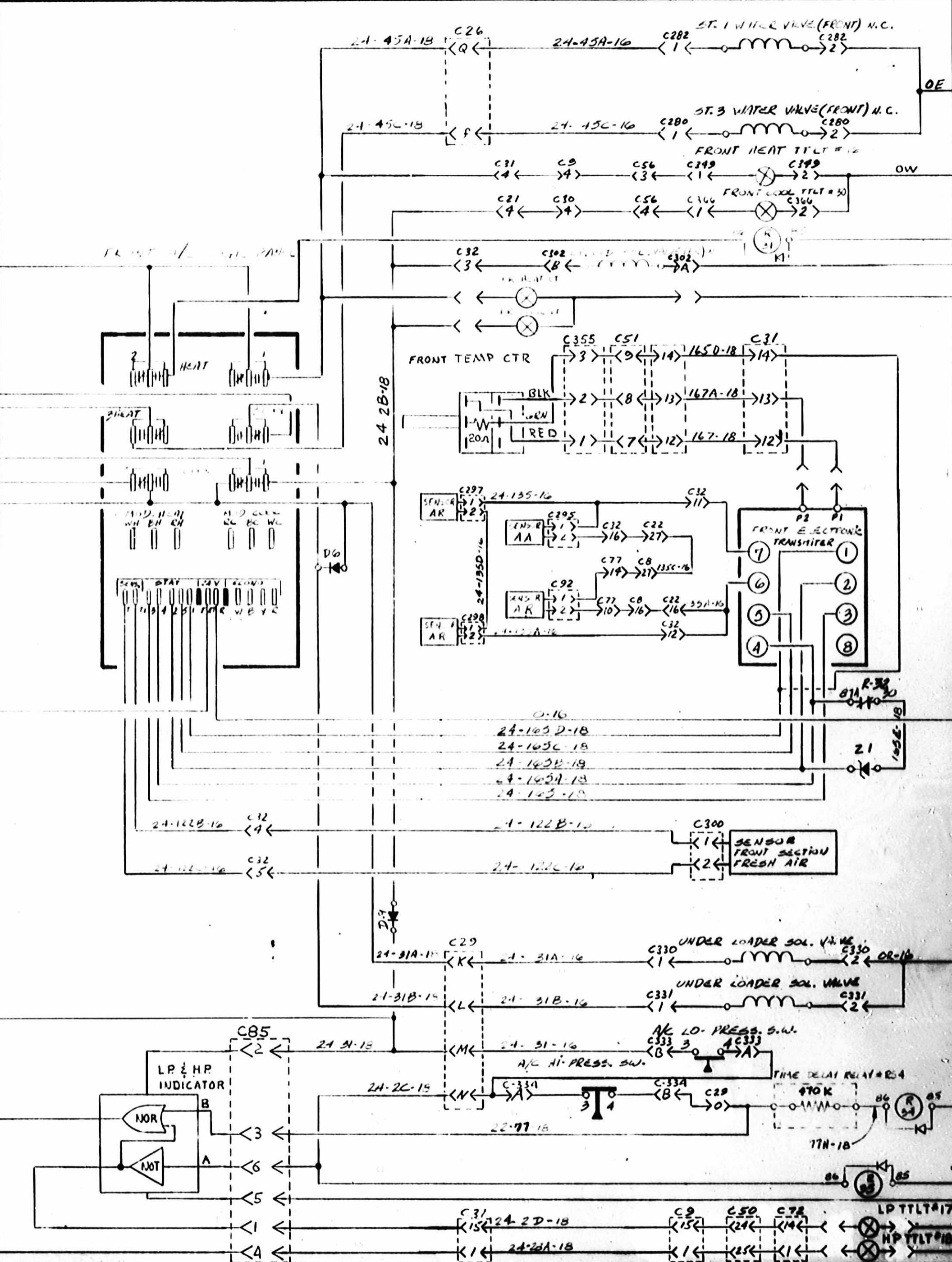
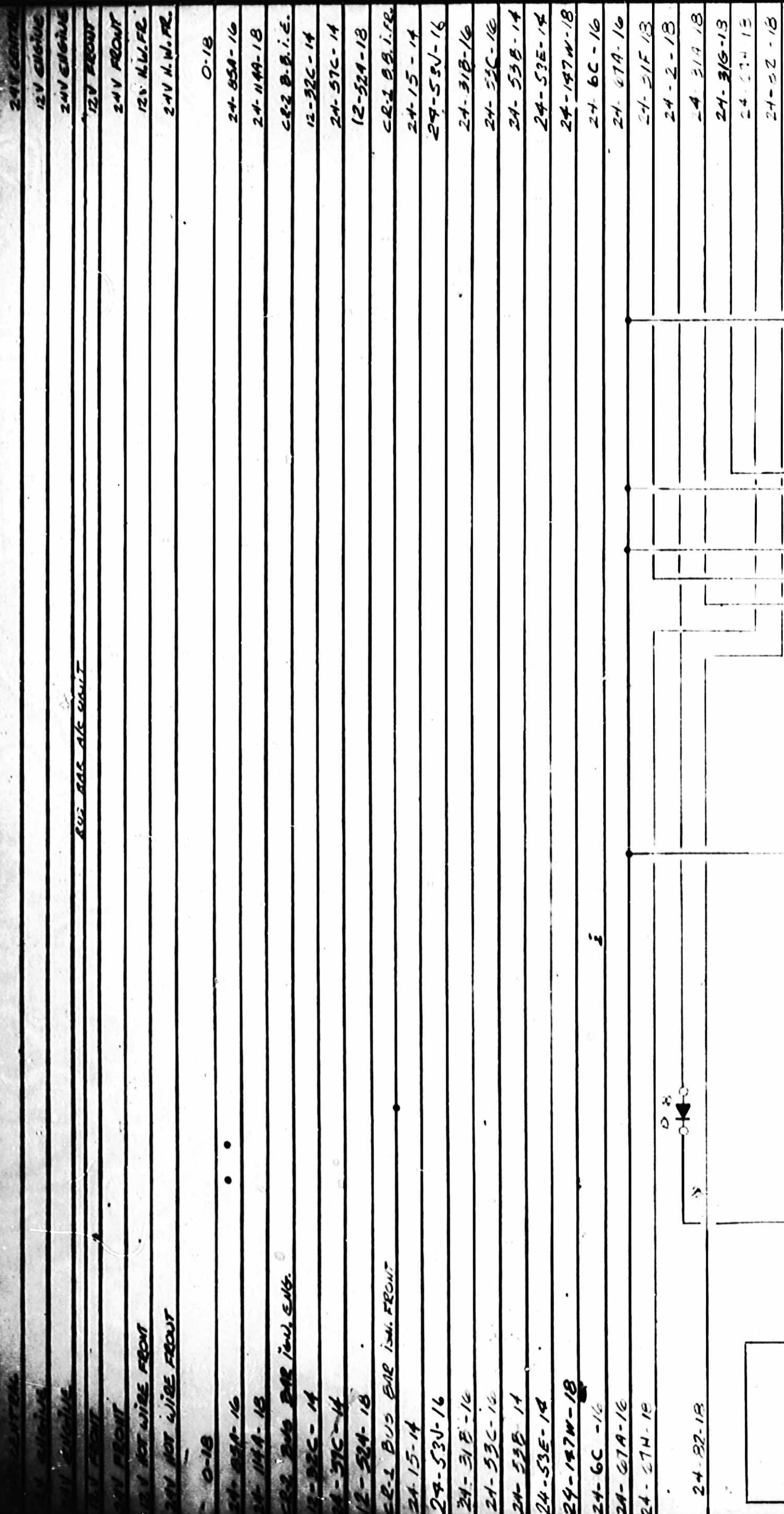

A/C & HEAT SYSTEM

D	88-03	ZI TOURNER DE COTE	M.D.
C	88-02	C.D. # 13311	B.C.
B	87-12	LAKE	A.B.
A	87-04	CORR. PRELIMINAIRE	R.C.
E	09-88	C.D.# 15248	O.C.

TITRE: WIRING DIAGRAM H5-60  
 APPL: H5-60 VEH. EFF. J-001 PRIOR TO J-009 REF:

DESS: A.B. DATE: 26-09  
 VER: KC. REF: D-060566

12V CENTRAL	12V ENGINE
24V CENTRAL	24V ENGINE
24V ENGINE	24V FRONT
24V FRONT	24V H.W. FE.
24V H.W. FE.	24V H.W. FE.
0-18	0-18
24-55A-16	24-55A-16
24-114A-16	24-114A-16
24-55B-16	24-55B-16
12-52C-14	12-52C-14
24-57C-14	24-57C-14
12-524-18	12-524-18
24-55-18	24-55-18
24-55J-16	24-55J-16
24-55B-16	24-55B-16
24-55C-16	24-55C-16
24-55B-14	24-55B-14
24-55E-14	24-55E-14
24-147W-18	24-147W-18
24-6-C-16	24-6-C-16
24-52-15	24-52-15

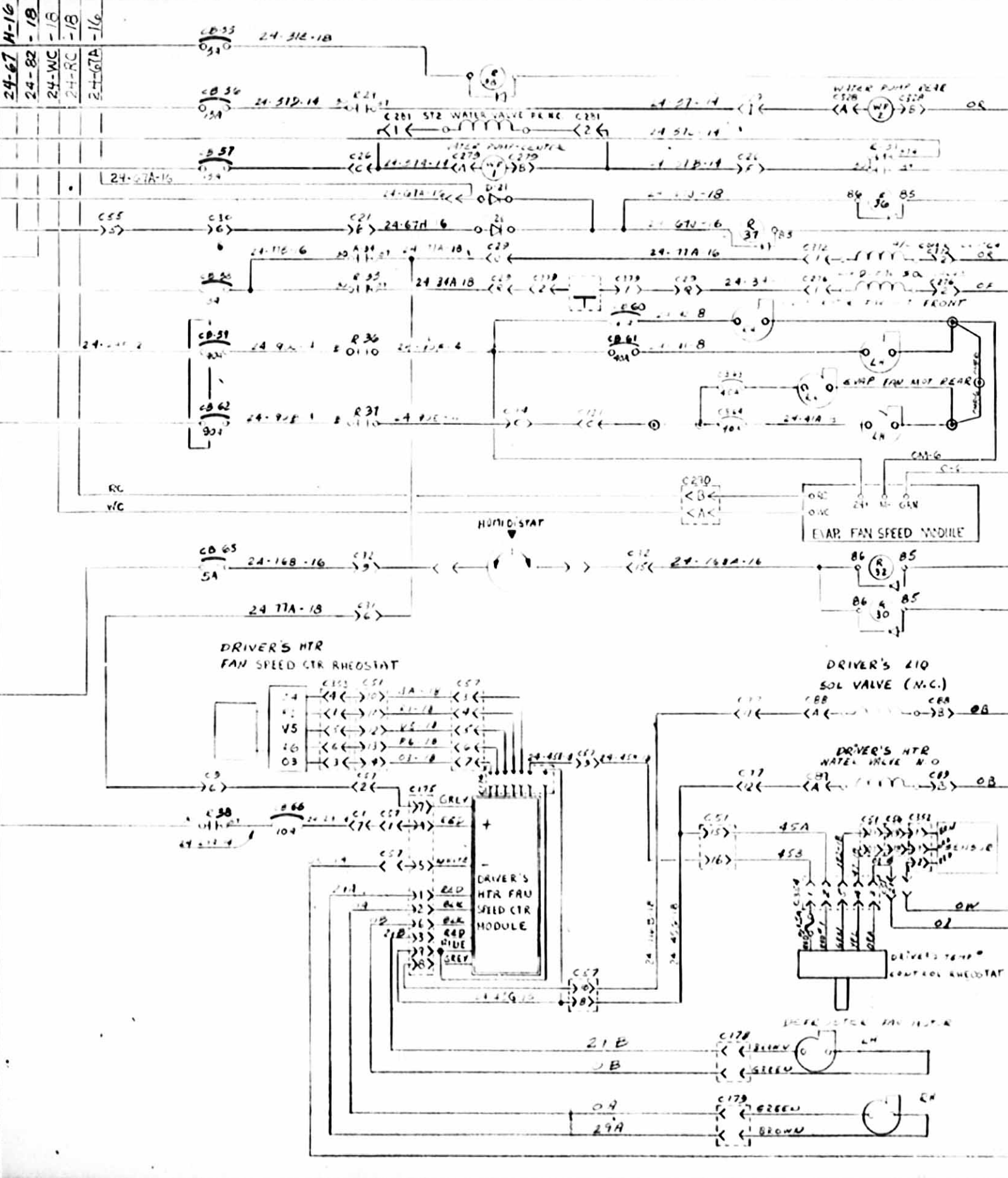

A/C & HEAT SYSTEM

12V CENTRAL	12V ENGINE
24V CENTRAL	24V ENGINE
24V ENGINE	24V FRONT
24V FRONT	24V H.W. FE.
24V H.W. FE.	24V H.W. FE.
0-18	0-18
24-55A-16	24-55A-16
24-114A-16	24-114A-16
24-55B-16	24-55B-16
12-52C-14	12-52C-14
24-57C-14	24-57C-14
12-524-18	12-524-18
24-55-18	24-55-18
24-55J-16	24-55J-16
24-55B-16	24-55B-16
24-55C-16	24-55C-16
24-55B-14	24-55B-14
24-55E-14	24-55E-14
24-147W-18	24-147W-18
24-6-C-16	24-6-C-16
24-52-15	24-52-15

DATE	8/11
REVISION	LANCE
PAR	S.B.

TITRE: WIRING DIAGRAM H5-60  
 APPL: H5-60 VEH EFF J001 FROM TO J009 REF: SPECIAL VOYAGEUR RETROFIT

DESSI	S.B.	DATE	89/11
VER.	16	APP.	12
NOI	D-060566	13/24	C

12V CENTRAL	24V CENTRAL	12V ENGINE	24V ENGINE	24V PARALLEL	12V FRONT	24V FRONT	12V H.W. FE	24V H.W. FE	0-18	24-85A-16	24-14A-18	C-2 89.1E.	12-32C-14	24-37C-14	12-52A-18	C-2 18 2.1R	24-15-14	24-55-16	24-35-16	24-53-16	24-53-14	24-53-14	24-53E-14	24-147W-18	24-6-C-16	24-67-A-16	24-67-H-16	24-82-18
CENTRAL	CENTRAL	ENGINE	ENGINE	PARALLEL	FRONT	FRONT	H.W. FE	H.W. FE		85A-16	14A-18	89.1E.	32C-14	37C-14	52A-18	2.1R	15-14	55-16	35-16	53-16	53-14	53-14	53E-14	147W-18	6-C-16	67-A-16	67-H-16	82-18
SENSIBLE	SENSIBLE	ENGINE	ENGINE	PARALLEL	FRONT	FRONT	H.W. FE	H.W. FE		85A-16	14A-18	89.1E.	32C-14	37C-14	52A-18	2.1R	15-14	55-16	35-16	53-16	53-14	53-14	53E-14	147W-18	6-C-16	67-A-16	67-H-16	82-18
NOT WIRE	NOT WIRE	ENGINE	ENGINE	PARALLEL	FRONT	FRONT	H.W. FE	H.W. FE		85A-16	14A-18	89.1E.	32C-14	37C-14	52A-18	2.1R	15-14	55-16	35-16	53-16	53-14	53-14	53E-14	147W-18	6-C-16	67-A-16	67-H-16	82-18
NOT WIRE	NOT WIRE	ENGINE	ENGINE	PARALLEL	FRONT	FRONT	H.W. FE	H.W. FE		85A-16	14A-18	89.1E.	32C-14	37C-14	52A-18	2.1R	15-14	55-16	35-16	53-16	53-14	53-14	53E-14	147W-18	6-C-16	67-A-16	67-H-16	82-18
										85A-16	14A-18	89.1E.	32C-14	37C-14	52A-18	2.1R	15-14	55-16	35-16	53-16	53-14	53-14	53E-14	147W-18	6-C-16	67-A-16	67-H-16	82-18
										85A-16	14A-18	89.1E.	32C-14	37C-14	52A-18	2.1R	15-14	55-16	35-16	53-16	53-14	53-14	53E-14	147W-18	6-C-16	67-A-16	67-H-16	82-18
										85A-16	14A-18	89.1E.	32C-14	37C-14	52A-18	2.1R	15-14	55-16	35-16	53-16	53-14	53-14	53E-14	147W-18	6-C-16	67-A-16	67-H-16	82-18
										85A-16	14A-18	89.1E.	32C-14	37C-14	52A-18	2.1R	15-14	55-16	35-16	53-16	53-14	53-14	53E-14	147W-18	6-C-16	67-A-16	67-H-16	82-18
										85A-16	14A-18	89.1E.	32C-14	37C-14	52A-18	2.1R	15-14	55-16	35-16	53-16	53-14	53-14	53E-14	147W-18	6-C-16	67-A-16	67-H-16	82-18
										85A-16	14A-18	89.1E.	32C-14	37C-14	52A-18	2.1R	15-14	55-16	35-16	53-16	53-14	53-14	53E-14	147W-18	6-C-16	67-A-16	67-H-16	82-18
										85A-16	14A-18	89.1E.	32C-14	37C-14	52A-18	2.1R	15-14	55-16	35-16	53-16	53-14	53-14	53E-14	147W-18	6-C-16	67-A-16	67-H-16	82-18
										85A-16	14A-18	89.1E.	32C-14	37C-14	52A-18	2.1R	15-14	55-16	35-16	53-16	53-14	53-14	53E-14	147W-18	6-C-16	67-A-16	67-H-16	82-18

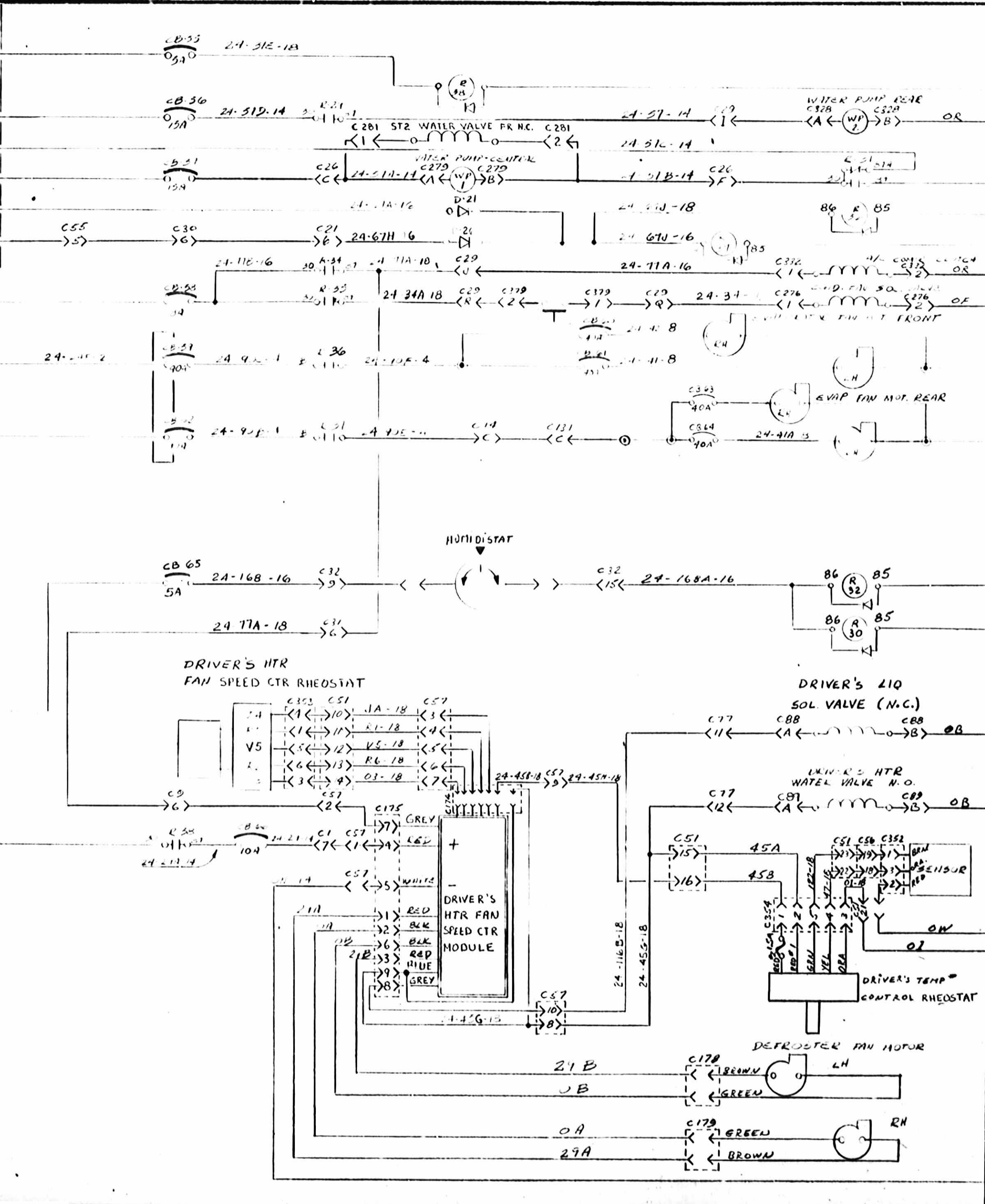

A/C & HEAT SYSTEM

D	88-05	CB65 ETAT BA	M	TITRE:	DESS: A. B.	DATE-86-0
C	88-05	MISE A JOUR	B		VER.-	APPR.-
B	87-12	LAKE	A			
A	87-04	CORR. PRELIMINAIRE	P			
TEM	DATE	REVISION	PAR	APPL: H5-60	VEH EFF U-001 PRIOR TO U-009	REF:
				<b>WIRING DIAGRAM H5-60</b>		
						NO: D-060566 1 3/4

12V CENTRAL  
24V CENTRAL  
12V ENGINE  
24V ENGINE  
12V FRONT  
24V FRONT  
12V HOT WIRE FR  
24V HOT WIRE FR

12V CENTRAL  
24V CENTRAL  
12V ENGINE  
24V ENGINE  
12V FRONT  
24V FRONT  
12V HOT WIRE FR  
24V HOT WIRE FR

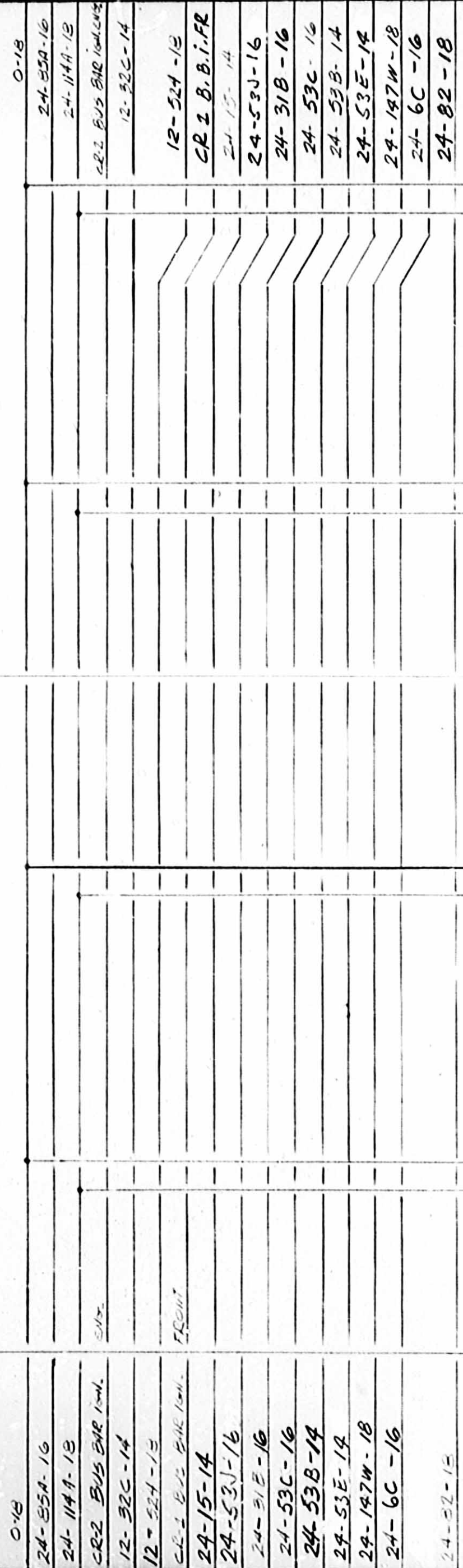

REAR VIEW MIRROR  
ADJUSTING SW. L.H. #35

MIRROR MOTOR L.H.

REAR VIEW  
MIRROR

REAR VIEW MIRROR  
ADJUSTING SW. R.H. #36

MIRROR MOTOR R.H.

HEATED MIRROR

HEATED  
MIRROR SW. #37

L.H. MIRROR HEATED

R.H. MIRROR HEATED

DRIVER'S WINDOW  
LIFTER SW. #38

DRIVER'S WINDOW LIFTER  
MOTOR

DRIVER'S WINDOW

CIGAR LIGHTER

CIGAR LIGHTER

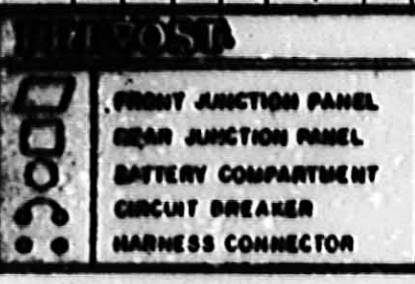

ITEM	DATE	REVISION	PAR
B	87-12	LONGÉ	AB
A	87-04	CORR. PRELIMINAIRE	RC.

TITRE:	DESS:	DATE:
WIRING DIAGRAM H5-60	A. B.	86-09
	VER.-	APPR.-

APPL:	VEN EFF:	J-001:	REF:
H5-60	PRIOR TO:	J-008	

NO:	DATE:
D-060566 1/24	C

12 V CENT  
24 V CENT  
12 V ENGINE  
24 V ENGINE  
12 V FRONT  
24 V FRONT  
12 V HOT WIRE FRONT  
24 V HOT WIRE FRONT

0-18  
24-85A-16  
24-114A-18  
CR-2 BUS BAR IGN. ENG.  
12-32C-14  
524-18  
CR-1 BUS BAR IGN. FR.  
24-15-14  
24-53J-16  
24-31B-16  
24-53C-16  
24-53B-14  
24-53E-14  
24-147W-18  
24-6C-18  
24-82-18

12 V CENT  
24 V CENT  
12 V ENGINE  
24 V ENGINE  
12 V FRONT  
24 V FRONT  
12 V HOT WIRE FRONT  
24 V HOT WIRE FRONT

0-18  
24-85A-16  
24-114A-18  
CR-2 BUS BAR IGN. ENG.  
12-32C-14  
524-18  
CR-1 BUS BAR IGN. FRONT  
24-15-14  
24-53J-16  
24-31B-16  
24-53C-16  
24-53B-14  
24-53E-14  
24-147W-18  
24-6C-16  
24-82-18

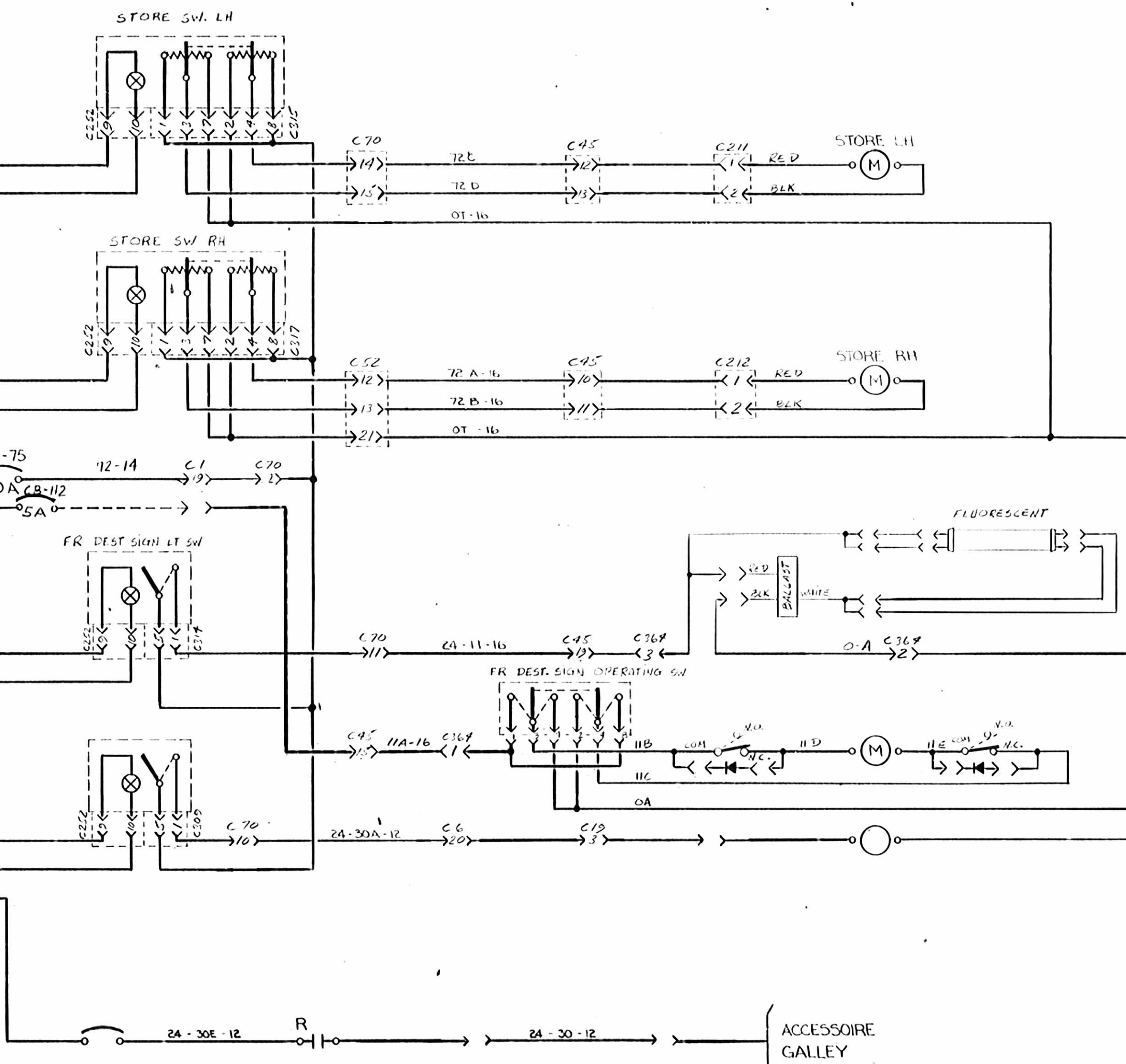

STORE

FRONT DESTINATION SIGN

OPTION GALLEY

**LEGEND**

	FRONT JUNCTION PANEL
	REAR JUNCTION PANEL
	BATTERY COMPARTMENT
	CIRCUIT BREAKER
	HARNESS CONNECTOR
	BATTERY JUNCTION BLOCK
	SINGLE CONNECTOR
	SIDE (RECTIFIER)
	OPTION

ITEM	DATE	REVISION	PAR

TITRE:  
**WIRING DIAGRAM H5-60**

APPL: H5-60 VEH. EFF. J-001  
PRIOR TO. J-008

DESS: D.T. DATE: 87-12-18  
VER.- APPR.-  
NO: D-060566 15/24 C





12V CENTRAL  
24V CENTRAL  
12V ENGINE  
24V ENGINE  
12V FRONT  
24V FRONT  
12V HOT WIRE FR  
24V HOT WIRE FR

0-13  
24-25A-16  
24-11A-18  
CR-2 B.B.I.E.  
12-52C-14  
12-524-18  
CR-1 B.B.I.FR.  
24-15-4  
24-53J-16  
24-31B-16  
24-53C-16  
24-53B-14  
24-53E-14  
24-197W-18  
24-176-16  
24-1620-16  
24-53-12  
24-176-12

12V CENTRAL  
24V CENTRAL  
12V ENGINE  
24V ENGINE  
12V FRONT  
24V FRONT  
12V HOT WIRE FRONT  
24V HOT WIRE FRONT

0-18  
24-25A-16  
24-11A-18  
CR-2 P.D. BAR IGN. ENGR.  
12-52C-14  
12-524-18  
CR-1 P.D. BAR IGN. FRONT  
24-147W-18  
24-176-16  
24-1620-16  
24-82-13  
24-176-14

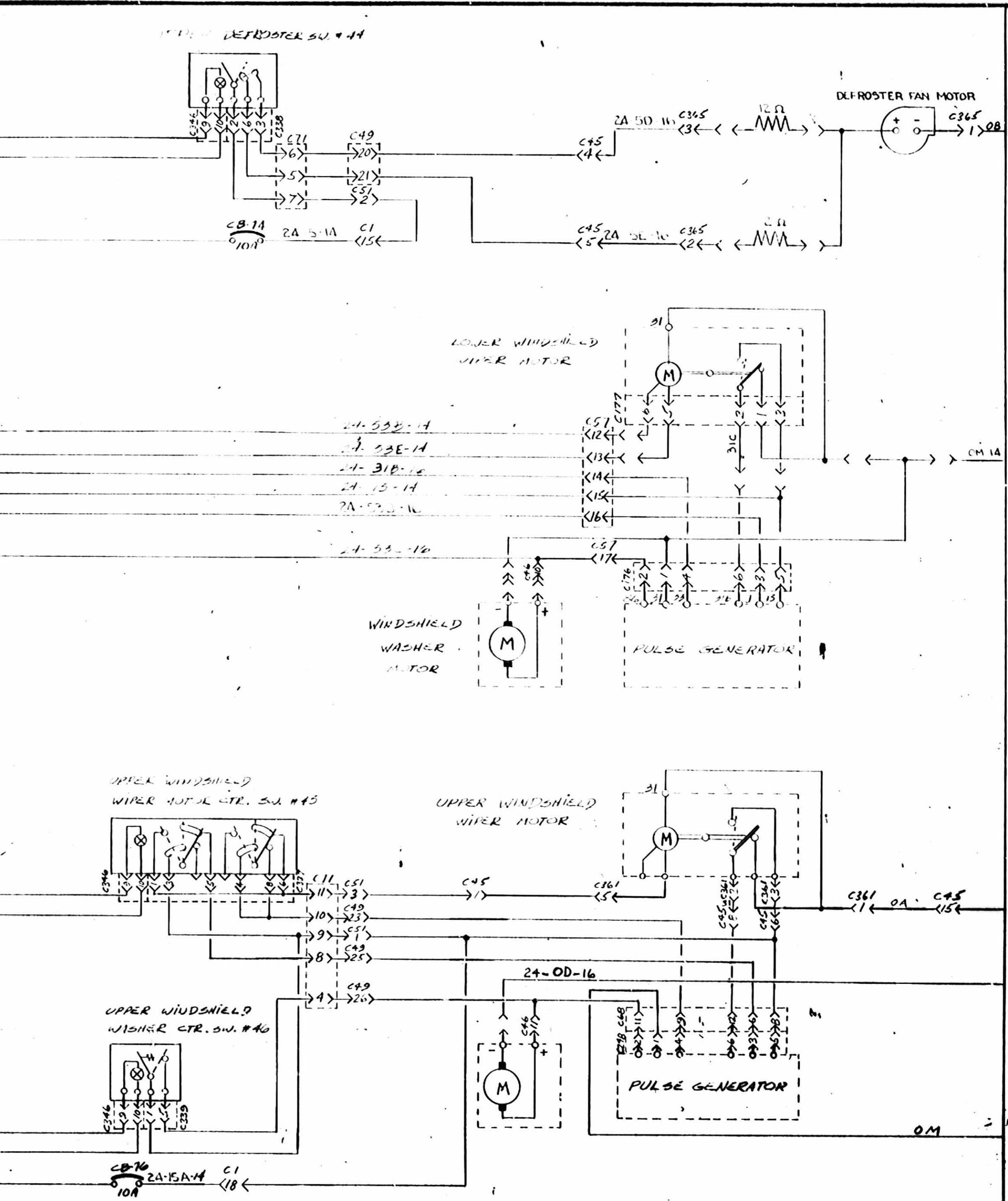

UPPER WINDSHIELD DEFROST

LOWER WINDSHIELD WIPER & WASHER

UPPER WINDSHIELD WIPER & WASHER

C	88-05	MISE 2 JOUR	MF
B	87-12	LANCÉ	AD
A	87-04	CORR. PRELIMINAIRE	PC
		REVISION	

TITRE: WIRING DIAGRAM H5-60

APPL: H5-60 VEH EFF J-001 PRIOR TO J-009

DESS: A.B.  
VER: /C  
D-060566 7/24



- 12V CONTROL
- 24V CONTROL
- 24V SIGNAL
- 24V SIGNAL
- 12V FRONT
- 24V FRONT
- 24V W.U.R.
- 24V W.U.R.

- 24-55A-16
- 24-14A-1B
- CR-2 B.A.L.C.
- 12-52C-14
- 12-52F-16
- 24-197W-18
- 24-176-16
- 24-120-16
- 24-82-1B

- 24-12U-16
- 24-12X-16
- 24-176-1B
- 24-12J-16
- 24-120-16
- 24-82-1B
- 24-7-16
- 24-82-1B

- 24-12U-16
- 24-12X-16
- 24-176-1B
- 24-12J-16
- 24-120-16
- 24-82-1B
- 24-7-16
- 24-82-1B

- 24-12U-16
- 24-12X-16
- 24-176-1B
- 24-12J-16
- 24-120-16
- 24-82-1B
- 24-7-16
- 24-82-1B

- 24-12U-16
- 24-12X-16
- 24-176-1B
- 24-12J-16
- 24-120-16
- 24-82-1B
- 24-7-16
- 24-82-1B

- 24-12U-16
- 24-12X-16
- 24-176-1B
- 24-12J-16
- 24-120-16
- 24-82-1B
- 24-7-16
- 24-82-1B

- 24-12U-16
- 24-12X-16
- 24-176-1B
- 24-12J-16
- 24-120-16
- 24-82-1B
- 24-7-16
- 24-82-1B

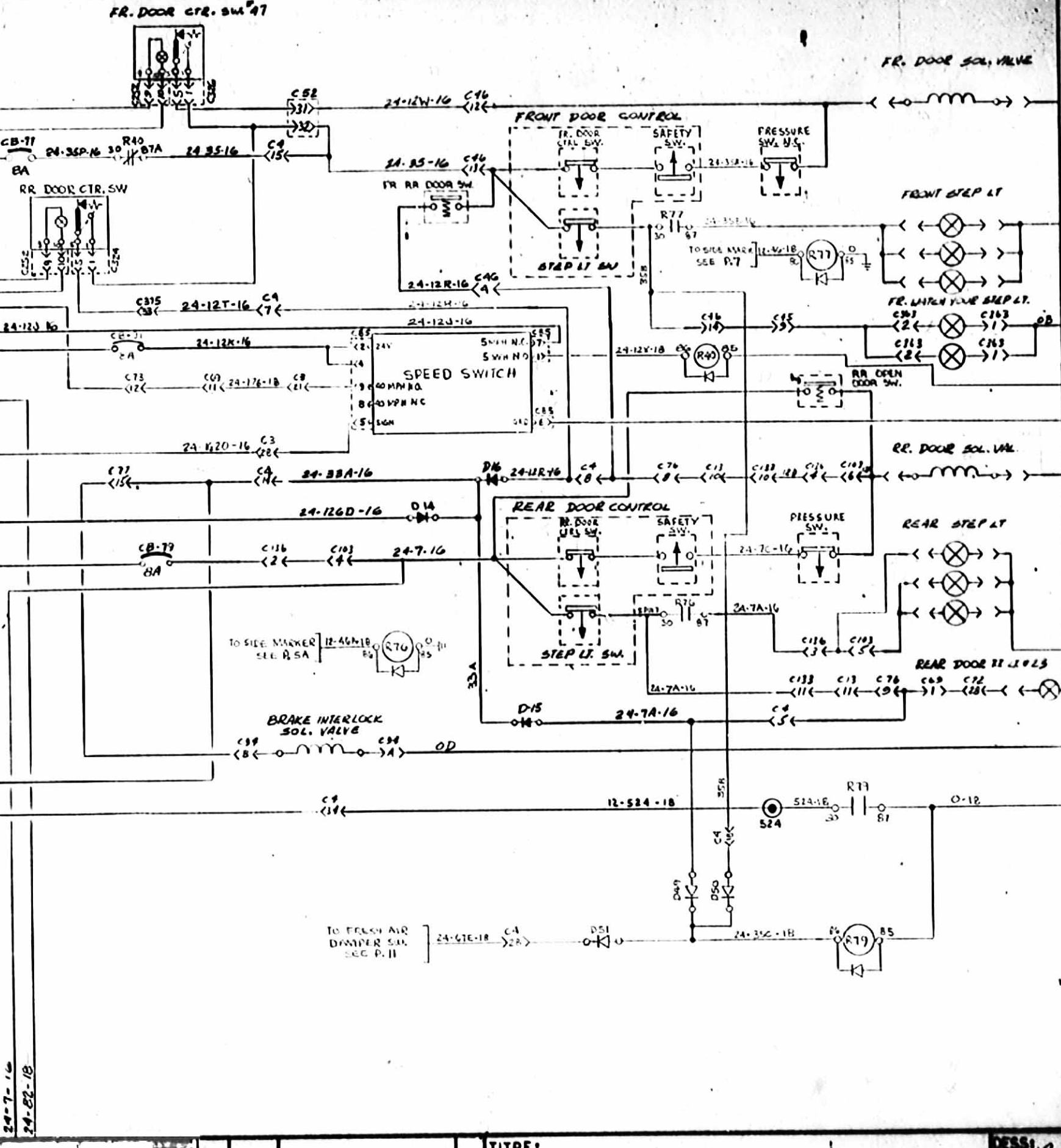

- 24-82-1B
- 24-7-16
- 24-82-1B
- 24-82-1B
- 24-82-1B
- 24-82-1B
- 24-82-1B
- 24-82-1B
- 24-82-1B

REAR & FRONT DOOR CONTROL

12V CONTROL

24V CONTROL

24V SIGNAL

REV	DATE	REVISION
B	10-11	R76, R77, R78, R79, R80
A	09-08	C.D. # 19807
A	02/10	LANCÉ

TITRE: WIRING DIAGRAM H5-60

APPL: H5-60 VEH EFF J-001 PRIOR TO J-003

DESS: A.B.

VER: C

D-060566 18N/LA C

87/10



- 12V CENTRAL
- 24V CENTRAL
- 12V ENGINE
- 24V ENGINE
- 12V FRONT
- 24V FRONT
- 12V H.W.P.
- 24V H.W.P.
- 0-18
- 24-55A-16
- 24-14A-18
- CR-2 B.B.I.G.
- 12-32C-14
- 12-32A-18
- CR-1 B.B.I.G.
- 24-147W-18
- 24-176-16
- 24-1620-16
- 24-142-18
- 24-176-18

- 12V CENTRAL
- 24V CENTRAL
- 12V ENGINE
- 24V ENGINE
- 12V FRONT
- 24V FRONT
- 12V H.W.P.
- 24V H.W.P.
- 0-18
- 24-55A-16
- 24-14A-18
- CR-2 B.B.I.G.
- 12-32C-14
- 12-32A-18
- CR-1 B.B.I.G.
- 24-147W-18
- 24-176-16
- 24-1620-16
- 24-142-18
- 24-176-18

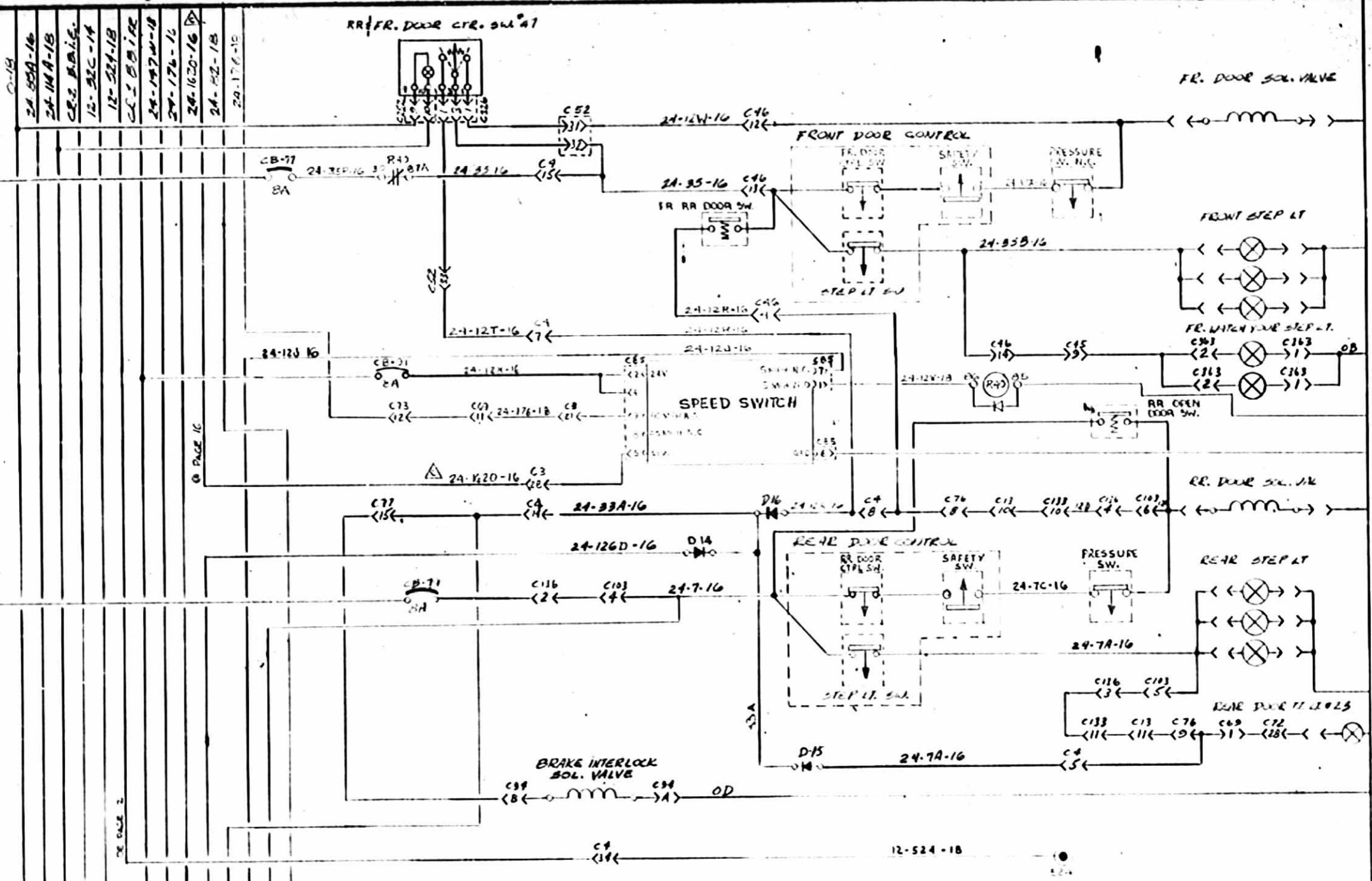

REAR & FRONT DOOR CONTROL

E	90-08	C.D.*19807	DT
D	88-11	CD*15700 CC*88197	MC
C	88-05	MISE A JOUR	ML
B	87-12	LANCÉ	AB
A	87-04	CORR. PRELIMINAIRE	PC
ITEM	DATE	REVISION	PAR

TITRE: **WIRING DIAGRAM H5-60**

APPL: H5-60 VEH EFF J-001 PRIOR TO J-005

REF:

DESS: A. B. DATE: 2/24

VER: C

NOI D-060566 18/24



12V CENTRAL
24V CENTRAL
12V ENGINE
24V ENGINE
12V FRONT
24V FRONT
12V HALL FZ
24V HALL FZ
0-18
24-85A-16
24-119A-18
CRS BAR 16A 16A ENG.
12-32C-14
CE-1 BUS BAR IGN. FRONT
24-147W-18
24-176-16
24-126D-16
24-33A-16
24-12J-16
24-7-16
24-82-18
24-12J-16
24-82-18

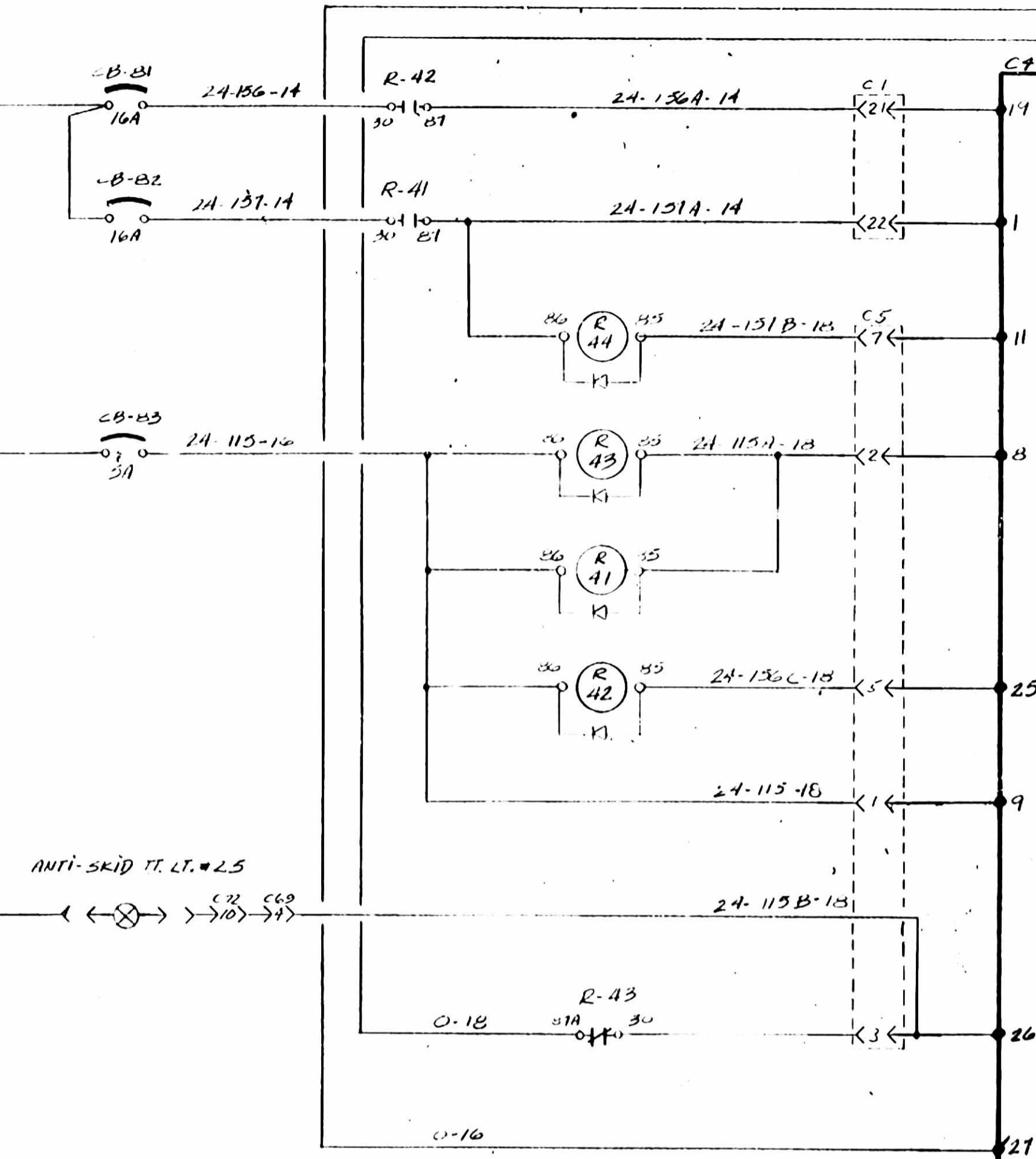

ELECTRIC CABLES WITHOUT MARK : 1.4mm<sup>2</sup> OR 1.5mm<sup>2</sup> = AWG 16  
CONNECTING BOX WATER-PROOF  
ELECTRIC FUSE CORRESPONDING TO DIN 12 531 OR CIRCUIT BREAKER

\* CONNECTING CABLE TO OPERATE THE SOLENOID CONTROL VALVE 412.195.000  
COLOUR : 1 GREEN/YELLOW, 2 BLUE, 3 BROWN

EV : INLET VALVE  
AV : OUTLET VALVE

\*\* OPTION DRIVE SLIP CONTROL DSC  
MOT : ACTUATOR FOR MOTOR CONTROL  
DSV : ACTUATOR VALVE FOR DIFFERENTIAL-BRAKE

IF DRIVE SLIP VALVE ARE NOT INSTALLED  
A SHORT (MAX. 1M) WIRE HARNESS SHOULD BE INSTALLED

EE NEXT PAGE

ELECTRONIC CONTROL UNIT

ANTI-SKID

DESIGNER	DATE	TITRE:	DESS: A. E.
C 88-06	24-06-16	LNLEUE	
B 87-12	LANCE		
A 87-01	CORR. PRELIMINAIRE		
REVISION		APPL: H5-60	REF: H5-60
		VEH GEF J-001	VER: C
		PRIOR TO J-003	NO D-060566 19/24 C

- 12V CENTRAL
- 24V CENTRAL
- 12V ENGINE
- 24V ENGINE
- 12V FRONT
- 24V FRONT
- 12V A.W.FR.
- 24V A.W.FR.
- 0-18
- 24-85A-16
- 24-14A-18
- CE2 2.6.16
- 12-32C-14
- CE-1 2.6.12
- 24-147W-18
- 24-176-18
- 24-126D-16
- 24-33A-16
- 24-7-16
- 24-82-18
- 24-120-16
- 12V CENTRAL
- 24V CENTRAL
- 12V ENGINE
- 24V ENGINE
- 12V FRONT
- 24V FRONT
- 12V A.W.FR.
- 24V A.W.FR.
- 0-18
- 24-85A-16
- 24-14A-18
- CE2 BUS BAR IGN. ENG.
- 12-32C-14
- CE-1 BUS BAR IGN. FRONT
- 24-147W-18
- 24-176-18
- 24-126D-16
- 24-33A-16
- 24-7-16
- 24-82-18
- 24-120-16

FRONT AXLE

DRIVE AXLE

REAR AXLE

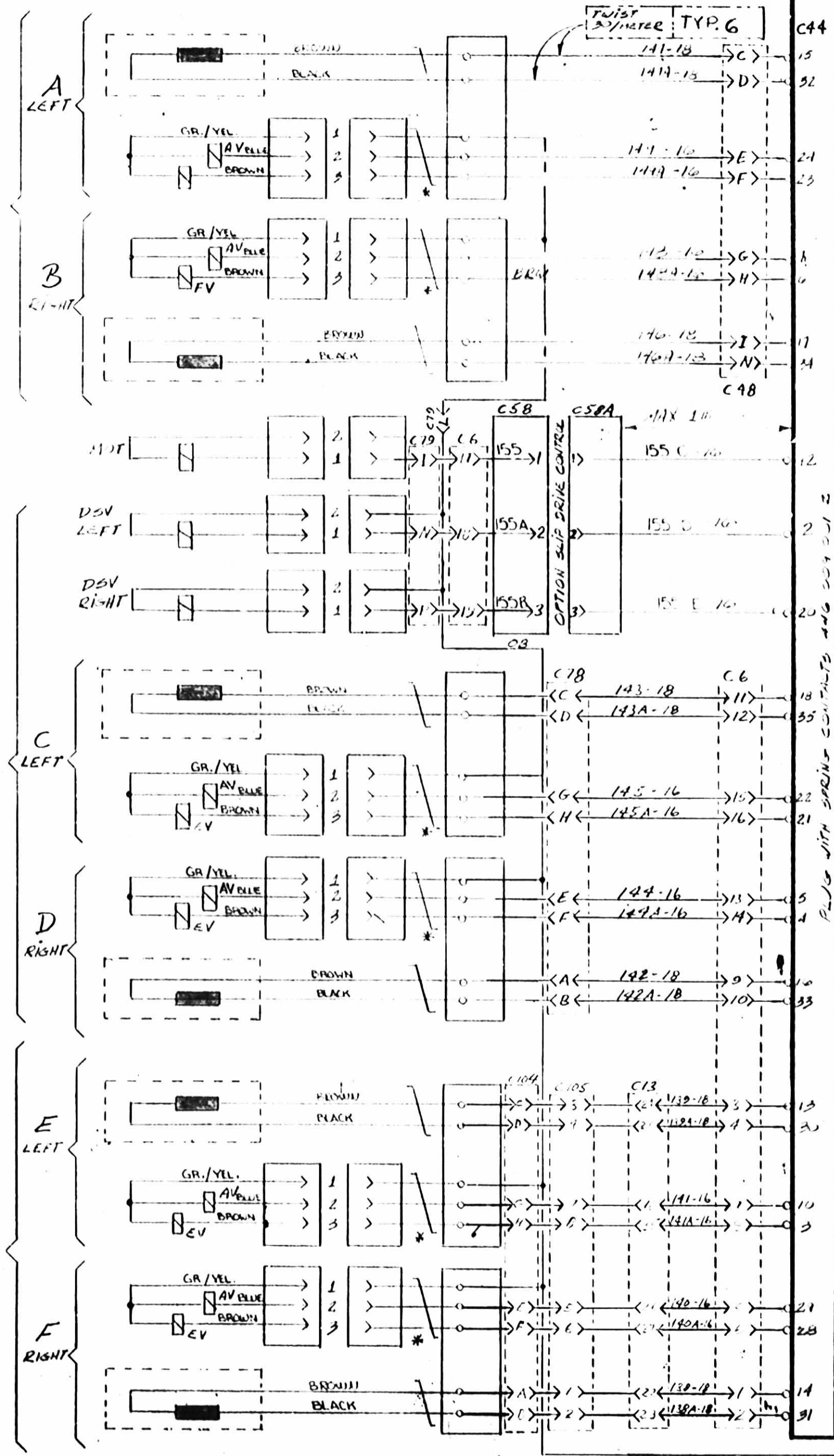

C44  
 15  
 32  
 24  
 23  
 1  
 6  
 17  
 24  
 C98  
 12  
 2  
 20  
 18  
 35  
 22  
 21  
 5  
 4  
 10  
 33  
 13  
 3  
 10  
 3  
 21  
 28  
 14  
 31  
 446 005 001 0 (OPTION DS) IDENTICAL FUNCTION WITH 446 005 002 0 IF DRIVE SLIP CONTROL IS NOT USED  
 446 005 002 0 (WITHOUT DRIVE SLIP CONTROL)

ANTI-SKID

REVISIONS

C	88-06	24-60-16 ENLEVÉ	MA
B	87-12	LANCÉ	AB
A	87-04	CORR. PRELIMINAIRE	PC
DATE		REVISION	PAR

TITRE: WIRING DIAGRAM H5-60

APPL: H5-60 VEH. EFF J001 PRIOR TO J002

DESS: A.B.

VER: KC

NOI D-060566



12V CENTRAL  
24V CENTRAL  
12V ENGINE  
24V ENGINE  
12V FRONT  
24V FRONT  
12V HULL FR.  
24V HULL FR.  
0-18  
24-85A-16  
24-11AA-18  
24-2-88B-16  
12-82C-14  
24-82B-16  
24-147W-18  
24-176-16  
24-126D-16  
24-33A-16  
24-7-16  
24-82-18  
24-121-16

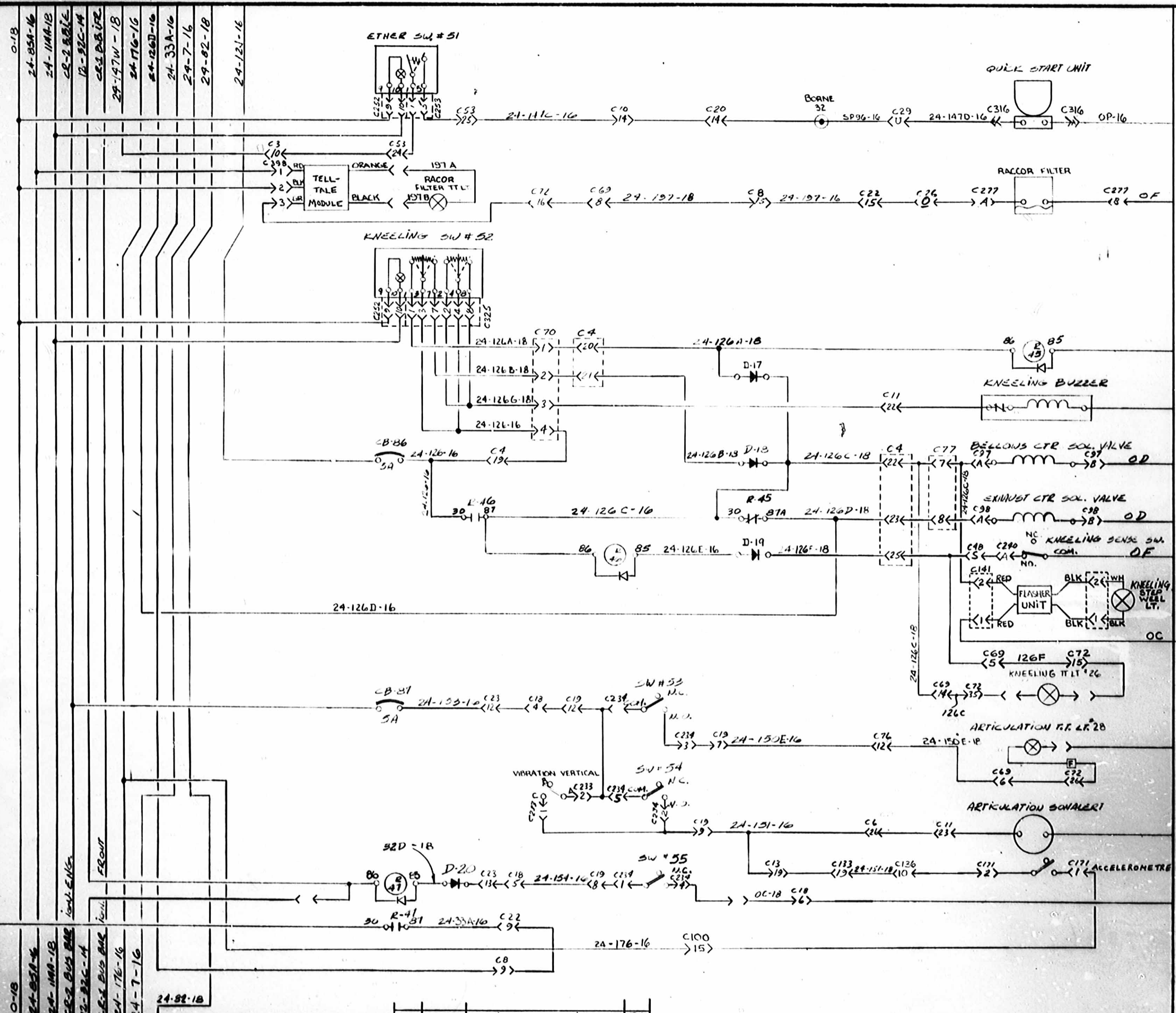

QUICK START

KNEELING

ARTICULATION SWITCH

12V CENTRAL  
24V CENTRAL  
12V ENGINE  
24V ENGINE  
12V FRONT  
24V FRONT  
12V HOT WIRE  
24V HOT WIRE  
FRONT  
FRONT  
12V HULL FR.  
24V HULL FR.  
0-18  
24-85A-16  
24-11AA-18  
24-2-88B-16  
12-82C-14  
24-82B-16  
24-176-16  
24-7-16  
24-82-18



E	89-02	C.D.#16145, O.C.#89031	R06
D	88-06	176 REMPLACE GC	MJ
C	88-02	C.D.#13311	B.C.
B	87-12	LANCEE	AB
A	87-04	CORR. PRELIMINAIRE	PC.
ITEM	DATE	REVISION	PAR

TITRE:  
**WIRING DIAGRAM H5-60**

APPL: H5-60 VEH EFF J-001  
PRIOR TO J-003

REF:

DESS: A.B. DATE: 86-10  
VER. - APPR. -  
NO: D-060566 21/24 C



12V CENTRAL  
24V CENTRAL  
12V ENGINE  
24V ENGINE  
12V FRONT  
24V FRONT  
12V HOT WIRE FRONT  
24V HOT WIRE FRONT  
0-18  
24-85A-16  
24-85A-18  
24-85A-19  
24-85A-20  
24-85A-21  
24-85A-22  
24-85A-23  
24-85A-24  
24-85A-25  
24-85A-26  
24-85A-27  
24-85A-28  
24-85A-29  
24-85A-30  
24-85A-31  
24-85A-32  
24-85A-33  
24-85A-34  
24-85A-35  
24-85A-36  
24-85A-37  
24-85A-38  
24-85A-39  
24-85A-40  
24-85A-41  
24-85A-42  
24-85A-43  
24-85A-44  
24-85A-45  
24-85A-46  
24-85A-47  
24-85A-48  
24-85A-49  
24-85A-50  
24-85A-51  
24-85A-52  
24-85A-53  
24-85A-54  
24-85A-55  
24-85A-56  
24-85A-57  
24-85A-58  
24-85A-59  
24-85A-60

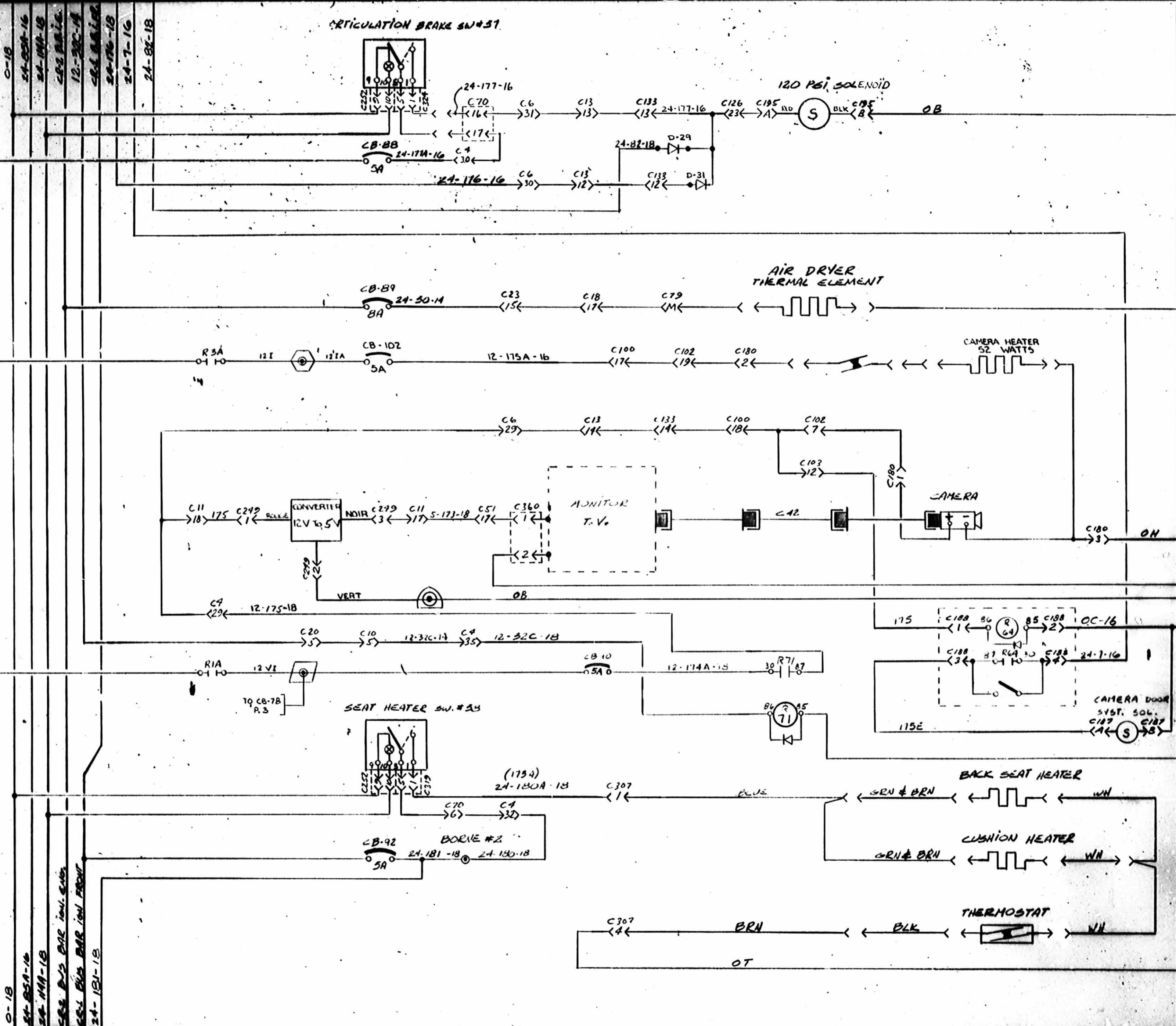

ARTICULATION  
BRAKE

AIR DRYER

BACK UP  
MONITOR

DRIVER'S  
SEAT HEATER

**LEGEND**

	FRONT JUNCTION PANEL
	REAR JUNCTION PANEL
	BATTERY JUNCTION PANEL
	BATTERY COMPARTMENT
	CIRCUIT BREAKER
	HARNESS CONNECTOR
	SINGLE CONDUCTOR
	SHIELD (INSULATED) CONDUCTOR
	OPTION

ITEM	DATE	REVISION	PAR
D	89-02	O.C.#89033, C.D.#16158	Rob.
C	88-06	MISE A JOUR	M.A.
B	87-12	LANCE	AB
A	87-04	CORR. PRELIMINAIRE	P.C.

TITRE :  
**WIRING DIAGRAM H5-60**

APPL: H5-60 VEH. EFF. J-001  
PRIOR TO J-003

DESS: A.B. DATE: 86-10  
VER. APPR. [Signature]  
NO: D-060566 22/124 C



- 12V CENTRAL
- 24V CENTRAL
- 12V ENGINE
- 24V ENGINE
- 12V FRONT
- 24V FRONT
- 12V HOT WIRE FRONT
- 24V HOT WIRE FRONT
- 0-18
- 24-85A-16
- 24-114A-18
- CR-2 B.B.I.F.
- CR-1 B.B.I.F.R.
- 24-181-18

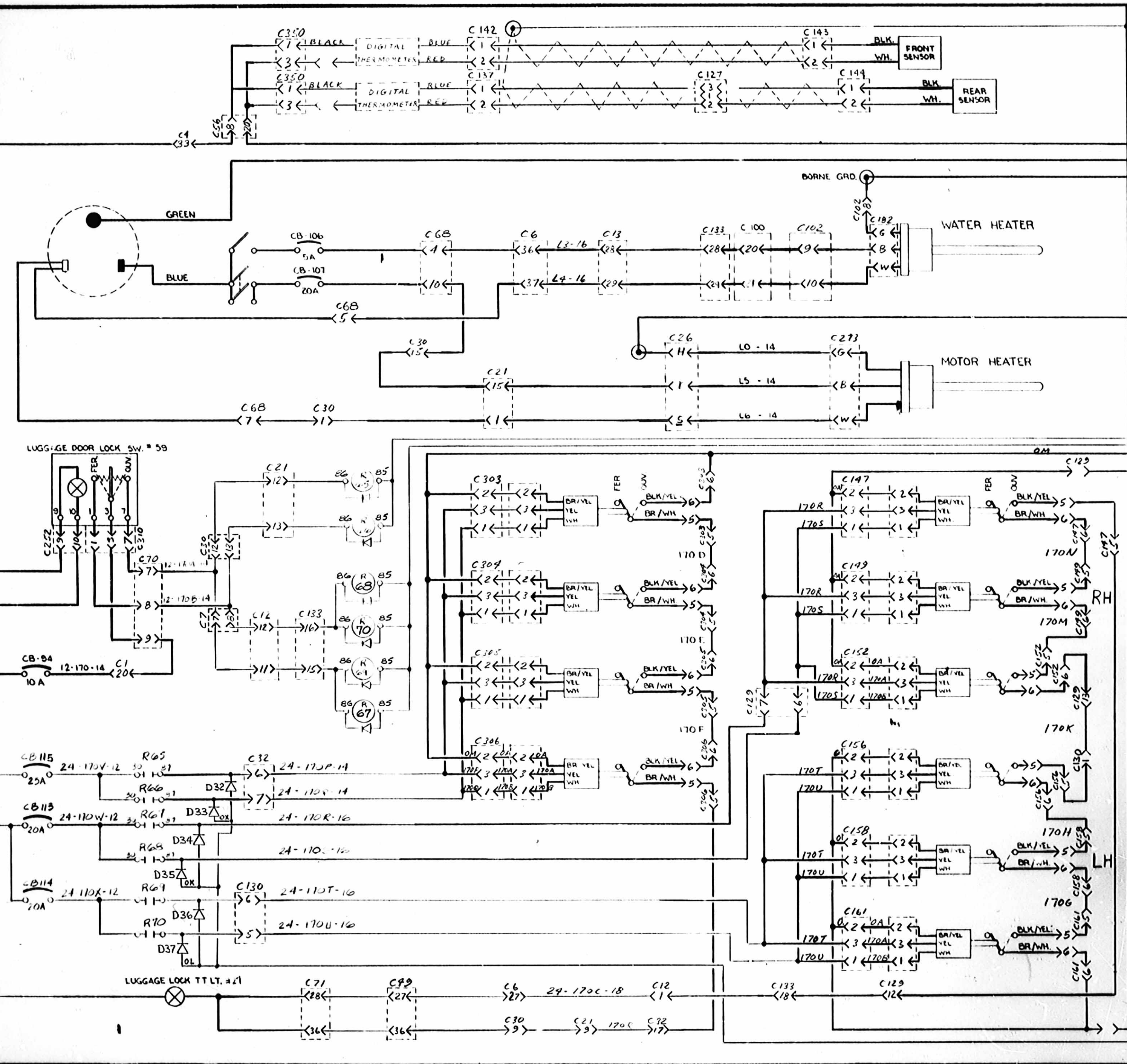

DIGITAL THERMOMETER

WATER TANK HEATER

MOTOR HEATER

LUGGAGE DOOR LOCK



LEGEND

THIS DOCUMENT IS THE PROPERTY OF THE U.S. GOVERNMENT AND IS TO BE REPRODUCED AND TRANSMITTED IN ANY FORM AND BY ANY MEANS, ELECTRONIC OR MECHANICAL, INCLUDING PHOTOCOPYING, RECORDING, OR BY ANY INFORMATION STORAGE AND RETRIEVAL SYSTEM, WITHOUT PERMISSION IN WRITING FROM THE U.S. GOVERNMENT PRINTING OFFICE: 1987-0-282-500-0

E	89-01	D32 @ D37 ADJUSTERS OC #89012	M	TYPE:
D	88-03	CD # 13579	A.B	
C	88-02	C.D. # 13311	B.C.	
B	8112	LANCÉ	AB	
A	87 04	CORR. PRELIMINAIRE	PC	
ITEM	DATE	REVISION	PAR	

WIRING DIAGRAM H5-60

APPL: H5-60 VEH EFF J-001  
PRIOR TO J-003

REF:

DESS: D. TURCOTTE  
VER: -  
NO: D-060566 23/24 C

DATE: DEC. 1987  
APPR: [Signature]



12V CENTER  
24V CENTER  
12V FRONT  
24V FRONT  
12V REAR  
24V REAR  
12V W.L.D.R.  
24V W.L.D.R.  
12V B.B.L.E.  
24V B.B.L.E.

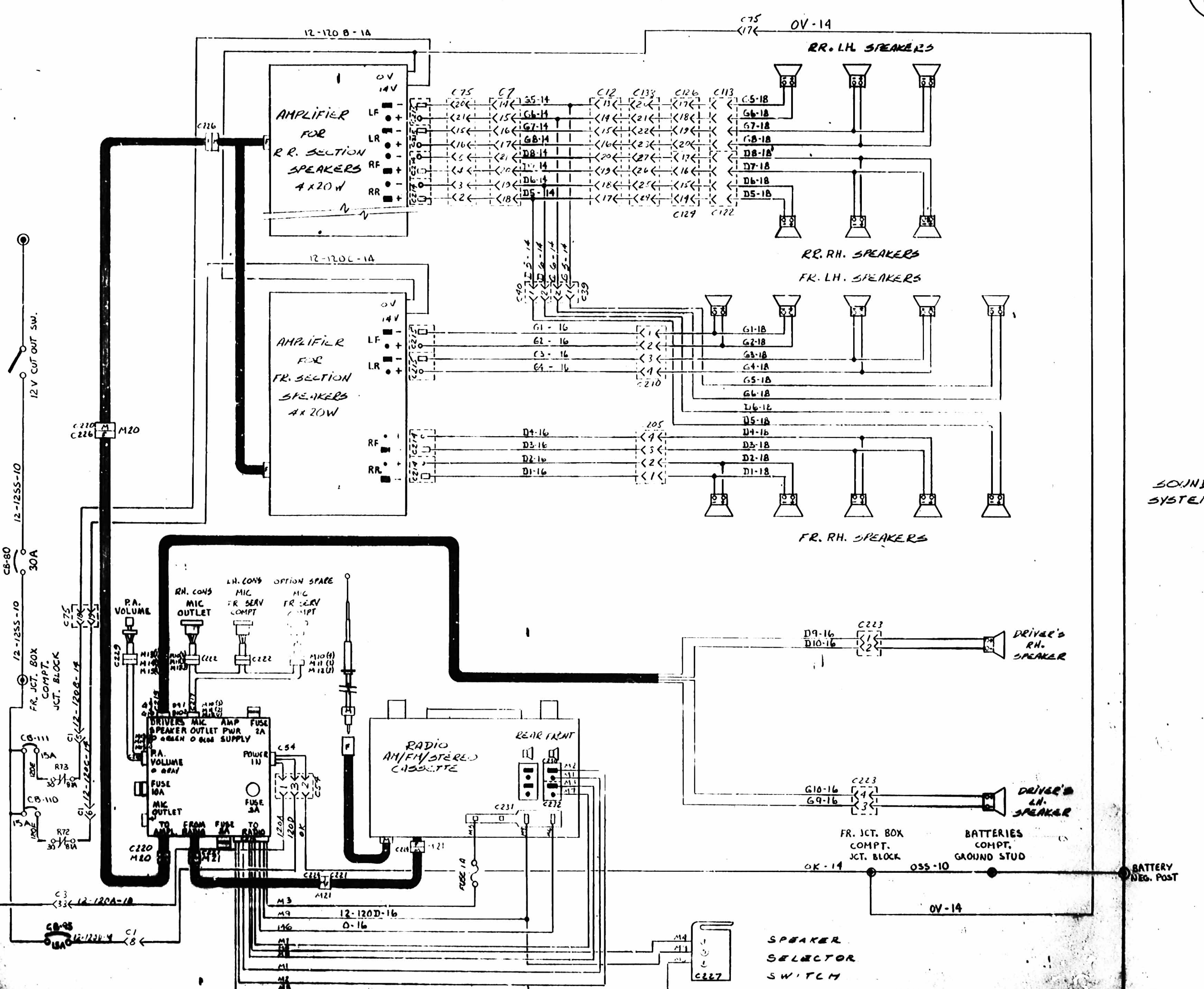

SOUND SYSTEM

LEGEND

F	88/08	CD 14823	
D	89/03	R72 & R73 AJOUTES	
C	87/12	LANGE	
B	87-00	CORR. PRELIMINAIRE	
A	87-04	CORR. PRELIMINAIRE	
REV. DATE		REVISION	

TITRE:

WIRING DIAGRAM H5-60

APPL: H5-60 VEH EFF J-001 PRIOR TO 4-003

DATE: 20/10

Handwritten initials and numbers: LC, 10-000500, 1/1