

Pneumatic diagram

PNEUMATIC DIAGRAMS W0-WE BUS SHELL WITH INDEPENDENT SUSP.

NO:	D140342 P0	REVISION :	i
-----	-------------------	------------	----------

EFF. OC#	2006012	PRIOR TO OC#	2007131	DR.	Y. Laine	date	2010-04-28
EFF. VEH#	#7-9096	PRIOR TO VEH#	#B-9954	CHK	Marc-Jose Handfield	Appr	Marc-José Handfield

REV.	DATE	DESCRIPTION	PAGE	BY	CHK.	APPR.
A	2006-06-19 2006-10-15	#7-9010 WE PRELIMINARY VEHICLE #7-9096 PRODUCTION VEHICLE NOTE : ABS 6 BASIC WITH AIR BRAKE ON TRAILER HITCH , NOT AVAILABLE.				
B	2006-10-19	#D140342 AIR BRAKE ON TRAILER HITCH OPTION	2	Rob.	M.J.H.	M.J.H.
C	2007-02-27	#8-9187 WE PRELIMINARY VEHICLE, WITH ESP ABS 6 (ELECTRONIC STABILITY PROGRAM)				
	2007-06-01 2007-06-01	D140342 P1.0 Revision :B , ABS 6 BASIC D140342 P2.0 New Version ABS 6 ADVANCED W/TRAILER	1 2	Rob. Rob.	M.J.H. M.J.H.	M.J.H. M.J.H.
	2007-06-01 2007-06-01	D140342 P3.0 Revision :B , LEVEL LOW SYSTEM D140342 P4.0 New Version ABS 6 ADVANCED	3 4	Rob. Rob.	M.J.H. M.J.H.	M.J.H. M.J.H.
D	2008-04-14	D140342 P2.0 Revision : D (Update) D140342 P5.0 Revision : B (Update)	P2 &2.1 P5 & 5.1	Rob. Rob.	M.J.H. M.J.H.	M.J.H. M.J.H.
E	2008-06-27	D13 VOLVO ENGINE, ADD AIR CLEANER INJECTOR D140342 P8 & P9 NEW PAGE, RETROFIT # R479	P8 &P8.1 P9 &P9.1	Y.L. Y.L.	M.J.H. M.J.H.	M.J.H. M.J.H.
F	2008-06-30	D140342 P1 Rev.D NEW AIR TANK ASSY FOR DIFFERENTIAL AIR BELLOWS SUSPENSION	P1 &P1.1	Rob.	M.J.H.	M.J.H.

Pneumatic diagram

PNEUMATIC DIAGRAMS W0-WE BUS SHELL WITH INDEPENDENT SUSP.

REV.	DATE	DESCRIPTION	PAGE	BY	CHK.	APPR.
G	2009-01-16	D140342 P1 Revision : D (Update)	P1 & P1.1	Y.L.	M.J.H.	M.J.H.
		D140342 P2 Revision : E (Update) OC #2008107	P2 & P2.1	Rob.	M.J.H.	M.J.H.
		D140342 P6 VOLVO ENGINE PRELIMINARY #9-9596 , EFF.# 9-9682...	P6 & 6.1	Rob.	M.J.H.	M.J.H.
		D140342 P7 NEW PAGE , DETROIT ENGINE ALLISON W/RETARDER	P7 & 7.1	Rob.	M.J.H.	M.J.H.
H	2010-04-20	VOLVO ENGINE, O.C. #2009088 , RV-3 VALVE SOLENOID ASSY	P7 & P7.1	Y.L.	M.J.H.	M.J.H.
		D140342 P7,P8,P9 Revision : B	P8 & P8.1	Y.L.	M.J.H.	M.J.H.
			P9 & P9.1	Y.L.	M.J.H.	M.J.H.
i	2010-04-28	NEW TAG AXLE, O.C. #2007131 (Preliminary vehicle : #A-9902)	P1 & P1.1	Y.L.	M.J.H.	M.J.H.
			P2 & P2.1	Y.L.	M.J.H.	M.J.H.
			P4 & P4.1	Y.L.	M.J.H.	M.J.H.
			P5 & P5.1	Y.L.	M.J.H.	M.J.H.
			P6 & P6.1	Y.L.	M.J.H.	M.J.H.

Pneumatic diagram

PNEUMATIC DIAGRAMS W0-WE BUS SHELL WITH INDEPENDENT SUSP.

PRODUCTION NUMBER	REV	EFF. VEH.	ECN	S.A.V. NUMBER	REV	DESCRIPTION
D140342P1.0	A	#7-9096	2006012	D140342P1.1	E	FULL PNEUMATIC SYSTEM ABS 6 BASIC SYSTEM
	B	#8-9279	2006038 2005002	D140342P1.2	E	ACCESSORIES
	C	#8-9436	2007108	D140342P1.3	E	BRAKES SYSTEM
	D E	#9-9702 #B-9954	UPDATE 2007131	D140342P1.4	E	SUSPENSION
D140342P2.0	A	#7-9096	2006012	D140342P2.1	A	ESP ABS 6 ADVANCED WITH AIR BRAKE ON TRAILER HITCH
	B				B	
	C	#8-9279	2006038 2005002		C	
	D	-----	UPDATE		D	
	E F	#9-9702 #B-9954	2008107 2007131		E F	
D140342P3.0	A	#7-9096	2006012	D140342P3.1	A	FRONT SINGLE SLIDE OUT OPTION (WE ENTERTAINER ONLY)
D140342P4.0	A	#7-9096	2006012	D140342P4.1	A	LEVEL LOW SUSPENSION OPTION
	B	#8-9279	2006038 2005002		B	
	C D	#8-9436 #B-9954	2007108 2007131		C D	
D140342P5.0	A	#8-9279	2006038 2005002	D140342P5.1	A	ESP ABS 6 ADVANCED
	B C	----- #B-9954	UPDATE 2007131		B C	
D140342P6.0	A B	#9-9682 #B-9954	2008048 2007131	D140342P6.1	A B	D13 VOLVO ENGINE WITH HALDEX AIR DRYER
D140342P7.0	A B	#8-9279 #A-9952	2005002 2009088	D140342P7.1	A B	DETROIT ENGINE WITH RETARDER ALLISON TRANSM.
D140342P8.0	A B	#9-9682 #A-9952	2008048 2009088	D140342P8.1	A B	D13 VOLVO ENGINE WITH RETARDER ALLISON TRANSM.

Pneumatic diagram

PNEUMATIC DIAGRAMS W0-WE BUS SHELL WITH INDEPENDENT SUSP.

PRODUCTION NUMBER	REV	EFF. VEH.	ECN	S.A.V. NUMBER	REV	DESCRIPTION
D140342P9.0	A B	#9-9682 #A-9952	2008048 2009088	D140342P9.1	A B	D13 VOLVO ENGINE WITHOUT RETARDER ALLISON TRANSM.
D140342SP1.0	A	#8-9279	2006012	D140342SP1.1	A	DIFFERENTIAL AIR LOCK OPTION

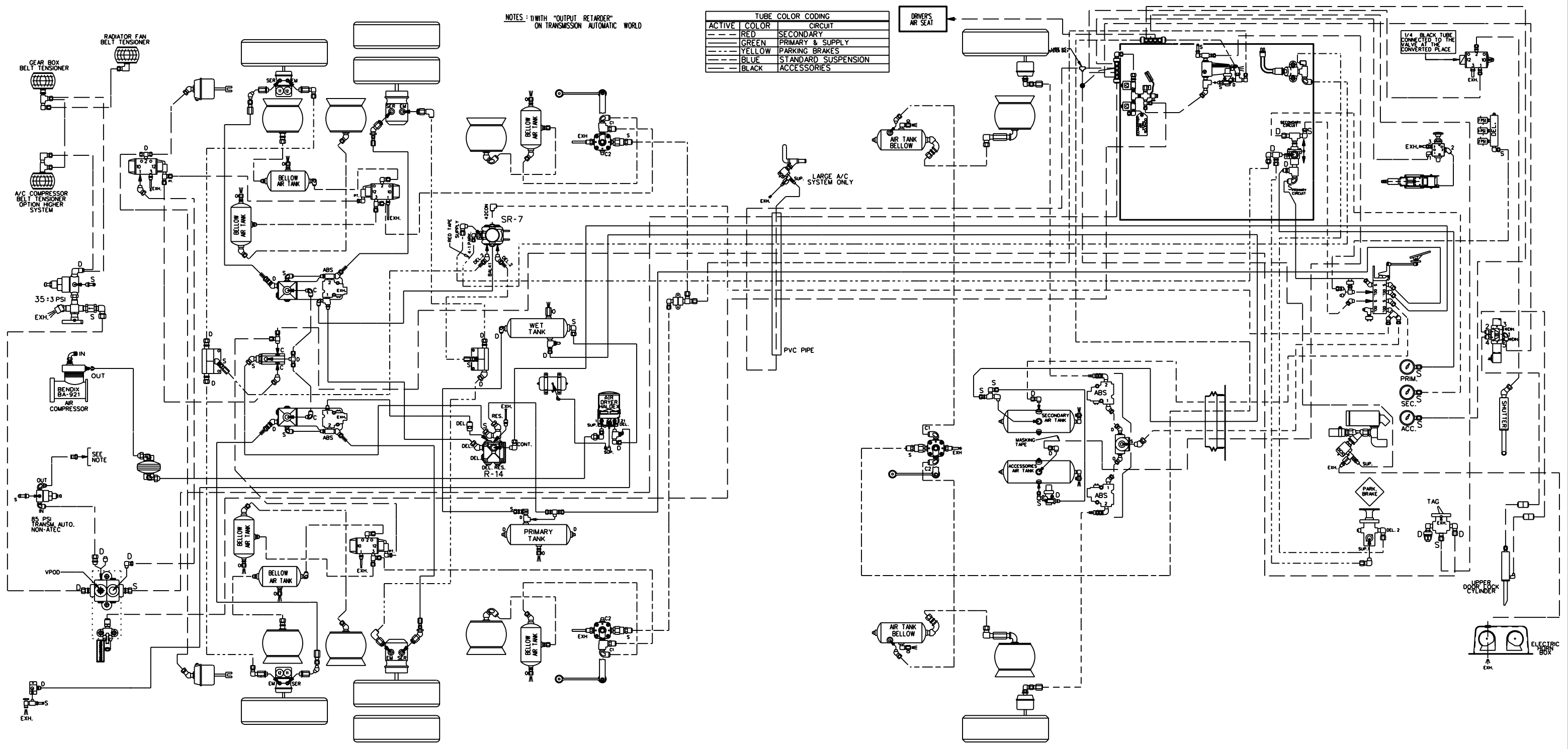

PREVOST®

DESCRIPTION:

BUS SHELL WE & WO 2006
WITH FULL PNEUMATIC SYSTEM

EFF. W/ VEH : #7-9096
Preliminary #7-9010
DATE: 2006/09
REV.: A

PAGE:

D140342 P1.1

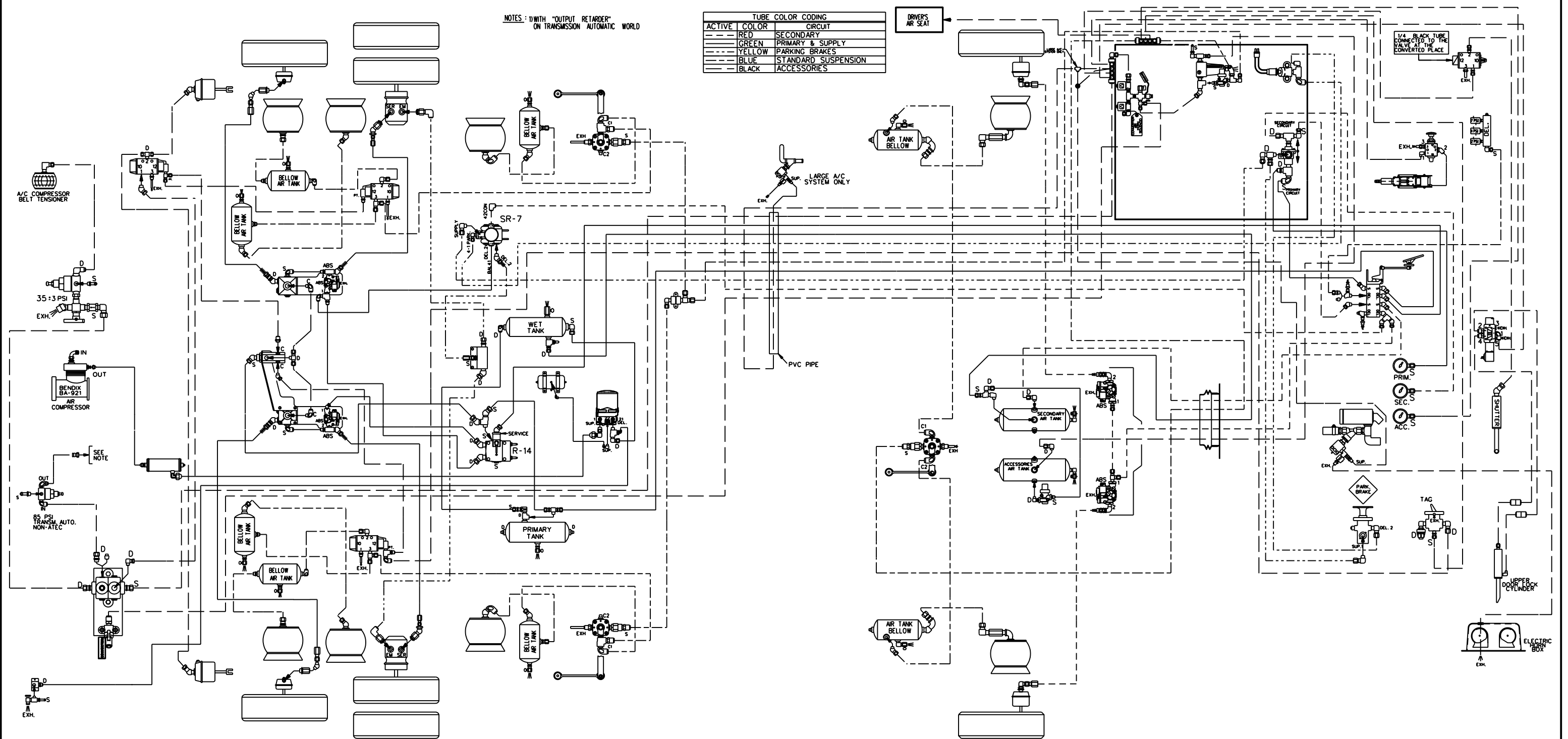

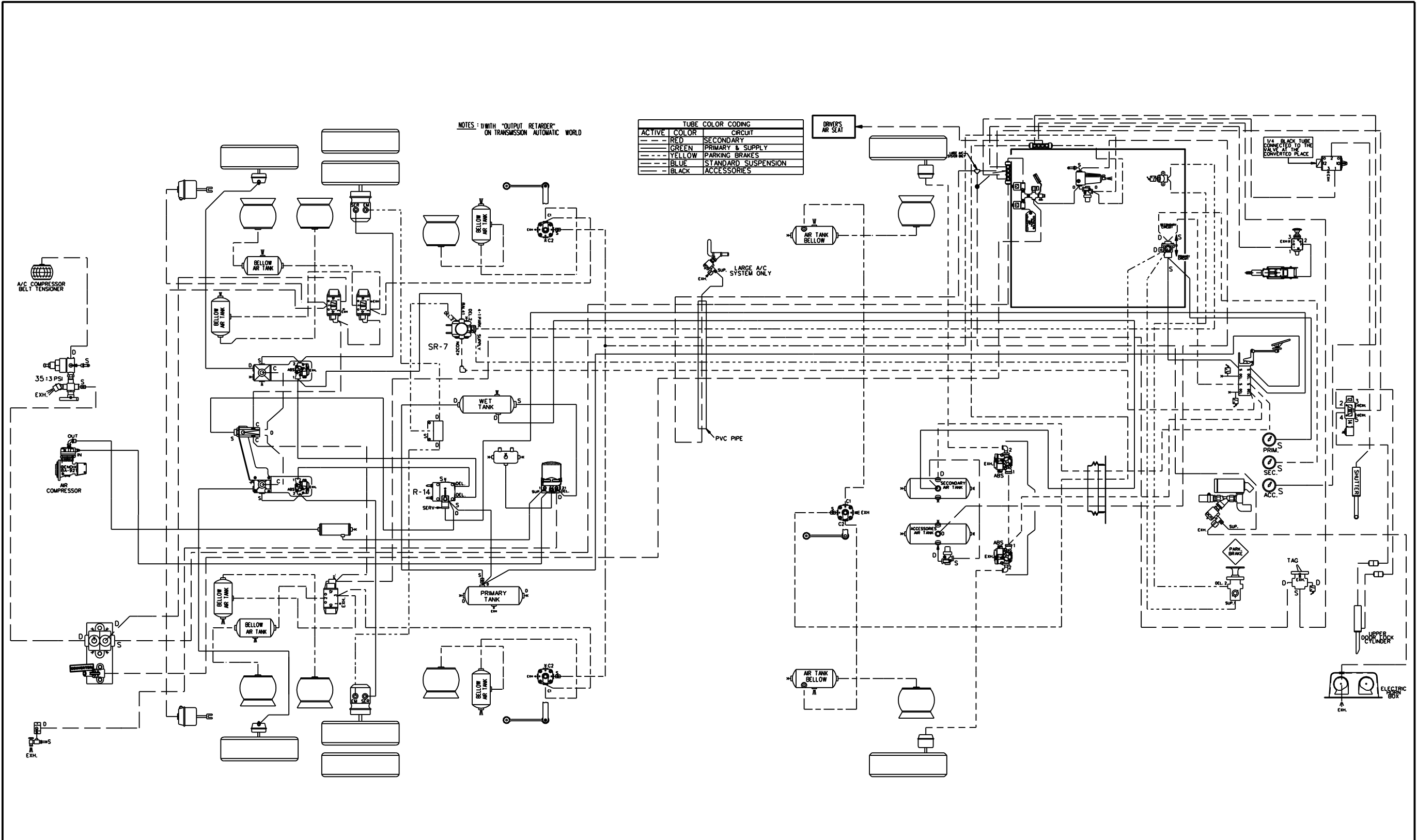

ACTIVE	COLOR	CIRCUIT
---	RED	SECONDARY
---	GREEN	PRIMARY & SUPPLY
---	YELLOW	PARKING BRAKES
---	BLUE	STANDARD SUSPENSION
---	BLACK	ACCESSORIES

NOTES : WITH "OUTPUT RETARDER"
ON TRANSMISSION AUTOMATIC WORLD

LARGE A/C SYSTEM ONLY

PVC PIPE

PREVOST®

DESCRIPTION:

BUS SHELL WE
WITH FULL PNEUMATIC SYSTEM

EFF. W/ VEH : *B-9954...

PAGE:

D140342 P1.1

DATE: 2010/04

REV.: E

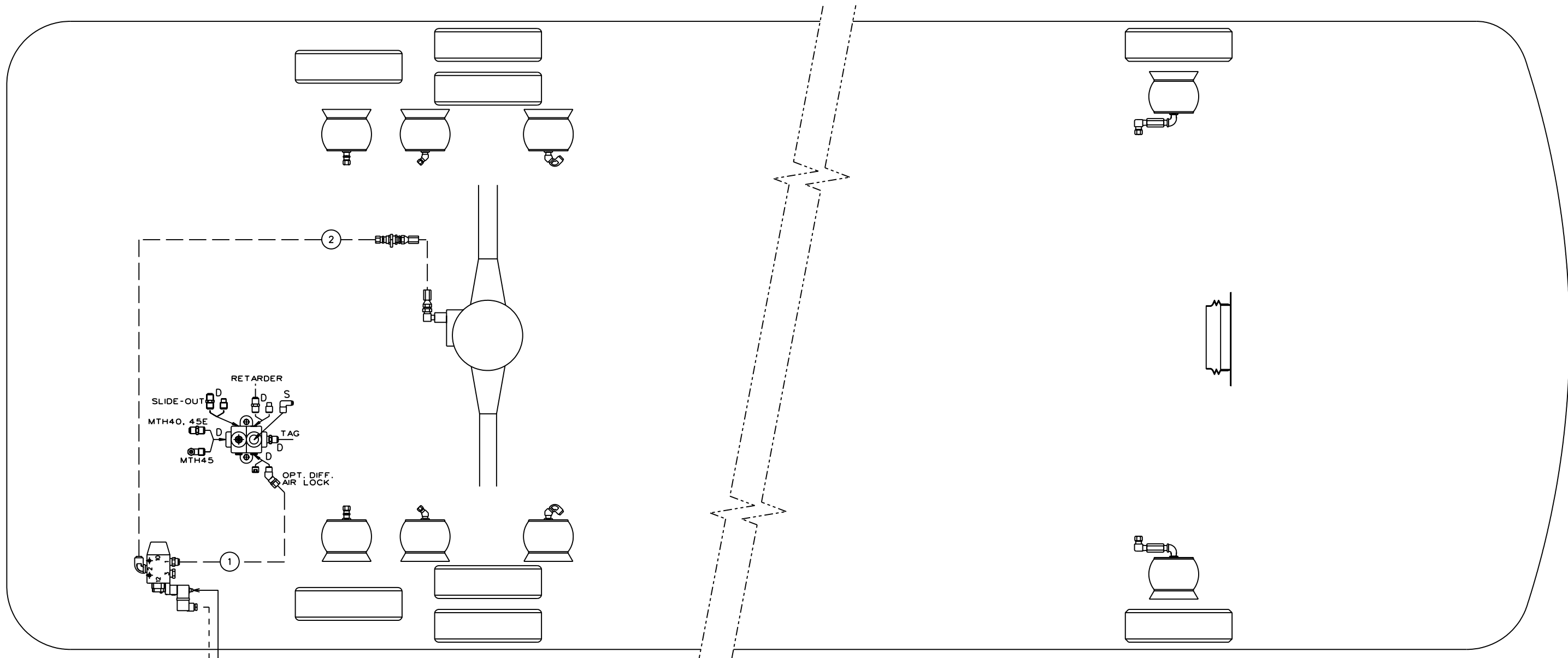

SOLENOID ENERGISED = DIFF. LOCK ACTIVE

CONNECTOR *CDL FROM HARNESS FRONT JCT. BOX TO REAR JCT. BOX

BALLOON	PIPE
*1	1/4" O.D. BLACK
*2	3/8" O.D. BLACK

TUBE COLOR CODING		
LINE TYPE	COLOR	CIRCUIT
---	BLACK	ACCESSORIES

PREVOST®

DESCRIPTION:

BUS SHELL WE & WO 2006 WITH OPTION DIFFERENTIAL AIR LOCK

EFF. W/VEH : TO FOLLOW
 DATE: 2006/09
 REV.: A

PAGE: D140342SP1.1

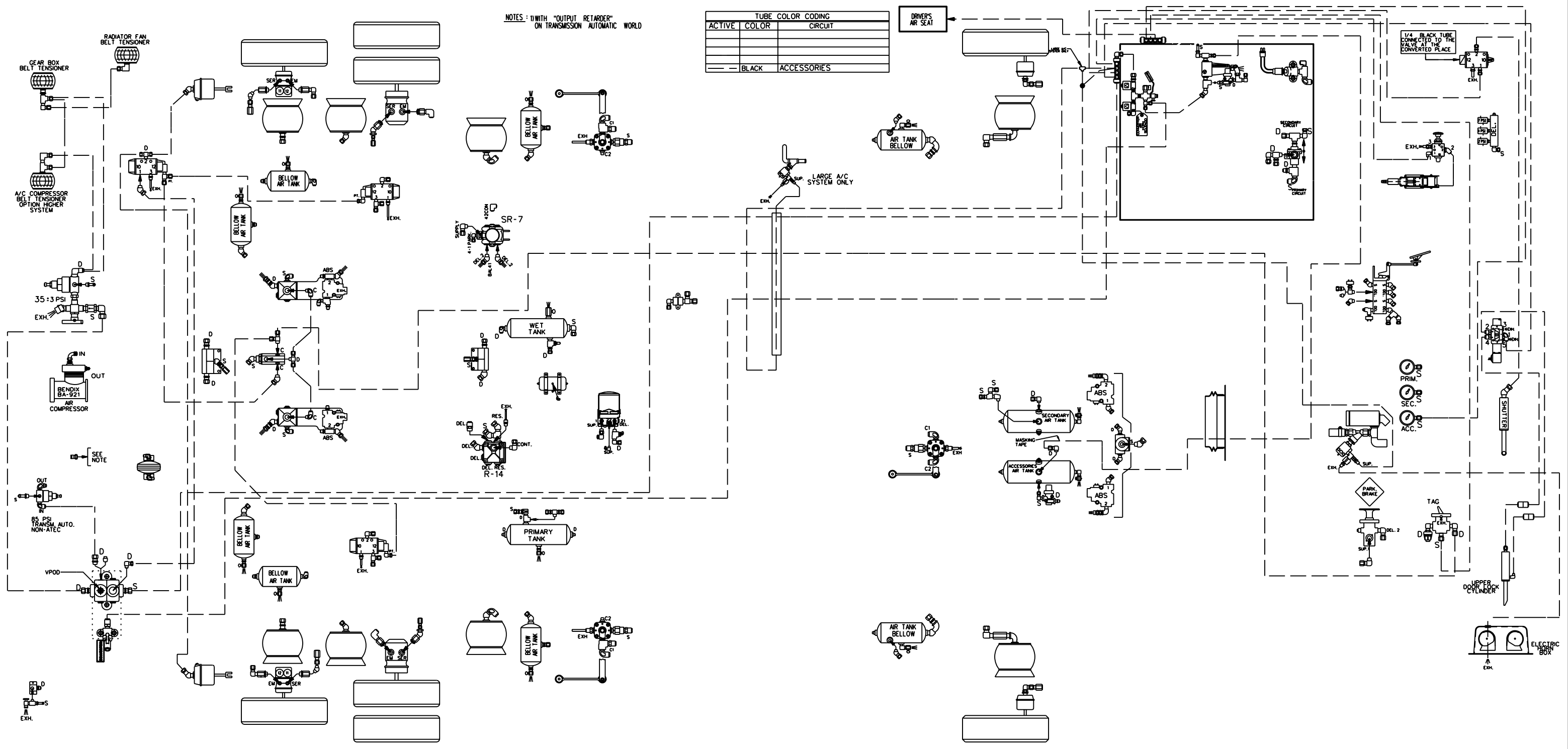

PREVOST

DESCRIPTION:

BUS SHELL WE & WO 2006
ACCESSORIES

EFF. W/ VEH : #7-9096
Preliminary #7-9010
DATE: 2006/09 REV.: A

PAGE:
D140342P1.2

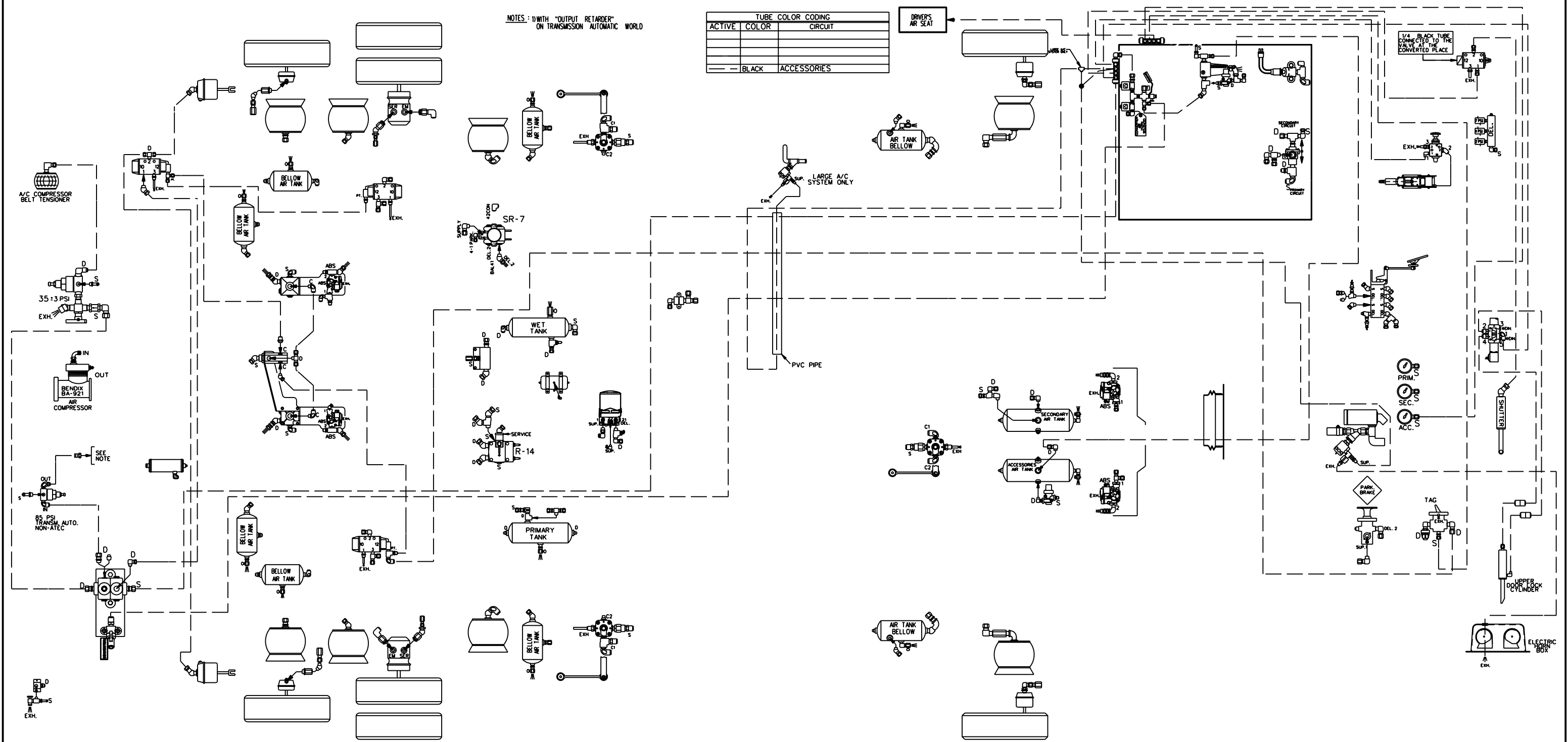

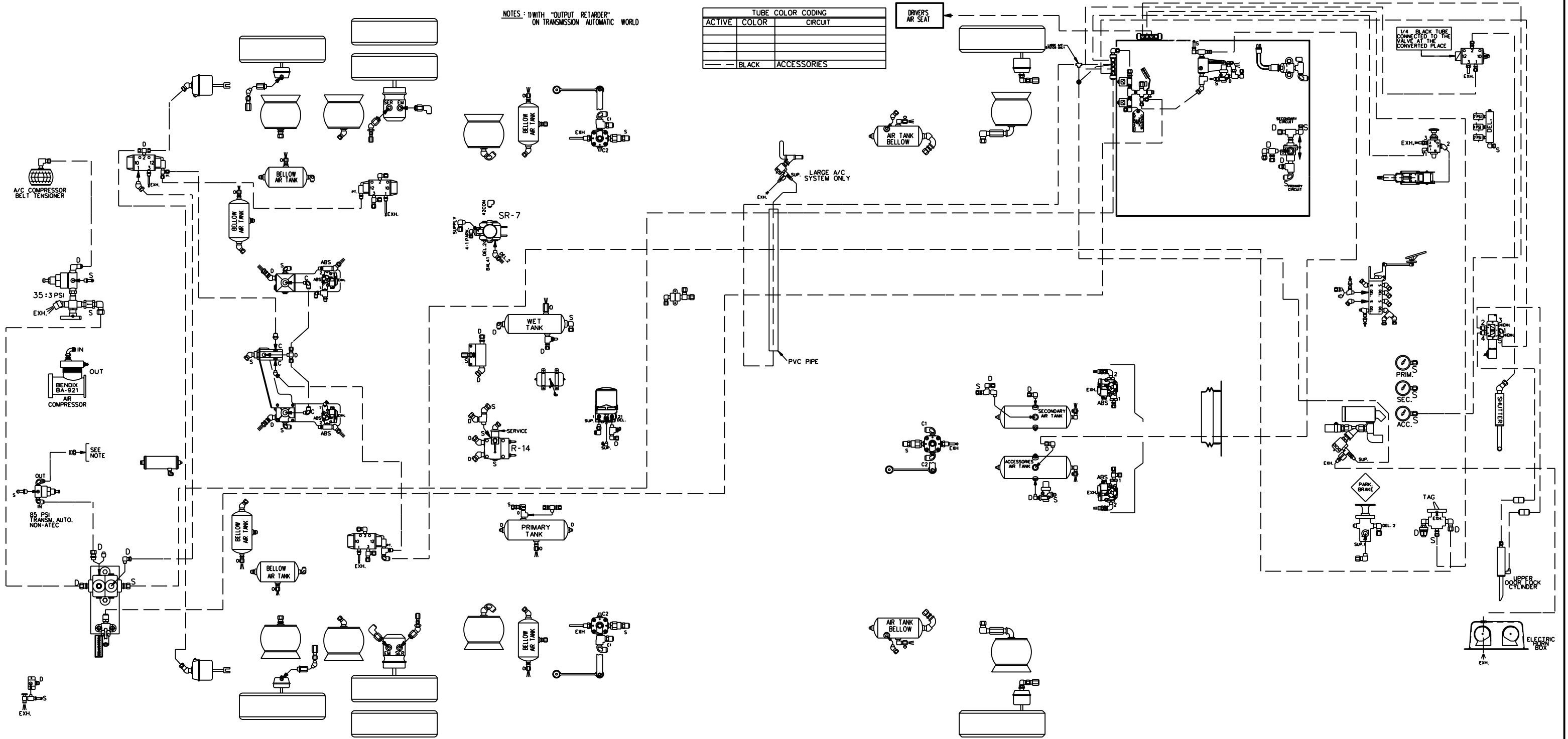

PREVOST®

DESCRIPTION:

BUS SHELL WE & WO 2006
ACCESSORIES

EFF. W/ VEH : #8-9436

PAGE:

DATE: 2008/04

REV.: C

D140342 P1.2

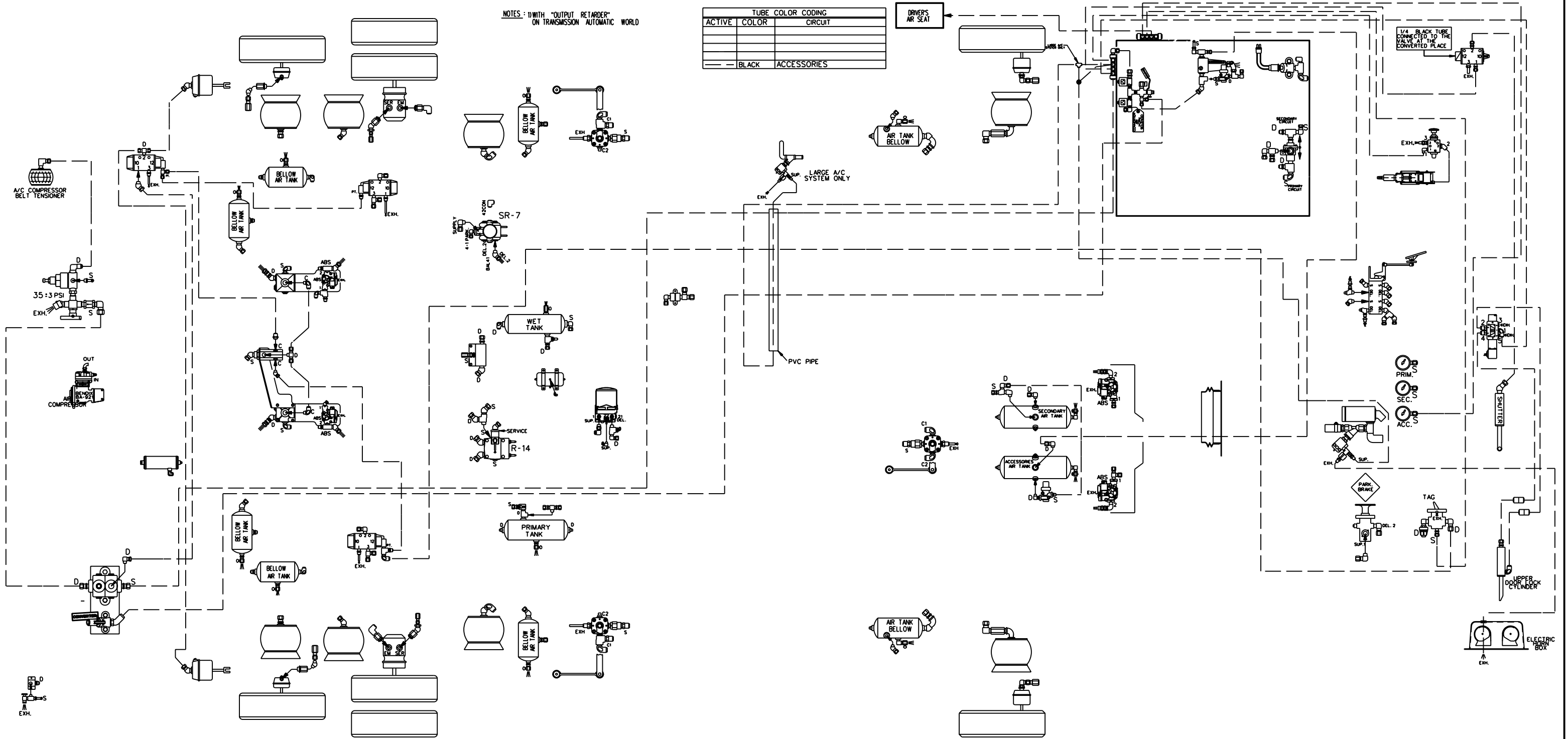

PREVOST®

DESCRIPTION:

BUS SHELL WE & WO 2006
ACCESSORIES

EFF. W/ VEH : #9-9702...

PAGE:

DATE: 2008/12

REV.: D

D140342 P1.2

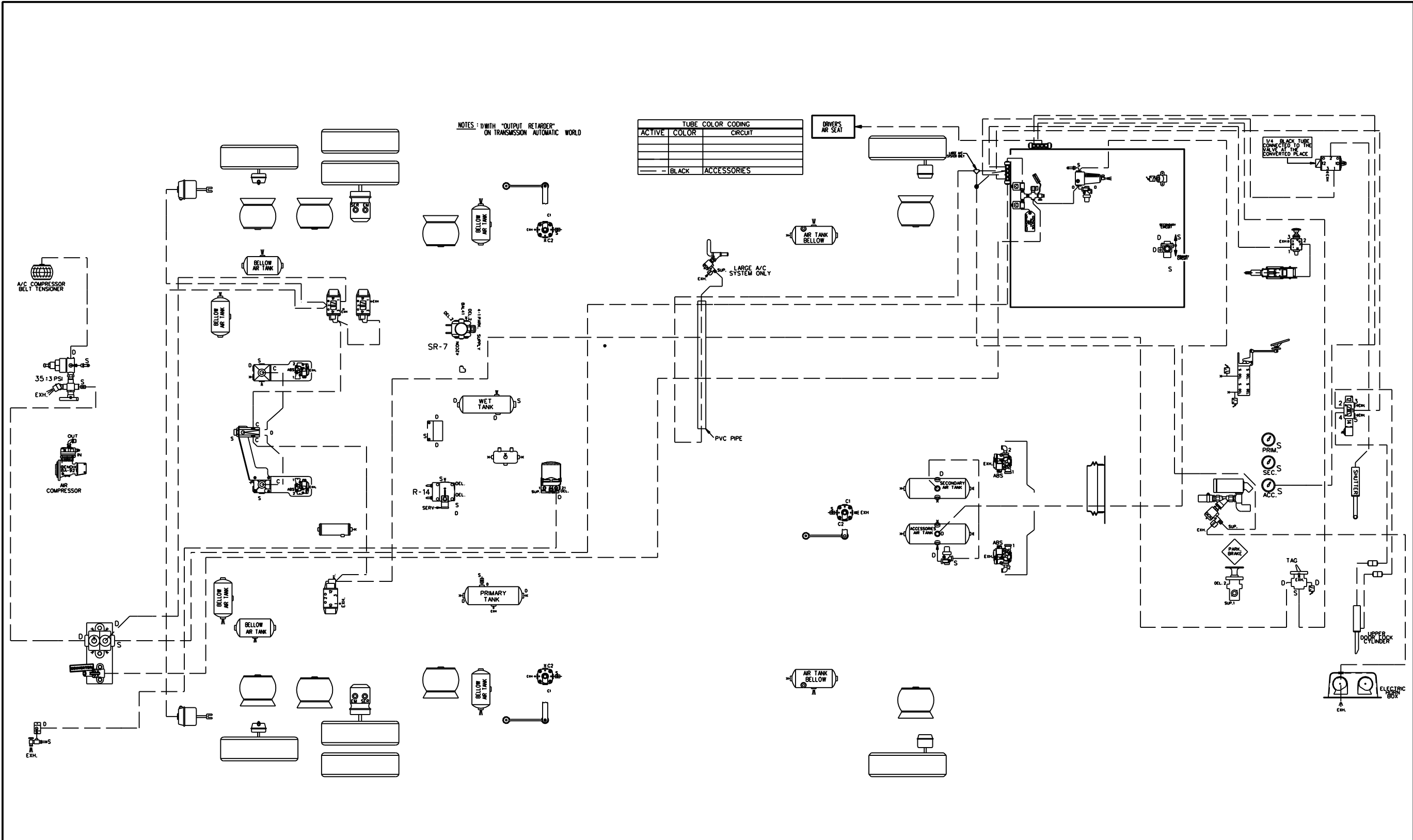

NOTES: 1) WITH "OUTPUT RETARDER" ON TRANSMISSION AUTOMATIC WORLD

ACTIVE	TUBE COLOR	CODING	CIRCUIT
---	RED	---	SECONDARY
---	GREEN	---	PRIMARY & SUPPLY
---	YELLOW	---	PARKING BRAKES

DRIVERS AIR SEAT

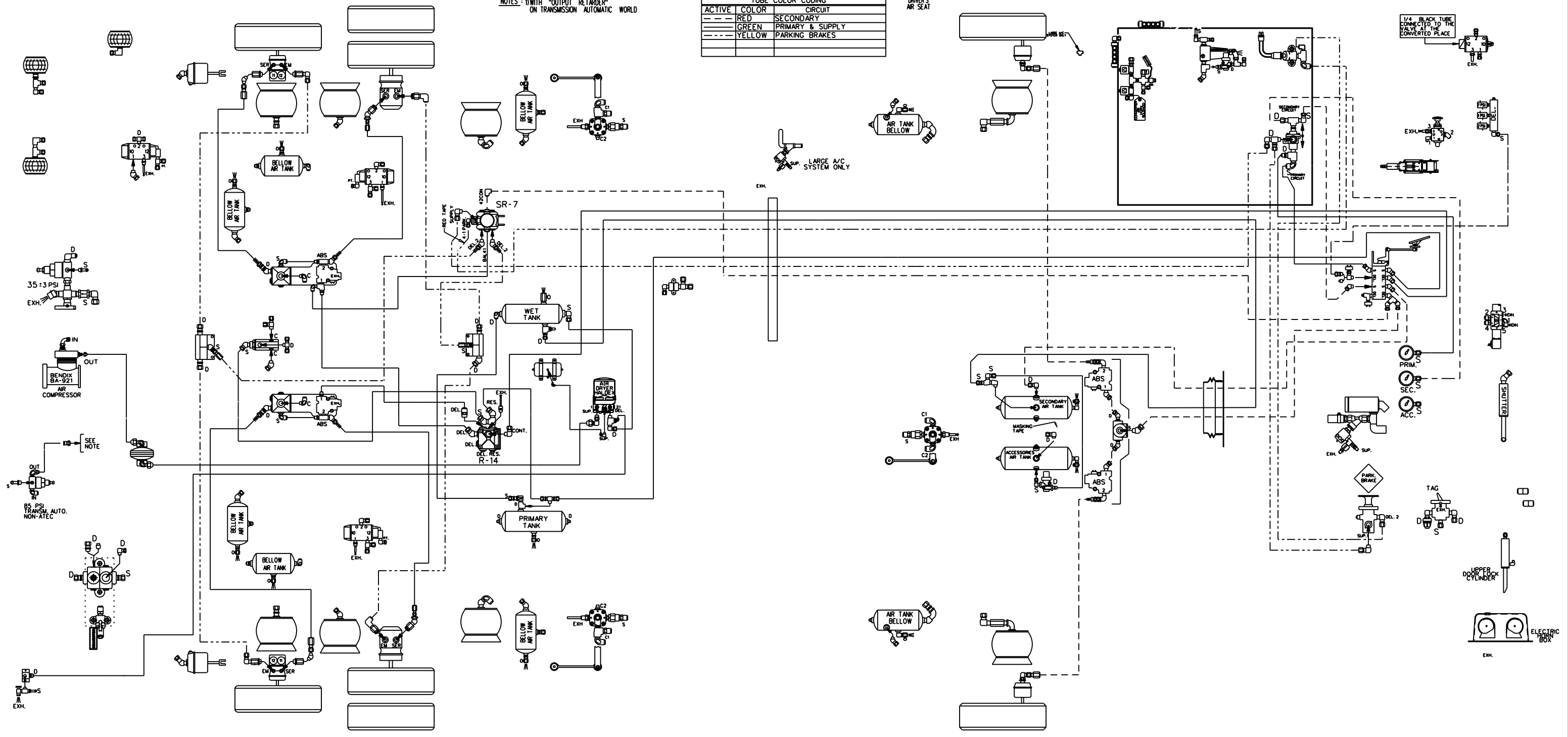

PREVOST

DESCRIPTION:

BUS SHELL WE & WO 2006
BRAKES SYSTEM

EFF. W/ VEH : #7-9096
Preliminary #7-9010
DATE: 2006/09 REV.: A

PAGE:
D140342 P1.3

NOTES: 1) WITH "OUTPUT RETARDER" ON TRANSMISSION AUTOMATIC WORLD

TUBE COLOR CODING		
ACTIVE	COLOR	CIRCUIT
---	RED	SECONDARY
---	GREEN	PRIMARY & SUPPLY
---	YELLOW	PARKING BRAKES

DRIVERS AIR SEAT

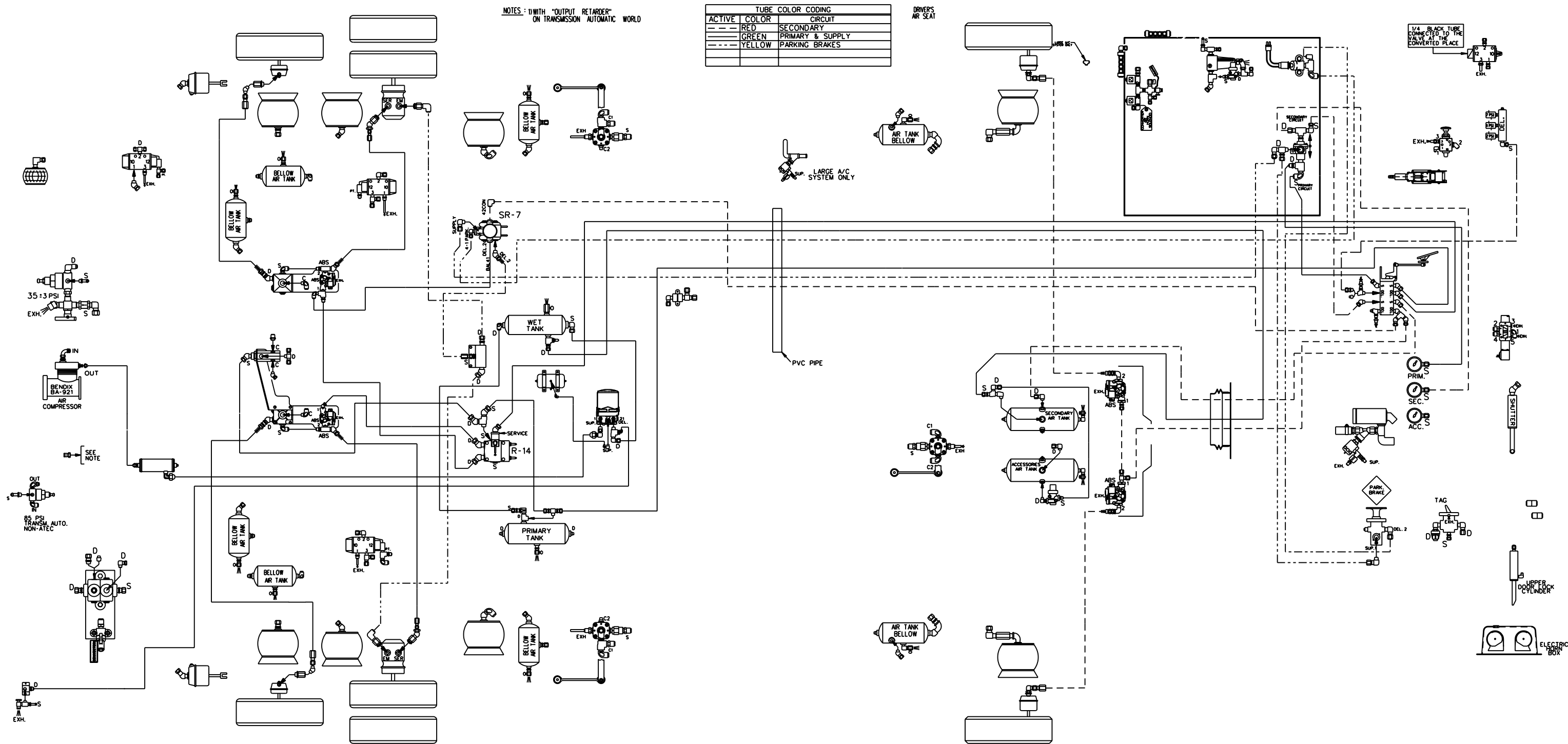

PREVOST

DESCRIPTION:

BUS SHELL WE & WO 2006
BRAKES SYSTEM

EFF. W/ VEH : #8-9279

PAGE:

DATE: 2007/06

REV.: B

D140342 P1.3

NOTES : 1) WITH "OUTPUT RETARDER"
ON TRANSMISSION AUTOMATIC WORLD

TUBE COLOR CODING	
ACTIVE	COLOR
---	RED
---	GREEN
---	YELLOW

DRIVERS
AIR SEAT

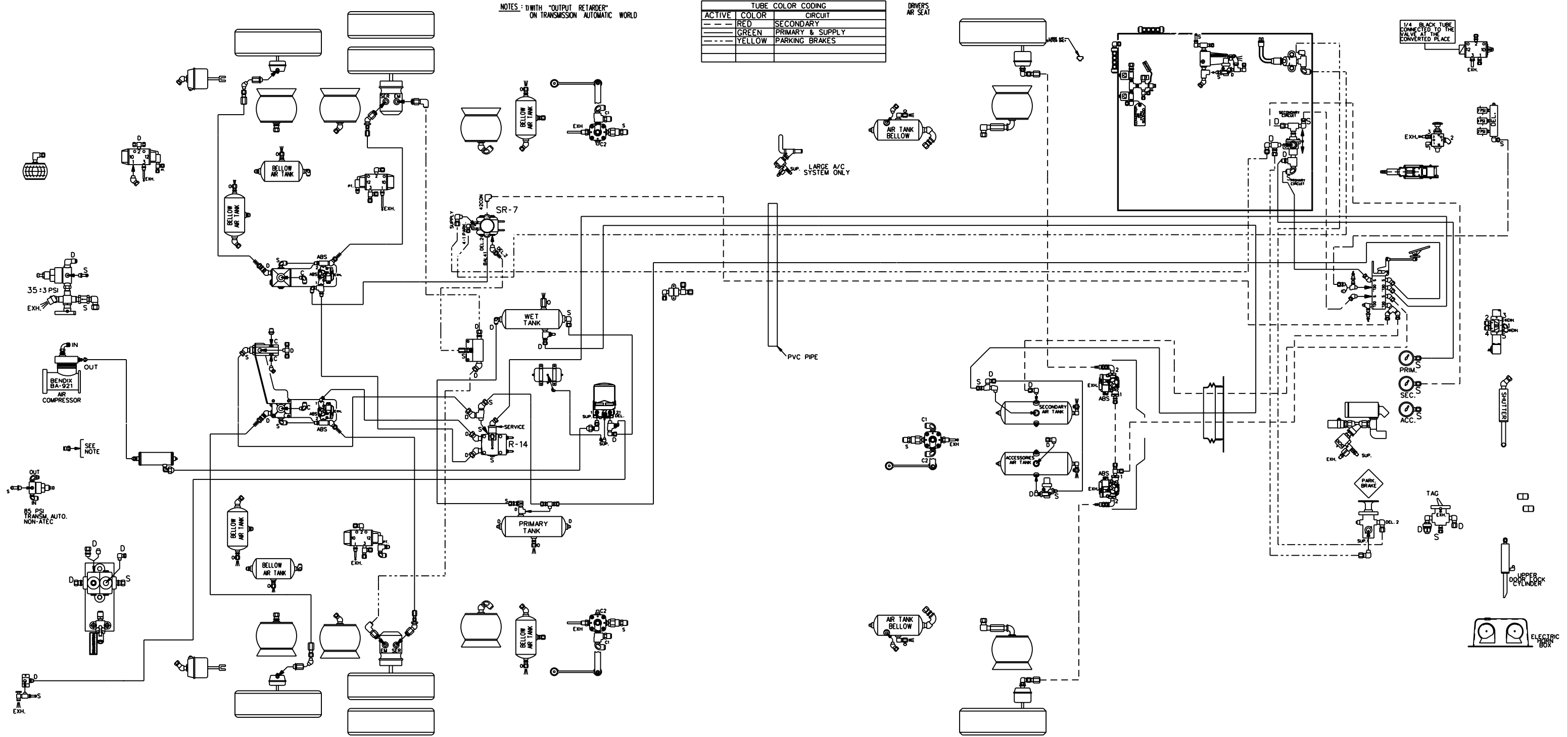

PREVOST®

DESCRIPTION: BUS SHELL WE & WO 2006
BRAKES SYSTEM

EFF. W/ VEH : #8-9436
DATE: 2008/04 REV.: C

PAGE: D140342 P1.3

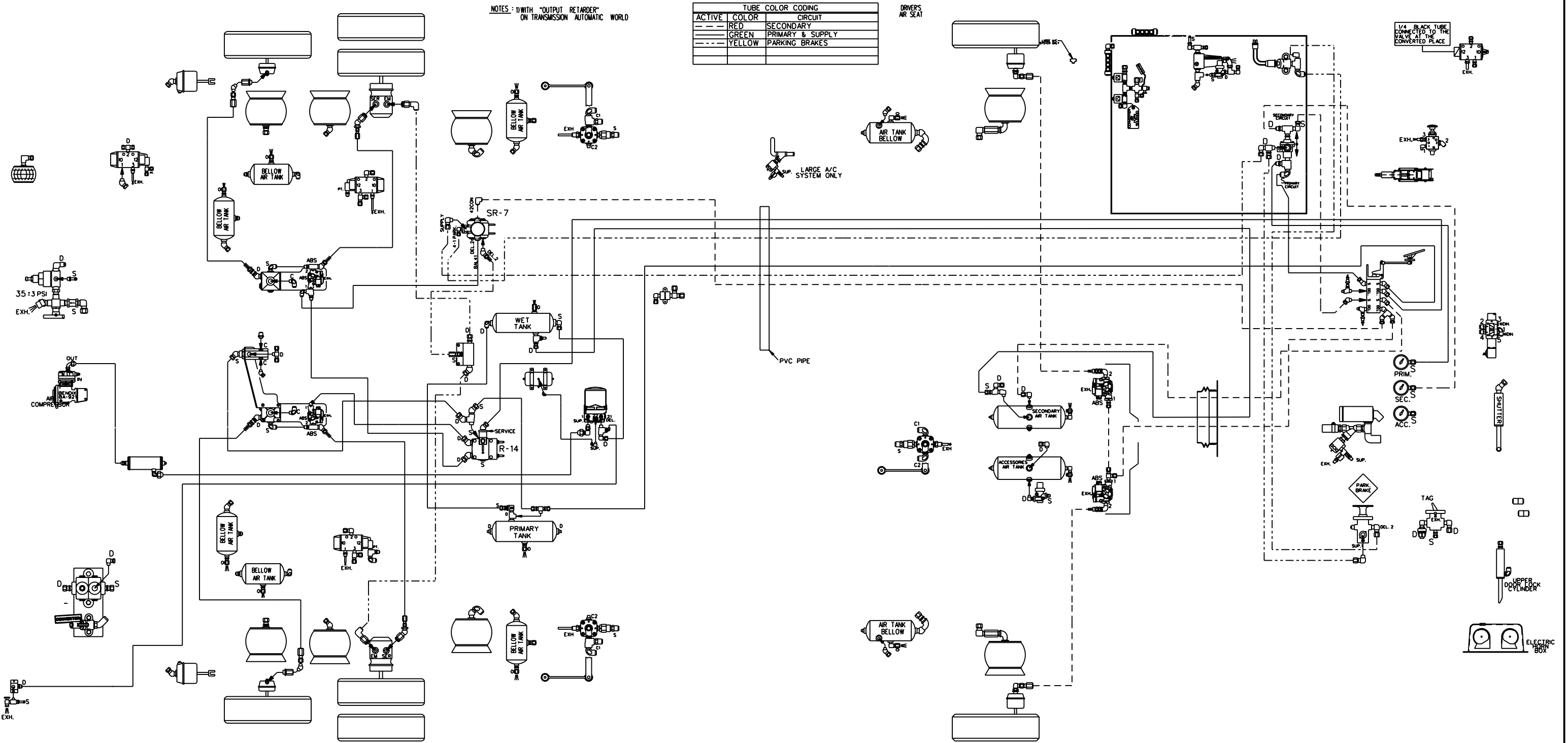

PREVOST

DESCRIPTION:

BUS SHELL WE & WO 2006
BRAKES SYSTEM

EFF. W/ VEH : #9-9702...

PAGE:

DATE: 2008/12

REV.: D

D140342 P1.3

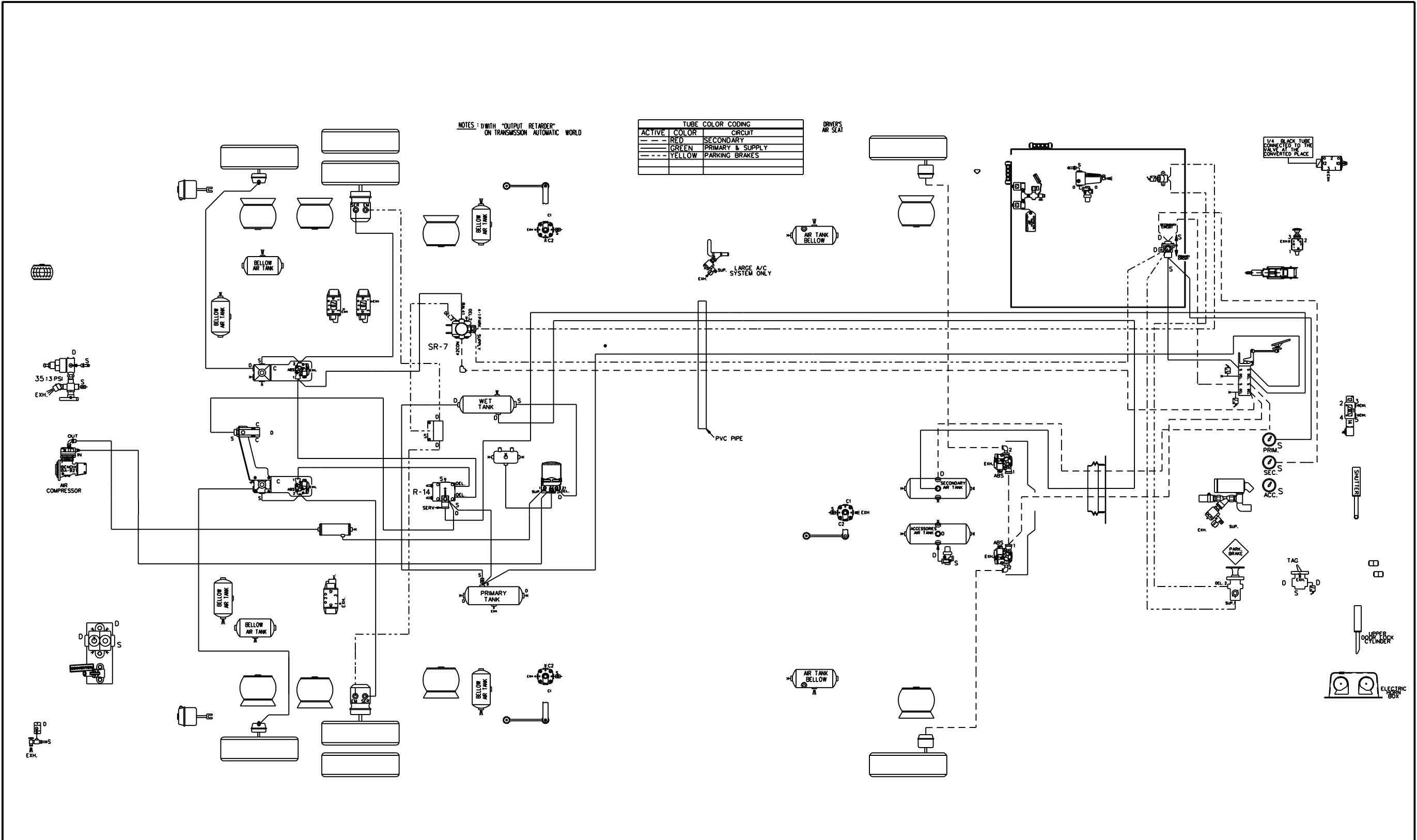

TUBE COLOR CODING		
ACTIVE	COLOR	CIRCUIT
---	RED	SECONDARY
---	GREEN	PRIMARY & SUPPLY
---	YELLOW	PARKING BRAKES

NOTES : WITH "OUTPUT RETARDER" ON TRANSMISSION AUTOMATIC WORLD

LARGE A/C SYSTEM ONLY

1/4" BLACK TUBE CONNECTED TO THE CONVERTED PLACE

PREVOST.

DESCRIPTION: BUS SHELL WE BRAKES SYSTEM

EFF. W/ VEH : *B-9954...
 DATE: 2010/04 REV.: E

PAGE: D140342 P1.3

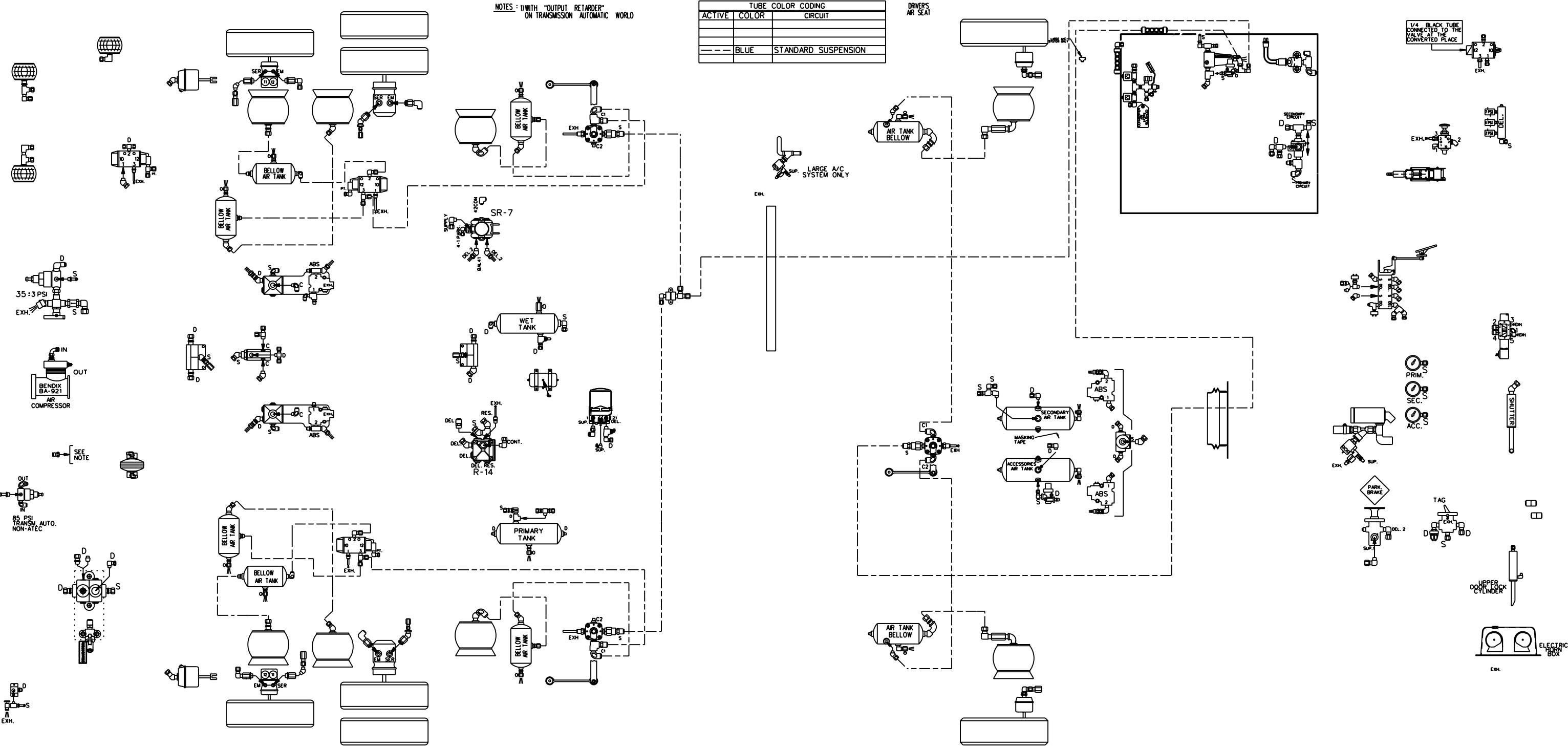

PREVOST

DESCRIPTION:

BUS SHELL WE & WO 2006
STANDARD SUSPENSION

EFF. W/ VEH : #7-9096
Preliminary #7-9010
DATE: 2006/09 REV.: A

PAGE:
D140342 P1.4

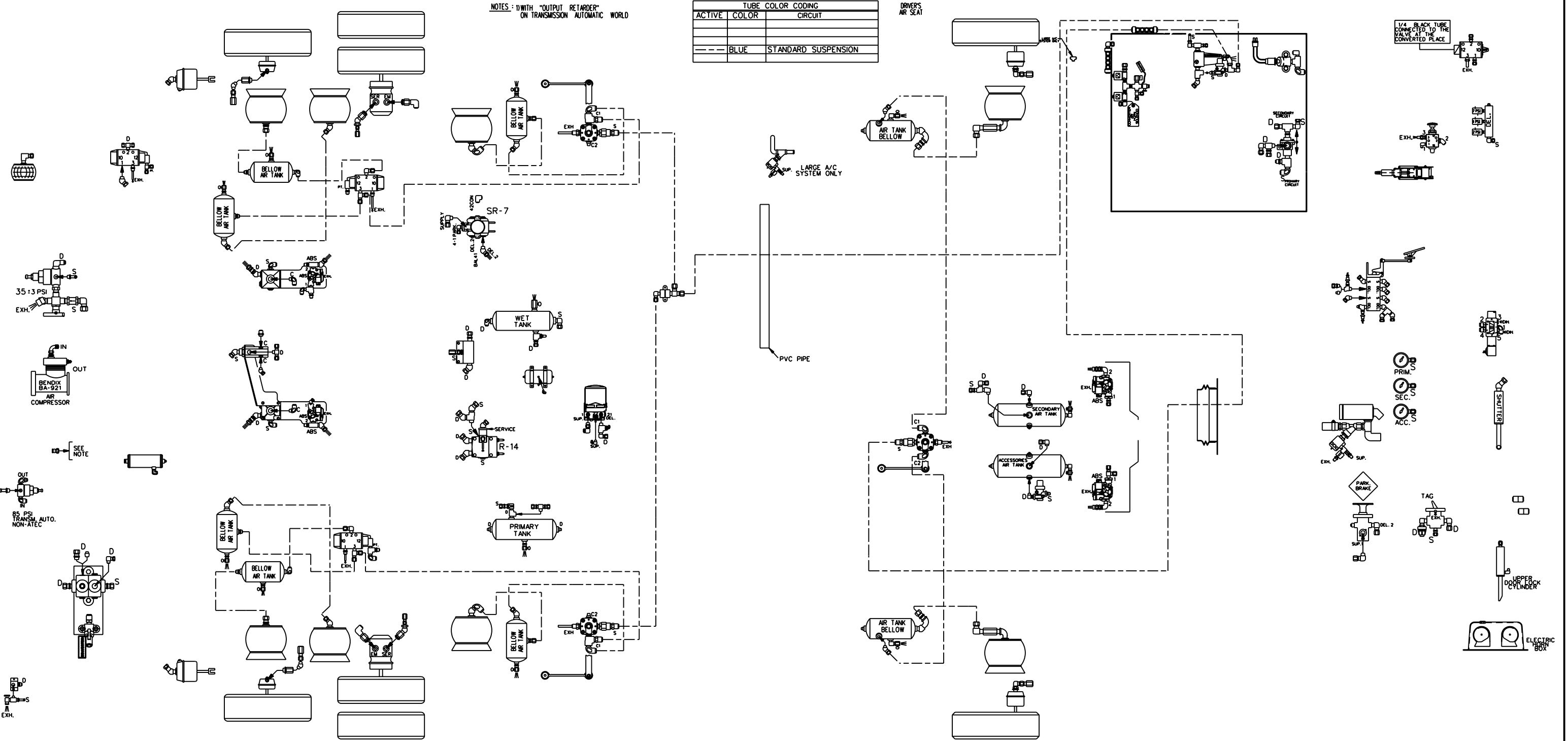

PREVOST®

DESCRIPTION:

BUS SHELL WE & WO 2006
STANDARD SUSPENSION

EFF. W/ VEH : #8-9436

PAGE:

DATE: 2008/04

REV.: C

D140342 P1.4

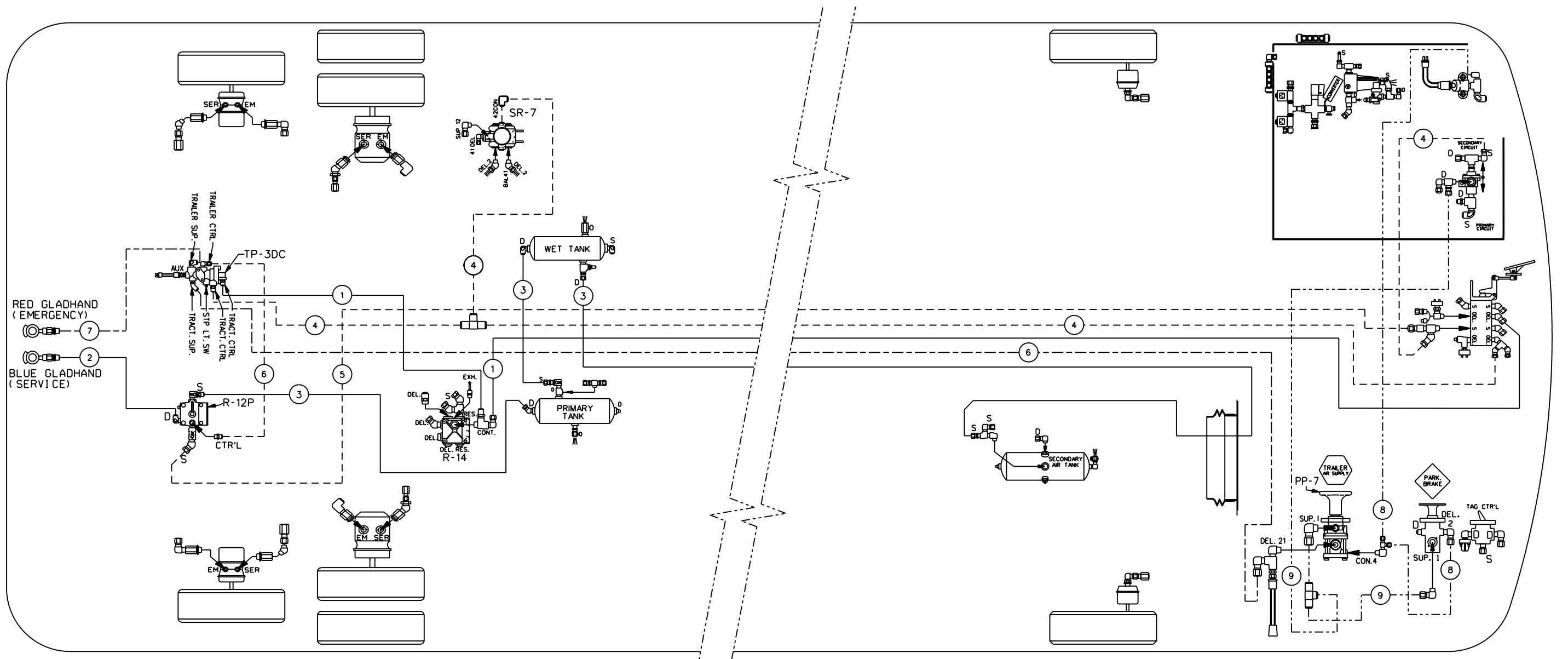

TUBE COLOR CODING	
ACTIVE COLOR	CIRCUIT
---	RED SECONDARY
---	GREEN PRIMARY & SUPPLY
---	YELLOW PARKING BRAKE
---	BROWN TRAILER

BALLOON	PIPE
#1	3/8" O.D. GREEN
#2	1/2" O.D. GREEN
#3	5/8" O.D. GREEN
#4	3/8" O.D. RED
#5	5/8" O.D. RED
#6	3/8" O.D. BROWN
#7	1/2" O.D. BROWN
#8	1/4" O.D. YELLOW
#9	3/8" O.D. YELLOW

PREVOST®

DESCRIPTION:

BUS SHELL WE & WO 2006
WITH OPTION TRAILER HITCH AIR BRAKE

EFF. W/VEH : #7-9102...

PAGE:

D140342 P2.1

DATE: 2006/09

REV.: A

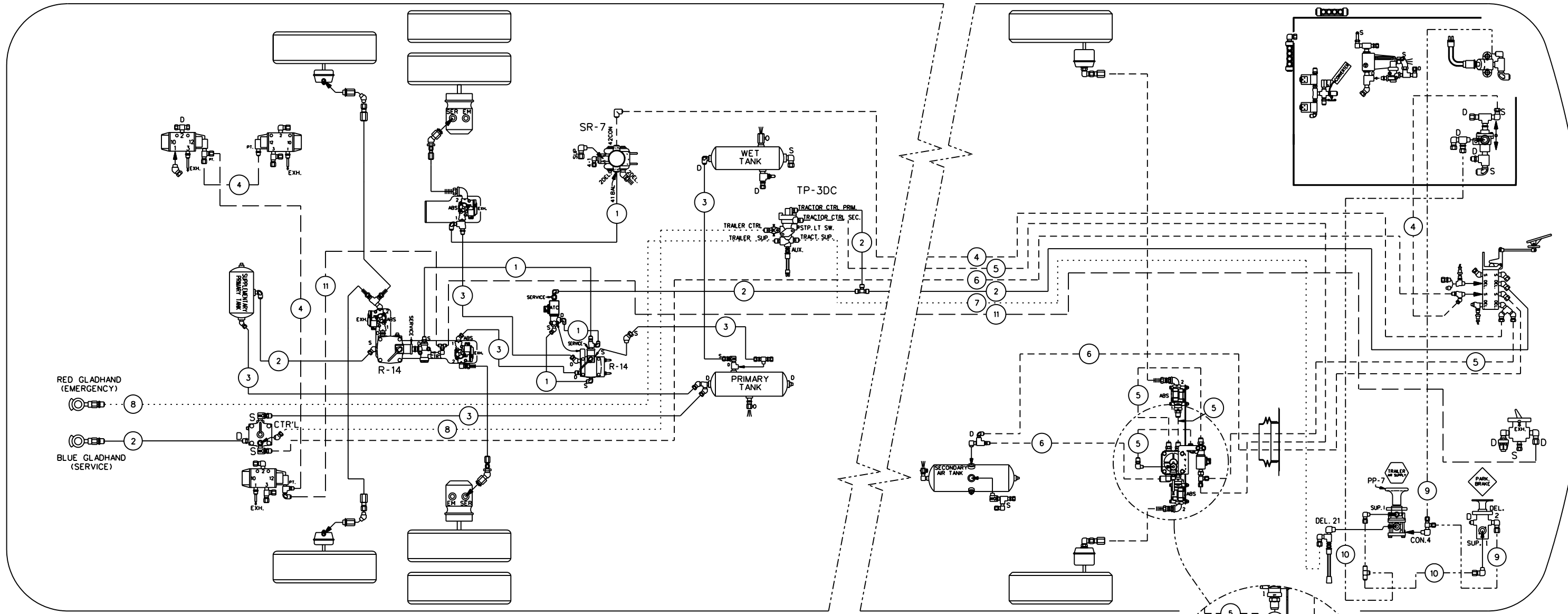

RED GLADHAND
(EMERGENCY)

BLUE GLADHAND
(SERVICE)

BALLOON	PIPE
•1	3/8" O.D. GREEN
•2	1/2" O.D. GREEN
•3	5/8" O.D. GREEN
•4	3/8" O.D. RED
•5	1/2" O.D. RED
•6	5/8" O.D. RED
•7	3/8" O.D. BROWN
•8	1/2" O.D. BROWN
•9	1/4" O.D. YELLOW
•10	3/8" O.D. YELLOW
•11	1/4" O.D. BLACK
•12	3/8" O.D. BLACK

TUBE COLOR CODING	
ACTIVE COLOR	CIRCUIT
---	RED SECONDARY
---	GREEN PRIMARY & SUPPLY
---	YELLOW PARKING BRAKE
---	BROWN TRAILER
---	BLACK ACCESSORIES

PREVOST®

DESCRIPTION:
 BUS SHELL WE & WO 2006
 WITH OPTION TRAILER HITCH AIR BRAKE
 WITH ESP BRAKE SYSTEM

EFF. W/VEH : #9-9702...
 DATE: 2008/12 REV.: E

PAGE:
 D140342 P2.1

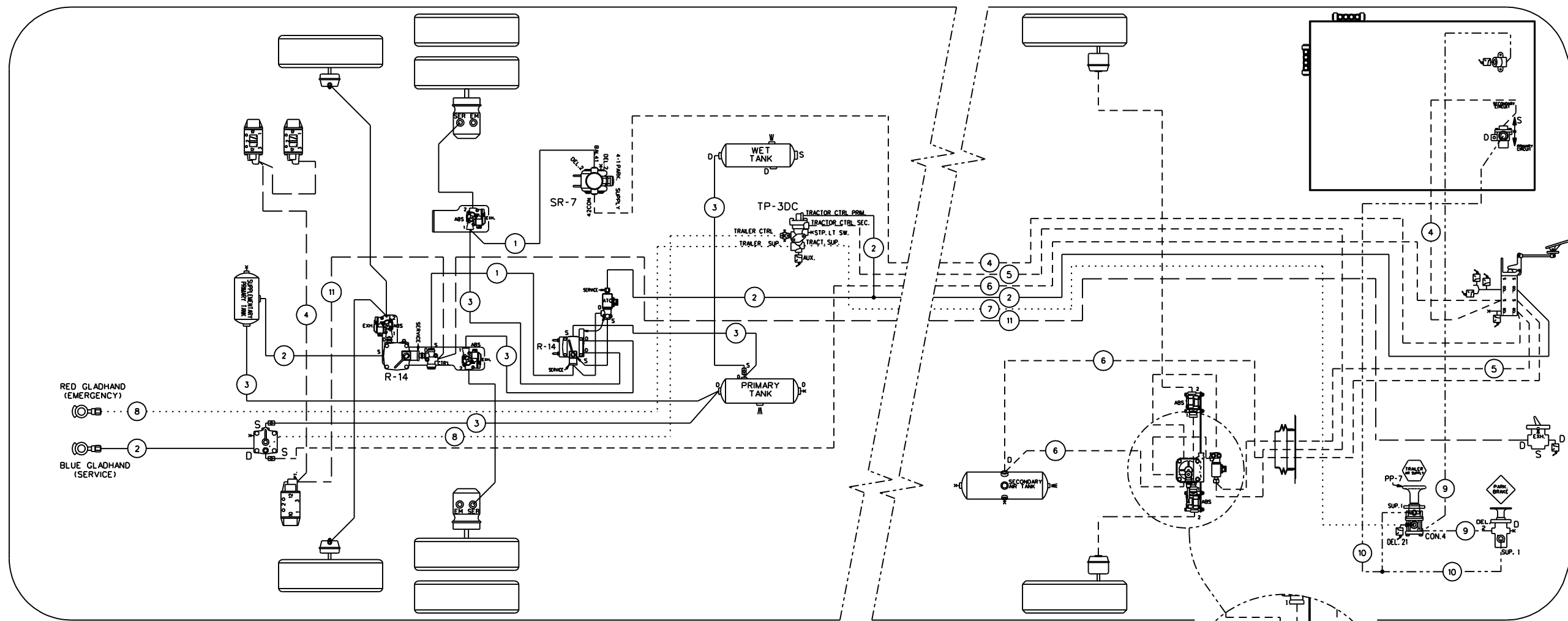

RED GLADHAND
(EMERGENCY)

BLUE GLADHAND
(SERVICE)

BALLOON	PIPE
•1	3/8" O.D. GREEN
•2	1/2" O.D. GREEN
•3	3/8" O.D. GREEN
•4	3/8" O.D. RED
•5	1/2" O.D. RED
•6	3/8" O.D. RED
•7	3/8" O.D. BROWN
•8	1/2" O.D. BROWN
•9	1/4" O.D. YELLOW
•10	3/8" O.D. YELLOW
•11	1/4" O.D. BLACK
•12	3/8" O.D. BLACK

TUBE COLOR CODING	
ACTIVE COLOR	CIRCUIT
---	RED SECONDARY
---	GREEN PRIMARY & SUPPLY
---	YELLOW PARKING BRAKE
---	BROWN TRAILER
---	BLACK ACCESSORIES

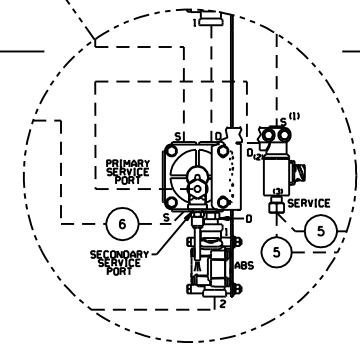

PREVOST®

DESCRIPTION:
 BUS SHELL WE 2006
 WITH OPTION TRAILER HITCH AIR BRAKE
 WITH ESP BRAKE SYSTEM

EFF. W/VEH : #B-9954...
 DATE: 2010/04 REV.: F

PAGE:
 D140342 P2.1

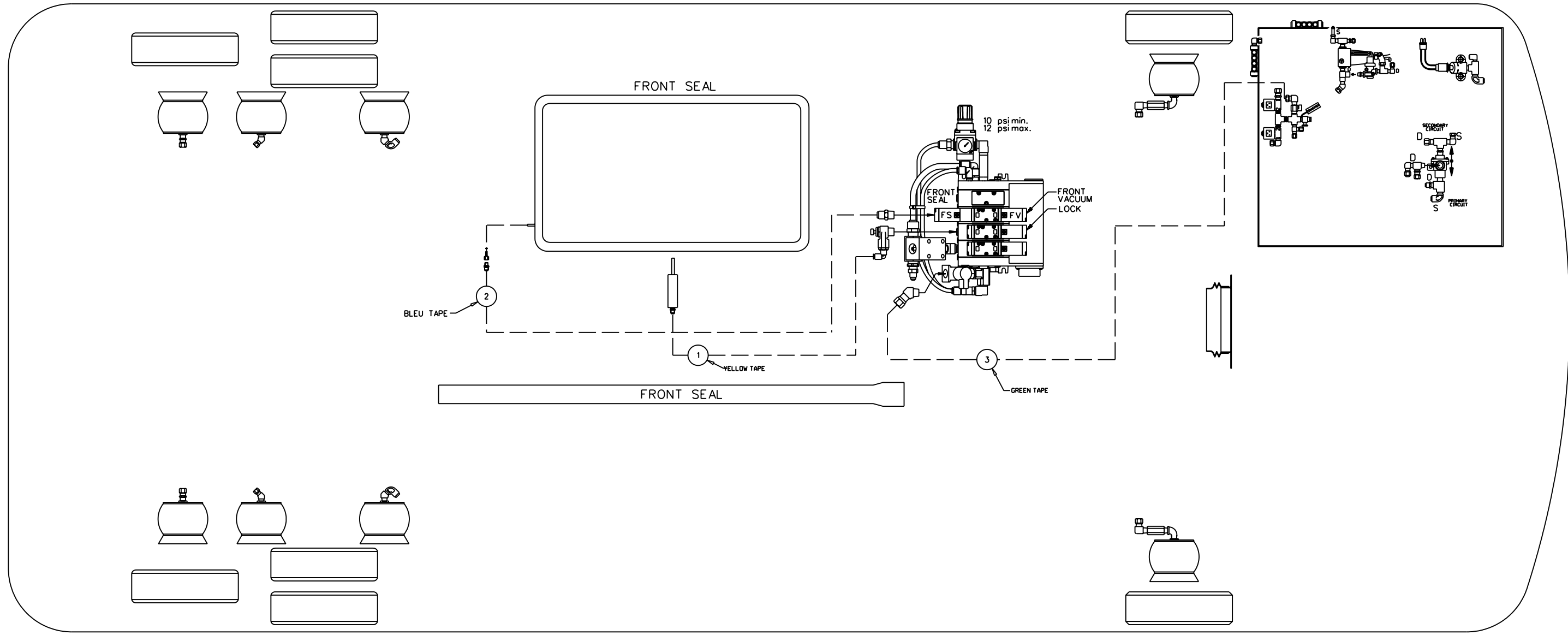

BALLOON	PIPE
*1	1/8" O.D. BLACK
*2	3/8" O.D. BLACK
*3	1/2" O.D. BLACK

TUBE COLOR CODING		
LINE TYPE	COLOR	CIRCUIT
---	BLACK	ACCESSOIRES

PREVOST®

DESCRIPTION:

BUS SHELL WE & WO 2006
WITH OPTION SIMPLE SLIDE-OUT

EFF. W/VEH : *7-9096

Preliminary *7-9010

DATE:
2006/09

REV.:
A

PAGE:

D140342 P3.1

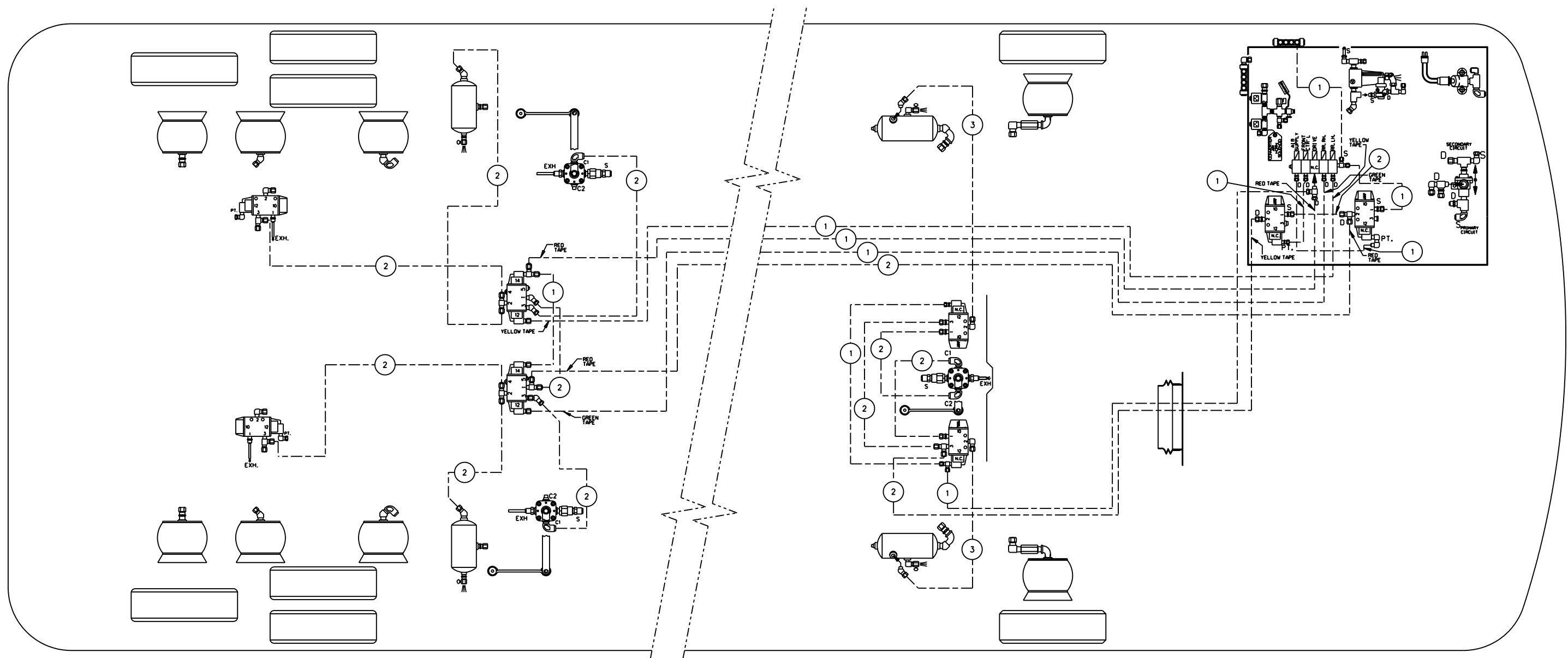

BALLOON	PIPE
#1	1/4" O.D. BLACK
#2	3/8" O.D. BLUE
#3	1/2" O.D. BLUE

TUBE COLOR CODING		
LINE TYPE	COLOR	CIRCUIT
---	BLUE	SUSPENSION
---	BLACK	SUSPENSION

PREVOST®

DESCRIPTION:

BUS SHELL WE & WO 2006
WITH OPTION LEVEL LOW

EFF. W/VEH : #7-9096...

Preliminary #7-9010

DATE:
2006/09

REV.:
A

PAGE:

D140342 P4.1

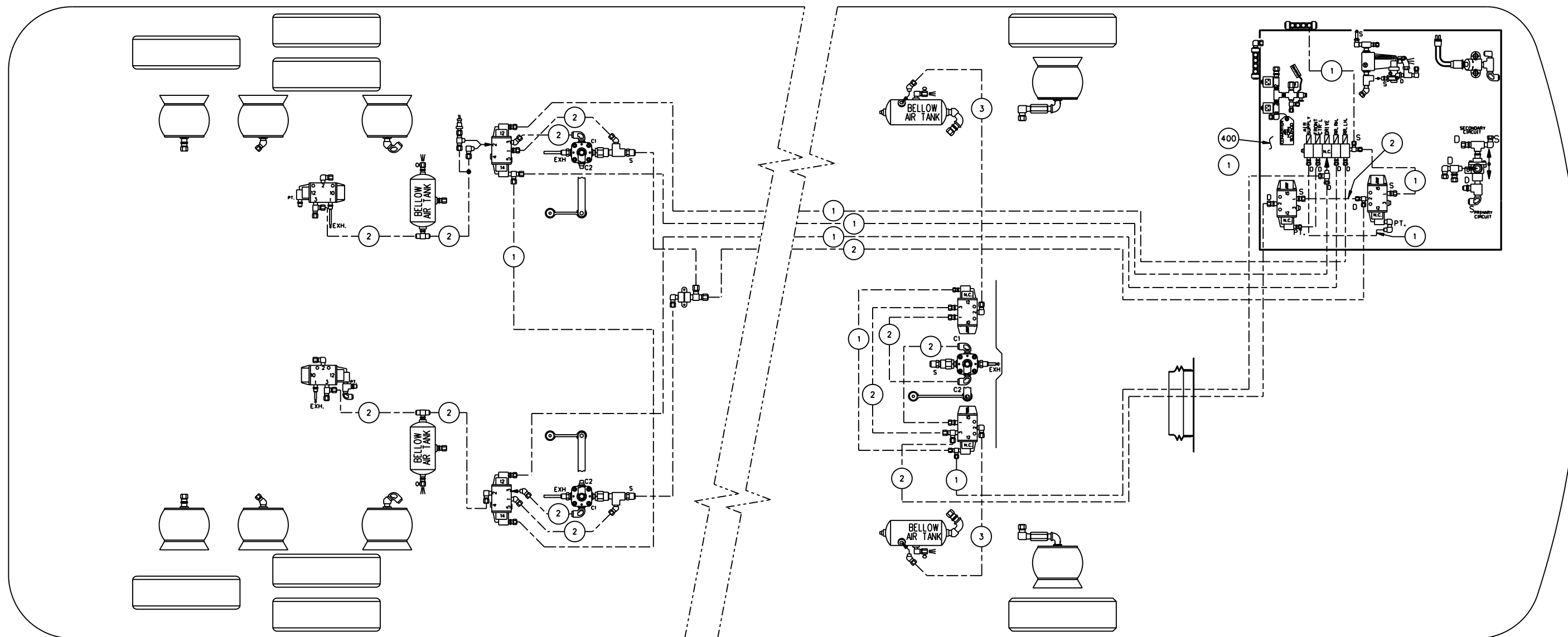

TUBE COLOR CODING	
ACTIVE	COLOR
---	BLACK
---	BLUE

CIRCUIT	
---	ACCESSORIES
---	STANDARD SUSPENSION

BALLOON	PIPE
*1	1/4" O.D. BLACK
*2	3/8" O.D. BLUE
*3	1/2" O.D. BLUE

PREVOST®

DESCRIPTION:

BUS SHELL WE & WO 2006
WITH OPTION LEVEL LOW

EFF. W/VEH :
*8-9279...

PAGE:

DATE:
2007/06

REV.:
B

D140342 P4.1

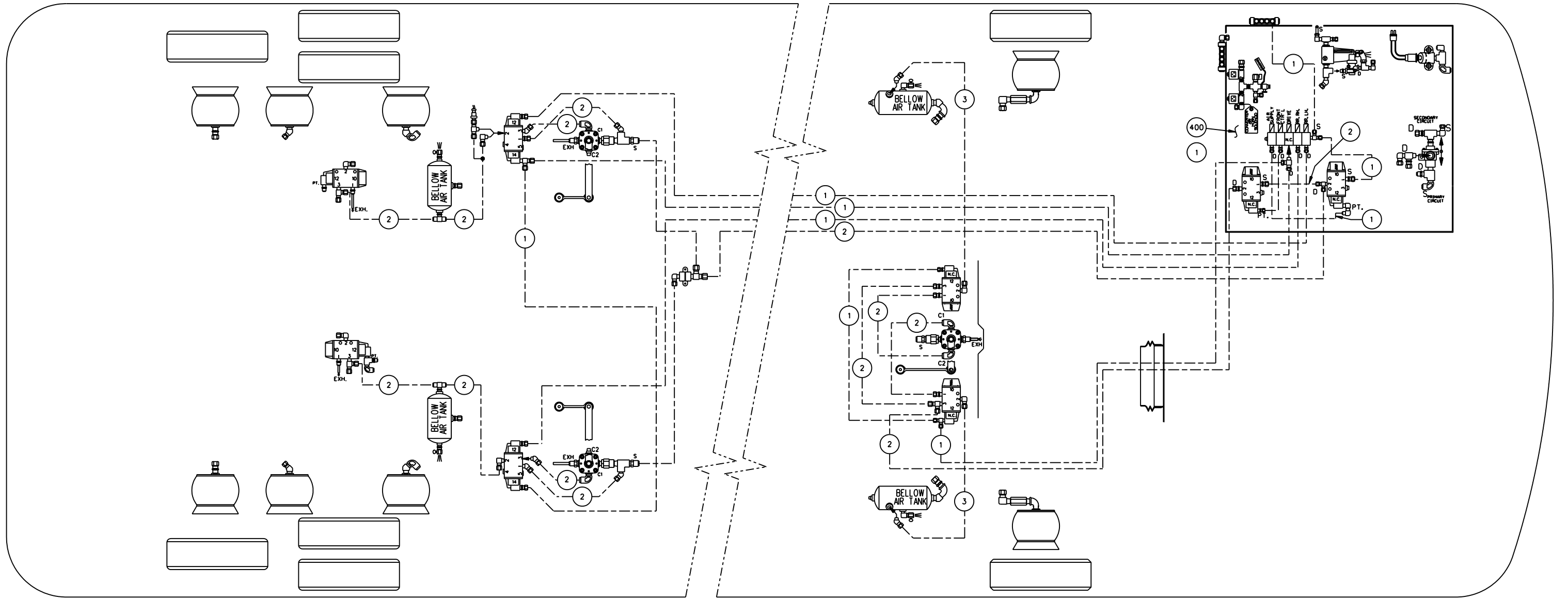

TUBE COLOR CODING		
ACTIVE	COLOR	CIRCUIT
—	BLACK	ACCESSORIES
- - -	BLUE	STANDARD SUSPENSION

BALLOON	PIPE
*1	1/4" O.D. BLACK
*2	3/8" O.D. BLUE
*3	1/2" O.D. BLUE

PREVOST®

DESCRIPTION:

BUS SHELL WE & WO 2006
WITH OPTION LEVEL LOW

EFF. W/VEH : #8-9436

PAGE:

DATE: 2008/04

REV.: C

D140342 P4.1

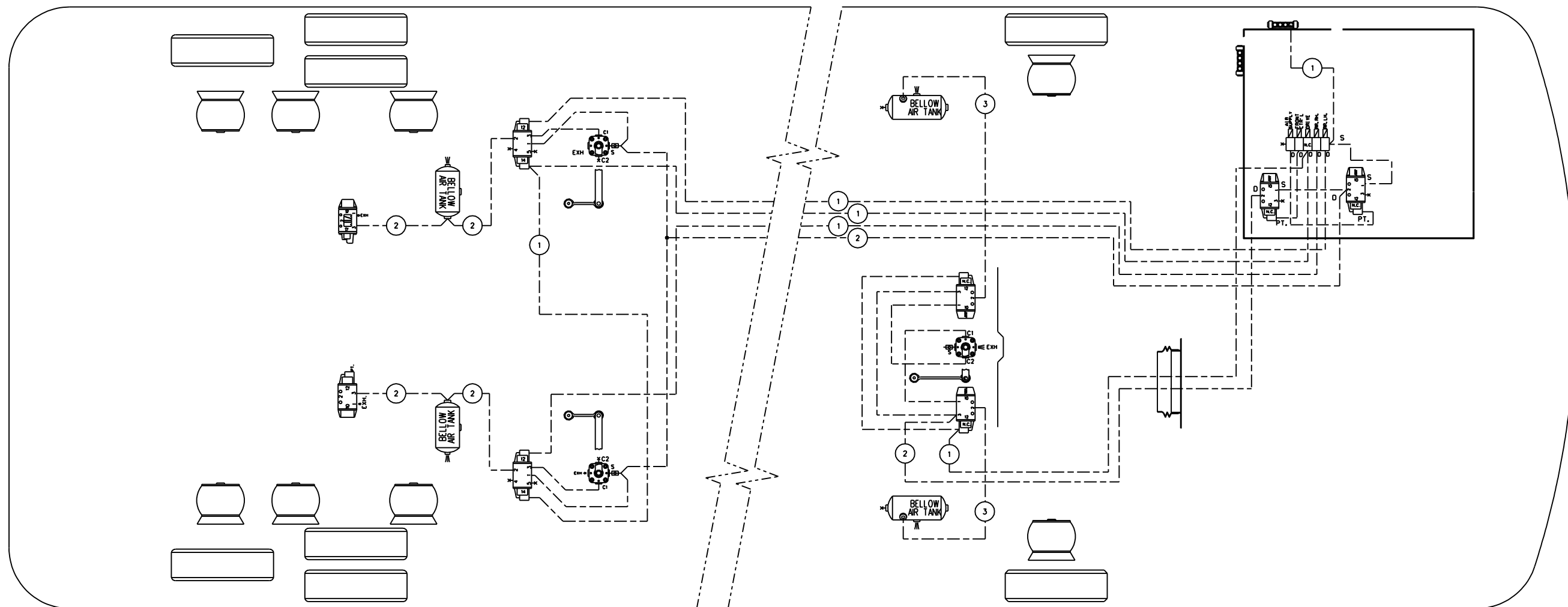

TUBE COLOR CODING	
ACTIVE COLOR	CIRCUIT
—	BLACK ACCESSORIES
---	BLUE STANDARD SUSPENSION

BALLOON	PIPE
*1	1/4" O.D. BLACK
*2	3/8" O.D. BLUE
*3	1/2" O.D. BLUE

PREVOST®

DESCRIPTION:

BUS SHELL WE 2006
WITH OPTION LEVEL LOW

EFF. W/VEH : #B-9954...

PAGE:

D140342 P4.1

DATE: 2010/04

REV.: D

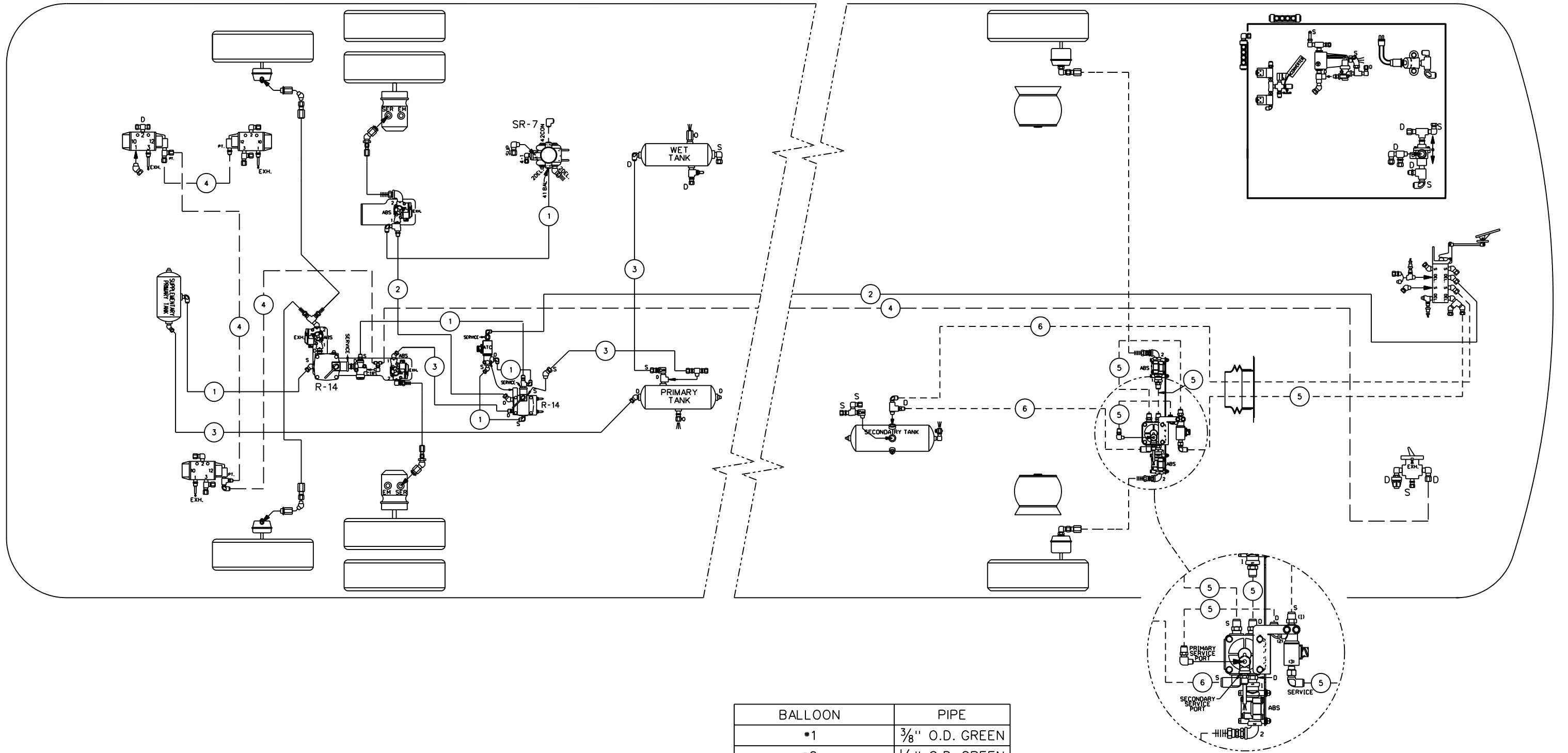

BALLOON	PIPE
*1	3/8" O.D. GREEN
*2	1/2" O.D. GREEN
*3	5/8" O.D. GREEN
*4	1/4" O.D. BLACK
*5	1/2" O.D. RED
*6	5/8" O.D. RED

TUBE COLOR CODING		
ACTIVE	COLOR	CIRCUIT
—	GREEN	PRIMARY & SUPPLY
—	BLACK	ACCESSORIES
- - -	RED	SECONDARY

PREVOST®

DESCRIPTION:

WO & WE BUS SHELL
WITH OPTION ESP BRAKE SYSTEM

EFF. W/ VEH : 8-9279...

PAGE:

D140342 P5.1

DATE: 2008/03

REV.: B

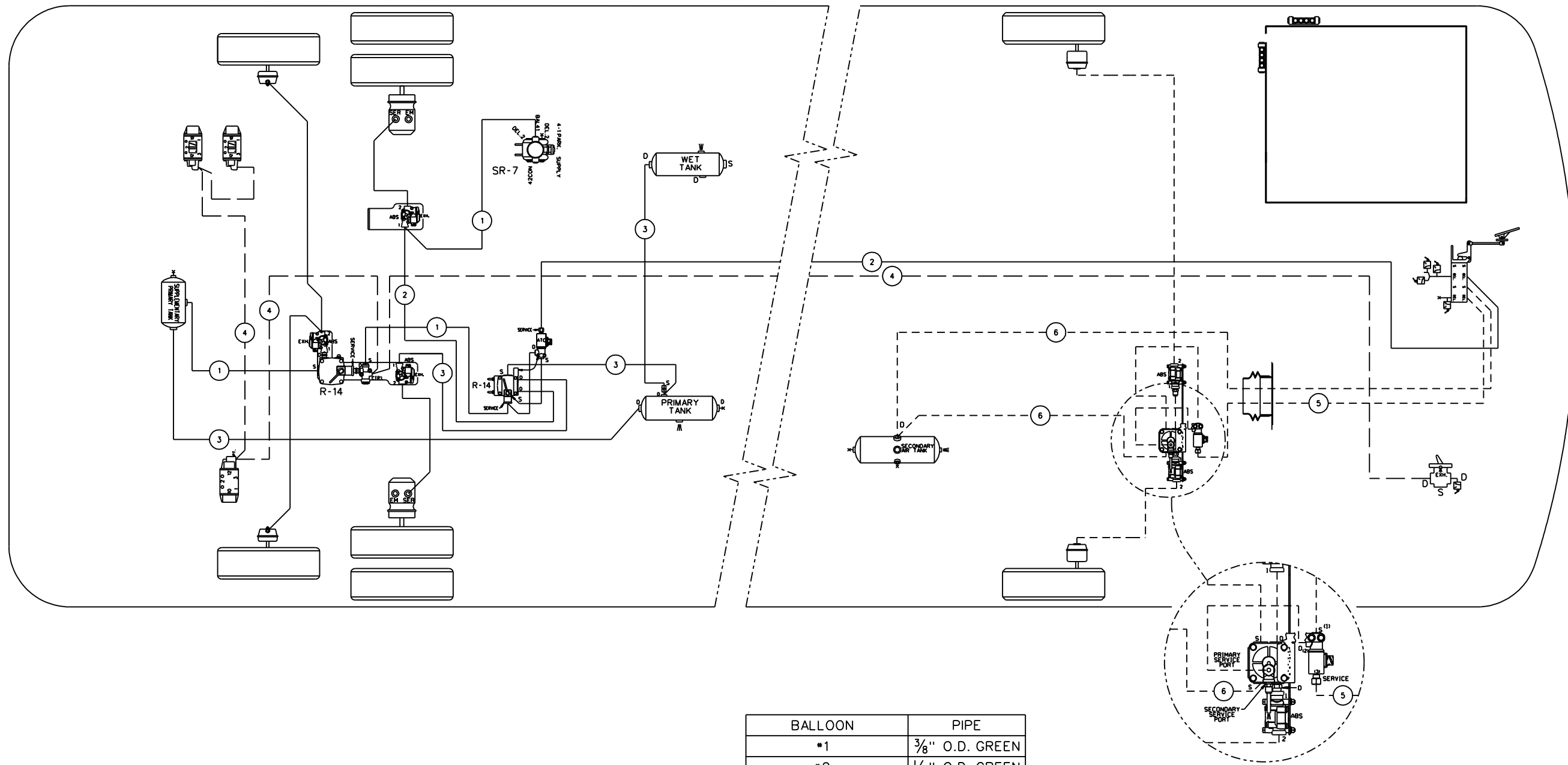

BALLOON	PIPE
*1	3/8" O.D. GREEN
*2	1/2" O.D. GREEN
*3	5/8" O.D. GREEN
*4	1/4" O.D. BLACK
*5	1/2" O.D. RED
*6	5/8" O.D. RED

TUBE COLOR CODING	
ACTIVE COLOR	CIRCUIT
— GREEN	PRIMARY & SUPPLY
— BLACK	ACCESSORIES
— RED	SECONDARY

PREVOST®

DESCRIPTION:

WE BUS SHELL
WITH OPTION ESP BRAKE SYSTEM

EFF. W/ VEH : *B-9954...

PAGE:

DATE: 2010/04

REV.: C

D140342 P5.1

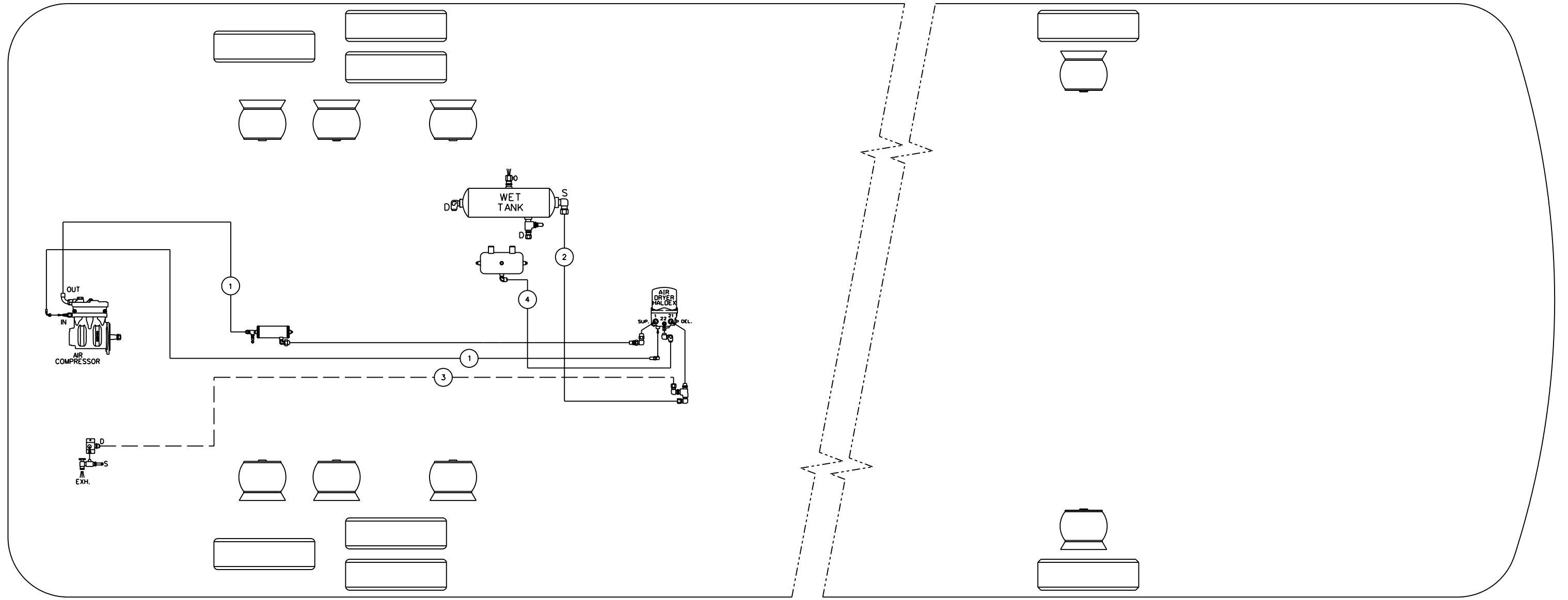

TUBE COLOR CODING		
ACTIVE	COLOR	CIRCUIT
—	GREEN	PRIMARY & SUPPLY
—	BLACK	ACCESSORIES

BALLOON	PIPE
*1	HOSE ASS'Y
*2	3/4" O.D. GREEN
*3	1/4" O.D. BLACK
*4	3/8" O.D. GREY

PREVOST®

DESCRIPTION:
 WE BUS SHELL
 HALDEX AIR DRYER WITH OPTION MD13 VOLVO ENGINE

EFF. W/ VEH : #9-9620...
 DATE: 2008/10
 REV.: A

PAGE:
 D140342 P6.1

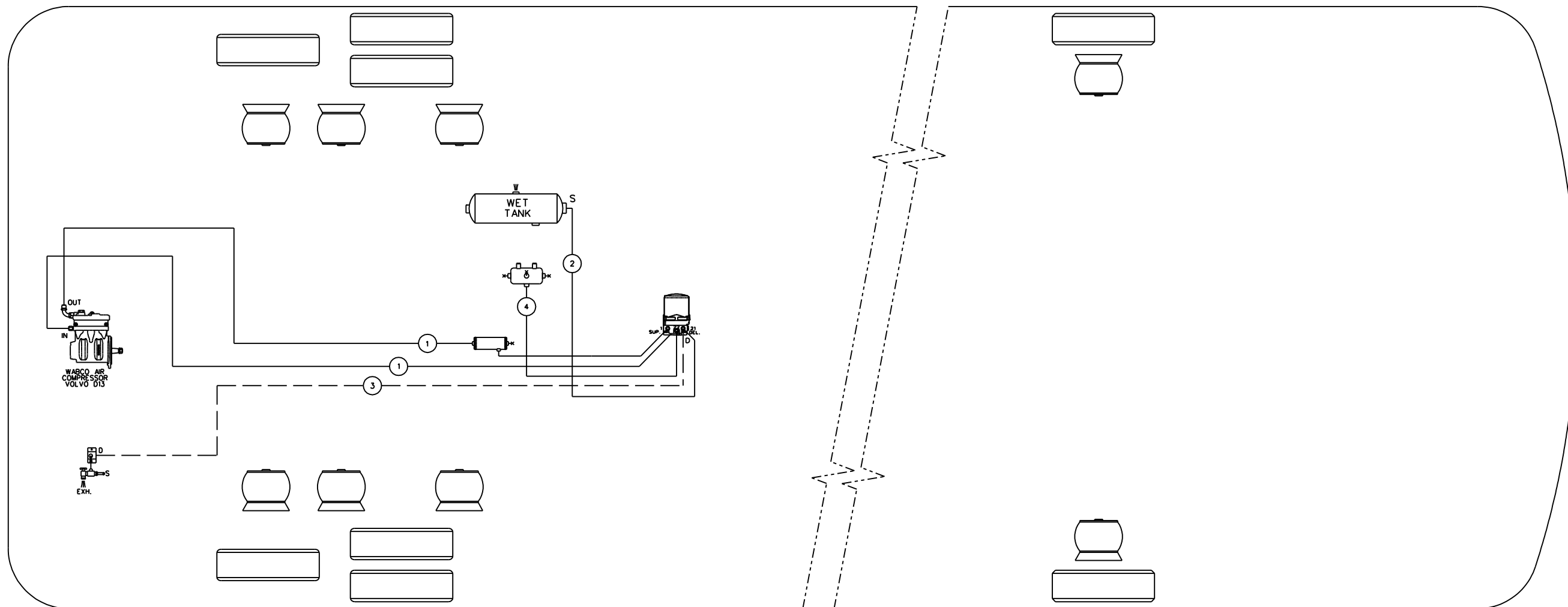

TUBE COLOR CODING	
ACTIVE COLOR	CIRCUIT
— GREEN	PRIMARY & SUPPLY
— BLACK	ACCESSORIES

BALLOON	PIPE
•1	HOSE ASS'Y
•2	3/4" O.D. GREEN
•3	1/4" O.D. BLACK
•4	3/8" O.D. GREY

PREVOST®

DESCRIPTION:

WE BUS SHELL
HALDEX AIR DRYER WITH OPTION MD13 VOLVO ENGINE

EFF. W/ VEH : #B-9954...

PAGE:

DATE: 2010/04

REV.: B

D140342 P6.1

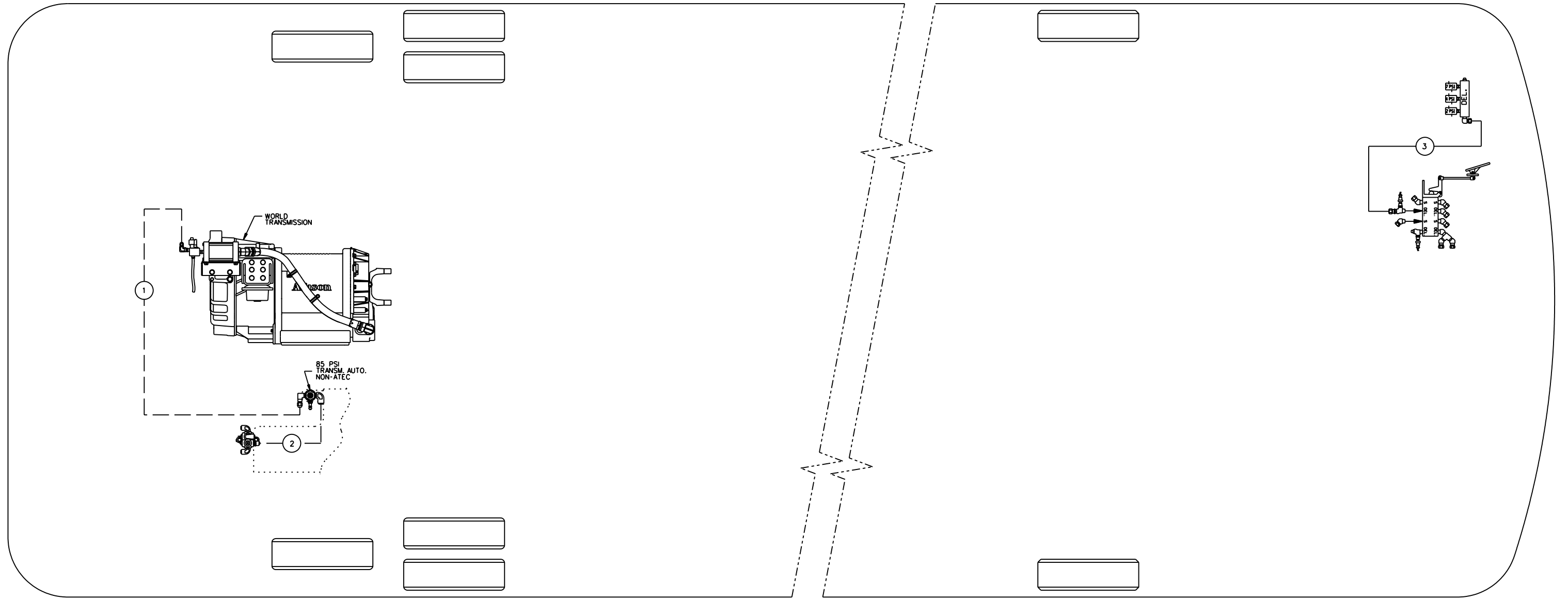

TUBE COLOR CODING		
ACTIVE	COLOR	CIRCUIT
---	BLACK	ACCESSORIES
---	GREEN	PRIMARY & SUPPLY

BALLOON	PIPE
*1	HOSE ASS'Y
*2	3/8" O.D. BLACK
*3	3/8" O.D. GREEN

PREVOST®

DESCRIPTION:
 BUS SHELL WE COOLING 2007
 WITH OUTPUT RETARDER ON WORLD TRANSMISSION

EFF. W/ VEH : #8-9279...
 DATE: 2008/07
 REV.: A

PAGE:
 D140342 P7.1

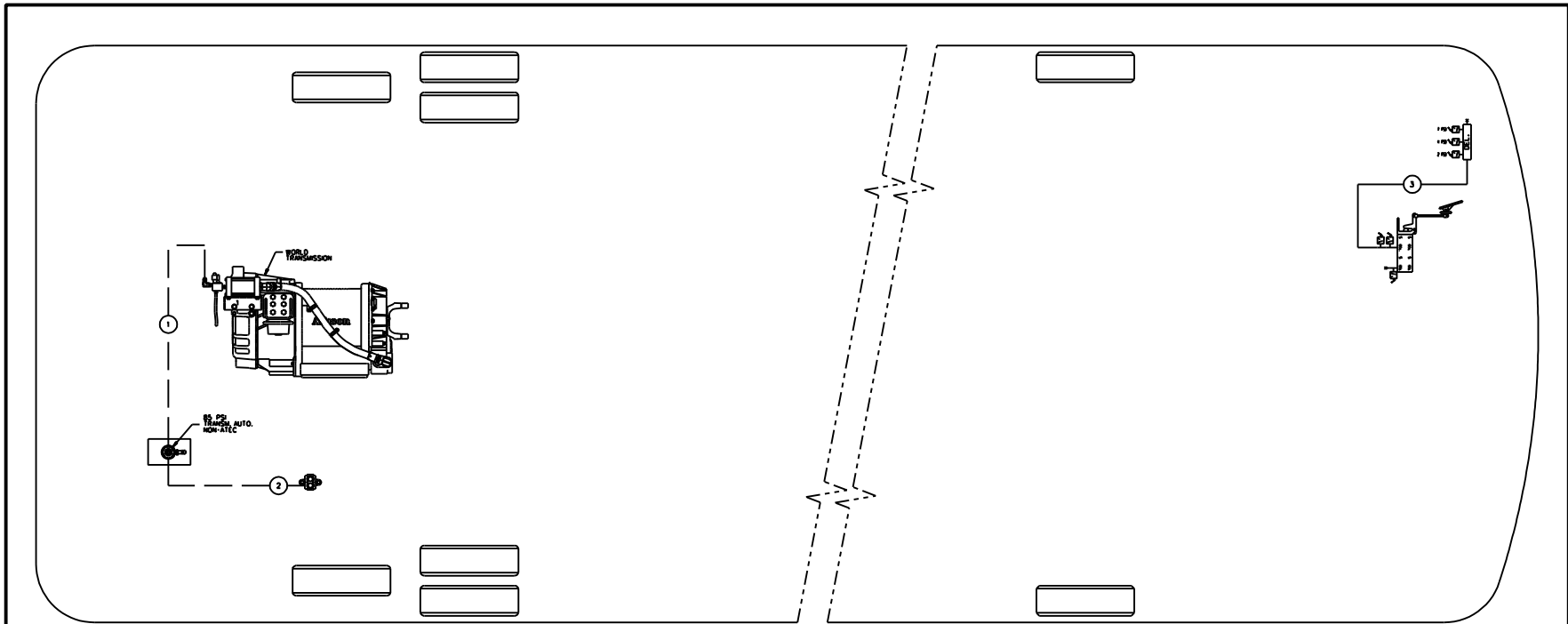

TUBE COLOR CODING	
ACTIVE COLOR	CIRCUIT
— BLACK	ACCESSORIES
— GREEN	PRIMARY & SUPPLY

BALLOON	PIPE
*1	HOSE ASS'Y
*2	1/4" O.D. BLACK
*3	3/8" O.D. GREEN

PREVOST.

DESCRIPTION:

BUS SHELL WE COOLING 2007
WITH OUTPUT RETARDER ON WORLD TRANSMISSION

EFF. W/ VEH :

*A-9952...

PAGE:

D140342 P7.1

DATE:

2010/04

REV.:

B

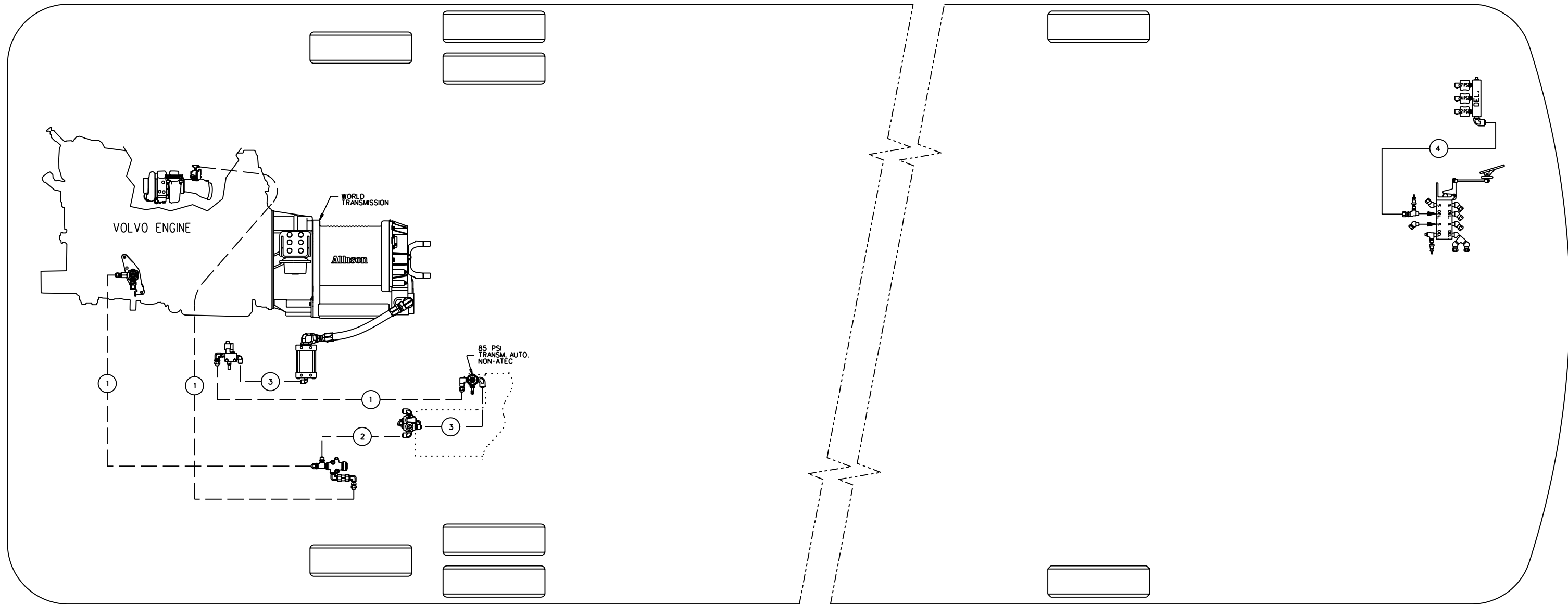

TUBE COLOR CODING		
ACTIVE	COLOR	CIRCUIT
---	BLACK	ACCESSORIES
---	GREEN	PRIMARY & SUPPLY

BALLOON	PIPE
*1	HOSE ASS'Y
*2	1/4" O.D. BLACK
*3	3/8" O.D. BLACK
*4	3/8" O.D. GREEN

PREVOST®

DESCRIPTION:

WE BUS SHELL
WITH OPTION MD13 VOLVO ENGINE
& OUTPUT RETARDER ON WORLD TRANSMISSION

EFF. W/ VEH : #9-9096...

DATE: 2008/06

REV.: A

PAGE:

D140342 P8.1

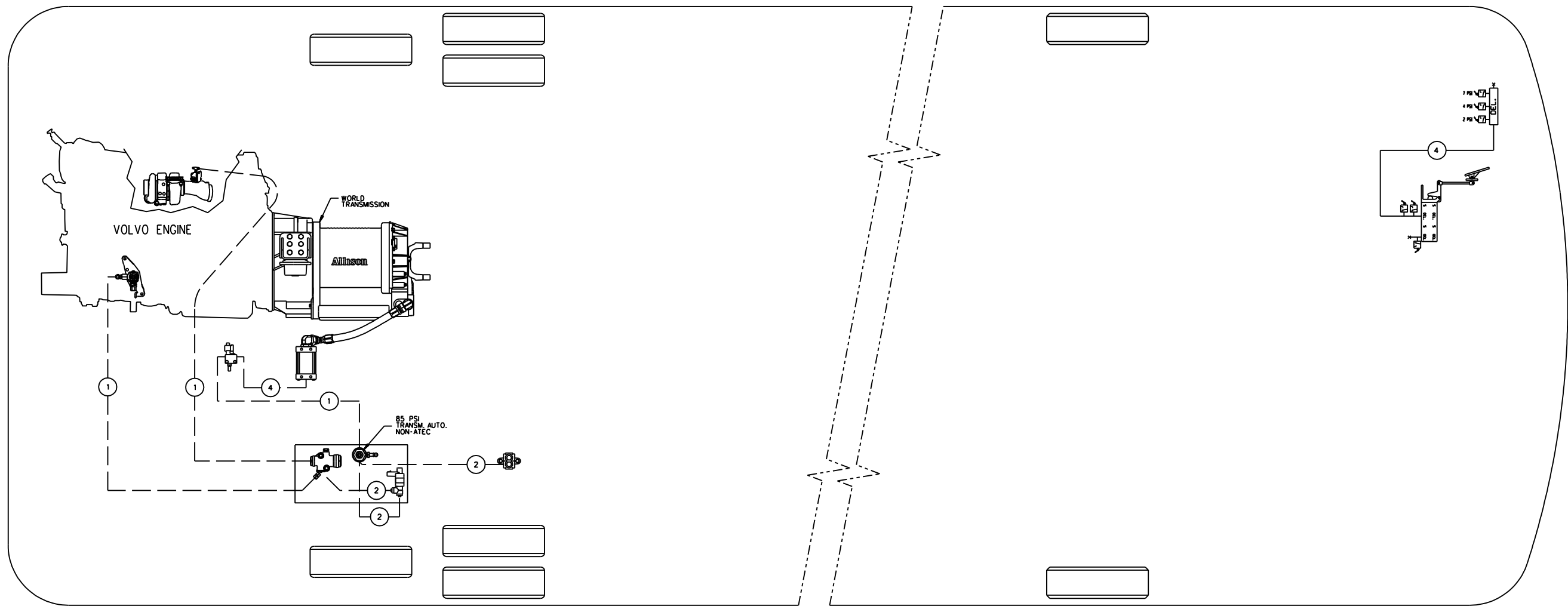

TUBE COLOR CODING		
ACTIVE	COLOR	CIRCUIT
---	BLACK	ACCESSORIES
---	GREEN	PRIMARY & SUPPLY

BALLOON	PIPE
*1	HOSE ASS'Y
*2	1/4" O.D. BLACK
*3	3/8" O.D. BLACK
*4	3/8" O.D. GREEN

PREVOST®

DESCRIPTION:

WE BUS SHELL
 WITH OPTION MD13 VOLVO ENGINE
 & OUTPUT RETARDER ON WORLD TRANSMISSION

EFF. W/ VEH : #A-9952...

DATE: 2010/04

REV.: B

PAGE:

D140342 P8.1

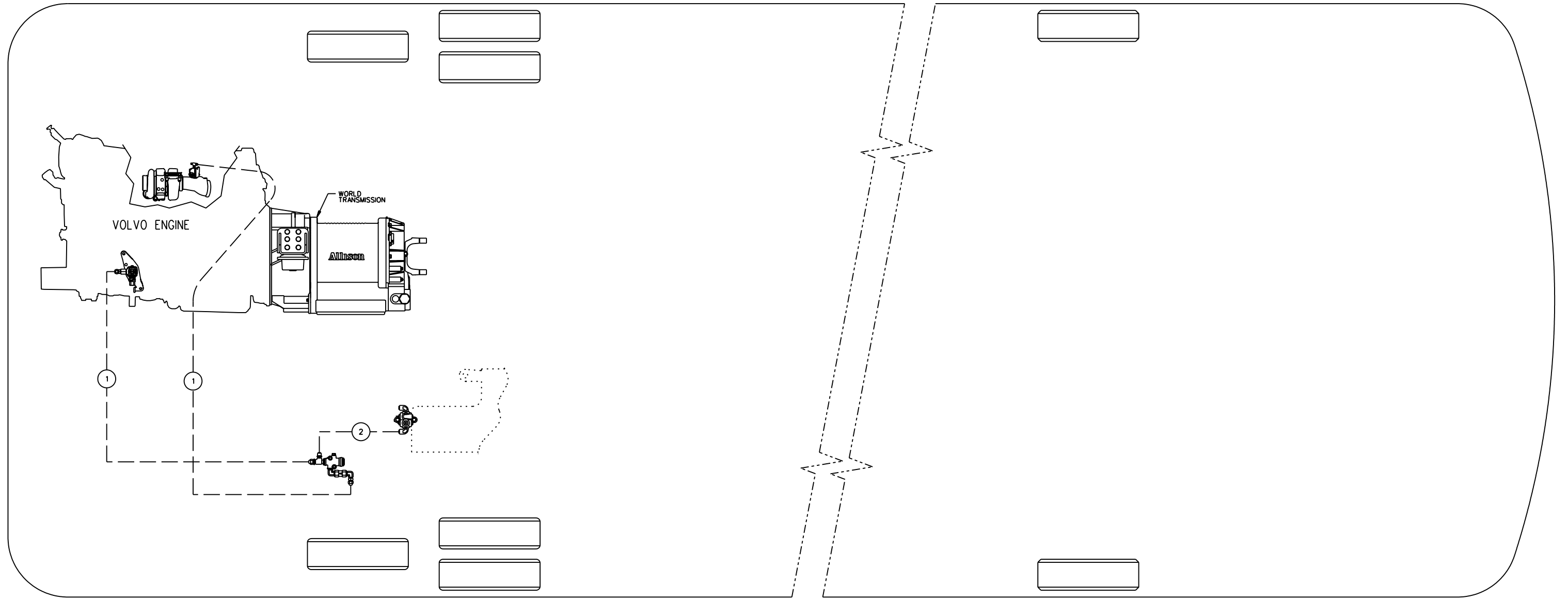

TUBE COLOR CODING		
ACTIVE	COLOR	CIRCUIT
---	BLACK	ACCESSORIES

BALLOON	PIPE
*1	HOSE ASS'Y
*2	1/4" O.D. BLACK

PREVOST®

DESCRIPTION: WE BUS SHELL
 WITH OPTION MD13 VOLVO ENGINE
 WITHOUT OUTPUT RETARDER ON WORLD TRANSMISSION

EFF. W/ VEH : #9-9096...
 DATE: 2008/06 REV.: A

PAGE: D140342 P9.1

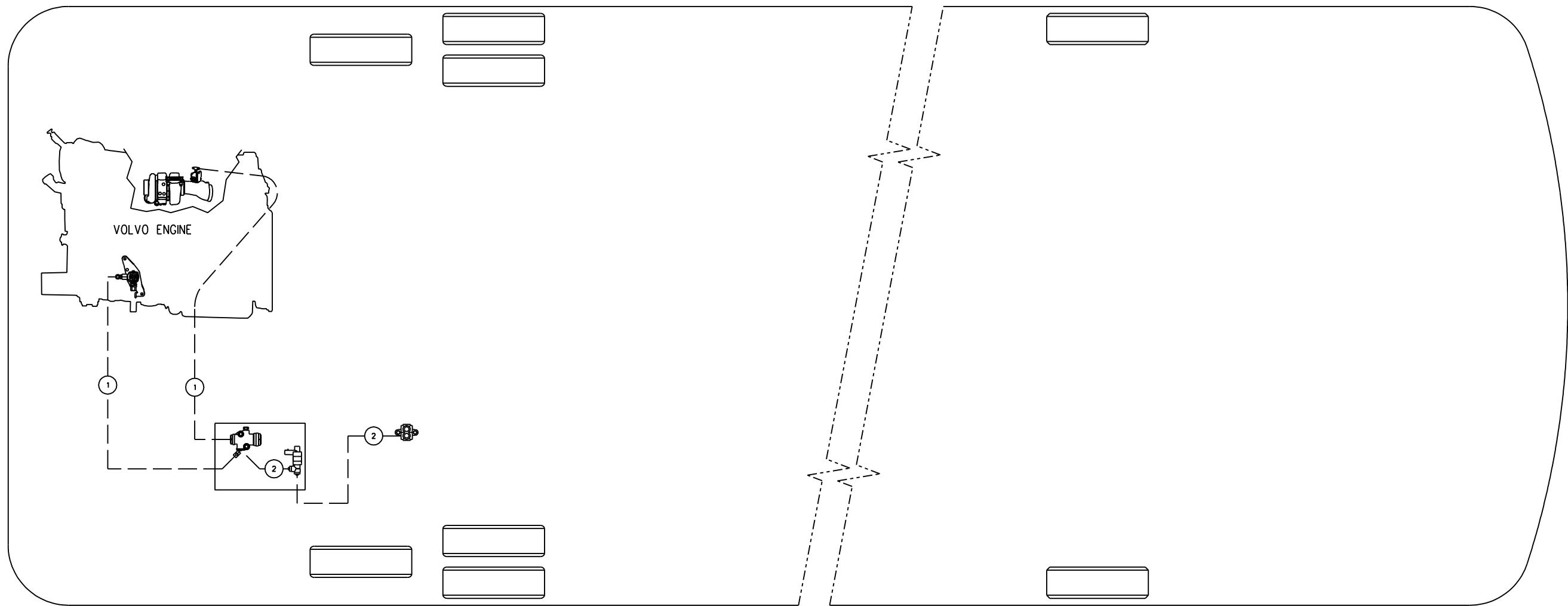

TUBE COLOR CODING	
ACTIVE	CIRCUIT
—	BLACK ACCESSORIES

BALLOON	PIPE
*1	HOSE ASS'Y
*2	1/4" O.D. BLACK

PREVOST®

DESCRIPTION: WE BUS SHELL
 WITH OPTION MD13 VOLVO ENGINE
 WITHOUT OUTPUT RETARDER ON WORLD TRANSMISSION

EFF. W/ VEH : #A-9952...
 DATE: 2010/04
 REV.: B

PAGE: D140342 P9.1