

Pneumatic diagram

PNEUMATIC DIAGRAMS W5 BUS SHELL WITH INDEPENDENT SUSP.

NO:	D140361 P0	REVISION :	E
-----	-------------------	------------	----------

EFF. OC#	2006038 2005002	PRIOR TO OC#	#2008069
EFF. VEH#	#8-9332	PRIOR TO VEH#	#...

DR.	Robert Bouillon	date	2008-12-15
CHK	Marc-Jose Handfield	Appr	Marc-José Handfield

REV.	DATE	DESCRIPTION	PAGE	BY	CHK.	APPR.
A	2007-05-02 2007-09-20	#8-9251, #8-9316 W5 PRELIMINARY VEHICLE ESP #8-9332 PRODUCTION VEHICLE				
B	2008-04-14	#D140361P.2 , Revision B (Update) #D140361 P.6 , Revision B (Update)	P2 & P2.1 P6 & P6.1	Rob. Rob.	M.J.H. M.J.H.	M.J.H. M.J.H.
C	2008-06-30	#D140361 P1 &P3 REVISION B , NEW AIR TANK ASSY FOR DIFFERENTIAL AIR BELLOWS SUSPENSION	P1&P1.1 TO 1.4	Rob.	M.J.H.	M.J.H.
D	2008-10-09	#D140361 P.6 , Revision C	P3 & P3.1 P6.0 & 6.1	Rob.	M.J.H.	M.J.H.
E	2008-12-15	#D140361 P.1 , Revision D	P1.0 & P1.1	Y. Laine	M.J.H.	M.J.H.
		NOTE : ABS 6 WITH AIR BRAKE ON TRAILER HITCH, NOT AVAILABLE.				

Pneumatic diagram

PNEUMATIC DIAGRAMS W5 BUS SHELL WITH INDEPENDENT SUSP.

PRODUCTION NUMBER	REV	EFF. VEH.	ECN	S.A.V. NUMBER	REV	DESCRIPTION
D140361P1.0	A	#8-9332	2006038 2005002	D140361P1.1	C	FULL PNEUMATIC SYSTEM ABS 6 SYSTEM
	B	#8-9433	2007108	D140361P1.2	C	ACCESSORIES
	C	#...	2008069	D140361P1.3	C	BRAKES SYSTEM
				D140361P1.4	C	SUSPENSION
D140361P2.0	A	#8-9332	2006038 2005002	D140361P2.1	A	BRAKE SYSTEM ESP (Preliminary Veh. #8-9251, #8-9316)
	B	#8-9595	2007108		B	
D140361P3.0	A	#8-9332	2006038 2005002	D140361P3.1	B	LEVEL LOW FINGER TIP SUSPENSION OPTION
	B	#8-9433	2007108			
D140361P4.0	A	#8-9332	2006038 2005002	D140361P4.1	A	LEFT SIDE FRONT SINGLE SLIDE OUT OPTION
D140361P5.0	A	#8-9332	2006038 2005002	D140361P5.1	A	DOUBLE SLIDE OUT OPTION LEFT SIDE , FRONT AND REAR
D140361P6.0	A	#8-9332	2006038 2005002	D140361P6.1	A	BRAKE SYSTEM ESP WITH AIR BRAKE ON TRAILER HITCH
	B	#8-9571	2007107		B	
	C		2008107		C	

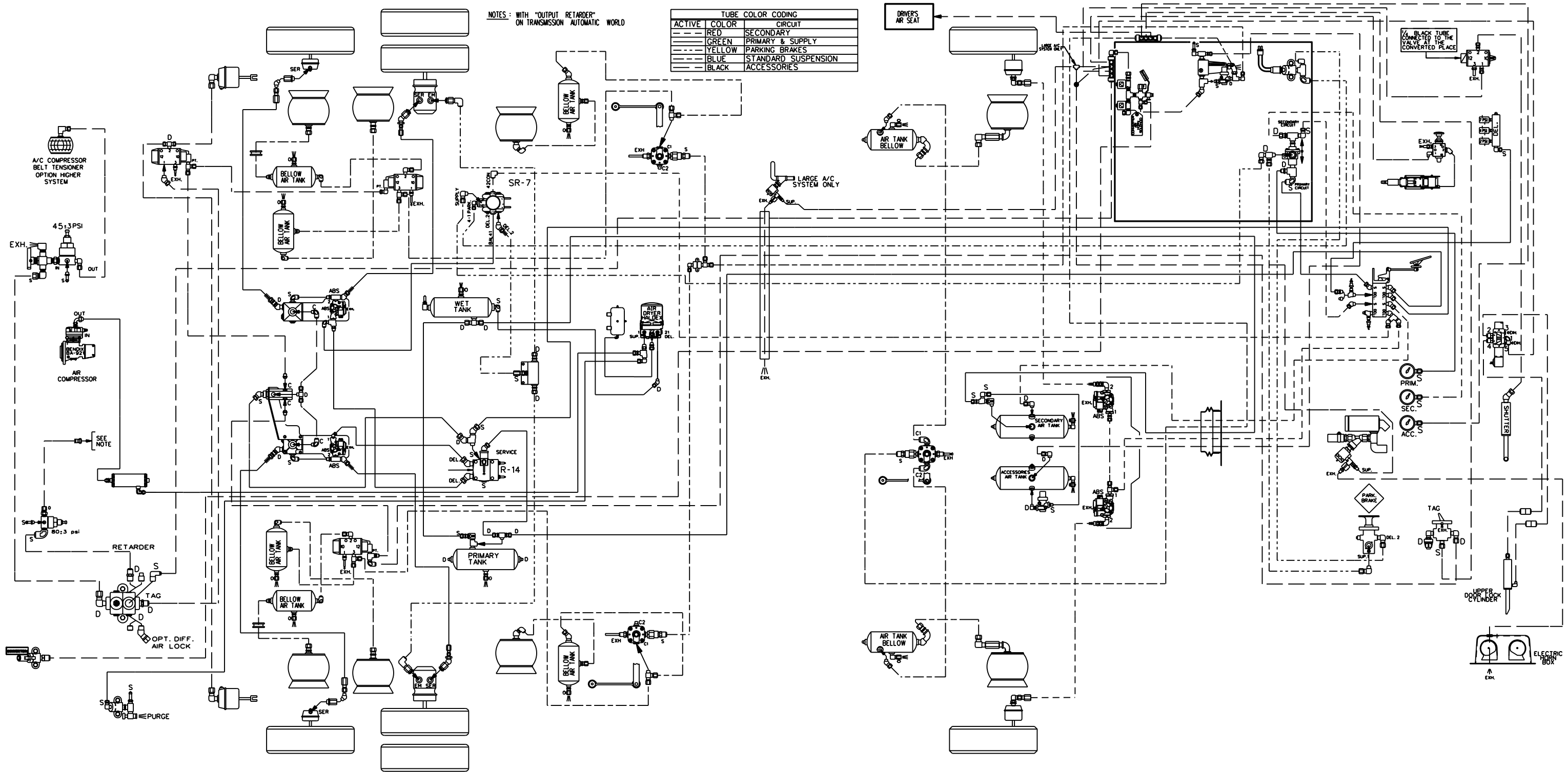

PREVOST

DESCRIPTION:

BUS SHELL XLII
 SERIES 60 ENGINES
 FULL PNEUMATIC SYSTEM ABS 6

EFF. W/ VEH :
 #8-9332...

PAGE:

D140361 P1.1

DATE:
 2007/09

REV.:
 A

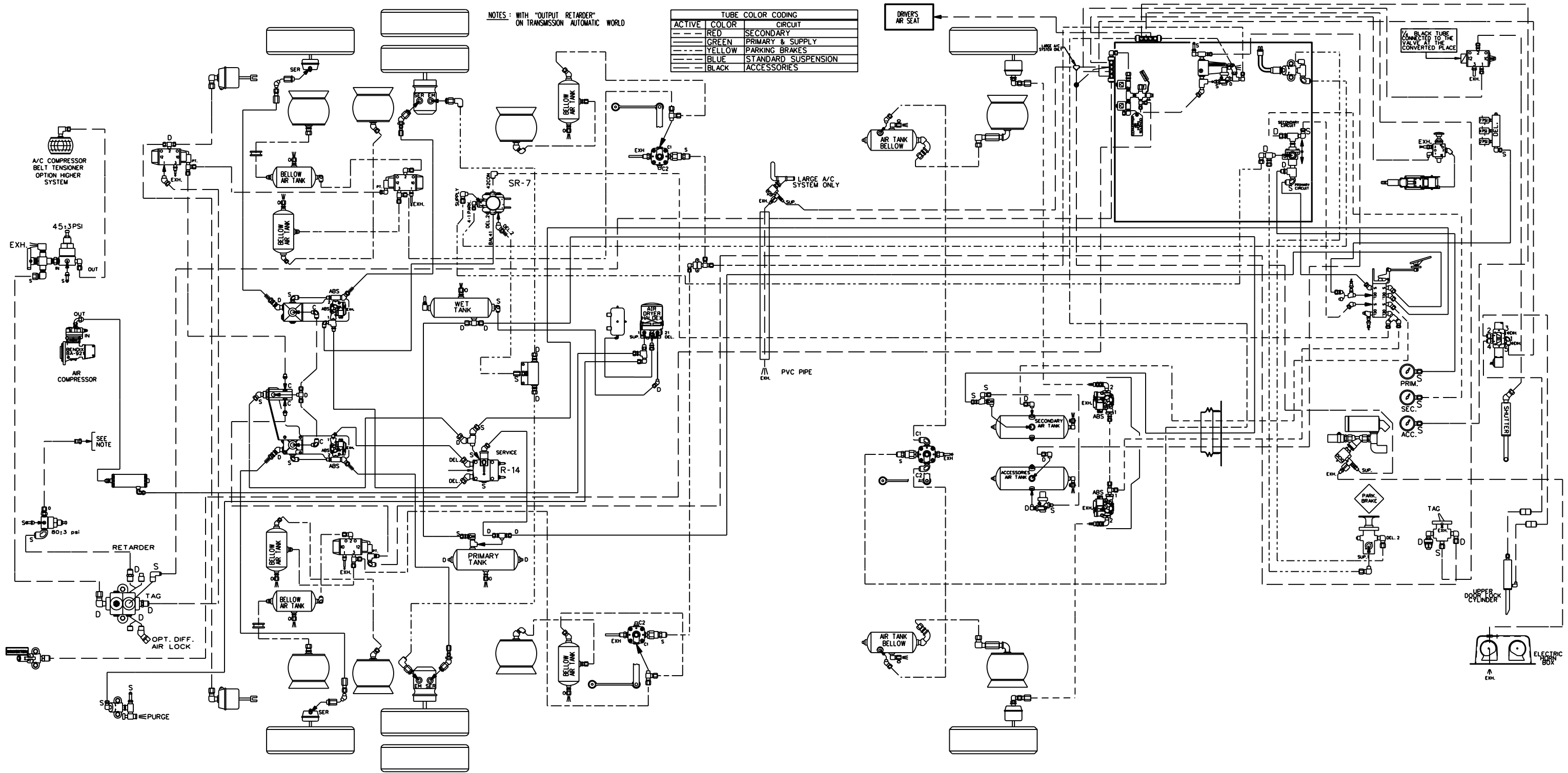

PREVOST®

DESCRIPTION:

BUS SHELL XLII
 SERIES 60 ENGINES
 FULL PNEUMATIC SYSTEM ABS 6

EFF. W/ VEH : #9-9776...

PAGE:

D140361 P.1.1

DATE: 2008/12

REV.: C

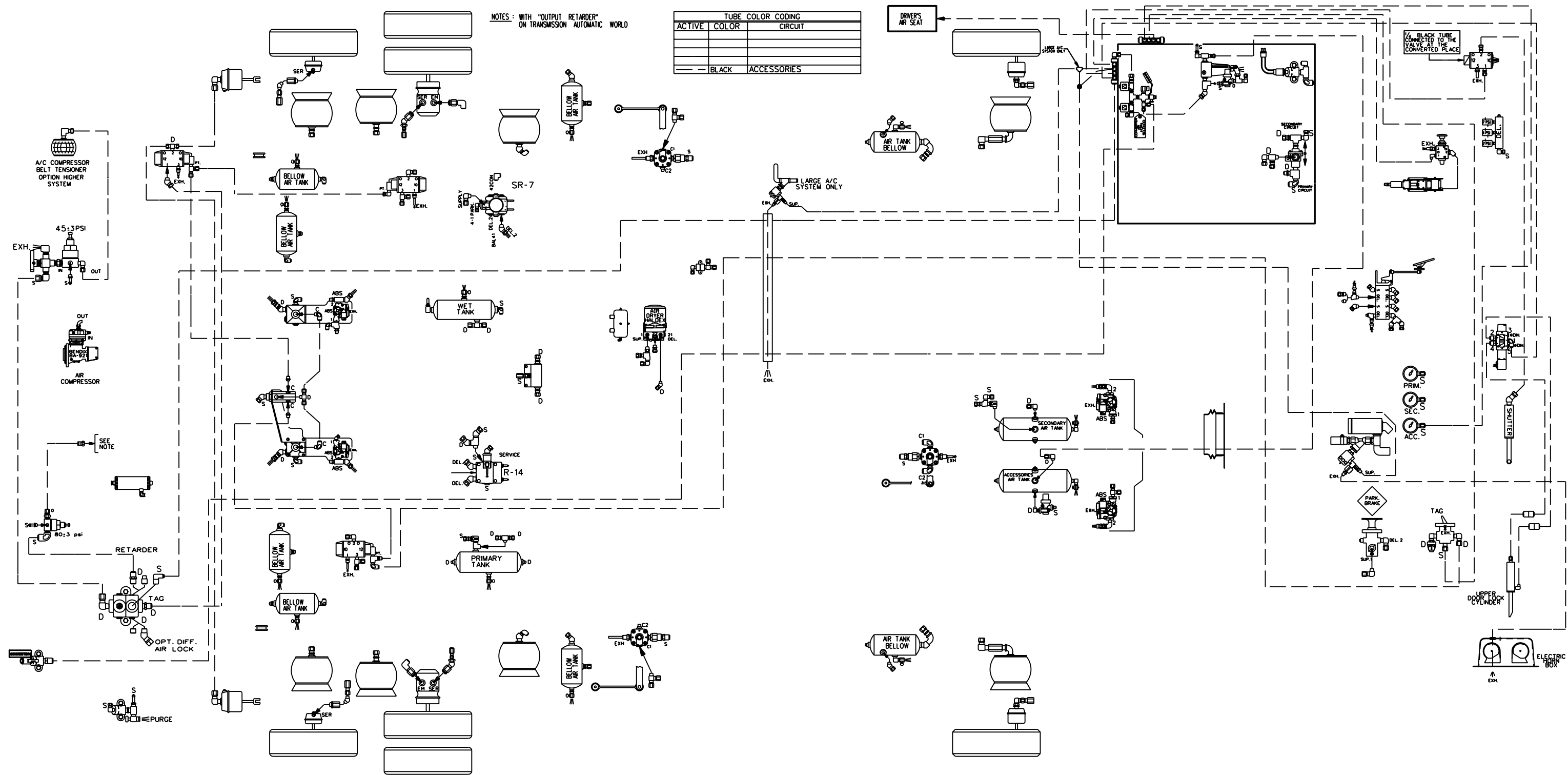

PREVOST

DESCRIPTION:

BUS SHELL XLII
 SERIES 60 ENGINES
 ACCESSORIES

EFF. W/ VEH :
 #8-9332...

PAGE:

D140361P1.2

DATE:
 2007/09

REV.:
 A

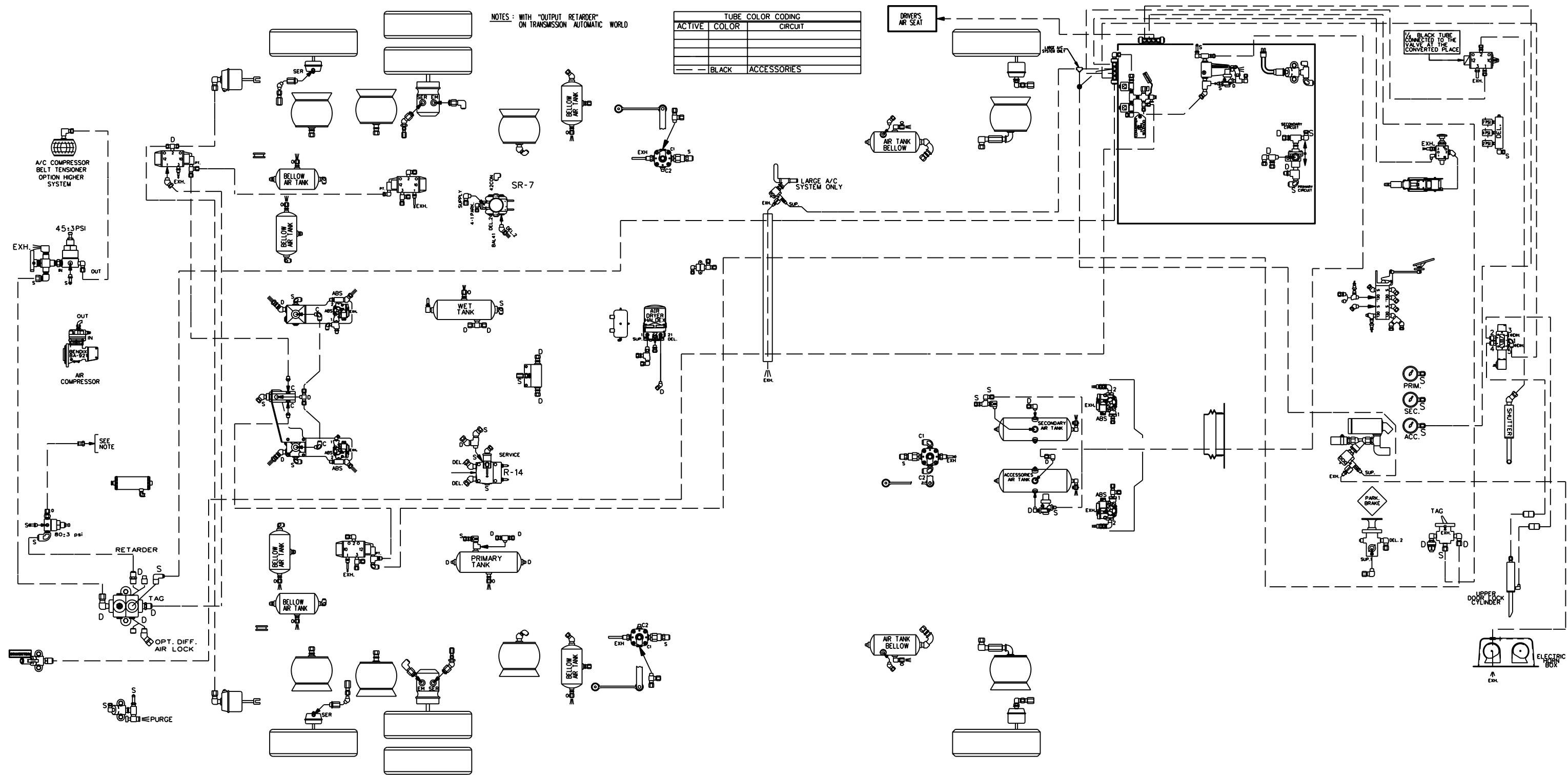

PREVOST

DESCRIPTION:

BUS SHELL XLII
 SERIES 60 ENGINES
 ACCESSORIES

EFF. W/ VEH : #8-9433

PAGE:

D140361 P1.2

DATE: 2008/04

REV.: B

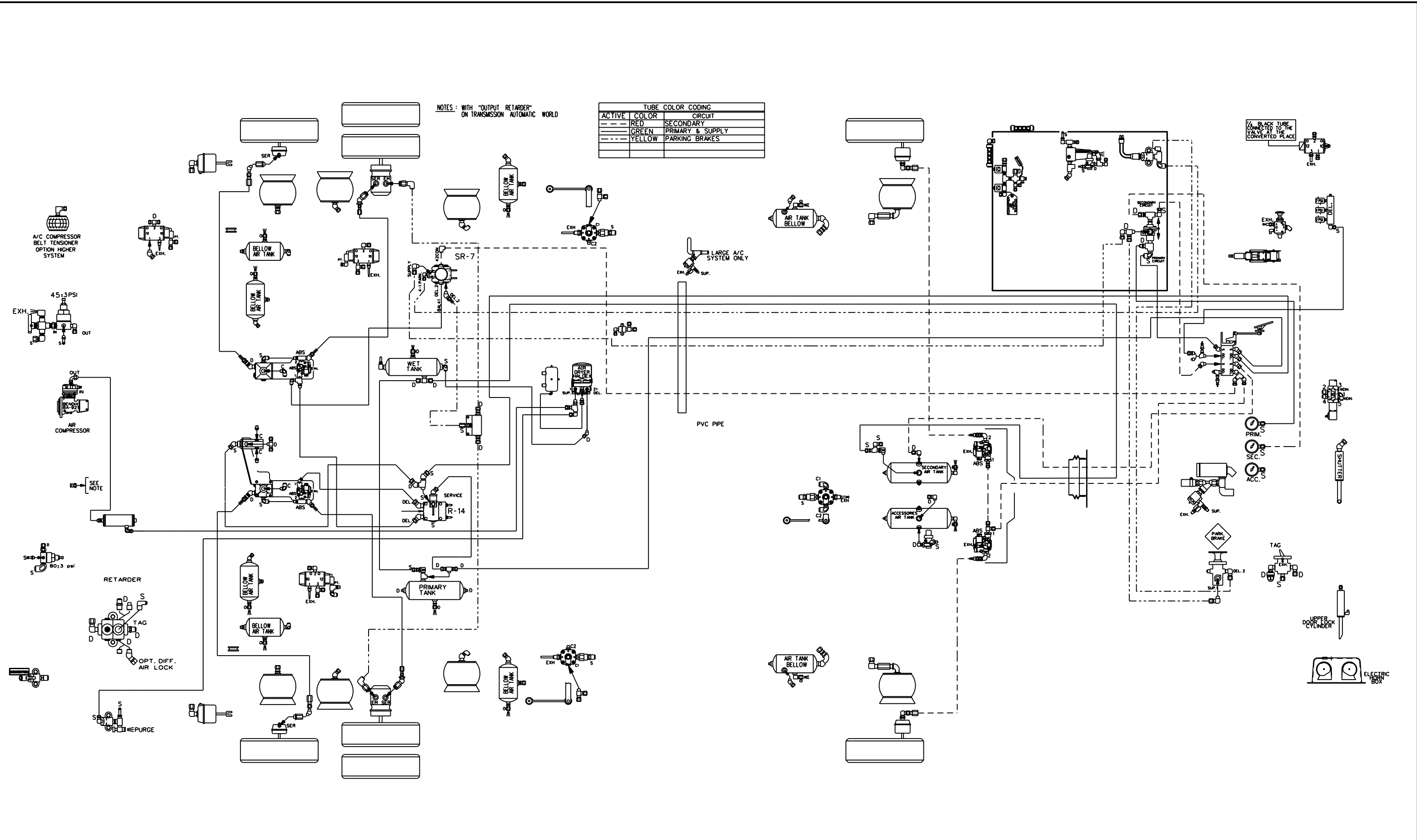

PREVOST®

DESCRIPTION: BUS SHELL XLII
 SERIES 60 ENGINES
 BRAKES SYSTEM ABS 6

EFF. W/ VEH : #9-9776...
 DATE: 2008/12
 REV.: C

PAGE: D140361 P1.3

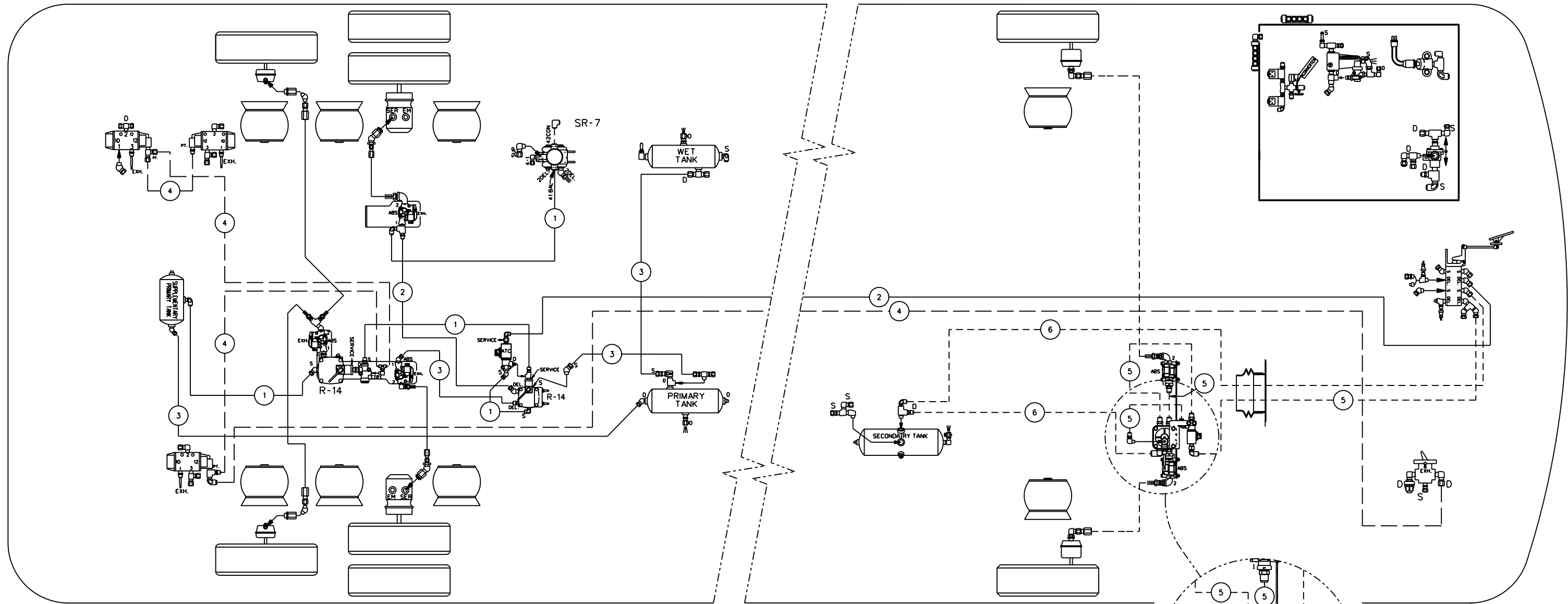

BALLOON	PIPE
#1	3/8" O.D. GREEN
#2	1/2" O.D. GREEN
#3	5/8" O.D. GREEN
#4	1/4" O.D. BLACK
#5	1/2" O.D. RED
#6	5/8" O.D. RED

TUBE COLOR CODING		
ACTIVE	COLOR	CIRCUIT
—	GREEN	PRIMARY & SUPPLY
—	BLACK	ACCESSORIES
- - -	RED	SECONDARY

PREVOST®

DESCRIPTION:
 BUS SHELL W5
 WITH BRAKE SYSTEM ESP OPTION

EFF. W/ VEH : #8-9332...
 DATE: 2007/09
 REV.: A

PAGE:
 D140361 P2.1

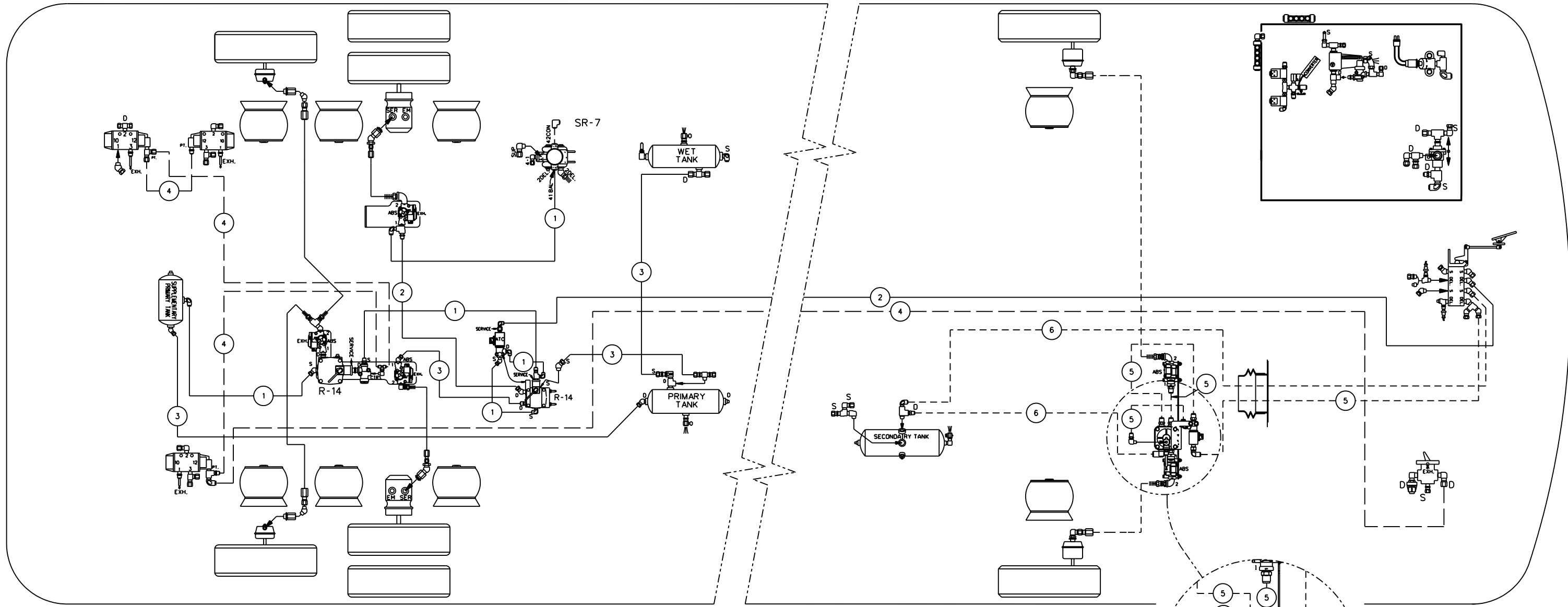

BALLOON	PIPE
#1	3/8" O.D. GREEN
#2	1/2" O.D. GREEN
#3	5/8" O.D. GREEN
#4	1/4" O.D. BLACK
#5	1/2" O.D. RED
#6	5/8" O.D. RED

TUBE COLOR CODING		
ACTIVE	COLOR	CIRCUIT
—	GREEN	PRIMARY & SUPPLY
---	BLACK	ACCESSORIES
- - - -	RED	SECONDARY

PREVOST®

DESCRIPTION:
 BUS SHELL W5
 WITH BRAKE SYSTEM ESP OPTION

EFF. W/ VEH : #8-9332...
 DATE: 2008/03

PAGE:
 D140361 P2.1
 REV.: B

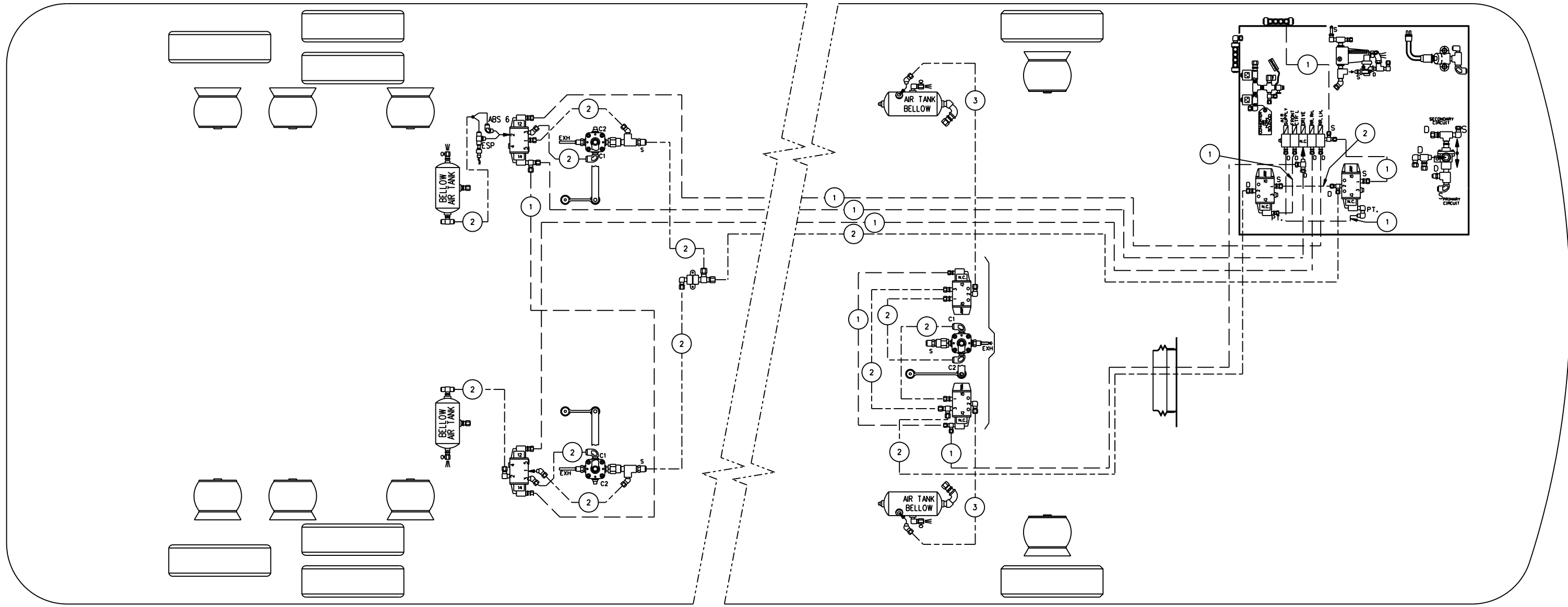

BALLOON	PIPE
*1	1/4" O.D. BLACK
*2	3/8" O.D. BLUE
*3	1/2" O.D. BLUE

TUBE COLOR CODING		
LINE TYPE	COLOR	CIRCUIT
---	BLUE	SUSPENSION
---	BLACK	ACCESSORIES

PREVOST®

DESCRIPTION:

BUS SHELL W5
WITH LEVEL LOW OPTION

EFF. W/VEH : #8-9332...

PAGE:

D140361 P3.1

DATE: 2007/09

REV.: A

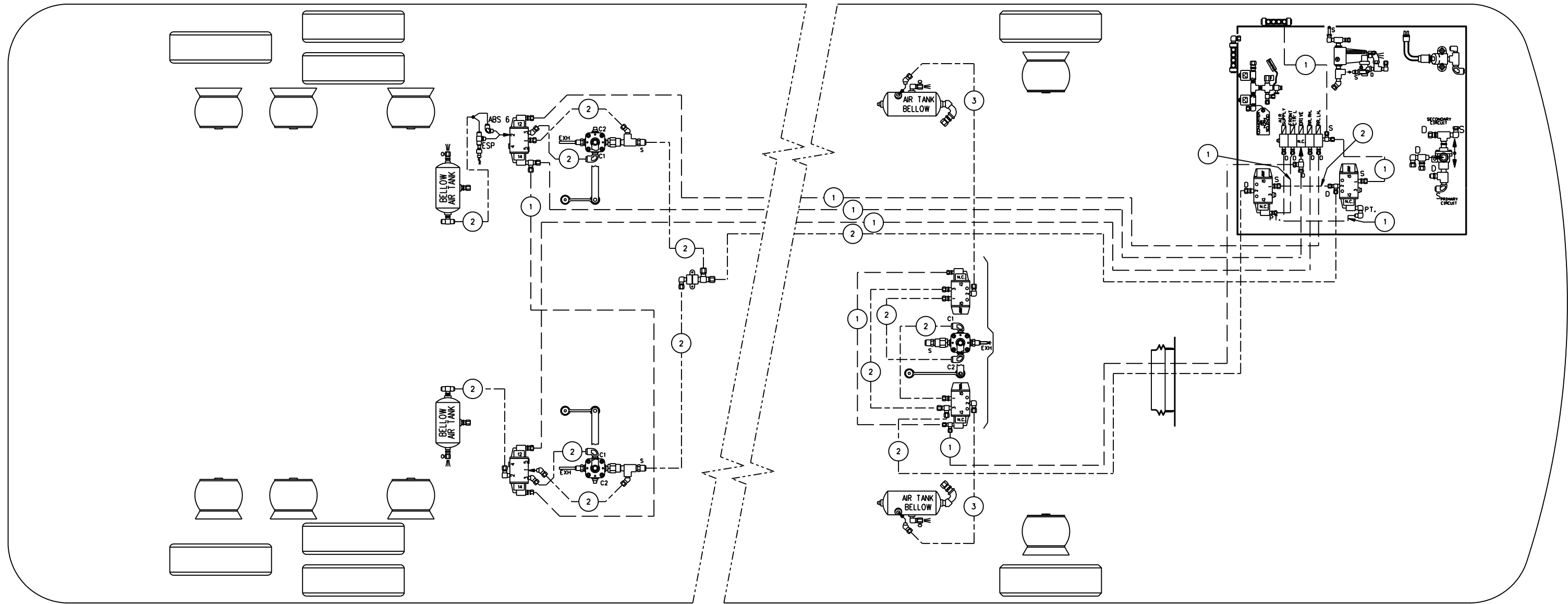

BALLOON	PIPE
*1	1/4" O.D. BLACK
*2	3/8" O.D. BLUE
*3	1/2" O.D. BLUE

TUBE COLOR CODING		
LINE TYPE	COLOR	CIRCUIT
---	BLUE	SUSPENSION
---	BLACK	ACCESSORIES

PREVOST®

DESCRIPTION:

BUS SHELL W5
WITH LEVEL LOW OPTION

EFF. W/VEH : #8-9433

PAGE:

DATE: 2008/04

REV.: B

D140361 P3.1

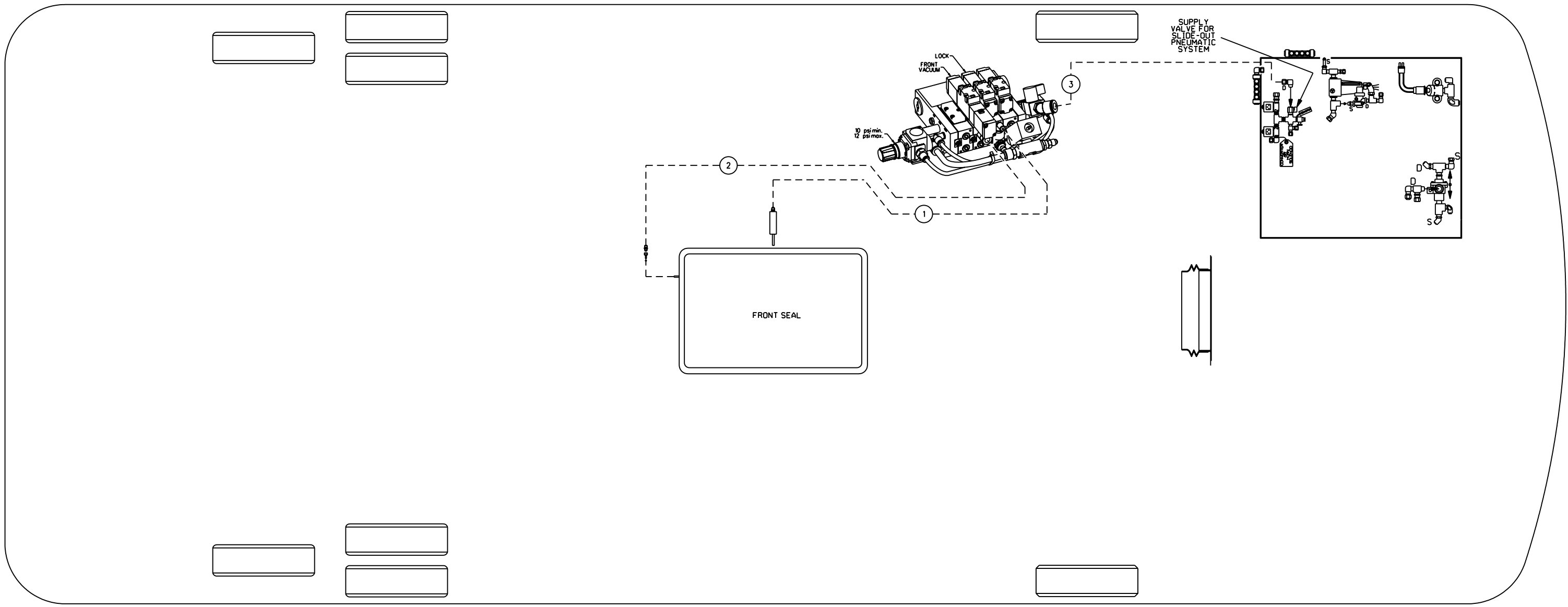

TUBE COLOR CODING	
ACTIVE COLOR	CIRCUIT
— BLACK	ACCESSORIES

BALLOON	PIPE
*1	1/8" O.D. BLACK
*2	3/8" O.D. BLACK
*3	1/2" O.D. BLACK

PREVOST®

DESCRIPTION:
 BUS SHELL W5
 FRONT SINGLE SLIDE-OUT OPTION, LEFT SIDE

EFF. W/ VEH : #8-9332...
 DATE: 2007/09
 REV.: A

PAGE:
 D140361 P4.1

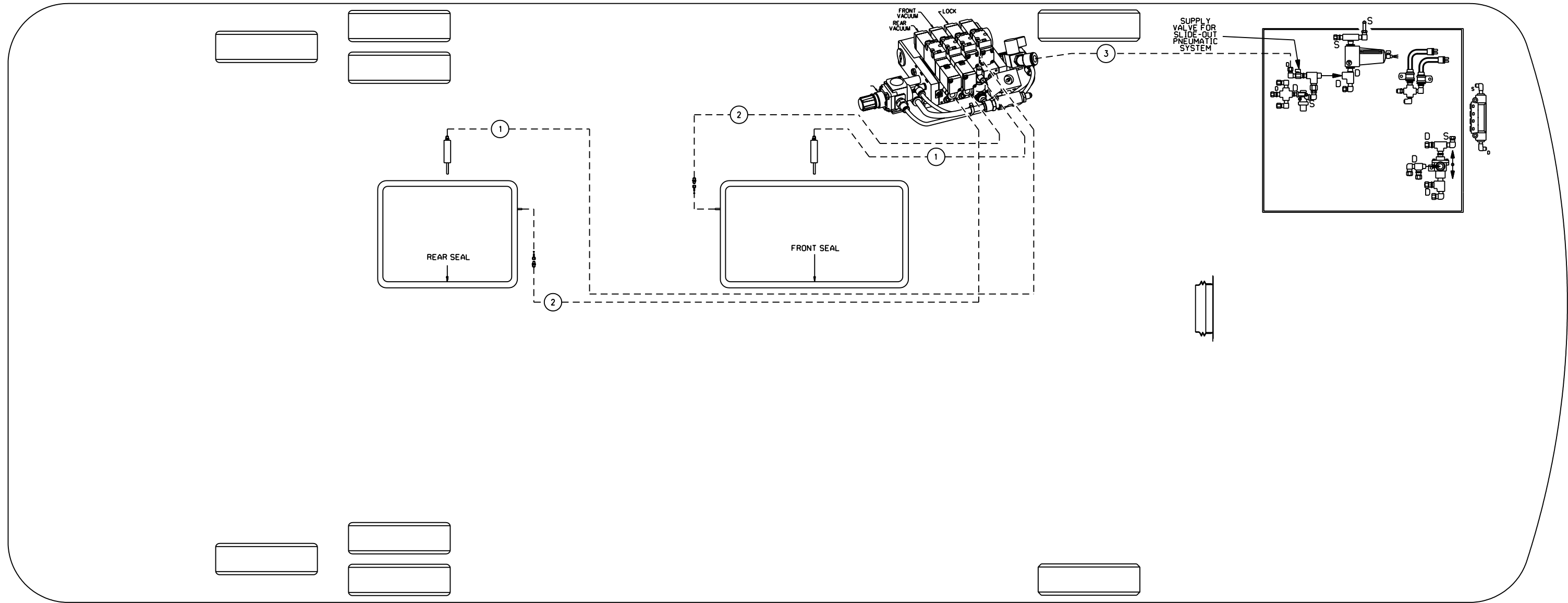

TUBE COLOR CODING	
ACTIVE COLOR	CIRCUIT
— BLACK	ACCESSORIES

BALLOON	PIPE
*1	1/8" O.D. BLACK
*2	3/8" O.D. BLACK
*3	1/2" O.D. BLACK

PREVOST®

DESCRIPTION:

BUS SHELL W5
DOUBLE SLIDE-OUT OPTION LEFT SIDE, FRONT AND REAR

EFF. W/ VEH : VEH.: #8-9332...

PAGE:

D140361 P5.1

DATE: 2007/09

REV.: A

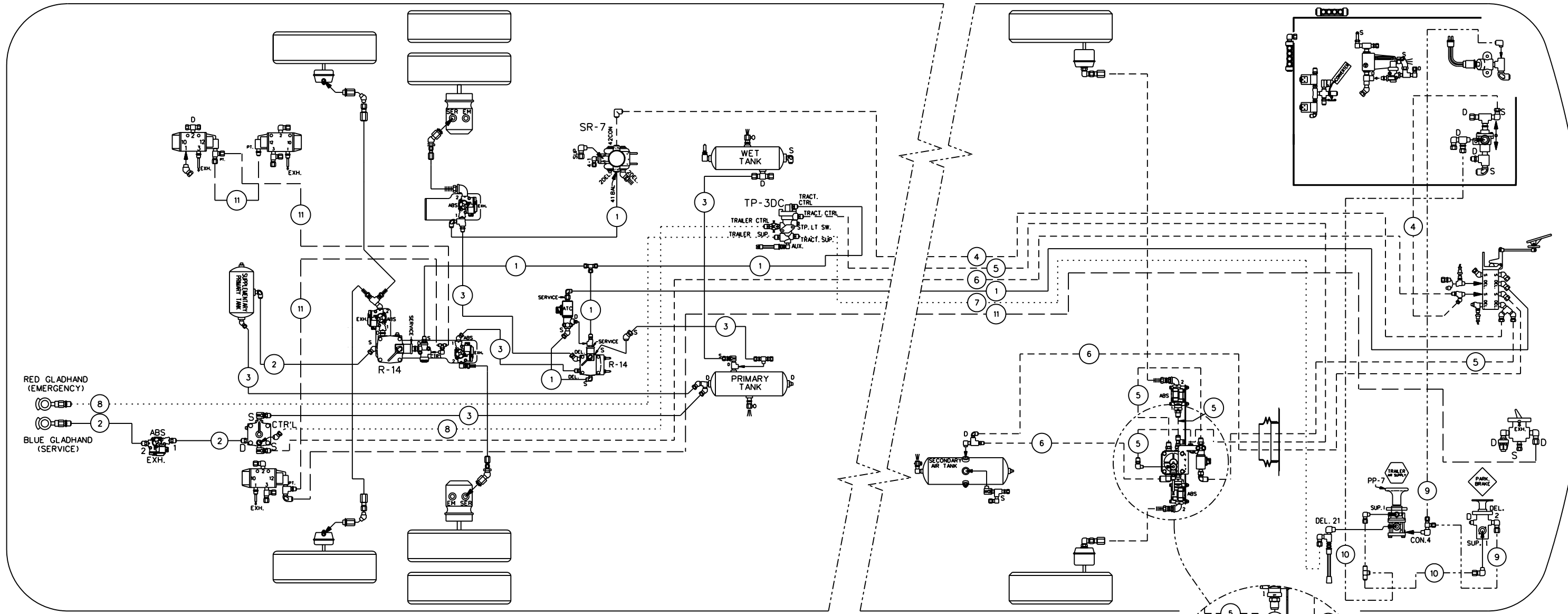

RED GLADHAND
(EMERGENCY)

BLUE GLADHAND
(SERVICE)

BALLOON	PIPE
•1	3/8" O.D. GREEN
•2	1/2" O.D. GREEN
•3	5/8" O.D. GREEN
•4	3/8" O.D. RED
•5	1/2" O.D. RED
•6	5/8" O.D. RED
•7	3/8" O.D. BROWN
•8	1/2" O.D. BROWN
•9	1/4" O.D. YELLOW
•10	3/8" O.D. YELLOW
•11	1/4" O.D. BLACK
•12	5/8" O.D. BLACK

TUBE COLOR CODING	
ACTIVE	CIRCUIT
---	RED SECONDARY
---	GREEN PRIMARY & SUPPLY
---	YELLOW PARKING BRAKE
---	BROWN TRAILER
---	BLACK ACCESSORIES

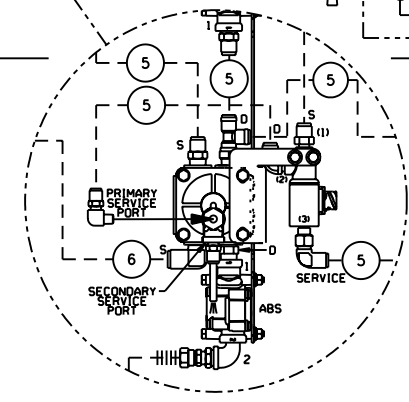

PREVOST®

DESCRIPTION:
 BUS SHELL W5
 WITH AIR BRAKES ON TRAILER HITCH
 AND ESP OPTION

EFF. W/VEH :
 VEH.: #8-9332...
 DATE: 2007/09
 REV.: A

PAGE:
 D140361 P6.1

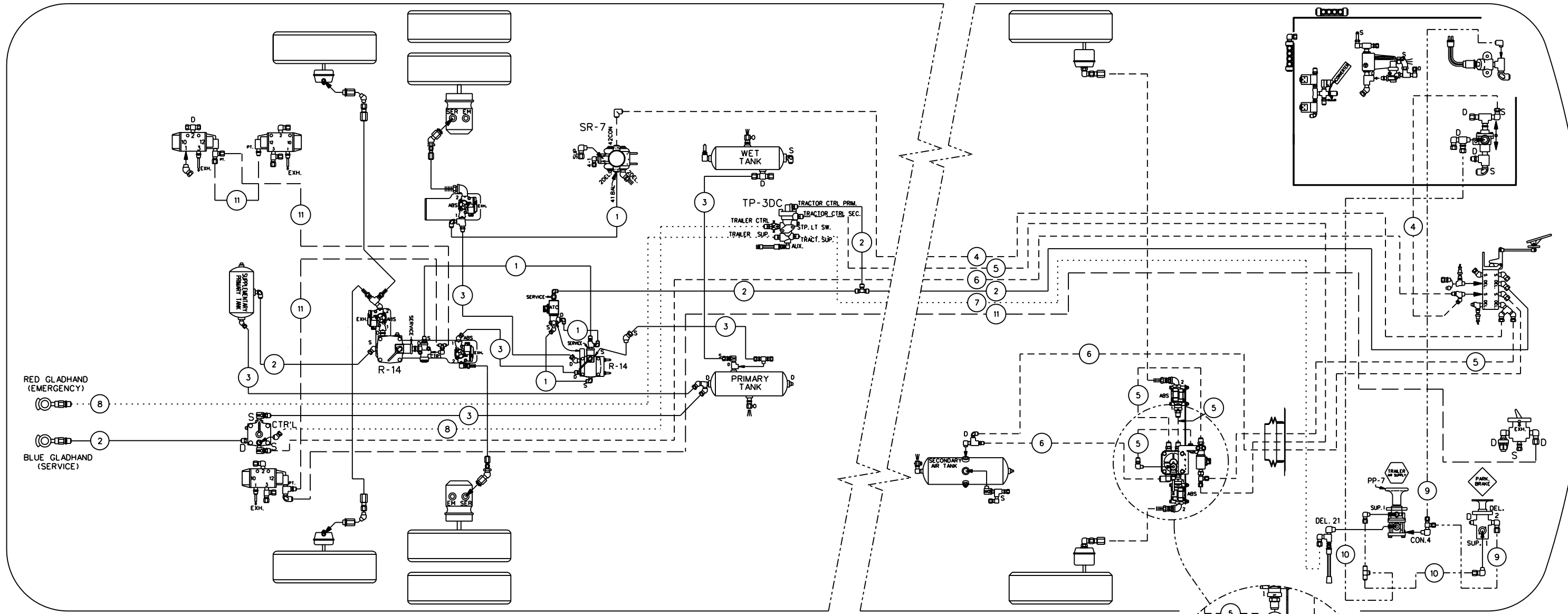

RED GLADHAND
(EMERGENCY)

BLUE GLADHAND
(SERVICE)

BALLOON	PIPE
•1	3/8" O.D. GREEN
•2	1/2" O.D. GREEN
•3	5/8" O.D. GREEN
•4	3/8" O.D. RED
•5	1/2" O.D. RED
•6	5/8" O.D. RED
•7	3/8" O.D. BROWN
•8	1/2" O.D. BROWN
•9	1/4" O.D. YELLOW
•10	3/8" O.D. YELLOW
•11	1/4" O.D. BLACK
•12	5/8" O.D. BLACK

TUBE COLOR CODING	
ACTIVE	CIRCUIT
---	RED SECONDARY
---	GREEN PRIMARY & SUPPLY
---	YELLOW PARKING BRAKE
---	BROWN TRAILER
---	BLACK ACCESSORIES

PREVOST®

DESCRIPTION:

BUS SHELL W5
WITH AIR BRAKES ON TRAILER HITCH
AND ESP OPTION

EFF. W/VEH : #9-9776...

PAGE:

DATE: 2008/12

REV.: C

D140361 P6.1