

PREVOST

Pneumatic diagram

PNEUMATIC DIAGRAMS X3-45 COACHES WITH INDEPENDENT SUSP.

NO:	D140383P0	REVISION :	G
-----	------------------	------------	----------

EFF. OC#	2010001	PRIOR TO OC#	2011095
EFF. VEH#	#B-5002	PRIOR TO VEH#	#C-5212

DR.	R. Bouillon	date	2012-02-07
CHK	Marc-Jose Handfield	appr	Marc-José Handfield

REV.	DATE	DESCRIPTION	PAGE	BY	CHK.	APPR.
A	2010-11-24	Coach X3-45 with Independent Front Suspension IFS, NEW EPA VOLVO ENGINE 2010 Production Vehicle #B-5002...		Rob.	M.J.H.	M.J.H.
B	2011-05-18	#D140383 P4.0 REVISION: B #D140383 P5.0 REVISION: B #D140383 P6.0 REVISION: B #D140383 P8.0 REVISION: B (AHI REPLACED) #D140383 P9.0 REVISION: B (AHI REPLACED) #B-5053 X3-45 PRELIMINARY VEHICLE AHI	P4.0 & 4.1 P5.0 & 5.1 P6.0 & 6.1 P8.0 & 8.1 P9.0 & 9.1	Rob. R.LAM.	M.J.H. M.J.H.	M.J.H. M.J.H.
C	2011-10-04	#D140383 P2.0 Revision: B (UPDATE) #D140383 P11.0 Revision: B (UPDATE) #D140383 P13.0 Revision: B (UPDATE) Effectif #C-5241	P2.0 & 2.1 P11.0&11.1 P13.0&13.1	Rob.	M.J.H.	M.J.H.
D	2011-10-17	#D140383 P 3 Revision B , P 4 , P 5 , P 6 Revision C (Front Height control valve Kneeling, Production Vehicle #C-5170...)	P3.0 & 3.1	Rob.	M.J.H.	M.J.H.
	2012-03-02	#D140383SP3 Special Fast Front Kneeling ; OBSOLETE	P4.0 & 4.1 P5.0 & 5.1 P6.0 & 6.1 SP3.0 & 3.1	M.LAF.	M.J.H	M.J.H.
E	2011-10-31	#D140383 P 3 Revision C , P 4 , P 5 , P 6 Revision D New I.F.S. 19,000 lbs , Production Vehicle #C-5241...	P3.0 & 3.1 P4.0 & 4.1 P5.0 & 5.1 P6.0 & 6.1	Rob.	M.J.H.	M.J.H.

Pneumatic diagram

PNEUMATIC DIAGRAMS X3-45 COACHES WITH INDEPENDENT SUSP.

REV.	DATE	DESCRIPTION	PAGE	BY	CHK.	APPR.
E	2011-10-31	#D140383 P 1 Revision B	P1.1 a 1.4	Rob.	M.J.H.	M.J.H.
F	2011-11-04	VOLVO ENGINE VERSION WITHOUT DRV VALVE	P.8 & 9 P8.1&9.1	Rob.	M.Pelletier	M.Pelletier
G	2012-02-07	#D140383 P1 Revision C (UPDATE)	P1.0 P1.1@1.4	Rob.	M.J.H.	M.J.H.

Pneumatic diagram

PNEUMATIC DIAGRAMS X3-45 COACHES WITH INDEPENDENT SUSP.

PRODUCTION NUMBER	REV	EFF. VEH.	ECN	S.A.V. NUMBER	REV	DESCRIPTION
D140383P1.0	C	#C-5241	2010070	D140383P1.1	C	FULL PNEUMATIC SYSTEM ABS 6
				D140383P1.2	C	ACCESSORIES
				D140383P1.3	C	BRAKES SYSTEM
				D140383P1.4	C	SUSPENSION
D140383P2.0	B	#C-5241		D140383P2.1	B	BRAKE SYSTEM ESP (Electronic Stability Program) OPTION
D140383P3.0	C	#C-5241	2010070	D140383P3.1	C	KNEELING OPTION
D140383P4.0	D	#C-5241	2010070	D140383P4.1	D	KNEELING & LOW-BUOY OPTION
D140383P5.0	D	#C-5241	2010070	D140383P5.1	D	KNEELING & HIGH-BUOY OPTION
D140383P6.0	D	#C-5241	2010070	D140383P6.1	D	KNEELING, LOW-BUOY & HIGH-BUOY OPTION
D140383P7.0	A	#B-5002	2010001	D140383P7.1	A	PARKING BRAKE WITH WCL WITHOUT KNEELING OPTION
D140383P8.0	C	#C-5212	2011095	D140383P8.1	C	ALLISON TRANSMISSION WITHOUT RETARDER OPTION (AHI)
D140383P9.0	C	#C-5212	2011095	D140383P9.1	C	ALLISON TRANSMISSION WITH RETARDER OPTION (AHI)
D140383P10.0	A	#B-5002	2010001	D140383P10.1	A	I-SHIFT TRANSMISSION OPTION
D140383P11.0	B	#C-5241		D140383P11.1	B	I-SHIFT TRANSMISSION & ESP OPTION
D140383P12.0	A	#B-5002	2010001	D140383P12.1	A	HALDEX AIR DRYER OPTION
D140383P13.0	B	#C-5241		D140383P13.1	B	TRAILER HITCH AIR BRAKES AND ESP OPTION (Allison Transm.)
D140383SP1.0	A	#B-5002	2010001	D140383SP1.1	A	"SPECIAL" WITH WABCO AIR DRYER
D140383SP2.0	A	#B-5002	2010001	D140383SP2.1	A	"SPECIAL" WITH OPTION PARKING BRAKE RELEASE WITH SUPPLEMENTARY SWITCH / WHITOUT KNEELING
D140383SP3.0	A	#B-5002	2010001	D140383SP3.1	A	"SPECIAL" WITH FAST FRONT KNEELING; OBSOLETE

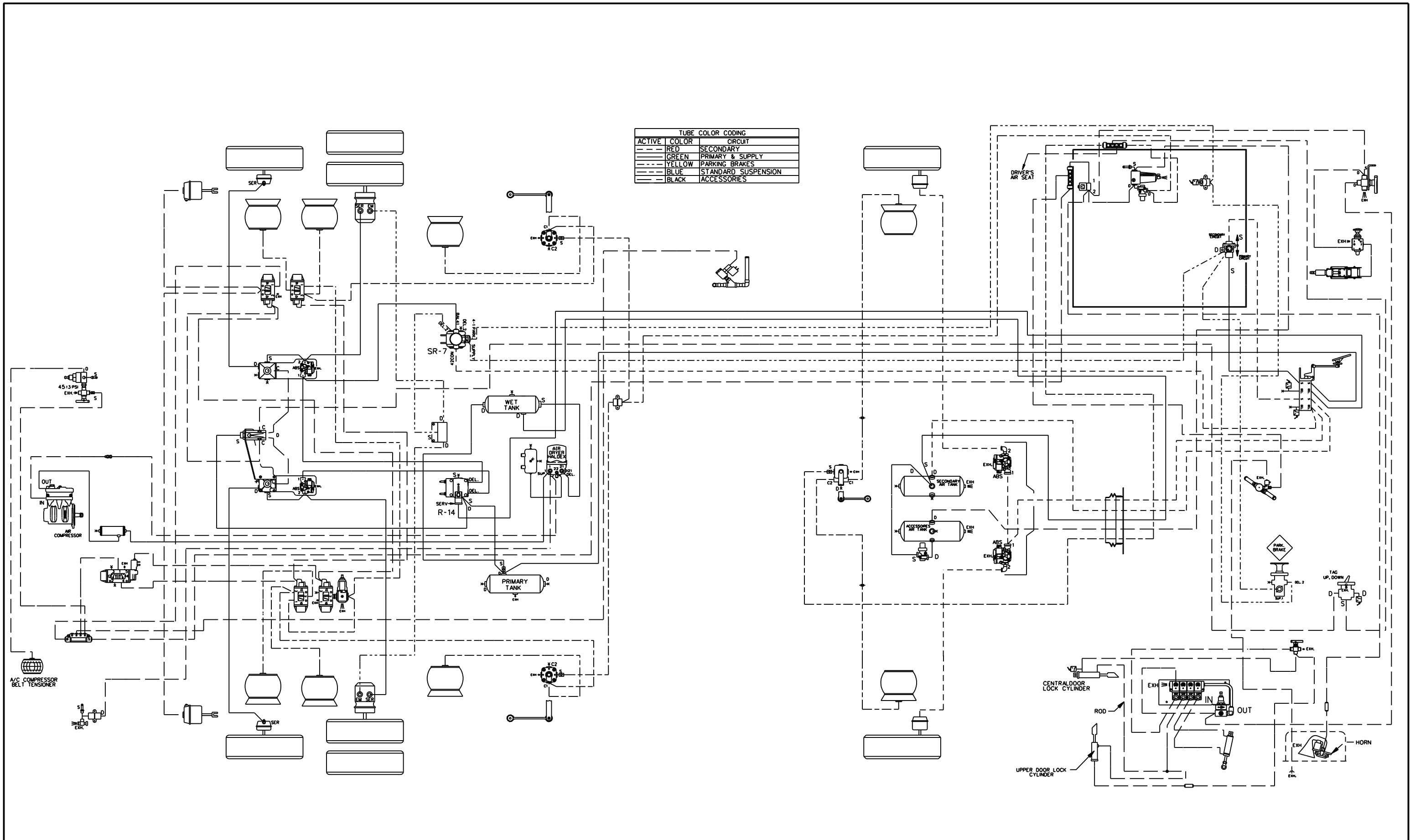

ACTIVE	COLOR	CIRCUIT
---	RED	SECONDARY
---	GREEN	PRIMARY & SUPPLY
---	YELLOW	PARKING BRAKES
---	BLUE	STANDARD SUSPENSION
---	BLACK	ACCESSORIES

PREVOST®

DESCRIPTION:

X3-45 COACH, WITH INDEPENDENT FRONT SUSPENSION (I.F.S.)
FULL PNEUMATIC SYSTEM

REV.:

B

PAGE:

D140383 P1.1

DATE:

2011/10

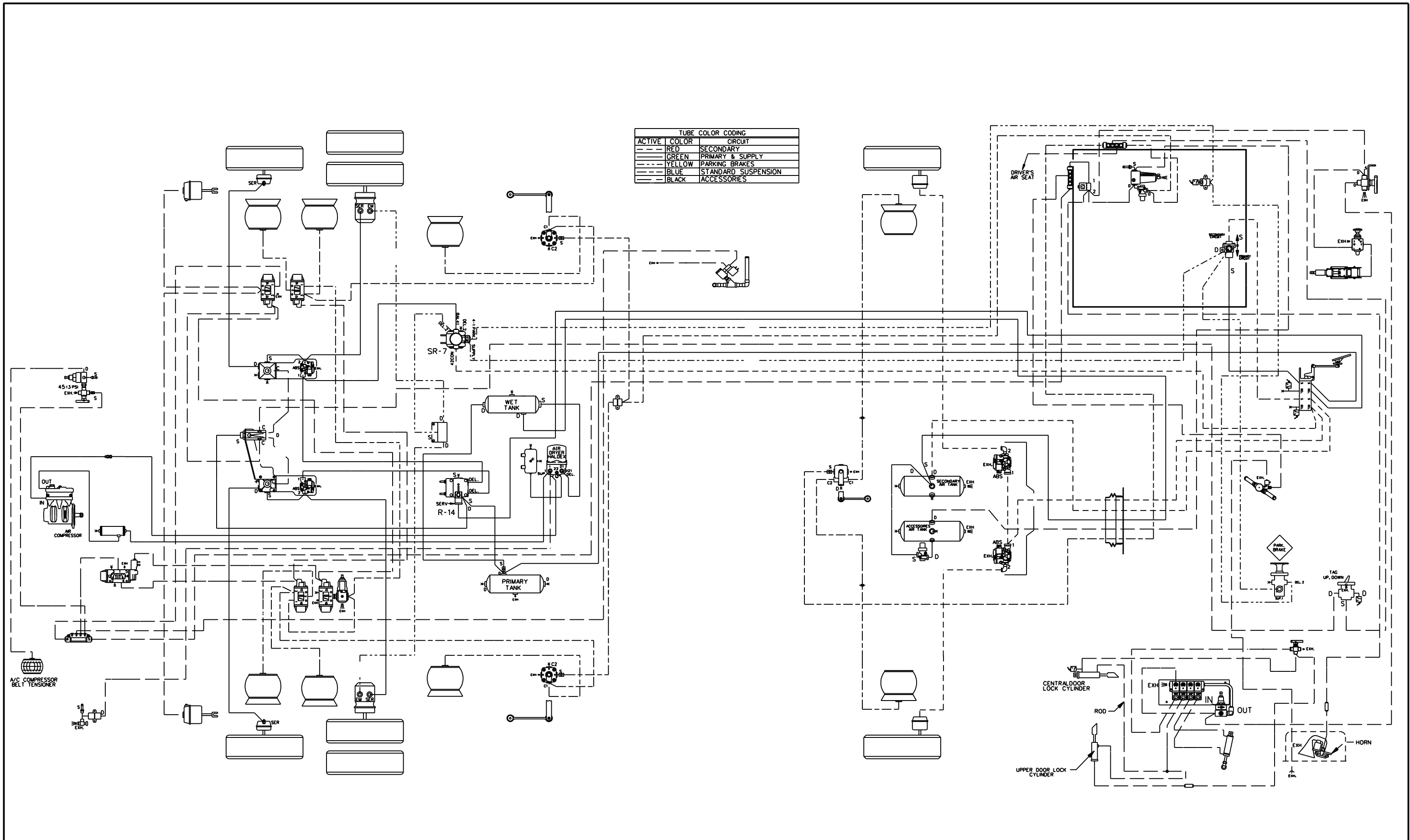

ACTIVE	COLOR	CIRCUIT
---	RED	SECONDARY
---	GREEN	PRIMARY & SUPPLY
---	YELLOW	PARKING BRAKES
---	BLUE	STANDARD SUSPENSION
---	BLACK	ACCESSORIES

PREVOST®

DESCRIPTION:

X3-45 COACH, WITH INDEPENDENT FRONT SUSPENSION (I.F.S.)
FULL PNEUMATIC SYSTEM

REV.:

C

PAGE:

D140383 P1.1

DATE:

2012/02

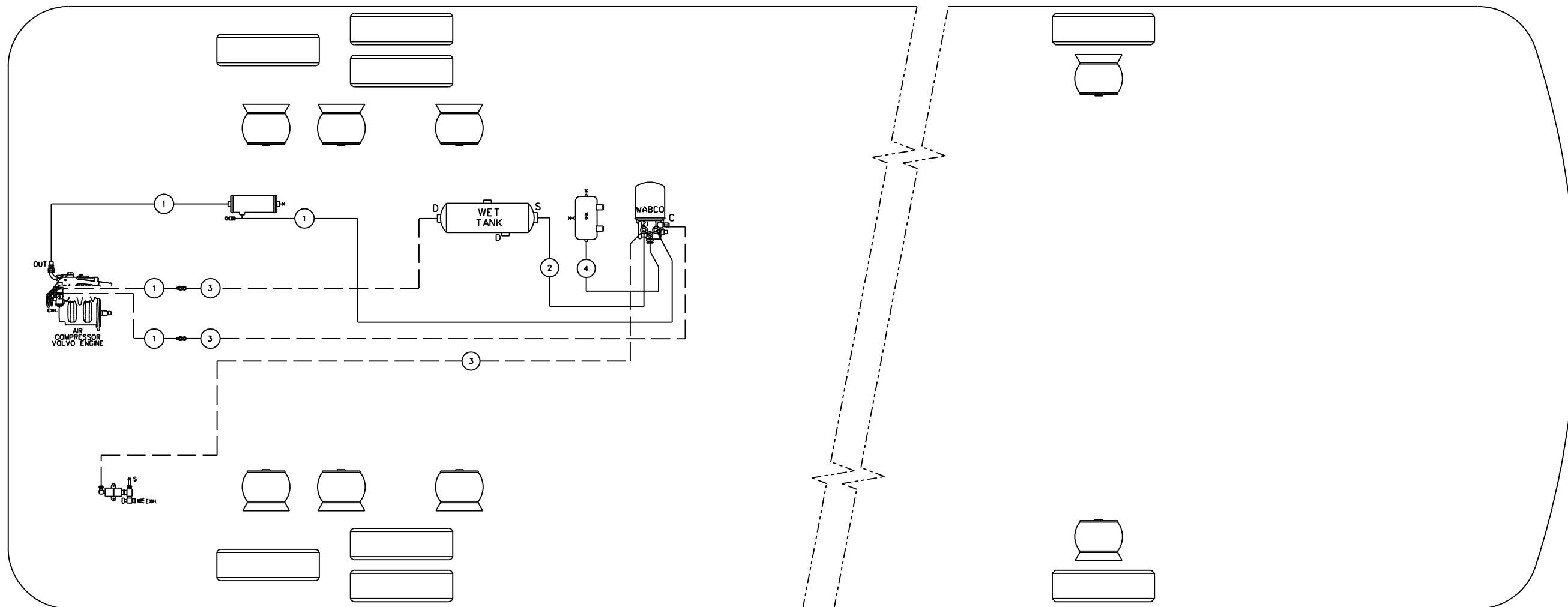

TUBE COLOR CODING	
ACTIVE COLOR	CIRCUIT
— GREEN	PRIMARY & SUPPLY
— BLACK	ACCESSORIES

BALLOON	PIPE
•1	HOSE ASS'Y
•2	3/4" O.D. GREEN
•3	1/4" O.D. BLACK
•4	3/8" O.D. GREY

PREVOST®

DESCRIPTION:

X3-45 COACH, WITH INDEPENDENT FRONT SUSPENSION (I.F.S.) WITH WABCO AIR DRYER

REV.:

A

DATE:

2010/11

PAGE:

D140383 SP1.1

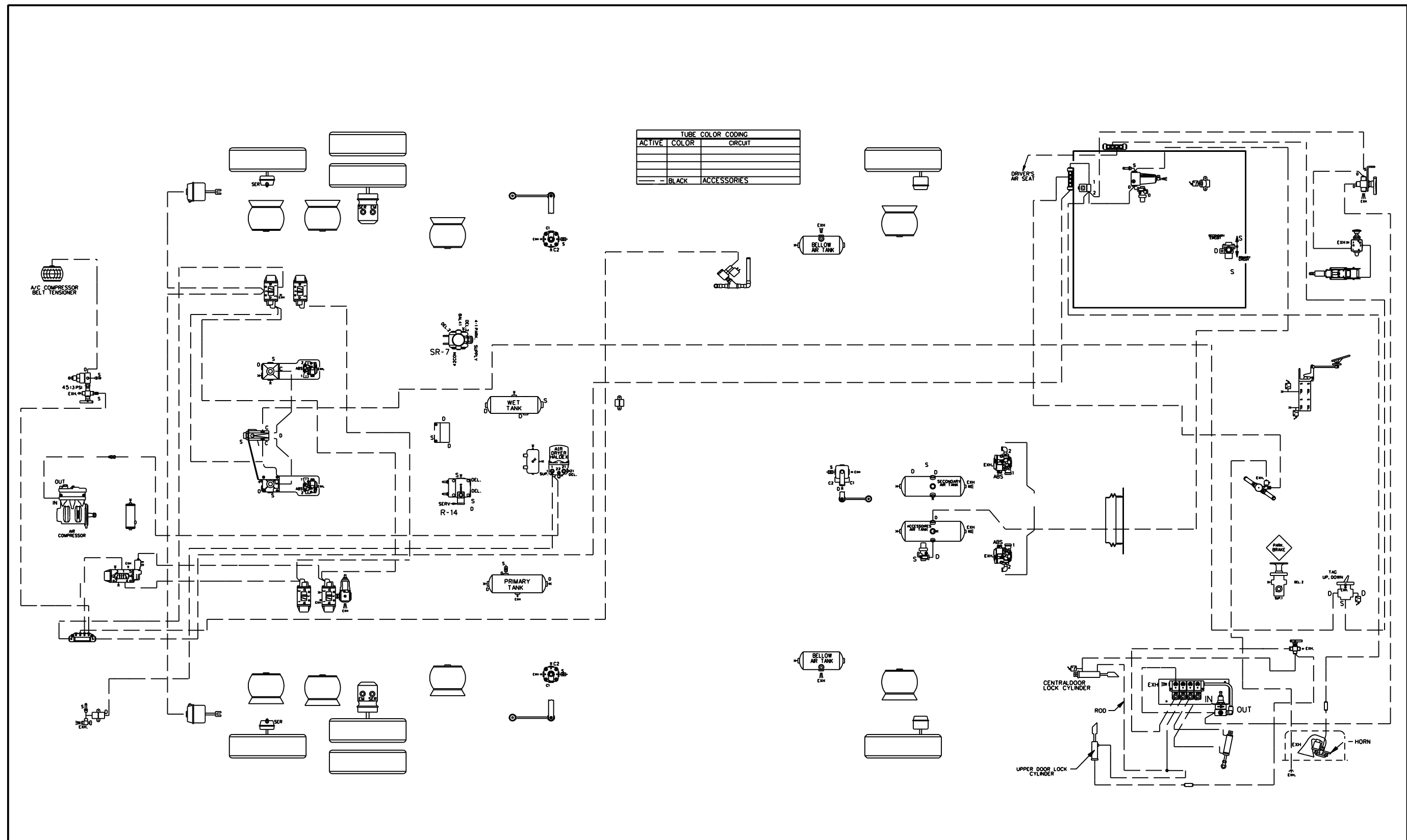

PREVOST®

DESCRIPTION:
X3-45 COACH, WITH INDEPENDENT FRONT SUSPENSION (I.F.S.)
ACCESSORIES

REV.: A
DATE: 2010/11

PAGE:
D140383 P1.2

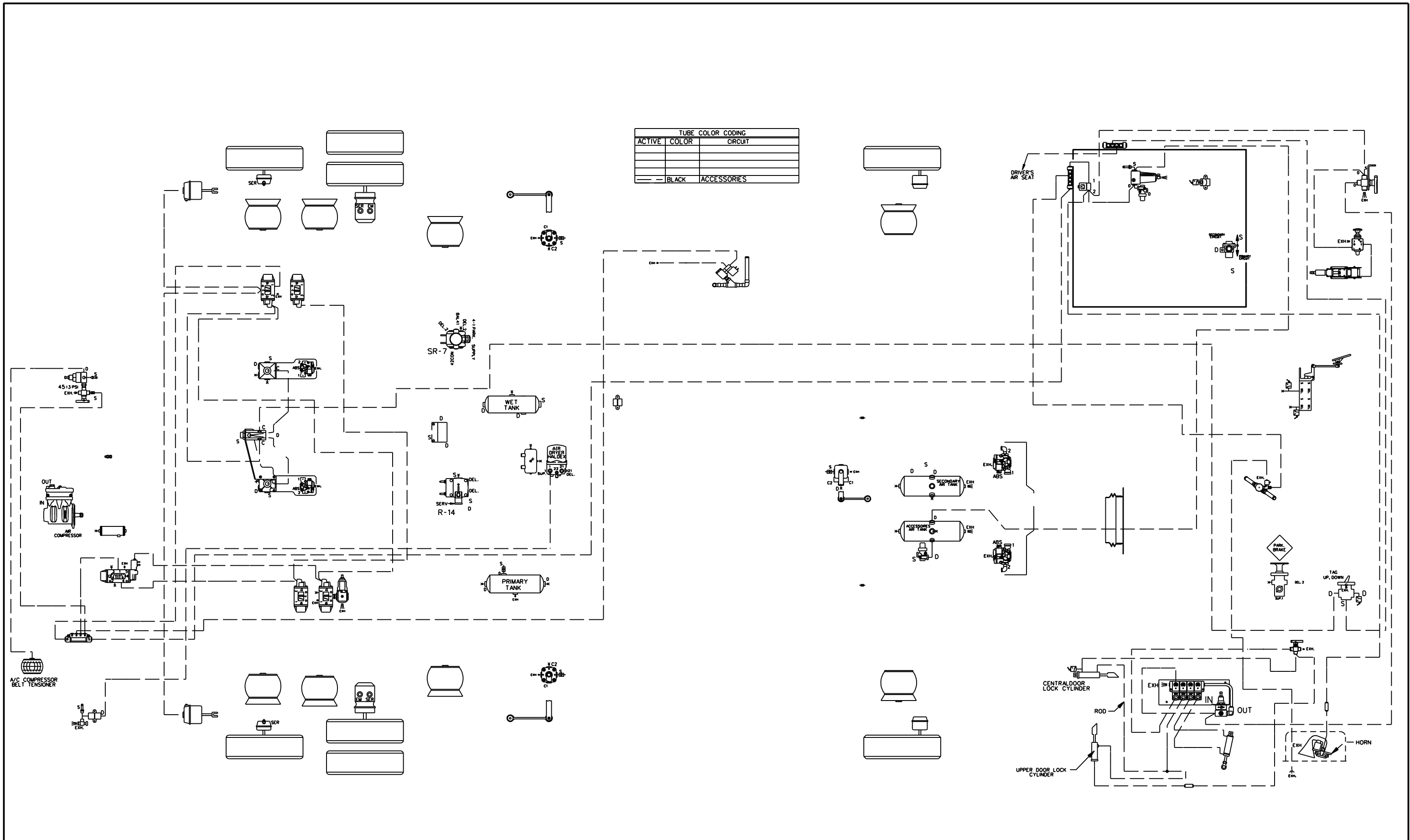

PREVOST®

DESCRIPTION:

X3-45 COACH, WITH INDEPENDENT FRONT SUSPENSION (I.F.S.)
ACCESSORIES

REV.:

C

PAGE:

DATE:

2012/02

D140383 P1.2

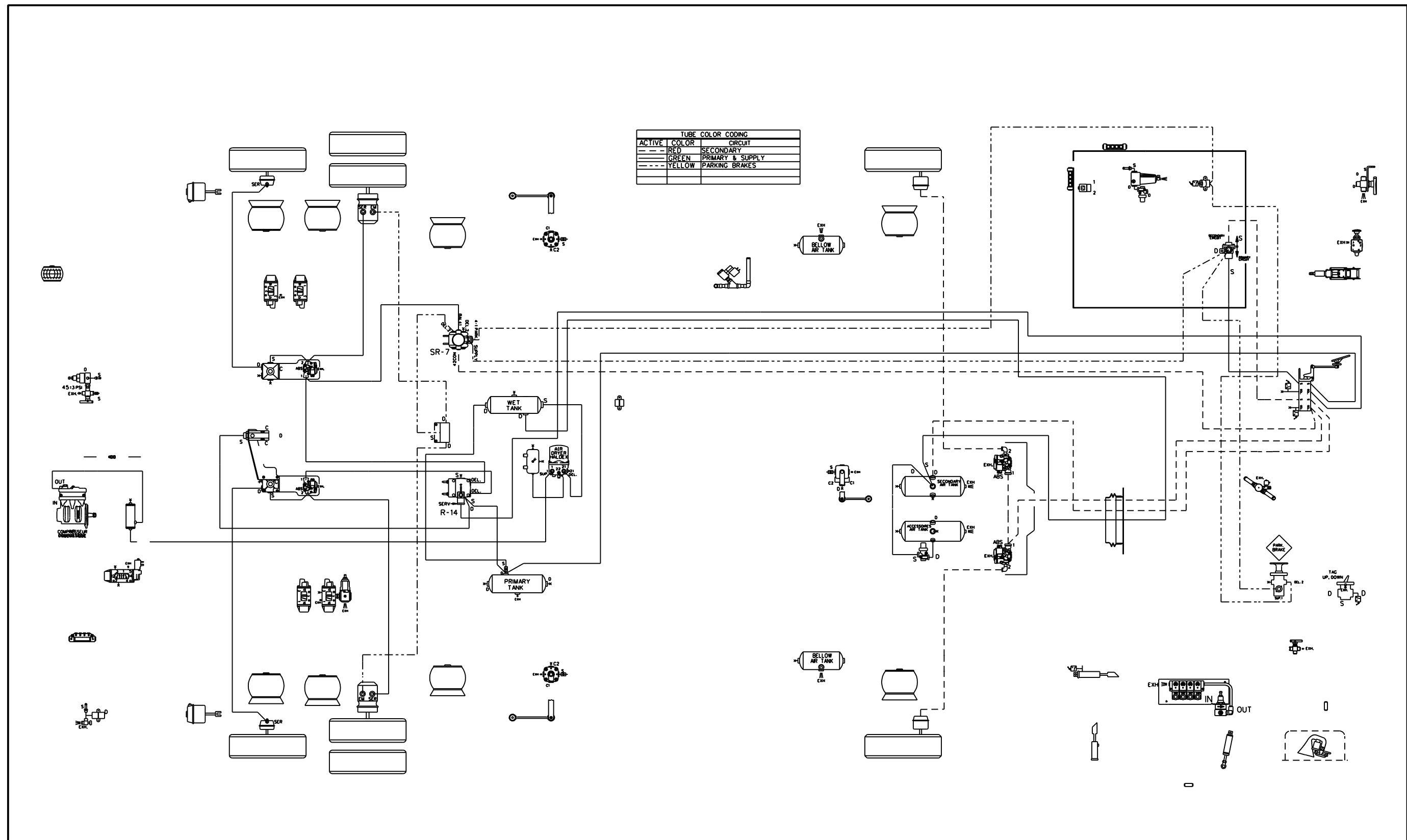

PREVOST®

DESCRIPTION: X3-45 COACH, WITH INDEPENDENT FRONT SUSPENSION (I.F.S.)
BRAKES SYSTEM

REV.: A
DATE: 2010/11

PAGE: D140383 P.1.3

TUBE COLOR CODING		
ACTIVE	COLOR	CIRCUIT
---	RED	SECONDARY
---	GREEN	PRIMARY & SUPPLY
---	YELLOW	PARKING BRAKES

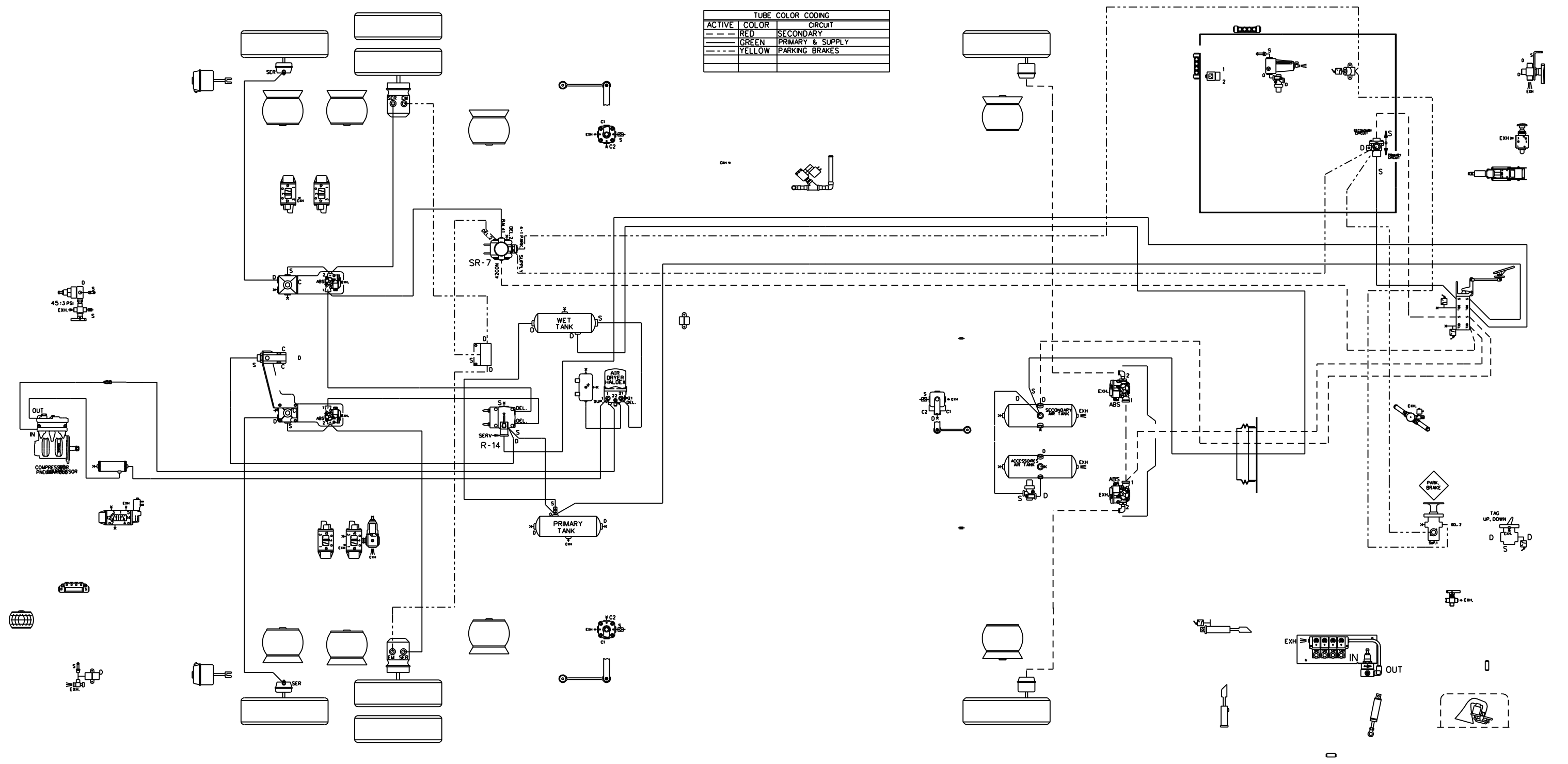

PREVOST®

DESCRIPTION: X3-45 COACH, WITH INDEPENDENT FRONT SUSPENSION (I.F.S.) BRAKES SYSTEM

REV.: C
DATE: 2012/02

PAGE: D140383 P1.3

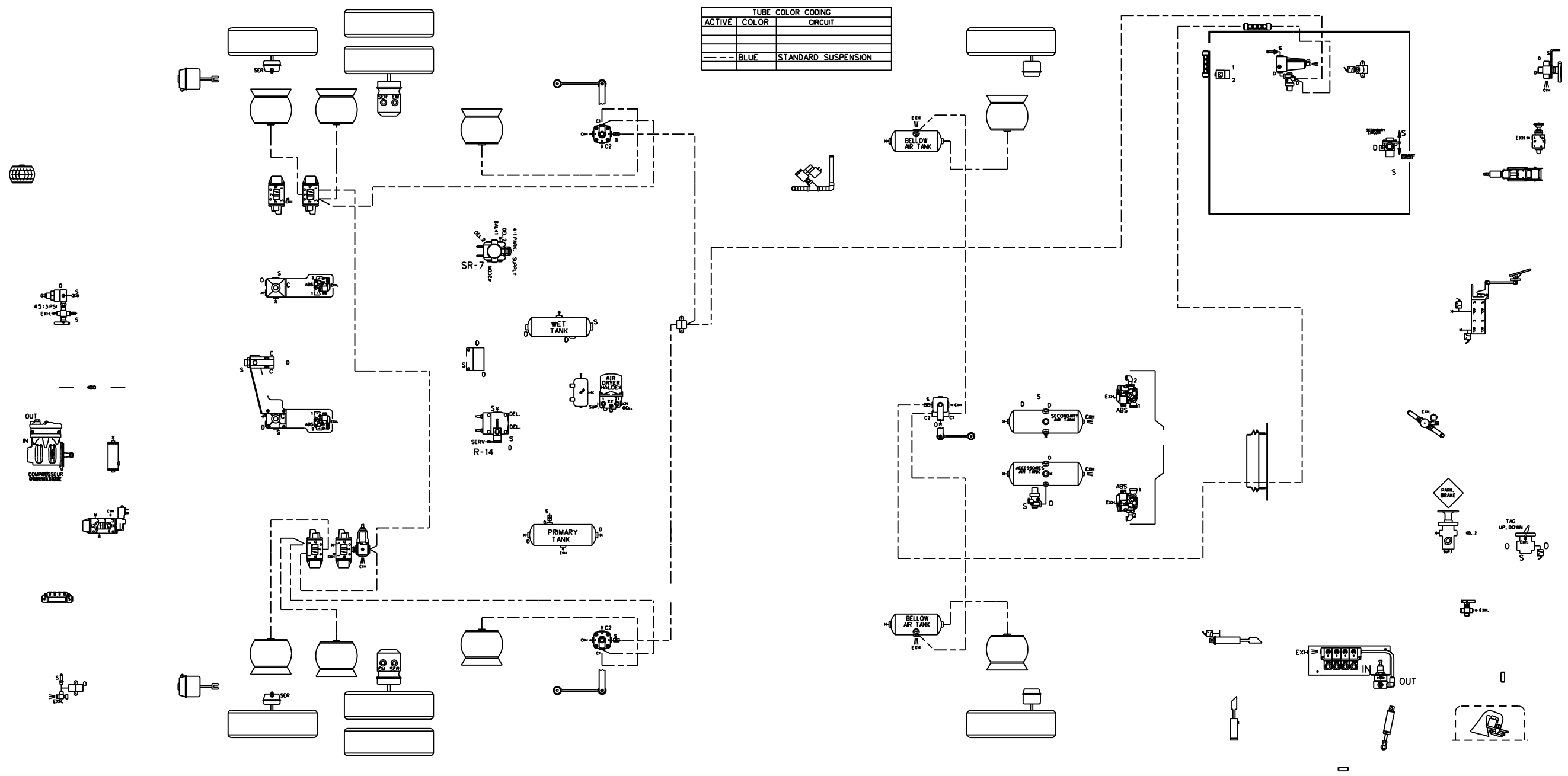

PREVOST®

DESCRIPTION:
X3-45 COACH, WITH INDEPENDENT FRONT SUSPENSION (I.F.S.)
STANDARD SUSPENSION

REV.: A
DATE: 2010/11

PAGE:
D140383 P1.4

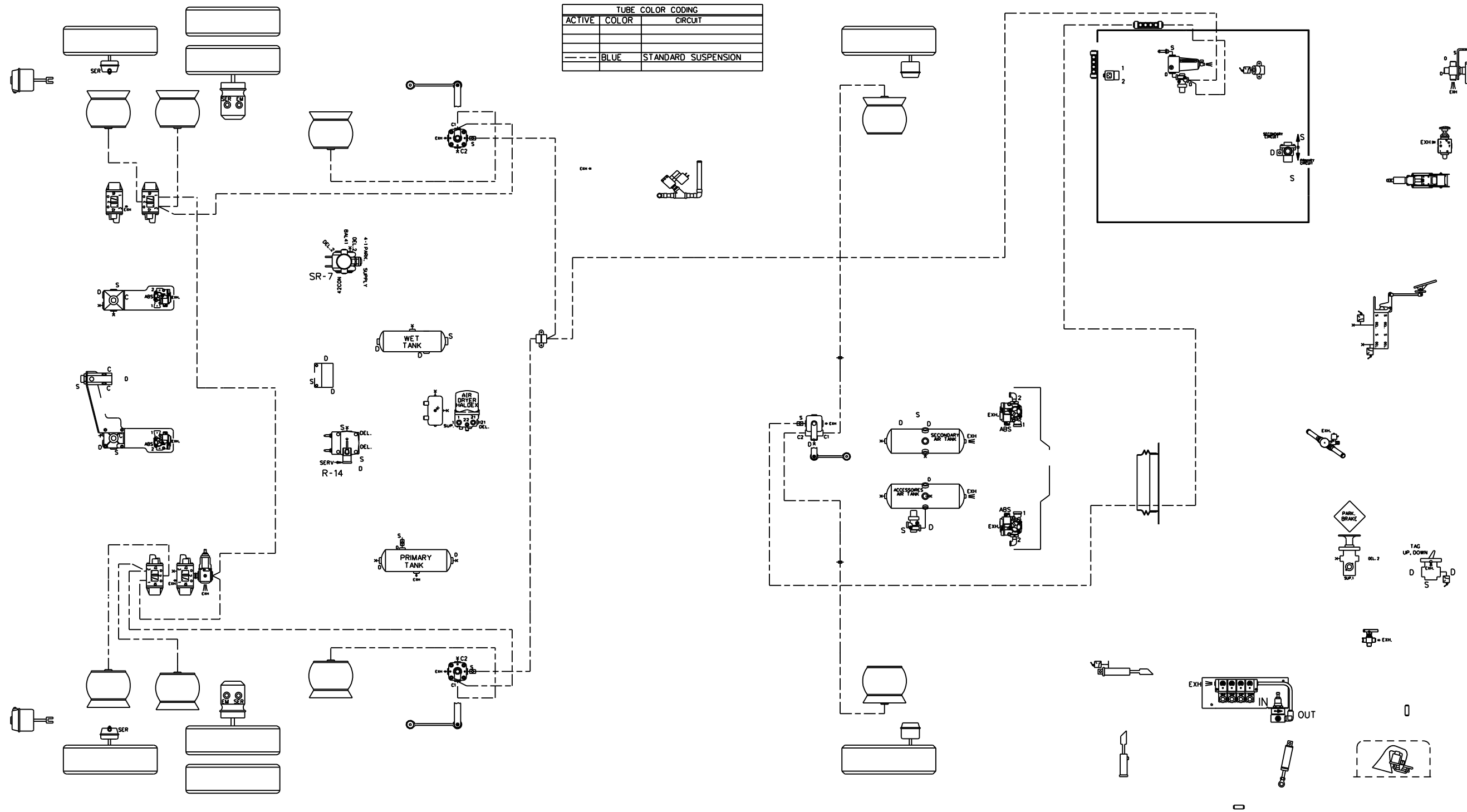

PREVOST®

DESCRIPTION:

X3-45 COACH, WITH INDEPENDENT FRONT SUSPENSION (I.F.S.)
STANDARD SUSPENSION

REV.:

C

PAGE:

DATE:

2012/02

D140383 P1.4

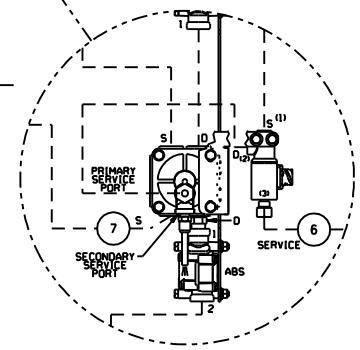
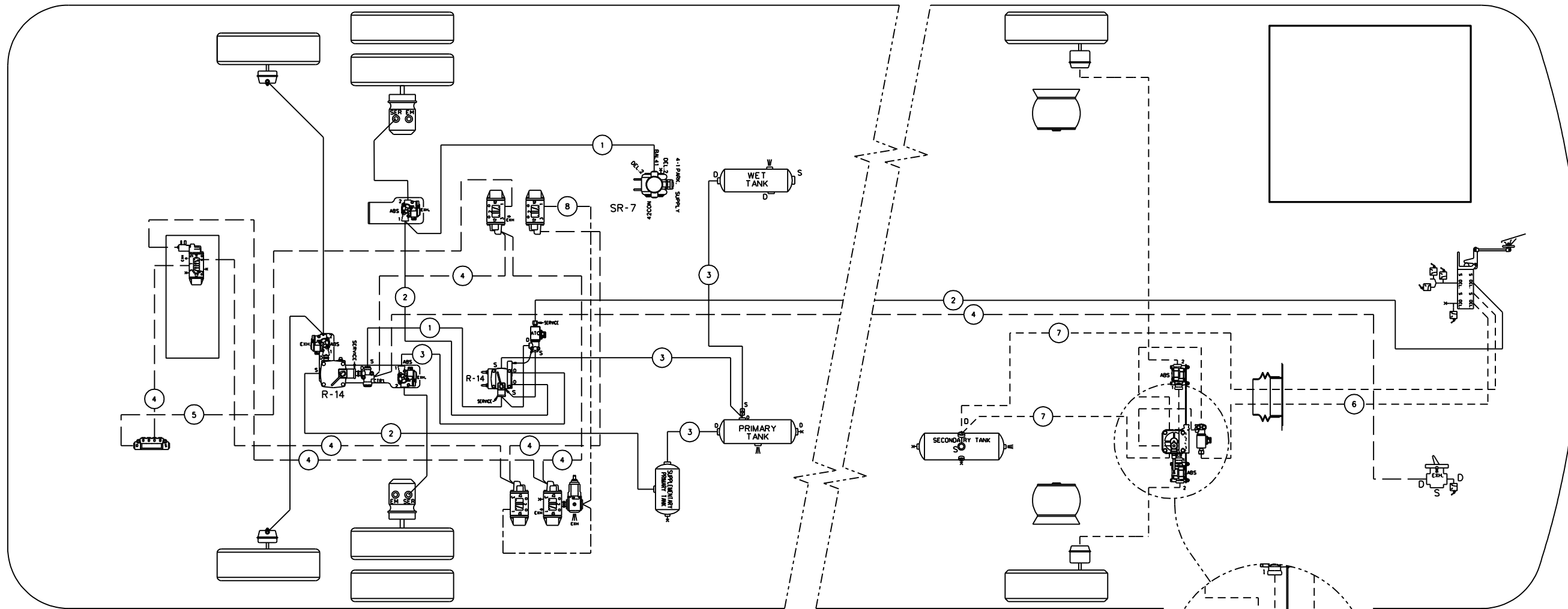

BALLOON	PIPE
*1	3/8" O.D. GREEN
*2	1/2" O.D. GREEN
*3	5/8" O.D. GREEN
*4	1/4" O.D. BLACK
*5	3/8" O.D. BLACK
*6	1/2" O.D. RED
*7	5/8" O.D. RED
*8	3/8" O.D. BLUE

TUBE COLOR CODING		
ACTIVE	COLOR	CIRCUIT
—	GREEN	PRIMARY & SUPPLY
—	BLACK	ACCESSORIES
- - -	RED	SECONDARY

PREVOST®

DESCRIPTION: X3-45 COACH WITH INDEPENDENT FRONT SUSPENSION (I.F.S.), WITH ESP OPTION

REV.: A
DATE: 2010/11

PAGE: D140383 P2.1

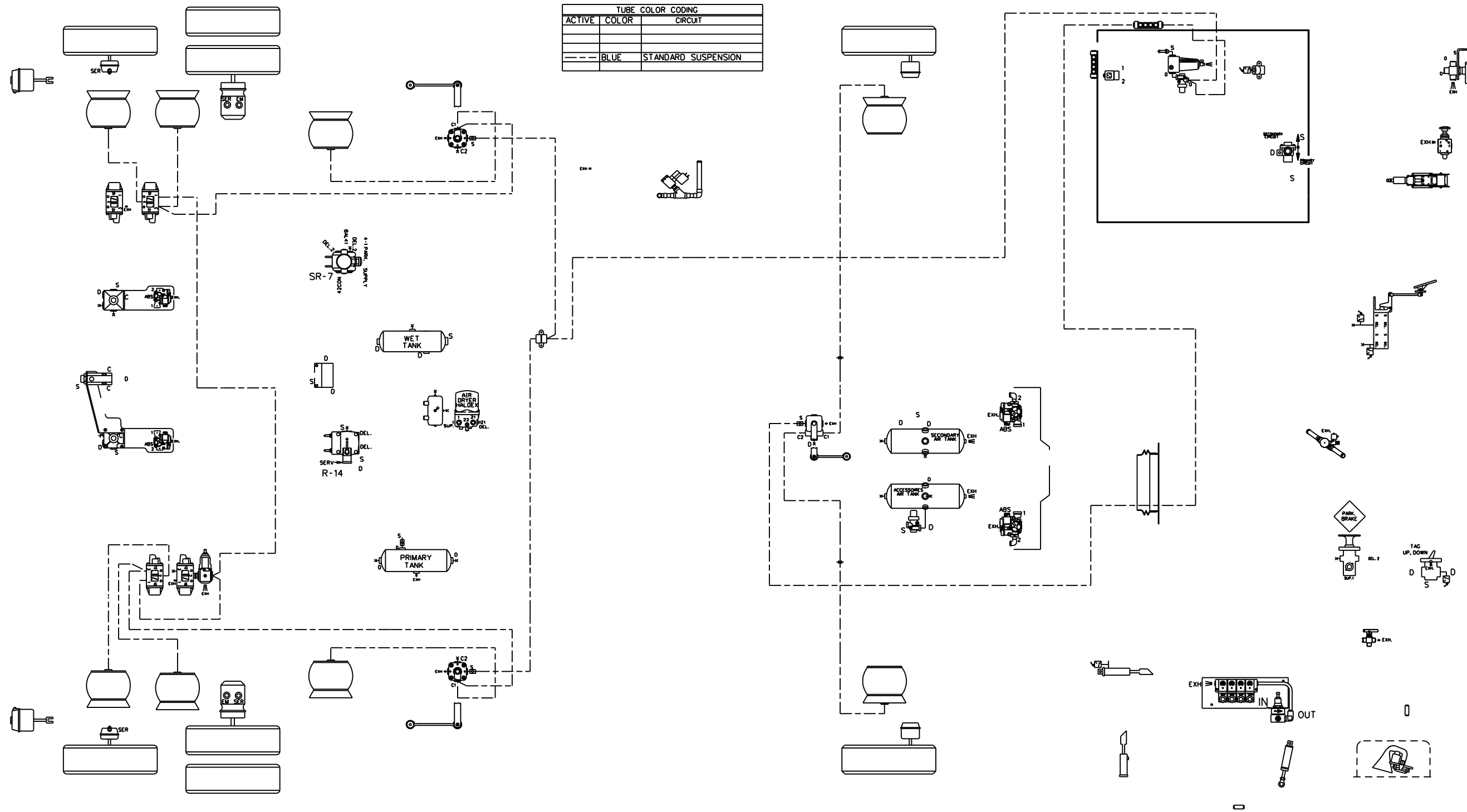

TUBE COLOR CODING		
ACTIVE	COLOR	CIRCUIT
---	BLUE	STANDARD SUSPENSION

PREVOST®

DESCRIPTION:

X3-45 COACH, WITH INDEPENDENT FRONT SUSPENSION (I.F.S.)
STANDARD SUSPENSION

REV.:

C

PAGE:

DATE:

2012/02

D140383 P1.4

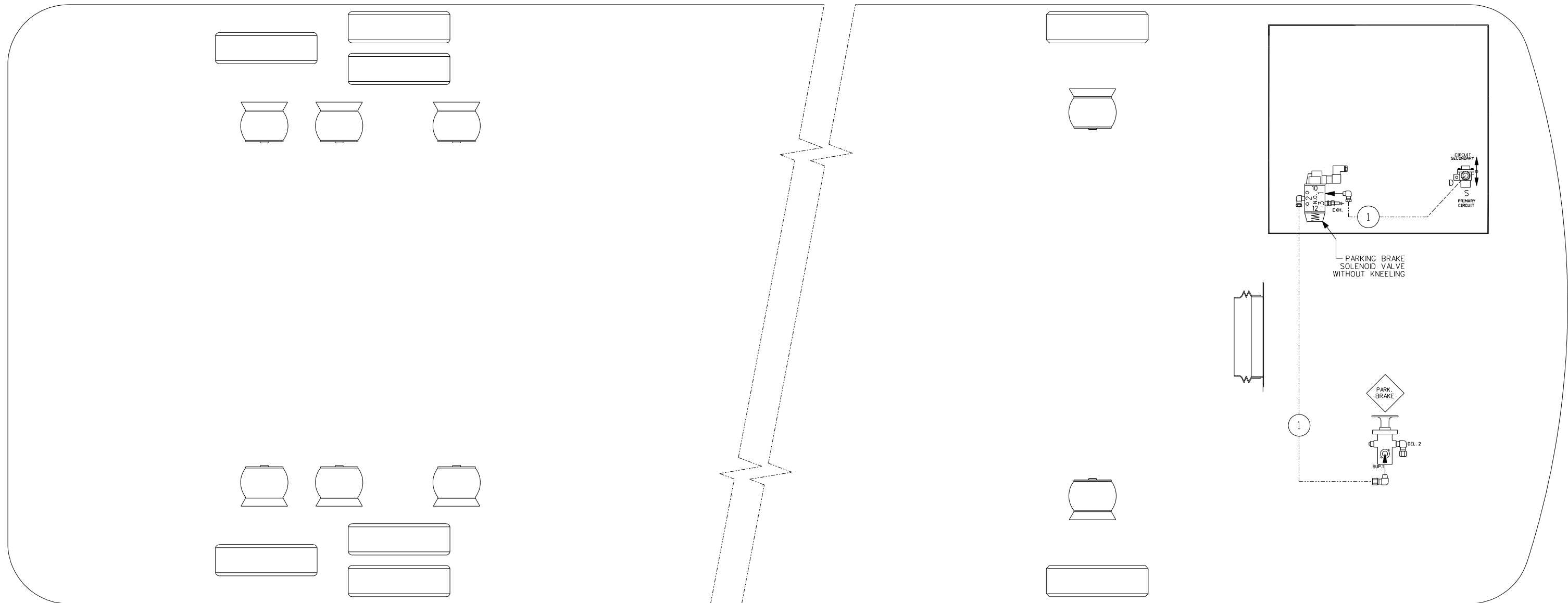

TUBE COLOR CODING		
ACTIVE	COLOR	CIRCUIT
---	YELLOW	PARKING BRAKONNEMENT

BALLOON	PIPE
#1	1/4" O.D. YELLOW

PREVOST[®]

DESCRIPTION: X3-45 COACH, WITH INDEPENDENT FRONT SUSPENSION (I.F.S.) WITH OPTION PARKING BRAKE RELEASE WITH SUPPLEMENTARY SWITCH

REV.: A
DATE: 2010/09

PAGE: D140383 SP2.1

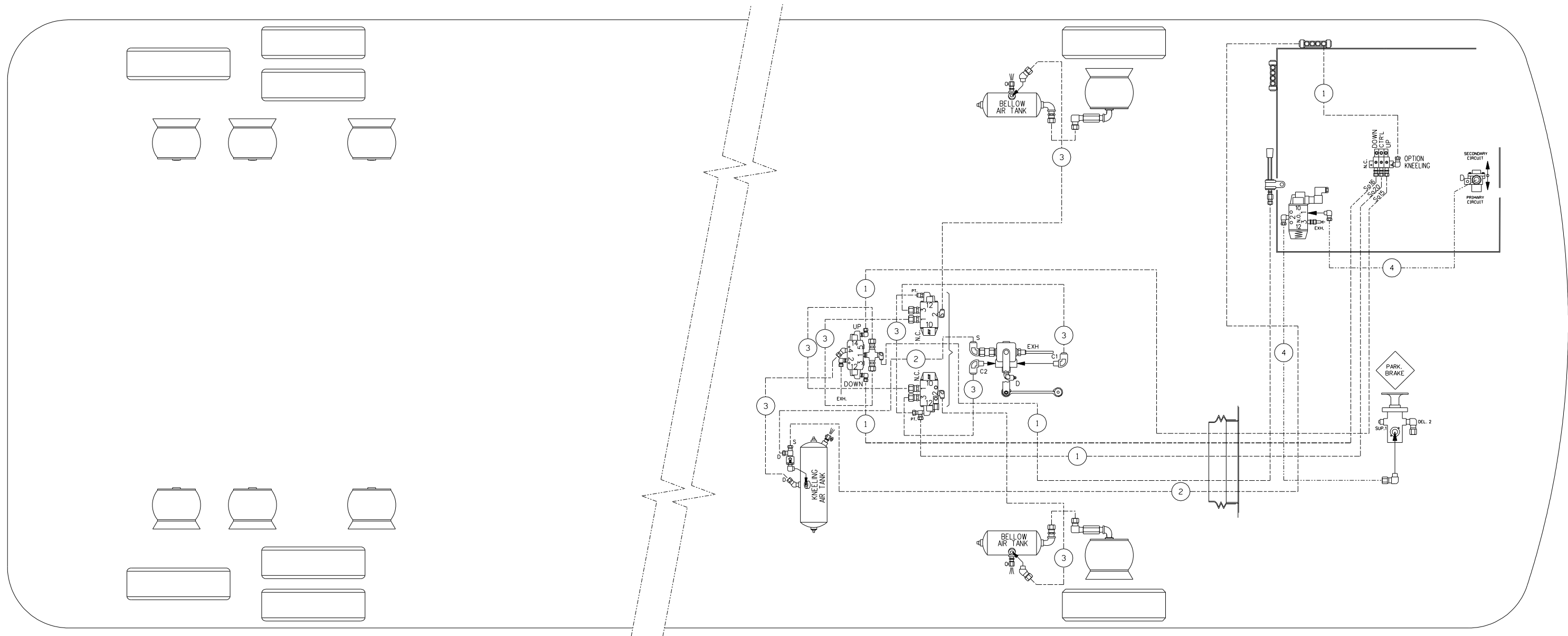

KNEELING SYSTEM = UP (CTR'L + UP ENERGIZED)
 DOWN (CTR'L + DOWN ENERGIZED)

BALLOON	PIPE
#1	1/4" O.D. BLUE
#2	3/8" O.D. BLUE
#3	1/2" O.D. BLUE
#4	3/8" O.D. YELLOW

TUBE COLOR CODING		
LINE TYPE	COLOR	CIRCUIT
---	BLUE	SUSPENSION
---	YELLOW	PARKING BRAKES

PREVOST[®]

DESCRIPTION:

X3-45 COACH, WITH INDEPENDENT FRONT SUSPENSION (I.F.S.)
 WITH OPTION FRONT KNEELING

REV.:

A

DATE:

2010/09

PAGE:

D140383 P3.1

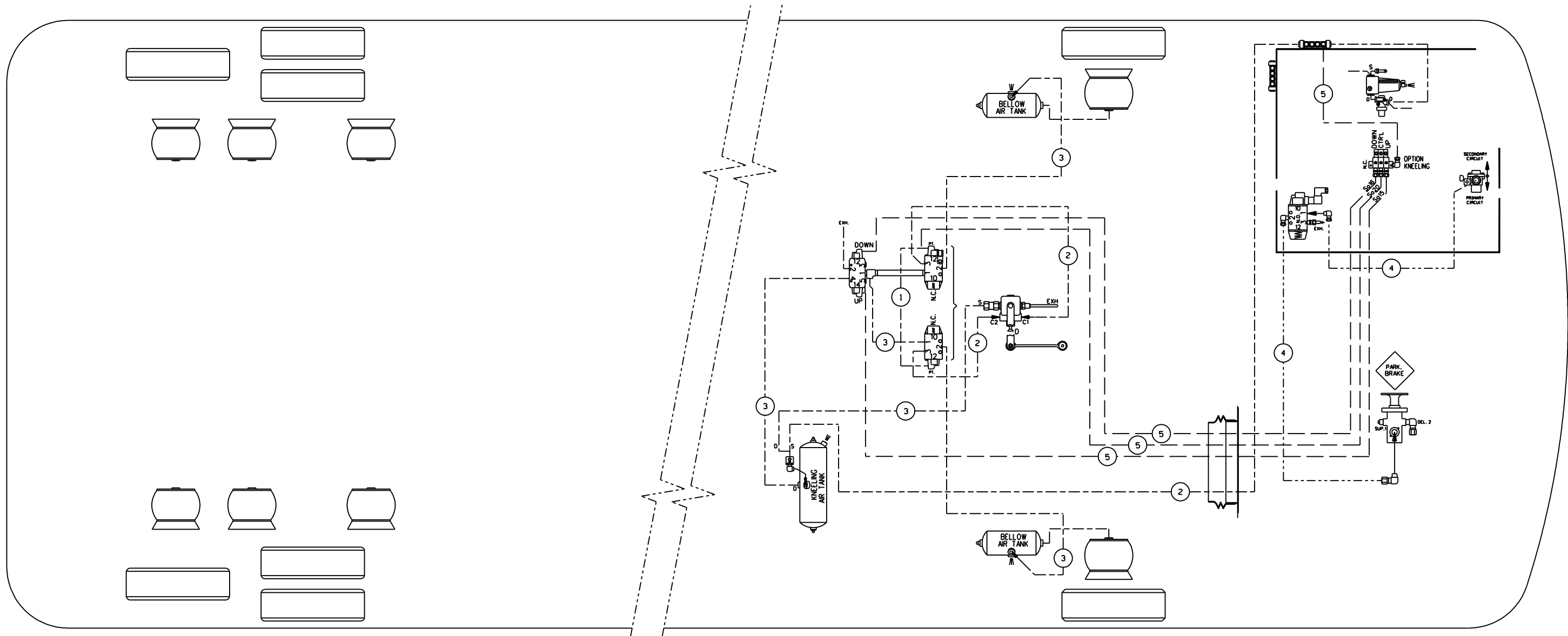

KNEELING SYSTEM = UP (CTR'L + UP ENERGIZED)
 DOWN (CTR'L + DOWN ENERGIZED)

BALLOON	PIPE
*1	1/4" O.D. BLUE
*2	3/8" O.D. BLUE
*3	1/2" O.D. BLUE
*4	3/8" O.D. YELLOW
*5	1/4" O.D. BLACK

TUBE COLOR CODING		
LINE TYPE	COLOR	CIRCUIT
---	BLUE	SUSPENSION
---	YELLOW	PARKING BRAKES
---	BLACK	ACCESSORIES FOR SUSPENSION

PREVOST®

DESCRIPTION:

X3-45 COACH, WITH INDEPENDENT FRONT SUSPENSION (I.F.S.)
 WITH OPTION FRONT KNEELING

REV.:

B

DATE:

2011/10

PAGE:

D140383 P3.1

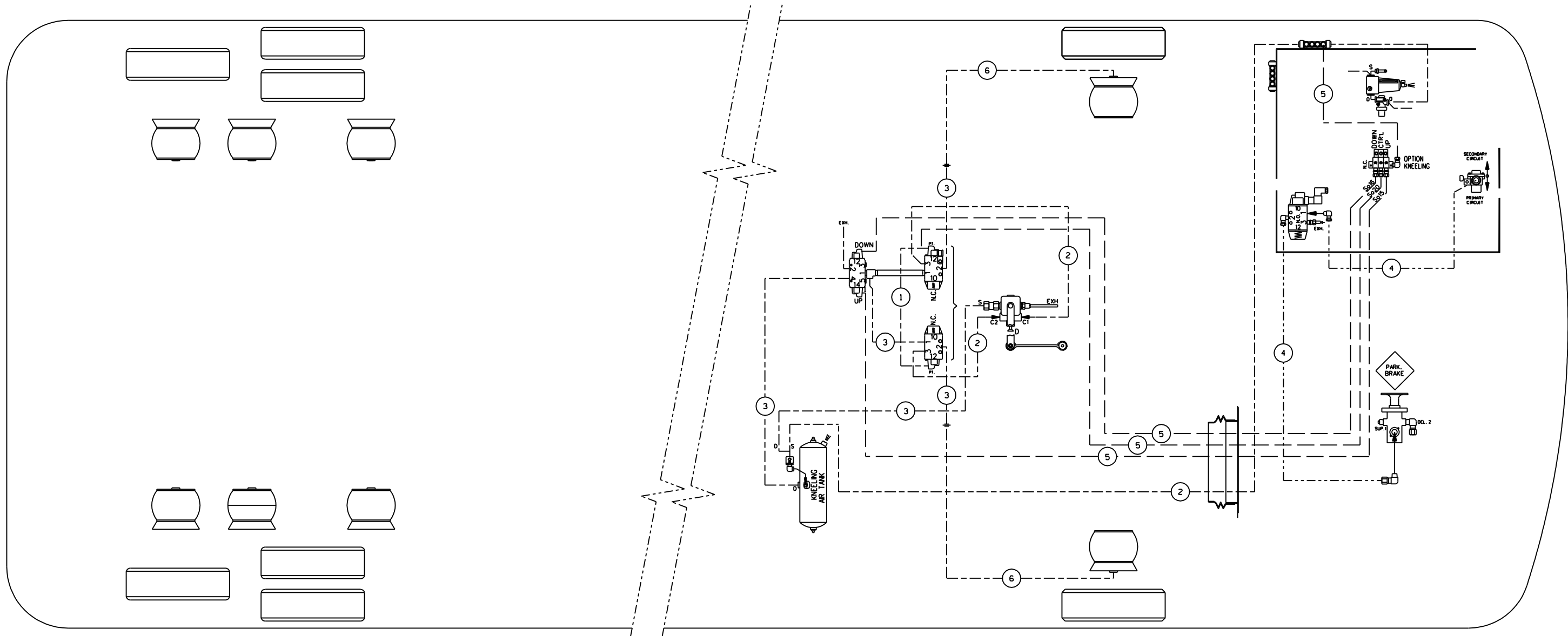

KNEELING SYSTEM = UP (CTR'L + UP ENERGIZED)
 DOWN (CTR'L + DOWN ENERGIZED)

BALLOON	PIPE
*1	1/4" O.D. BLUE
*2	3/8" O.D. BLUE
*3	1/2" O.D. BLUE
*4	3/8" O.D. YELLOW
*5	1/4" O.D. BLACK
*6	HOSE ASSY *8

TUBE COLOR CODING		
LINE TYPE	COLOR	CIRCUIT
---	BLUE	SUSPENSION
---	YELLOW	PARKING BRAKES
---	BLACK	ACCESSORIES FOR SUSPENSION

PREVOST®

DESCRIPTION:

X3-45 COACH, WITH INDEPENDENT FRONT SUSPENSION (I.F.S.)
 WITH OPTION FRONT KNEELING

REV.:

C

DATE:

2011/10

PAGE:

D140383 P3.1

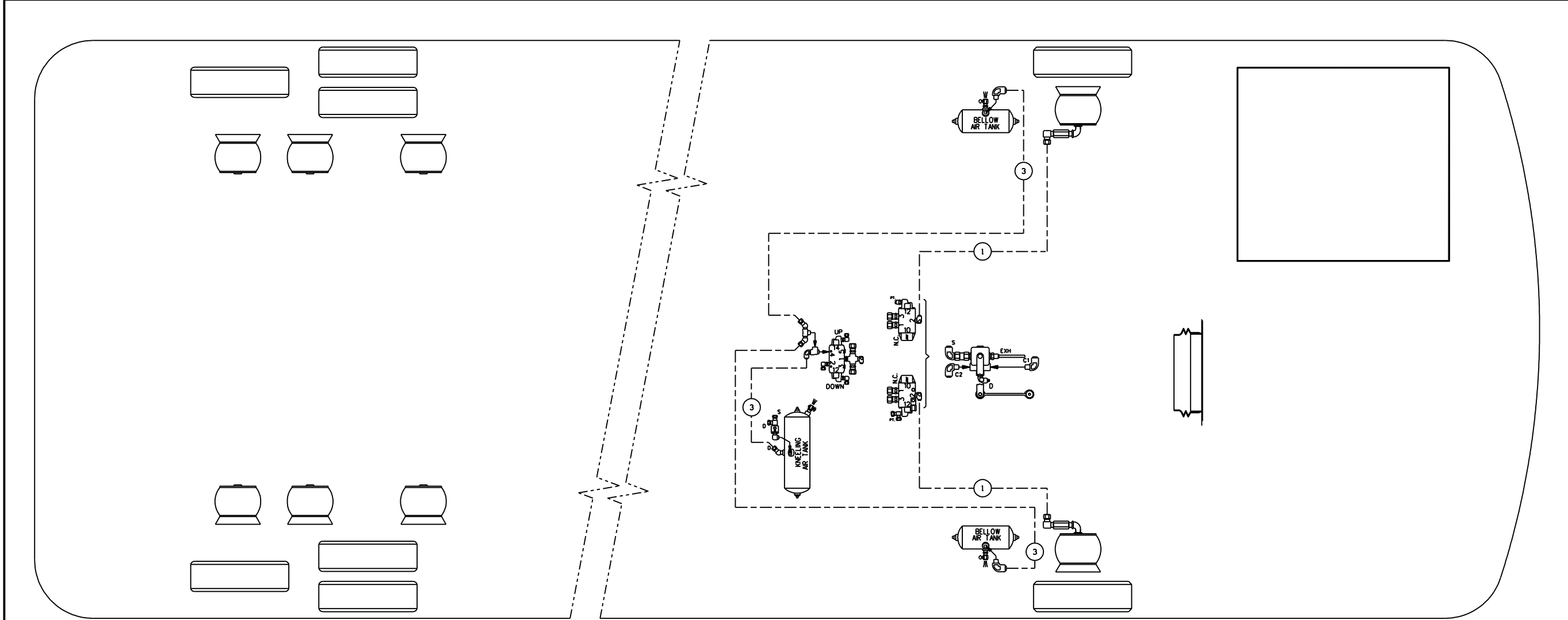

BALLOON	PIPE	TUBE COLOR CODING	
		LINE TYPE	CIRCUIT
*1	1/2" O.D. BLUE	---	BLUE
		---	SUSPENSION

PREVOST®

DESCRIPTION: X3-45 COACH, WITH INDEPENDENT FRONT SUSPENSION (I.F.S.)
SPECIAL WITH FAST FRONT KNEELING

REV.: A
DATE: 2010/11

PAGE: D140383 SP3.1

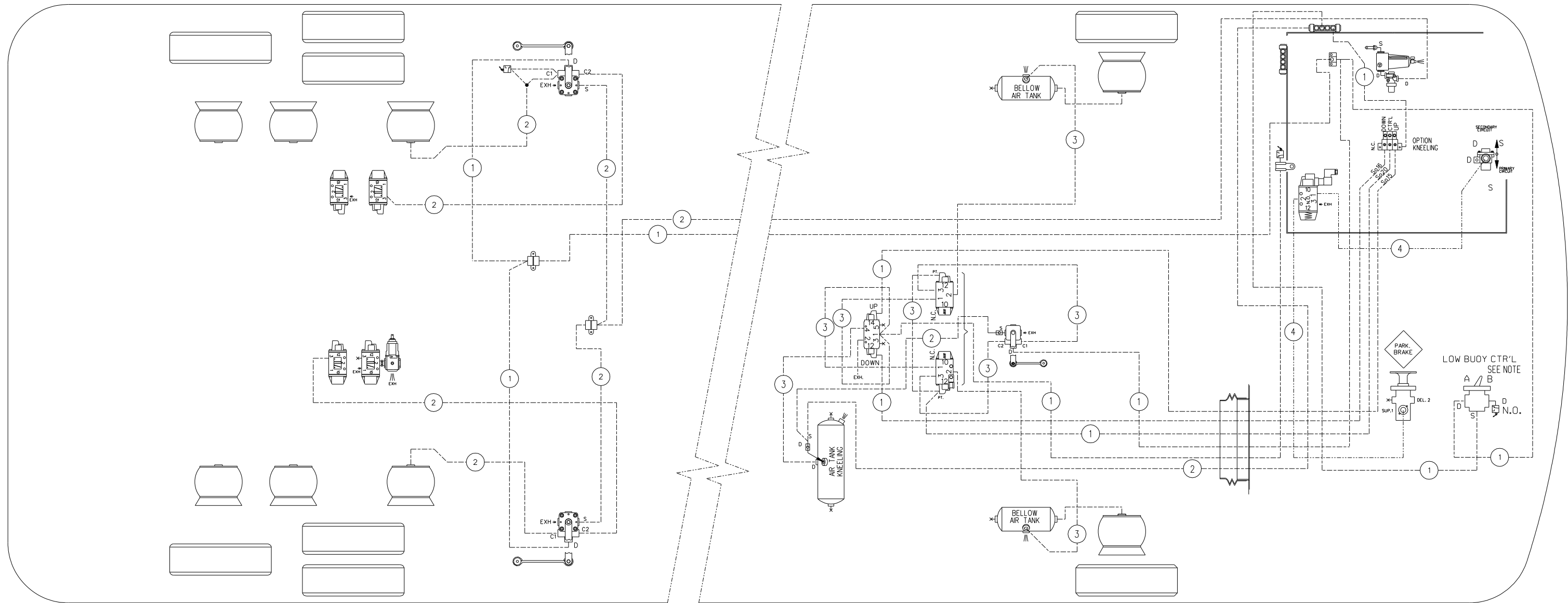

BALLOON	PIPE
#1	1/4" O.D. BLUE
#2	3/8" O.D. BLUE
#3	1/2" O.D. BLUE
#4	3/8" O.D. YELLOW

TUBE COLOR CODING		
LINE TYPE	COLOR	CIRCUIT
---	BLUE	SUSPENSION
---	YELLOW	PARKING BRAKES

NOTE:

CONTROL VALVE OPT. "LOW-BUOY" , "A" OR "B" SETTING:

POSITION "A": VALVE IS OPEN,
AIR FLOW BETWEEN SUPPLY (S) AND
DELIVERY (D) , LOW-BUOY IS IN FUNCTION.

POSITION "B": VALVE CLOSED,
AIR DOES'NT FLOW BETWEEN SUPPLY (S) AND
DELIVERY (D) , LOW-BUOY IS NOT IN FUNCTION.

PREVOST®

DESCRIPTION:

X3-45 COACH, WITH INDEPENDENT FRONT SUSPENSION (I.F.S.) WITH
OPTION FRONT KNEELING & LOW-BUOY COMBINATION

REV.:

A

DATE:

2010/09

PAGE:

D140383 P4.1

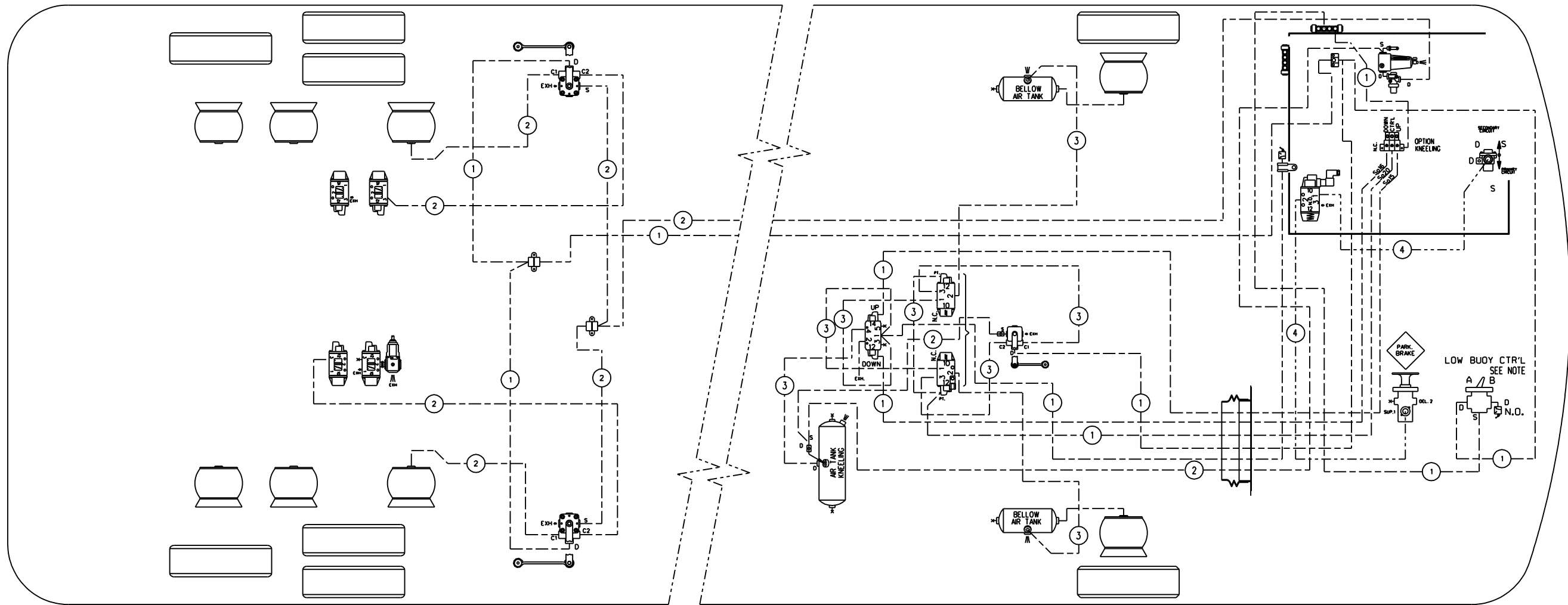

BALLOON	PIPE
*1	1/4" O.D. BLUE
*2	3/8" O.D. BLUE
*3	1/2" O.D. BLUE
*4	3/8" O.D. YELLOW

TUBE COLOR CODING		
LINE TYPE	COLOR	CIRCUIT
---	BLUE	SUSPENSION
---	YELLOW	PARKING BRAKES

NOTE:

CONTROL VALVE OPT. "LOW-BUOY" , "A" OR "B" SETTING:

POSITION "A": VALVE IS OPEN,
AIR FLOW BETWEEN SUPPLY (S) AND
DELIVERY (D) , LOW-BUOY IS IN FUNCTION.

POSITION "B": VALVE CLOSED,
AIR DOES'NT FLOW BETWEEN SUPPLY (S) AND
DELIVERY (D) , LOW-BUOY IS NOT IN FUNCTION.

PREVOST®

DESCRIPTION:
X3-45 COACH, WITH INDEPENDENT FRONT SUSPENSION (I.F.S.) WITH
OPTION FRONT KNEELING & LOW-BUOY COMBINATION

REV.: B
DATE: 2011/04

PAGE:
D140383 P4.1

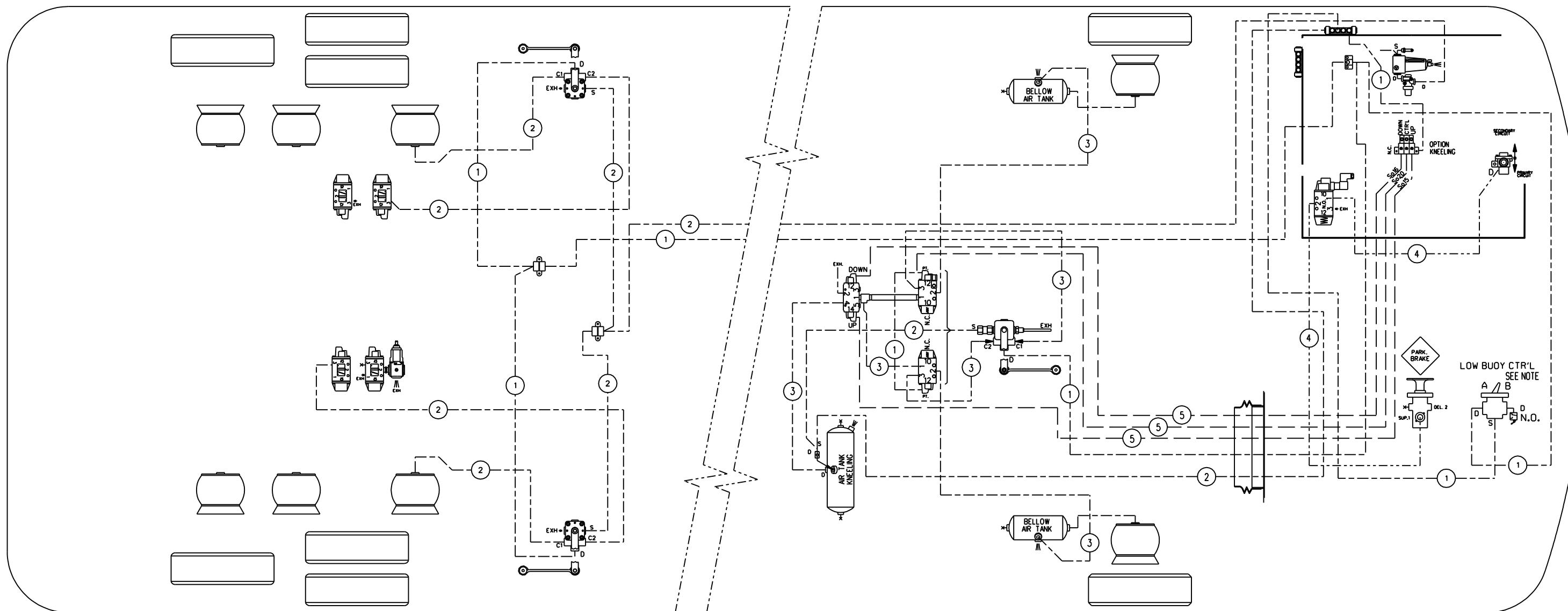

BALLOON	PIPE
*1	1/4" O.D. BLUE
*2	3/8" O.D. BLUE
*3	1/2" O.D. BLUE
*4	3/8" O.D. YELLOW
*5	1/4" O.D. BLACK

TUBE COLOR CODING		
LINE TYPE	COLOR	CIRCUIT
---	BLUE	SUSPENSION
---	YELLOW	PARKING BRAKES

NOTE:

CONTROL VALVE OPT. "LOW-BUOY" , "A" OR "B" SETTING:

POSITION "A": VALVE IS OPEN,
AIR FLOW BETWEEN SUPPLY (S) AND
DELIVERY (D) , LOW-BUOY IS IN FUNCTION.

POSITION "B": VALVE CLOSED,
AIR DOES'NT FLOW BETWEEN SUPPLY (S) AND
DELIVERY (D) , LOW-BUOY IS NOT IN FUNCTION.

PREVOST®

DESCRIPTION:

X3-45 COACH, WITH INDEPENDENT FRONT SUSPENSION (I.F.S.) WITH
OPTION FRONT KNEELING & LOW-BUOY COMBINATION

REV.:

C

PAGE:

D140383 P4.1

DATE:

2011/10

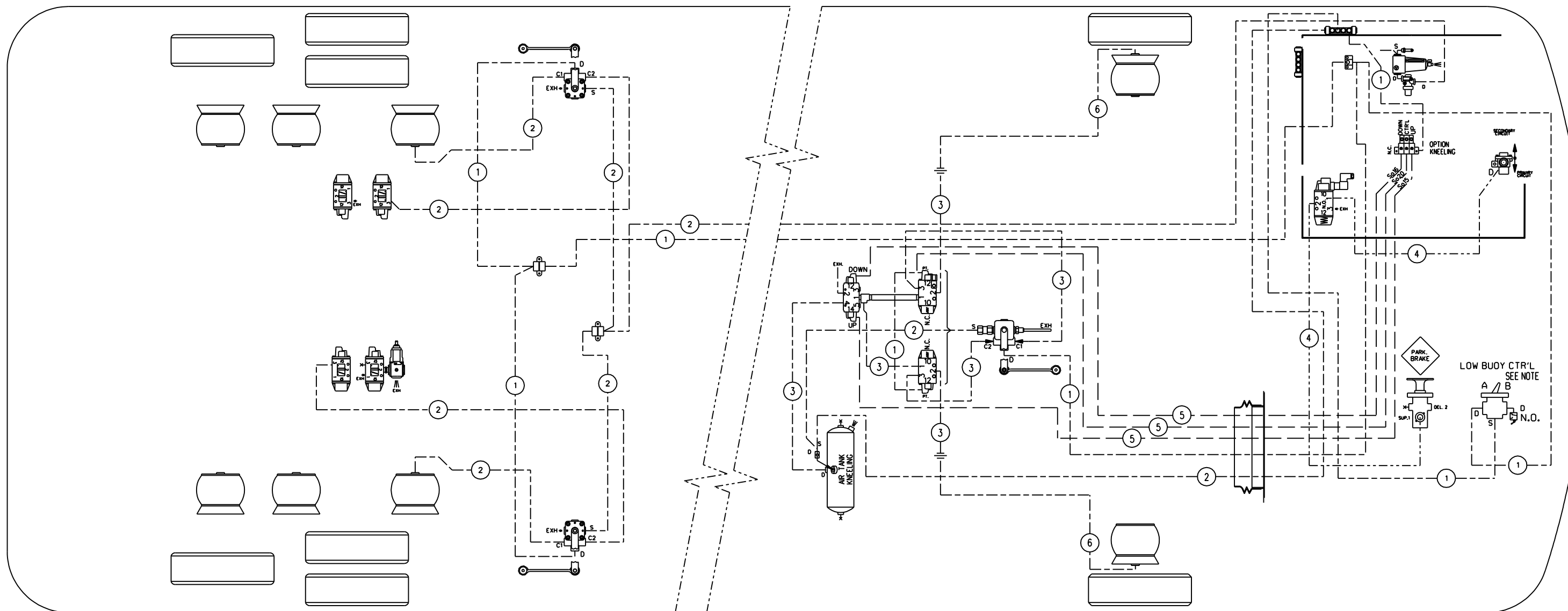

BALLOON	PIPE
*1	1/4" O.D. BLUE
*2	3/8" O.D. BLUE
*3	1/2" O.D. BLUE
*4	3/8" O.D. YELLOW
*5	1/4" O.D. BLACK
*6	HOSE ASSY * 8

TUBE COLOR CODING		
LINE TYPE	COLOR	CIRCUIT
---	BLUE	SUSPENSION
---	YELLOW	PARKING BRAKES

NOTE:

CONTROL VALVE OPT. "LOW-BUOY" , "A" OR "B" SETTING:

POSITION "A": VALVE IS OPEN,
AIR FLOW BETWEEN SUPPLY (S) AND
DELIVERY (D) , LOW-BUOY IS IN FUNCTION.

POSITION "B": VALVE CLOSED,
AIR DOES'NT FLOW BETWEEN SUPPLY (S) AND
DELIVERY (D) , LOW-BUOY IS NOT IN FUNCTION.

PREVOST®

DESCRIPTION:

X3-45 COACH, WITH INDEPENDENT FRONT SUSPENSION (I.F.S.) WITH
OPTION FRONT KNEELING & LOW-BUOY COMBINATION

REV.:

D

PAGE:

DATE:

2011/10

D140383 P4.1

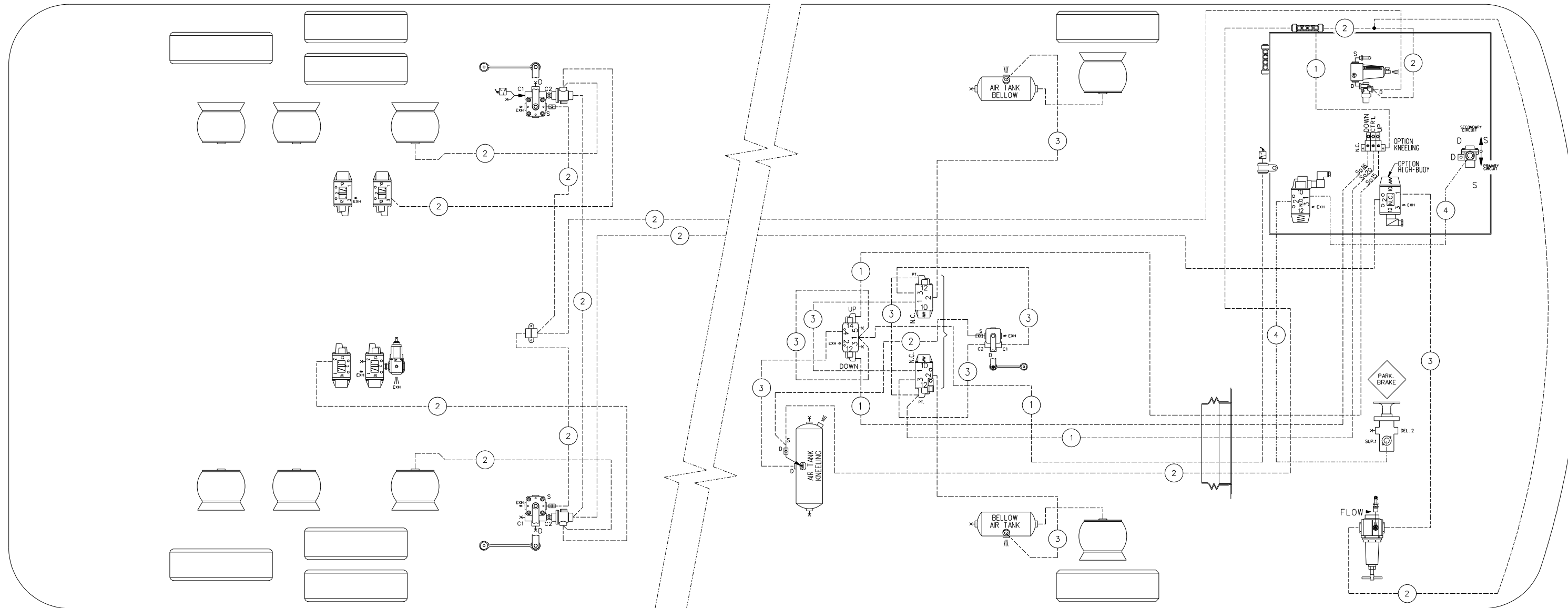

BALLOON	PIPE
#1	1/4" O.D. BLUE
#2	3/8" O.D. BLUE
#3	1/2" O.D. BLUE
#4	3/8" O.D. YELLOW

TUBE COLOR CODING		
LINE TYPE	COLOR	CIRCUIT
---	BLUE	SUSPENSION
---	YELLOW	PARKING BRAKES

PREVOST®

DESCRIPTION:

X3-45 COACH, WITH INDEPENDENT FRONT SUSPENSION (I.F.S.) WITH OPTION FRONT KNEELING & HIGH-BUOY COMBINATION.

REV.:

A

PAGE:

DATE:

2010/09

D140383 P5.1

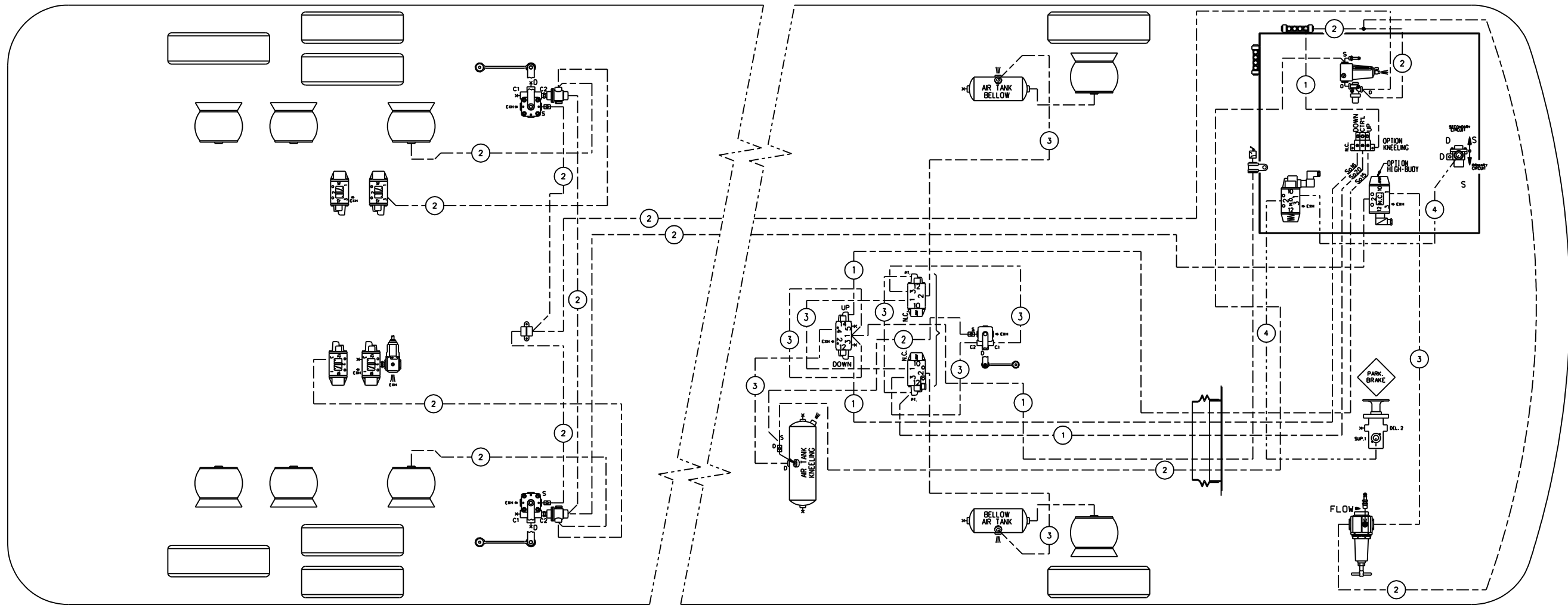

BALLOON	PIPE
#1	1/4" O.D. BLUE
#2	3/8" O.D. BLUE
#3	1/2" O.D. BLUE
#4	3/8" O.D. YELLOW

TUBE COLOR CODING		
LINE TYPE	COLOR	CIRCUIT
---	BLUE	SUSPENSION
---	YELLOW	PARKING BRAKES

PREVOST®

DESCRIPTION:

X3-45 COACH, WITH INDEPENDENT FRONT SUSPENSION (I.F.S.) WITH OPTION FRONT KNEELING & HIGH-BUOY COMBINATION.

REV.:

B

DATE:

2011/04

PAGE:

D140383 P5.1

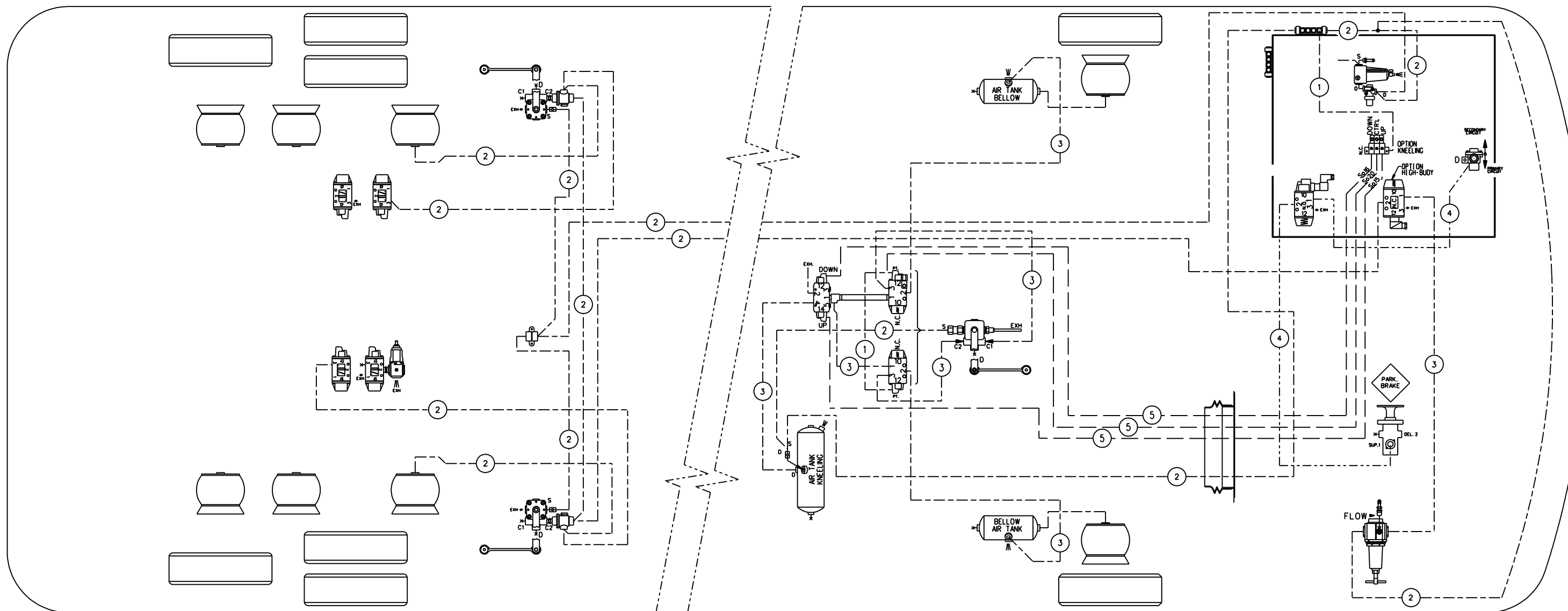

BALLOON	PIPE
*1	1/4" O.D. BLUE
*2	3/8" O.D. BLUE
*3	1/2" O.D. BLUE
*4	3/8" O.D. YELLOW
*5	1/4" O.D. BLACK

TUBE COLOR CODING		
LINE TYPE	COLOR	CIRCUIT
---	BLUE	SUSPENSION
- - - - -	YELLOW	PARKING BRAKES

PREVOST®

DESCRIPTION:

X3-45 COACH, WITH INDEPENDENT FRONT SUSPENSION (I.F.S.) WITH OPTION FRONT KNEELING & HIGH-BUOY COMBINATION.

REV.:

C

DATE:

2011/10

PAGE:

D140383 P5.1

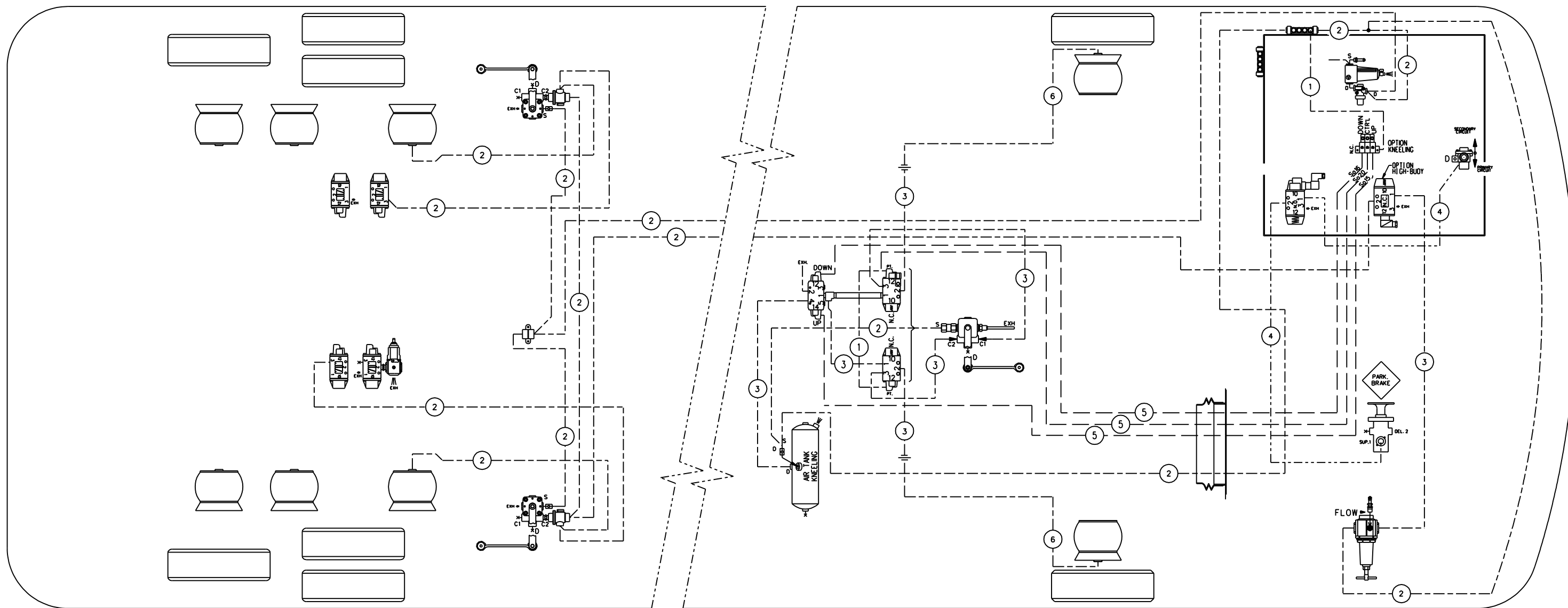

BALLOON	PIPE
*1	1/4" O.D. BLUE
*2	3/8" O.D. BLUE
*3	1/2" O.D. BLUE
*4	3/8" O.D. YELLOW
*5	1/4" O.D. BLACK
*6	HOSE ASSY *8

TUBE COLOR CODING		
LINE TYPE	COLOR	CIRCUIT
---	BLUE	SUSPENSION
- - - - -	YELLOW	PARKING BRAKES

PREVOST®

DESCRIPTION:

X3-45 COACH, WITH INDEPENDENT FRONT SUSPENSION (I.F.S.) WITH
OPTION FRONT KNEELING & HIGH-BUOY COMBINATION.

REV.:

D

DATE:

2011/10

PAGE:

D140383 P5.1

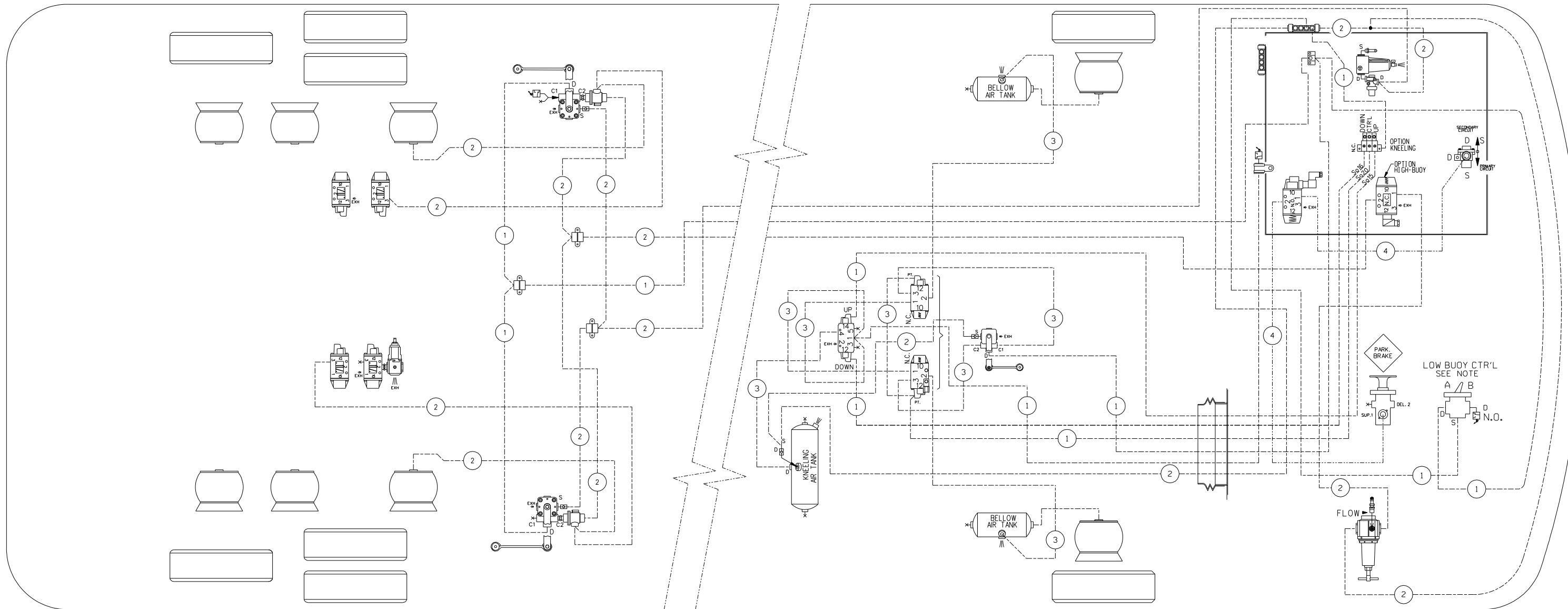

BALLOON	PIPE
#1	1/4" O.D. BLUE
#2	3/8" O.D. BLUE
#3	1/2" O.D. BLUE
#4	3/8" O.D. YELLOW
#5	3/8" O.D. BLACK
#6	3/4" O.D. BLACK

NOTE:

KNEELING SYSTEM = UP (CTR'L + UP ENERGIZED)
DOWN (CTR'L + DOWN ENERGIZED)

CONTROL VALVE OPT. "LOW-BUOY" , "A" OR "B" SETTING:

POSITION "A": VALVE IS OPEN,
AIR FLOW BETWEEN SUPPLY (S) AND
DELIVERY (D) , LOW-BUOY IS IN FUNCTION.

POSITION "B": VALVE CLOSED,
AIR DOES'NT FLOW BETWEEN SUPPLY (S) AND
DELIVERY (D) , LOW-BUOY IS NOT IN FUNCTION.

TUBE COLOR CODING		
LINE TYPE	COLOR	CIRCUIT
---	BLUE	SUSPENSION
---	BLACK	ACCESSORIES
---	YELLOW	PARKING BRAKES

PREVOST

DESCRIPTION:

X3-45 COACH, WITH INDEPENDENT FRONT SUSPENSION (I.F.S.) WITH
OPTION FRONT KNEELING, LOW-BUOY & HIGH-BUOY COMBINATION

REV.:

A

PAGE:

D140383 P6.1

DATE:

2010/09

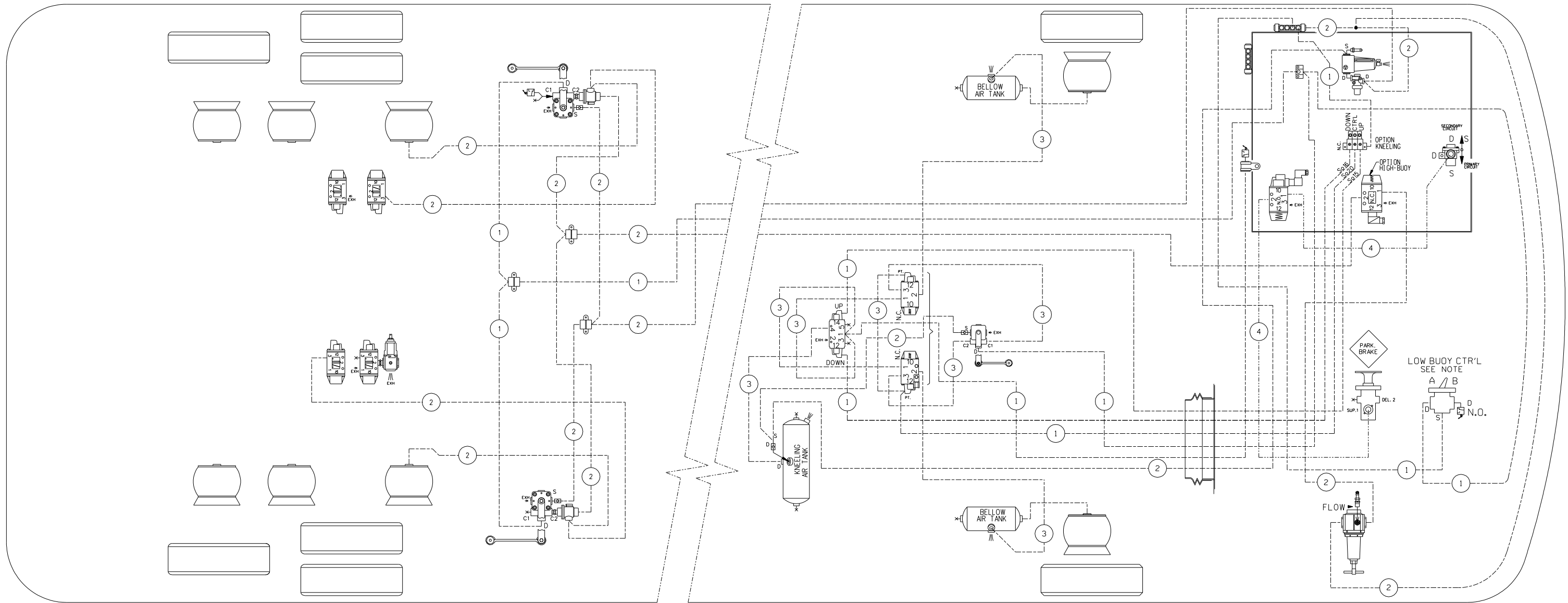

BALLOON	PIPE
#1	1/4" O.D. BLUE
#2	3/8" O.D. BLUE
#3	1/2" O.D. BLUE
#4	3/8" O.D. YELLOW
#5	3/8" O.D. BLACK
#6	3/4" O.D. BLACK

NOTE:

KNEELING SYSTEM = UP (CTR'L + UP ENERGIZED)
DOWN (CTR'L + DOWN ENERGIZED)

CONTROL VALVE OPT. "LOW-BUOY" , "A" OR "B" SETTING:

POSITION "A": VALVE IS OPEN,
AIR FLOW BETWEEN SUPPLY (S) AND
DELIVERY (D) , LOW-BUOY IS IN FUNCTION.

POSITION "B": VALVE CLOSED,
AIR DOES'NT FLOW BETWEEN SUPPLY (S) AND
DELIVERY (D) , LOW-BUOY IS NOT IN FUNCTION.

TUBE COLOR CODING		
LINE TYPE	COLOR	CIRCUIT
---	BLUE	SUSPENSION
---	BLACK	ACCESSORIES
---	YELLOW	PARKING BRAKES

PREVOST®

DESCRIPTION:

X3-45 COACH, WITH INDEPENDENT FRONT SUSPENSION (I.F.S.) WITH
OPTION FRONT KNEELING, LOW-BUOY & HIGH-BUOY COMBINATION

REV.:

B

DATE:

2011/01

PAGE:

D140383 P6.1

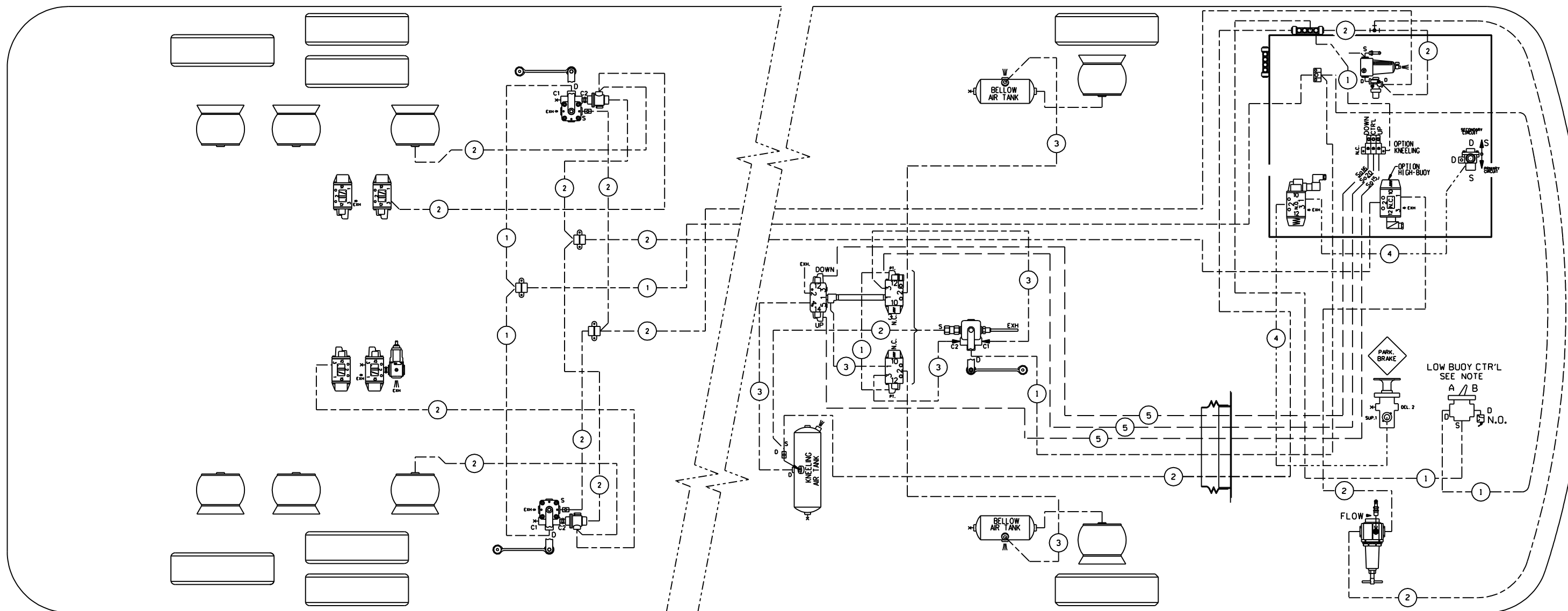

BALLOON	PIPE
*1	1/4" O.D. BLUE
*2	3/8" O.D. BLUE
*3	1/2" O.D. BLUE
*4	3/8" O.D. YELLOW
*5	1/4" O.D. BLACK
*6	3/8" O.D. BLACK
*7	3/4" O.D. BLACK

NOTE:

KNEELING SYSTEM = UP (CTR'L + UP ENERGIZED)
DOWN (CTR'L + DOWN ENERGIZED)

CONTROL VALVE OPT. "LOW-BUOY" , "A" OR "B" SETTING:

POSITION "A": VALVE IS OPEN,
AIR FLOW BETWEEN SUPPLY (S) AND
DELIVERY (D) , LOW-BUOY IS IN FUNCTION.

POSITION "B": VALVE CLOSED,
AIR DOES'NT FLOW BETWEEN SUPPLY (S) AND
DELIVERY (D) , LOW-BUOY IS NOT IN FUNCTION.

TUBE COLOR CODING		
LINE TYPE	COLOR	CIRCUIT
---	BLUE	SUSPENSION
---	BLACK	ACCESSORIES
---	YELLOW	PARKING BRAKES

PREVOST®

DESCRIPTION:

X3-45 COACH, WITH INDEPENDENT FRONT SUSPENSION (I.F.S.) WITH
OPTION FRONT KNEELING, LOW-BUOY & HIGH-BUOY COMBINATION

REV.:

C

PAGE:

D140383 P6.1

DATE:

2011/10

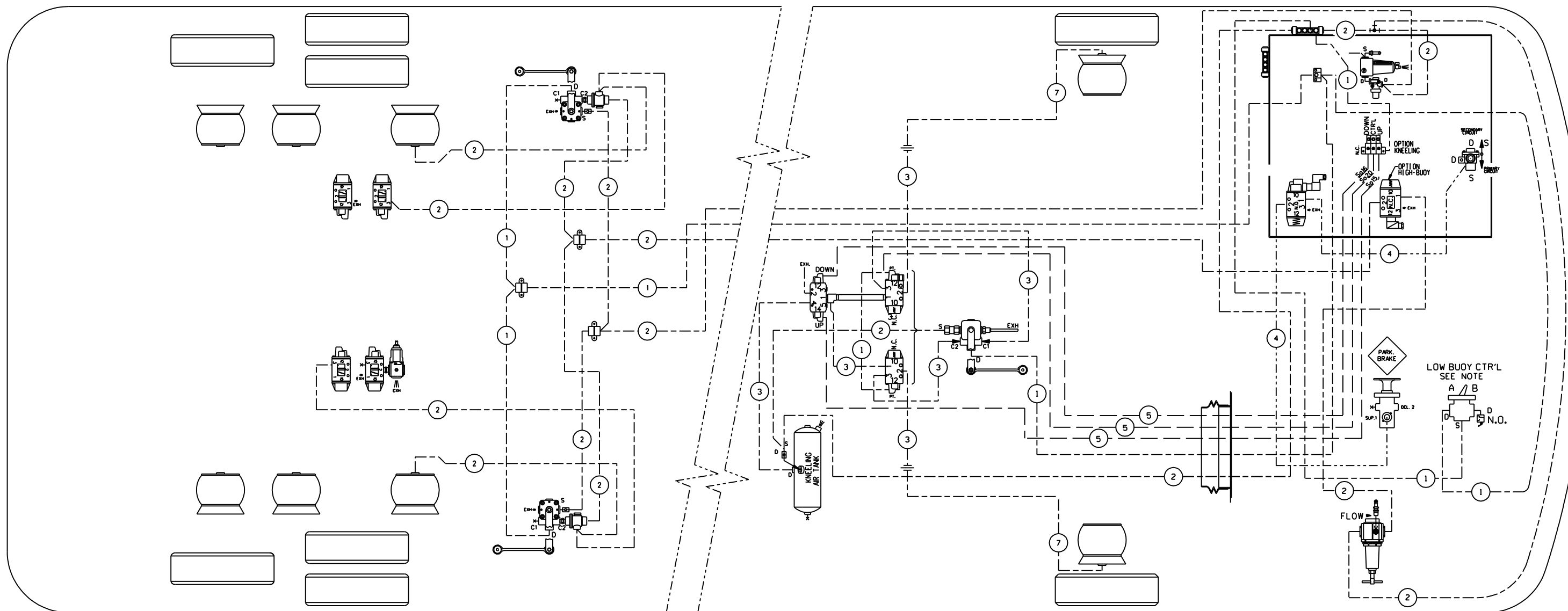

BALLOON	PIPE
*1	1/4" O.D. BLUE
*2	3/8" O.D. BLUE
*3	1/2" O.D. BLUE
*4	3/8" O.D. YELLOW
*5	1/4" O.D. BLACK
*6	3/8" O.D. BLACK
*7	HOSE ASSY *8

NOTE:

KNEELING SYSTEM = UP (CTR'L + UP ENERGIZED)
DOWN (CTR'L + DOWN ENERGIZED)

CONTROL VALVE OPT. "LOW-BUOY" , "A" OR "B" SETTING:

POSITION "A": VALVE IS OPEN,
AIR FLOW BETWEEN SUPPLY (S) AND
DELIVERY (D) , LOW-BUOY IS IN FUNCTION.

POSITION "B": VALVE CLOSED,
AIR DOES'NT FLOW BETWEEN SUPPLY (S) AND
DELIVERY (D) , LOW-BUOY IS NOT IN FUNCTION.

TUBE COLOR CODING		
LINE TYPE	COLOR	CIRCUIT
---	BLUE	SUSPENSION
---	BLACK	ACCESSORIES
---	YELLOW	PARKING BRAKES

PREVOST®

DESCRIPTION:

X3-45 COACH, WITH INDEPENDENT FRONT SUSPENSION (I.F.S.) WITH
OPTION FRONT KNEELING, LOW-BUOY & HIGH-BUOY COMBINATION

REV.:

D

DATE:

2011/10

PAGE:

D140383 P6.1

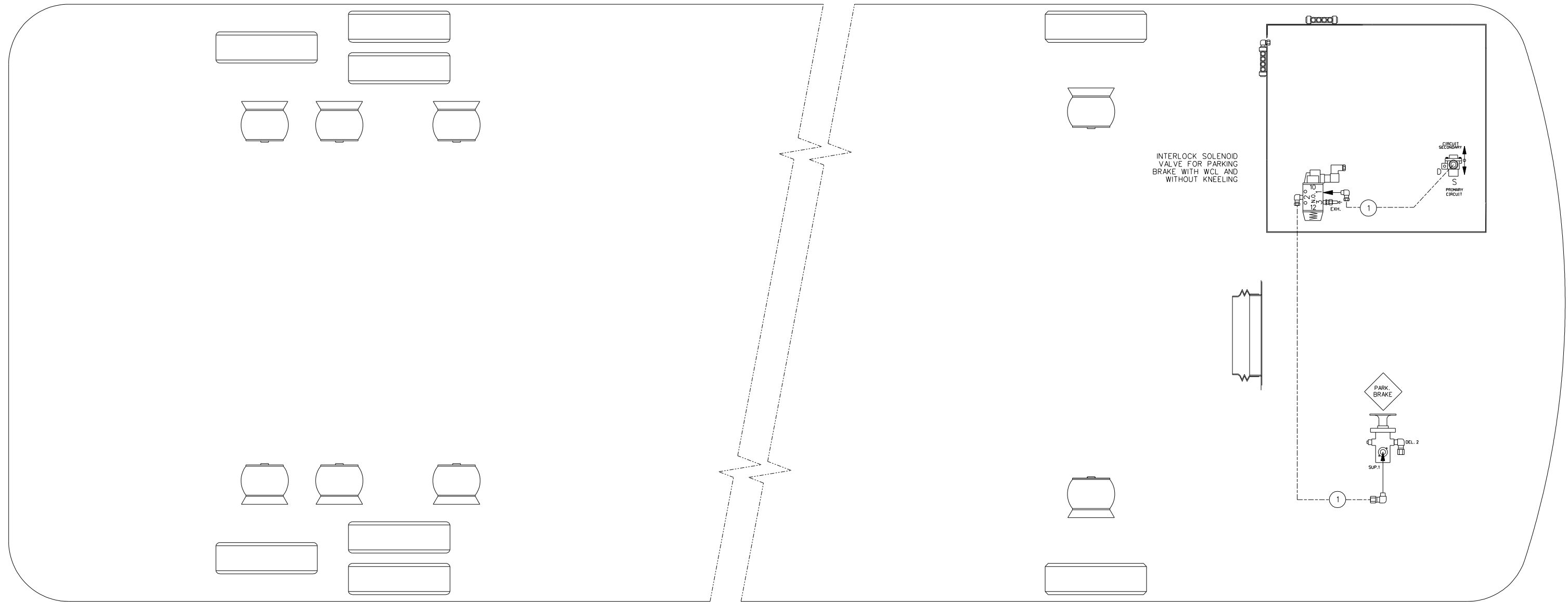

TUBE COLOR CODING		
ACTIVE	COLOR	CIRCUIT
---	YELLOW	PARKING BRAKE

BALLOON	PIPE
#1	3/8" O.D. YELLOW

PREVOST®

DESCRIPTION:

X3-45 COACH, WITH INDEPENDENT FRONT SUSPENSION (I.F.S.)
WITH OPTION PARKING BRAKE WITH WHEELCHAIR LIFT AND WITHOUT
KNEELING

REV.:

A

DATE:

2010/09

PAGE:

D140383 P7.1

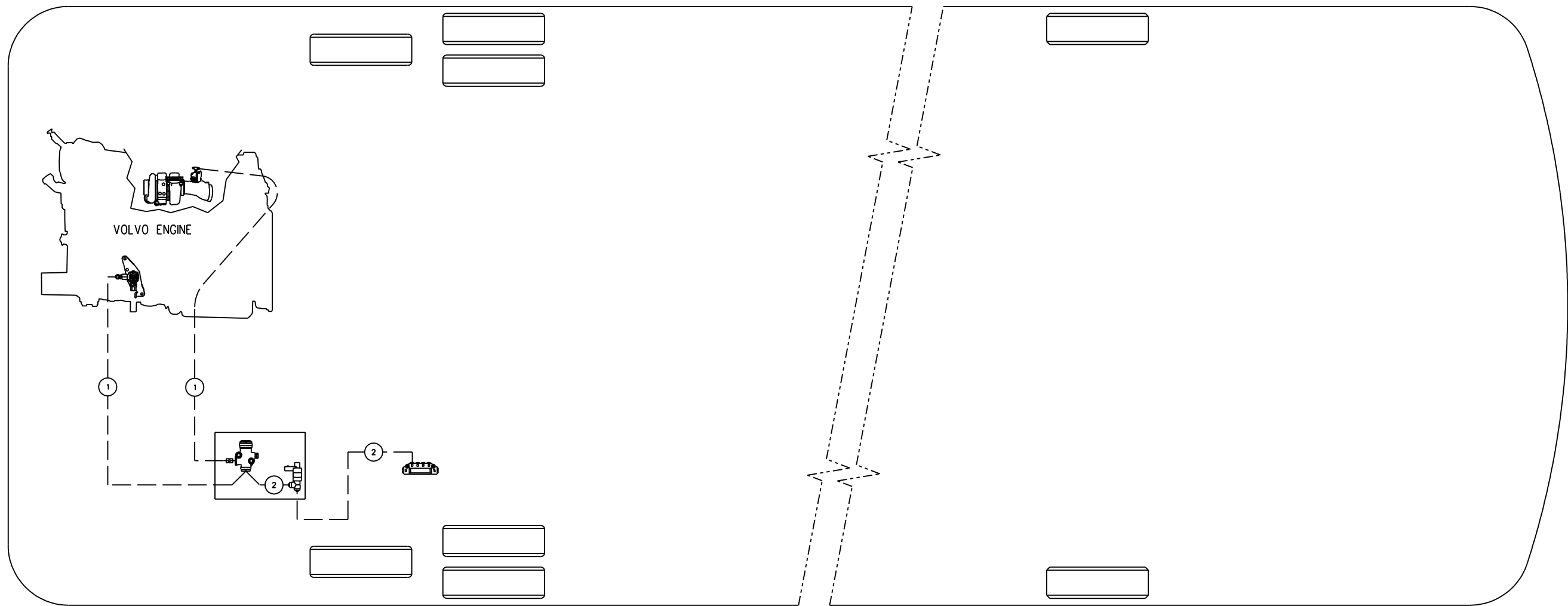

TUBE COLOR CODING		
ACTIVE	COLOR	CIRCUIT
—	BLACK	ACCESSORIES

BALLOON	PIPE
*1	HOSE ASS'Y
*2	1/4" O.D. BLACK

PREVOST®

DESCRIPTION:

X3-45 COACH, WITH INDEPENDENT FRONT
SUSPENSION (I.F.S.), WITHOUT OUTPUT RETARDER
ON WORLD TRANSMISSION

REV.:

A

DATE:

2010/11

PAGE:

D140383 P8.1

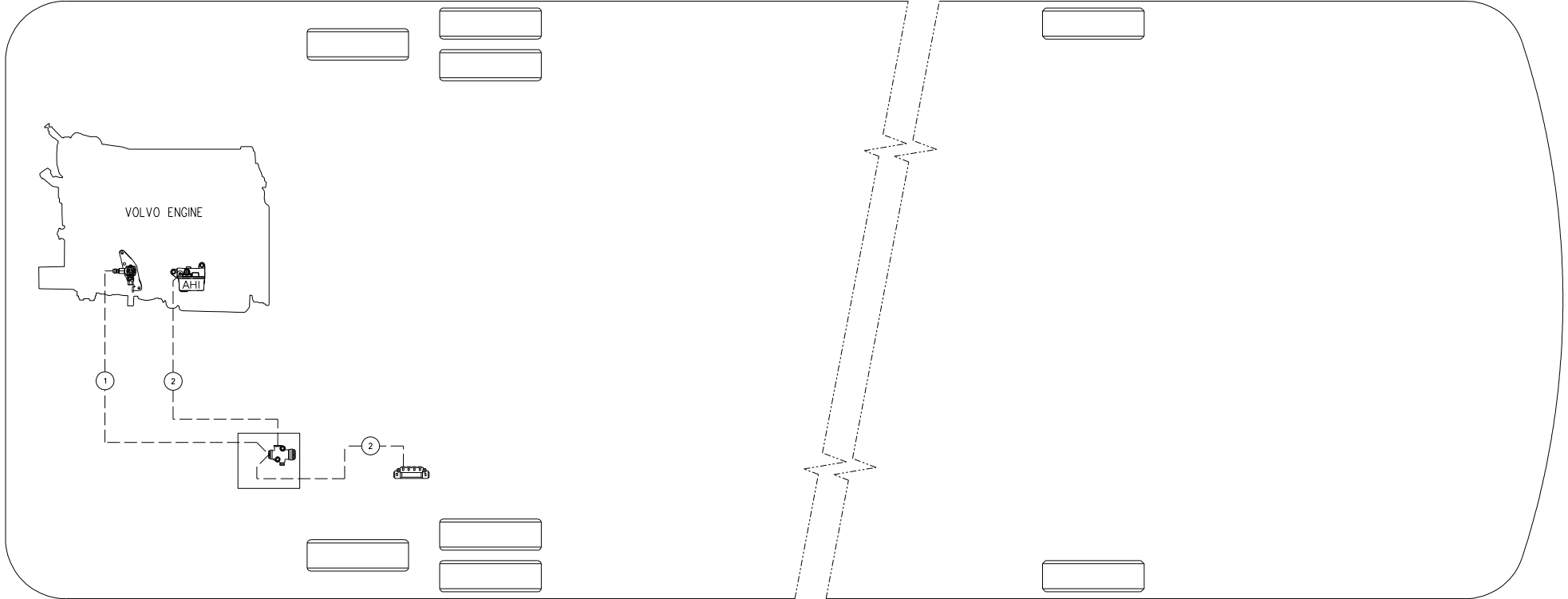

TUBE COLOR CODING	
ACTIVE COLOR	CIRCUIT
---	BLACK ACCESSORIES

BALLOON	PIPE
*1	HOSE ASS'Y
*2	1/4" O.D. BLACK

PREVOST®

DESCRIPTION:

X3-45 COACH, WITH INDEPENDENT FRONT SUSPENSION (I.F.S.), WITHOUT OUTPUT RETARDER ON WORLD AND I-SHIFT TRANSMISSION

REV.: B
DATE: 2011/02

PAGE: D140383 P8.1

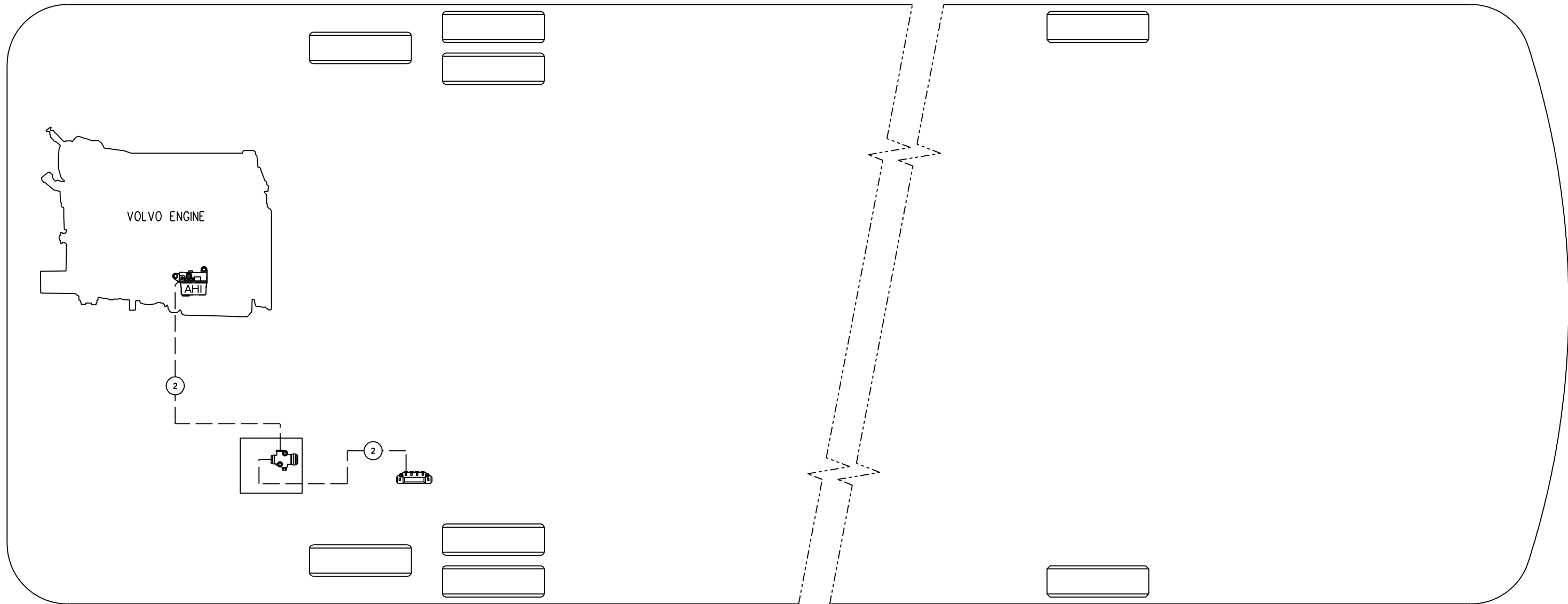

TUBE COLOR CODING		
ACTIVE	COLOR	CIRCUIT
---	BLACK	ACCESSORIES

BALLOON	PIPE
*1	---
*2	1/4" O.D. BLACK

PREVOST®

DESCRIPTION:

X3-45 COACH, WITH INDEPENDENT FRONT
SUSPENSION (I.F.S.), WITHOUT OUTPUT RETARDER
ON WORLD AND I-SHIFT TRANSMISSION

REV.:

C

DATE:

2011/12

PAGE:

D140383 P8.1

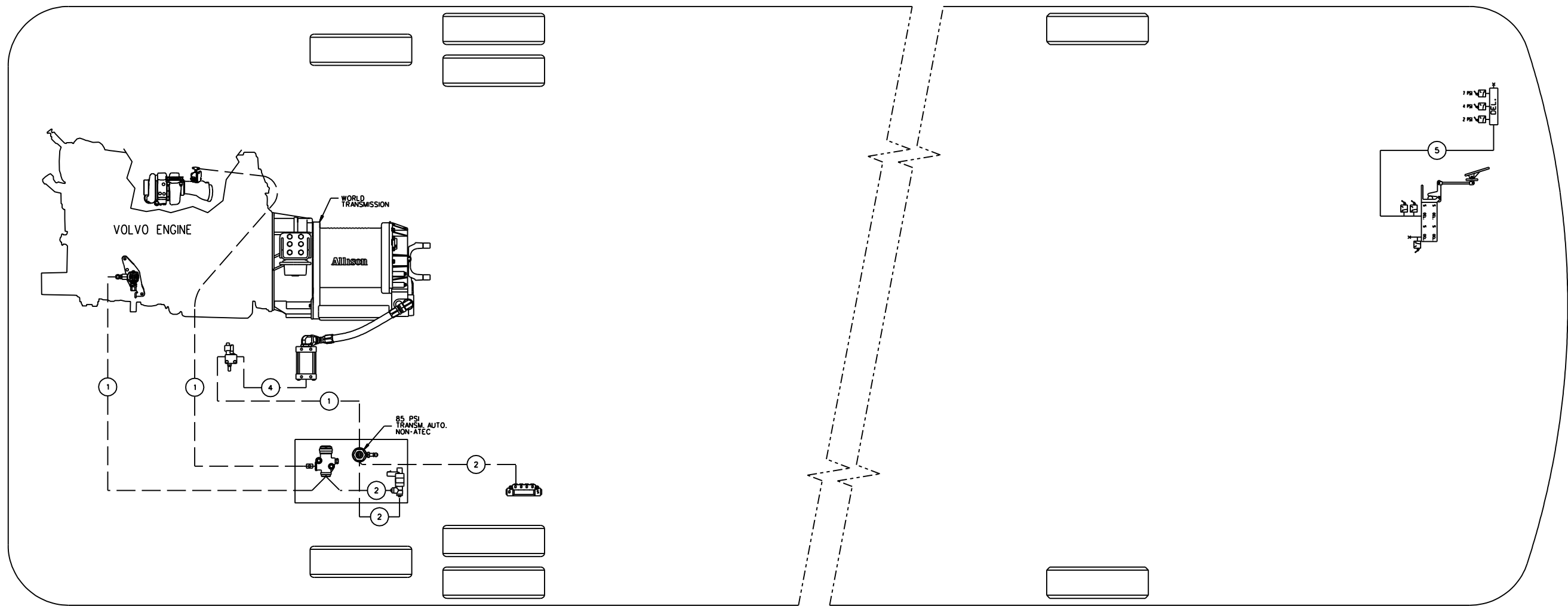

TUBE COLOR CODING		
ACTIVE	COLOR	CIRCUIT
---	BLACK	ACCESSORIES
---	GREEN	PRIMARY & SUPPLY

BALLOON	PIPE
*1	HOSE ASS'Y
*2	1/4" O.D. BLACK
*3	3/8" O.D. BLACK
*4	1/2" O.D. BLACK
*5	3/8" O.D. GREEN

PREVOST®

DESCRIPTION: X3-45 COACH,
WITH INDEPENDENT FRONT SUSPENSION (I.F.S.)
& OUTPUT RETARDER ON WORLD TRANSMISSION

REV.: A
DATE: 2010/11

PAGE: D140383 P9.1

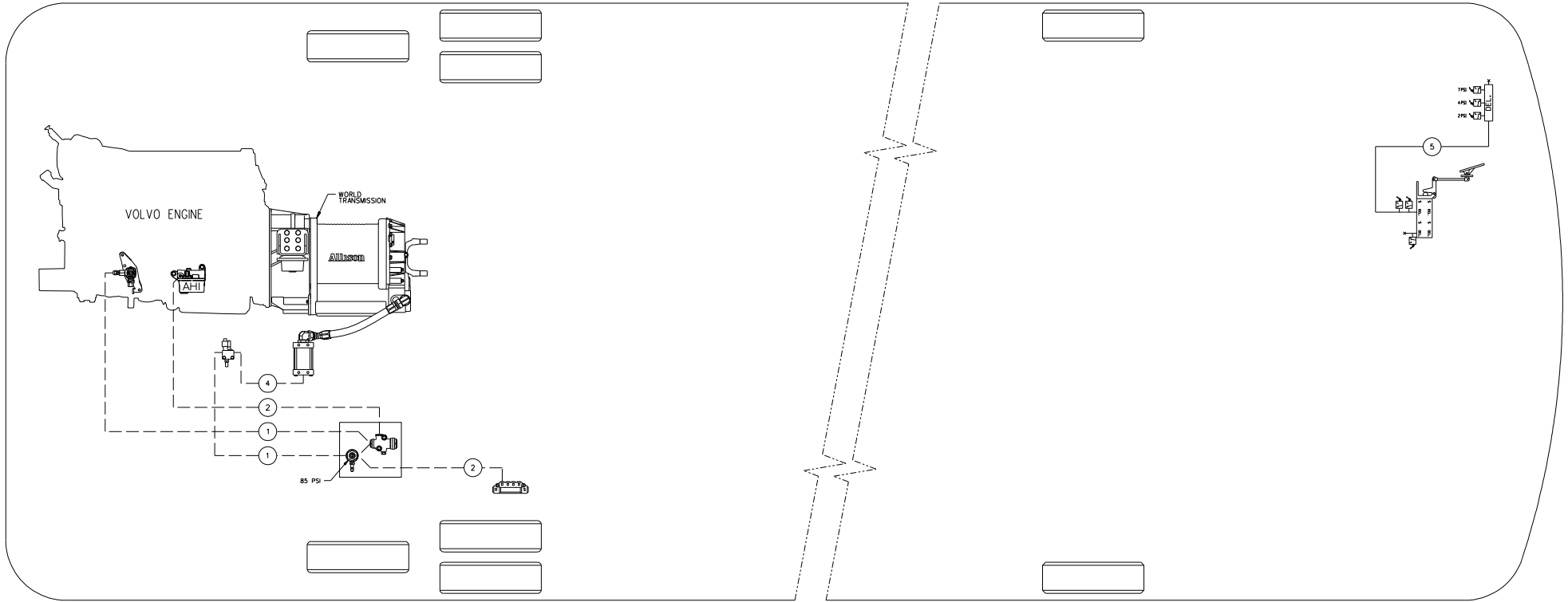

TUBE COLOR CODING	
ACTIVE COLOR	CIRCUIT
---	BLACK ACCESSORIES
---	GREEN PRIMARY & SUPPLY

BALLOON	PIPE
*1	HOSE ASS'Y
*2	1/4" O.D. BLACK
*3	3/8" O.D. BLACK
*4	1/2" O.D. BLACK
*5	3/8" O.D. GREEN

PREVOST®

DESCRIPTION: X3-45 COACH,
WITH INDEPENDENT FRONT SUSPENSION (I.F.S.)
& OUTPUT RETARDER ON WORLD TRANSMISSION

REV.: B
DATE: 2011/02

PAGE: D140383 P9.1

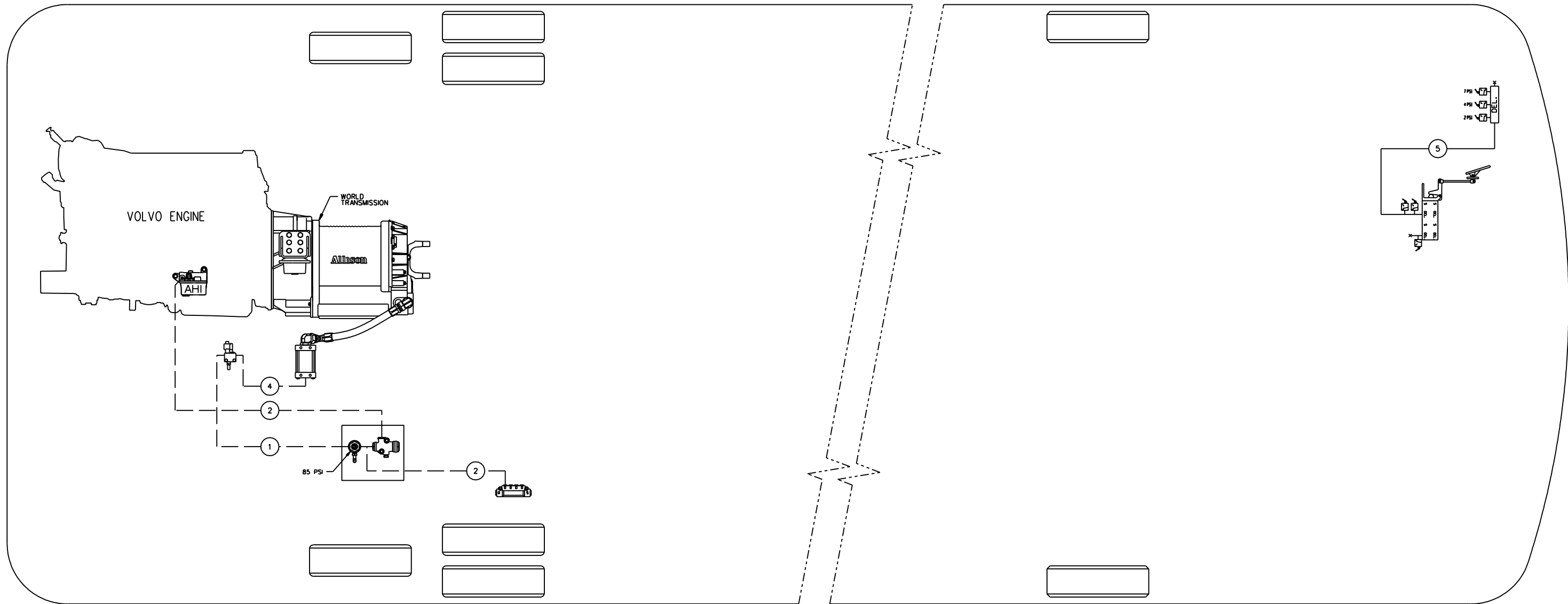

TUBE COLOR CODING		
ACTIVE	COLOR	CIRCUIT
---	BLACK	ACCESSORIES
---	GREEN	PRIMARY & SUPPLY

BALLOON	PIPE
#1	HOSE ASS'Y
#2	1/4" O.D. BLACK
#3	3/8" O.D. BLACK
#4	1/2" O.D. BLACK
#5	3/8" O.D. GREEN

PREVOST®

DESCRIPTION:

X3-45 COACH,
WITH INDEPENDENT FRONT SUSPENSION (I.F.S.)
& OUTPUT RETARDER ON WORLD TRANSMISSION

REV.:

C

DATE:

2011/12

PAGE:

D140383 P9.1

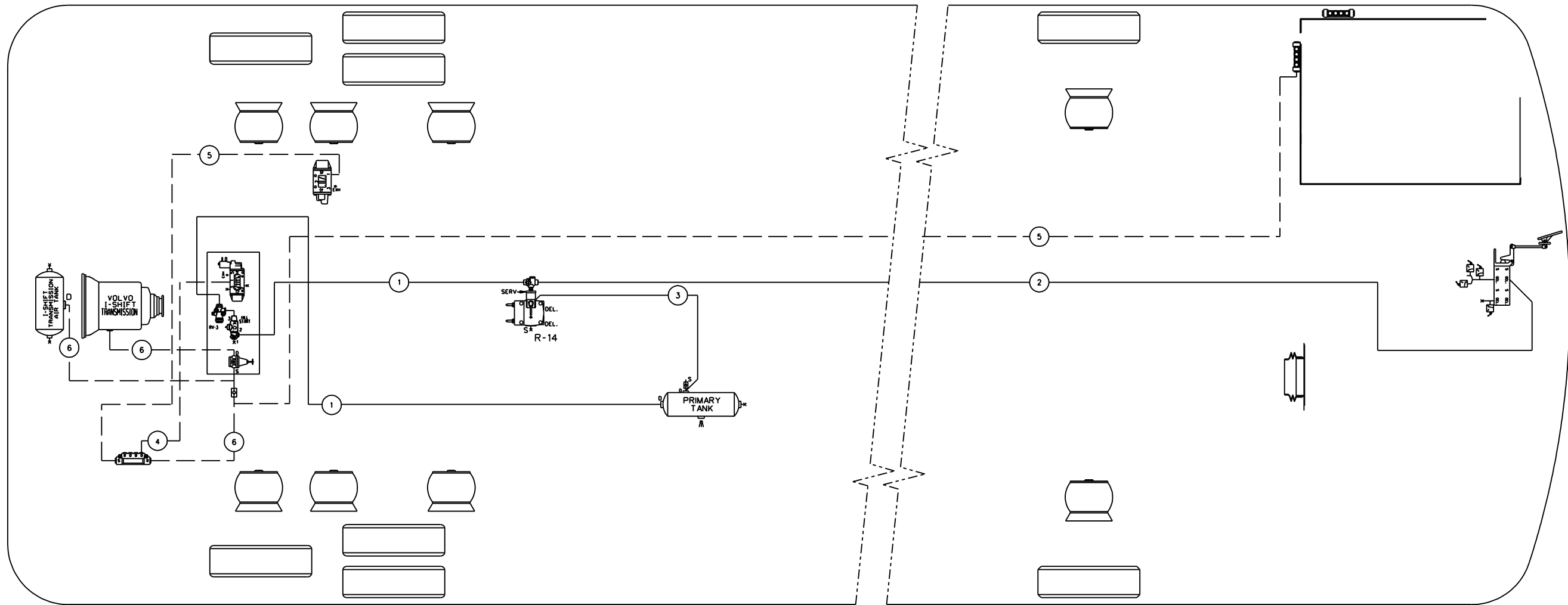

BALLOON	PIPE
*1	3/8" O.D. GREEN
*2	1/2" O.D. GREEN
*3	5/8" O.D. GREEN
*4	1/4" O.D. BLACK
*5	3/8" O.D. BLACK
*6	1/2" O.D. BLACK

TUBE COLOR CODING		
ACTIVE	COLOR	CIRCUIT
—	GREEN	PRIMARY & SUPPLY
—	BLACK	ACCESSORIES

PREVOST®

DESCRIPTION: X3-45 COACH, WITH INDEPENDENT FRONT SUSPENSION (I.F.S.) WITH I-SHIFT TRANSMISSION OPTIONS

REV.: A
DATE: 2010/11

PAGE: D140383 P10.1

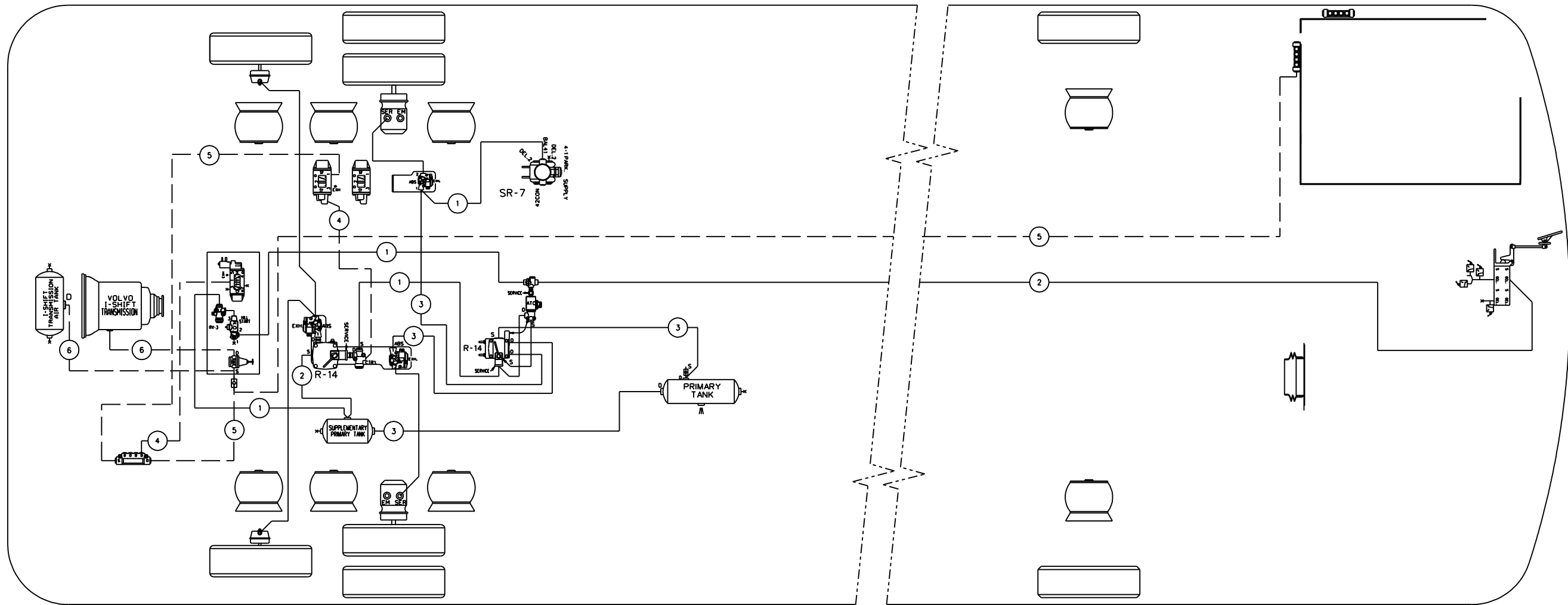

BALLOON	PIPE
*1	3/8" O.D. GREEN
*2	1/2" O.D. GREEN
*3	5/8" O.D. GREEN
*4	1/4" O.D. BLACK
*5	3/8" O.D. BLACK
*6	1/2" O.D. BLACK

TUBE COLOR CODING		
ACTIVE	COLOR	CIRCUIT
—	GREEN	PRIMARY & SUPPLY
—	BLACK	ACCESSORIES

PREVOST®

DESCRIPTION:

X3-45 COACH, WITH INDEPENDENT FRONT SUSPENSION (I.F.S.)
WITH ESP & I-SHIFT TRANSMISSION OPTIONS

REV.:

A

DATE:

2010/11

PAGE:

D140383 P11.1

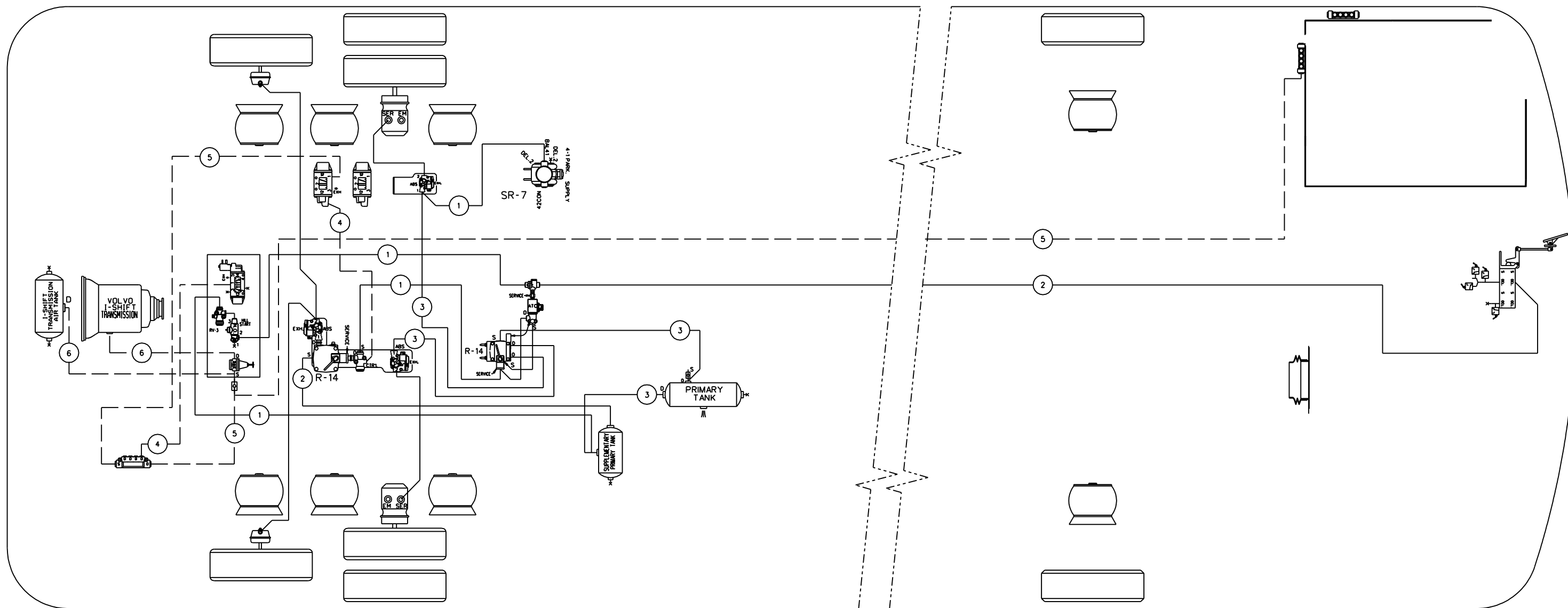

BALLOON	PIPE
#1	3/8" O.D. GREEN
#2	1/2" O.D. GREEN
#3	5/8" O.D. GREEN
#4	1/4" O.D. BLACK
#5	3/8" O.D. BLACK
#6	1/2" O.D. BLACK

TUBE COLOR CODING	
ACTIVE COLOR	CIRCUIT
GREEN	PRIMARY & SUPPLY
BLACK	ACCESSORIES

PREVOST®

DESCRIPTION:

X3-45 COACH, WITH INDEPENDENT FRONT SUSPENSION (I.F.S.)
WITH ESP & I-SHIFT TRANSMISSION OPTIONS

REV.:

B

DATE:

2011/10

PAGE:

D140383 P11.1

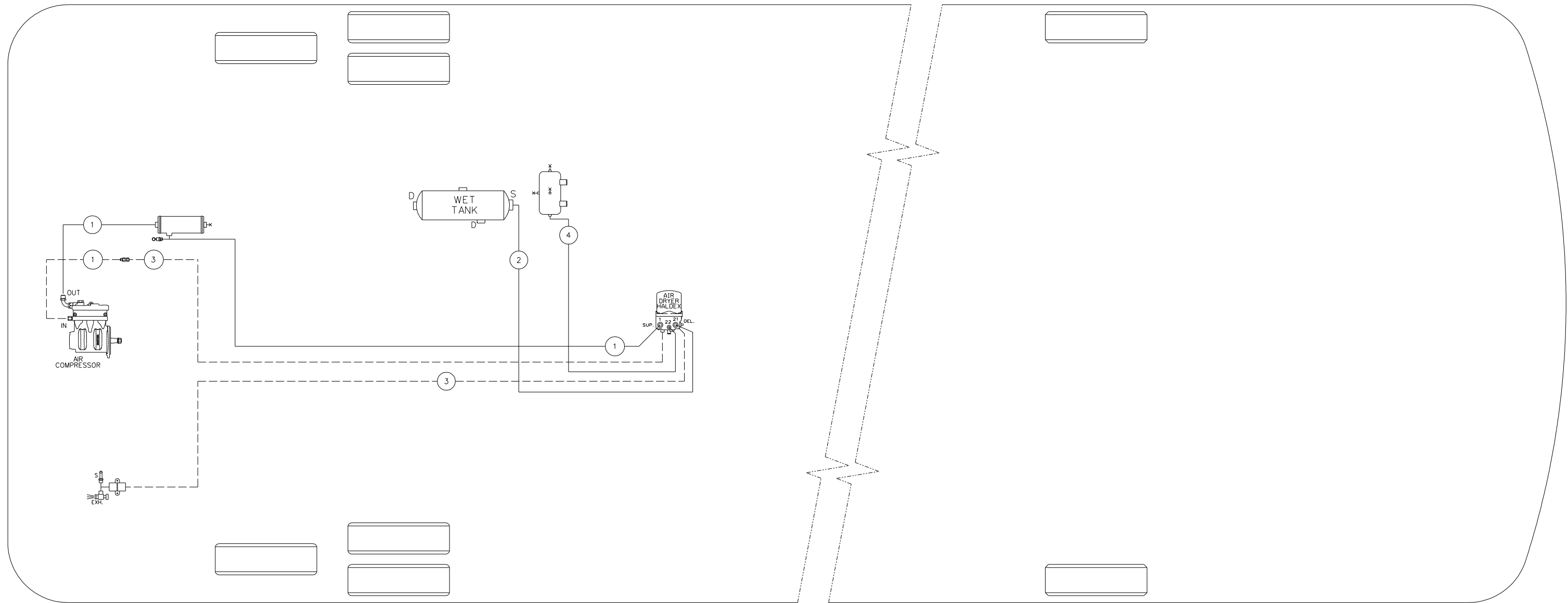

TUBE COLOR CODING		
ACTIVE	COLOR	CIRCUIT
—	GREEN	PRIMARY & SUPPLY
- - -	BLACK	ACCESSORIES

BALLOON	PIPE
#1	HOSE ASS'Y
#2	3/4" O.D. GREEN
#3	1/4" O.D. BLACK
#4	3/8" O.D. GREY

PREVOST®

DESCRIPTION:
X3-45 COACH, WITH INDEPENDENT FRONT SUSPENSION (I.F.S.) AND HALDEX AIR DRYER

REV.: A
DATE: 2010/09

PAGE:
D140383 P12.1

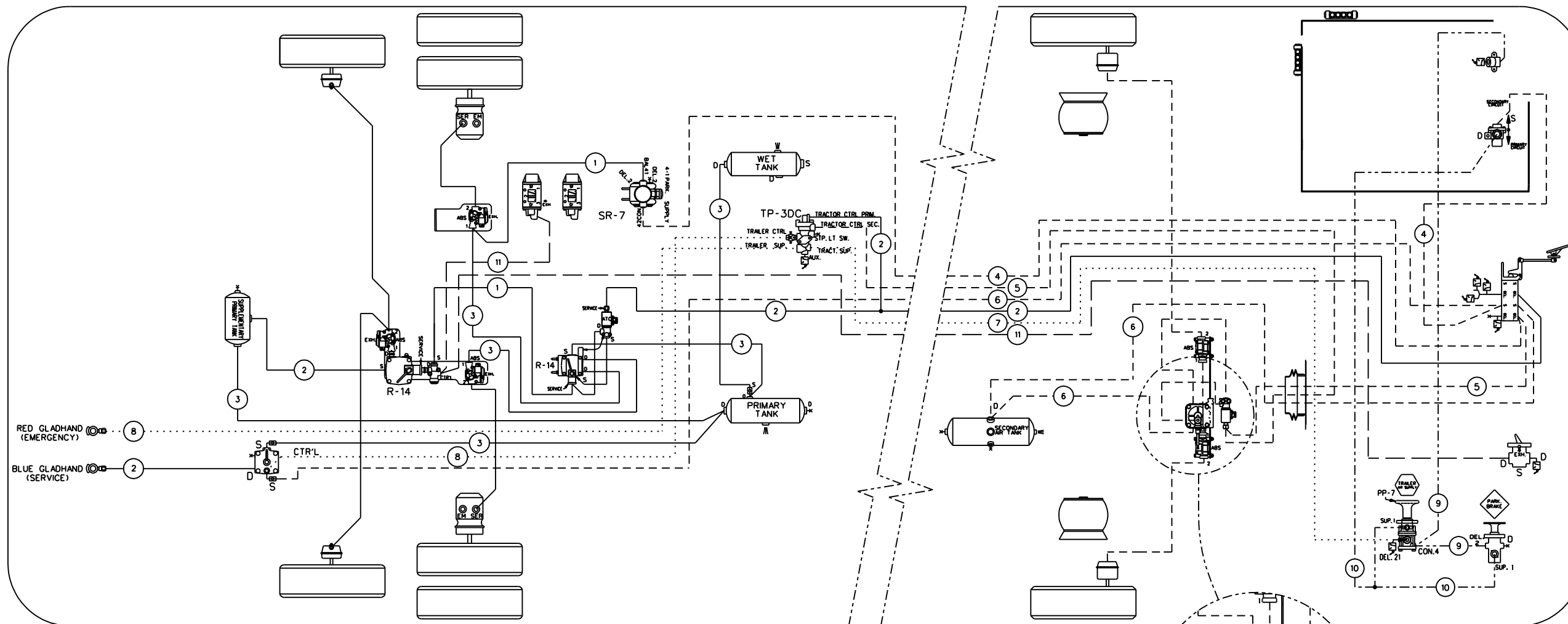

RED GLADHAND (EMERGENCY) 8
 BLUE GLADHAND (SERVICE) 2

BALLOON	PIPE
*1	3/8" O.D. GREEN
*2	1/2" O.D. GREEN
*3	3/8" O.D. GREEN
*4	3/8" O.D. RED
*5	1/2" O.D. RED
*6	3/8" O.D. RED
*7	3/8" O.D. BROWN
*8	1/2" O.D. BROWN
*9	1/4" O.D. YELLOW
*10	3/8" O.D. YELLOW
*11	1/4" O.D. BLACK
*12	3/8" O.D. BLACK

TUBE COLOR CODING	
ACTIVE COLOR	CIRCUIT
---	RED SECONDARY
---	GREEN PRIMARY & SUPPLY
---	YELLOW PARKING BRAKE
---	BROWN TRAILER
---	BLACK ACCESSORIES

PREVOST

DESCRIPTION:

X3-45 COACH, WITH INDEPENDENT FRONT SUSPENSION (I.F.S.)
 WITH OPTION TRAILER HITCH AIR BRAKE
 WITH ESP SYSTEM

REV.:

A

DATE:

2010/11

PAGE:

D140383 P13.1

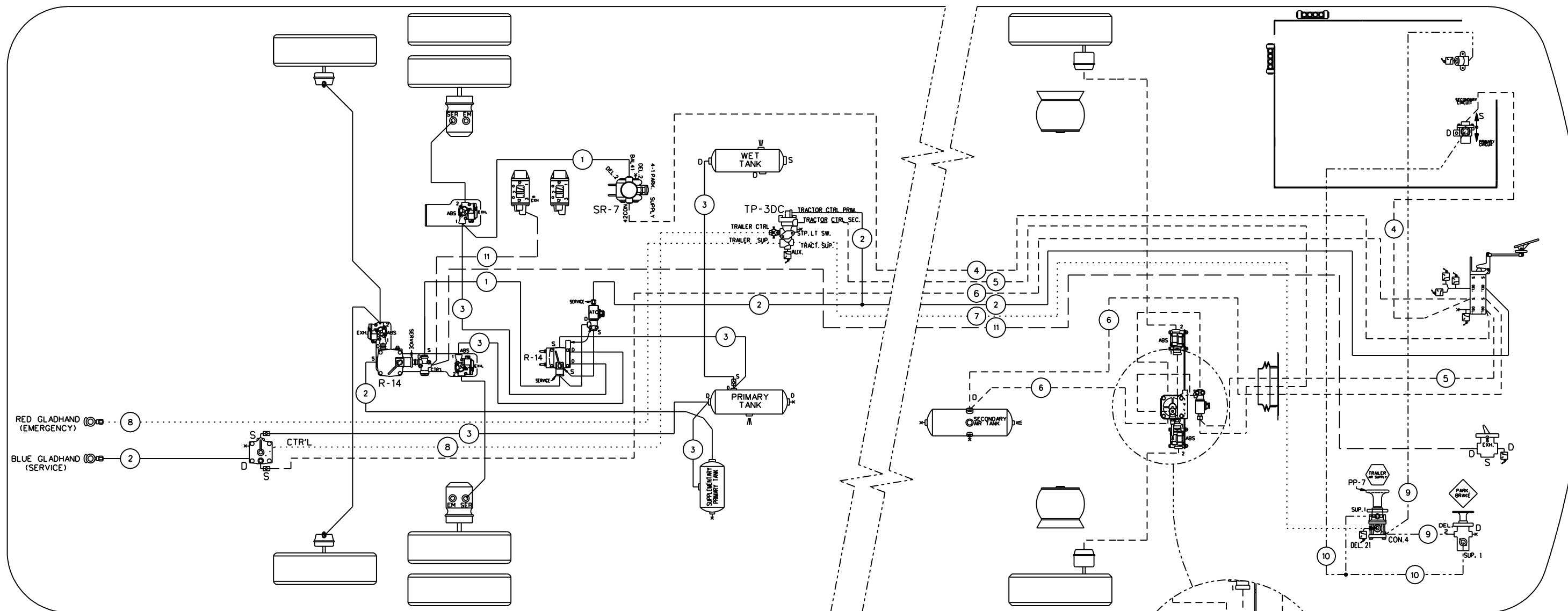

BALLOON	PIPE
*1	3/8" O.D. GREEN
*2	1/2" O.D. GREEN
*3	5/8" O.D. GREEN
*4	3/8" O.D. RED
*5	1/2" O.D. RED
*6	5/8" O.D. RED
*7	3/8" O.D. BROWN
*8	1/2" O.D. BROWN
*9	1/4" O.D. YELLOW
*10	3/8" O.D. YELLOW
*11	1/4" O.D. BLACK
*12	5/8" O.D. BLACK

TUBE COLOR CODING	
ACTIVE COLOR	CIRCUIT
---	RED SECONDARY
---	GREEN PRIMARY & SUPPLY
---	YELLOW PARKING BRAKE
---	BROWN TRAILER
---	BLACK ACCESSORIES

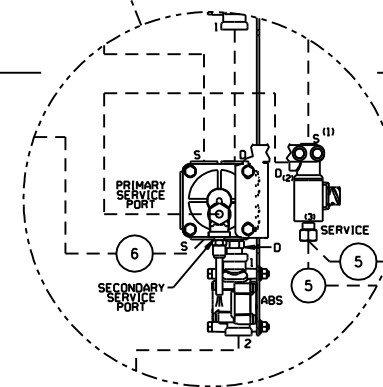

PREVOST®

DESCRIPTION:

X3-45 COACH, WITH INDEPENDENT FRONT SUSPENSION (I.F.S.)
WITH OPTION TRAILER HITCH AIR BRAKE
WITH ESP SYSTEM

REV.:

B

DATE:

2011/10

PAGE:

D140383 P13.1