

PREVOST

Instruction Sheet

IS18905

INSTALLATION OF HATCHES WITH FAN ON H3 MODELS

| H3 MODELS | EFFECTIVITY | KIT TO ORDER | HATCH COLOR | PAGE |
|--|---|--------------|-------------|---|
| H3-45 coaches Model Years : From 2019 | From 2PCH33493 <u>KC710185</u> | IS-18905_1 | BEIGE | 2 AND 4 |
| H3-45 coaches Model Years : From 2019 | From 2PCH33493 <u>KC710185</u> | IS-18905_2 | GREY | 3 AND 4 |
| H3-45 coaches Model Years : From 2005 up to 2018 | From 2PCH33499 <u>51010168</u> up to 2PCH33493 <u>JC710184</u> | IS-18905_3 | BEIGE | 21 |

NOTE

Material can be obtained through regular channels.

SECTION 1: FOR H3 MODELS WITH NEW ELECTRICAL ARCHITECTURE

Kit # IS-18905_1 contains the following parts:

| Part No. | Description | Qty |
|----------|---|-----|
| 950456 | HATCH WITH FAN (BEIGE) | 2 |
| 061395 | HARNESS FOR HATCHES W/FAN - DASH SECTION (NEA) | 1 |
| 061396 | HARNESS FOR HATCHES W/FAN - ROOF SECTION (NEA) | 1 |
| 504637 | CABLE TIE, NYLON BLK (STD) | 30 |
| 562697 | SWITCH, NGR EATON 8961K680 | 2 |
| 565927 | CAP SWITCH EATON - HATCHES (VENT. ROOF) | 2 |
| 504273 | CABLE TIE, NYLON BLK (SMALL) | 10 |
| 562286 | TERMINAL PIN, FOR ROOF HARNESS REAR FAN WIRE EXTENDING | 4 |
| 562482 | TERMINAL SOCKET, FOR FAN CONNECTOR | 6 |
| 562485 | DEUTSCH CONNECTOR 2C SHP, MALE, FOR MOTOR | 2 |
| 562488 | SECONDARY LOCK DEUTSCH, FOR CONNECTOR 562485 | 2 |
| 563623 | BUTT SPLICE / 16-14 / BLUE / W/THERMORETRAC / PANDUIT BSH14-Q | 4 |
| 560668 | ELECTRICAL WIRE RED, 14 AWG, GXL, 125 deg (ft) | 3 |
| 562585 | ELECTRICAL WIRE BLACK, 14 AWG, TXL, 125 deg (ft) | 3 |
| 562387 | CONVOLUTED TUBING NYL 0.25"ID (ft) | 2 |
| 561681 | CONVOLUTED TUBING NYL 0.35"ID (ft) | 15 |
| 561683 | CONVOLUTED TUBING NYL 0.50"ID (ft) | 2 |
| 504447 | GROMMET .5X.062X.312X.625 | 6 |
| IS18905 | INSTRUCTION SHEET | 1 |
| FI18905 | FEUILLE D'INSTRUCTIONS | 1 |

Other parts that may be required with kit IS-18905_1 :

| Part No. | Description | Qty |
|----------|---|---------|
| 564099 | HOCKEY TAPE BLACK | AS REQ. |
| 684013 | CAOUTCHOUC PROTECTION FOR ELECTRICAL TERMINAL | AS REQ. |
| 684685 | ADHESIVE/SEALANT SIMMON ISR70-03 BLACK | AS REQ. |
| 680038 | LOCTITE 243 BLUE | AS REQ. |

SECTION 1: FOR H3 MODELS WITH NEW ELECTRICAL ARCHITECTURE

Kit # IS-18905_2 contains the following parts:

| Part No. | Description | Qty |
|----------|---|-----|
| 950583 | HATCH WITH FAN (GREY) | 2 |
| 061395 | HARNESS FOR HATCHES W/FAN - DASH SECTION (NEA) | 1 |
| 061396 | HARNESS FOR HATCHES W/FAN - ROOF SECTION (NEA) | 1 |
| 504637 | CABLE TIE, NYLON BLK (STD) | 30 |
| 562697 | SWITCH, NGR EATON 8961K680 | 2 |
| 565927 | CAP SWITCH EATON - HATCHES (VENT. ROOF) | 2 |
| 504273 | CABLE TIE, NYLON BLK (SMALL) | 10 |
| 562286 | TERMINAL PIN, FOR ROOF HARNESS REAR FAN WIRE EXTENDING | 4 |
| 562482 | TERMINAL SOCKET, FOR FAN CONNECTOR | 6 |
| 562485 | DEUTSCH CONNECTOR 2C SHP, MALE, FOR MOTOR | 2 |
| 562488 | SECONDARY LOCK DEUTSCH, FOR CONNECTOR 562485 | 2 |
| 563623 | BUTT SPLICE / 16-14 / BLUE / W/THERMORETRAC / PANDUIT BSH14-Q | 4 |
| 560668 | ELECTRICAL WIRE RED, 14 AWG, GXL, 125 deg (ft) | 3 |
| 562585 | ELECTRICAL WIRE BLACK, 14 AWG, TXL, 125 deg (ft) | 3 |
| 562387 | CONVOLUTED TUBING NYL 0.25"ID (ft) | 2 |
| 561681 | CONVOLUTED TUBING NYL 0.35"ID (ft) | 15 |
| 561683 | CONVOLUTED TUBING NYL 0.50"ID (ft) | 2 |
| 504447 | GROMMET .5X.062X.312X.625 | 6 |
| IS18905 | INSTRUCTION SHEET | 1 |
| FI18905 | FEUILLE D'INSTRUCTIONS | 1 |

Other parts that may be required with kit IS-18905_2 :

| Part No. | Description | Qty |
|----------|---|---------|
| 564099 | HOCKEY TAPE BLACK | AS REQ. |
| 684013 | CAOUTCHOUC PROTECTION FOR ELECTRICAL TERMINAL | AS REQ. |
| 684685 | ADHESIVE/SEALANT SIMMON ISR70-03 BLACK | AS REQ. |
| 680038 | LOCTITE 243 BLUE | AS REQ. |



DANGER

Park vehicle safely, apply parking brake, stop the engine. Prior to working on the vehicle, set the ignition switch to the OFF position and trip the main circuit breakers equipped with a trip button.

SECTION 1: FOR H3 MODELS WITH NEW ELECTRICAL ARCHITECTURE

PROCEDURE (KIT IS-18905_1 AND KIT IS-18905_2)

1. Install protection to the seats.



FIGURE 1

2. Prepare the new hatches.
3. If applicable, remove the plastic frame on both new hatches. Use Torx #40 and remove the screws (4).
4. Keep the screws in a safe place.



FIGURE 2

5. Remove the wire holder that fixes the wire on the frame. Use a Torx #20.
6. Keep the screw and the holder in a safe place.
7. Discard both plastic frames.

NOTE

The new hatches are to be installed on the existing frames which are glued on the vehicle.



FIGURE 3

8. Remove all hatch levers (4) and springs from both new hatches and keep in a safe place.



FIGURE 4

9. Remove both existing hatches on the vehicle by removing the screws (4 per hatch).
10. Discard the existing hatches and fasteners.



FIGURE 5

11. Remove the finishing plastic moulding of both roof exits.
12. Keep the moulding and screws in a safe place.

| |
|---|
| NOTE |
| <i>The new hatches are to be installed on the existing hatch frames which are glued on the vehicle.</i> |



FIGURE 6

13. Remove the dashboard cover by unscrewing the M4 – 0.7x 20 screws (5) that secure it to the dashboard.

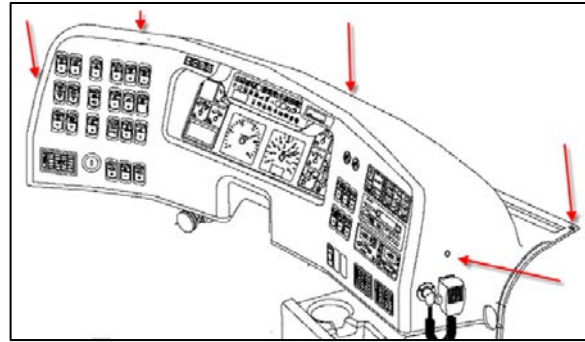

FIGURE 7

14. Remove the finishing plastic moulding on the driver side pillar.



FIGURE 8

15. Remove driver side parcel rack end cover.



FIGURE 9

16. Remove the overhead compartment door in line with the front hatch on the driver side.

17. Dismount light support screws.



FIGURE 10

18. Pull down the center roof panel around the front hatch.

| |
|---|
| NOTE |
| <i>Do not bend too much to avoid making a kink on the center panel.</i> |



FIGURE 11

19. Remove the overhead compartment door in line with the rear hatch on the driver side.

20. Dismount light support screws.

21. Remove the center roof panel completely around the rear hatch.

| |
|---|
| NOTE |
| <i>Do not bend too much to avoid making a kink on the center panel.</i> |



FIGURE 12

22. Unscrew the light control panel (6 screws per panel) in line with the front hatch and the panel in line with the rear hatch. Do not disconnect wiring.

NOTE

Step 22 is to facilitate the installation of the harness. Unscrew only number of panels as necessary.



FIGURE 13

23. Remove vertical protective panel into the front service compartment.



FIGURE 14

24. Remove horizontal protective panel into the front service compartment.

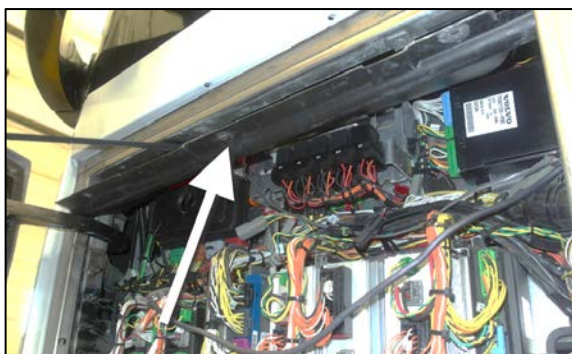

FIGURE 15

25. Prepare the installation of the dashboard fan switches and dash harness (short harness).
26. Install 0.35" ID convoluted tubing on the dash harness wiring.



FIGURE 16

27. Install switches with the red light facing down as shown in Figure 17.



FIGURE 17

28. Install switch caps with the fan sign facing up as shown in Figure 18.
29. On the back of each switch connect dash harness switch connectors, Sw602 (front fan) on the left and Sw603 (rear fan) on the right.



FIGURE 18

30. Locate existing male connector C600 into the dashboard.
31. Remove the existing female connector without wires on the existing male connector C600.
32. Do not connect yet the new female connector with the existing connector.

NOTE

Do not plug existing male connector C600 to the new female connector C600 to avoid having power on the electrical line. This operation will be done at the end.



FIGURE 19

33. Run the dash harness up to the front service compartment through the aperture close to the left windshield pillar.
34. Use cable ties to secure all new wires with existing wiring.

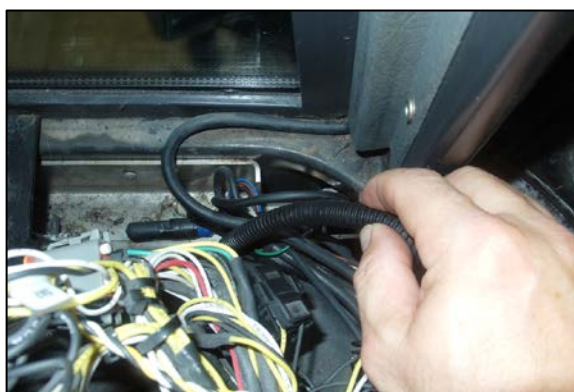

FIGURE 20

35. Prepare roof harness (long harness).
36. Use tool shown in Figure 21 and remove secondary locks in the roof harness connector MO62 and MO63.



FIGURE 21

37. Disconnect terminals on the roof harness connector MO62 and MO63.
38. Keep connectors, secondary locks and seals in a safe place.

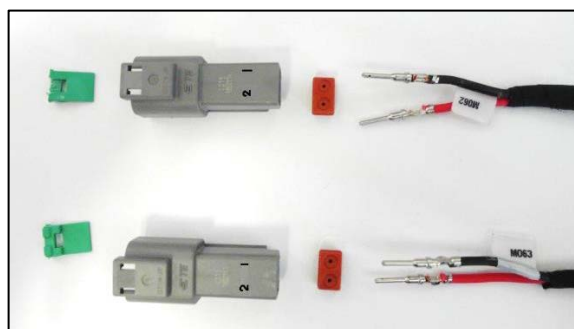

FIGURE 22

39. Install 2 foot of 0.50"ID convoluted tubing on the roof harness starting at connector C662 then 8 feet of 0.35"ID convoluted tubing.
40. Attach the sections of convoluted tubing together with black electrical tape as shown in Figure 23.



FIGURE 23

41. Into the front service compartment, connect male connector C662 with female connector C662.

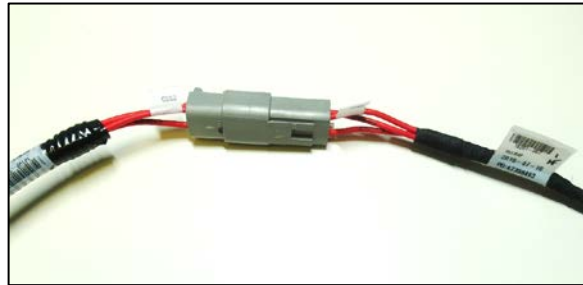

FIGURE 24

42. Run the roof harness through the opening at the bottom of the driver side pillar.
43. Use cable ties to secure all new wires in the front service compartment with existing wiring.

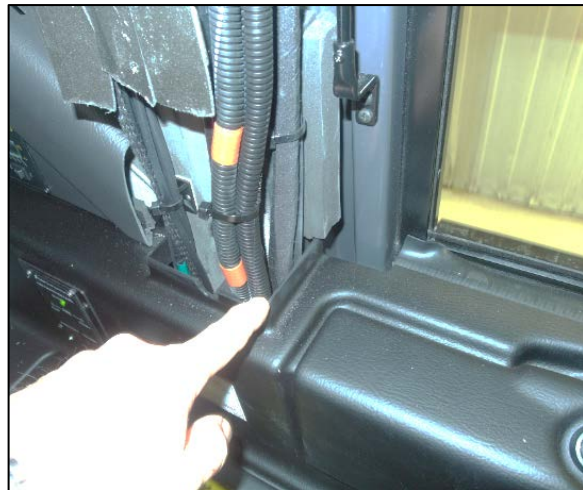

FIGURE 25

- 44. Run the roof harness through the opening at the top of the driver side pillar.
- 45. Use cable ties to secure the harness with existing wiring.



FIGURE 26

- 46. Run the roof harness from the top of the driver side pillar to the light control panel interspace (bottom of the parcel rack).



FIGURE 27

- 47. Run the whole roof harness through the light control panel interspace (bottom of the parcel rack) up to the rear hatch.



FIGURE 28

48. Drill a 9/16" diameter hole through the overhead compartment structure as shown in Figure 29.
49. Install a grommet and run the front hatch wiring section of the roof harness through the hole.



FIGURE 29

50. Drill a 1/2" diameter hole through the top finishing moulding and install a grommet.
51. Run the wiring through the grommet.
52. Drill 1/4" diameter holes (2) through the compartment support to install cable ties.
53. Install medium cable ties (3) but do not tighten.

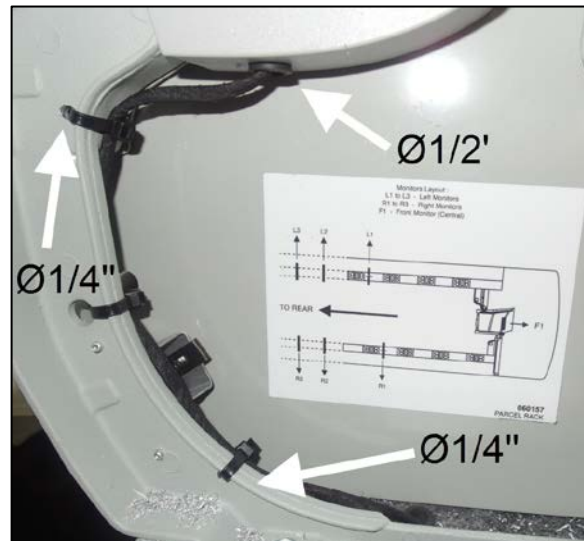

FIGURE 30

54. Install 3" long of 0.35" ID convoluted tubing where the wiring is exiting the finishing moulding to protect the wiring when the center roof panel is in place.



FIGURE 31

55. Make a groove into the roof insulation as shown in Figure 32. The groove has to be ¼" wide and between ¼" to ½" deep.

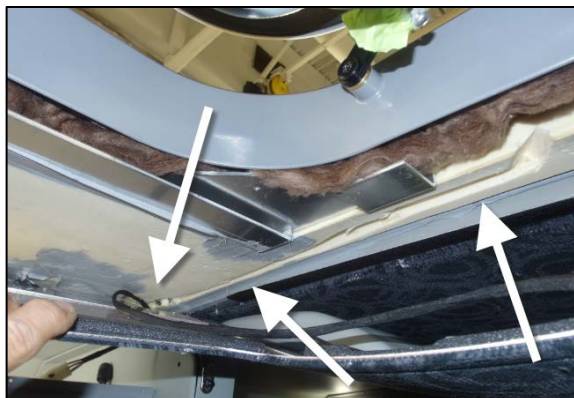

FIGURE 32

56. Drill holes in both existing hatch frames on the front side as shown in Figure 33.

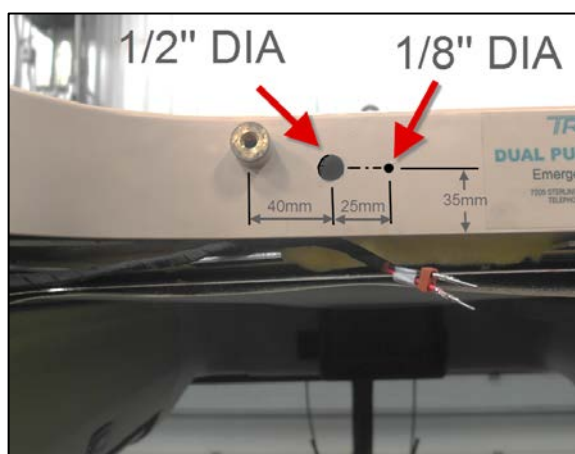

FIGURE 33

57. Install both new hatches with fan. Apply Loctite on screws. Make sure all springs are in place.
58. For both new hatches, run the fan wiring through the ½" diameter hole and fix the wire holder as shown in Figure 34.



FIGURE 34

59. If applicable, cut the excess of fan wiring.
60. Install seal, socket terminals, male connector and secondary lock on the front fan motor wiring. Connect white wire in pin #1 and black wire in pin #2.



FIGURE 35

61. Reinstall terminals into connector Mo62 on the front section roof harness with the seal and the secondary lock. Red wire goes into pin #1 and black wire goes into pin #2 and

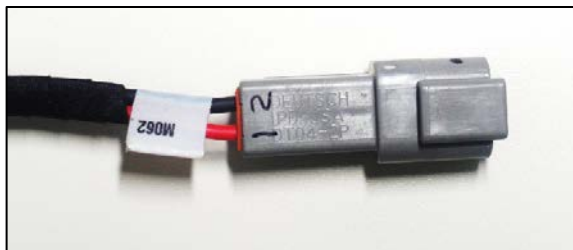

FIGURE 36

62. Connect the front fan male connector to the roof harness female connector.

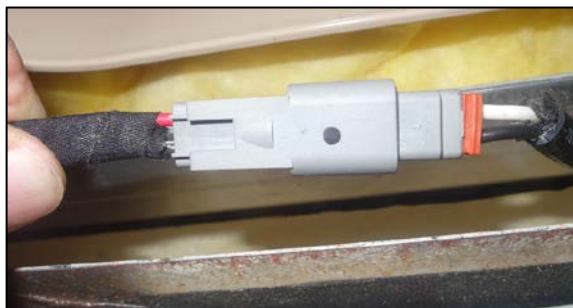

FIGURE 37

63. Position the connector on the top of the bracket (Figure 38).
64. Insert wiring into the groove and use duct tape to keep it in place.
65. Pull the excess length of wire down to the light control interspace.



FIGURE 38

66. Install 3" long of 0.35" ID convoluted tubing around the panel bracket to protect the wiring (Figure 39).
67. Tighten the cable ties.

NOTE

Make sure the new wiring is always protected against wearing or cutting or squeezing between existing parts.

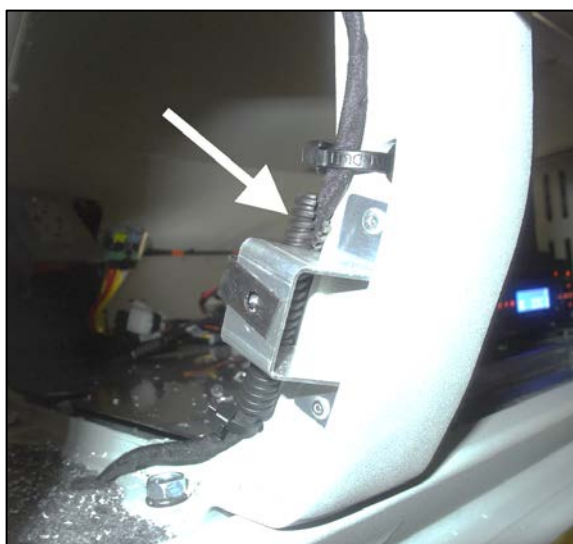

FIGURE 39

68. Into the light control panel interspace, apply sealant #684685 as shown in Figure 40 to secure the grommet and the wiring.



FIGURE 40

69. Repeat the wiring installation for the rear hatch.
70. Drill a 1/2" diameter hole through the top finishing moulding and install a grommet.
71. Drill a 9/16" diameter hole through overhead compartment structure and install a grommet.
72. Run the wiring through the grommets.
73. Drill 1/4" diameter holes (2) through the compartment support to install cable ties.
74. Install medium cable ties (3) but do not tighten.

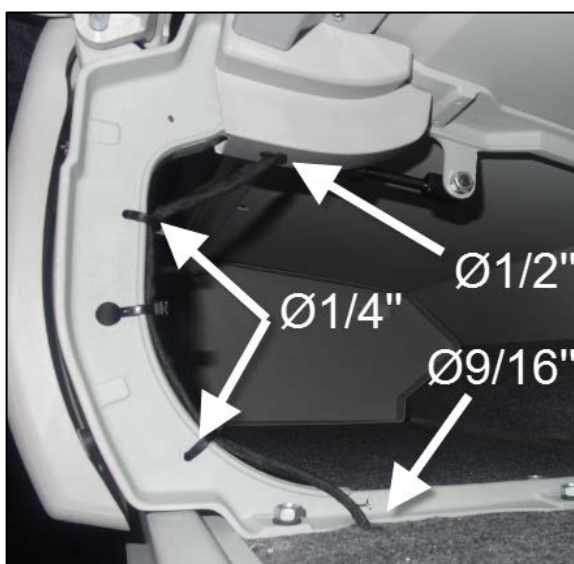

FIGURE 41

75. Groove the roof insulation as shown in Figure 42.

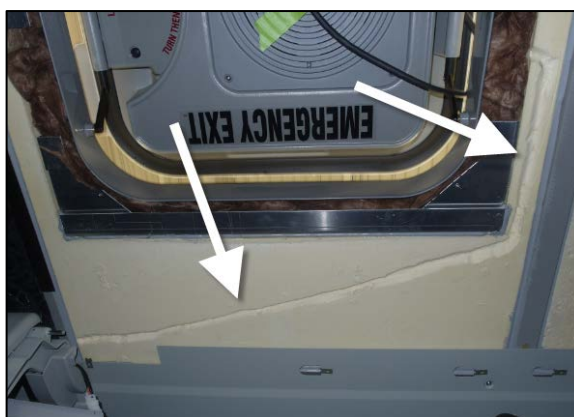

FIGURE 42

76. If necessary, add a length of wiring to the rear section of the harness to make it long enough.
77. If applicable, add label Mo63 and wrap the new wires together with hockey tape.

| |
|--|
| <i>NOTE</i> |
| <i>Kit includes wires, splice and terminal for this operation.</i> |



FIGURE 43

78. On the roof harness, install terminals into connector Mo63 on the rear section roof harness with the seal and the secondary lock. Red wire goes into pin #1 and black wire goes into pin #2.

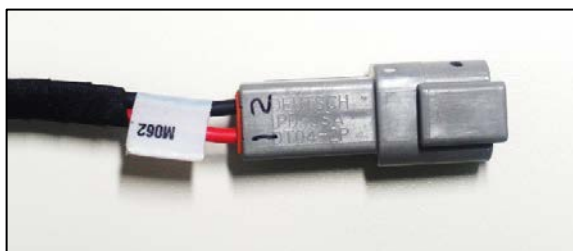

FIGURE 44

79. On the fan wiring, install seal, socket terminals, male connector and secondary lock on the front fan motor wiring. Connect white wire in pin #1 and black wire in pin #2.



FIGURE 45

80. Connect the rear fan male connector to the roof harness female connector.

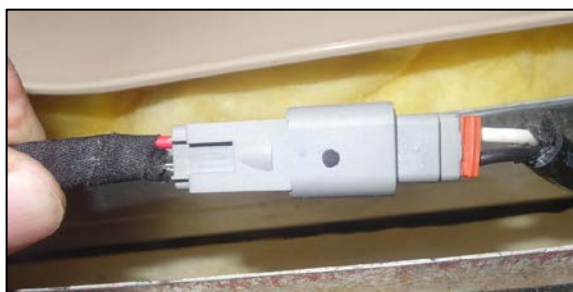

FIGURE 46

81. Run the wiring into the groove as shown in Figure 47.

82. Use duct tape to keep the wiring in place.



FIGURE 47

83. Insert wiring into the groove and use duct tape to keep it in place.

84. Pull the excess length of wire down to the light control interspace.



FIGURE 48

85. Tighten the cable ties.

NOTE

Make sure the new wiring is always protected against wearing or cutting or squeezing between existing parts.



FIGURE 49

86. Into the light control panel interspace, apply sealant #684685 as shown in Figure 50 to secure the grommet and the wiring.



FIGURE 50

87. From the dashboard, connect male connector C600 to the female connector C600.
88. Use cable ties to secure all new wires with existing wiring.
89. Test both fans are running well and pushing air outside the vehicle.



FIGURE 51

90. To clear the fan electrical wiring, make a V-groove on the finishing moulding as shown in Figure 52.

91. Install the finishing moulding.

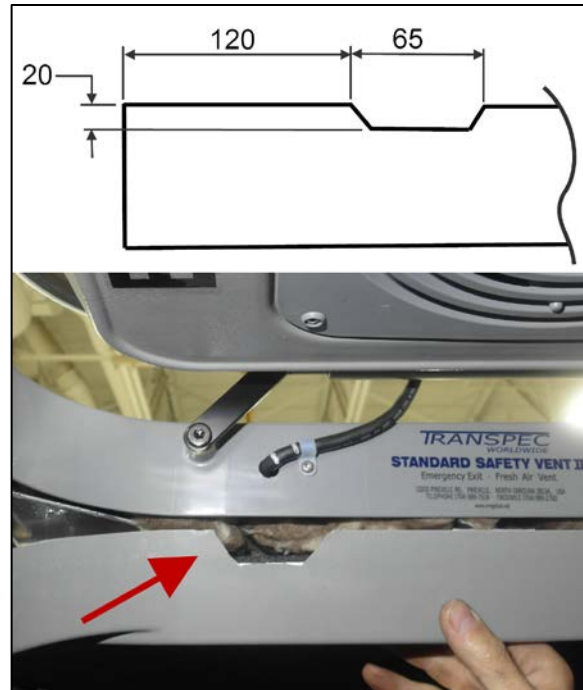

FIGURE 52

92. Reinstall these components:

- Module A (3 screws) into the dashboard.
- Horizontal protective panel into the front service compartment.
- Vertical protective panel into the front service compartment.
- All light control panels.
- Center roof panels.
- Both overhead compartment light support
- Overhead compartment doors.
- Driver side parcel rack end cover.
- Finishing plastic moulding into the overhead compartment.
- Separation panel into the second compartment.
- Finishing plastic moulding on the driver side pillar.
- Dashboard cover.

93. Bulletin is complete.

SECTION 2: FOR H3 MODELS BEFORE NEW ELECTRICAL ARCHITECTURE

Kit # IS-18905_3 contains the following parts:

| Part No. | Description | Qty |
|----------|---|-----|
| 950456 | HATCH WITH FAN (BEIGE) | 2 |
| 067352 | HARNESS FOR HATCHES W/FAN - DASH SECTION (BEFORE NEA) | 1 |
| 067350 | HARNESS FOR HATCHES W/FAN - ROOF SECTION (BEFORE NEA) | 1 |
| 504637 | CABLE TIE, NYLON BLK (STD) | 30 |
| 562697 | SWITCH, NGR EATON 8961K680 | 2 |
| 565927 | CAP SWITCH EATON - HATCHES (VENT. ROOF) | 2 |
| 504273 | CABLE TIE, NYLON BLK (SMALL) | 10 |
| 562286 | TERMINAL PIN, FOR ROOF HARNESS REAR FAN WIRE EXTENDING | 4 |
| 562482 | TERMINAL SOCKET, FOR FAN CONNECTOR | 6 |
| 562485 | DEUTSCH CONNECTOR 2C SHP, MALE, FOR MOTOR | 2 |
| 562488 | SECONDARY LOCK DEUTSCH, FOR CONNECTOR 562485 | 2 |
| 563623 | BUTT SPLICE / 16-14 / BLUE / W/THERMORETRAC / PANDUIT BSH14-Q | 7 |
| 502854 | NUT HEX N500 M6-1 | 1 |
| 560668 | ELECTRICAL WIRE RED, 14 AWG, GXL, 125 deg (ft) | 3 |
| 562585 | ELECTRICAL WIRE BLACK, 14 AWG, TXL, 125 deg (ft) | 3 |
| 562387 | CONVOLUTED TUBING NYL 0.25"ID (ft) | 2 |
| 561681 | CONVOLUTED TUBING NYL 0.35"ID (ft) | 15 |
| 561683 | CONVOLUTED TUBING NYL 0.50"ID (ft) | 2 |
| 504447 | GROMMET .5X.062X.312X.625 | 6 |
| 503765 | HOSE GH 134-10 (ft) | 0.5 |
| IS18905 | INSTRUCTION SHEET | 1 |
| FI18905 | FEUILLE D'INSTRUCTIONS | 1 |

Other parts that may be required with kit IS-18905_3 :

| Part No. | Description | Qty |
|----------|---|---------|
| 564099 | HOCKEY TAPE BLACK | AS REQ. |
| 684013 | CAOUTCHOUC PROTECTION FOR ELECTRICAL TERMINAL | AS REQ. |
| 684685 | ADHESIVE/SEALANT SIMMON ISR70-03 BLACK | AS REQ. |
| 680038 | LOCTITE 243 BLUE | AS REQ. |



DANGER

Park vehicle safely, apply parking brake, stop the engine. Prior to working on the vehicle, set the ignition switch to the OFF position and trip the main circuit breakers equipped with a trip button.

SECTION 2: FOR H3 MODELS BEFORE NEW ELECTRICAL ARCHITECTURE

PROCEDURE (H3 MODELS BEFORE NEA)

94. Install protection to the seats.



FIGURE 53

95. Prepare the new hatches.

96. If applicable, remove the plastic frame on both new hatches. Use Torx #40 and remove the screws (4).

97. Keep the screws in a safe place.



FIGURE 54

98. Remove the wire holder that fixes the wire on the frame. Use a Torx #20.
99. Keep the screw and the holder in a safe place.
100. Discard both plastic frames.

| |
|---|
| NOTE |
| <i>The new hatches are to be installed on the existing frames which are glued on the vehicle.</i> |



FIGURE 55

101. Remove all hatch levers (4) and springs from both new hatches and keep in a safe place.



FIGURE 56

102. Remove both existing hatches on the vehicle by removing the screws (4 per hatch).
103. Discard the existing hatches and fasteners.



FIGURE 57

- 104. Remove the finishing plastic moulding of both roof exits.
- 105. Keep the moulding and screws in a safe place.

| |
|---|
| NOTE |
| <i>The new hatches are to be installed on the existing hatch frames which are glued on the vehicle.</i> |



FIGURE 58

- 106. Remove the dashboard cover by unscrewing the M4 – 0.7x 20 screws (5) that secure it to the dashboard.

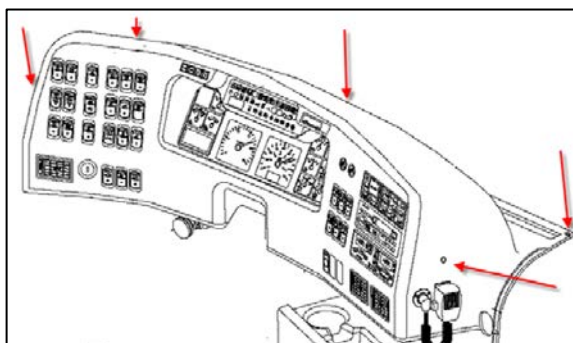

FIGURE 59

- 107. Remove the finishing plastic moulding on the driver side pillar.



FIGURE 60

108. Remove driver side parcel rack end cover.



FIGURE 61

109. Unscrew the light control panel (6 screws per panel) in line with the front hatch and the panel in line with the rear hatch. Do not disconnect wiring.

| |
|---|
| NOTE |
| <i>Step 109 is to facilitate the installation of the harness. Unscrew only panels as necessary.</i> |



FIGURE 62

110. Remove vertical protective panel into the front service compartment.



FIGURE 63

111. Remove horizontal protective panel into the front service compartment.

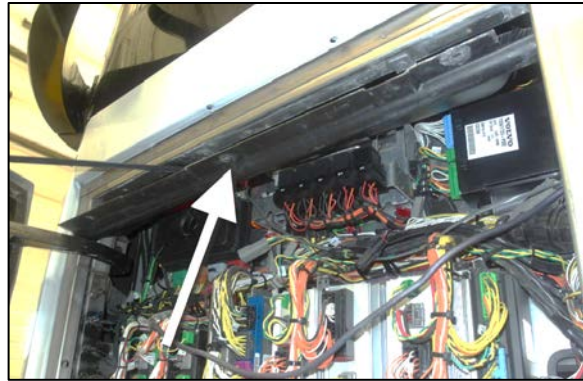

FIGURE 64

112. Prepare the installation of the dashboard fan switches and dash harness (short harness).



FIGURE 65

113. On the dash harness, locate wire 114A (yellow), wire 115A (yellow) and the ground wire 00A (black).

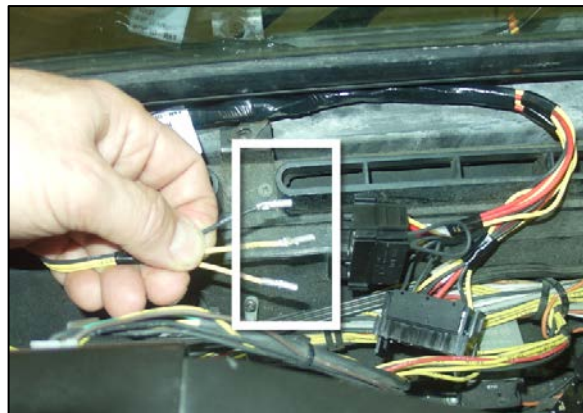

FIGURE 66

114. Cut the terminals on these wires and remove insulation for splicing.

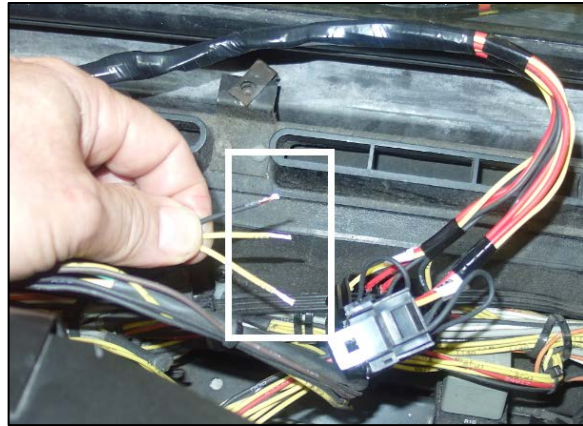

FIGURE 67

115. To allow more room to work, unscrew Module A (3 screws). Do not disconnect wiring.



FIGURE 68

116. Locate the driver light switch on the dashboard.



FIGURE 69

- 117. From inside the dashboard, disconnect the driver light switch connector (Sw24).
- 118. Locate wire 114A (yellow at pin 10), wire 115A (yellow at pin 9) and the ground wire 00A (black).

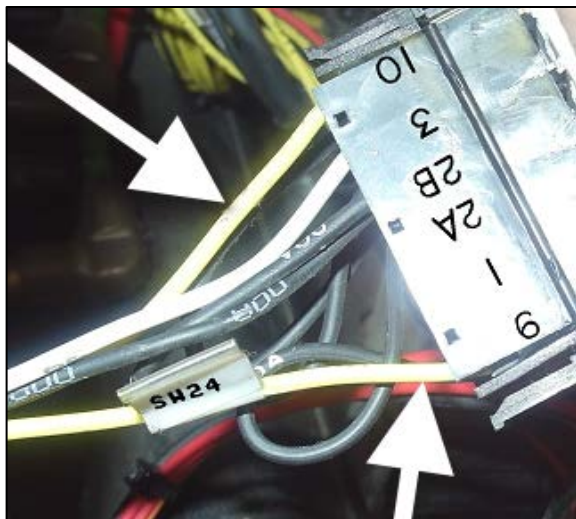

FIGURE 70

- 119. Splice wire 114A of the dash harness with wire 114A of the driver light switch (Sw24).
- 120. Splice wire 115A of the dash harness with wire 115A of the driver light switch (Sw24).
- 121. Splice wire 00A of the dash harness with wire 00A of the driver light switch (Sw24).

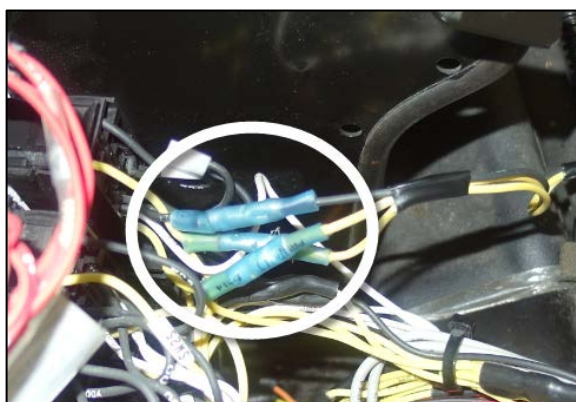

FIGURE 71

- 122. Install switches with the red light facing down as shown in Figure 72.



FIGURE 72

123. Install switch caps with the fan sign facing up as shown in Figure 73.
124. On the back of each switch, connect dash harness switch connectors, Sw305 (front fan) on the left and Sw306 (rear fan) on the right.



FIGURE 73

125. Run the dash harness up to the front service compartment through the aperture close to the left windshield pillar.
126. Use cable ties to secure all new wires with existing wiring.

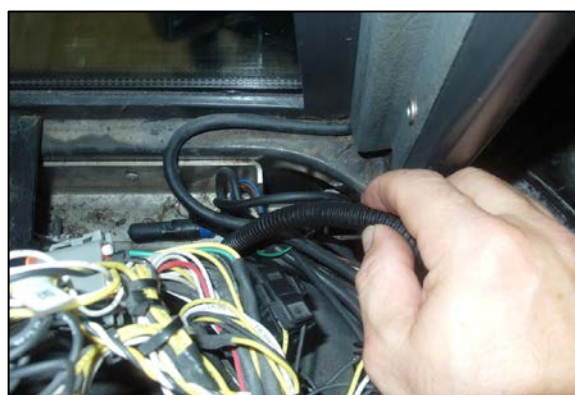

FIGURE 74

127. Do not connect wire 24RHF and wire OFB2 on the roof harness (long harness). They are connected at last to avoid having power on the electrical line.

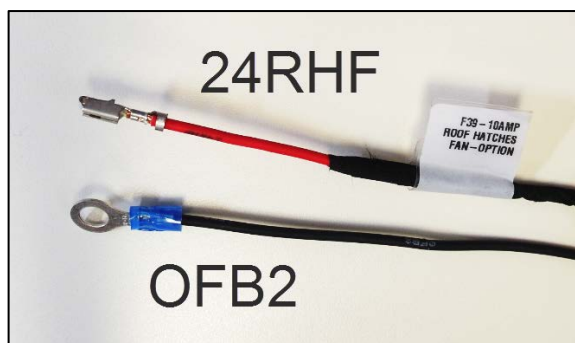

FIGURE 75

128. Prepare roof harness (long harness).
129. Use tool shown in Figure 76 and remove secondary locks in the roof harness connector MO62 and MO63.



FIGURE 76

130. Disconnect terminals on the roof harness connector MO62 and MO63.
131. Keep connectors, secondary locks and seals in a safe place.

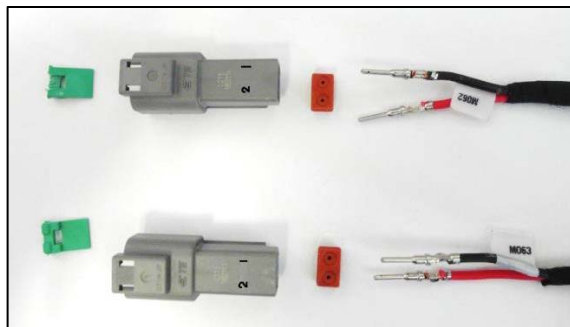

FIGURE 77

132. Install 2 feet of 0.50" diameter loom on the roof harness starting at connector CSS2 then 8 feet of 0.35" diameter loom.
133. Attach the sections of looms together with black electrical tape as shown in Figure 78.

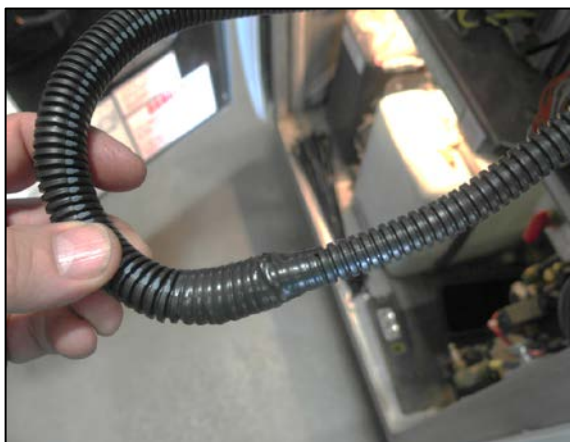

FIGURE 78

134. Into the front service compartment, connect male connector CSS2 with female connector CSS2.



FIGURE 79

- 135. Run the roof harness through the opening at the bottom of the driver side pillar.
- 136. Use cable ties to secure all new wires in the front service compartment with existing wiring.



FIGURE 80

- 137. Run the roof harness through the opening at the top of the driver side pillar.
- 138. Use cable ties to secure the harness with existing wiring.



FIGURE 81

- 139. Run the roof harness from the top of the driver side pillar to the light control panel interspace (bottom of the parcel rack).



FIGURE 82

140. Run the whole roof harness through the light control panel interspace (bottom of the parcel rack) up to the rear hatch (Figure 83).



FIGURE 83

141. Drill a 9/16" diameter hole through the overhead compartment structure as shown in Figure 84.

142. Install a grommet and run the front hatch wiring section of the roof harness through the hole.

143. Install 1 foot of convoluted tubing on the wiring from the grommet.

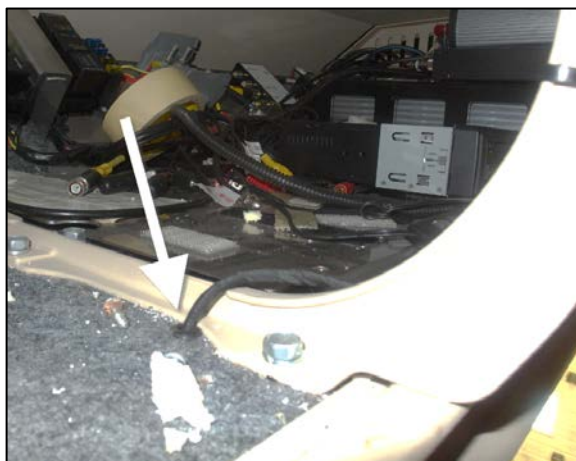

FIGURE 84

144. Run the wiring through the aperture over the top finishing moulding. Make sure the convoluted tubing is protecting the wiring at this transition.



FIGURE 85

145. Groove the roof insulation as shown in Figure 86.
146. Cut a length of 75 mm of a hose.
147. Install the hose between the metal structure and the roof insulation as shown in Figure 86.
148. Run the front section roof harness through the hose.



FIGURE 86

149. Drill holes in both existing hatch frames on the front side as shown in Figure 87.

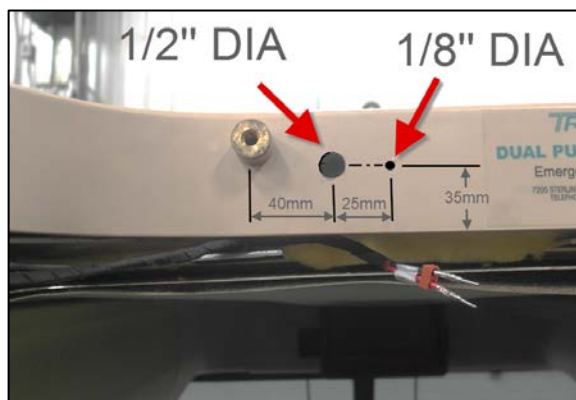

FIGURE 87

150. Install both new hatches with fan. Apply Loctite on screws. Make sure all springs are in place.
151. For both new hatches, run the fan wiring through the 1/2" diameter hole and fix the wire holder as shown in Figure 88.



FIGURE 88

152. If applicable, cut the excess of fan wiring.
153. On the fan wiring, install seal, socket terminals, male connector and secondary lock on front fan motor wiring. Connect black wire in pin #1 and white wire in pin #2.



FIGURE 89

154. On the roof harness, install terminals into connector Mo62 on the front section roof harness with the seal and the secondary lock. Black wire goes into pin #1 and red wire goes into pin #2.



FIGURE 90

155. Connect the front fan male connector to the roof harness female connector.

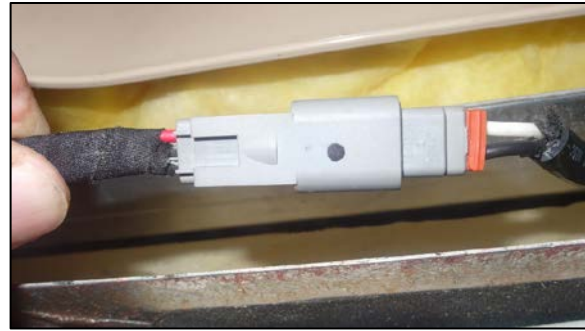

FIGURE 91

156. Keep cutting the roof insulation and install the wiring and connectors into the groove as shown in Figure 92.

157. Pull the excess length of wire down to the light control interspace.

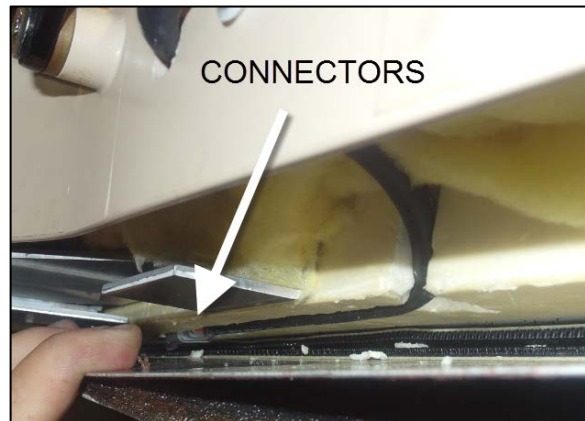

FIGURE 92

158. Install a cable tie as shown in Figure 93.

NOTE

Make sure the new wiring is always protected against wearing or cutting or squeezing between existing parts.

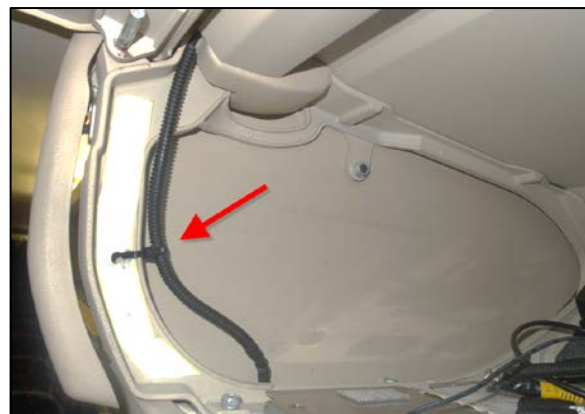

FIGURE 93

159. Into the light control panel interspace, apply sealant #684685 as shown in Figure 94 to secure the grommet and the wiring.



FIGURE 94

160. Repeat the wiring installation for the rear hatch.
161. Drill a 1/2" diameter hole through the top finishing moulding and install a grommet.
162. Drill a 9/16" diameter hole through overhead compartment structure and install a grommet.
163. Run the wiring through the grommets.
164. Drill 1/4" diameter holes (2) through the compartment support to install cable ties.
165. Install medium cable ties (3) but do not tighten.

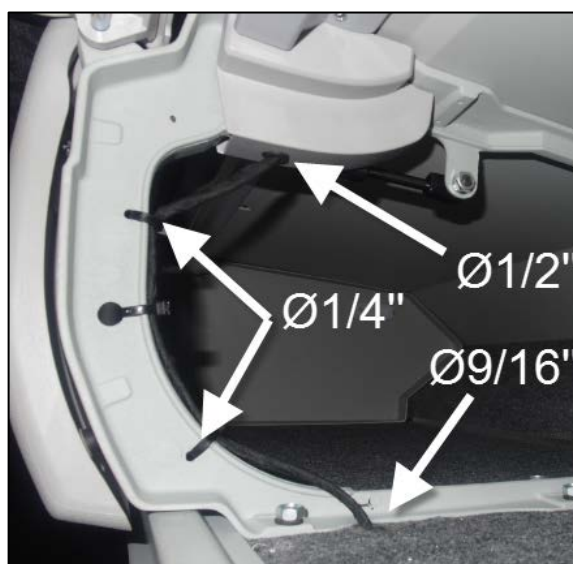

FIGURE 95

166. Groove the roof insulation as shown in Figure 96.
167. Cut a length of 75 mm of a hose.
168. Install the hose between the metal structure and the roof insulation as shown in Figure 96.
169. Run the wiring through the hose.



FIGURE 96

170. If necessary, add a length of wiring to the rear section of the harness to make it long enough.
171. If applicable, add label Mo63 and wrap the new wires together with hockey tape.

| |
|--|
| <i>NOTE</i> |
| <i>Kit includes wires, splice and terminal for this operation.</i> |



FIGURE 97

172. On the roof harness, install terminals into connector Mo63 on the rear section roof harness with the seal and the secondary lock. Black wire goes into pin #1 and red wire goes into pin #2.



FIGURE 98

173. On the fan wiring, install seal, socket terminals, male connector and secondary lock on rear fan motor wiring. Connect black wire in pin #1 and white wire in pin #2.



FIGURE 99

174. Connect the rear fan male connector to the roof harness female connector.



FIGURE 100

175. Run the wiring into the grooving and above the structure as shown in Figure 101.
176. Use duct tape to keep the wiring in place for the next steps.
177. Pull the excess length of wire down to the light control interspace.



FIGURE 101

178. Tighten the cable ties.

| |
|---|
| NOTE |
| <i>Make sure the new wiring is always protected against wearing or cutting or squeezing between existing parts.</i> |



FIGURE 102

179. Into the light control panel interspace, apply sealant #684685 as shown in Figure 103 to secure the grommet and the wiring.



FIGURE 103

180. Locate wire 24RHF and wire OFB2 from the roof harness (long harness) into the front service compartment.

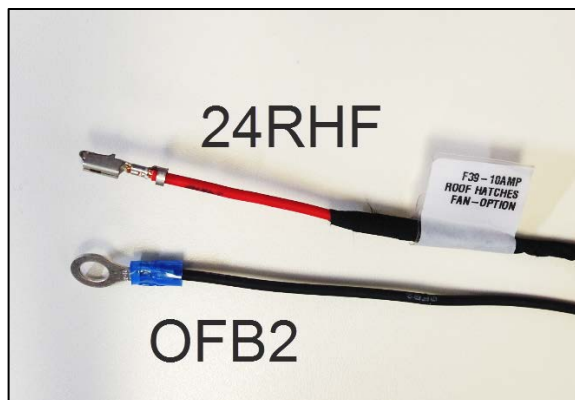

FIGURE 104

181. Into the front service compartment, locate the VECF4 connector (orange).



FIGURE 105

182. Disconnect the VECF4 connector if necessary.

183. Orientate terminal locking tab of the wire 24RHF with the VECF4 connector as shown in Figure 106.

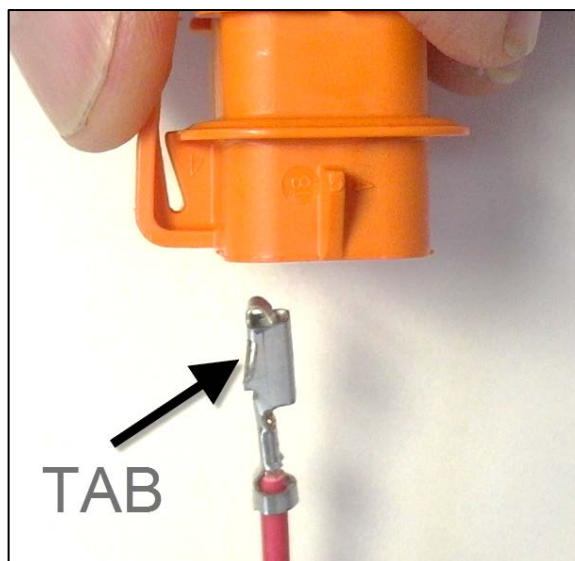

FIGURE 106

184. Connect wire 24RHF into pin C of VECF4 connector and make sure it is locked in place.
185. Reconnect VECF4 connector if applicable.

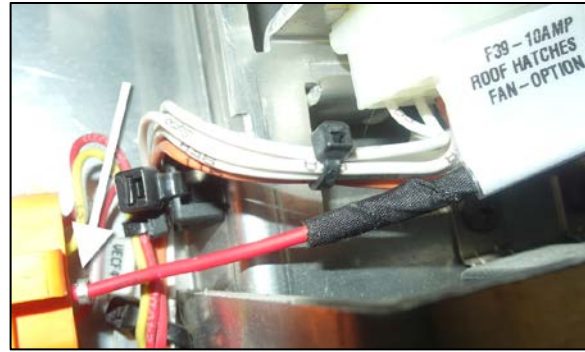

FIGURE 107

186. Into the front service compartment, on the left, locate the "On chassis" welded ground studs.
187. Select a free stud or one with the minimum connections.
188. Clean the contact surface if necessary.

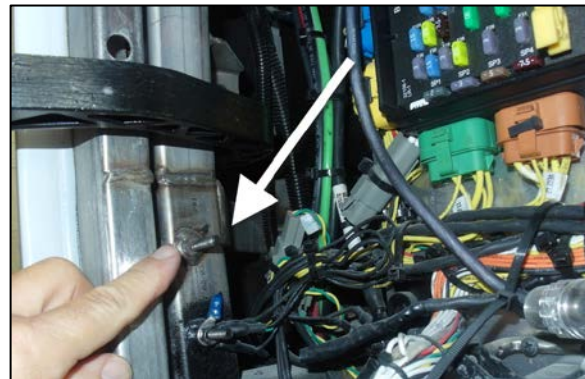

FIGURE 108

189. Connect wire OFB2 to the "On chassis" welded ground stud. Use nut M6x1 if necessary.
190. Tighten to 106 lb-in (12 Nm)



FIGURE 109

191. Apply terminal protection on the terminal and nut (#684013).
192. Use cable ties to secure all new wires with existing wiring.
193. Turn ignition lever to Accessory or On position.
194. Test both fans are running well and pushing air outside the vehicle.

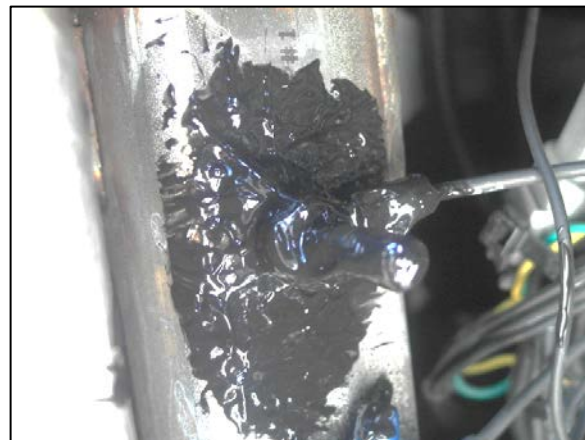

FIGURE 110

195. If necessary, make a V-shape cut out on the finishing moulding as shown in Figure 111.

196. Install the finishing moulding.



FIGURE 111

197. Reinstall these components:

- Module A (3 screws) into the dashboard.
- Horizontal protective panel into the front service compartment.
- Vertical protective panel into the front service compartment.
- All light control panels.
- Driver side parcel rack end cover.
- Finishing plastic moulding on the driver side pillar.
- Dashboard cover.

198. Bulletin is complete.

ESTIMATED TIME

The time required to perform this instruction sheet is approximately 6 hours per vehicle.

PARTS / WASTE DISPOSAL

Discard waste according to applicable environmental regulations (Municipal/State[Prov.]/ Federal)