

PREVOST

Instruction Sheet

IS18907

INSTALLATION OF HATCHES WITH FAN ON X3 MODELS

X3 MODELS	EFFECTIVITY	KIT TO ORDER	PAGE
X3-45 coaches Model Years : From 2017	From 2PCG33490 <u>HC736182</u>	IS-18907_1	2
	From 4RKG33496 <u>H9737395</u>		
X3-45 coaches Model Years : From 2007 up to 2017	From 2PCG33494 <u>71028754</u> up to 2PCG33490 <u>HC736179</u>	IS-18907_2	18
	From 4RKG33499 <u>G9737275</u> up to 4RKG33494 <u>H9737394</u>		

NOTE

Material can be obtained through regular channels.

SECTION 1: FOR X3 MODELS WITH NEW ELECTRICAL ARCHITECTURE

Kit # IS-18907_1 contains the following parts:

Part No.	Description	Qty
950583	HATCH WITH FAN (GREY)	2
061395	HARNESS FOR HATCHES W/FAN - DASH SECTION (NEA)	1
061396	HARNESS FOR HATCHES W/FAN - ROOF SECTION (NEA)	1
504637	CABLE TIE, NYLON BLK (STD)	30
562697	SWITCH, NGR EATON 8961K680	2
565927	CAP SWITCH EATON - HATCHES (VENT. ROOF)	2
504273	CABLE TIE, NYLON BLK (SMALL)	10
504637	CABLE TIE HOLDER	10
500638	SCREW TP BDG PH Z050 #8 X ½" LONG	10
562482	TERMINAL SOCKET, FOR FAN CONNECTOR	6
562485	DEUTSCH CONNECTOR 2C SHP, MALE, FOR MOTOR	2
562488	SECONDARY LOCK DEUTSCH, FOR CONNECTOR 562485	2
562387	CONVOLUTED TUBING NYL 0.25" ID (ft)	2
561681	CONVOLUTED TUBING NYL 0.35" ID (ft)	10
561683	CONVOLUTED TUBING NYL 0.50" ID (ft)	2
504447	GROMMET .5X.062X.312X.625	6
504339	RIVET POP DOME OE 1/8" DIA. X 3/8" Length SS	10
IS18907	INSTRUCTION SHEET	1
FI18907	FEUILLE D'INSTRUCTIONS	1

Other parts that may be required with kit IS-18907_1 :

Part No.	Description	Qty
564099	HOCKEY TAPE BLACK	AS REQ.
684685	ADHESIVE/SEALANT SIMMON ISR70-03 BLACK	AS REQ.
680038	LOCTITE 243 BLUE	AS REQ.



DANGER

Park vehicle safely, apply parking brake, stop the engine. Prior to working on the vehicle, set the ignition switch to the OFF position and trip the main circuit breakers equipped with a trip button.

SECTION 1: FOR X3 MODELS WITH NEW ELECTRICAL ARCHITECTURE

PROCEDURE

1. Install protection to the seats.



FIGURE 1

2. Prepare the new hatches.
3. If applicable, remove the plastic frame on both new hatches. Use Torx #40 and remove the screws (4).
4. Keep the screws in a safe place.



FIGURE 2

5. Remove the wire holder that fixes the wire on the frame. Use a Torx #20.
6. Keep the screw and the holder in a safe place.
7. Discard both plastic frames.



FIGURE 3

NOTE

The new hatches are to be installed on the existing frames which are glued on the vehicle.

8. Remove all hatch levers (4) and springs from both new hatches and keep in a safe place.



FIGURE 4

9. Remove both existing hatches on the vehicle by removing the screws (4 per hatch).
10. Discard the existing hatches and fasteners.



FIGURE 5

11. Remove the finishing plastic moulding of both roof exits.
12. Keep the moulding and screws in a safe place.

NOTE
<i>The new hatches are to be installed on the existing hatch frames which are glued on the vehicle.</i>



FIGURE 6

13. Remove the dashboard cover by unscrewing the M4 – 0.7x 20 screws (5) that secure it to the dashboard.

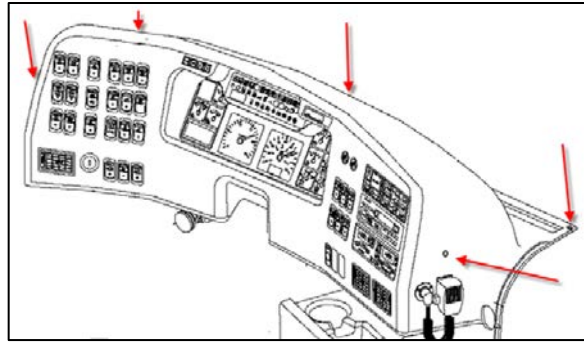

FIGURE 7

14. Remove the finishing plastic moulding on the driver side pillar.



FIGURE 8

15. Remove driver side parcel rack end cover.



FIGURE 9

16. Unscrew the light control panel (6 screws per panel) in line with the front hatch and the panel in line with the rear hatch. Do not disconnect wiring.

NOTE
<i>Step 16 is to facilitate the installation of the harness. Unscrew only panels as necessary.</i>



FIGURE 10

17. For both hatches, toward the vehicle front side, remove roof center panels completely.

NOTE
<i>Ceiling center panels are kept in place with a J-shape moulding on both sides and with heavy-duty Velcro. To avoid making a kink on the center panel, use a piece of wood and with assistance carefully pry off the panel.</i>



FIGURE 11

18. For both hatches, remove rivets on the roof transition panel finishing moulding (J-shape holder) driver side only.

19. Remove the moulding.

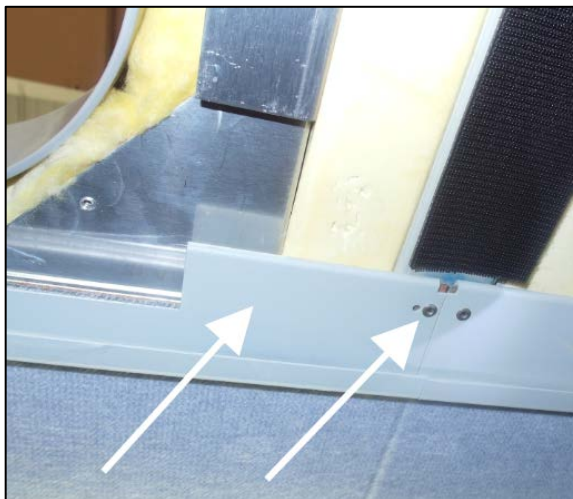

FIGURE 12

20. Dismount the air cylinder of the overhead compartment door in line with the front hatch.
21. Pull out the air cylinder head and at the same time, with a small flat screw driver, pry out partially the clip until the cylinder head moves out.



FIGURE 13

22. Remove the overhead compartment door in line with the front hatch and the door in line with the rear hatch.
23. Use a 2 mm between flat Allen key and loosen the set screw (item 1, Figure 14) that holds the hinge pivot in place.
24. Push the hinge pivot (item 2, Figure 14) just enough to release one door at a time.



FIGURE 14

NOTE
<i>It is not necessary to remove hinge pivot on both sides of a door. It is possible to remove the door with one pivot still in place.</i>

25. For both hatches, remove overhead compartment light.



FIGURE 15

26. Prepare the installation of the dashboard fan switches and dash harness (short harness).
27. Install 0.35" ID convoluted tubing on the dash harness wiring.



FIGURE 16

28. Install switches with the red light facing down as shown in Figure 17.



FIGURE 17

29. Install switch caps with the fan sign facing up as shown in Figure 18.
30. On the back of each switch, connect dash harness switch connectors, Sw602 (front fan) on the left and Sw603 (rear fan) on the right.



FIGURE 18

31. Locate existing male connector C600 into the dashboard.
32. Remove the existing female connector without wires on the existing male connector C600.
33. Do not connect yet the new female connector with the existing connector.

NOTE

Do not plug existing male connector C600 to the new female connector C600 to avoid having power on the electrical line. This operation will be done at the end.

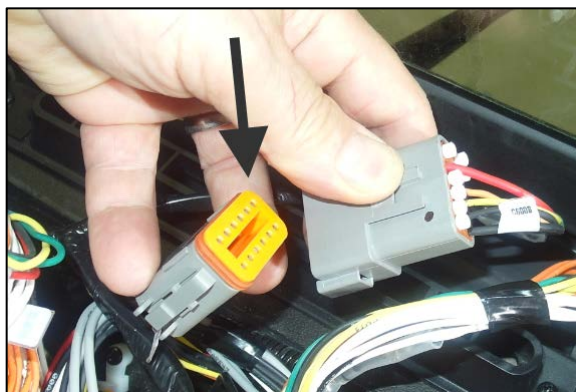

FIGURE 19

34. Run the dash harness up to the front service compartment through the aperture close to the left windshield pillar.
35. Use cable ties to secure all new wires with existing wiring.

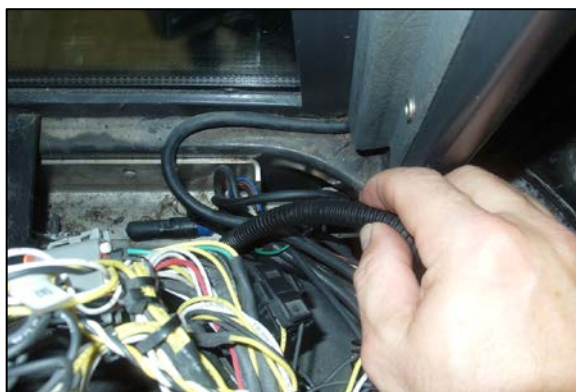

FIGURE 20

36. Prepare roof harness (long harness).
37. Use tool shown in Figure 21 and remove secondary locks in the roof harness connector MO62 and MO63.



FIGURE 21

38. Disconnect terminals on the roof harness connector MO62 and MO63.
39. Keep connectors, secondary locks and seals in a safe place.

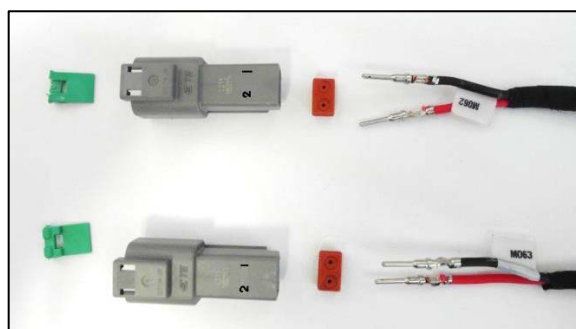

FIGURE 22

40. Install 2 foot long of 0.50" diameter loom on the roof harness starting at connector C662 then 8-foot long of 0.35" diameter loom.
41. Attach the sections of looms together with black electrical tape as shown in Figure 23.



FIGURE 23

42. Into the front service compartment, connect male connector C662 with female connector C662.



FIGURE 24

43. Run the roof harness through the opening at the bottom of the driver side pillar.
44. Use cable ties to secure all new wires in the front service compartment with existing wiring.

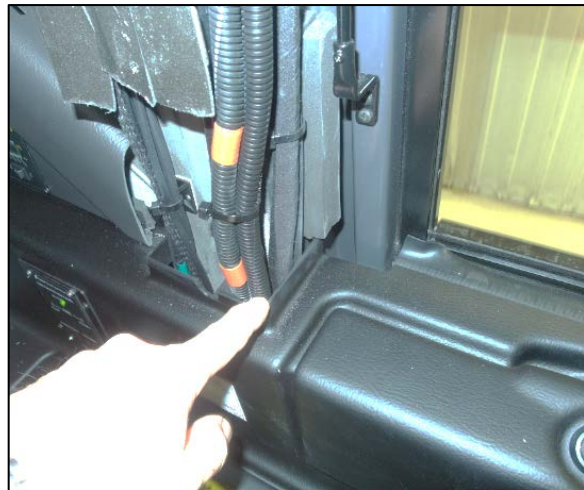

FIGURE 25

45. Run the roof harness through the opening at the top of the driver side pillar.
46. Use cable ties to secure the harness with existing wiring.



FIGURE 26

47. Run the roof harness from the top of the driver side pillar to the light control panel interspace (bottom of the parcel rack).



FIGURE 27

48. Run the whole roof harness through the light control panel interspace (bottom of the parcel rack) up to the rear hatch.



FIGURE 28

49. Drill a 9/16" diameter hole through the overhead compartment structure as shown in Figure 29.
50. Install a grommet and run the front hatch wiring section of the roof harness through the hole.



FIGURE 29

51. Drill a 1/2" diameter hole through the plastic moulding and install a grommet.
52. Run the front hatch section of the roof harness through the grommet.



FIGURE 30

53. Drill a 1/2" diameter hole through the top finishing moulding and install a grommet.
54. Run the wiring through the top grommet.
55. Drill 1/4" diameter holes (2) through the compartment support to install cable ties.
56. Install medium cable ties (3) but do not tighten.

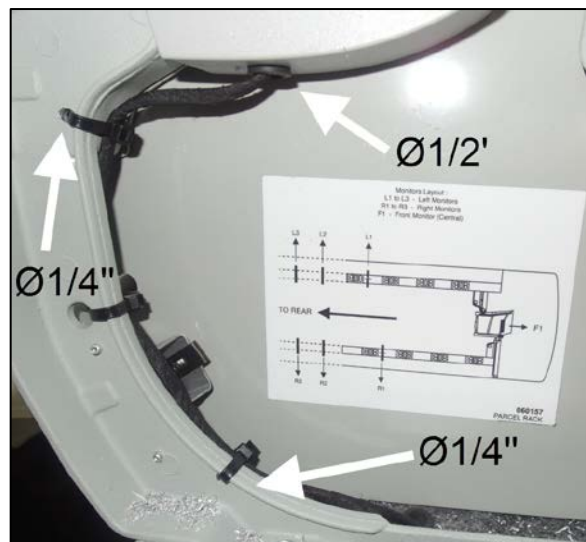

FIGURE 31

57. Drill a 1/2" diameter hole through the roof transition panel around 2" from the joint between panels.
58. Install a grommet.
59. Run the front hatch section of the roof harness through the grommet.
60. Drill two holes with a No. 29 drill bit as shown in Figure 32.
61. Install cable tie holders and cable ties, but do not tighten it.

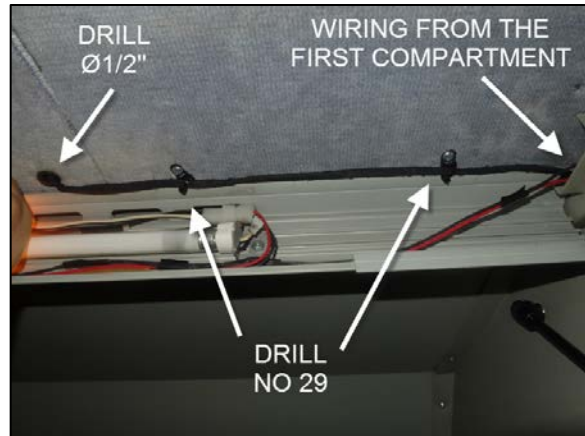

FIGURE 32

62. Make a groove into the roof insulation as shown in Figure 33. The groove has to be 1/4" wide and between 1/4" to 1/2" deep.



FIGURE 33

63. Drill holes in both existing hatch frames on the front side as shown in Figure 34

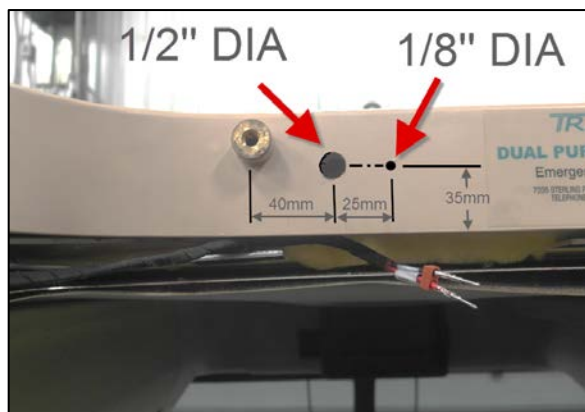

FIGURE 34

64. Install both new hatches with fan. Apply Loctite on screws. Make sure all springs are in place.
65. For both new hatches, run the fan wiring through the ½” diameter hole and fix the wire holder as shown in Figure 35.



FIGURE 35

66. If applicable, cut the excess of fan wiring.
67. On the fan wiring, install seal, socket terminals, male connector and secondary lock on the front fan motor wiring. Connect white wire in pin #1 and black wire in pin #2.



FIGURE 36

68. On the roof harness, install terminals into connector Mo62 on the front section roof harness with the seal and the secondary lock. Red wire goes into pin #1 and black wire goes into pin #2.



FIGURE 37

69. Connect the front fan male connector to the roof harness female connector.



FIGURE 38

70. Keep cutting the roof insulation and install the wiring and connectors into the groove as shown in Figure 39.



FIGURE 39

71. Use duct tape to keep the wiring in place.
72. Pull the excess length of wire down to the light control interspace.
73. Tighten the cable ties on this wiring section.

NOTE
<i>Make sure the new wiring is always protected against wearing or cutting or squeezing between existing parts.</i>

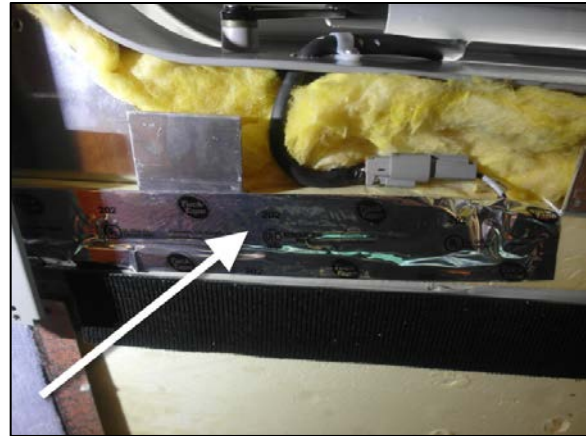

FIGURE 40

74. Into the light control panel interspace, apply sealant #684685 as shown in Figure 91 to secure the grommet and the wiring.



FIGURE 41

75. Repeat the wiring installation for the rear hatch.
76. Drill a 1/2" diameter hole through the top finishing moulding and install a grommet.
77. Drill a 9/16" diameter hole through overhead compartment structure and install a grommet.
78. Run the wiring through the grommets.
79. Drill 1/4" diameter holes (2) through the compartment support to install cable ties.
80. Install medium cable ties (3) but do not tighten.
81. Repeat steps 57 to 74 for the rear hatch installation.

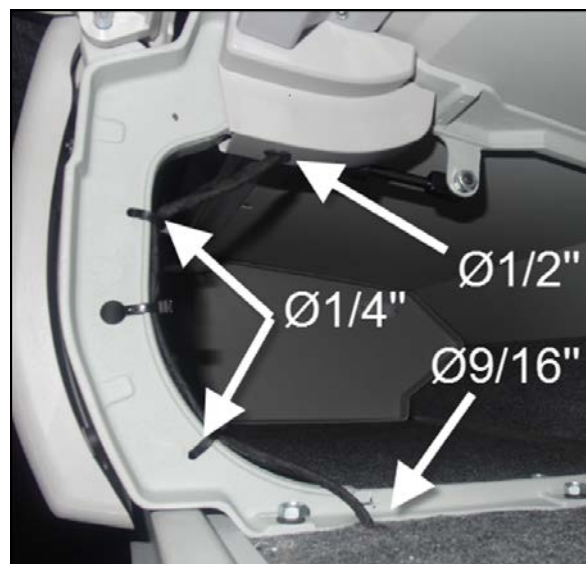

FIGURE 42

82. From the dashboard, connect male connector C600 to the female connector C600.
83. Use cable ties to secure all new wires with existing wiring.
84. Test both fans are running well and pushing air outside the vehicle.



FIGURE 43

85. Reinstall rivets on the roof transition panel finishing moulding.

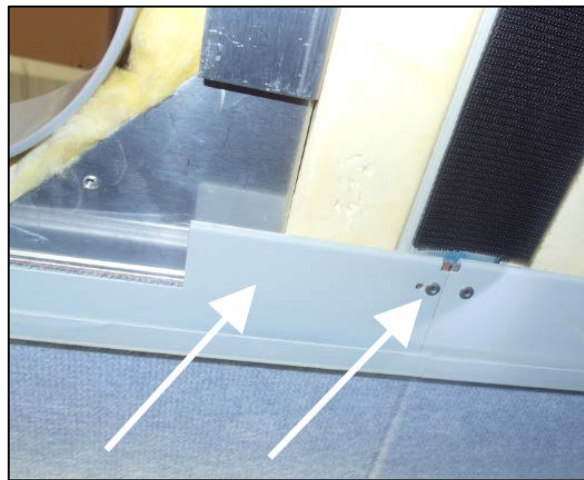

FIGURE 44

86. If necessary, make a V-shape cut out on the finishing moulding as shown in Figure 45.
87. Install the finishing moulding.

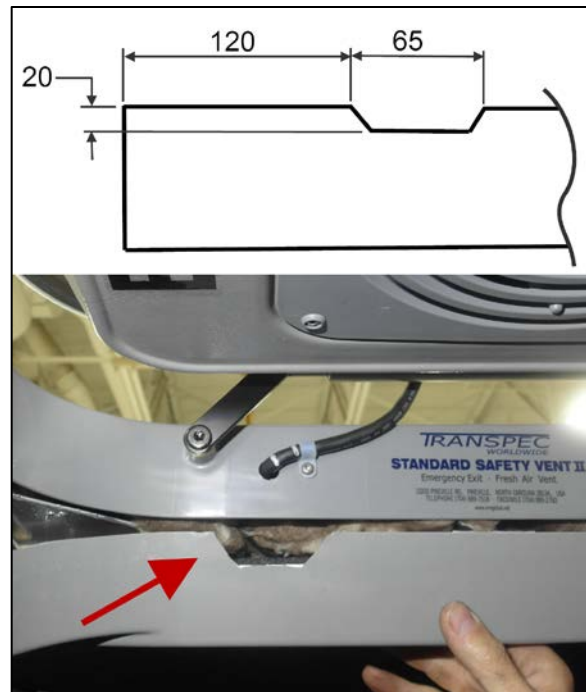

FIGURE 45

88. Reinstall these components:
- All light control panels.
 - Driver side parcel rack end cover.
 - Finishing plastic moulding on the driver side pillar.
 - Dashboard cover.
89. Bulletin is complete.

SECTION 2: FOR X3 MODELS BEFORE NEW ELECTRICAL ARCHITECTURE

Kit # IS-18907_2 contains the following parts:

Part No.	Description	Qty
950583	HATCH WITH FAN (GREY)	2
067352	HARNESS FOR HATCHES W/FAN - DASH SECTION (BEFORE NEA)	1
067350	HARNESS FOR HATCHES W/FAN - ROOF SECTION (BEFORE NEA)	1
504637	CABLE TIE, NYLON BLK (STD)	30
562697	SWITCH, NGR EATON 8961K680	2
565927	CAP SWITCH EATON - HATCHES (VENT. ROOF)	2
504273	CABLE TIE, NYLON BLK (SMALL)	10
504637	CABLE TIE HOLDER	10
500638	SCREW TP BDG PH Z050 #8 X ½" LONG	10
562482	TERMINAL SOCKET, FOR FAN CONNECTOR	6
562485	DEUTSCH CONNECTOR 2C SHP, MALE, FOR MOTOR	2
562488	SECONDARY LOCK DEUTSCH, FOR CONNECTOR 562485	2
563623	BUTT SPLICE / 16-14 / BLUE / W/THERMORETRAC / PANDUIT BSH14-Q	5
502854	NUT HEX N500 M6-1	1
562387	CONVOLUTED TUBING NYL 0.25"ID (ft)	2
561681	CONVOLUTED TUBING NYL 0.35"ID (ft)	15
561683	CONVOLUTED TUBING NYL 0.50"ID (ft)	2
504447	GROMMET .5X.062X.312X.625	6
504339	RIVET POP DOME OE 1/8"DIA. X 3/8" Length SS	10
IS18907	INSTRUCTION SHEET	1
FI18907	FEUILLE D'INSTRUCTIONS	1

Other parts that may be required with kit IS-18907_2 :

Part No.	Description	Qty
564099	HOCKEY TAPE BLACK	AS REQ.
684013	CAOUTCHOUC PROTECTION FOR ELECTRICAL TERMINAL	AS REQ.
684685	ADHESIVE/SEALANT SIMMON ISR70-03 BLACK	AS REQ.
680038	LOCTITE 243 BLUE	AS REQ.



DANGER

Park vehicle safely, apply parking brake, stop the engine. Prior to working on the vehicle, set the ignition switch to the OFF position and trip the main circuit breakers equipped with a trip button.

SECTION 2: FOR X3 MODELS BEFORE NEW ELECTRICAL ARCHITECTURE

PROCEDURE

90. Install protection to the seats.



FIGURE 46

91. Prepare the new hatches.

92. If applicable, remove the plastic frame on both new hatches. Use Torx #40 and remove the screws (4).

93. Keep the screws in a safe place.



FIGURE 47

94. Remove the wire holder that fixes the wire on the frame. Use a Torx #20.
95. Keep the screw and the holder in a safe place.
96. Discard both plastic frames.

NOTE

The new hatches are to be installed on the existing frames which are glued on the vehicle.

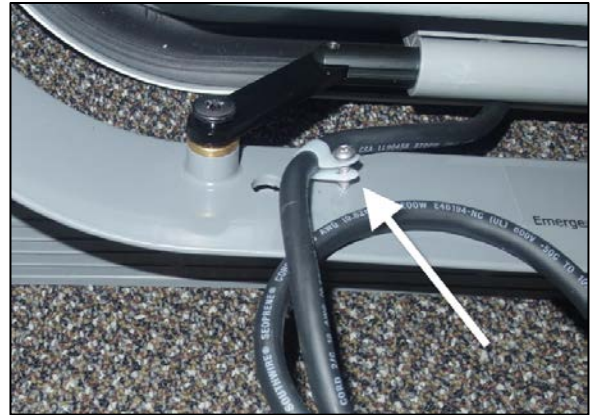

FIGURE 48

97. Remove all hatch levers (4) and springs from both new hatches and keep in a safe place.



FIGURE 49

98. Remove both existing hatches on the vehicle by removing the screws (4 per hatch).
99. Discard the existing hatches and fasteners.



FIGURE 50

100. Remove the finishing plastic moulding of both roof exits.
101. Keep the moulding and screws in a safe place.

NOTE

The new hatches are to be installed on the existing hatch frames which are glued on the vehicle.



FIGURE 51

102. Remove the dashboard cover by unscrewing the M4 – 0.7x 20 screws (5) that secure it to the dashboard.

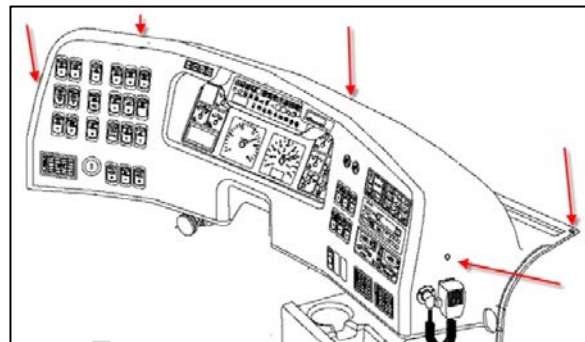

FIGURE 52

103. Remove the finishing plastic moulding on the driver side pillar.



FIGURE 53

104. Remove driver side parcel rack end cover.



FIGURE 54

105. Unscrew the light control panel (6 screws per panel) in line with the front hatch and the panel in line with the rear hatch. Do not disconnect wiring.

NOTE
<i>Step 105 is to facilitate the installation of the harness. Unscrew only panels as necessary.</i>



FIGURE 55

106. For both hatches, toward the vehicle front side, remove roof center panels completely.

NOTE
<i>Ceiling center panels are kept in place with a J-shape moulding on both sides and with heavy-duty Velcro. To avoid making a kink on the center panel, use a piece of wood and with assistance carefully pry off the panel.</i>



FIGURE 56

107. For both hatches, remove rivets on the roof transition panel finishing moulding (J-shape holder) driver side only.
108. Remove the moulding.

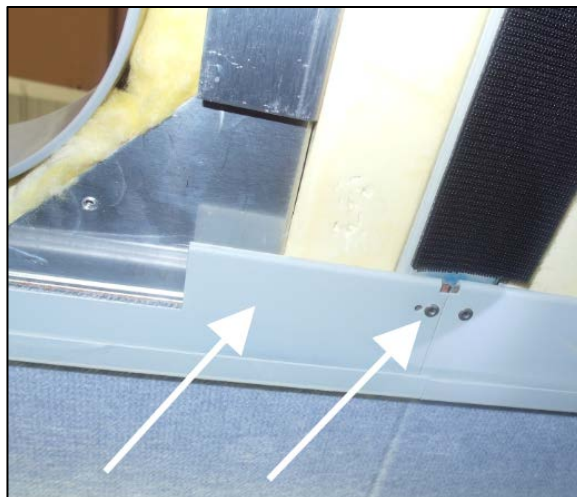

FIGURE 57

109. Dismount the air cylinder of the overhead compartment door in line with the front hatch.
110. Pull out the air cylinder head and at the same time, with a small flat screw driver, pry out partially the clip until the cylinder head moves out.



FIGURE 58

111. Remove the overhead compartment door in line with the front hatch and the door in line with the rear hatch.
112. Use a 2 mm between flat Allen key and loosen the set screw (item 1, Figure 59) that holds the hinge pivot in place.
113. Push the hinge pivot (item 2, Figure 59) just enough to release one door at a time.

NOTE

It is not necessary to remove hinge pivot on both sides of a door. It is possible to remove the door with one pivot still in place.



FIGURE 59

114. For both hatches, remove overhead compartment light.



FIGURE 60

115. Prepare the installation of the dashboard fan switches and dash harness (short harness).



FIGURE 61

116. On the dash harness, locate wire 114A (yellow), wire 115A (yellow) and the ground wire 00A (black).

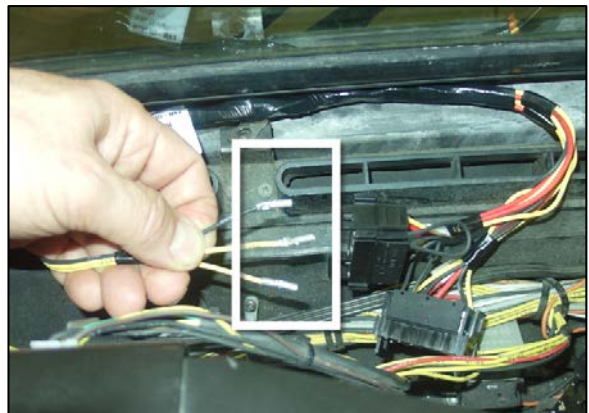

FIGURE 62

117. Cut the terminals on these wires and remove insulation for splicing.

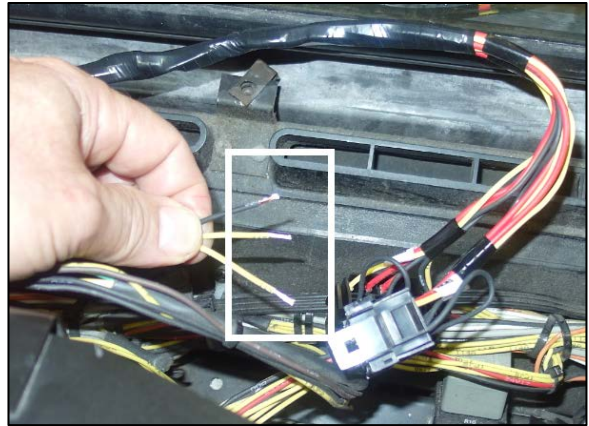

FIGURE 63

118. Locate the driver light switch on the dashboard.



FIGURE 64

119. From inside the dashboard, disconnect the driver light switch connector (Sw24).

120. Locate wire 114A (yellow at pin 10), wire 115A (yellow at pin 9) and the ground wire 00A (black).

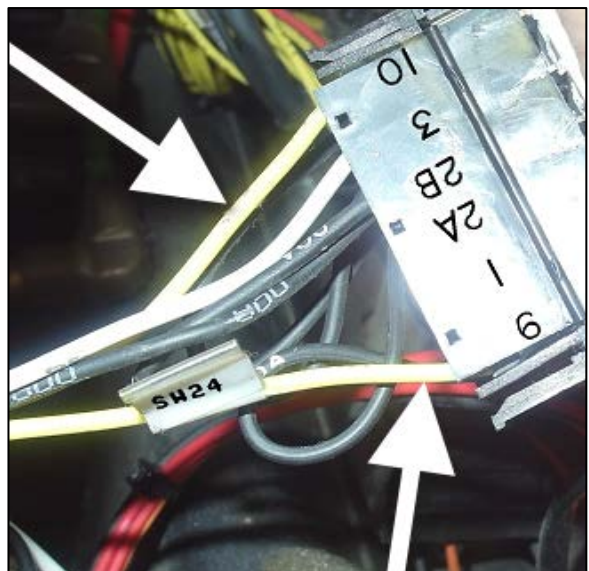

FIGURE 65

- 121. Splice wire 114A of the dash harness with wire 114A of the driver light switch (Sw24).
- 122. Splice wire 115A of the dash harness with wire 115A of the driver light switch (Sw24).
- 123. Splice wire 00A of the dash harness with wire 00A of the driver light switch (Sw24).

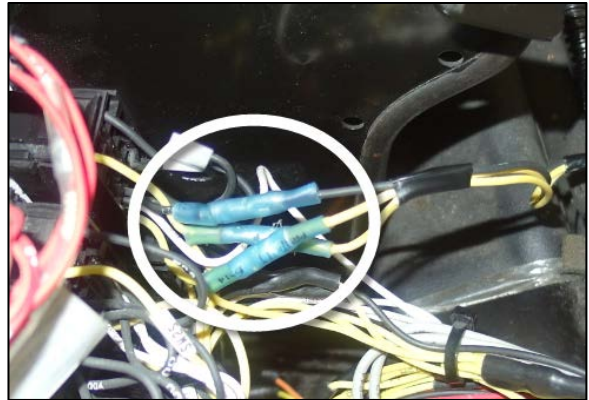

FIGURE 66

- 124. Install switches with the red light facing down as shown in Figure 67.



FIGURE 67

- 125. Install switch caps with the fan sign facing up as shown in Figure 68.
- 126. On the back of each switch, connect dash harness switch connectors, Sw305 (front fan) on the left and Sw306 (rear fan) on the right.



FIGURE 68

127. Run the dash harness up to the front service compartment through the aperture close to the left windshield pillar.

128. Use cable ties to secure all new wires with existing wiring.



FIGURE 69

129. Do not connect Wire 24RHF and wire OFB2 on the roof harness (long harness). They are connected at last to avoid having power on the electrical line.

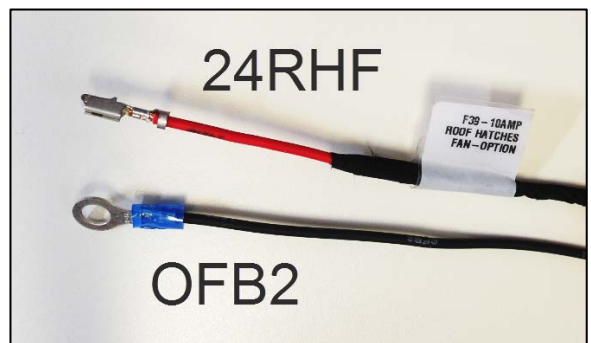

FIGURE 70

130. Prepare roof harness (long harness).

131. Use tool shown in Figure 71 and remove secondary locks in the roof harness connector MO62 and MO63.



FIGURE 71

132. Disconnect terminals on the roof harness connector MO62 and MO63.

133. Keep connectors, secondary locks and seals in a safe place.

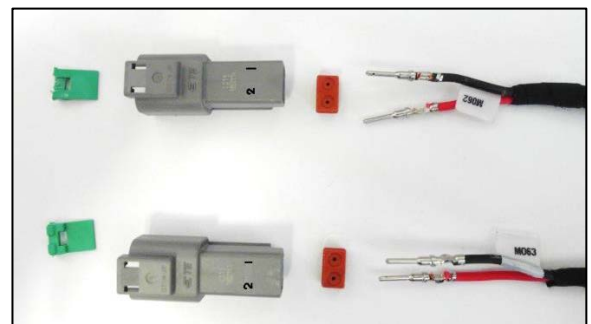

FIGURE 72

134. Install 2 foot long of 0.50" diameter loom on the roof harness starting at connector CSS2 then 8-foot long of 0.35" diameter loom.
135. Attach the sections of looms together with black electrical tape as shown in Figure 73.

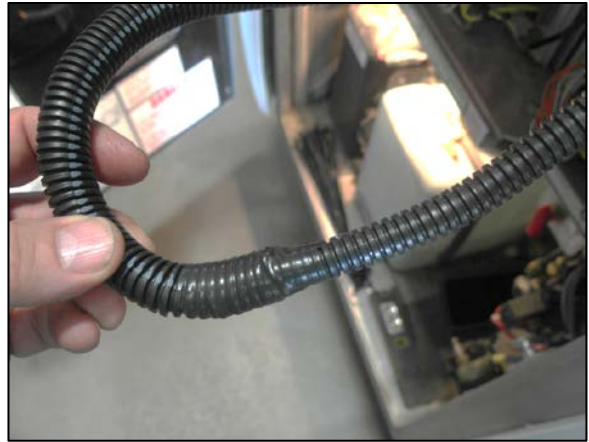

FIGURE 73

136. Into the front service compartment, connect male connector CSS2 with female connector CSS2.



FIGURE 74

137. Run the roof harness through the opening at the bottom of the driver side pillar.
138. Use cable ties to secure all new wires in the front service compartment with existing wiring.

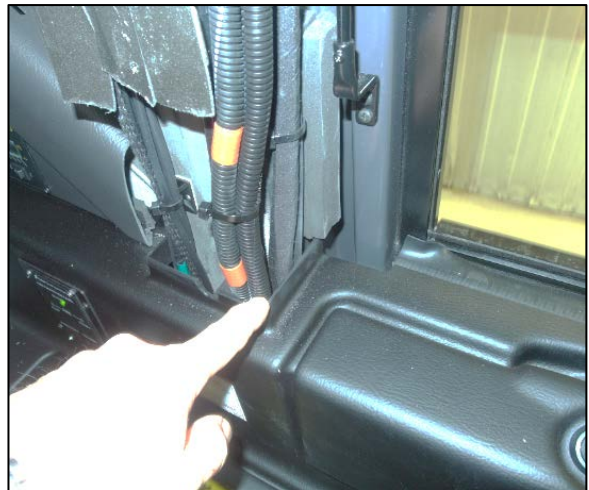

FIGURE 75

139. Run the roof harness through the opening at the top of the driver side pillar.
140. Use cable ties to secure the harness with existing wiring.



FIGURE 76

141. Run the roof harness from the top of the driver side pillar to the light control panel interspace (bottom of the parcel rack).



FIGURE 77

142. Run the whole roof harness through the light control panel interspace (bottom of the parcel rack) up to the rear hatch.



FIGURE 78

- 143. Drill a 9/16" diameter hole through the overhead compartment structure as shown in Figure 79.
- 144. Install a grommet and run the front hatch wiring section of the roof harness through the hole.



FIGURE 79

- 145. Drill a 1/2" diameter hole through the plastic moulding and install a grommet.
- 146. Run the front hatch section of the roof harness through the grommet.



FIGURE 80

- 147. Run the wiring through the top grommet.
- 148. Drill 1/4" diameter holes (2) through the compartment support to install cable ties.
- 149. Install medium cable ties (3) but do not tighten.

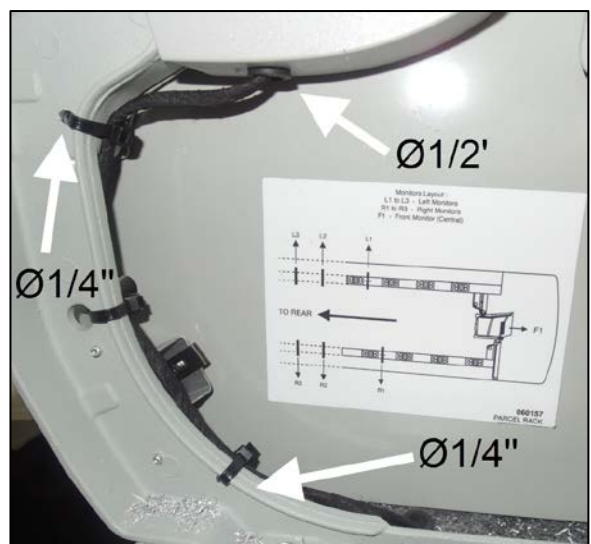

FIGURE 81

150. Drill a 1/2" diameter hole through the roof transition panel around 2" from the joint between panels.
151. Install a grommet.
152. Run the front hatch section of the roof harness through the grommet.
153. Drill two holes with a No. 29 drill bit as shown in Figure 82.
154. Install cable tie holders and cable ties, but do not tighten it.

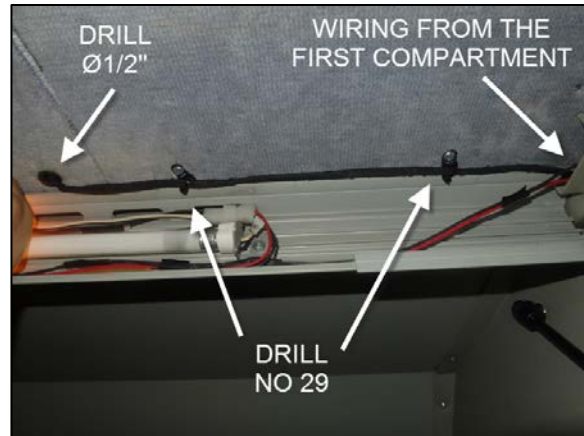

FIGURE 82

155. Make a groove into the roof insulation as shown in Figure 83. The groove has to be 1/4" wide and between 1/4" to 1/2" deep.



FIGURE 83

156. Drill holes in both existing hatch frames on the front side as shown in Figure 84

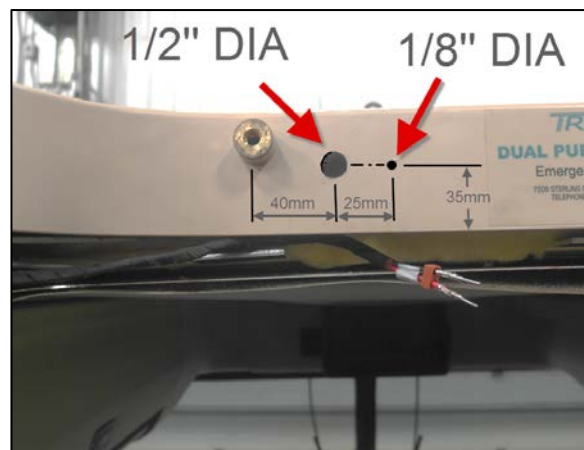

FIGURE 84

157. Install both new hatches with fan. Apply Loctite on screws. Make sure all springs are in place.
158. For both new hatches, run the fan wiring through the ½” diameter hole and fix the wire holder as shown in Figure 85.



FIGURE 85

159. If applicable, cut the excess of fan wiring.
160. On the fan wiring, install seal, socket terminals, male connector and secondary lock on the front fan motor wiring. Connect black wire in pin #1 and white wire in pin #2.



FIGURE 86

161. On the roof harness, install terminals into connector Mo62 on the front section roof harness with the seal and the secondary lock. Black wire goes into pin #1 and red wire goes into pin #2.



FIGURE 87

162. Connect the front fan male connector to the roof harness female connector.



FIGURE 88

163. Keep cutting the roof insulation and install the wiring and connectors into the groove as shown in Figure 89.



FIGURE 89

164. Use duct tape to keep the wiring in place.
165. Pull the excess length of wire down to the light control interspace.
166. Tighten the cable ties on this wiring section.

NOTE
<i>Make sure the new wiring is always protected against wearing or cutting or squeezing between existing parts.</i>

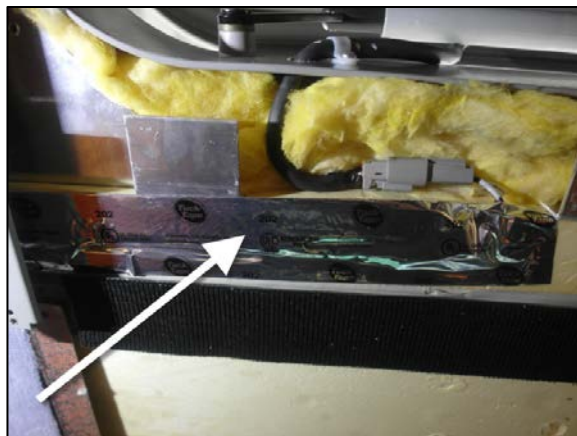

FIGURE 90

167. Into the light control panel interspace, apply sealant #684685 as shown in Figure 91 to secure the grommet and the wiring.



FIGURE 91

168. Repeat the wiring installation for the rear hatch.
169. Drill a 1/2" diameter hole through the top finishing moulding and install a grommet.
170. Drill a 9/16" diameter hole through overhead compartment structure and install a grommet.
171. Run the wiring through the grommets.
172. Drill 1/4" diameter holes (2) through the compartment support to install cable ties.
173. Install medium cable ties (3) but do not tighten.
174. Repeat steps 150 to 167 for the rear hatch installation.

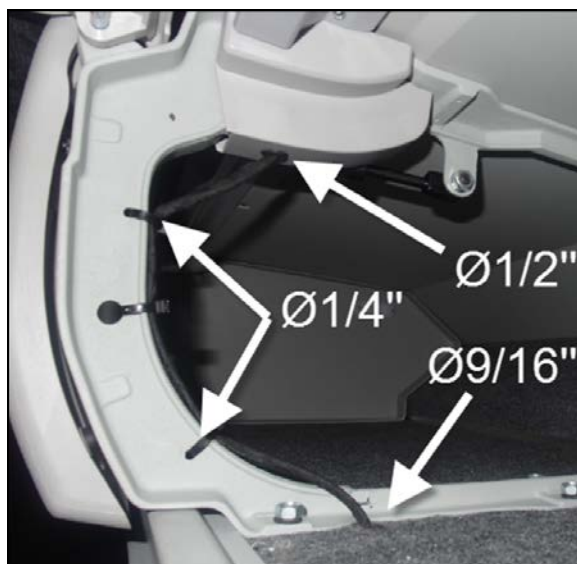

FIGURE 92

175. Locate wire 24RHF and wire OFB2 from the roof harness (long harness) into the front service compartment.

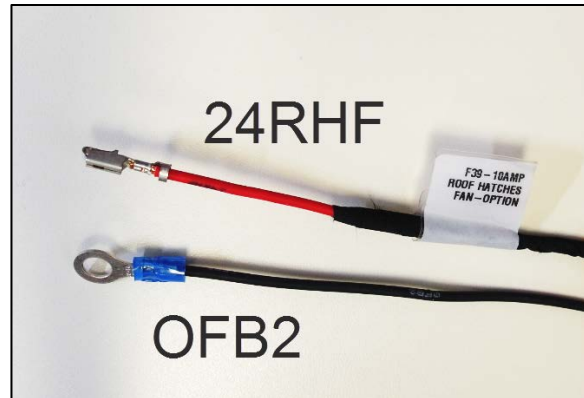

FIGURE 93

176. Into the front service compartment, locate the VECF4 connector (orange).



FIGURE 94

177. Disconnect the VECF4 connector if necessary.

178. Orientate terminal locking tab of the wire 24RHF with the VECF4 connector as shown in Figure 95.

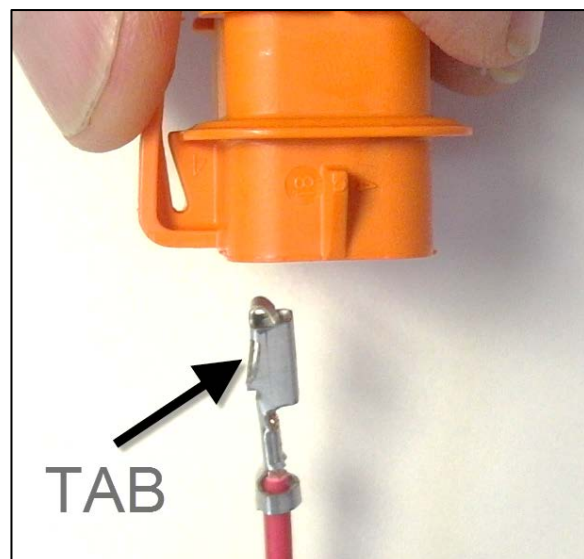

FIGURE 95

179. Connect wire 24RHF into pin C of VECF4 connector and make sure it is locked in place.
180. Reconnect VECF4 connector if applicable.

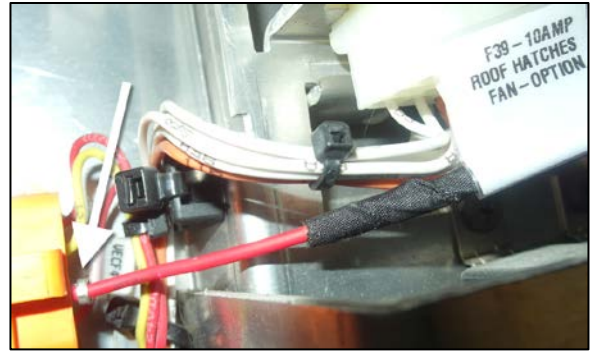

FIGURE 96

181. Into the front service compartment, on the left, locate the "On chassis" welded ground studs.
182. Select a free stud or one with the minimum connections.
183. Clean the contact surface if necessary.

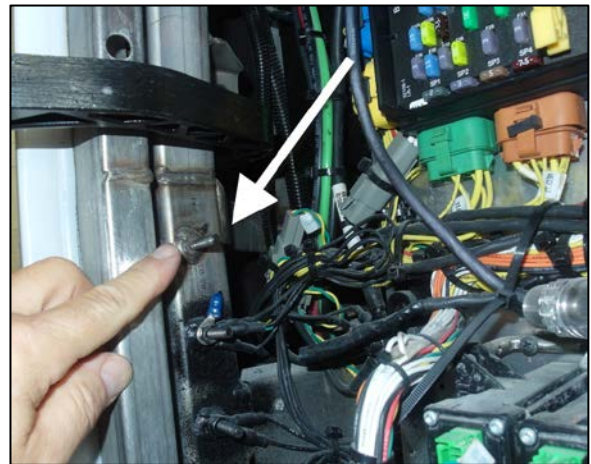

FIGURE 97

184. Connect wire OFB2 to the "On chassis" welded ground stud. Use nut M6x1.
185. Tighten to 106 lb-in (12 Nm)



FIGURE 98

186. Apply terminal protection on the terminal and nut (#684013).
187. Use cable ties to secure all new wires with existing wiring.
188. Turn ignition level to Accessory or On position.
189. Test both fans are running well and pushing air outside the vehicle.

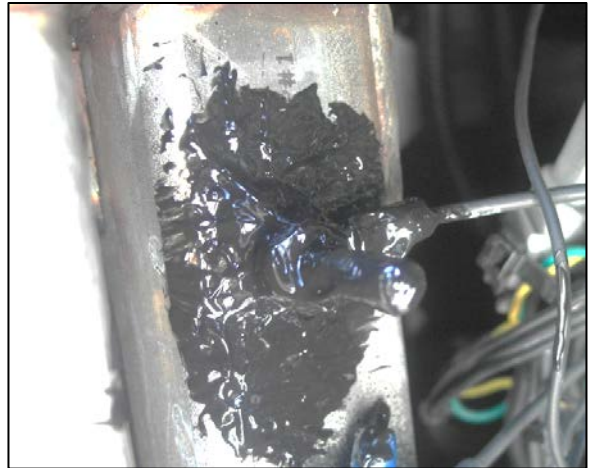

FIGURE 99

190. Reinstall rivets on the roof transition panel finishing moulding.

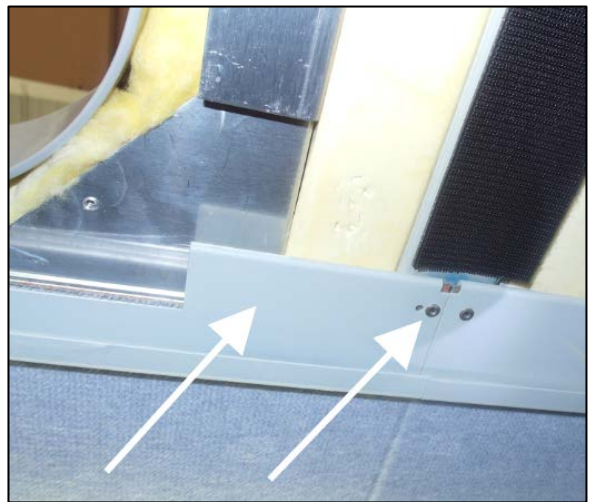

FIGURE 100

191. If necessary, make a V-shape cut out on the finishing moulding as shown in Figure 101.

192. Install the finishing moulding.

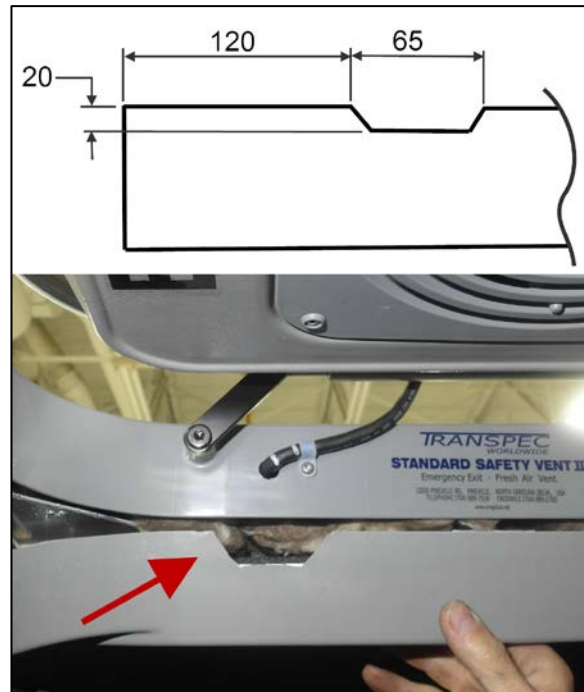

FIGURE 101

193. Reinstall these components:

- All light control panels.
- Driver side parcel rack end cover.
- Finishing plastic moulding on the driver side pillar.
- Dashboard cover.

194. Bulletin is complete.

ESTIMATED TIME

The time required to perform this instruction sheet is approximately 6 hours per vehicle.

PARTS / WASTE DISPOSAL

Discard waste according to applicable environmental regulations (Municipal/State[Prov.]/ Federal)