

Safety Recall

SR12-57A

Date	Expiration	Group	No.	Page
09.2012	none	8	01	1(26)

ADDITION OF AN EMERGENCY EXIT WINDOW 9700 (B13R)

REVISION A: THIS SAFETY RECALL SUPERSEDES PREVIOUS VERSION.

Part # 949845 replaced by 984726.
Part # 21289374 replaced by 22040451.

MODEL YEAR(S) AND VEHICLE SERIAL NUMBERS (VIN) INVOLVED

VIN			
The following Volvo Bus 9700 Model Year 2009 to 2012			
3CET2M62695134115	3CET2M628A5140471	3CET2S222B5145922	3CET2S222B5148853
3CET2M622A5136397	3CET2S229B5142239	3CET2S225B5147664	3CET2S224B5148854
3CET2M624A5136398	3CET2S221B5143806	3CET2S229B5148252	3CET2S226B5148855
3CET2M626A5136399	3CET2S223B5143807	3CET2S220B5148253	3CET2S228B5148856
3CET2M629A5136400	3CET2S222B5145919	3CET2S224B5148434	3CET2S22XB5148857
3CET2M62XA5140469	3CET2S229B5145920	3CET2S226B5148435	3CET2S22XC5152652
3CET2M626A5140470	3CET2S220B5145921	3CET2S226B5148659	

DESCRIPTION

On the vehicles involved in this safety recall, the quantity of emergency exit windows is insufficient to comply with the requirements of FMVSS no. 217: "Bus Emergency Exits and Window Retention and Release".

Please contact your Prevost Service Center to schedule an appointment at your earliest convenience to have an additional emergency exit window installed free of charge. Please mention Safety Recall SR12-57. A complete list of Prevost service points is available on www.prevostcar.com/network.

Prevost Service Centers		
Quebec	850, chemin Olivier Saint-Nicolas, Quebec G7A 2N1	Toll free phone: 1-866-870-2046 Tel.: 1-418-831-2046
British Columbia	6537 River Road Delta, BC V4K 5B9	Tel.: 1-604-940-3306
New Jersey	201 South Avenue South Plainfield, New Jersey 07080	Toll free phone: 1-800-223-0830 Tel.: 1-908-222-7211
Florida	6931 Business Park Blvd. North Jacksonville, Florida 32256	Toll free phone: 1-800-874-7740 Tel.: 1-904-886-4555
Tennessee	800 South Cartwright Street Goodlettsville, Tennessee 37072	Toll free phone: 1-877-299-8881 Tel.: 1-615-299-8881
Texas	15200 Frye Road Fort Worth, Texas 76155-2702	Toll free phone: 1-866-773-8678 Tel.: 1-817-685-0250

Safety Recall

SR12-57A

Date Expiration Group No. Page
09.2012 none 8 01 2(26)

California

3384 De Forest Circle
Mira Loma, California 91752

Toll free phone: 1-800-421-9958
Tel.: 1-951-360-2550

PROCEDURE



DANGER

Park vehicle safely, apply parking brake, stop engine. In the battery box, set the battery cut-off switch to the OFF position prior to working on the vehicle.

Small fixed Window
to be removed and
installed.

Fixed Window to be
replaced for an
emergency window.

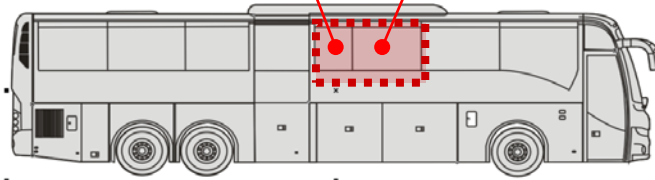

Order kit 199281 which includes:

Part Number	Description	Qty	Comments
21970752	Emergency Window LT 31%	1 pce	Grey Tinted
22040451	Rubber Moulding	16' 5"	
21655877	Decal, Emergency Window	2 pce	
21320062	Lock Pin	2 pce	
984726	Flange Screw	4 pce	
20707763	Insulating Bushing	59"	
21000221	Rubber Spacer 10mm x 12mm	12"	
20844257	Adhesive Tape, Double Side, 25 mm	59"	
70364951	Adhesive Layer, Black	3450 cm ²	
21736880	SENSOR, MAGNETIC CONTACT M04	1	
21721793	SENSOR, MAGNETIC MK04-1B90C-500W	1	

Other parts required

Part Number	Description	Qty	Comments
21675360	Internal Cover Moulding	1 pce	Order if damaged
21333610	Window Pane LT 31%	1 pce	Grey Tinted, Order if



Safety Recall

SR12-57A

Date Expiration Group No. Page
 09.2012 none 8 01 3(26)

			damaged.
8714348	Sika 265 Sealing Compound Black, 600ml	5	Only avail. in sausage
683661	Sika Aktivator	250 ml	
680459	Loctite 404 Cyanoacrylate adhesive.	15 ml	Or other equivalent
-----	Sodium bicarbonate (Baking Soda)	1 ml	Use with cyanoacrylate.

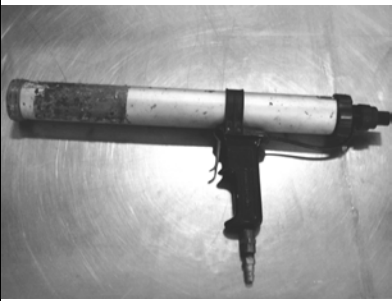
Special Tools

Part Number	image	Description	Qty
683260		Pneumatic gun for 600ml sausage	1 pce
683124		Mixer Adaptor	1
683655		Triangle bead adaptor	1



DANGER

Before working on a vehicle, set the parking brakes, place the transmission in neutral, and block the wheels. Failure to do so can result in unexpected vehicle movement and can cause serious personal injury or death



DANGER

Use ladders, platforms or lift equipment of adequate rating to access top area of bus body. Failure to follow this recommendation may result in a fall, serious personal injury or death.

1. BEFORE REMOVING THE GLASS

- Protect the passenger seats.
- Protect the side of the bus body,

DURING REMOVAL OF THE GLASS USE SAFETY GOGGLES AND SAFETY GLOVES

2.

Remove the moldings around the windows inside the bus



3.

Protect the windows all around with masking tape and remove the adhesive as much as possible in the bottom edge of the aluminum molding.

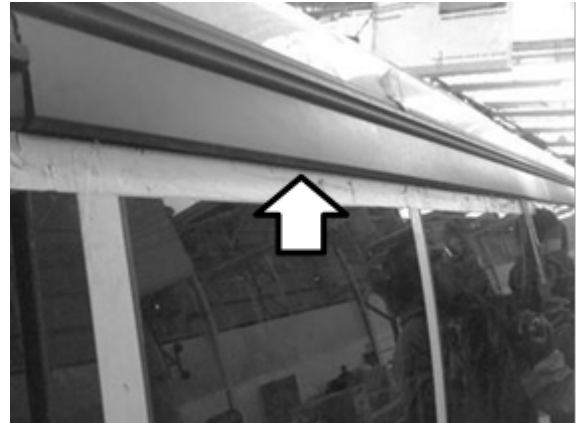

Date	Expiration	Group	No.	Page
09.2012	none	8	01	5(26)

4.

To unglue the aluminum molding, use prybars and a cutter to push out the molding and cut the adhesive carefully.

Note: Do this task very carefully to avoid damage the molding and the small window, in order to install them again.



5. Push the molding upwards and remove the remaining old adhesive at the corners.



GLASS REMOVAL

If you wish to keep the glass, follow steps 6 to 10.

6.

Cut and remove the adhesive around the window frame outside the bus.



7.

Insert an awl into the split.



8.

Thread a steel wire through the eye of the awl and pull the wire over to the other side.

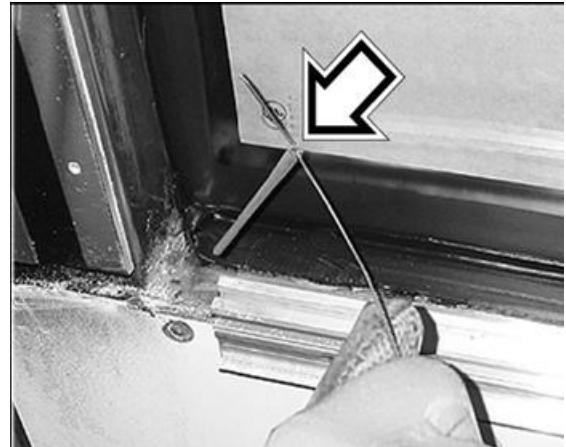

9.

Attach the handles to the wire.

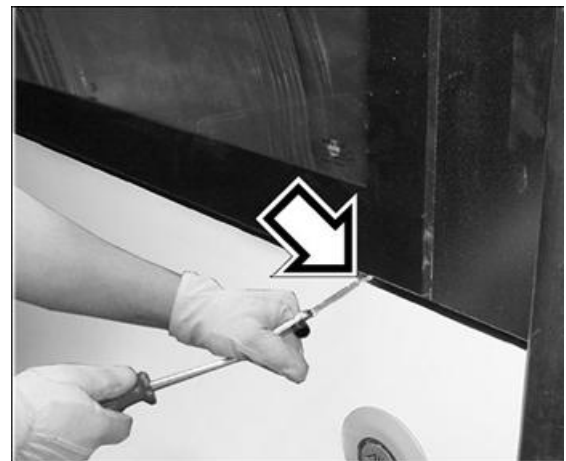

Date	Expiration	Group	No.	Page
09.2012	none	8	01	7(26)

10.

Cut out the glass. When finishing carefully remove the wire out the glass.

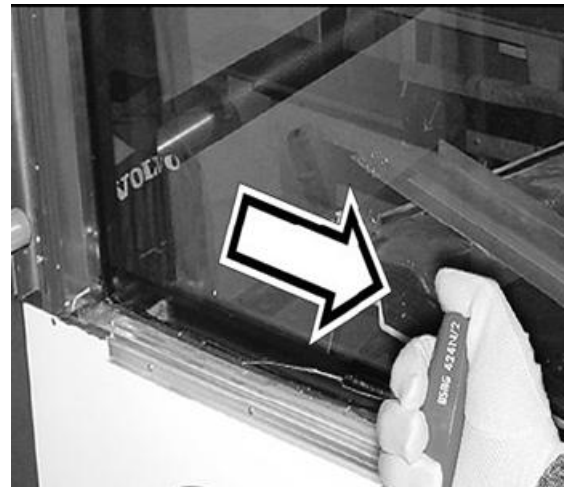

11.

Clean and remove the remaining old glue from the frame.



12.

Remove the 4th window pane **21674660** next to the window to be replaced. Repeat steps from 1 to 8. Removing this window will allow a better gap distribution between windows.

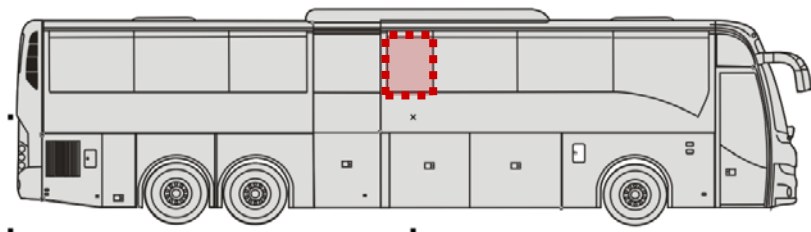

Date	Expiration	Group	No.	Page
09.2012	none	8	01	8(26)

Installing the rubber molding

13.

On the bus frame, scour around the frame surface with a heavy duty scour pad to promote adhesion. To apply Sika Aktivator **683661**; substrate must be clean, dry, free of oil and grease; thoroughly remove all loose particles and residues.

Sika Aktivator application:

Wipe bond face with a clean, lint-free cloth moistened with Sika Aktivator. Apply sparingly, wiping once only. Wipe off with a clean dry cloth or paper towel.

Allow to dry 10 minutes but not more than two hours before applying adhesive. If adhesive cannot be applied within two hours of priming, repeat application.



14.

Stick double sided tape **20844257** in the upper edge frame (only).



15.

Remove the protective layer and stick the rubber molding **21289374** all around the inner edge of the frame for emergency window.



Date	Expiration	Group	No.	Page
09.2012	none	8	01	9(26)

Start at the middle of the bottom edge of the window's frame, radius at the corners as small and smooth as possible, check the good adhesion of the rubber molding. Cut the molding to join with the star end of the molding, glue the butt joint with cyanoacrylate adhesive.

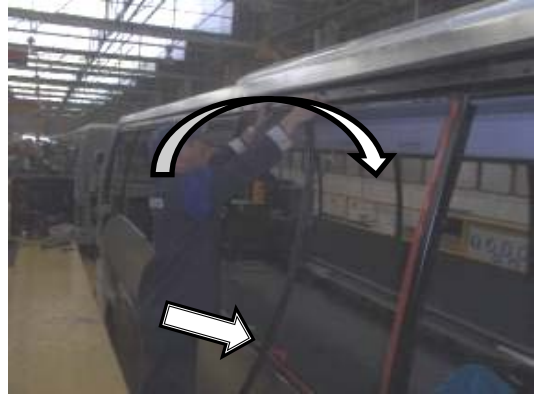

16.

Apply adhesive **8714348** all around under the rubber molding as shown in the image.

Note: Before installing the emergency window you must wait at least 12 hours for the adhesive to dry **8714348**.

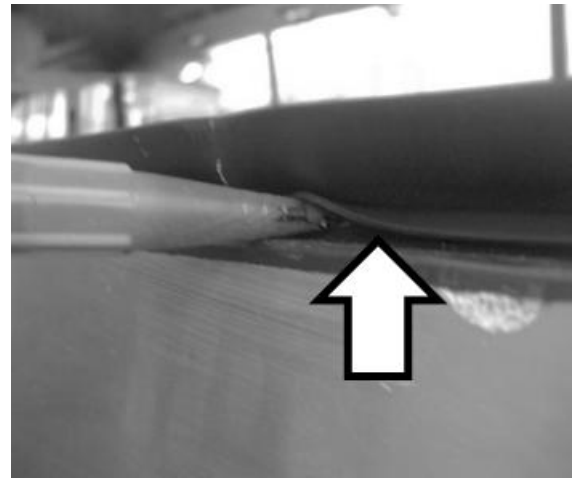

Install the new emergency window.

17.

Install the Insulating bushing **20707763** on the upper round edge of the aluminum molding of the emergency window, as is shown in the image.



Safety Recall

SR12-57A

Date	Expiration	Group	No.	Page
09.2012	none	8	01	10(26)

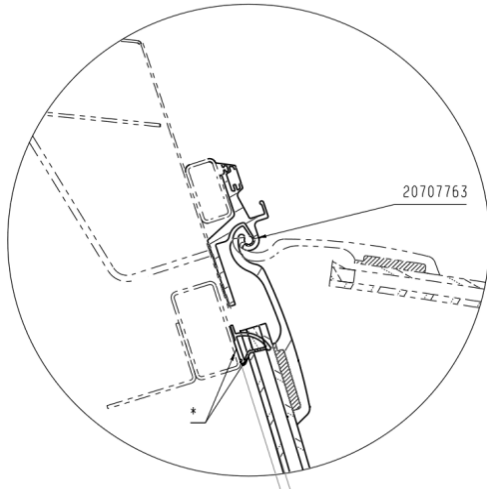

Date	Expiration	Group	No.	Page
09.2012	none	8	01	11(26)

18.

Insert the new emergency window assembly into the upper aluminum molding of the bus.

Note:

For this step 2 people are needed.

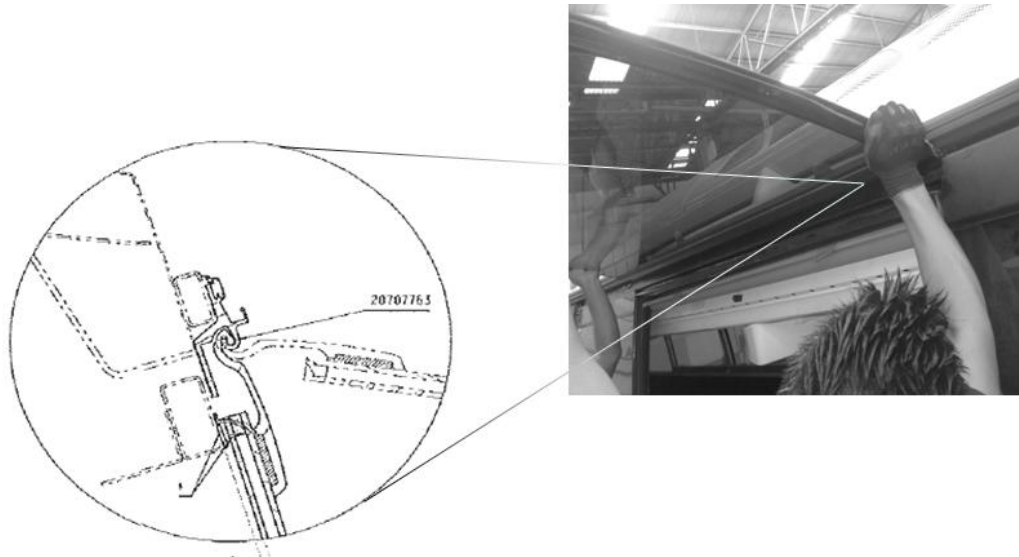

19.

Adjust the clearance between windows $1/4'' \pm 1/32''$
(6mm \pm 1mm).

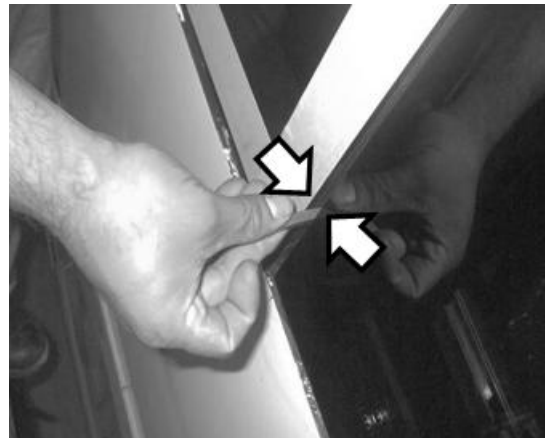

Install Lock Pins

20.

Close and align the emergency window surface with the emergency window already installed (and perfectly closed).

21.

Once the window is closed and aligned, open completely the emergency window mechanism and find the lock pin **21320062** final position in one side, mark the position of the holes for the both screws to fit the lock pin; do the same for opposite side.

Date	Expiration	Group	No.	Page
09.2012	none	8	01	12(26)

22.

Open emergency window, hold open the emergency window and drill four **5mm** holes.

Note: Use a center punch to avoid drill walk and result in an inaccurate hole position.



WARNING

When drilling always wear proper eye protection. Failure to wear proper eye protection can result in serious personal injury.



23.

Install the lock pin using 2 flange screws, M6*20 949845. Tighten screws to 88 ± 13 lb-in

Note: Do not re-use screws. If damaged use new screws.

Note: Avoid damaging the pin to reduce the risk of a jammed mechanism.

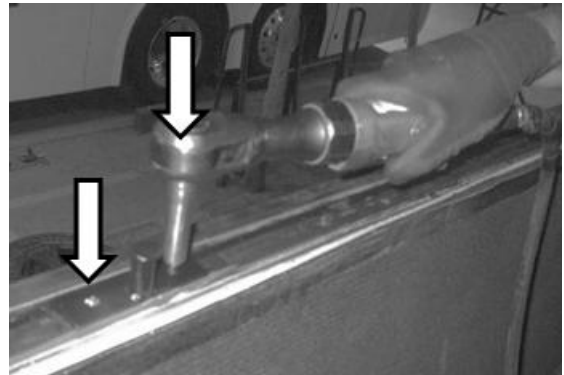

Install Small Window pane

24.

Before installing the next window Remove all traces of old glue and clean perfectly, remove the black adhesive layer.

Install a new strip of black adhesive layer **70364951**, place at the same position than old one. See images



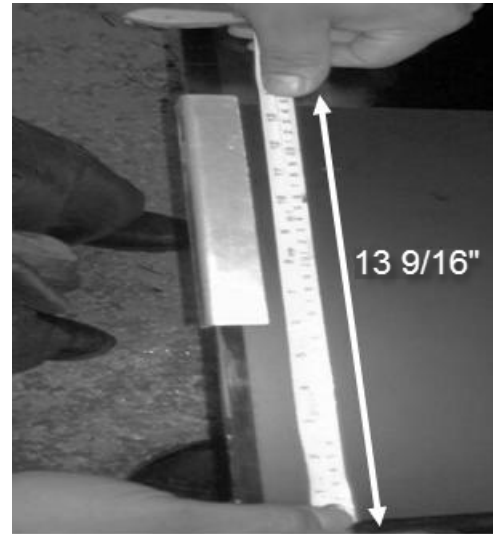

25.

All around the window pane cut the Adhesive Layer 1". We recommended using an L profile as shown in the images.

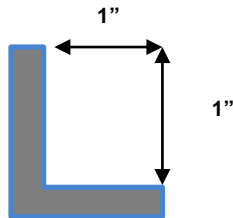

26.

Apply Sika Aktivator all around the window pane, were the adhesive layer was removed.

Sika Aktivator application:

Wipe bond face with a clean, lint-free cloth moistened with Sika Aktivator. Apply sparingly, wiping once only. Wipe off with a clean dry cloth or paper towel.

Allow to dry 10 minutes but not more than two hours before applying adhesive. If adhesive cannot be applied within two hours of priming, repeat application.

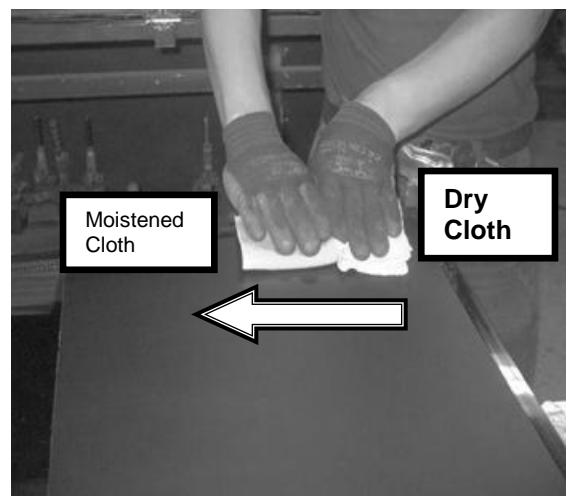

Date	Expiration	Group	No.	Page
09.2012	none	8	01	14(26)

27.

Apply Sika Aktivator to the entire surface of window frame following the instructions in the previous step.



28.

Before placing the window pane, install two rubber 10mm spacers along the window lower frame to support the window pane. Set the rubber spacer to 7 7/8" from each lower corner of the window frame.

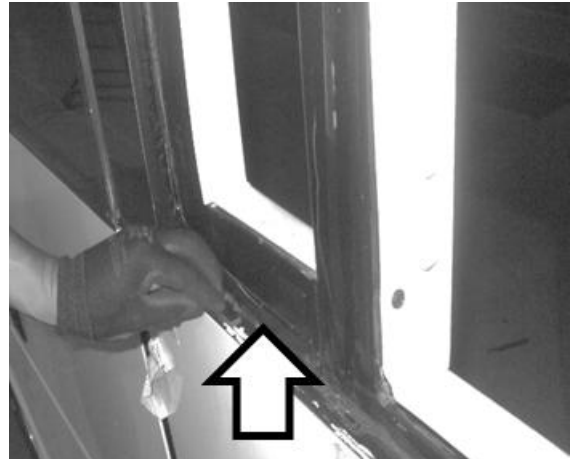

29.

Apply Black Sealant (**8714348**) all around the window frame. Bead profile will be applied 5 mm from the profile outer edge.

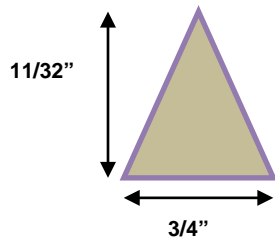

Cross section of adhesive

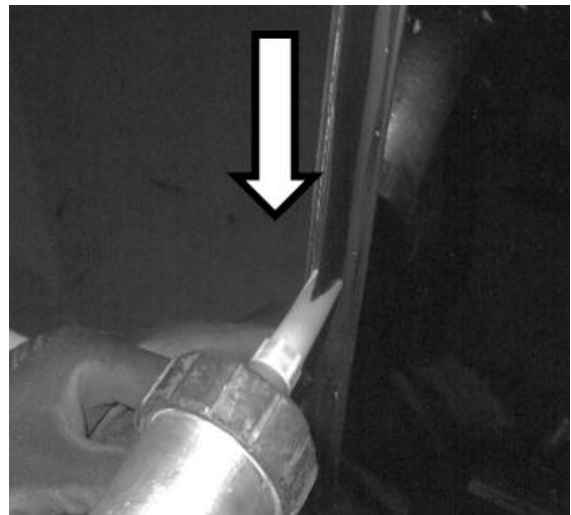

30.

Install the window pane in position

Note: Check that the window pane is in the same level and aligned with the rest of window panes.

Note: Be sure to set first the lower side of window pane.



31.

Put some pieces of wood to hold the side window pane (and adjust it) in its position. Use self-drilling screws, 45 mm length.

Note: Before filling the joint gap let the sealer dry at least ****24**** hours.

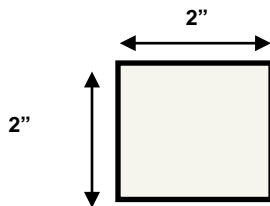

Sealing

32.

After 24 hours, remove pieces of wood and seal the joint gap. To seal the emergency window side open the emergency window and put black sealant **8714348** along the interior window edge.



Date	Expiration	Group	No.	Page
09.2012	none	8	01	16(26)

33.

Remove adhesive **8714348** excess using a rubber scraper and apply soapy water to obtain a good smooth finishing.



Install aluminum molding

34.

Install the upper window molding. Use the molding removed at the beginning and cut it according to the window width. To cut use a cut off tool.

Note: Use the molding previously removed and cut to fit window pane size.



35.

Remove dirt and dust from window surface by cleaning with Sika Cleaner. Allow 10 minutes to dry, no more than 2 hours, apply Sika Aktivator. If Aktivator cannot be applied within 2 hours repeat application.

Sika Aktivator application:

Wipe bond face with a clean, lint-free cloth moistened with Sika Aktivator. Apply sparingly, wiping once only. Wipe off with a clean dry cloth or paper towel.

Allow 10 minutes to dry but not more than 30 minutes before applying adhesive. If adhesive cannot be applied within 30 minutes of priming, repeat application.



Date	Expiration	Group	No.	Page
09.2012	none	8	01	17(26)



36.

Apply adhesive (**8714348**) as shown.

4" wide.

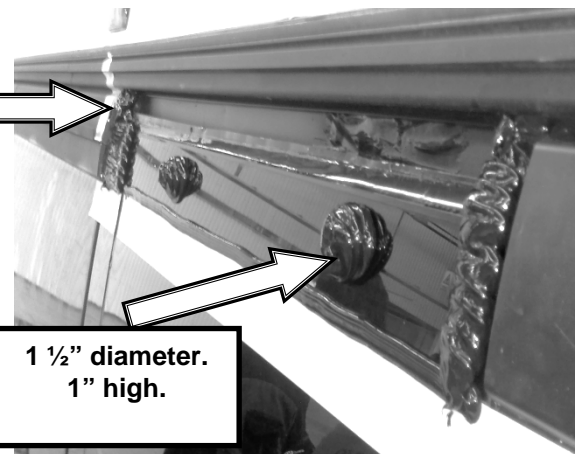

Note:

Before installing the molding, protect the window and molding all around with masking tape (3").

37.

Install the molding.



Date	Expiration	Group	No.	Page
09.2012	none	8	01	18(26)

38.

Remove the remaining adhesive **8714348** and apply soapy water to obtain a good smooth finish.

Note: Ensure the moulding gaps are cleaned of any remaining adhesive.



39.

Once the window pane has been installed go to the bus interior, mark window perimeter and cut the Adhesive Layer Black strap, use a ruler.



Date	Expiration	Group	No.	Page
09.2012	none	8	01	19(26)

40.

Seal the side window pane (interior side), then apply soapy water to obtain a good smooth finish. Remove the adhesive tape.



41.

Internal cover (21675360) must be drilled in order to insert the pin **21320062**. The distances in both must be considered as a guide for drilling. The final position of the mounted pins is mandatory. Diameters shown in the images are mandatory. **Measurement units mm.** Once the cover has been drilled install the cover.

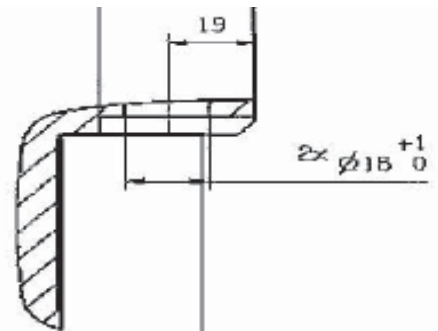

$$19\text{mm} = 3/4''$$

$$\text{Ø}16\text{mm } {}_0^{+1} = \text{Ø}0.625 {}_0^{+0.040''}$$

Date	Expiration	Group	No.	Page
09.2012	none	8	01	20(26)

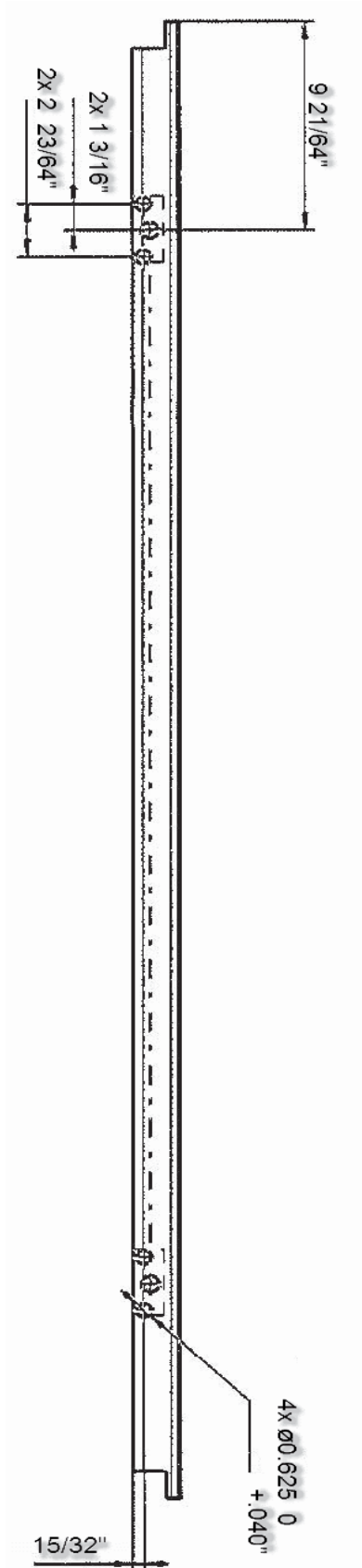

Date	Expiration	Group	No.	Page
09.2012	none	8	01	21(26)

42.

Install all moldings removed inside the bus.



43.

Place a decal **21655877** 13 3/8" from each end of the pull bar.



44.

Check the emergency window for proper operation. Lift the window release bar push the window open from the bottom. To close, lift the release bar and pull the window into position. Push down on release bar to lock the window shut.



Date Expiration Group No. Page
09.2012 none 8 01 22(26)

SENSOR INSTALLATION PROCEDURE

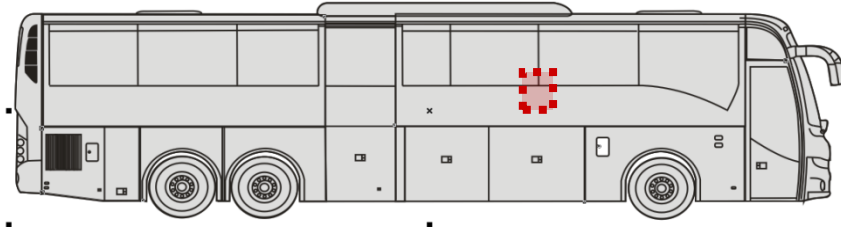

Part Number	Description	Qty	Comments
21736880	SENSOR, MAGNETIC CONTACT M04	1	
21721793	SENSOR, MAGNETIC MK04-1B90C-500W	1	
8714348	SEALING COMPOUND, SIKAFLEX-265-BLACK	20 ml	



DANGER

Before working on a vehicle, set the parking brakes, place the transmission in neutral, and chock the wheels. Failure to do so can result in unexpected vehicle movement and can cause serious personal injury or death



DANGER

Use ladders, platforms or lift equipment of adequate rating to access top area of bus body. Failure to follow this recommendation may result in a fall, serious personal injury or death.

Remove:

1.

Remove the interior right side moulding in column D.

Note:

Be sure not to damage the moulding.



Safety Recall

SR12-57A

Date	Expiration	Group	No.	Page
09.2012	none	8	01	23(26)

2.

Cut the molding in the bottom as shown in the image.

Cut is 1/4" wide, 7/8" long and 7/16" deep.

Note!

This cut should mirror the existing cut on the opposite side on the moulding.

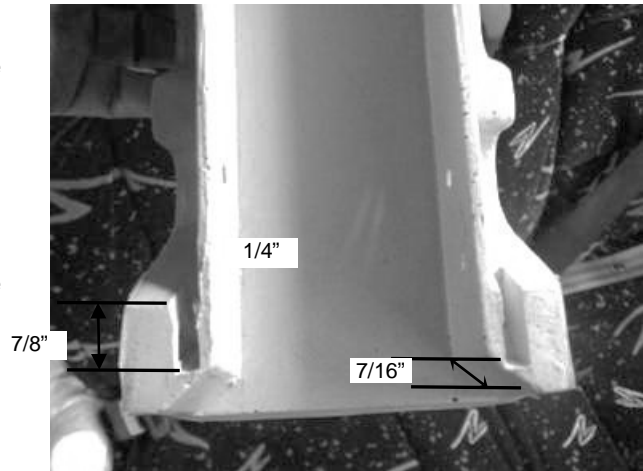

Install:

3.

Drill the moulding. Use 1/8" (3mm) drill bit.

Note:

Be sure to use low speed to drill the moulding.

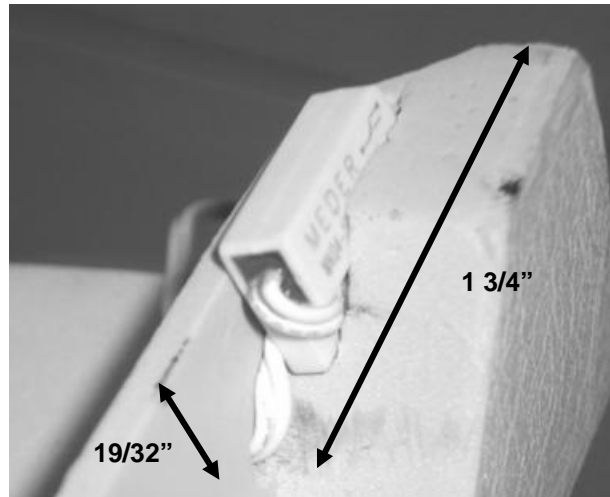

WARNING

When drilling always wear proper eye protection. Failure to wear proper eye protection can result in serious personal injury.



Date	Expiration	Group	No.	Page
09.2012	none	8	01	24(26)

4.

Set the sensor **21721793** in the notch. Remove additional material if needed. Pass the cable through the holes as shown in image.



5.

Set the sensor **21721793** in position according the image and secure with glue.

Note:

Use a mix of Loctite 404 or other cyanoacrylate adhesive and sodium bicarbonate (baking soda) as a gap filler compound.

First apply a layer of cyanoacrylate adhesive, sprinkle with sodium bicarbonate, and then apply a new layer of cyanoacrylate adhesive.



6.

Remove the insulation tape of the first emergency window wiring harness.



Date	Expiration	Group	No.	Page
09.2012	none	8	01	25(26)

7.

See Function Group 371 in IMPACT for more information about guidelines for cable repair.

Join the sensor cables and the wiring harness

Note: Switch is not polarized

8.

Tape the harness connection to avoid contact with the window frame.



9.

Set the moulding in the original position and hide the sensor harness between the window frame and the moulding. Secure the moulding with screws.



Safety Recall

SR12-57A

Date	Expiration	Group	No.	Page
09.2012	none	8	01	26(26)

10.

Apply black adhesive to the sensor **21736880** and position it in the window corner just in front of the new sensor **21721793** installed before.

Note:

Average distance between both sensors is
5/64" +/- 1/16"

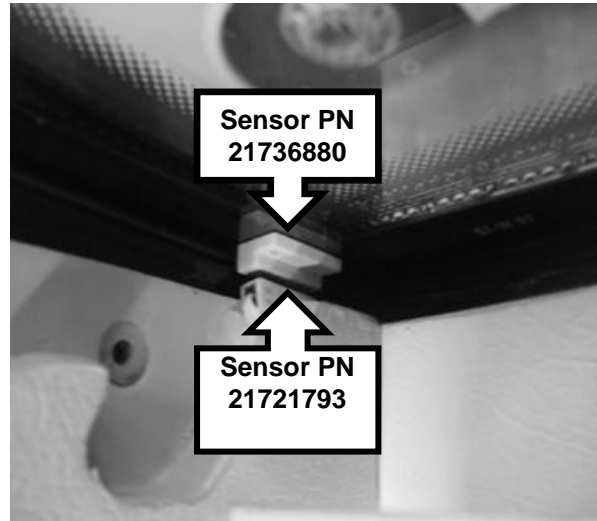

This modification is covered by Prevest's normal warranty. The working time required to perform this recall is approximately fourteen (14) hours. As a matter of normal service process, your Prevest Service Center will also check for other repair measures which might be applicable to your vehicle and this may increase the required working time.

Please contact your Prevest Service Center for additional information and to schedule an appointment at your earliest convenience. Please mention Safety Recall SR12-57.

OTHER

VBC Bulletin	C8870
Fail Code	18.07
Defect Code	09
System Condition	R
Causal Part	21970752