

PREVOST

ENREGISTRÉ - REGISTERED
ISO 9001 & ISO 14001

**WARRANTY
BULLETIN**

Wb08-02A







DATE : APRIL 2008	SECTION : 06 - ELECTRICAL
EXPIRATION: APRIL 2010	
SUBJECT : POWER WINDOW HARNESS – REMOVAL OF ZENER SUPPRESSOR DIODES	

REVISION : A

Model year 2008 added to XLII MTH + exception vehicles added to X3

APPLICATION

Model	VIN																				
 H3-41, H3-45 coaches Model Year : 2005 - 2007	 <p>The following vehicles</p> <table border="0"> <tr> <td>2PCH334904101 4933</td> <td>2PCH3349X5101 0020</td> </tr> <tr> <td>2PCH334994101 4963</td> <td>2PCH334945101 0109</td> </tr> <tr> <td>2PCH334904101 4995</td> <td>2PCH334925101 0142</td> </tr> </table> <p>and</p> <p>from 2PCH334995101 0168 up to 2PCH3349X7171 0865 incl.</p> <p>except</p> <table border="0"> <tr> <td>2PCH334947171 0795</td> <td>2PCH334927171 0858</td> </tr> <tr> <td>2PCH334947171 0845</td> <td>2PCH334967171 0863</td> </tr> </table>	2PCH33490 4101 4933	2PCH3349X 5101 0020	2PCH33499 4101 4963	2PCH33494 5101 0109	2PCH33490 4101 4995	2PCH33492 5101 0142	2PCH33494 7171 0795	2PCH33492 7171 0858	2PCH33494 7171 0845	2PCH33496 7171 0863										
2PCH33490 4101 4933	2PCH3349X 5101 0020																				
2PCH33499 4101 4963	2PCH33494 5101 0109																				
2PCH33490 4101 4995	2PCH33492 5101 0142																				
2PCH33494 7171 0795	2PCH33492 7171 0858																				
2PCH33494 7171 0845	2PCH33496 7171 0863																				
 VIP Motorhomes Model Year : 2006 – 2007	<p>The following vehicles</p> <table border="0"> <tr> <td>2PCV334986101 0358</td> <td>2PCV334906101 0368</td> </tr> </table> <p>and</p> <p>from 2PCV334926101 0436 up to 2PCV334937171 0886 incl.</p> <p>except</p> <table border="0"> <tr> <td>2PCV3349561710760</td> <td>2PCV3349471710850</td> </tr> <tr> <td>2PCV3349171710790</td> <td>2PCV3349171710854</td> </tr> <tr> <td>2PCV3349071710828</td> <td>2PCV3349771710860</td> </tr> <tr> <td>2PCV3349671710834</td> <td>2PCV3349471710864</td> </tr> <tr> <td>2PCV3349X71710836</td> <td>2PCV3349171710868</td> </tr> <tr> <td>2PCV3349171710840</td> <td>2PCV3349771710874</td> </tr> <tr> <td>2PCV3349571710842</td> <td>2PCV3349071710876</td> </tr> <tr> <td>2PCV3349271710846</td> <td>2PCV3349671710882</td> </tr> <tr> <td>2PCV3349671710848</td> <td></td> </tr> </table>	2PCV33498 6101 0358	2PCV33490 6101 0368	2PCV3349561710760	2PCV3349471710850	2PCV3349171710790	2PCV3349171710854	2PCV3349071710828	2PCV3349771710860	2PCV3349671710834	2PCV3349471710864	2PCV3349X71710836	2PCV3349171710868	2PCV3349171710840	2PCV3349771710874	2PCV3349571710842	2PCV3349071710876	2PCV3349271710846	2PCV3349671710882	2PCV3349671710848	
2PCV33498 6101 0358	2PCV33490 6101 0368																				
2PCV3349561710760	2PCV3349471710850																				
2PCV3349171710790	2PCV3349171710854																				
2PCV3349071710828	2PCV3349771710860																				
2PCV3349671710834	2PCV3349471710864																				
2PCV3349X71710836	2PCV3349171710868																				
2PCV3349171710840	2PCV3349771710874																				
2PCV3349571710842	2PCV3349071710876																				
2PCV3349271710846	2PCV3349671710882																				
2PCV3349671710848																					

 <p>X3-45 coaches Model Year : 2007 - 2008</p>	<p>The following vehicles</p> <p>2PCG3349471028754 2PCG3349471028883 2PCG3349471028821 2PCG3349871028904 2PCG3349971028863</p> <p>and</p> <p>from 2PCG3349471028933 up to 2PCG3349481729151 incl.</p> <p>except</p> <p>2PCG3349371028938 2PCG3349371028941 2PCG3349971028944 2PCG3349471028947 2PCG3349471028950 2PCG3349471029001 2PCG3349X71029004 2PCG3349571029007 2PCG3349971029009 2PCG3349771029011 2PCG3349071029013 2PCG3349271029014 2PCG3349671029016 2PCG3349X71029018 2PCG3349171029019 2PCG3349371029023 2PCG3349771029025 2PCG3349971029026 2PCG3349271029028 2PCG3349471029029 2PCG3349271029031 2PCG3349271729034 2PCG3349471729035 2PCG3349871729037 2PCG3349X71729038 2PCG3349871729040 2PCG3349X71729041 2PCG3349371729043 2PCG3349771729045 2PCG3349971729046 2PCG3349271729048 2PCG3349071729050 2PCG3349271729051 2PCG3349981729162 2PCG3349881729167</p>
 <p>XLII-40, XLII-45 Motorhomes & Entertainer XLII-45 Model Year : 2007-2008</p>	<p>The following vehicles</p> <p>2PCY3349X71029010 2PCW3349071029024</p> <p>and</p> <p>from 2PCY3349771729096 up to 2PCW3349771729168 incl.</p>
<p>This bulletin does not necessarily apply to all the above-mentioned vehicles, some vehicles may have been modified before delivery. The owners of the vehicles affected by this bulletin will be advised by a letter indicating the Vehicle Identification Number (VIN) of each vehicle concerned.</p>	

DESCRIPTION

On the above mentioned vehicles, it is necessary to remove two suppressor diodes on the driver's power window harness and on the entrance door power window harness when applicable.

The suppressor diode purpose on this harness is to provide an electrical noise filter protection on the Multiplex system. Since the introduction of the multiplexing, everyday use has proved that they are not required but they must nevertheless be removed from the harness because a faulty diode will cause the burning of the fuse protecting the circuit. Once replaced, the new fuse will also burn at the first activation of the power window, and so on.

PROCEDURE



DANGER

Park vehicle safely, apply parking brake, stop engine and set battery master switch(es) to the OFF position prior to working on the vehicle.

H3 & VIP SERIES VEHICLES

1. Open the front electrical and service compartment.
2. Remove the plastic panel protecting the electrical components.
3. Locate the power window electrical harness. You will find it over the electrical compartment, within the area shown on the image at right.

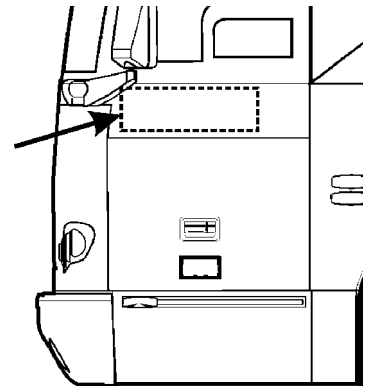
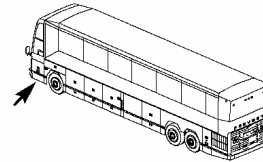

4. Starting from the motor connector, find the diodes along the harness.

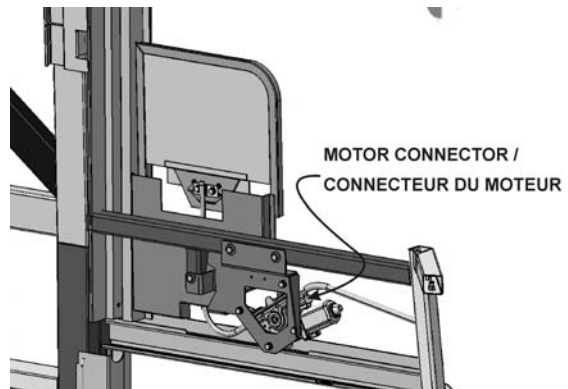

- Diodes D42 & D43 are placed inside clear protective tubing. Cut circuit 26C before and after the clear tubing.

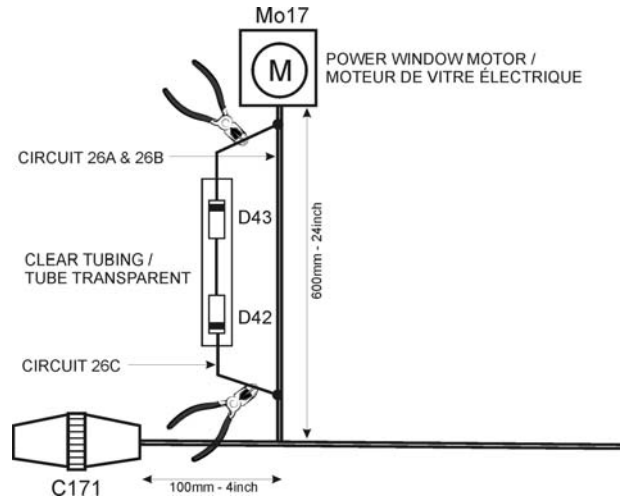

- Place heat shrink tubing on the remaining circuit.
- Restore electrical power on the vehicle and test the functioning of the power window.

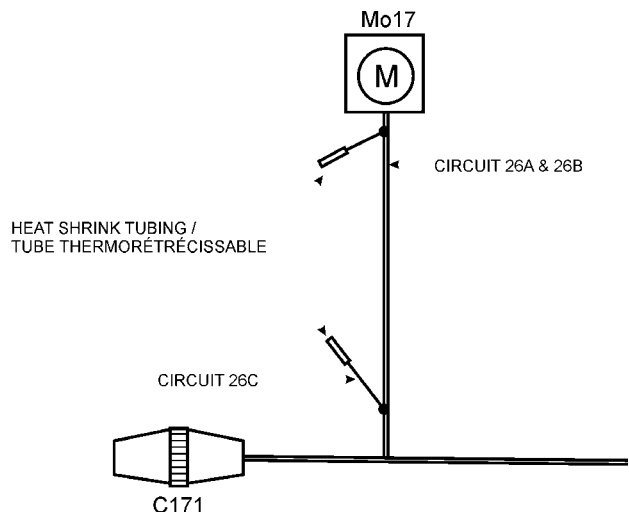

X3 & XLII SERIES VEHICLES

1. Open the front electrical and service compartment door.
2. Remove the windshield washer reservoir.
3. In order to get to the power window motor, remove the door interior panel. Cut through the insulating layer to gain access to the power window motor electrical harness.

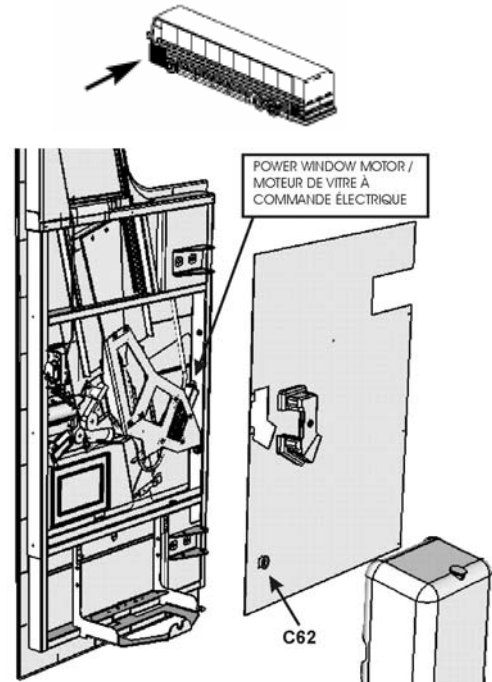

4. Starting from the motor connector, find the diodes along the harness. Diodes are located at about 16" from the connector.
5. Diodes D42 & D43 are placed inside clear protective tubing. Cut circuit 26C before and after the clear tubing.

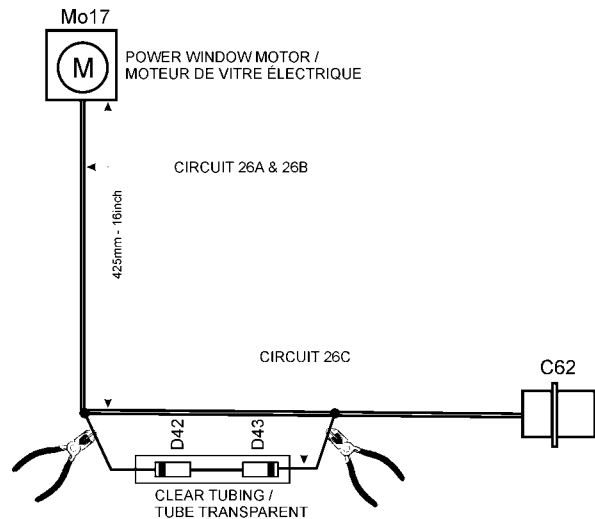

6. Place heat shrink tubing on the remaining circuit.
7. Restore electrical power on the vehicle and test the functioning of the power window.

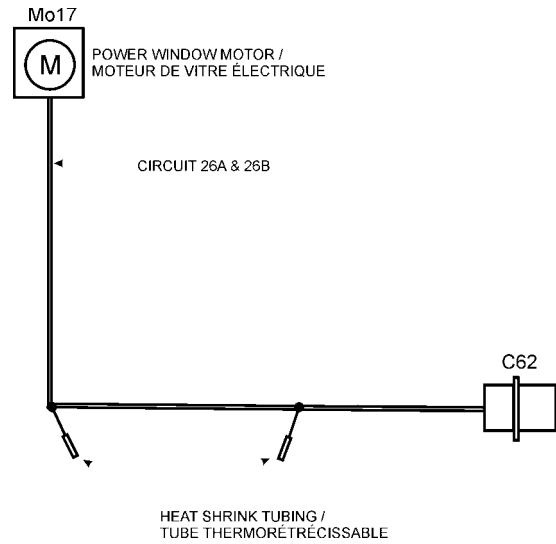

8. On XLII series vehicles, the entrance door power window harness must also be corrected.
9. In order to get to the power window motor, remove the door interior finishing and the access panel. Cut through the insulating layer to gain access to the power window motor electrical harness. The harness will be found along the oblique square tube shown on the image at right.

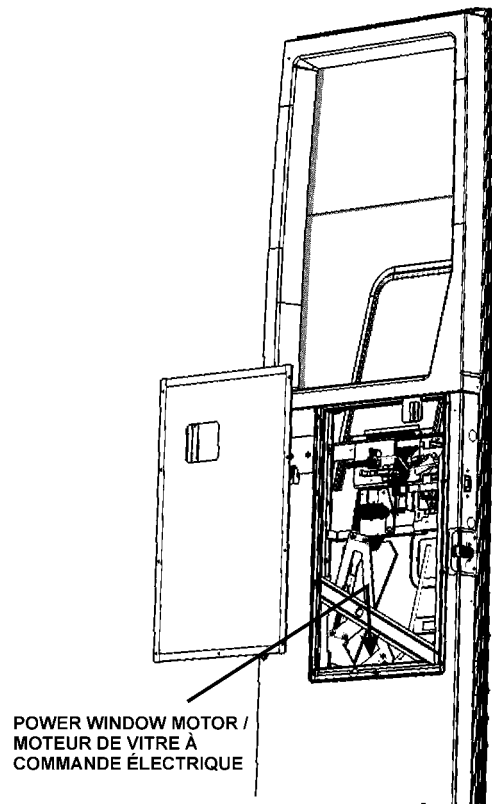

10. Starting from the motor connector, find the diodes along the harness. Diodes are located at about 7" (175mm) from the connector.
11. Diodes D32 & D33 are placed inside clear protective tubing. Cut circuit 26C before and after the clear tubing.

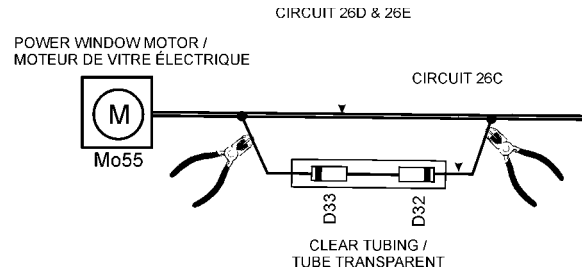

12. Place heat shrink tubing on the remaining circuit.
13. Restore electrical power on the vehicle and test the functioning of the power window.

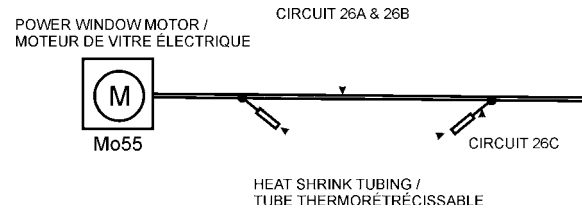

WARRANTY

This modification is covered by Prevo's normal warranty. We will reimburse you the labor upon receipt of the removed parts and a completed A.F.A. form on which you must specify as per "Warranty Bulletin 08-02A".

Reimbursed labor:

H3 series: ½ hour (0.5)

VIP series: ½ hour (0.5)

X3 series: ½ hour (0.5)

XLII series: 1 ¼ hour (1.25)

Parts / Waste disposal:

Return removed parts to Prevo with A.F.A. for full reimbursement.