

PREVOST

WARRANTY BULLETIN

WB16-02H

DATE :	MAY 2016	SECTION :	06 - Electrical
EXPIRATION:	MAY 2018		
SUBJECT :	CHARGING SYSTEM IMPROVEMENT		

REVISION H: THIS WARRANTY BULLETIN SUPERSEDES PREVIOUS VERSION.
 Released: July.2018 Nut M8 #5001787 cancelled and changed, use nut #5001983 instead 

APPLICATION

NOTICE TO SERVICE CENTERS <i>Verify vehicle eligibility by checking warranty bulletin status with SAP or via ONLINE WARRANTY SYSTEM available on Service / Warranty tab of Prevost website.</i>	
Model	VIN 
X3-45 coaches Model Year : 2015 - 2016	From 2PCG33496FC73 5762 up to 2PCG33495GC73 6077 incl. and vehicle 4RKG33499G973 7275
H3-41, H3-45 coaches Model Year : 2015 - 2016	From 2PCH33496FC71 2695 up to 2PCH33497GC71 3324 incl.
This bulletin does not necessarily apply to all the above-mentioned vehicles, some vehicles may have been modified before delivery. The owners of the vehicles affected by this bulletin will be advised by a letter indicating the Vehicle Identification Number (VIN) of each vehicle concerned.	

DESCRIPTION

On the vehicles affected by this bulletin, it is necessary to perform a Multiplex software update plus other corrective measures to improve the charging system. The corrective measures of this bulletin are very important and must all be carried out on the involved vehicles.

MATERIAL NEEDED

ELECTRICAL COMPONENTS – CORRECTIVE MEASURES

H3 + X3 Series: Order kit #7770335 that includes the following parts:

Part No.	Description	Qty
062490	SLEEVE, HEAT SHRINKING 6-IN LONG	1
067835	CABLE, JUMPER Rev.C	1
564055	TERMINAL, SOCKET (BUSSMAN CONNECTOR)	1
060297	ADAPTER, STUD	1
5001341	WASHER, FLAT M8 STAINLESS STEEL	3
5001983	NUT, M8 STAINLESS STEEL NSS	2
12089679	SEAL, CABLE (BUSSMAN CONNECTOR)	1



DRIP EDGES INSTALLATION

For **H3 Series**, order Drip Edges kit #7770177 that includes the following parts:

Part No.	Description	Qty
470218	DRIP EDGE, UPPER	1
470219	DRIP EDGE, LOWER	1
504339	RIVET, POP DOME OPEN END 1/8" x 3/8	35

For **X3 Series**, order Drip Edges kit #7770178 that includes the following parts:

Part No.	Description	Qty
470278	DRIP EDGE, UPPER	1
470152	DRIP EDGE, LOWER	1
504339	RIVET, POP DOME OPEN END 1/8" x 3/8	33
504610	RIVET, MGL PRDG SS 1/4" x 5/8	4

Other required parts:

Part No	Description	Qty
506869	NOTE : One (1) roll is enough to repair nine (9) vehicles ROLL, DOUBLE FACE SELF-ADHESIVE FOAM TAPE, 1/32 x 1/4 x 300ft	1
500583	SCREW, #6x½ BINDING HEAD PHILLIPS TAPPING	5

NOTE

Material can be obtained through regular channels.

The bulletin structure is as follows (the corrective measures can be performed in any order):

DONE

1. MULTIPLEX SOFTWARE UPDATE

DONE

2. ELECTRICAL COMPONENTS – CORRECTIVE MEASURES

2.1 ALTERNATOR JUMPER CABLE INSPECTION & REPLACEMENT

DONE

2.2 ALTERNATOR 24VD (direct) ON PIN #4 CHANGED FOR 24VI (indirect)

DONE

3. DRIP EDGES INSTALLATION

3.1 H3 SERIES

3.2 X3 SERIES

PROCEDURE



DANGER

Park vehicle safely, apply parking brake, stop engine. Prior to working on the vehicle, set the ignition switch to the OFF position and trip the main circuit breakers equipped with a trip button. On Commuter type vehicles, set the battery master switch (master cut-out) to the OFF position.

1. MULTIPLEX SOFTWARE UPDATE

1. A Multiplex software update must be performed on the vehicle.
2. You must make an appointment at your nearest Prevost Service Center in order to receive the software update. You can also contact your Prevost Service Representative for help.

2. ELECTRICAL COMPONENTS – CORRECTIVE MEASURES

2.1 ALTERNATOR JUMPER CABLE INSPECTION & REPLACEMENT

NOTE: your vehicle may already have the appropriate stud adapter and jumper cable version

RISK OF ELECTRICAL SHOCK

The alternator is connected to the batteries through master relay R1. If the ignition switch is in the OFF position and the battery master switch (master cut-out) is set to the OFF position, there should not be electrical power to the alternator terminals. However, a faulty master relay R1 could eventually leave the battery power circuit closed, thus electrical power would be present at the alternator terminals.

Using a multimeter, probe the alternator **B1+** terminal and the ground terminal. Make sure that the voltage reading is 0 volt prior disconnecting the alternator cables.

1. Disconnect power cable **A** from the upper alternator **B1+** stud terminal.

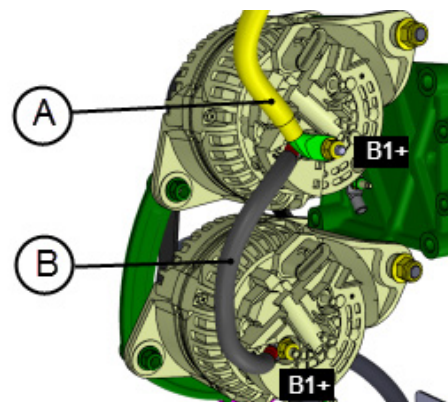

FIGURE 1

A : (+) POWER CABLE

B : (+) JUMPER CABLE

2. Disconnect jumper cable **B** from the upper alternator **B1+** stud terminal. To do so, unscrew and remove stud adapter **C** and flat washer.
3. Disconnect jumper cable **B** from the lower alternator **B1+** stud terminal. To do so, remove hex nut and washer.

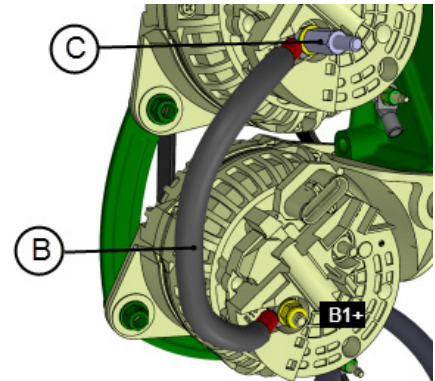

FIGURE 2

B : (+) JUMPER CABLE

C : (+) STUD ADAPTER

IMPORTANT: Make sure that the adapter included in the kit is the appropriate adapter for the installation.

4. Inspect the stud adapter included in your kit. The hex section (between two flat surfaces) **must measure 5/8 inch (16mm)** (FIGURE 3).
5. If the stud adapter hex section measures 1/2 inch (13mm), **DO NOT INSTALL THAT ADAPTER**. You absolutely must get the appropriate adapter #060297.

*The use of an inappropriate adapter leaves jumper cable lug improperly tightened. Moreover, the contact surface with the power cable is insufficient to ensure **good electrical conductivity**. Damage to the terminal of the alternator and the lug are likely to occur.*

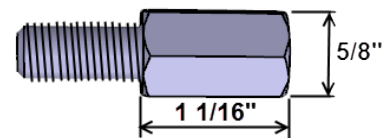

FIGURE 3

CORRECT (part #060297)

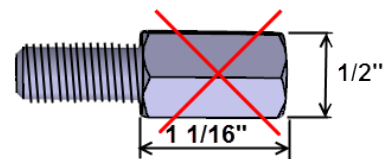

FIGURE 4

INCORRECT (part #564590)

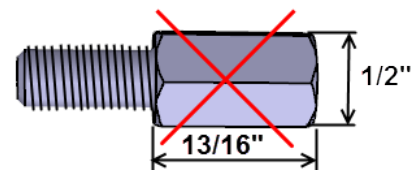

FIGURE 5

INCORRECT (part #564159)

6. Before installing the jumper cable, make sure that the nut that secures the alternator stud is properly tightened.

CHECK THAT THE NUT SECURING THE STUD IS PROPERLY TIGHTENED (10 lbf-ft)

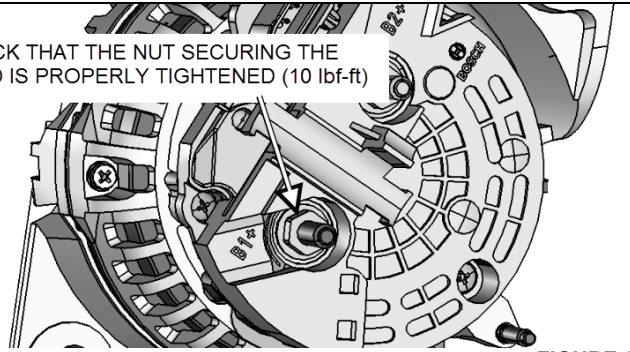

FIGURE 6

7. Reinstall the jumper cable **#067835 revision C** included in kit #7770335 (FIGURE 7, FIGURE 8).

Rev.C lug terminal through hole dia.= 5/16" CORRECT

Rev.B lug terminal through hole dia.= 13/32" INCORRECT

Rev.B diameter of the through hole is too large, reducing contact surface with the stud and the nut thus reducing electrical conductivity between the lug and the alternator stud (FIGURE 9).



FIGURE 7



FIGURE 8

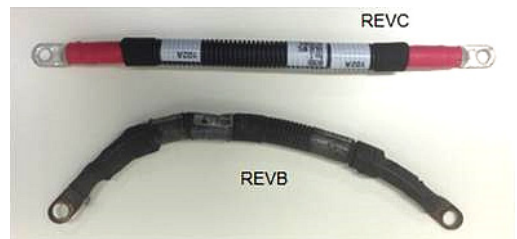

FIGURE 9

-
8. Reinstall appropriate jumper cable **B** (i.e. rev.C) with appropriate stud adapter. Refer to **FIGURE 10**.

Note: M8 nut "E" formerly #5001787 is canceled. Use nut #5001983 instead.

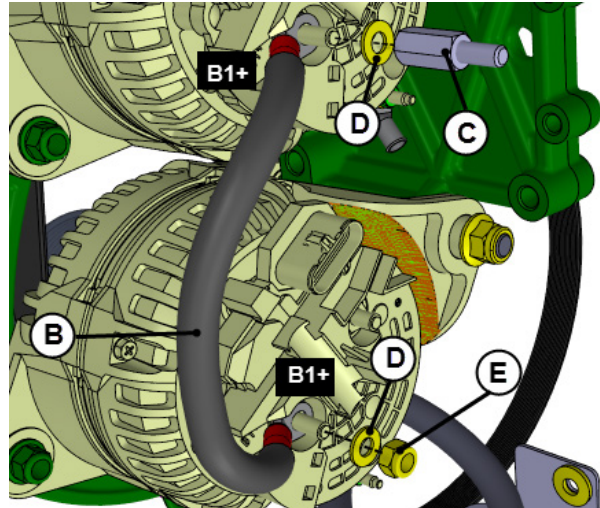

FIGURE 10

- B : JUMPER CABLE #067835 revision C**
C : STUD ADAPTER #060297 torque: 10 lbf-ft
D: FLAT WASHER #5001341
E: NUT M8 #5001983 torque: 10 lbf-ft

-
9. Reinstall power cable **A**. To do so, connect power cable **A** to the upper alternator **B1+** stud terminal. Refer to **FIGURE 11**.

Note: M8 nut "E" formerly #5001787 is canceled. Use nut #5001983 instead.

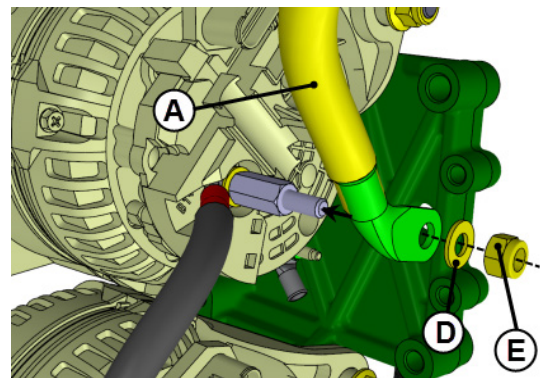

FIGURE 11

- A : POWER CABLE**
D: FLAT WASHER #5001341
E: NUT M8 #5001983 torque: 10 lbf-ft

-
10. **Protect the alternator studs against corrosion.** Apply anti-corrosion compound or **Color Guard Rubber Coating** on alternator terminals, cable lugs and nuts.
-

2.2 ALTERNATOR 24VD (DIRECT) ON PIN #4 CHANGED FOR 24VI (INDIRECT)
NOTE: this corrective measure may have already been performed on your vehicle

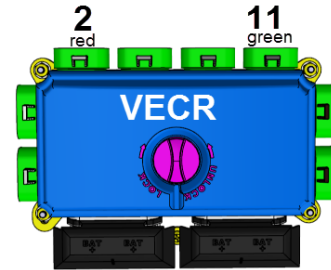
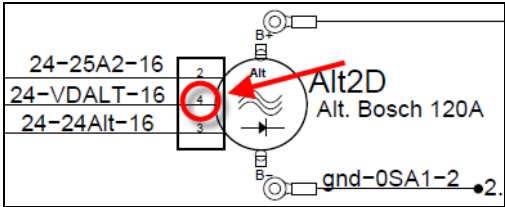

FIGURE 12 : VECR

1. Inside rear electrical compartment (rear junction box), locate VECR module (FIGURE 12).

2. Unplug connector no. 11 (green).

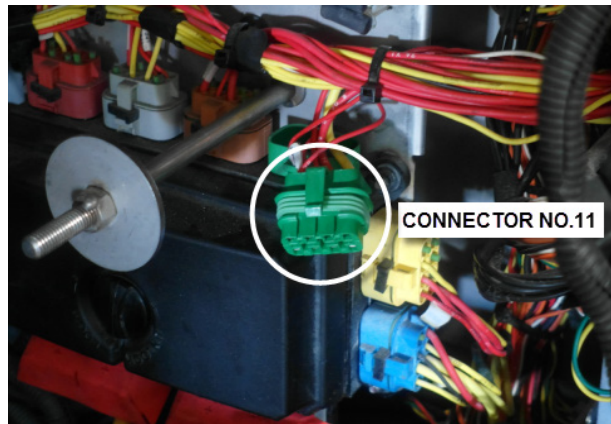

FIGURE 13

3. Using an extractor tool or a small flat blade screwdriver, remove wire 24VDALT from cavity H of connector no.11 (FIGURE 13 to FIGURE 16).

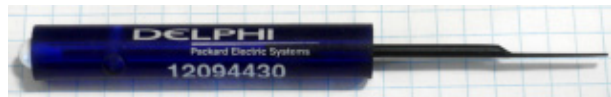

FIGURE- 14 : EXTRACTOR DELPHI 12094430

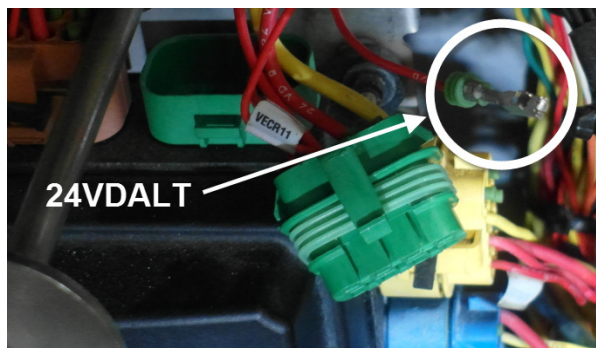

FIGURE 15

4. Relocate wire 24VDALT to cavity **C** of connector no.2 (red) on the harness.

Cavity **C** of connector no.2 should be available. This branch of the circuit will be protected by 10A fuse F64 (see FIGURE 18 below).

Should cavity C not be available, refer to your vehicle wiring diagram page 5.1 to select another free cavity protected by a 10A or 15A fuse (see FIGURE 18 for reference).

IMPORTANT NOTE: If required, extend wire 24VDALT using 16 AWG red electrical wire in order to reach connector no.2.

Cut and discard existing terminal. Extend wire 24VDALT by doing **one** soldered joint. Use the included piece of heat shrinking sleeve to protect the soldered joint. Crimp the terminal included with the kit to the end of wire and the seal (see FIGURE 17).

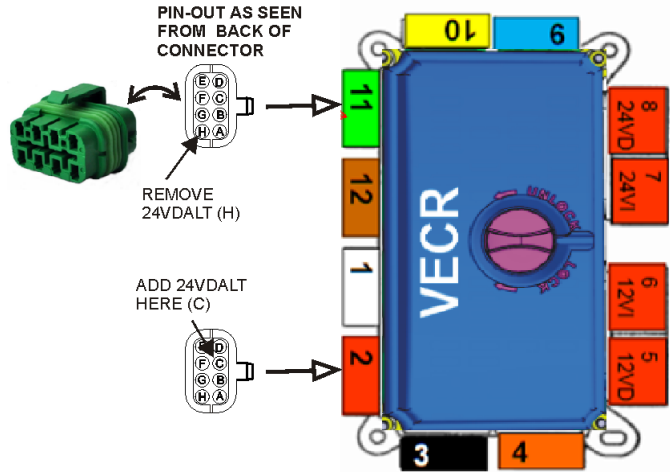

FIGURE 16



FIGURE 17

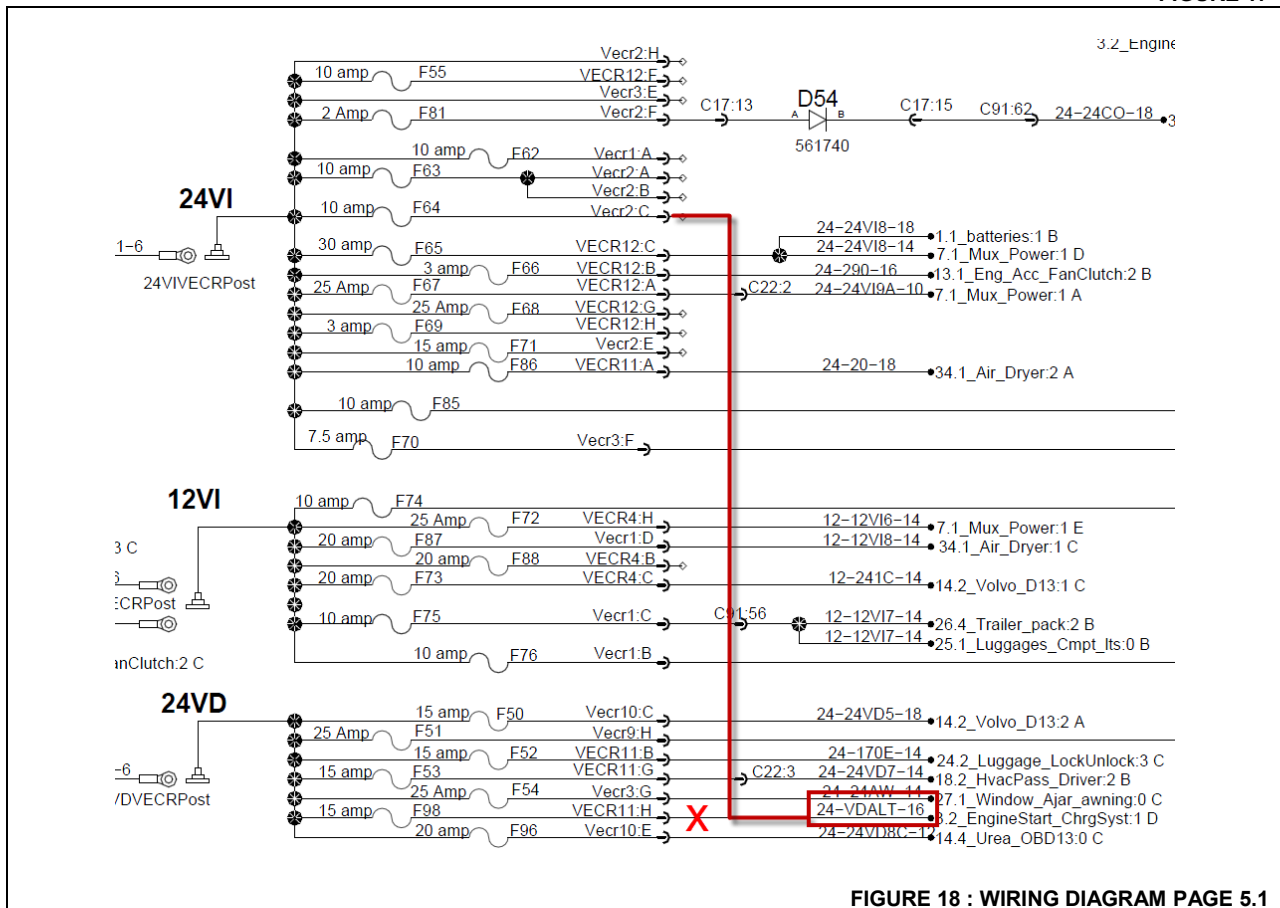

FIGURE 18 : WIRING DIAGRAM PAGE 5.1

3.0 DRIP EDGES INSTALLATION

3.1 H3 SERIES (see section 3.2 for X3 Series drip edges installation)

Special tool needed:

RIGHT ANGLE DRILL



1. Identify drip edge #470218 and #470219 (FIGURE 19 & FIGURE 20).

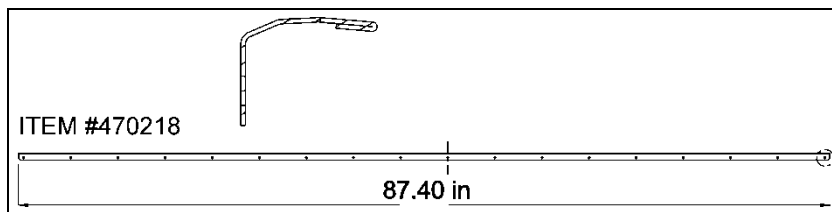

FIGURE 19: H3 SERIES UPPER DRIP EDGE

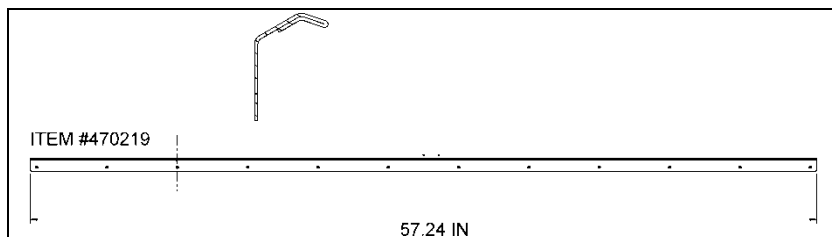

FIGURE 20: H3 SERIES LOWER DRIP EDGE



FIGURE 21

2. Clean dirt on the lower part of the **exhaust aftertreatment system ATS** access hatch as well as the area located right above the ATS access hatch (FIGURE 22). It is very important to install the drip edge on a clean surface to assure water tightness.

NOTE: FIGURE 22 shows where the drip edges will be installed.

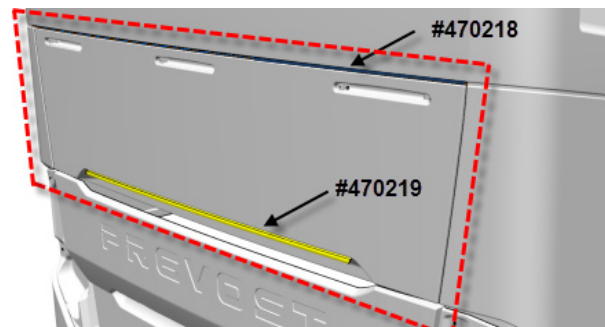

FIGURE 22

3. To ease the drip edge installation, draw reference lines indicating the center of the rear end to make sure that the drip edges will be installed perfectly centered (FIGURE 23). You may use the center high mounted stop light as reference to find the center of the rear end.

- upper reference line on the body surface
- lower reference line on the ATS access hatch surface

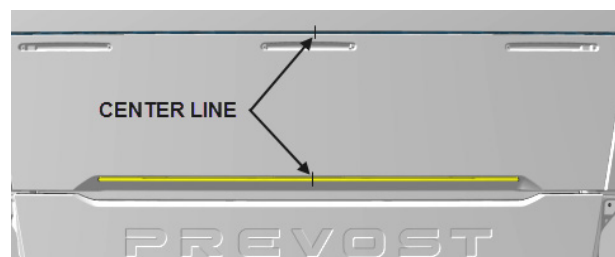
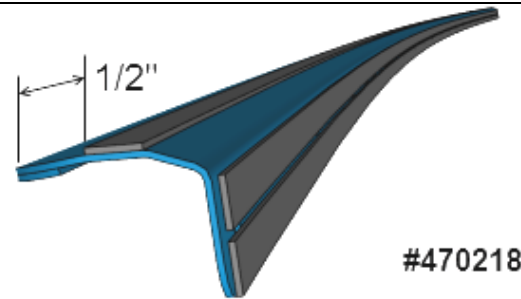

FIGURE 23

4. Apply three strips of double face self-adhesive tape along drip edge #470218 from one end up to the other end. The first strip should be placed about 1/2 inch from the edge as shown on FIGURE 24. The two other strips should be placed on each side of the drilled holes.

IMPORTANT NOTE: The foam tape must be stuck on the drip edges. **Drip edges must not be stuck on the vehicle body.**



#470218

FIGURE 24

5. Apply two strips of double face self-adhesive tape along drip edge #470219 from one end up to the other end. The strips should be placed on each side of the drilled holes (FIGURE 25).

IMPORTANT NOTE: The foam tape must be stuck on the drip edges. **Drip edges must not be stuck on the vehicle body surface.**

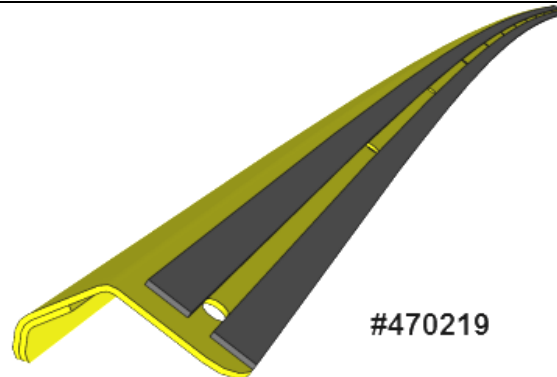

#470219

FIGURE 25



FIGURE 26

6. Draw a line to mark the center of both drip edge (FIGURE 27).

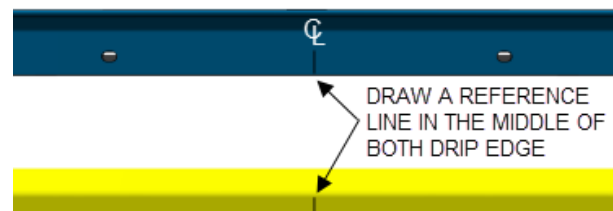

FIGURE 27

INSTALLATION OF DRIP EDGE #470219

- Place drip edge #470219 in proper position, on the access hatch. Use reference lines marked on the drip edge and the vehicle body to center properly.

The front face of the drip edge must be flush with the surface above. The goal is to prevent water from dripping on the inner side of the engine compartment door.

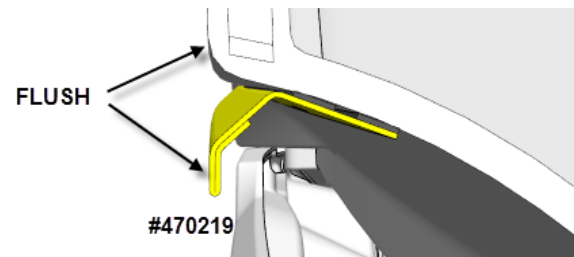

FIGURE 28

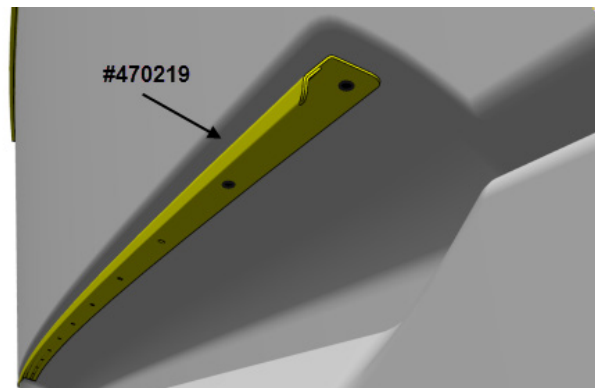

FIGURE 29

- Preinstall the drip edge using three (3) screw #6x1/2 (#500583), see FIGURE 30.

Use a 9/64" drill bit. Place one screw at each end and one in the center of the drip edge.

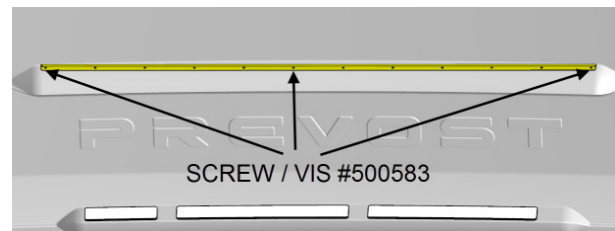

FIGURE 30

- Fasten drip edge using nine (9) rivets #504339 as shown on FIGURE 31. Use a 9/64" drill bit.

IMPORTANT NOTE: The drip edges must not be stuck on the vehicle body

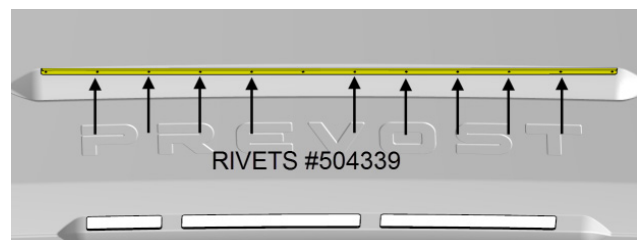

FIGURE 31

10. Remove the three (3) screws previously installed and replace with rivets.

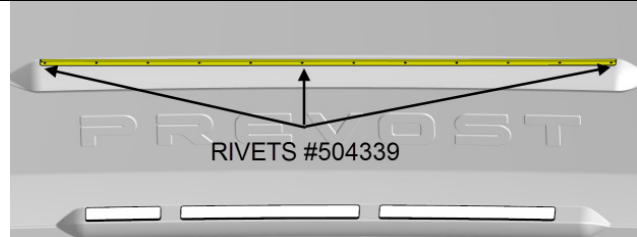

FIGURE 32

INSTALLATION OF DRIP EDGE #470218

You don't need to remove the access hatch in order to install drip edge if you use a right angle drill.

11. Place the drip edge #470218 in proper position, on the vehicle body (**not on the access hatch**). Use reference lines marked on the drip edge and the vehicle body to center properly.

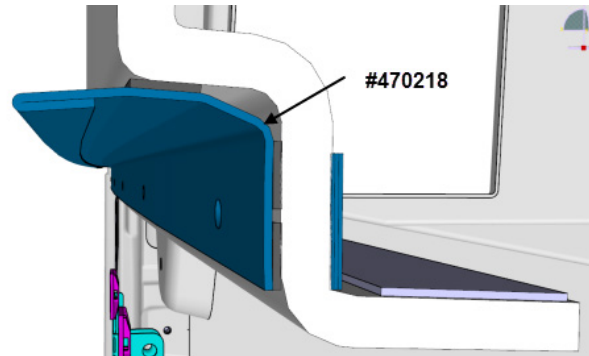

FIGURE 33

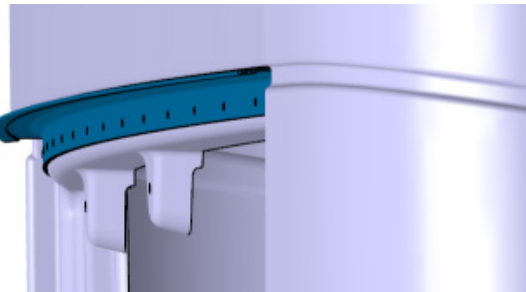

FIGURE 34

12. Preinstall the drip edge using five (5) screws #6x1/2 (#500583) as shown on FIGURE 35.

Drill using a 9/64 bit. FIGURE 36 shows how to drill holes with the access hatch in place using a right angle drill.

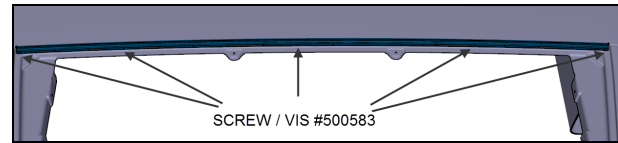

FIGURE 35



FIGURE 36

13. Fasten the drip edge using thirteen (13) rivets #504339 as shown on FIGURE 37.

Drill using a 9/64 bit.

IMPORTANT NOTE: *The drip edges must not be stuck on the vehicle body*

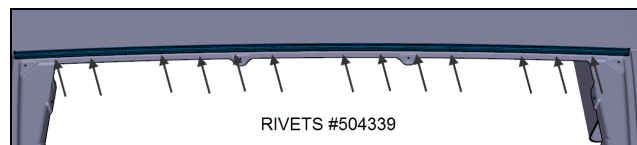

FIGURE 37



FIGURE 38

14. Remove the five (5) screws previously installed and replace with rivets.

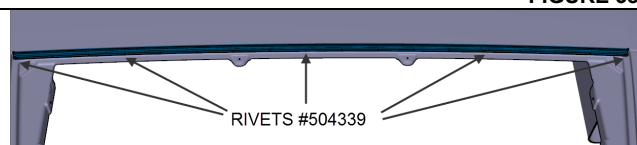

FIGURE 39

3.2 X3 SERIES

1. Identify the drip edge #470278 and #470152 (FIGURE 40 & FIGURE 41).

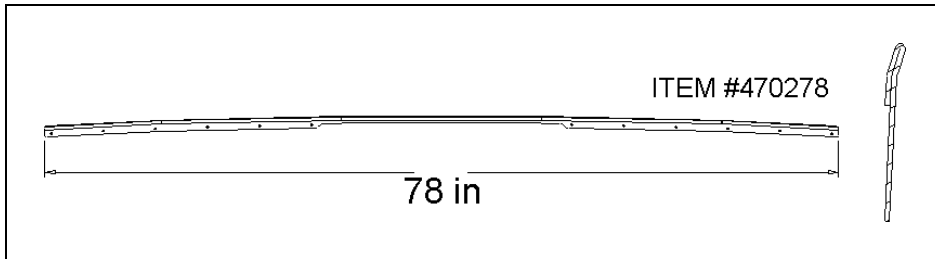

FIGURE 40: X3 SERIES UPPER DRIP EDGE

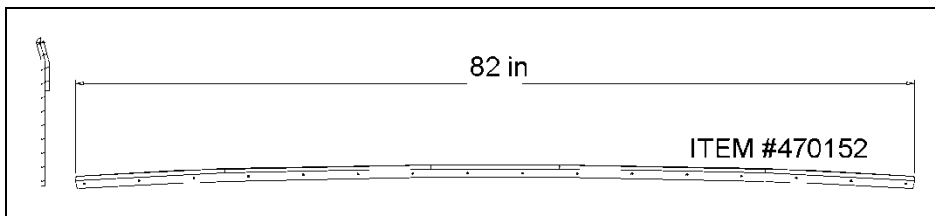

FIGURE 41: X3 SERIES LOWER DRIP EDGE

2. See on FIGURE 42 where each drip edge will be positioned. The drip edges will be fastened on the vehicle body, **not on** the ATS access hatch.

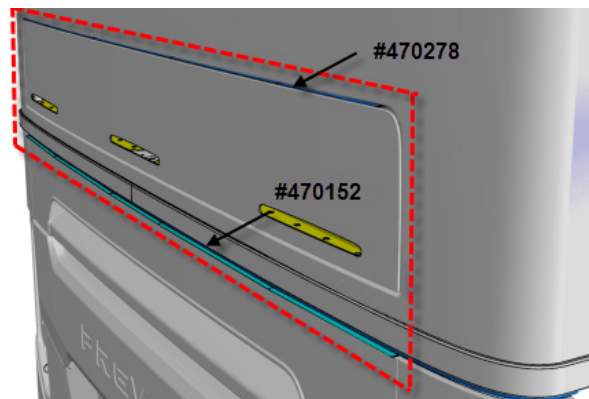

FIGURE 42

3. To ease installation of the drip edges, draw a reference lines on the vehicle body indicating the center of the rear end so that the drip edges will be installed perfectly centered (FIGURE 43). You may use the center high mounted stop light and the SS molding as reference to find the center of the rear end.

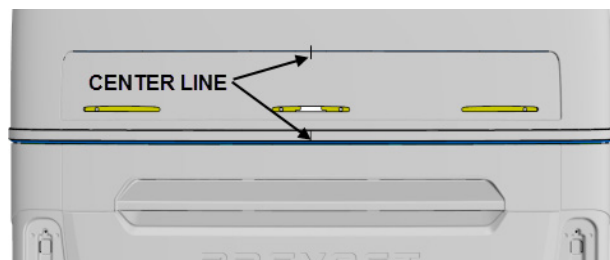

FIGURE 43

4. Remove the **exhaust aftertreatment system (ATS) access hatch**.

Prior to removing the access hatch, protect the surrounding surfaces using wide paper masking tape.



FIGURE 44

- a) To do so, drill through the folding arm rivets (4 rivets) shown on FIGURE 45
- b) Disconnect the “high mounted stop lights” cable harness.
- c) Unscrew the hinges mounting bolts (2 bolts per hinge). Spacers may be found behind the hinges. Make sure you identify the spacers in order to reinstall the access hatch using the proper spacer at the correct location (FIGURE 46).



FIGURE 45

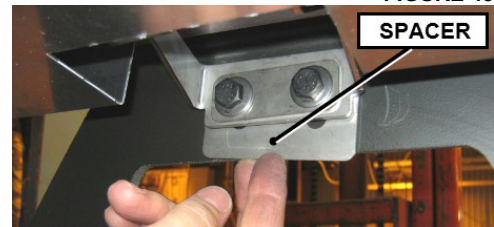

FIGURE 46

5. Clean dirt on the area located right above the ATS access hatch and the area where the lower drip edge will be installed (FIGURE 42). It is very important to install the drip edges on a clean surface to ensure water tightness.

6. Apply two strips of double face self-adhesive tape, one to each side of the drilled holes (except in the middle where only one strip can be applied) along drip edge #470278 as shown on FIGURE 47.

IMPORTANT NOTE: The foam tape must be stuck on the drip edges. The drip edges must not be stuck on the vehicle body.

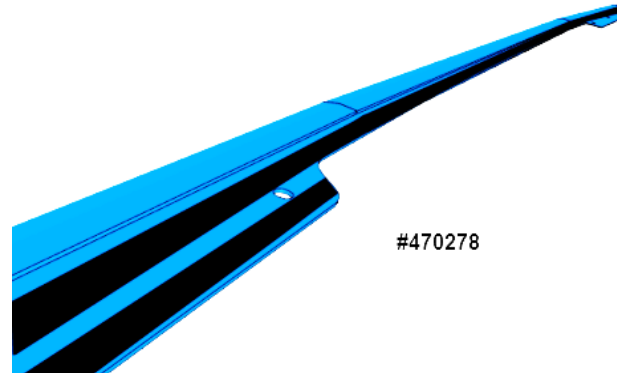

FIGURE 47

7. Apply two strips of double face self-adhesive tape along drip edge #470252 from one end up to the other end. The strips should be placed on each side of the drilled holes (FIGURE 48).

IMPORTANT NOTE: The foam tape must be stuck on the drip edges. Drip edges must not be stuck on the vehicle body.

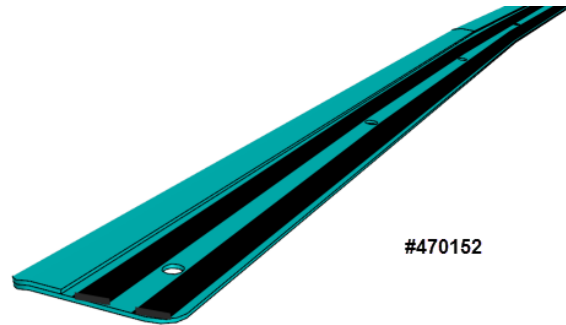

FIGURE 48

8. Draw a line to mark the center of both drip edge (FIGURE 49).

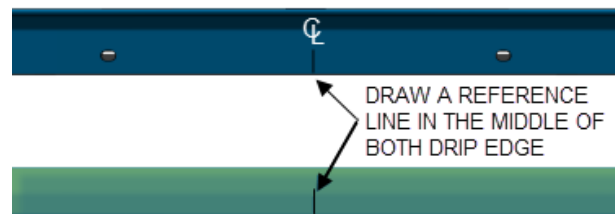

FIGURE 49

INSTALLATION OF DRIP EDGE #470278

The drip edge should extend past the panel surface by $\frac{1}{4}$ ". The goal is to prevent water/rain from dripping on the inner side of the SCR access hatch.

9. Place drip edge #470278 in proper position. Use reference lines marked on the drip edge and vehicle body to center properly.

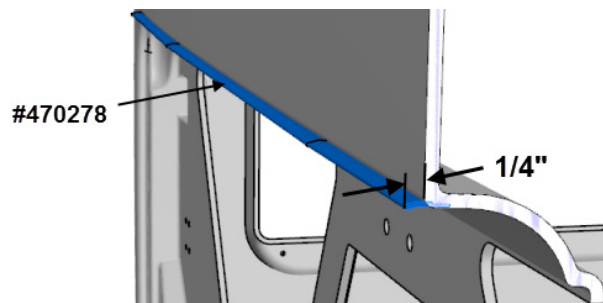

FIGURE 50

IMPORTANT NOTE: The drip edge must not be stuck on the vehicle body except in the middle area where the drip edge cannot be fastened with rivets. In this particular case, peel back the protective layer on the adhesive foam tape and stick to the surface.

No rivets are used to fasten the middle of the drip edge because the rivet head will interfere with the upper edge of the ATS access hatch.

10. Preinstall the drip edge using four (4) screws #6x1/2 (#500583).

Drill with a 7/64 bit. Place screws as shown on FIGURE 51.

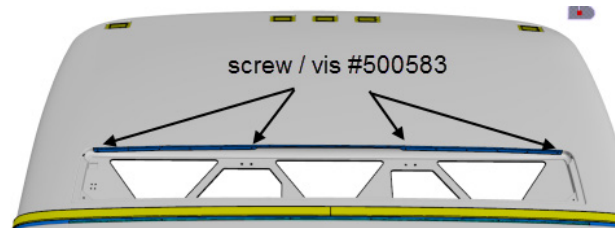

FIGURE 51

11. Fasten the drip edge using eight (8) rivets #504339 as shown on FIGURE 52.

Use a 1/8 drill bit for the installation of the rivets

12. Remove the four (4) screws previously installed and replace with rivets.

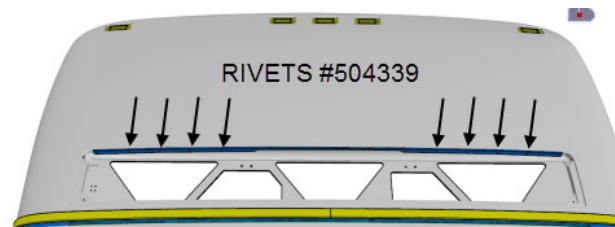

FIGURE 52

INSTALLATION OF DRIP EDGE #470152

13. Place the drip edge #470152 in proper position. Use reference lines marked on the drip edge and vehicle body to center properly.

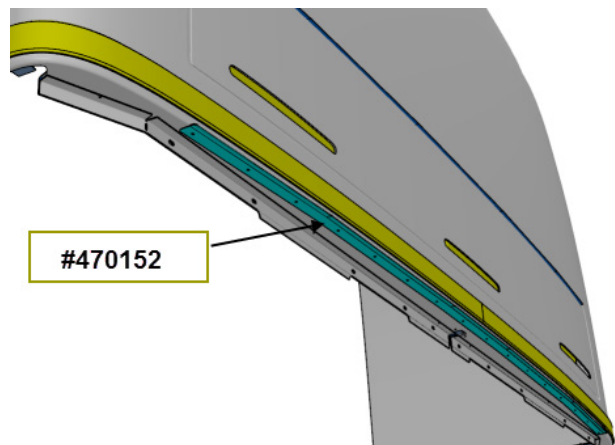

FIGURE 53

14. Install drip edge #470152, by using the same method as for the first drip edge. Preinstall the drip edge using five (5) screw #6x1/2 (#500583) and fasten using rivets #504339. Replace the five screws previously installed with rivets #504339.

The drip edge should be shifted not more than 7/32" from the surface of the molding located above it (FIGURE 54). The goal is to prevent water from dripping on the inner side of the engine compartment door.

IMPORTANT NOTE: Drip edges must not be stuck on the vehicle body.

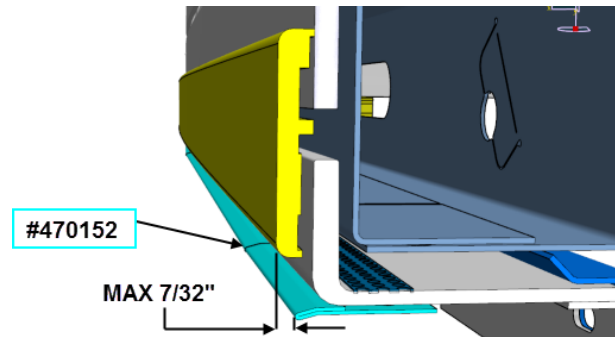

FIGURE 54

ATS ACCESS HATCH REINSTALLATION AND ADJUSTMENT

15. Bolt the access hatch hinges, making sure to reinstall the spacers as originally installed.
16. Tighten the bolts (4 bolts).

Screw M8-1.25 G8.8 standard torque: 16 lb-ft

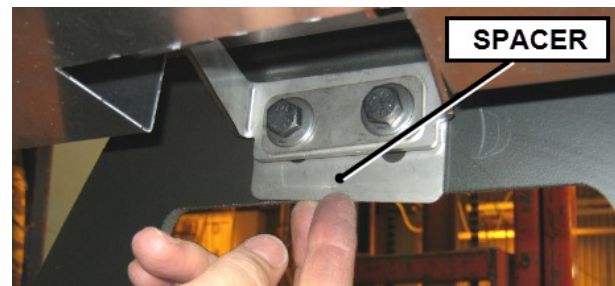

FIGURE 55

17. Reinstall the folding arm. Secure the folding arm as shown on FIGURE 56 using four 1/4" x 5/8 stainless steel rivets #504610.

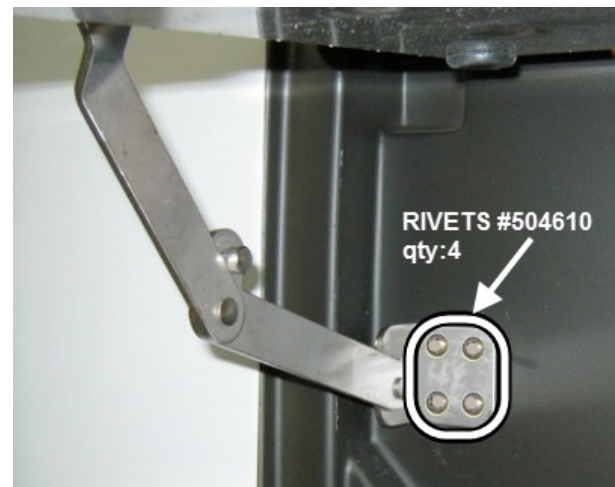

FIGURE 56

-
18. Close the access hatch. Make sure it is centered in the opening. Ideally, the gap should be equal on four sides.

GAP: $3/16 \pm 5/64$ inch

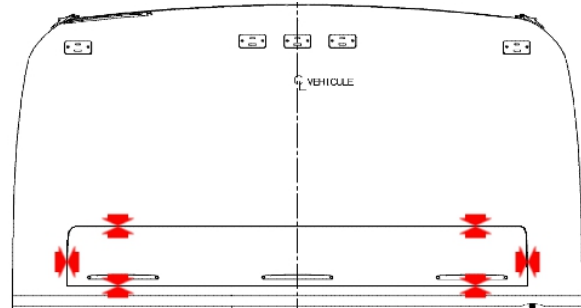

FIGURE 57

-
19. Check the upper part of the access hatch for rubbings against the rivets when opening and closing the hatch. If this is the case, the hatch has to be moved downward.
20. Loosen the hinge mounting bolts (4 bolts) slightly.
21. Use a screwdriver and hammer, tap slightly on the hinges to move the door for proper fit (FIGURE 58).



FIGURE 58

-
22. Once the hatch is properly positioned, tighten the hinges bolts (4 bolts).

-
23. If the hatch has moved down, it may be necessary to move the keeper down slightly (FIGURE 59). To do so, loosen the mounting bolts (2 bolts) and move the keeper in the direction shown with arrows. Firmly tighten the keeper bolts once adjustment is done).

Screw M8-1.25 G8.8 standard torque: 16 lb-ft

24. Check that the access hatch latches easily.

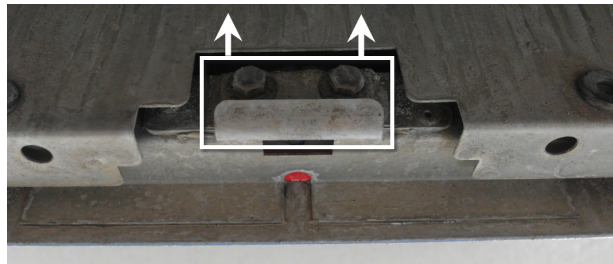

FIGURE 59 : KEEPER

PARTS / WASTE DISPOSAL

Discard waste according to applicable environmental regulations (Municipal/State[Prov.]/ Federal)

WARRANTY

The software update time is not included in the labor reimbursed by this warranty bulletin. The Multiplex software update is covered under the *Red Carpet Service Policy*.

This modification is covered by Prevo's normal warranty. We will reimburse you the parts and

- four hours (4.0) of labor
- five hours (5.0) of labor if the vehicle is equipped with an auxiliary sump tank

upon receipt of a warranty claim. Please submit claim via our Online Warranty System, available at www.prevostcar.com (under Service \ Warranty section). Use Claim Type: "Bulletin/Recall" and select "Warranty Bulletin WB16-02".

OTHER

VBC Bulletin	N/A
Fail Code	06.15
Defect Code	09
Syst. Cond	B
Causal Part	067835

Access all our Service Bulletins by typing the following URL in your browser address bar:

<http://techpub.prevostcar.com/en/>

E-mail us at technicalpublications_prev@volvo.com and type "ADD" in the subject to receive our warranty bulletins by e-mail.