



**SAFETY
RECALL**

SR15-330A

DATE :	JUNE 2015	SECTION :	11 - Rear axle
SUBJECT:	WHEEL HUB CARRIER REPLACEMENT – ZF A132 DRIVE AXLE		

REVISION A: THIS SAFETY RECALL SUPERSEDES PREVIOUS VERSION.

Range of applicable vehicles modified. Added, specific range of vehicle requiring changing of drive axle flange shafts. Added mention to perform "brake test".

APPLICATION

NOTICE TO SERVICE CENTERS <i>Verify vehicle eligibility by checking warranty bulletin status with SAP or via ONLINE WARRANTY SYSTEM available on Service / Warranty tab of PrevoSt website.</i>	
Model	VIN
X3-45 Commuter Model Year: 2015	 From 4RKG33497F973 7001 (fleet # 2492) up to 4RKG33497F973 7077 (fleet # 2568) incl.
<p>This Safety Recall does not necessarily apply to all the above-mentioned vehicles, some vehicles may have been modified before delivery. The owners of the vehicles affected by this recall will be advised by a letter indicating the Vehicle Identification Number (VIN) of each vehicle concerned.</p>	

DESCRIPTION

On the vehicles affected by this bulletin, it is necessary to replace both wheel hub carriers on ZF A132 drive axle. A specific range of vehicles also need to have both flange shaft replaced (see details below).

MATERIAL

Order the following parts:

Part No.	Description	Qty
621947	HUB CARRIER, WHEEL (ZF No. 4474 335 177)	2

Other parts that may be required:

For vehicles within the following range: From 4RKG33495F973**7031** up to 4RKG33498F973**7038**

It is necessary to replace the two drive axle flange shafts.

Description	Qty
FLANGE SHAFT	2

NOTE

Material can be obtained through regular channels.

PROCEDURE



DANGER

Park vehicle safely, apply parking brake, stop engine. Prior to working on the vehicle, set the ignition switch to the OFF position and trip the main circuit breakers equipped with a trip button. On Commuter type vehicles, set the battery master switch (master cut-out) to the OFF position.

- 1) Refer to the ZF procedure (Prevost ZF A132 Bus Axle Repair Instruction Wheel Head Carrier Replacement) appended to this bulletin.
- 2) Once the replacement completed, perform the "Brake Test" as applicable. Record the results.

PARTS DISPOSITION

DO NOT RETURN THE REPLACED PARTS. Discard waste according to applicable environmental regulations (Municipal/State[Prov.]/ Federal)

WARRANTY

This modification is covered by Prevost's normal warranty. We will reimburse you the parts and eight hour(s) (8.0) of labor upon receipt of a completed A.F.A. Please submit claim via our Online Warranty System, available at www.prevostcar.com (under service \ warranty section). Use Claim Type: "Bulletin/Recall" and select "Safety Recall SR15-330".

Should you only wish to close the safety recall (without reimbursement), fill-in the "Safety Recall Certification Sheet" provided with this bulletin and return it to our warranty department by Email at prevost.onlinewarranty@volvo.com or by fax at 418-831-9301.

OTHER

VBC Bulletin	N/A
Fail Code	11.02
Defect Code	09
Syst.Cond	B
Causal Part	621947

Access all our Service Bulletins on
<https://secureus5.volvo.com/technicalpublications/en/pub.asp>
or scan the QR-Code with your smart phone.

E-mail us at technicalpublications_prev@volvo.com and type
"ADD" in the subject to receive our warranty bulletins by e-mail.



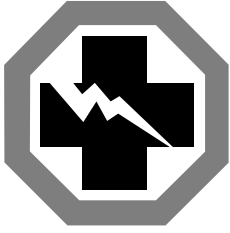

**Safety Recall
Certification Sheet
(Ref: SR15-330)**

VEHICLE SERIAL NUMBER:

4	R	K																	
---	---	---	--	--	--	--	--	--	--	--	--	--	--	--	--	--	--	--	--

PERFORMED BY		OWNER/OPERATOR	
We hereby certify that Safety Recall Instructions with regard to Safety Recall SR15-XX have been performed.			
Name: _____		Name: _____	
Addr: _____		Addr: _____	
Phone: _____		Phone: _____	
Fax: _____		Fax: _____	
Signature :	_____	Signature :	_____
Date:	_____	Date:	_____

If the information mentioned above is incorrect or you are not the owner of this vehicle anymore, please fill this section and return to sender.

NEW OWNER: _____

BUSINESS: _____

ADDRESS (including County): _____

TELEPHONE: _____ **FAX:** _____

Please return this completed document with your A.F.A. form



Prevost

ZF A132

Bus Axle

Repair Instruction

Wheel Head Carrier

Replacement

Structure of the Service Manual

The structure of this manual reflects the sequence of work steps for completely dismantling the removed unit. Tools required for carrying out the repair work are listed in the current text as well as in chapters “WS” (Special Tools) and “WH” (Commercial Tools).

Important information on work safety

As a basic principle, the workshop carrying out the repair or maintenance of ZF units shall be fully responsible for work safety.

The observance of all valid safety regulations and legal requirements is a prerequisite for avoiding any damage to persons and products during maintenance and repair work. Repair workshops must familiarize themselves with these regulations prior to starting any work.

The following safety references are used in this manual:

 CAUTION	This symbol serves as a reference to special working procedures, methods, information, use of auxiliaries etc... indicated in this repair manual.
--	--

 DANGER	This symbol identifies situations in which lacking care may lead to personal injury or damage to the product.
--	--

NOTE:	Thoroughly study this manual before starting any tests and repair work.
--------------	---

NOTE:	Figures, drawings and parts in this manual do not always represent the original; they show the working procedure. Since the figures, drawings and parts are not shown to scale, do not draw any conclusions on size and weight (not even within one and the same illustration). Carry out work according to the legend.
--------------	---

NOTE:	After repair work and tests, the expert staff must verify that the product is functioning perfectly again.
--------------	--

NOTE:	All screws must represent that they have been torqued to the correct specification with the use of Torque Seal Paint across the face of the screw and body of the housing.
--------------	--

NOTE:	Before starting this task the technician MUST collect the following technical data: 1. The vehicle manufacturer 4. The vehicle operator 2. The vehicle chassis number 5. The ZF axle part number 3. The vehicle mileage 6. The ZF axle serial number Labor times are set: 4 hours / Wheel Head 8 Hours / Axle
--------------	--

TIGHTENING TORQUES FOR SCREWS (in Nm) ACC. TO ZF STANDARD 148

Friction coefficient: μ tot. = 0.12 for screws and nuts without subsequent treatment, as well as for phosphate coated nuts. Tighten manually!

Unless otherwise specified, the tightening torques can be taken from the following chart:

Metric ISO standard thread DIN 13, page 13

Dimension	8.8		10.9		12.9
M4	2.8		4.1		4.8
M5	5.5		8.1		9.5
M6	9.5		14		16.5
M7	15		23		28
M8	23		34		40
M10	46		68		79
M12	79		115		135
M14	125		185		215
M16	195		280		330
M18	280		390		460
M20	390		560		650
M22	530		750		880
M24	670		960		1100
M27	1000		1400		1650
M30	1350		1900		2250
M33	1850		2600		3000
M36	2350		3300		3900
M39	3000		4300		5100

Metric ISO fine thread DIN 13, page 13

Dimension	8.8		10.9		12.9
M 8 x 1	24		36		43
M 9 x 1	36		53		62
M 10 x 1	52		76		89
M 10 x 1.25	49		72		84
M 12 x 1.25	87		125		150
M 12 x 1.5	83		120		145
M 14 x 1.5	135		200		235
M 16 x 1.5	205		300		360
M 18 x 1.5	310		440		520
M 18 x 2	290		420		490
M 20 x 1.5	430		620		720
M 22 x 1.5	580		820		960
M 24 x 1.5	760		1100		1250
M 24 x 2	730		1050		1200
M 27 x 1.5	1100		1600		1850
M 27 x 2	1050		1500		1800
M 30 x 1.5	1550		2200		2550
M 30 x 2	1500		2100		2500
M33 x 1.5	2050		2900		3400
M 33 x 2	2000		2800		3300
M 36 x 1.5	2700		3800		4450
M 36 x 3	2500		3500		4100
M 39 x 1.5	3450		4900		5700
M 39 x 3	3200		4600		5300

SPECIAL TOOLS FOR DISASSEMBLY AND REASSEMBLY

A-132

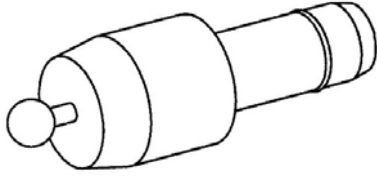

Assembly Aid

5870.651.085

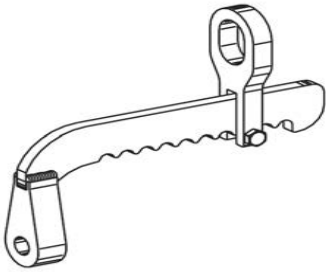

Load Carrying Fixture

5870.281.043

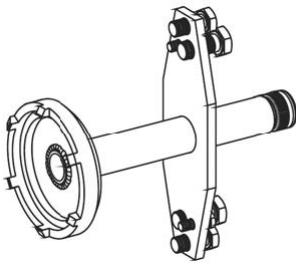

Slotted Nut Wrench

5870.401.146

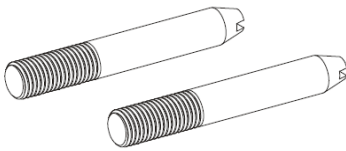

Locating Pins

5870.204.029

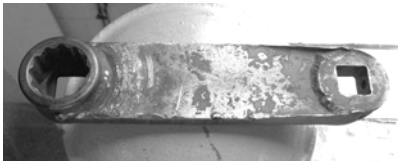

Torque Adaptor 30mm

ZF Special Tool



Torque Adaptor 27mm

ZF Special Tool

Note:

Due to the nature of this repair and the low miles that these vehicles have covered it has been decided that the oil currently in the axle **WILL BE REUSED** and should be drained into a clean container before dis-assembly of the axle begins.



1. Removing the oil from the axle.

Using a 19mm or 3/4" Allen key socket remove the sump plug and drain down the oil in the axle into a clean dry and water free container.

Note: This volume is approximately 4.5 Gallons therefore ensure your container is large enough.

This oil is going to put back in the axle when the replacement is complete.

Note:

The brake manufacturer's instructions and specifications are mandatory for any operations done on the brake system!

The relating information is included in the repair, maintenance and service manuals of the component manufacturer!

The applicable instructions are to be requested from the brake manufacturer or can be viewed on the brake manufacturer's website!

Brake manufacturer and brake type are indicated on the identification plate of the brake caliper!

2. Disassembly of brake cylinder and brake caliper

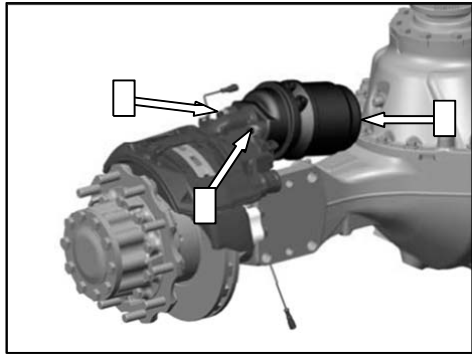

Removing the Brake Chamber

Place vehicle on a suitable vehicle lift where the wheels can be removed in a safe manor and parking brake is disengaged.

Use 24 mm wrench to remove both nylon locking nuts holding the air brake chamber to the brake caliper and secure the chamber out of the working area.

Note: Make sure none of the electrical wiring to the ABS circuits are damaged and unplug the wear detection connectors at this point.

If relevant remove wear indicator connection at the caliper.

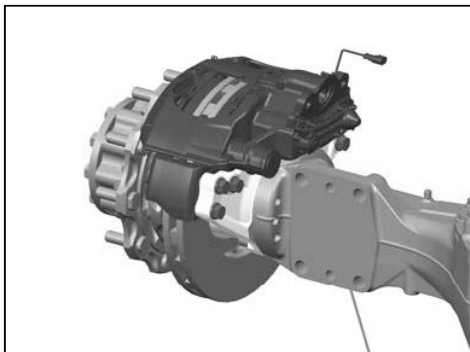

Removing the Brake Caliper Assembly

Using a short 10mm wrench back off the brake adjuster enough to pull the brake pads over any ridge on the edge of the brake rotor.

Using special torque adaptors to remove the caliper carrier bolts, safely remove the brake caliper in upward direction using suitable lifting equipment.

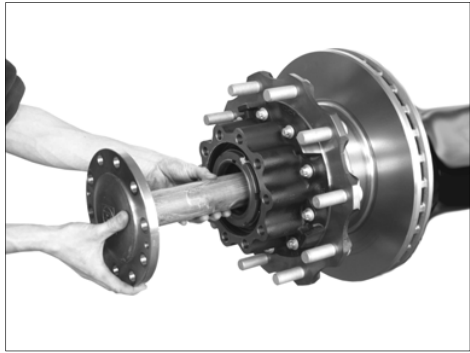

3. Disassembly of hub

Removing the Flange Shaft

Using a 14mm Allen Key Socket Loosen and remove all the screws from the flange shaft.

Pull flange shaft out of the axle using a tire lever on the end of one of the lug nut studs to the back of the flange.

Note: Be prepared this is a relatively heavy item. Place in a safe area where it will not be damaged.

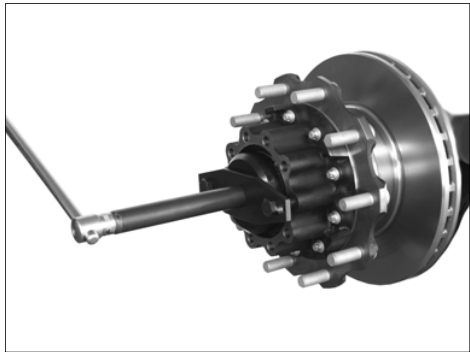

Remove the lock nut assembly.

Using a pin punch push the staked lock tab from the slot on the outer slotted nut far enough that the slotted nut is able to spin.

Using the special tool (5870 401 146) to loosen and remove the outer slotted nut and locking plate.

Note: Use caution as the nut is torqued to 1200 N/m (885 lb. ft.)

Again using the special tool (5870 401 146) loosen and remove the inner slotted nut (tightened to 850N/m (630 lb.ft.)



Remove the wheel Head.

Using a safe method of working, carefully remove the wheel head assembly and set aside.

Note: The provision of a special tool for lifting the wheel head assembly has been included in the special ZF tool kit.

In addition to this a lifting table makes the perfect substitute (see recommendations)

(S) Load carrying fixture 5870.281.043

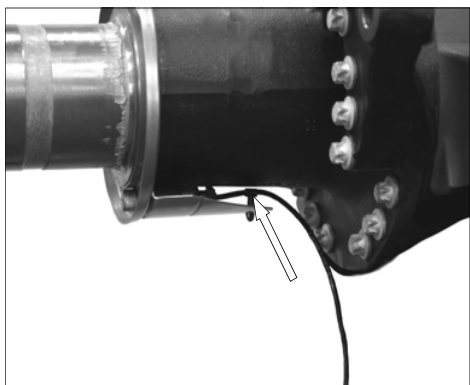

4. Disassembly of hub carrier

Removing the wheel head carrier

Remove the ABS sensor by first detaching the cable from the clamp and remove clamp from the screen sheet (dust cover) see arrow.

Push out the sensor and bushing towards the axle bridge.

Gently remove the screen sheet from the hub carrier using a hammer and drift around the circumference of the tube,

Note: There are provisions in your kit to replace the screen sheet if the old item gets damaged removing it. Please try to re-use the original.

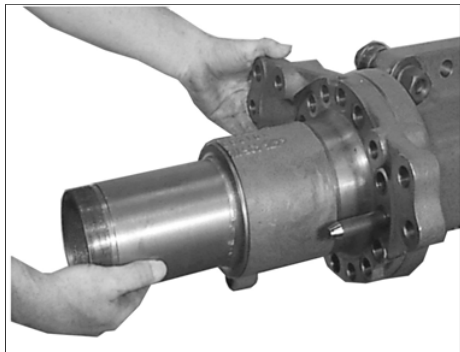

Using the 14 mm Allen key socket, loosen the ring of screws holding the hub carrier. Remove 2 screws completely and replace them with the 2 locating screws (5870.204.029).

Remove the remaining screws releasing hub carrier and place in an area for it to be returned to ZF for inspection.

Remove O-ring from hub carrier.

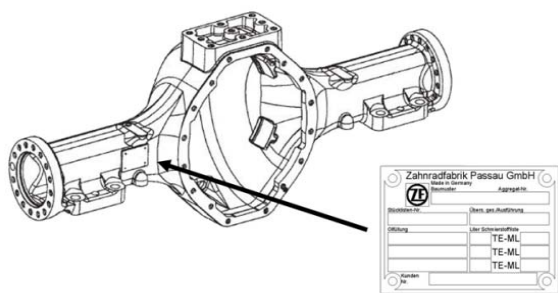

Once the hub has been removed it will need to be labelled with warranty data:
Axle part number
Axle Serial Number
Right Hub / Left hub
Date code on hub
Bus VIN.



Your service supervisor will need to contact the person below to obtain return instructions of the hubs.

Matt Douglas
Customer Quality Engineer

ZF Gainesville, LLC
1925 New Harvest Road, SW
Gainesville, Georgia 30507, USA

Phone +1 770 297-4217 Fax +1 770-297-4021
matt.douglas@zf.com

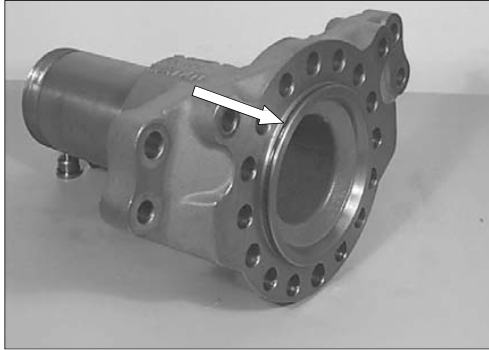

5. Reassembly of hub carrier

Take a new wheel head carrier from stock

Lubricate the O-ring (see arrow) and insert it into the annular groove on the hub carrier.

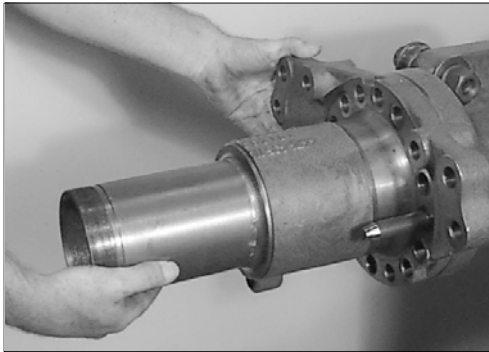

Slide the replacement wheel head carrier on to the locations pins (5870.204.029) as shown.

Fix wheel head carrier with cylindrical screws and washers making sure not to trap the o'ring.

Tightening torque (M18x1.5/10.9) $M_A = 440 \text{ N/m}$
 $= 325 \text{ lb.ft.}$

Note: Ensure correct installation position.

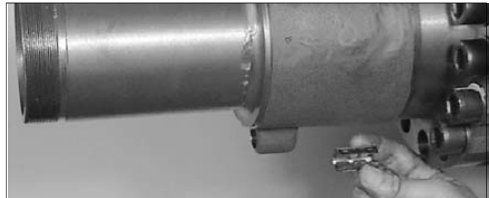

Reinstalling the ABS sensor assembly

Re-install ABS Sensor bushing into the hole on the hub carrier.



Re-install the ABS sensor by pushing the sensor in until it stops.

The sensor depth is set when the wheel head is fitted so cannot be incorrect unless it is not pushed all the way in at this stage.

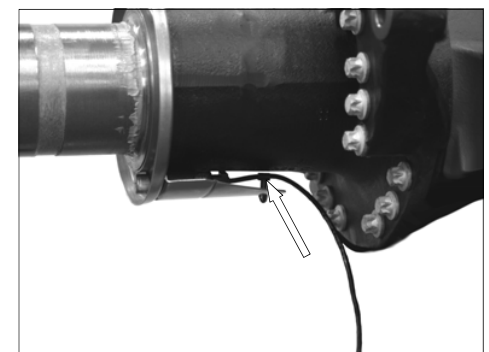

Refitting the Screen Sheet

Refit the original screen sheet or replace with a new item if old one was damaged during dis-assembly. This can be fitted by lightly tapping it on with a small hammer and soft punch until the shoulder is seated.



Note: Ensure that the ABS sensor wiring route is correct at this point.

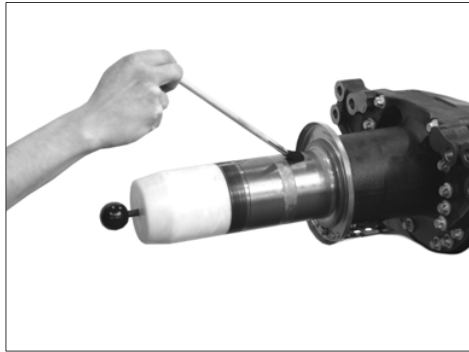

6. Reassembly of hub

Correct procedure for mounting wheel head Inc. Greasing

Insert assembly aid (5870.651.085) in to the hub carrier.

Note: To prevent hydro locking the wheel head at assembly the following procedure must be adhered to.

Over greasing the axle tube will create this issue!

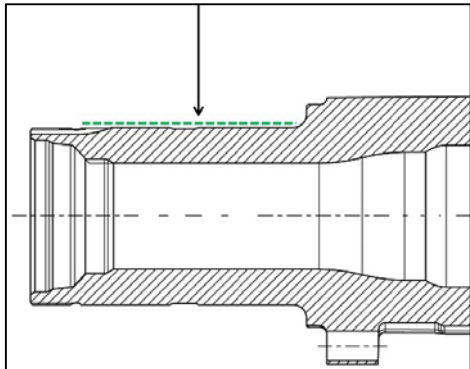

Greasing Procedure

Grease only on the area shown at the point of the arrow.

Note: the grease is used to provide a corrosion resistance coating only.

Grease must conform to the ZF **TE-ML 12** Approved list of lubricants

Do Not Over Grease!!!

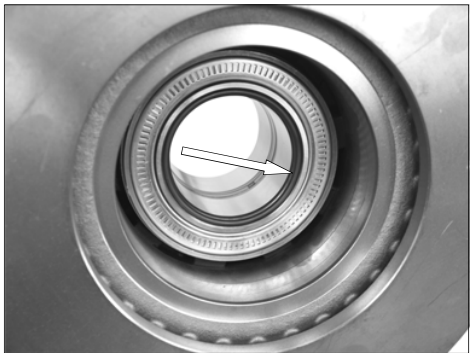

Re-fitting the wheel head

Remove o'ring from compact bearing annular groove.

Lightly lubricate the O-ring and re- insert it into the annular groove (see arrow). This is the inner side of the rotor.

Note: Try and prevent any grease getting on the rotor, so as not to contaminate the brake pads.



Carefully mount the preassembled hub to the hub carrier using a safe method of working or by means of the load carrying fixture supplied (5870.281.043) until contact is obtained.

Screw on inner slotted nut with the chamfer facing towards you and again using the slotted nut wrench (5870.401.146) Pre-tighten the inner slotted nut to a torque of:
Torque $M_A = 100 \text{ N/m} = 74 \text{ lb.ft.}$

This will effectively push the ABS sensor into the correct position (expect a grinding noise). Rotate the hub several times in each direction and using a rubber mallet strike the rotor every half turn to seat the compact bearing o'ring.

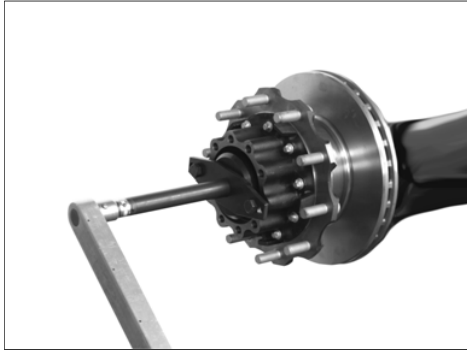

Final torque for inner slotted nut

Again using the slotted nut wrench (5870.401.146)
Tightening the inner slotted nut to the specified torque:

Torque (Inner Slotted nut) $M_A = 850 \text{ N/m} = 627 \text{ lb.ft.}$

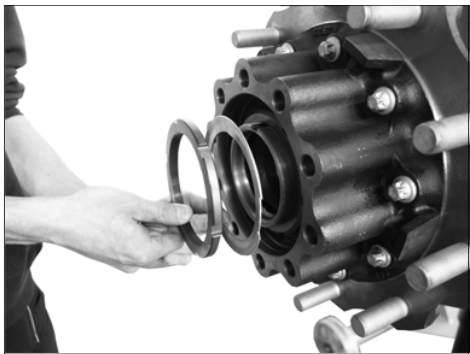

Mount locking plate with the tab facing towards the differential.

With the chamfer also facing towards the differential, screw the outer slotted nut up to the lock plate and torque.

Torque (outer slotted nut) $M_A = 1200 \text{ N/m} = 885 \text{ lb.ft.}$

Note: Ensure correct installation position. Also see legend below for exact slotted nut and lock plate orientation.

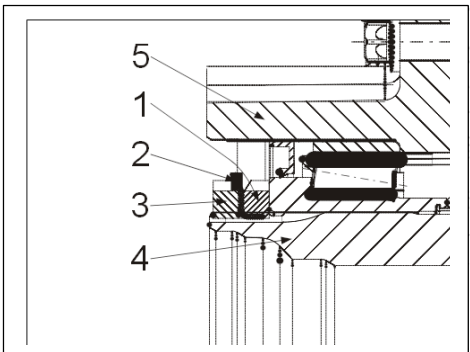

👉 Legend:

- 1 = Inner slotted nut
- 2 = Locking plate
- 3 = Outer slotted nut
- 4 = Hub carrier
- 5 = Hub



Secure slotted nut by Staking the locking plate into any of the slots of the outer slotted nut, taking care not to damage the mating surface of the wheel end, where the flange shaft o'ring is seated!

👉 **Note:** This is absolutely critical and must deform the lock plate enough to stop the outer slotted nut from spinning should the tightening torque be lost!

👉 **Note:** You **MUST** torque seal (shown with YELLOW paint) over the outer slotted nut onto the end of the hub casting so that any movement during service can be viewed on inspection.

Lubricate the chamfer on the wheel end to assist the insertion of the flange shaft.



Re-installing the flange shaft

Lubricate the O-ring (see arrow) and insert it into the annular groove of the flange shaft.

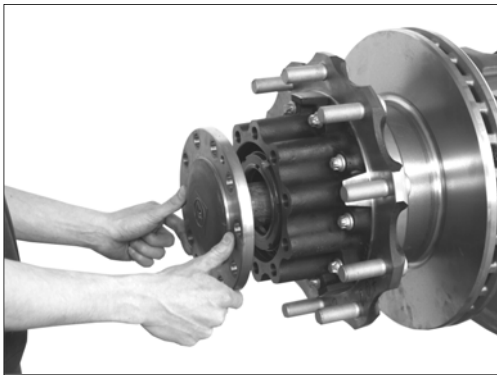

Insert the flange shaft into the hub carrier and gently locate the differential splines.

Push the flange up to the wheel end.

Insert 2 x screws and slowly pull the flange into the wheel head to prevent trapping the o'ring.

Fit remaining screws and torque to:

Tightening torque (M18x1.5) $M_A = 440 \text{ N/m} = 325 \text{ lb.ft}$



7. Reassemble brake and brake cylinder

Mount brake caliper assembly to axle.

The Fitted screw must be nipped tight before torqueing begins.

Tightening torque (M16x1.5/10.9) $M_A = 270 \text{ N/m}$
 $= 199 \text{ lb.ft.}$

Tightening torque (fit bolt M16x1.5) $M_A = 270 \text{ N/m}$
 $= 199 \text{ lb.ft.}$

Tightening up Caliper carrier bolts

The use of torque adaptors has been recognized as the best method to torque the caliper carrier bolts on certain applications.

Torque conversions must be calculated when extending the length of your torque bar, and torquing should be carried out in one smooth movement without vigorous effort to prevent inaccuracies.

Use this web page for torque calculations:

www.motorcraftservice.com/renderers/torquewrench/wrench_formula_main_en.asp

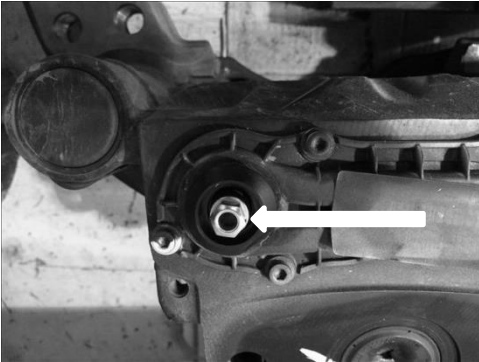

Adjusting the brake using a short 10mm wrench

While spinning the rotor adjust the brake in a clockwise direction until the rotor is no longer able to spin.

Back off adjuster 3 clicks and the clearance is set.

Note: The caliper adjuster incorporates a sintered shear adapter to prevent damage to the adjuster over tightening will cause the adaptor to fail, replacements are available, please leave a functioning adaptor in place.



Refitting the wear indicator

Where relevant refit the connectors to the caliper to prevent electrical errors.

This procedure is the reverse of dis-assembly.

Refit the brake cylinder and torque the 2 x 24mm lock nuts to $M_A = 190 \text{ N/m}$
 $= 140 \text{ lb.ft.}$



Recommendation

The Use lifting cart has been recognized as good method of lifting the parts on and off for safe working practice.



8. Refilling with the saved oil

Take the saved oil in the clean container and refill the axle

Carry out a short test drive and re-check oil level.

If a top up of oil is required only use oils from the **ZF approved list of lubricants TE-ML 12.**

Adjust oil level accordingly

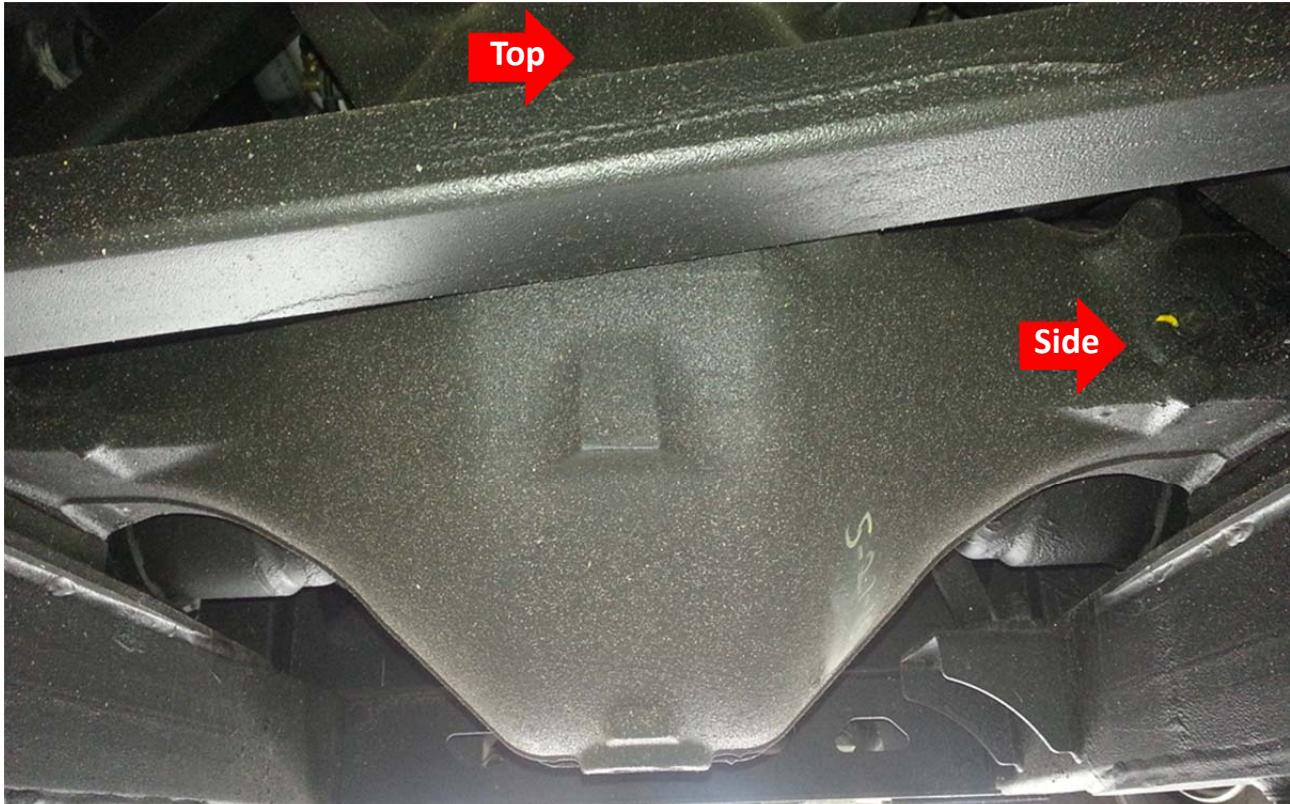

Remove top and side plugs and then fill oil through top until it drains outside hole.

9. Mark completion date on frame

