

SECTION 5 OTHER FEATURES

EXHAUST AFTERTREATMENT SYSTEM	2
FILTRATION AND REGENERATION UNIT.....	2
SELECTIVE CATALYTIC REDUCTION UNIT.....	4
DRIVER INFORMATION DISPLAY (DID) MENUS	9
« GAUGES » MENU.....	10
« FUEL DATA » MENU.....	11
« TIME/DISTANCE » MENU.....	12
« PREVOST LIAISON (OPTION) » MENU.....	12
« VEHICLE MESSAGES » MENU.....	13
« DIAGNOSTICS » MENU.....	14
« PRE-TRIP ASSISTANCE (OPTION) » MENU.....	16
« DATA LOG » MENU.....	17
« AFTERTREATMENT » MENU.....	18
« PASSWORD » MENU.....	19
TRANSMISSION RETARDER	19
ENGINE BRAKE	20
EXHAUST BRAKE.....	20
VOLVO ENGINE BRAKE (VEB).....	20
ENGINE BRAKE – AUTO MODE (A) (WITH I-SHIFT TRANSMISSION ONLY).....	21
ANTILOCK BRAKING SYSTEM (ABS), TRACTION CONTROL SYSTEM (TCS) & ELECTRONIC STABILITY CONTROL (ESC) 21	
ANTILOCK BRAKING SYSTEM (ABS).....	21
TRACTION CONTROL SYSTEM (TCS).....	21
ELECTRONIC STABILITY CONTROL (ESC).....	22
DCDL DRIVER CONTROLLED DIFFERENTIAL LOCK (OPTIONAL).....	22
OPERATION TIPS.....	22
LOCKING THE DCDL.....	23
UNLOCKING THE DCDL.....	23
KNEELING SYSTEM	23
HI-BUOY	23
LOW-BUOY	24
RETRACTABLE TAG AXLE	24
IN-STATION LIGHTING	24
COOLANT HEATER	24
SWITCHING THE HEATER ON.....	25
SWITCHING THE HEATER OFF.....	25
COOLANT HEATER TIMER.....	25
TROUBLESHOOTING AND MAINTENANCE.....	27
WHEELCHAIR LIFT	27
WHEELCHAIR LIFT AND ACCESS DOORS.....	27
OPERATING THE WHEELCHAIR LIFT.....	28
THRESHOLD WARNING SYSTEM (TWS) ADJUSTMENT.....	29
EMERGENCY OPERATION.....	30
WHEELCHAIR LIFT REMOVAL FOR STORING OR MAINTENANCE PURPOSES.....	32
WHEELCHAIR LIFT INSTALLATION.....	33
INTERIOR APPOINTMENTS.....	33
WHEELCHAIR RESTRAINT SYSTEMS	34
4-POINT SECUREMENT WITH FLOOR ANCHORAGE.....	34

5-2 OTHER FEATURES

4-POINT SECUREMENT WITH ANCHORAGE TO PASSENGERS SEAT PEDESTALS 35

EXHAUST AFTERTREATMENT SYSTEM

The exhaust aftertreatment system consists of two units, the filtration and regeneration unit and the selective catalytic reduction SCR unit.

FILTRATION AND REGENERATION UNIT

The main purpose of the filtration and regeneration unit is to capture and oxidize (regenerate) the particulate matter (soot) in the engine exhaust gas. The exhaust gas first enters the Diesel Oxidation Catalyst (DOC) and then flow through the Diesel Particulate Filter (DPF); together they capture and regenerate the soot on a regular or passive basis. Through constant monitoring of the exhaust gas temperature and the system back pressure, the engine control module is able to manage regeneration.

Passive regeneration

Passive regeneration is the process by which the particulate matter is oxidized due to the heat generated by the engine internal combustion process. During normal highway operation, exhaust temperatures alone are usually high enough to oxidize accumulating soot. In low ambient temperatures, however, or in some stop-and-go applications, the system needs a little help to regenerate, or clean itself. This process is called "active" regeneration.

Active regeneration







Active regeneration is necessary when the engine internal combustion process alone does not generate enough heat. A dosing system injects a mist of diesel fuel into the exhaust system to increase and maintain the aftertreatment system temperature. Exhaust temperature must be above 572°F (300°C) to initiate the oxidation catalyst, which in turn oxidizes the injected diesel fuel molecules to achieve up to 1200°F (650°C) exhaust temperature at the particulate filter. This process of active regeneration takes place during the normal operation cycle of the vehicle without charges in performance or control for the operator. EPA2010 compliant Volvo engines produce less soot, so less active or stationary regeneration will be required.

Stationary (parked) regeneration

In a small number of specific engine duty cycles, engine control module may not be capable of completing an active regeneration. In these situations, the operator will be notified that a stationary or parked regeneration may be required. A DPF telltale light will illuminate indicating the need for user interaction. The lamp gives the operator a grace period to allow this process to take place at a time when most convenient for the operator. This process requires the vehicle to be parked while a driver or maintenance technician initiates the regeneration process using the DID menus. Once initiated, the stationary regeneration process will be complete in about 45 minutes.

The driver will be notified of the need for a stationary regeneration (parked) by illumination of the DPF REGENERATION telltale light.

Diesel particulate filter clogging sequence – Instrument cluster telltale light

<p>LEVEL 1</p>	 solid	<p>REGENERATION NEEDED</p> <p>Diesel particulate filter is becoming full</p> <p>The DPF REGENERATION telltale light illuminates to notify the driver that a stationary regeneration (parked) will be required soon. When this lamp is lit, initiate stationary regeneration process at an appropriate time of day. THERE IS NO URGENCY AT THIS LEVEL.</p>
<p>LEVEL 2</p>	 flashing	<p>REGENERATION REQUIRED</p> <p>Diesel particulate filter full</p> <p>If no DPF regeneration occurs after the initial DPF REGENERATION telltale light illumination, the lamp will begin blinking and a stationary regeneration should be initiated as soon as possible in order to prevent from entering into Level 3.</p>
<p>LEVEL 3</p>	 flashing + 	<p>ATD SERVICE REQUIRED</p> <p>ENGINE DERATE ACTIVE</p> <p>Diesel particulate filter overfull</p> <p>If the flashing DPF REGENERATION telltale light is still ignored, the CHECK telltale light will illuminate. In that situation, engine performance is limited. Perform a parked regeneration IMMEDIATELY to avoid further derate and prevent from entering into Level 4.</p>
<p>LEVEL 4</p>	 flashing +  + 	<p>ATD SERVICE REQUIRED</p> <p>ENGINE SHUTDOWN ACTIVE</p> <p>A serious engine problem has occurred. The DPF may be over its maximum capacity.</p> <p>If a stationary regeneration is still not initiated, a standard Engine Protection Shutdown sequence will occur. All of the following dashboard lamps will be present:</p> <p>Blinking DPF REGENERATION telltale light; Solid CHECK telltale light; Solid STOP telltale light.</p> <p>Once engine derate and/or shutdown sequence is completed, a stationary regeneration must occur to continue vehicle operation. If the driver continues to operate the vehicle without regeneration, additional measures will be taken to protect the engine and ATD from damage, up to and including engine shutdown. Parked regeneration might no longer be possible.</p> <p>If engine protection has been initiated and forces the engine to shutdown, you CAN immediately re-start the engine and perform the necessary steps in order to initiate a stationary regeneration.</p>

5-4 OTHER FEATURES

Initiating a Stationary (Parked) Regeneration

NOTE

At starting of the engine, if a stationary regeneration is required, the engine coolant temperature must reach 140°F (60°C) before any stationary regeneration may be initiated and completed. Permit the engine to idle for a short while or drive the vehicle until engine temperature increases sufficiently.



WARNING

Do not initiate a stationary regeneration in a closed area like a garage. Stationary regenerations must be undertaken outdoors only.



WARNING

During stationary regeneration, exhaust temperature may reach up to 1200°F (650°C) at the particulate filter. Before initiating stationary regeneration, make sure that the DPF outlet diffuser is clear of objects and that no one is working near the DPF outlet diffuser.



WARNING

Hot surfaces. Keep yourself clear of all hot Aftertreatment Device components, particularly during and after active or stationary regeneration. Hot surfaces can cause serious burns.

NOTE

STATIONARY REGENERATION

This process requires the vehicle to be parked while the driver or a maintenance technician initiates the regeneration process.

The DPF REGENERATION telltale light illuminates to notify the driver of the need and urgency of a manual stationary regeneration.



DPF REGENERATION telltale light

If stationary regeneration is not performed, this telltale light will blink, indicating that a stationary regeneration is required immediately. If stationary regeneration is still not performed,

“engine power derate and shutdown” sequence may occur as per level 1 to level 4 sequence.

To initiate a stationary regeneration:

- Park the vehicle in a clear area, vehicle speed must be 0 mph (0 km/h);
- Engine must be on normal idle and fully warmed up (coolant temperature above 140°F/60°C);
- Apply parking brakes and set the transmission to neutral (N).
- Press the DID ENTER button and then get to the DID Aftertreatment menu. Select sub-menu Request Parked REGEN and press ENTER button to confirm and initiate regeneration.

The regeneration will begin. Turn off the air conditioning to reduce engine load. The engine idling speed will increase to 1600 rpm. Once the regeneration is completed, the engine speed will return to normal idle.

Voluntary Interruption of a Stationary Regeneration

It is possible to interrupt a stationary regeneration at all time. To do so, set the ignition key to the OFF position or get to the DID's Aftertreatment menu, select Cancel REGEN and press ENTER button to confirm. You can stop regeneration simply by releasing the parking brake. Use this procedure in order to move the vehicle in a safe area.

If regeneration is interrupted, it is very important to reinitiate the regeneration as soon as possible.

SELECTIVE CATALYTIC REDUCTION UNIT

Selective Catalytic Reduction (SCR) is a technology that uses Diesel Exhaust Fluid (DEF) and a catalytic converter to reduce nitrogen oxides (NOx) emissions.

SCR is an exhaust aftertreatment system that injects small amount of DEF into the exhaust gas between the DPF and the selective reduction catalytic converter. DEF turns to ammonia and carbon dioxide when heated. The exhaust stream then passes over a catalyst, the ammonia reacts with the NOx to form nitrogen and water vapor.

The basic elements of the SCR system consist of a 15.9 gallons (60 liters) DEF tank complete with pump, lines and heating system, a dosing

injector, a catalytic converter and the control and monitoring system.

Diesel exhaust fluid DEF

When handling DEF solution, it is important that electrical connectors to be connected or well encapsulated, otherwise there is a risk that the DEF will cause oxidation that cannot be removed. Water or compressed air will not help, since DEF quickly oxidizes certain metals. If a disconnected connector comes into contact with the DEF solution, it must be replaced immediately to prevent the DEF solution from creeping further into the copper wiring, which takes place at a speed of about 2.4 in (60 mm) per hour.



CAUTION

Diesel Exhaust Fluid (DEF) is a nontoxic aqueous solution of urea (32.5%) and ultra-pure water (67.5%). Urea is a compound of nitrogen that turns to ammonia when heated. The fluid is non flammable, and is not dangerous when handled as recommended. However, it is highly corrosive to certain metals, especially copper and brass.

When detaching hoses and components, do not spill DEF on disconnected or unsealed connectors. If DEF is spilled on a disconnected or unsealed connector, the connector must be removed immediately and replaced.

Things to know about spilt diesel exhaust fluid (DEF):

- If urea solution comes into contact with the skin, rinse with plenty of water and remove contaminated clothing.
- If urea solution comes into contact with the eyes rinse for several minutes and call for medical help if necessary.
- If inhaled breathe fresh air and call for medical help if necessary.
- Do not allow the DEF solution to come into contact with other chemicals.
- The DEF solution is not flammable. If the DEF solution is exposed to high temperatures, it breaks down into ammonia and carbon dioxide.

- The DEF solution is highly corrosive to certain metals, including copper and aluminum.
- If the DEF solution is spilled onto the vehicle, wipe off the excess and rinse with water. Spilled DEF solution can form concentrated white crystals on the vehicle. Rinse off these crystals with water.



WARNING

DEF spilt onto hot components will quickly vaporize. Turn your face away!

Diesel Exhaust Fluid (DEF) Consumption









DEF consumption is related to fuel consumption. In order to meet EPA requirements, DEF tanks are sized so one refill will be necessary every two refill of the fuel tank.

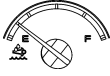

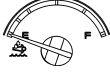

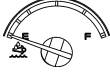
Selective catalytic reduction – Driver warning and inducement

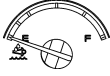
SCR system components must not be removed, altered or modified in any way. In order to protect the SCR system from tampering, inducement measures will occur if the following states are detected:





- Disconnection of DEF tank level sensor
- Blocked DEF line or dosing valve
- Disconnection of DEF dosing valve
- Disconnection of DEF pump
- Disconnection of SCR wiring harness
- Disconnection of NOx sensor
- Disconnected exhaust temperature sensor
- Disconnected DEF temperature sensor
- Disconnected DEF quality sensor

5-6 OTHER FEATURES

DEF TANK LEVEL DRIVER WARNING AND INDUCEMENT				
Conditions / Triggers		DEF Tank LOW LEVEL Indicator, DID Message and audible warning		Inducement
1	Normal DEF tank level sensor reads between 100% and 12%	None		None
2	Low DEF tank warning DEF tank level sensor reads between 12% and 0.1% 	 solid	DEF TANK LEVEL LOW REFILL DEF SOON TO PREVENT ENGINE DERATE  3 beeps	Warning message
3	DEF tank near empty DEF tank level sensor reads less than 0.1% 	 blinking	DEF TANK EMPTY REFILL DEF TO AVOID 5 MPH LIMIT ENGINE IN DERATE  3 beeps	Engine torque reduction of 25%
4	DEF tank empty and one (1) hour of operation in engine derate mode 	 blinking	DEF TANK EMPTY REFILL DEF TO AVOID 5 MPH LIMIT ENGINE IN DERATE  3 beeps	Engine torque reduction of 40%
5	DEF tank empty and either <ol style="list-style-type: none"> Diesel fuel refueling done with a fuel level sensor reading increase of 15%, or more Vehicle stationary (speed=0) for 20 minutes with engine off or at idle 	 blinking	REFILL DEF TANK VEHICLE SPEED LIMITED TO 5 MPH (8 KM/H)  constant tone	Vehicle road speed limited (RSL) to 5 mph (8 km/h) <i>Note: The vehicle has to be stationary before 5 mph (8 km/h) road speed limit becomes active</i>

DEF QUALITY DRIVER WARNING AND INDUCEMENT				
Conditions / Triggers		Amber Warning Light & Did Message And Audible Warning		Inducement
1	Good DEF quality	None		None
2	Poor DEF quality detected		POOR DEF QUALITY DETECTED	Warning message
3	Poor DEF quality detected	<input type="checkbox"/> CHECK solid	POOR DEF QUALITY DETECTED ENGINE WILL DERATE IN < XXX MINS  3 beeps	Warning message
4	Poor DEF quality detected and one (1) hour of operation with active diagnostic troubleshooting code	<input type="checkbox"/> CHECK solid	POOR DEF QUALITY DETECTED ENGINE IN DERATE 5 MPH (8KM/H) LIMIT IN < XXX MINS  3 beeps	Engine torque reduction of 25%
5	Poor DEF quality detected and four (4) hours of operation with active diagnostic troubleshooting code	<input type="checkbox"/> CHECK solid	SERVICE DEF 5 MPH (8KM/H) LIMIT NEXT VEHICLE STOP  3 beeps	Engine torque reduction of 40%
6	Diesel fuel refueling done with a fuel level sensor increase of 15% or more and Vehicle stationary (speed=0) for 20 minutes with engine off or at idle	<input type="checkbox"/> CHECK solid	SERVICE DEF VEHICLE SPEED LIMITED TO 5 MPH (8 KM/H)  constant tone	Vehicle road speed limited (RSL) to 5 mph (8 km/h) <i>Note: The vehicle has to be stationary before 5 mph (8 km/h) road speed limit becomes active</i>

5-8 OTHER FEATURES

SCR SYSTEM TAMPERING DRIVER WARNING AND INDUCEMENT				
Conditions / Triggers		Amber Warning Light, Did Message And Audible Warning		Inducement
1	Normal No diagnostic troubleshooting code active	None		None
2	SCR system tampering diagnostic troubleshooting code confirmed	<input type="checkbox"/> CHECK solid	SCR SYSTEM FAULT ENGINE WILL DERATE IN < XXX MINS  constant tone	Warning message
3	Reached one (1) hour of operation with active SCR system tampering diagnostic troubleshooting code confirmed	<input type="checkbox"/> CHECK solid	SCR SYSTEM FAULT ENGINE IN DERATE 5 MPH (8KM/H) LIMIT IN < XXX MINS  constant tone	Engine torque reduction of 25%
4	Reached four (4) hours of operation with active SCR system tampering diagnostic troubleshooting code confirmed	<input type="checkbox"/> CHECK solid	SCR SYSTEM FAULT REPAIR NEEDED 5 MPH (8KM/H) LIMIT NEXT VEHICLE STOP  constant tone	Engine torque reduction of 40%
5	Diesel fuel refueling done with a fuel level sensor increase of 15% or more	<input type="checkbox"/> CHECK solid	SCR SYSTEM FAULT VEHICLE SPEED LIMITED TO 5 MPH (8 KM/H)  constant tone	Vehicle road speed limited (RSL) to 5 mph (8 km/h)

DRIVER INFORMATION DISPLAY (DID) MENUS

There are Driving and Non-Driving menus. Several sub-menus are password-protected while the vehicle is parked. The Non-Driving menu is accessible only when the vehicle is parked.

DRIVING MODE MENUS	NON-DRIVING/STATIONARY MODE MENUS
Gauges <ol style="list-style-type: none"> 1. Current Gear Position (I-Shift) 2. Outside Temperature 3. Engine Oil Temperature 4. Transmission Fluid Temperature 5. Prevost Liaison Compass 6. Accessories Air Pressure 7. A/C Compressor Pressure 8. Battery Voltage 9. Allison Transmission Oil Life 10. Battery State Of Charge 	Display Settings <ol style="list-style-type: none"> 1. Language 2. Units 3. Time/Date 4. Favorite Display Setting 5. Display Light 6. Change Password
Fuel Data <ol style="list-style-type: none"> 1. Fuel Flow / ECO % 2. Trip Fuel Used 3. Distance to Empty 	Diagnostics <ol style="list-style-type: none"> 1. View Active Faults 2. View Inactive Faults 3. Cluster Self Test 4. Part Number 5. Reset Inactive Faults 6. Vehicle Tests
Time-Distance <ol style="list-style-type: none"> 1. Time and Date 2. Alarm Clock 3. Trip Odometer 1 and 2 4. Average Trip Speed 5. Estimated Time of Arrival (ETA) 	Pre-Trip Assistance <ol style="list-style-type: none"> 1. Exterior Light Inspection 2. Air Leakage Monitor
Prevost Liaison <ol style="list-style-type: none"> 1. Read Message 2. Send Message 3. Other Info 	Datalog <ol style="list-style-type: none"> 1. Vehicle ID 2. Total Data 3. Trip Data 4. Reset Trip Data
Vehicle Messages	Aftertreatment <ol style="list-style-type: none"> 1. Request Parked REGEN 2. ATS Status 3. Cancel REGEN
Reset Trip Data	Password <ol style="list-style-type: none"> 1. Enter Password

5-10 OTHER FEATURES

« GAUGES » MENU

There are several gauges in this menu. The gauges are used to view current status of important functions in the vehicle.

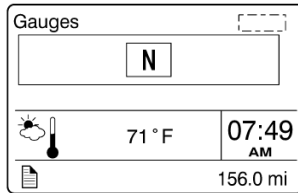

1. Current Gear Position (I-Shift transmission only)

Indicates the current gear position selected on the I-Shift transmission.

D= drive

N= neutral

R= reverse

M= manual

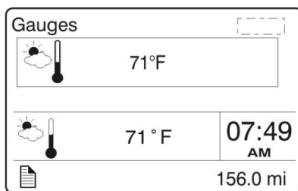

2. Outside Temperature

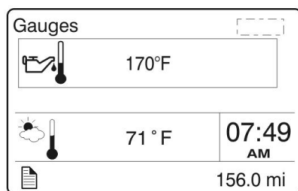

3. Engine Oil Temperature

Selecting this gauge will display the engine oil temperature.

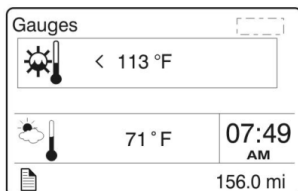

4. Transmission Fluid Temperature

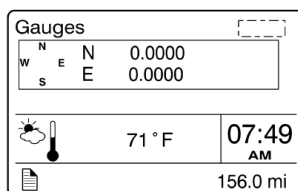

5. Prevost Liaison Compass

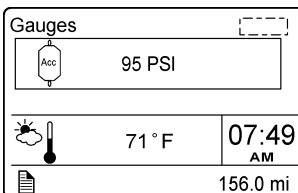

6. Accessories Air Pressure

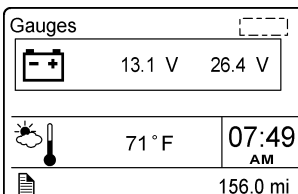

7. Battery Voltage

Displays current 12-volts and 24-volts system voltage.

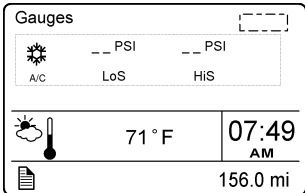

8. A/C Compressor Pressure

Displays the A/C compressor suction pressure value (LoS=low side) and discharge pressure value (HiS=high side).

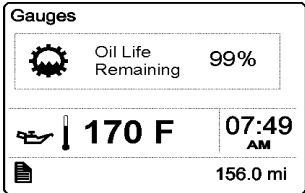

9. Allison Transmission Oil Life

Displays the percentage of the calculated remaining life of the transmission oil. New oil is displayed as 99%. Refer to Appendix C for more details.

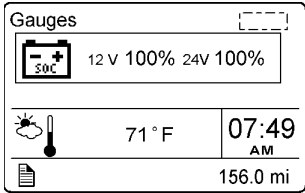

10. Battery State Of Charge

When equipped with PRIME option, displays the state of charge of the 12-volt and 24-volt battery banks.

« FUEL DATA » MENU

The Fuel Data menu provides information on the fuel consumption of the vehicle in various situations. For example, how much fuel has been used, how much fuel is remaining before refueling the vehicle.

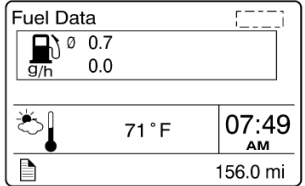

1. Fuel Flow (gph)

The lower numerical value indicates the instantaneous fuel consumption. In this menu, you can reset the upper numerical value which is the average fuel consumption. To reset, hold ENTER button for 1 second.

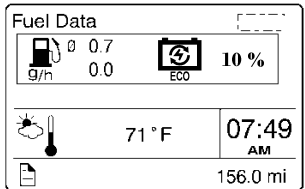

When equipped with PRIME option, the percentage of trip made on regenerated electricity is also displayed.

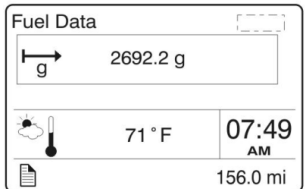

2. Trip Fuel Used

Indicates the total fuel consumption (gallons/liters) since the last reset. Note: You should use Reset function before each new trip.

You can reset the fuel consumption value in this menu. To reset, hold ENTER button for 1 second.

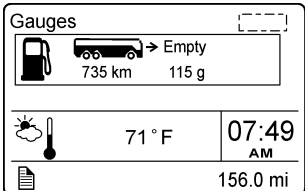

3. Distance to Empty

The left numerical value indicates the distance that can be traveled with the quantity of fuel that remains in the tank as indicated by the right numerical value.

5-12 OTHER FEATURES

« TIME/DISTANCE » MENU

The time and date can be set in the Time/Distance menu. The alarm clock can also be set from this menu. Following the alarm clock menu is the Trip Odometer 1 and 2 selection, which allows the operator to see the distance travelled since the last reset. Average trip speed is also shown. By specifying the distance to your destination, the vehicle can calculate the estimated time of arrival (ETA).

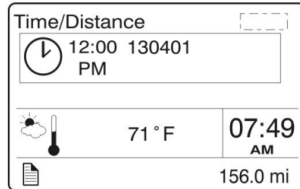

1. Time And Date

Adjust time and date with this menu. The instrument cluster has its own internal battery, so the date and date setting is keep in memory even if the vehicle's battery is disconnected.

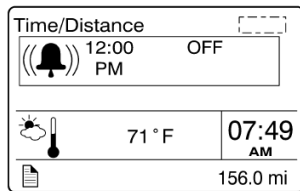

2. Alarm Clock

Use this function to program and activate an alarm on the instrument cluster clock. When the alarm clock goes off, a warning signal is sounded. The alarm shuts off after 60 seconds or if the ESCAPE button is depressed.

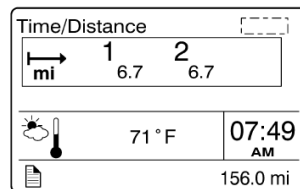

3. Trip Odometer 1 and 2

Allows the operator to see the distance travelled since the last reset. You can reset the trip odometer 1 or 2 in this menu. To reset, depress ENTER button, use UP/DOWN button to select between odometer 1 or 2 and then hold ENTER button for 1 second.

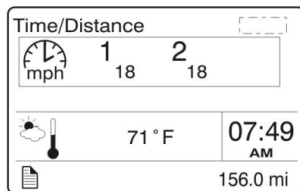

4. Average Trip Speed

This function displays the average speed for the current travel. The average trip speed is calculated as the distance traveled divided by the time the engine has been running (since the last reset). Two average trip speeds can be measured, corresponding to leg 1 and leg 2. Use Reset function before each new travel to start new measurements.

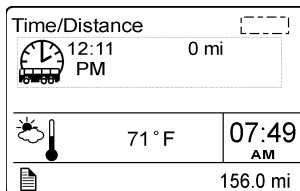

5. Estimated Time of Arrival (ETA)

This function will display the estimated time of arrival if the distance to be traveled is entered first, in this menu. To set distance to be traveled, press ENTER and enter the distance left to drive in mile or km using ENTER and UP/DOWN buttons.

« PREVOST LIAISON (option) » MENU

The Prevost Liaison system provides cellular communication between the driver and the fleet operator. The driver can send and receive short text messages, which are visible through the Driver Information Display.

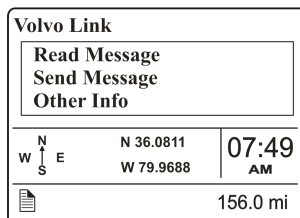

The following menus are available:

1. Read Message

- Quick Response (only available if there is a message available)

2. Send Message

- Driver & Equipment
- Dispatch Messages
- Free Text

3. Other Info

- Comm Liaison Info
- Mailbox Info
- GPS Info
- INI Info
- Configuration Info

« VEHICLE MESSAGES » MENU

Use this function to consult the vehicle active messages that were previously displayed as pop-up messages and then acknowledged. When consulting a message, the corresponding STOP, CHECK or INFORMATION warning light will illuminate. Scroll through the messages using the up/down button. Press ESC button to return to main menu.

« RESET TRIP DATA » MENU

When the Reset Trip Data menu is open, pressing and holding down the Enter button for 1 second resets the functions listed below. This function will permit to the system to calculate new value from the point of resetting.

- Fuel Flow
- Trip Fuel Used
- Average Trip Speed

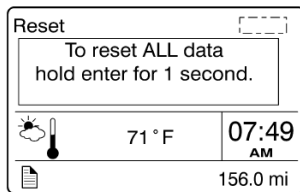

« DISPLAY SETTINGS » MENU

The Display Settings menu is used to change languages and units. The password, time and date can also be changed. The backlight and contrast of the display screen can be adjusted.

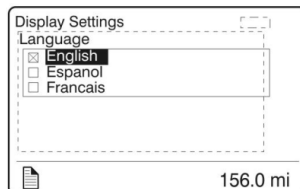

1. Language

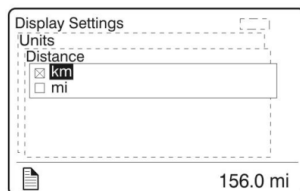

2. Units

Use this function to select desired unit formats for:

- Distance (miles or km);
- Fuel consumption (km/l, l/100km, mpg US or IMP);
- Temperature (°C or °F).

5-14 OTHER FEATURES

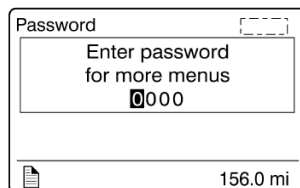
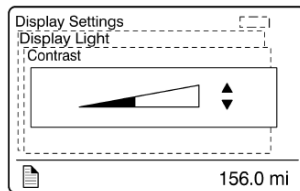
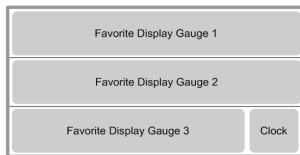
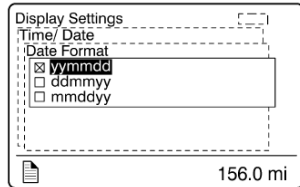
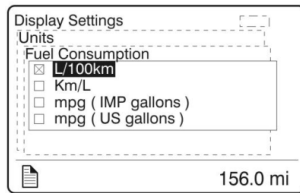

3. Time/Date

Select the time and date format (am, pm, 24h) using this function.

4. Favorite Display Setting

Use this menu to select your favorite display gauges 1, 2 and 3 and replace the default gauges. On vehicles provided with the I-Shift transmission, Favorite Display Gauge 3 cannot be edited as it is kept for display of the transmission status.

Example: You wish to display the engine oil temperature at the Gauge 1 position.

1. Use UP/DOWN button until Gauge 1 position is selected.
2. Press ENTER button to confirm.

Use UP/DOWN button to scroll through the available gauges. When the engine oil temperature gauge is displayed, press ENTER button to confirm (repeat steps 1-3 to change Gauge 2 and Gauge 3 if needed).

5. Display Light

The Display Light menu has three sub-menus:

• Contrast

Adjust the contrast with the UP/DOWN button and press ENTER button to confirm.

• Backlight

In this menu, the display lighting can be adjusted relative to other instrument lighting with the UP/DOWN button.

• Night/Day

Use the Night/Day menu to choose a dark background with light text and images or a light background with dark text and images. Press ENTER button to toggle between Night and Day.

6. Change Password

Use this menu to change the current password. This menu is only accessible if the correct password is entered. The default password is 0000.

1. Mark which password is to be changed with the display UP/DOWN button.
2. Confirm with ENTER button.
3. Set the first digit with the UP/DOWN button.
4. Step to the next digit using ENTER button.
5. Step backwards with ESC button.

« DIAGNOSTICS » MENU

The Diagnostics menu enables fault tracing on the control units in the vehicle to check for faults.

Instrument tests are available to check the telltales, gauges, display and speaker. The part number of a control unit can be identified in the part number menu.

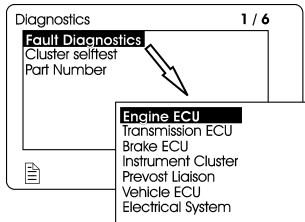

1. View Active Fault

A list of the control units on the vehicle is displayed. Use this function to check for active faults on specific control units.

2. View Inactive Fault

Use this function to check for inactive faults on specific control units.

3. Cluster Selftest

Use this menu to check proper functioning of the following components:

- Telltale lights
- Analog gauges
- Display
- Speakers

The following table describes the available tests. To cancel a test, press the ESC button).

Telltale lights test	Telltales illuminate for approximately five seconds. Press the Esc button to cancel the test.
Analog gauges	The indicators move forwards and backwards between the end positions. They do not show any particular value. This is just a check to confirm that the indicators move, and to make sure the operators are working. Press the Esc button to cancel the test.
Display test	The entire display lights up until the Esc button is pressed.
Speaker Test	A sound is emitted through the speakers. Press the Esc button to cancel the test.

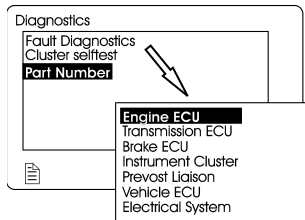

4. Part Number

A list of the control units on the vehicle with their part numbers is displayed in the Part Number menu.

5. Reset Inactive Faults

Use this menu to delete an inactive fault for a particular control unit. Note: it is not possible to delete inactive faults of the Engine ECU.

6. Vehicle Test

Use this menu to perform tests on several components and systems:

- dashboard switches (Mux Input Test)
- electric motors, valve and pump contactors (Motor Test Sequence)

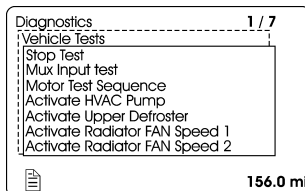

In case of overheating of the engine due to a malfunction of the radiator fan clutch control, you can force activation of the fan clutch using ACTIVATE RADIATOR FAN SPEED 1, SPEED 2.

The DID status line will show TEST to confirm that one of the test modes is active. To cancel an active test, turn the ignition switch to the OFF position or press ESCAPE button, select STOP TEST submenu and then press ENTER

5-16 OTHER FEATURES

button twice. "TEST" will disappear from the DID status line.

For further information concerning these functions, refer to section 06: Electrical, under "Troubleshooting And Testing The Multiplex Vehicles" paragraph of the Maintenance Manual.

« PRE-TRIP ASSISTANCE (option) » MENU

The Pre-Trip Assistance option is a tool to assist the driver in completing the pre-trip inspection of the vehicle. This option is not a substitute for a complete pre-trip inspection. If any system of the vehicle does not pass inspection, the error must be corrected before operating the vehicle. The available pre-trip tests include the Exterior Light Inspection check, and the Air Leakage check.

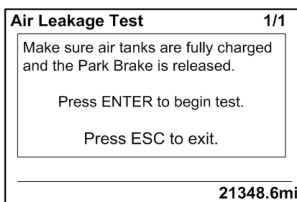
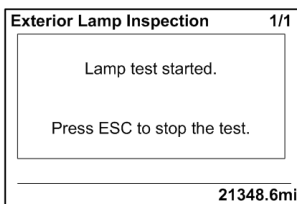
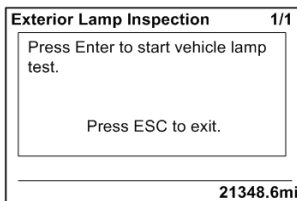
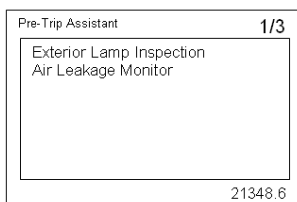

1. Exterior Light Inspection

The Exterior Light Inspection function turns on all the exterior lights simultaneously. This allows the operator to start the test, exit the vehicle and do a visual check that all exterior lights function properly. Press ESCAPE button to end the test and turn off all the exterior lights.

2. Air leakage Monitor

The Air Leakage check allows the driver to accurately measure the amount of air pressure drop in the front and rear brake air systems. After selecting this test from the DID, you are prompted to apply the service brake for 60 seconds. After applying and holding the service brake for 60 seconds, the DID will display the amount of pressure drop in the brake system.

Before starting the test through the DID, complete the following:

- Start the engine and check that the brake systems air pressure is greater than 100 psi.
- Turn engine off.
- Release the brakes and allow the system to settle (air gauge needle stops moving).
- Press the ENTER button to start the test.
- If the air tanks pressure is too low to perform the test (pressure must be greater than 100 psi), the following messages will appear.

Primary Brake Pressure < 100 psi.
Unable to perform Air Leakage Test.

Secondary Brake Pressure < 100 psi.
Unable to perform Air Leakage Test.

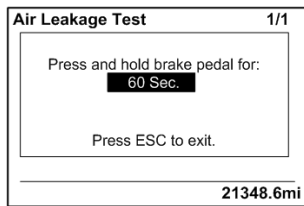

f. You must press and hold brake pedal for 60 seconds, as instructed.

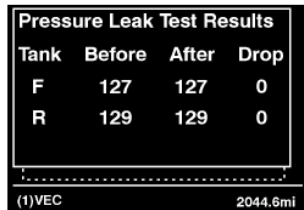

g. Once the brake pressure test is completed the pressure leak test results are displayed.

« DATA LOG » MENU

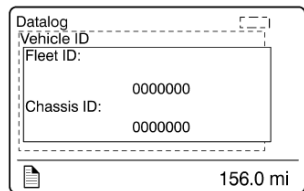

1. Vehicle ID

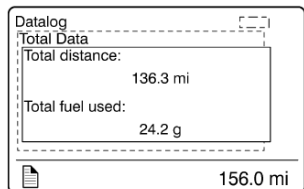

2. Total Data

Total Data menu indicates the accumulated engine values that have been logged during the lifetime of the engine ECU.

Available information:

- Total distance traveled
- Total fuel used
- Total engine hours
- Total idle time
- Total PTO hours
- total engine revolutions

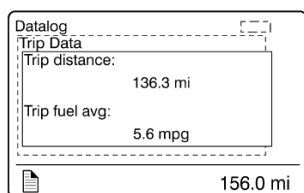

3. Trip Data

This menu displays the trip information listed below. This function must be reset before each measurement (before each new trip or leg) using the Reset Trip Data menu.

Available information for the trip or leg is:

- Trip distance (miles or km)
- Trip fuel average (mpg, liter/100km; km/liter)
- Trip fuel used (gallons or liters)
- Trip duration on cruise control (hours)
- Trip duration with engine rpm greater than economy rpm (hours)
- Trip duration while engine rpm is greater than the desire maximum rpm RPM Limit set in Fleet Limits sub-menu (hours)
- Trip fuel used with engine rpm greater than the economy rpm (gallons/liters)
- Trip average speed (mph, km/h)
- Trip duration with speed greater than the maximum desired speed as set in Fleet Limits sub-menu (hours)
- Trip engine hours

5-18 OTHER FEATURES

- Trip duration on engine idle (hours)
- Trip fuel used while in engine idle (gallons, liters)

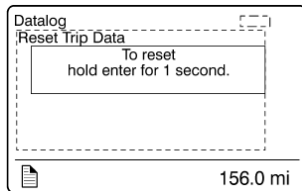

4. Reset Trip Data

This menu can only be accessed if the correct password has been entered. Use this function to reset measurements of the Trip Data menu before each new trip or leg.

« AFTERTREATMENT » MENU

This menu permits to the driver to initiate a stationary regeneration, to check the status of the aftertreatment system and to interrupt regeneration.

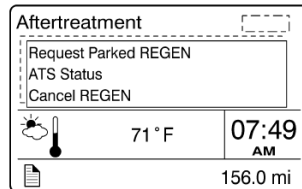

1. Request Parked REGEN

Use this function to initiate a stationary (parked) regeneration.

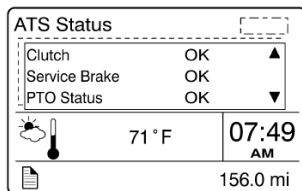

2. ATS Status

The Aftertreatment status sub-menus provide information about the conditions required for performing regeneration. The status can be OK (regeneration allowed), CHECK (regeneration not allowed) or N/A (not applicable). When ATS Status is selected, the following sub-menus are available.

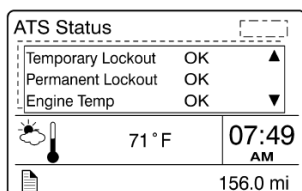
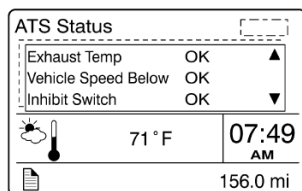
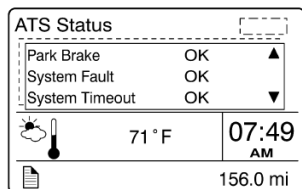
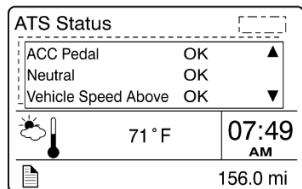

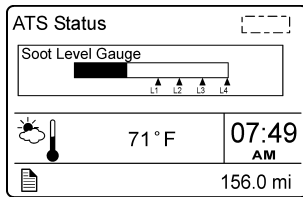

Soot Level Gauge

From the ATS Status sub-menu, you can view the soot level for the Aftertreatment system. When the soot level is high, regeneration is necessary. L1, L2, L3 and L4 under the scale correspond to Level 1 up to Level 4 (see Diesel particulate filter clogging sequence – Engine indicator lamp).



3. Cancel REGEN

From the Aftertreatment main menu, you can cancel a REGEN cycle.

« PASSWORD » MENU

Certain functions are password-protected. These passwords give the user access to all password-protected functions. The default password is 0000.

1. Password

The following menus are password-protected and marked with a key symbol in the menus:

- Change Password
- Fleet ID
- Reset Trip Data
- Fault Diagnostics
- Inactive Faults

TRANSMISSION RETARDER

The transmission retarder is an optional device that helps to reduce the speed of a vehicle. It improves vehicle control, increases driving safety and permits more economical operation. The retarder provides slowing power when it is most needed, such as when descending

mountain roads, in stop-and-go traffic and on crowded freeways.

The transmission retarder is a vehicle-slowng device, not a vehicle-stopping device. It is not a substitute for the service braking system. The service brake must be used to bring the vehicle to a complete stop.

5-20 OTHER FEATURES

The retarder is provided with control buttons on the steering wheel and a lever on the steering column (refer to Section 4 *Controls and instruments*).

NOTE

Extended use will raise the temperature of the transmission fluid.

The retarder helps reduce speed on grades without using the vehicle's conventional service braking system. This virtually eliminates brake overheating and reduces the risk of a runaway vehicle. A retarder greatly increases the service life of brake pads and discs, resulting in reduced brake maintenance costs.



WARNING

Do not use the retarder during inclement weather or slippery road conditions.

NOTE

The stoplights automatically illuminate when the vehicle is slowing down after application of the transmission retarder.

For vehicles equipped with the Antilock Braking System (ABS), as the wheels start to lock up on slippery roads, the output retarder automatically deactivates until the wheels roll freely.

ENGINE BRAKE



WARNING

A vehicle speed retarding device (such as engine brake) is not intended to replace the service brake systems on your vehicle nor intended to bring your vehicle to a stop. A vehicle speed retarding device is only intended to reduce the speed of your vehicle under certain conditions.

Several types of engine brake can be installed or are standard on certain engines. All are used to reduce wear on the vehicle brake linings.



WARNING

When descending significant grades, use the service brake as little as possible. If the engine does not slow the vehicle to a safe

speed, apply service brake and shift to a lower range. Let the engine (and engine brake) slow the vehicle. Keep brakes cool and ready for emergency stopping.

NOTE

When driving with cruise control, the exhaust brake automatically engages if the selected cruise speed is exceeded by approximately 4 mph (7 km/h). The exhaust brake is then disengaged when the speed has returned close to selected cruise speed, provided that the engine brake was previously enabled.

NOTE

On vehicles equipped with the I-Shift transmission, any increase of the braking power, such as from Auto mode (A) to Engine Brake Low (1), from Auto mode (A) to Engine Brake High (2) or from Engine Brake Low (1) to Engine Brake High (2) will deactivate the cruise control.

EXHAUST BRAKE

The exhaust brake provides about 66 % of the total available engine braking power. The exhaust brake is most effective at high engine speeds (1500 to 2300 rpm). The exhaust brake is automatically disengaged if the engine speed drops to or below 1100 rpm.

This engine brake mode provides low braking power by containing the exhaust gases in the exhaust manifold, thereby making the engine work against the back pressure. This provides a retarding force on the drive wheels.

The following must be in effect for the exhaust brake function:

- The engine brake switch found on the dashboard is set to the ON position
- The **Retarder/Engine Brake Low** (1) button on the steering wheel controls is depressed
- Accelerator pedal is fully released
- Engine speed exceeds 1150 rpm

VOLVO ENGINE BRAKE (VEB)

VEB has a higher braking effect than the exhaust brake. This engine brake mode is most effective at high engine speeds (1500 to 2300 rpm). It is automatically disengaged if engine speed drops below 1000 rpm.

The VEB is engaged using the **Retarder/Engine Brake High** (2) button located on the steering wheel. It works together with the exhaust brake to provide to provide 100 % of the maximum available braking power.

The engine brake control on the steering wheel is achieved by the use of three buttons: OFF, LOW (1) and HIGH (2). With the Engine Brake LOW (1) button depressed, only the exhaust brake is engaged. With the Engine Brake HIGH (2) button, both the exhaust brake and the compression brake are activated.

VEB = Exhaust Brake + Compression Brake

The following must be in effect for the VEB to function:

- The engine brake switch found on the dashboard is set to the ON position
- The **Retarder/Engine Brake Low** (2) button on the steering wheel controls is depressed
- The vehicle speed is over 7.5 mph (12 km\h)
- Engine temperature is greater than 110°F (43°C)
- Accelerator pedal is fully released
- Engine speed exceeds 1150 rpm

ENGINE BRAKE – AUTO MODE (A) (WITH I-SHIFT TRANSMISSION ONLY)

The Auto mode (A) supplies 66 % of the maximum available braking power. To engage the engine brake Auto mode (A), set the engine brake switch to the ON position.

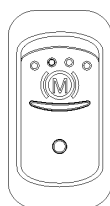

Engine Brake switch



When in Auto mode (A), the engine brake engages simultaneously with service brakes upon pressing of the brake pedal. The engine braking power varies with the brake pedal position. The further the pedal is depressed, the more total braking power is provided.

To switch to the engine brake Auto mode (A) when the engine brake is already engaged in Low (1) or High (2) braking power, simply press the Engine Brake OFF switch located on the steering wheel.

ANTILOCK BRAKING SYSTEM (ABS), TRACTION CONTROL SYSTEM (TCS) & ELECTRONIC STABILITY CONTROL (ESC)

ANTILOCK BRAKING SYSTEM (ABS)

The purpose of the Antilock Braking System (ABS) is to maintain vehicle stability and control during braking and to minimize the stopping distance in any road condition.

On slippery roads and more generally in emergency situations, over-braking frequently induces wheel locking. Wheel locking greatly increases breaking distance on any road surface. Locked wheels also impede directional control and cause severe tire abrasion. An antilock braking system provides maximum braking performance while maintaining adequate control on slippery roads.

The basis of ABS is constant monitoring of wheel parameters during braking. Sensors on each wheel of the front and drive axles constantly measure wheel speed during braking. This information is transmitted to a four-channel electronic processor which senses when any wheel is about to lock. Modulating valves quickly adjust brake pressure (up to 5 times every second) to prevent wheel lock. Each wheel is therefore controlled according to the available grip.

In this way, the vehicle is brought to a stop in the shortest possible time while remaining stable and under the driver's control.

	<p>WARNING</p>
<p>Vehicles following ABS-equipped vehicles may not be able to brake as fast on slippery roads.</p>	

TRACTION CONTROL SYSTEM (TCS)

TCS controls wheel spin during vehicle acceleration to improve traction.

- The TCS system will intervene automatically and apply braking pressure to a spinning wheel transferring engine power to the other

5-22 OTHER FEATURES

drive wheel that have better traction. This feature is active only at speeds below 25 mph (40 km/h).

- If all of the drive wheels begin to spin, the TCS system will reduce engine throttle to improve traction at all of the drive wheels.

If drive wheels begin to lose traction during acceleration, TCS will engage automatically to assist the driver in accelerating the vehicle. The TCS/ESC lamp will flash rapidly to let you know whenever TCS is actively functioning.

ELECTRONIC STABILITY CONTROL (ESC)

The ESC stability system is an optional feature for ABS-equipped vehicles that reduces the risk of rollovers and loss of control. The ESC system features include the RSP Roll Stability Program and Yaw Control.

The RSP system counteracts the tendency of a vehicle to tip over while changing direction (typically, while turning).

To reduce the risk of rollover, the RSP system detects potential rollover conditions and slows the vehicle both by reducing engine throttle (and hence, engine torque) and by applying service brakes as needed at the appropriate wheels.

 WARNING
During an RSP system intervention, the vehicle automatically decelerates . The RSP system can slow the vehicle with or without you applying the brake pedal, and even when you are applying the throttle .

During an RSP system intervention, you can always use your service brake pedal to increase the braking pressure that will be applied. However, if you were to apply less braking pressure than needed or even if you release the brake pedal entirely during an intervention, the RSP system will continue to apply the necessary amount of braking pressure automatically to the appropriate wheels to mitigate a potential rollover.

Yaw Control is a feature that reduces the risk of loss of control. If a vehicle's tires start to slide during a turn, Yaw Control counteracts the tendency of that vehicle to spin (or yaw), thereby reducing the risk of loss of control. Many factors, including road conditions, load distribution and

driving behavior, can contribute to the development of a spin.

 WARNING
In the case where a vehicle equipped with the ESC system pulls a trailer, the latter must be equipped with ABS.

 CAUTION
Even with ESC-equipped vehicles, the driver remains responsible for ensuring vehicle stability during operation.

<i>NOTE</i>
<i>For further details, consult "Bendix ABS Operator's Manual".</i>

DCDL DRIVER CONTROLLED DIFFERENTIAL LOCK (OPTIONAL)

By actuating the dashboard switch, the driver can lock or unlock differential action.

The purpose of the DCDL is to provide maximum vehicle traction and control on bad road surface conditions. When the DCDL is actuated, a clutch collar completely locks the differential case, gearing, and axle shafts together. This feature maximizes traction to both wheels. The lock position will also protect against spinout damage to the differential. The DCDL should not be actuated when good road conditions exist.

OPERATION TIPS

1. The DCDL can be locked or unlocked if the vehicle is standing still or moving at a constant low speed when the wheels are not spinning, slipping, or losing traction.
2. When the DCDL is locked, operate the vehicle at low speeds. DCDL will not engage and will disengage in speed higher than 5 MPH (8 km/h).
3. When the DCDL is locked, the vehicle's turning radius will increase. This condition is called "understeer." The driver must use caution, good judgment and drive at low speeds when operating the vehicle with the DCDL locked.

4. Always unlock the DCDL as soon as the need for maximum traction has passed and the vehicle is traveling on a good road.
5. Do not lock the DCDL when the wheels are slipping or losing traction, or damage to the axle can result.
6. Do not lock the DCDL when the vehicle is traveling down steep grades, or potential loss of vehicle stability could occur.

LOCKING THE DCDL

When encountering poor road conditions where maximum traction is needed, follow the recommended procedures:

1. Without the wheels spinning, slipping or losing traction, flip the DCDL control switch to the “LOCK” position while maintaining a constant vehicle speed.
2. Let up momentarily on the accelerator to relieve torque on the gearing, allowing the DCDL to lock.
3. When the DCDL is fully locked, the vehicle will have an “understeer” condition when making turns. Proceed cautiously over poor road conditions.

UNLOCKING THE DCDL

When the vehicle can safely operate and driving conditions have improved, disengage the DCDL following the recommended procedures:

1. Flip the control switch to the “UNLOCK” position, when the vehicle is stopped or when traveling at low speed while the wheels are not spinning, slipping or losing traction.
2. Let up momentarily on the accelerator to relieve torque on the gearing, allowing the DCDL to unlock.
3. Resume driving at normal speed using good driving judgment.

KNEELING SYSTEM

This system lowers the front end, enabling passengers to get on and off the coach without any difficulty.

To operate:

- Stop the coach ;
- Set the transmission to neutral(N) ;

- Apply the parking brakes ;
- Momentarily press the rocker switch downwards to lower the front end of the coach 4 inches (100 mm). (Refer to Section 4 *Controls and Instruments*).

A pictogram will appear in the DID status line indicating that the coach is being lowered.

NOTE
The parking brakes must be applied to allow the use of the kneeling.

NOTE
 Kneeling is disabled when the entrance door is open.

To raise the front of the coach to normal height;

- Momentarily press the rocker switch upwards. The front end will rapidly rise up ;
- Release the parking brakes ;
- Shift the transmission to the desired range.

 **CAUTION**
 Avoid parking the coach too close to the sidewalk or to other obstacles which could damage the coach during kneeling.

HI-BUOY

The coach may be equipped with the optional front Hi-Buoy or full Hi-Buoy. The front Hi-Buoy system has the same functions as front kneeling. In addition it enables passengers to get on or off the coach easily by raising the front end about 4 inches (100 mm), which may prove useful when the dock is higher than usual. The front Hi-Buoy is combined with front kneeling to increase flexibility of the system. Refer to Section 4 *Controls And Instruments*.

The full Hi-Buoy system raises the whole coach about 4 inches (100 mm). It can be used to enable passengers to get on or off the coach easily, and to safely travel roads with high obstacles. Refer to Section 4 *Controls and Instruments*.

NOTE
The Hi-Buoy system does not operate when the coach is traveling over 5 mph (8 km/h).

5-24 OTHER FEATURES

Consequently, the driver cannot inadvertently operate the Hi-Buoy system at higher speeds.

LOW-BUOY

This system lowers the coach about 4 inches (100 mm). It enables the coach to drive through underpasses where the height is less than 12 feet (3.7 m).

Low-buoy operation is controlled by a valve located on the lateral console. Toggle the low-buoy control lever rearward to lower the coach. Toggle the control level forward to return the coach to normal ride height. A pictogram appears in the Driver Information Display if the coach speed exceeds 12 mph (20 km/h) when lowered. Refer to Section 4 *Controls and Instruments*.



CAUTION

Avoid parking too close to the curb or other obstacles that could damage the coach during low-buoy operation.



WARNING

Use only below 5 mph (8 km/h).

NOTE

The Low-Buoy cannot be activated when the coach is traveling over 5 mph (8 km/h). Consequently, the driver cannot inadvertently operate the Low-Buoy system at higher speeds.

RETRACTABLE TAG AXLE

Tag axle retraction is controlled by a valve located on the right lateral console. The valve can be switched to either the wheels up or wheels down position. The axle will be automatically raised or lowered by air pressure according to the valve position. Refer to Section 4 *Controls and Instruments*.

The tag axle service brakes operate only when the tag axle is in the wheels down position. Never lower the tag axle while the coach is moving. A pictogram appears in the Driver Information Display if the vehicle speed exceeds 12 mph (20 km/h) with tag axle raised. The tag

axle can be raised in tight maneuvering areas like in a parking lot or to make it easier to turn a short corner. The tag axle shortens the wheelbase and allows tighter turning. Raising the tag axle transfers extra weight and additional traction to the drive wheels providing improved control on slippery roads.



CAUTION

Do not use tag axle in raised position for an extended period. Raising tag axle increases load on the drive axle, suspension and tires.

Do not drive vehicle with tag axle raised when speed is exceeding 12 mph (20 km/h).

In order to prevent damage to the suspension, always raise the tag axle before lifting the coach.

IN-STATION LIGHTING

The in-station lighting system circuit is linked with the optional battery charger. When the charger is connected to an external power source, the in-station lighting circuit can be energized without depleting the batteries. The receptacle used for the battery charger is located on the engine R.H. side access door.

COOLANT HEATER

This optional auxiliary heating system is used for preheating and retaining the heat of water-cooled engines. It can be used before startup to ease starting and to provide rapid operation of the interior heating system. It can also be used with the engine running to maintain coolant heat and interior temperature.

The heater operates independently of the engine. It is connected to the cooling system, heating circuits and to the vehicle's fuel and electrical system.



WARNING

The coolant heating system uses the same fuel as the engine. Do not operate in a closed building or while refueling. Operate only in a well ventilated area.

The coolant heater is located in a compartment in the lower part of the rear electrical compartment. To access the coolant heater,

remove the panel in the rear electrical compartment.

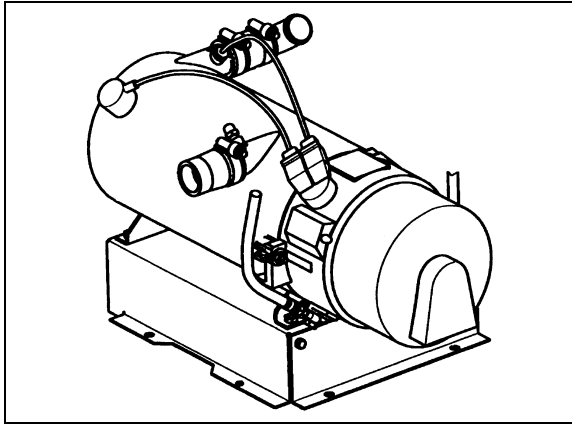

COOLANT HEATER (104,000 BTU) 22224

SWITCHING THE HEATER ON

The timer light illuminates when the heater is switched on. Air is forced in to flush out the combustion chamber of residual gases and the water circulation pump begins operating. The fuel metering pump delivers fuel in precise amounts to the combustion chamber, where fuel and combustion air form a combustible mixture which is ignited by the ignition unit.

Once the flame sensor has signaled to the control unit that combustion has taken place, the ignition unit is switched off.

Hot combustion gases are diverted at the end of the flame pipe and are then forced through the indirect heating surfaces of the heat exchanger. The heat exchanger transfers the heat to the coolant water passing through the heat exchanger.

The heater is thermostatically controlled and operates intermittently (i.e., the switched-on time of the burner varies depending on the heat requirement). The water temperature is controlled by the built-in water thermostat.

The water circulation pump remains in operation as long as the heater is operating, even during the regulated intervals and during the delayed cut-out of the heater. The pump can also be operated independently of the heater by means of an appropriate circuit. The heater can be switched ON at any time (i.e., during the delayed cut-out period). Ignition takes place after the delayed cut-out time expires.

SWITCHING THE HEATER OFF

The fuel supply is interrupted when the heater is switched OFF. This causes the flame to go out and a delayed cut-out of 2.5 minutes begins. The circulating combustion air flushes the remaining combustion gases out of the chamber and cools off the heated parts on the exhaust side of the heat exchanger. The water circulation pump continues to transfer the latent heat present in the heat exchanger, thus preventing hot spots. Once the delayed cut-out time expires, both the combustion air blower and the water circulation pump switch OFF automatically. A cut-out will automatically take place in case of heater failure. Refer to Section 9 *Technical information* for additional information.

COOLANT HEATER TIMER

The timer, located on L.H. lateral console is used to program the starting and stopping time of the preheating system and to give Fault Codes. The system indicator light, located on the timer, illuminates when the system is functional.



CAUTION

The preheating system should not operate for more than one hour before starting engine as this could discharge batteries.



WARNING

Preheating system must not operate when vehicle is parked inside or during fuel fill stops.

NOTE

Preheating system uses the same fuel as the engine.

Timer operating instructions (Spheros)

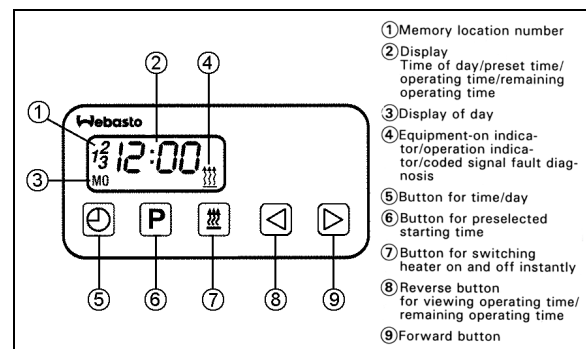

SPHEROS

5-26 OTHER FEATURES

These instructions refer to the Spheros timer illustrated above.

Remaining Operating Time

The remaining operating time refers to the period of time the heater still continues to remain in operation. It may be changed while the heater is in operation.

Setting the Digital Timer

After the power has been connected, all symbols on the digital display are flashing. The time of the day and the day of the week must be set.

All flashing symbols of the timer can be set by means of the Forward (9) or Reverse (8) buttons.

When buttons (8) and (9) are pressed for more than 2 seconds, the quick digit advance mode is activated.

Setting the Time and Day of the Week

1. Press button (5) for more than 2 seconds (time display flashes).
2. Press (8) or (9) button to set the time of day.
3. Wait 5 seconds. The time of day is stored (day of week flashes).
4. Press (8) or (9) button to set the correct day of week.
5. Wait 5 seconds. The day of week is stored.

Viewing the Time (Ignition ON)

Continuous display of current time and day of the week.

Viewing the Time (Ignition OFF)

Briefly press button (5) to display current time and day for 5 seconds.

Switching Heater ON (Instant Heating) With Ignition ON:

Press button (7). Heater is switched on (continuous operation) and continues to operate until button (7) is pressed again or ignition is switched off.

NOTE

If the ignition is switched off while heater is in operation, the remaining operating time of 15 minutes flashes on the display and the heater will continue to operate for this period of time.

Switching Heater ON (Instant Heating) With Ignition OFF:

Press button (7). Heater is switched on for preset operating time (the factory-set heater operating duration is 60 minutes)

Switching Heater OFF

Press button (7). The heater starts its after-run cycle and switches off thereafter.

Presetting Starting Time

1. Press button (6). Memory location number flashes.

NOTE

By repeatedly pressing button (6), starting time 2 or 3 can be preset.

2. Press button (8) or (9) until correct startup time is set.
3. Wait 5 seconds. Preset starting time is stored and day of week flashes.
4. Press button (8) or (9) to select the correct startup day of week.
5. Wait 5 seconds. The startup day of week is stored.

The number of memory location remains on the display. The timer is now in the programmed mode and will switch the heater on at the preset time.

NOTE

We recommend that memory locations 1 and 2 be used for presetting times within 24 hours of setting the timer. Memory location 3 can be used for a starting time within the next 7 days of setting the timer.

Recalling Preset Times

Press (6) repeatedly until the desired memory location number and preset time are displayed.

Canceling Preset Time

Press button (6) repeatedly until no more memory location number is visible on the display.

Setting Operating Time

1. With heater off, press button (8). Operating time flashes.
2. Press button (8) or (9) to set the operating time (between 1 and 120 minutes)
3. Wait 5 seconds. Operating time is stored.

The heater remains in operation for the preset time (except for continuous operation).

Setting the Remaining Operating Time

1. With heater in operation, press button (8). Remaining operating time flashes.
2. Set remaining time with button (8) or (9).
3. Wait 5 seconds. Remaining operating time is stored.

Fault Diagnosis by Coded Light Signals

On heaters equipped with a fault diagnosis system using coded light signals, the equipment-on indicator/operation indicator flashes. Please consult appendix D for the Fault Diagnosis and Code list.

TROUBLESHOOTING AND MAINTENANCE

The diagnostic code system in Spheros timers is standard. Refer to Appendix D at the end of this manual, to the Maintenance Manual or to Spheros manual for more information.

NOTE
If there are no heater faults, the heater will go through a normal start cycle and regulate based on thermostat setting.

NOTE
Switch on the preheating system briefly about once a month, even during the warm season.

CAUTION
When welding on the vehicle, disconnect the

preheater module connector in order to protect this system from voltage surges.

CAUTION
To avoid running down the batteries, do not turn on the preheating system for more than one hour before starting the engine.

WARNING
The preheating system uses the same fuel as the engine. Do not operate in a building or while refueling. Operate only in a well-ventilated area.

WHEELCHAIR LIFT

Read and understand the RICON Owner's Manual before attempting to use the wheelchair lift. The instructions below are a quick reference and serve to complement the information provided by the lift manufacturer.

WARNING
To operate the optional wheelchair lift, the coach must be parked on a flat and level surface, with the parking brake applied.

Supply power to the wheelchair lift system first by depressing the wheelchair lift activation switch located on the dashboard.

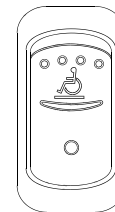

WHEELCHAIR LIFT ACTIVATION SWITCH

WHEELCHAIR LIFT AND ACCESS DOORS

Open the access door until fully opened, then open the lift mechanism baggage door and swing open until locked open.

A light inside the vehicle illuminates the doorway when the wheelchair access door is open.

5-28 OTHER FEATURES

A pictogram will appear in the DID when the lift mechanism door or the wheelchair access door is open. Refer to Section 4 *Controls and Instruments*.

NOTE

Whenever the wheelchair lift activation switch is in the ON position, an interlock system prevents releasing of the parking brake and a transmission inhibit feature prevents gear selection when either the lift mechanism access door or the wheelchair access door is open.

If in motion and the access door opens, a pictogram will show and an audible alert will sound.

To close the door, pull the door handle to unlock from the open position, and then slam the door shut.

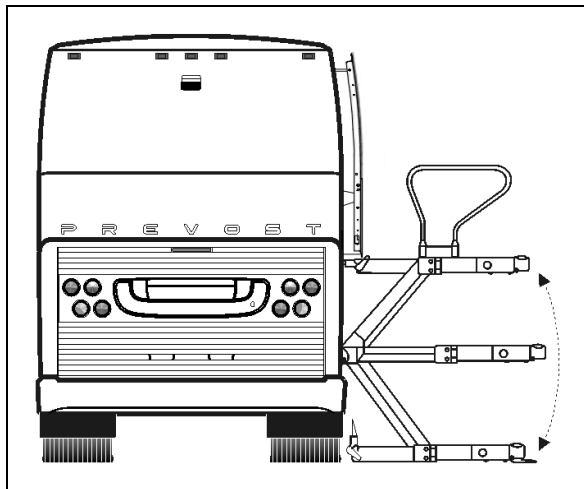

RICON WHEELCHAIR LIFT

23365

OPERATING THE WHEELCHAIR LIFT



WARNING

Inspect the lift before each use as described in the RICON Owner's manual. If any unsafe condition exists, or if unusual noises or movements are noticed, DO NOT use and contact an authorized RICON dealer for repair.



WARNING

Read and comply with all warning labels and symbols affixed to the wheelchair lift.



WARNING

Do not operate with a load in excess of 660 lbs (300 Kg).

The coach must be parked at least 10 feet (3 meters) away from other vehicles or large objects. Turn on the POWER ENABLE switch and then control each lift motion by pressing an appropriate button. The POWER ENABLE switch provides power to the pendant and thereby enables the lift. When turned on, the power switch and each button illuminate. When operating the lift, be careful the control wire doesn't bind with the lift mechanism.

Using the handheld control pendant, deploy the lift by pressing on the DEPLOY button. When the lift begins to deploy, it is normal to hear a clutch action of one or two clicks should be heard. Once deployed, lift the handrails until locked in vertical position. Buckle the restraint belt.

Use the UP and DOWN switch to raise or lower the platform. Upon reaching the top or the bottom of its stroke, the appropriate rollstop will lower.

NOTE

The restraint belt acts as a safety device and it prevents raising or lowering the lift when not buckled.

Roll the wheelchair onto the platform with the wheelchair facing outwards because the front rollstop is not designed to keep the large rear wheels of a wheelchair from rolling off the platform.

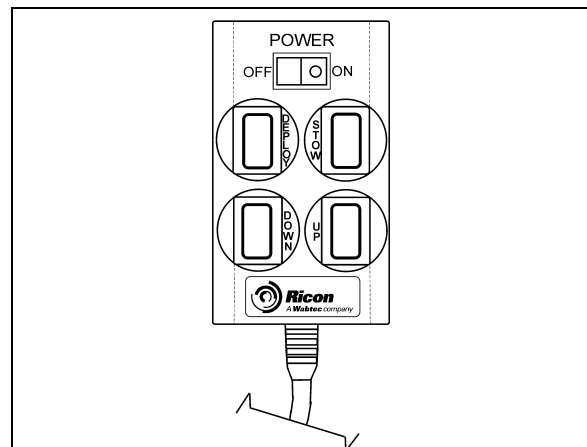

CONTROL PENDANT

23421



WARNING

Use extreme care when rolling on or off the platform and lock the wheelchair brakes while stationary on the platform. Make sure the wheelchair fits safely on the platform. Keep arms and legs away from moving parts.

NOTE
The indicator light on the control device illuminates when power is supplied (when the lift electrical circuit is activated by the switch on the dashboard).

To stow the platform, detach the restraint belt and fold the left handrail, then fold the right handrail (lift the slam lock handles to fold handrails). Re-fasten restraint belt. Press down and hold the STOW button until the lift is fully stowed.

THRESHOLD WARNING SYSTEM (TWS) ADJUSTMENT

There are three verifications to perform; 1) Adjust Aiming of Acoustic Sensor Beam, 2) Test Aim of Acoustic Sensor Beam, and 3) Adjust Acoustic Sensor Timing.

Adjustment of the sensor timing is done at the factory and should not need to be repeated in the field. Readjustment should only be considered if the sensor aiming could not be adjusted to ignore both the wheelchair in the aisle and the platform during its normal movement.

Adjust Aiming of Acoustic Sensor Beam

1. Place wheelchair with passenger in center aisle of coach, pointed at doorway where Threshold Warning System (TWS) is installed. The TWS should not detect a wheelchair and passenger when they are located this far from doorway.
2. Turn power to lift on (LED on TWS module will light steady) and indicator light on the control device illuminates. If wheelchair and passenger are detected by acoustic sensors the LED will flash, the buzzer will sound and the module red light will flash. If this occurs it is necessary to adjust aiming of sensors.
3. Turn sensor angle adjustment screw clockwise to move direction of beam away from center aisle and towards doorway. Stop adjustment when LED ceases to flash.

NOTE

Only in rare instances will adjustment be needed in the counterclockwise direction.

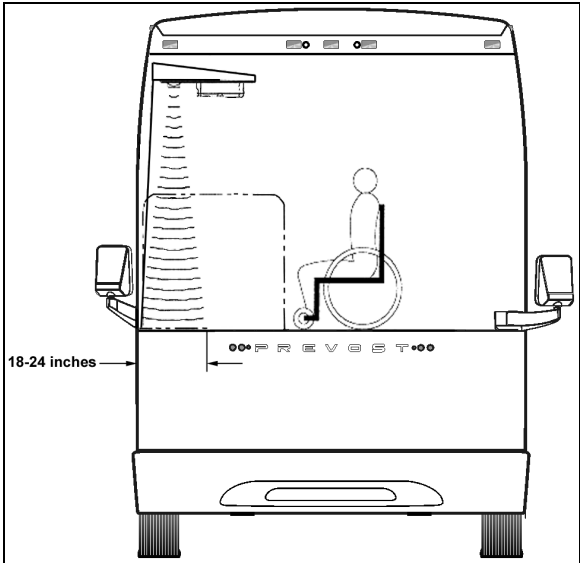

TWS AREA 23366

4. Move centerline of small wheels of wheelchair (with passenger) to within 24 inches of doorway and repeat aiming procedure in previous step.

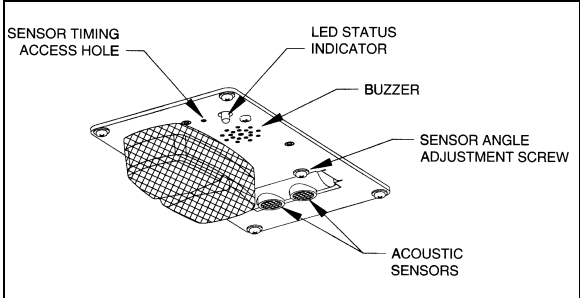

TWS MODULE DETAIL

Test Aim of Acoustic Sensor Beam

1. Move wheelchair and passenger slowly towards doorway. TWS should detect wheelchair and passenger (LED will flash, buzzer will sound and the module red light will flash) when centerline of front wheels is between 18 and 24 inches from doorway.
2. Open vehicle access door above lift. Lower platform to ground and place wheelchair and passenger at rear of platform. Rollstop (rear barrier) should be up. Raise platform to floor level.

This normal platform motion with wheelchair and passenger aboard should not actuate TWS. If LED does flash (buzzer will also

5-30 OTHER FEATURES

sound and module red light will flash), turn sensor adjustment screw slightly counterclockwise.

NOTE

If an adjustment is made, repeat the previous step where wheelchair is between 18 and 24 inches from doorway.

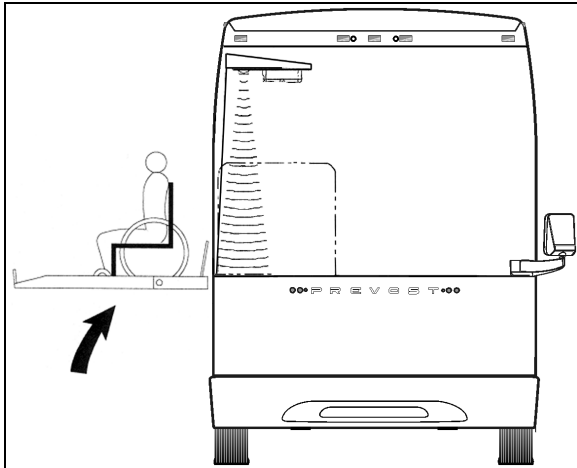

CHECKING NORMAL PLATFORM POSITION

23366

Adjust Acoustic Sensor Timing

1. Support a flat sheet of cardboard or similar material, directly beneath TWS module at a distance of 4½ feet below module. Sheet must be facing sensors.

NOTE

Before proceeding, visually inspect sensors to verify that they are pointing directly at floor, or nearly, and are not pointing off at an extreme angle.

2. Note the sensor timing access hole. This hole provides access to a plunger-actuated switch that sets the sensor timing. Insert a 1/16-inch diameter wire-like object into the access hole and press the plunger inward. The LED will flash momentarily while the module establishes the distance and then remain on steady. Release the plunger when the LED ceases to flash.

NOTE

It is important that objects, such as your body, tools, seats, etc, do not interfere with the beam while the adjustment is being made.

EMERGENCY OPERATION

In the event of electrical power loss, manual operation of the lift is possible as explained below.

To manually deploy the platform

Allow enough space for lift operation and passenger boarding. If a break down situation exists and the vehicle cannot be moved so that the lift system can be operated safely, the operator must summon emergency assistance to move the vehicle before operating the lift.

Fully open wheelchair access and lift doors. Ensure that there are no obstacles in the path of the lift.

Remove the pump handle from inside the cover of the lift mechanism box.

Turn one of the manual platform release shafts using pump handle extension.

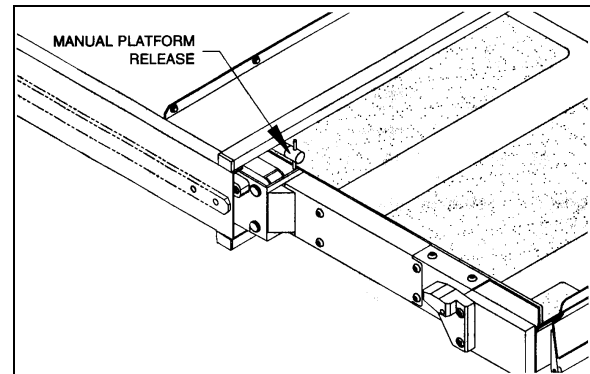

MANUAL PLATFORM RELEASE SHAFT

Grasp the platform and pull firmly until the lift is all the way out against the carriage stops.

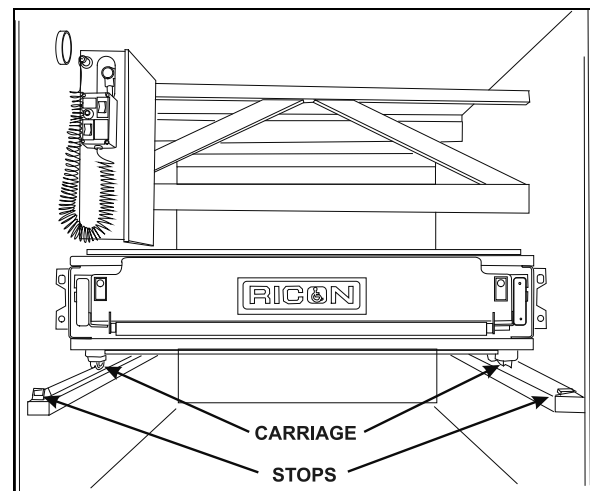

WHEELCHAIR LIFT MANUAL OPERATION

23265

To manually raise the platform

Remove the pump handle from inside the cover of the lift mechanism box.

Insert the handle onto manual backup pump release valve. Make sure the notches at the end of the handle are fully engaged by the release valve pin. Twist the handle clockwise until lightly-snug and remove.



CAUTION

During manual rising of the lift, do not raise the platform more than 1-1/2 inches above the vehicle floor level. Any excessive travel will make it difficult to enter the platform and/or damage the lift bridge plate actuator. The outer edge of the bridge plate must rest squarely on the vehicle floor.

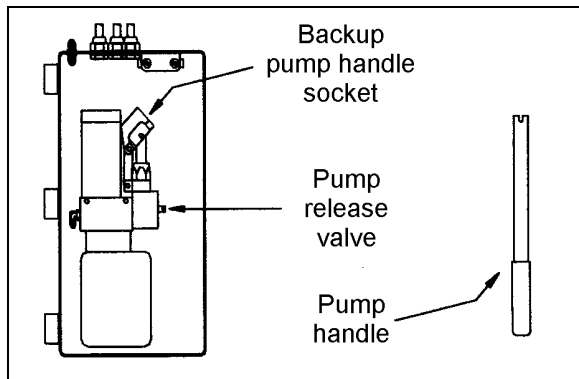

WHEELCHAIR LIFT MANUAL HYDRAULIC PUMP 23268

Insert handle extension into manual backup pump handle socket and pump to raise the platform to the vehicle floor level.

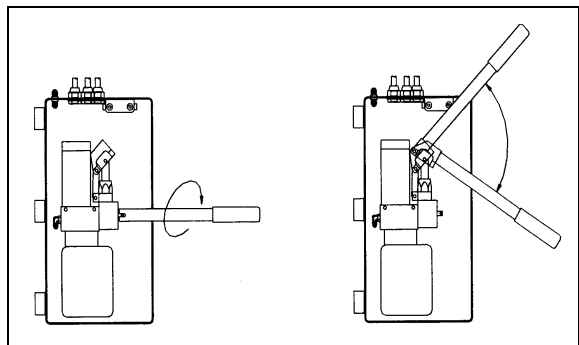

PLATFORM MANUAL RAISING 23267

The lift passenger and attendant must follow the instructions to ENTER or EXIT the vehicle, as previously described.

To manually lower the platform



CAUTION

Do not turn pump release valve more than 1/4-turn counterclockwise. The valve is totally removable which will disable all automatic and manual UP/DOWN functions.

Insert the pump handle extension onto manual backup pump release valve. Make sure the notches at the end of the handle are fully engaged by the release valve pin. Slowly twist the handle 1/4-turn counterclockwise until the platform begins to lower.

Allow the platform to reach ground level.

Twist the handle clockwise until lightly-snug and remove.

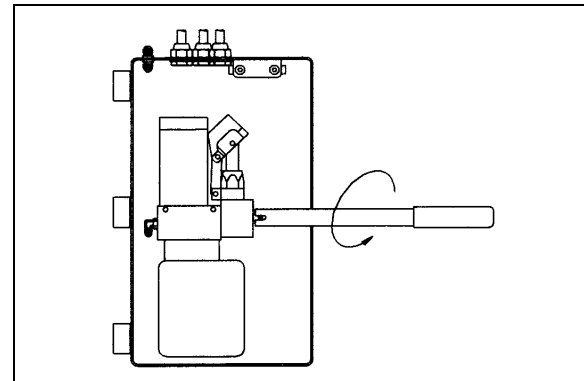

PLATFORM MANUAL LOWERING

Using the rollstop manual control knob and one hand on the rollstop, OPEN the rollstop.

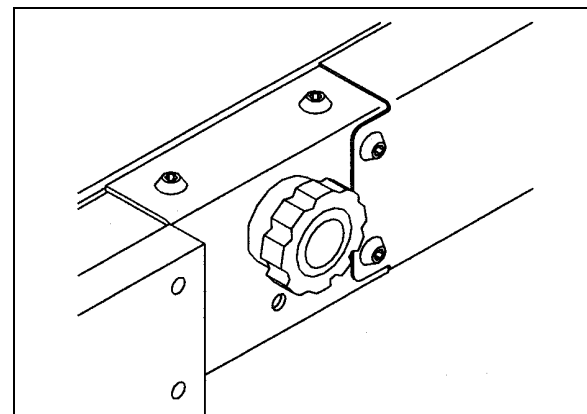

ROLLSTOP MANUAL CONTROL KNOB 23275

The attendant and lift passenger should follow the instructions to ENTER or EXIT the vehicle, as described previously.

5-32 OTHER FEATURES

To manually stow the platform

Raise or lower the platform to the deploy/stow position; the platform frame must be parallel to the side of the lift enclosure. If the exact position cannot be obtained, slightly low is preferred to slightly high.

Using the rollstop manual control knob and one hand on the rollstop, close the rollstop until it latches.

Use one person on each side of the lift to prevent mechanical binding.

With fingers up and palms forward, push the platform forcefully to start the lift moving inward. As the lift begins to move inward, maintain a constant pushing motion until the lift comes to rest completely inside the lift enclosure.

Push firmly at the end and make sure that the platform manual release shafts have turned to lock the platform.

To manually stow the lift from ground level

In the unlikely event of a hydraulic system failure and the manual backup pump is inoperative, the lift may be stowed as follows by **two or more able-bodied people**:

Raise or lower the platform to the deploy/stow position; the platform frame must be parallel to the side of the lift enclosure. If the exact position cannot be obtained, slightly low is preferred to slightly high.

Using the rollstop manual control knob and one hand on the rollstop, close the rollstop until it latches.



WARNING

The platform is heavy and should be lifted using caution and proper lifting technique: Always lift with legs and not the back when attempting to lift heavy objects.

Use one person on each side of the lift to prevent mechanical binding.

With fingers up and palms forward, push the platform forcefully to start the lift moving inward. As the lift begins to move inward, maintain a constant pushing motion until the lift comes to rest completely inside the lift enclosure.

Push firmly and make sure that the platform manual release shafts have turned to lock the platform.

WHEELCHAIR LIFT REMOVAL FOR STORING OR MAINTENANCE PURPOSES

Disconnect connector located at compartment ceiling.

Remove 4 fixing bolts located inside compartment, on each side of platform.

Grasp the platform and pull firmly, sustaining a constant pull so that the platform slides onto the rails until the carriage come in contact with the stops.

Secure the first two telescopic legs onto the platform.

NOTE

There are two telescopic legs for each platform side. The proper side is indicated onto the telescopic leg.

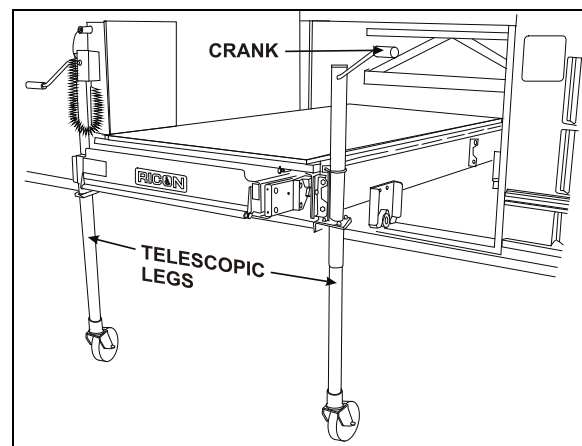

INSTALLATION OF TELESCOPIC LEGS

Turn telescopic leg crank to raise the carriage to be able to clear the stops.

Pull the platform until the rear carriage hit against the stops.

Secure the two rear telescopic legs onto the platform then turn telescopic leg crank to be able to clear the stops.

Remove platform completely.

Lower the platform to minimum height using the telescopic leg cranks before moving it.



WARNING

For better stability, keep the platform at minimum height when moving.

WARNING

Never deploy the platform from enclosure while standing on the telescopic legs.

WARNING

Telescopic legs were designed to support and move the platform only, do not use as a work table.

WARNING

Before moving platform, make sure that floor is level and free of obstacles.

WHEELCHAIR LIFT INSTALLATION

- Raise the platform to proper level.
- Insert the platform so that the rear carriage clears the stops.
- Turn telescopic leg crank until the carriage clears the stops.
- Remove the two rear telescopic legs from the platform.
- Insert the platform until the front carriage clears the stops.
- Lower the front of the platform.
- Remove the two front telescopic legs from the platform.
- Push firmly and make sure that the platform manual release shafts have turned to lock the platform.
- Secure the 4 fixing bolts located inside compartment, on each side of platform. **Apply a torque of 60 ft-lbs.**
- Reconnect connector located at compartment ceiling.

WARNING

When re-inserting platform into compartment, make sure that carriage wheels are properly aligned over the L. H. side triangular rail before removing telescopic legs.

INTERIOR APPOINTMENTS

To accommodate a wheelchair, two rows of regular seats on one side of the coach must be folded and slid away. Seats may be folded on both sides of the coach to make room for a second wheelchair.

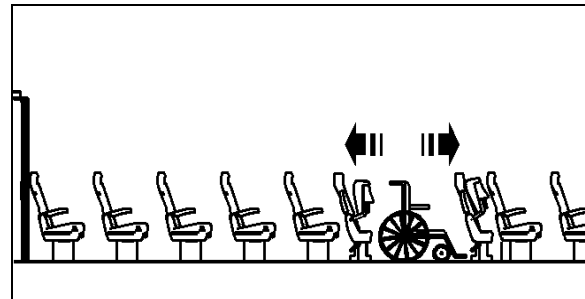

POSSIBLE SEATING ARRANGEMENTS 23259

An electrical wheelchair or tri-wheeler may require sliding back seats from both sides of the coach to allow enough turnaround space.

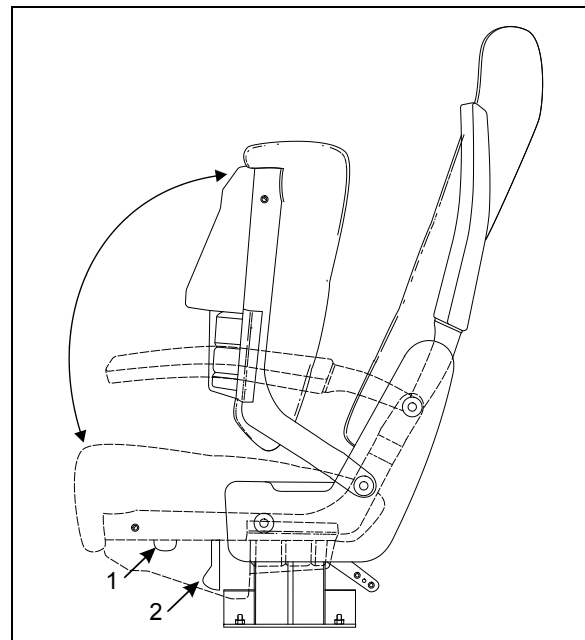

FOLDING SEATS 18430

5-34 OTHER FEATURES

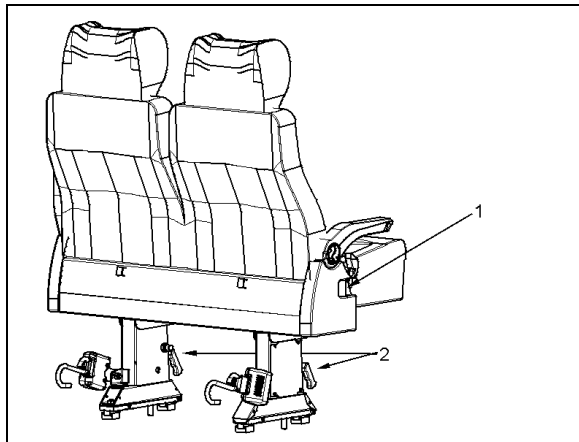

FOLDING AND SLIDING SEATS

To fold a set of seats, raise the seat back then lift up the seat cushion (pull on lever 1). To slide a row of seats, remove the black covers from the floor tracks. Pull the lever 2 while sliding the seat along the track.

The wheelchair occupants have a hostess/stop chime and a reading light switch at their disposal on the window sill of the coach, within easy reach.

WHEELCHAIR RESTRAINT SYSTEMS

Two types of wheelchair restraint systems may be found, depending on the type of seats:

1. 4-point wheelchair and occupant securement with floor anchorage.
2. 4-point wheelchair and occupant securement with anchorage to passengers seat pedestals.

Refer to Q'Straint publications included in the wheelchair restraint plastic pouches for further details.

4-POINT SECUREMENT WITH FLOOR ANCHORAGE

This securement system includes:

- 4 wheelchair tiedown retractors to secure wheelchair to vehicle floor.
- Occupant securements: lap and shoulder belts that integrate to the rear wheelchair restraints.
- Floor anchorages; installed on the vehicle floor.

Two complete sets of wheelchair restraints are kept in plastic pouches and stowed in an overhead compartment. To secure each wheelchair, four tiedown retractors must be used (at all four corners).

Two of the four tiedown retractors have attaching pins to secure the occupant's lap belt. They must be placed at the rear of the wheelchair. Each tiedown retractor slots into a mounting floor pocket.

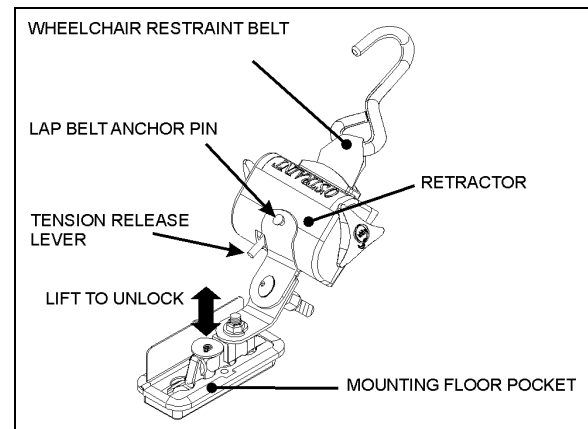

WHEELCHAIR ANCHORAGE SYSTEMS

23266

To anchor the retractors, lift the floor pocket cover, push in the retractor anchor then slide it until it locks in place. Hook one wheelchair restraint belt to each corner of the wheelchair frame (**not the wheels**) and allow the retractors to tension the belts.

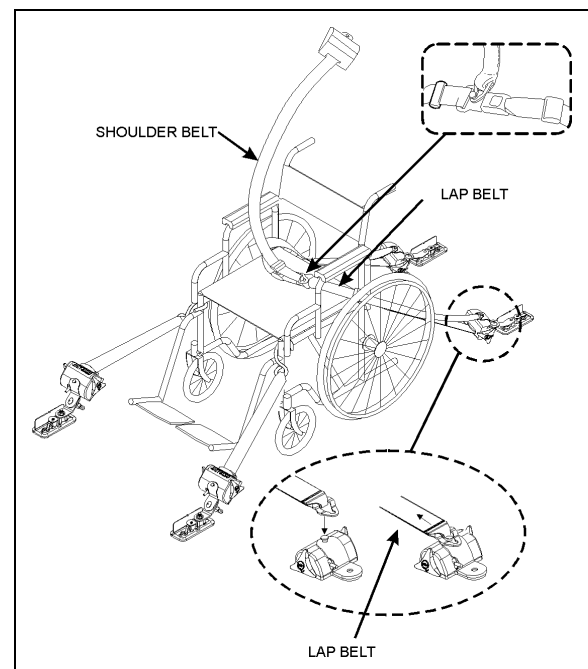

WHEELCHAIR RESTRAINTS AND ACCESSORIES

Use the blue webbing loops whenever the wheelchair restraint belt hook cannot reach a stiff member of the wheelchair chassis.

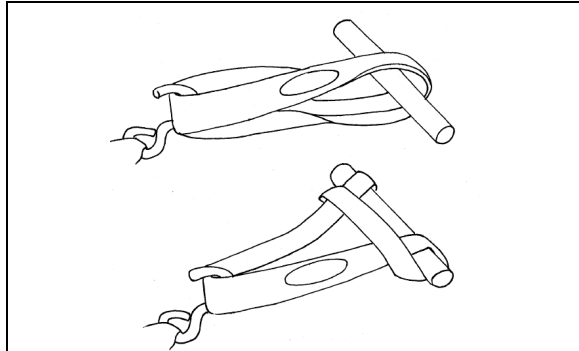

TYPICAL USE OF THE BLUE WEBBING LOOPS

To remove the restraint belts, release tension in the locking mechanism by tightening the belt slightly more with the retractor knob before pushing down the tension release lever found on the retractor. Unhook the wheelchair and allow the belts to retract. Guide the belts in, making sure they remain untwisted as they retract.

Release the anchor by lifting the lock pin then sliding out and up the anchor from the floor pocket. Close the lid to prevent dirt from entering the pocket cavity.

	<p>WARNING</p>
<p>Do not let restraint belts or occupant safety belts rub against sharp edges. Do not bleach or dry clean.</p>	

Wheelchair Occupant Restraint

Secure the wheelchair occupant in the following manner:

Fix the lap belt to the pins on the retractors of the rear restraint belts. Adjust the lap belt so it sits snug across the hips. Make sure that you place the lap belt buckle on the center aisle side. Fasten the shoulder belt to the pin on the lap belt buckle. A retractor adjusts shoulder belt length automatically.

	<p>WARNING</p>
<p>A snug fit with the lap belt positioned low on the hips is necessary to maximize safety. The belt should not be worn or twisted. Avoid pinching the belt and/or hardware. Do not</p>	

wear over rigid or breakable objects such as eyeglasses, pens or keys as these may cause injuries.

	<p>CAUTION</p>
<p>The safety belt buckle provided with the red release button must always be located on the center aisle side.</p>	

To release the belts, unfasten the shoulder belt then press the red release button found on the lap belt buckle.

4-POINT SECUREMENT WITH ANCHORAGE TO PASSENGERS SEAT PEDESTALS

This securement system includes:

- 4 wheelchair restraint belts and retractors with anchorage to passengers seat pedestals.
- Occupant securements: lap and shoulder belt.

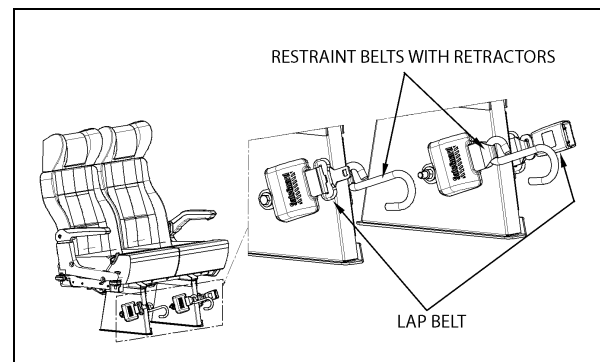

WHEELCHAIR AND OCCUPANT RESTRAINT SYSTEM

To secure the wheelchair, four restraint belts must be used (at all four corners). Hook one wheelchair restraint belt to each corner of the wheelchair frame (**not the wheels**) and allow the retractors to tension the belts.

To remove the restraint belts, push down on the tension release lever found on the retractor. Unhook the wheelchair and allow the belts to retract. Guide the belts in, making sure they remain untwisted as they retract.

Wheelchair Occupant Restraint

Secure the wheelchair occupant in the following manner:

5-36 OTHER FEATURES

Fasten and adjust the lap belts so it sits snug across the hips. Make sure that you place the lap belt buckle on the center aisle side. Fasten the shoulder belt by inserting the lap belt tab into the shoulder belt buckle. A retractor adjusts shoulder belt length automatically.



WARNING

A snug fit with the lap belt positioned low on the hips is necessary to maximize safety. The belt should not be worn or twisted. Avoid pinching the belt and/or hardware. Do not wear over rigid or breakable objects such as eyeglasses, pens or keys as these may cause injuries.



CAUTION

The safety belt buckle provided with the red release button must always be located on the center aisle side.

To unfasten the belts, press the red release button on the shoulder belt buckle first and then unfasten the lap belt by pressing the red release button on the lap belt buckle.