

Cadec and Seat Belt Alarm

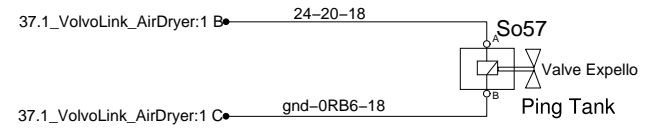

From FJB

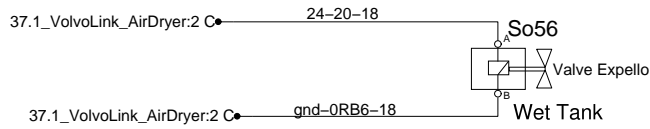
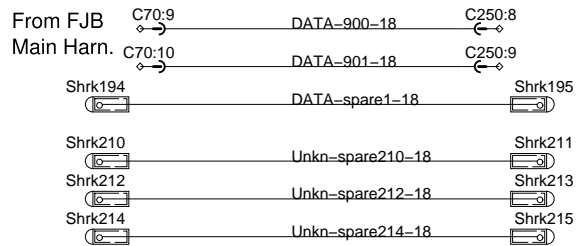
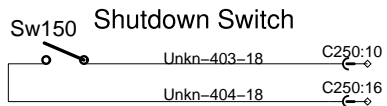
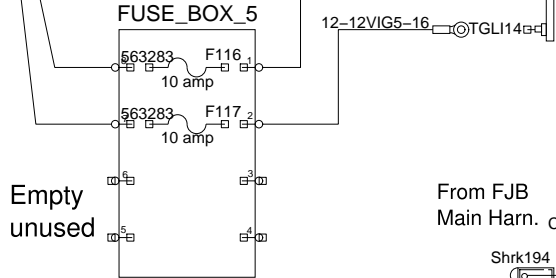
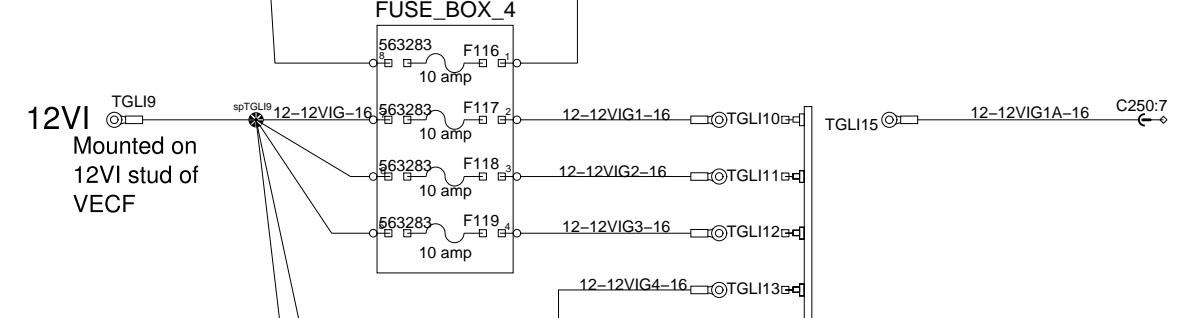
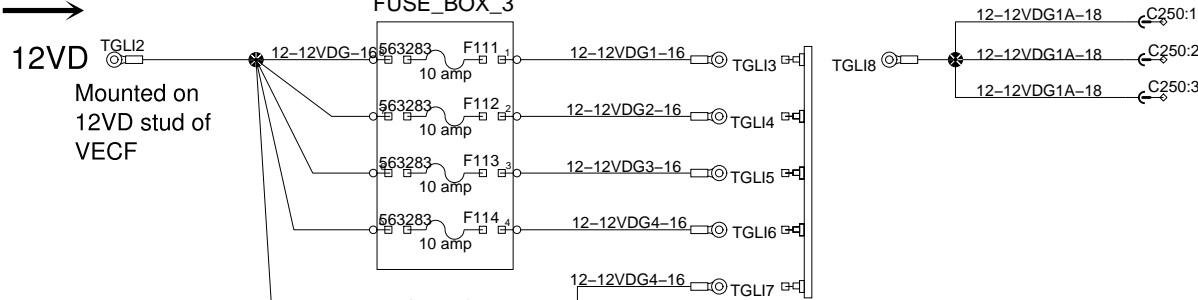

USSC Seat Belt Switch

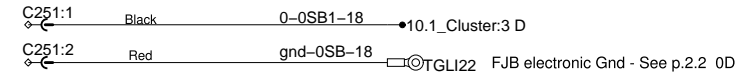

WIRELESS SYSTEM POWER

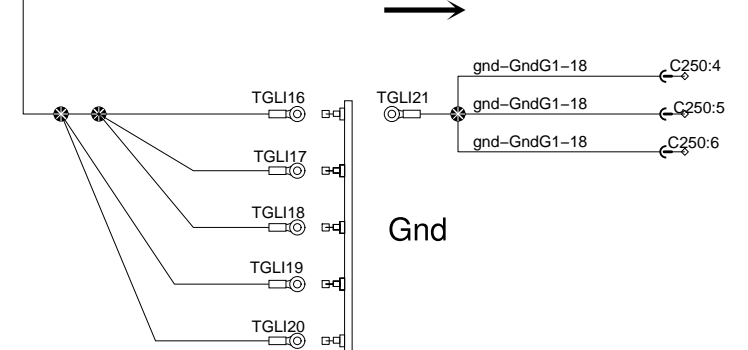
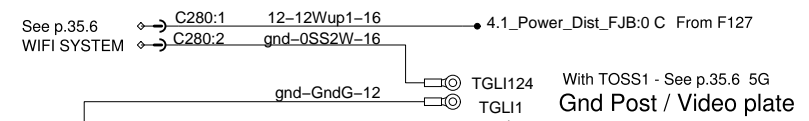

Input from Cadec

