



# Technical

# TECHNICAL

Comprehensive information that helps you connect with the right hose and fittings. Visit [www.parkerhose.com](http://www.parkerhose.com) for the latest technical data.

Hydraulic	421WC	1-braid, wire	2750	2250	2000	1250	1000			-40/+257								
	482TC/ST	1-braid, wire	3350	3250	3000	2500	2000	1500	1250	1000	625	500	375			-50/+302	100R1AT	
	431	2-braids, wire	5000	4250	4000	3500	2750	2250	2000						-40/+212	100R1AT	1436-1-1SN	853-1SN
	304	2-braids, wire	5000	4000	3500	2250	2000								-40/+212	100R2AT		
	451TC/ST	1-braid, wire	3000	3000	3000	3000	3000	3000	3000	3000	3000	3000	3000		-40/+212	100R16		
	341	4-spiral, wire		4500	4000		3000	3000	2500						-55/+302	100R16		
	302/301	2-braids, wire	5800	5000	4750	4000	3600	3100	2400	1800	1300	1150			-40/+212	100R2AT	1436-1-2SN	
	471TC/ST	2-braids, wire	5800	5000	4250	3625	3125	2500							-40/+212	100R2AT	11237-1-2SC	857-2SC
	472TC	2-braids, wire									1800	1300			-40/+212			
	351TC/ST	2-braids, wire	4000	4000	4000	4000	4000	4000							-40/+212			
	721/721TC	4-spiral, wire		4000	4000	4000	4000	4000	3000	2500	2500				-40/+257	100R12	3862-1-R12	856-R12
	721ST	4-spiral, wire		4000	4000	4000	4000	4000	3000						-40/+257	100R12	3862-1-R12	856-R12
	772TC/ST	4-spiral, wire		4000	4000	4000	4000	4000	3000	2500	2500				-40/+257	100R12	3862-1-R12	856-R12
	774	4-spiral, wire							4000	4000	3000	2500	2500		-40/+176			
	711	4-spiral, wire							3000	3000					-40/+212	100R11		
	781/78C	4-braid, wire							5000	5000	5000	5000			-40/+257	100R13	3862-1-R13	856-R13
	782TC/ST	4-braid, wire							5000	5000	5000	5000			-40/+257	100R13	3862-1-R13	856-R13
	701	6-spiral, wire			6000	5000									-40/+212		3862-1-4SP	856-4SP
	731	6-spiral, wire							700	420					-40/+120		3862-1-4SH	856-4SH
	791TC	6-spiral, wire							3000	6000					-40/+257	100R15	3862-1-R15	
	792TC/ST	6-spiral, wire							3000						-40/+257	100R15	3862-1-R15	
	761	6-spiral, wire							8000						-40/+257			
	JK	2-braids, wire	10500		10100										-40/+120			
	811 with HC/TB	1-braid, 1-spiral wire						100	70	50					-40/+212			
	811 with HC/81	1-braid, 1-spiral wire													-40/+212	100R4		
	811 with 81/DB	1-braid, 1-spiral wire									200	150	100		-40/+212	100R4		
	811HT with HC/TB	1-braid, 1-spiral wire						100	70	50	50	50			-40/+257			
	811HT with HC/81	1-braid, 1-spiral wire													-40/+257			
	811HT with 81/DB	1-braid, 1-spiral wire						300	250	200	150	100			-40/+257			
	881 with HC/TB	2-braid, 1-spiral wire						100	70	50	50	50			-40/+257			
	881 with 81	2-braid, 1-spiral wire													-40/+257			
	881 with 43/81/DB	2-braid, 1-spiral wire						300	250	200	150	100			-40/+257			
	804	1-braid, fiber	150		150	150	150								-40/+257			
	801	1-braid, fiber	250		250	250	250	250	175						-40/+257			
	898	1-braid, fiber	250		250	250	250								-40/+257			
	899	1-braid, fiber	250		250	250	250								-40/+257			

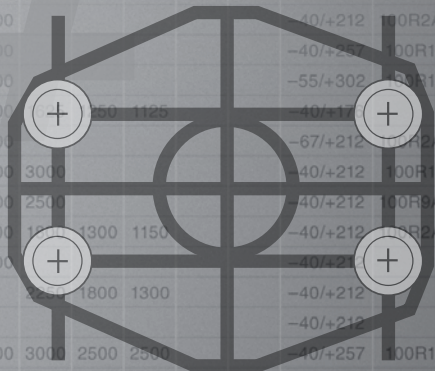

Before You **SPEC** it,

**S** **T** **A** **M** **P** **EN** it.

Size

Temperature

Application

Media

Pressure



SAE

ISO

Hose  
**A**

## Table of Contents

### Size

Flow Capacities at Recommended Flow Velocities ..... E-3  
 Hose Flow Capacities Pressure Drop.....E-4

Fittings  
**B**

### Temperature

Temperature/Pressure Chart - 201, 206, 213, and 266 Hose.....E-5  
 Minimum/ Maximum Temperature Chart .....E-6

Equipment  
**C**

### Application

Hose Installation Tips .....E-10  
 Ferrule-Fix .....E-11  
 Hose, Adapters and Fittings Standards and Specifications.....E-12  
 Assembly Methods .....E-15  
 Thread Guide.....E-16  
 Standard Fitting Configurations by Connection and End Code .....E-17  
 Metric Conversions.....E-19

Accessories  
**D**

### Media

Chemical Resistance Information..... E-20

Technical  
**E**

### Pressure

Working Pressure Chart .....E-30  
 Pressure Rating of Hose End Connections .....E-32  
 Metric Pressure Conversions .....E-33

Part Number Index .....E-34  
 Fitting Size Identification Chart.....E-38

Safety Guide & MSDS Statement.....E-40  
 Offer of Sale .....E-44

# Size

## Flow Capacities at Recommended Flow Velocities

The nomogram below is provided as an aid in determining the correct hose size.

How to use the nomogram: Determine the proper flow rate your system requires, then connect a straight edge from the selected flow rate to the recommended velocity range. The required hose I.D. will appear at the intersection of the straight edge and the center column. If the straight edge passes through the scale between sizes listed, use the next larger I.D. hose.

Example: Locate 16 gallons per minute in the left-hand column and 20 feet per second (fps) in the right-hand column (the maximum

recommended velocity range for pressure lines). Lay a straight edge across these two points. The inside diameter required is shown in the center column at or above the straight edge. In this case, we need a hose I.D. of 0.625 (5/8") inch (or larger).

Use the same procedure for suction or return lines, except utilizing their respective maximum recommended velocities.

Flow  
Gallons per Minute

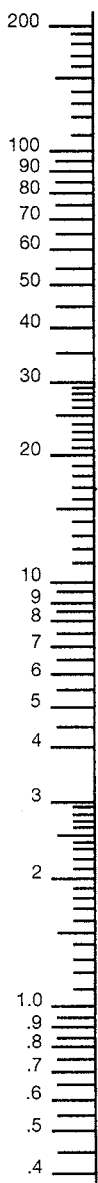

The nomogram is based on the following formula:

$$D = \sqrt{\frac{Q \times 0.4081}{V}}$$

Where: Q = Flow in Gallons per Minute (gpm)  
V = Velocity in Feet per Second (ft/sec)  
D = Hose Inside Diameter (inches)

Inside Diameter of Hose  
Inch / Dash Size  
20, 21, 22, 23, All Others  
Group XV, 90, 91

2-3/8"	40	32	2"
1-13/16"	32	24	1-1/2"
1-3/8"	24	20	1-1/4"
1-1/8"	20	16	1"
7/8"	16	12	3/4"
5/8"	12	10	5/8"
1/2"	10	8	1/2"
13/32"	8	6	3/8"
5/16"	6	5	5/16"
1/4"	5	4	1/4"
3/16"	4	3	3/16"

Velocity  
Feet per Second

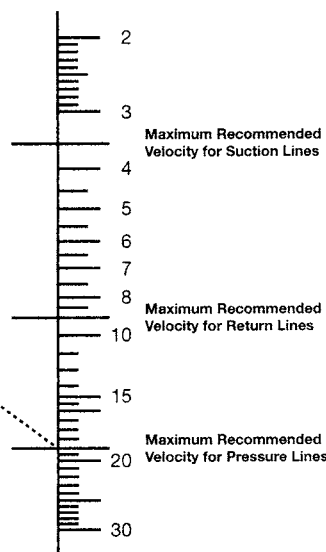

Hose  
**A**

Fittings  
**B**

Equipment  
**C**

Accessories  
**D**

Technical  
**E**

# Size

## Hose Flow Capacities Pressure Drop

Hose Dash Size	-04		-05		-06		-08		-10		-12		-16		-20		-24		-32		-40	-48	
Hose I.D. (Inches)	0.19	0.25	0.25	0.31	0.31	0.38	0.41	0.50	0.50	0.63	0.63	0.75	0.88	1.00	1.13	1.25	1.38	1.50	1.81	2.00	2.38	3.00	
0.25	10.0	3.1	3.1																				
0.5	19.0	6.0	6.0	2.7	2.7																		
1	40.0	12.0	12.0	5.5	5.5	2.4																	
2	95.0	24.0	24.0	10.0	10.0	4.8	3.5																
3	185.0	46.0	46.0	17.0	17.0	7.0	5.0	2.2	2.2														
4		78.0	78.0	29.0	29.0	12.0	8.0	3.0	3.0	1.2	1.2												
5		120.0	120.0	44.0	44.0	18.0	12.0	4.5	4.5	1.6	1.6	0.7											
8				95.0	95.0	39.0	26.0	10.0	10.0	3.6	3.6	1.4	0.6										
10						59.0	40.0	15.0	15.0	5.7	5.7	2.0	1.0	0.6									
12						80.0	52.0	20.0	20.0	7.2	7.2	2.6	1.5	0.8	0.4								
15							75.0	30.0	30.0	10.0	10.0	4.2	2.2	1.2	0.7	0.4							
18							107.0	40.0	40.0	15.0	15.0	6.3	3.0	1.5	0.7	0.6	0.4						
20								49.0	49.0	19.0	19.0	8.0	3.4	2.0	1.1	0.7	0.4	0.3					
25								72.0	72.0	26.0	26.0	11.0	5.5	3.0	1.6	1.0	0.6	0.4	0.2				
30										34.0	34.0	14.0	7.0	3.6	2.2	1.3	0.8	0.5	0.2	0.1			
35										47.0	47.0	19.0	9.5	5.0	2.8	1.7	1.1	0.7	0.3	0.2			
40												25.0	12.0	6.5	3.4	2.2	1.4	0.9	0.4	0.2			
50												36.0	17.0	9.0	5.3	3.3	2.0	1.3	0.5	0.4	0.2		
60												50.0	23.0	12.0	7.5	4.4	2.8	1.8	0.8	0.5	0.2		
70													31.0	17.0	9.3	6.0	3.8	2.4	1.0	0.7	0.3		
80													38.0	21.0	12.0	7.1	4.6	3.0	1.2	0.8	0.3	0.1	
90													49.0	27.0	15.0	9.0	5.9	3.8	1.5	1.0	0.5	0.1	
100														33.0	19.0	12.0	7.0	4.7	1.9	1.3	0.6	0.2	
150														60.0	36.0	22.0	13.0	8.5	3.4	2.2	1.0	0.3	
200																36.0	23.0	15.0	6.0	3.9	1.7	0.6	
250																54.0	33.0	22.0	8.5	5.3	2.5	0.8	
300																	45.0	29.0	12.0	7.5	4.0	1.1	
400																		51.0	21.0	14.0	6.5	2.2	
500																			32.0	20.0	10.0	3.0	
800																					18.0	5.0	
1000																							10.0

U.S. Gallons per Minute

Pressure drop in psi (pounds per square inch) per 10 feet of hose (smooth bore) without fittings.

Fluid specification: Specific gravity = 0.85; Viscosity =  $\nu$  = 20 centistokes (C.S.), (20 C.S. = 97 S.S.U.)

Pressure drop values listed are typical of many petroleum based hydraulic oils at approximately +100°F (+38°C). Differences in fluids, fluid temperature and viscosity can increase or decrease actual pressure drop compared to the values listed.

A Hose

B Fittings

C Equipment

D Accessories

M Technical



# T emperature

## Temperature / Pressure Chart - 201, 206, 213, and 266 Hose

The Temperature / Pressure Chart identifies the effects temperature change has on the maximum working pressure of specific hoses.

**How to use the chart:**

- 1st - Identify the Maximum Working Pressure of selected hose.
- 2nd - Identify the maximum working temperature of the application.
- 3rd - Locate point where temperature and Percent of Maximum Working Pressure intersect on the chart.
- 4th - Based on percentage figure, calculate Maximum Working Pressue of the application.

**Example: 201-8 hose to be used a 250°F (121°C)**

Maximum Working Pressure up to 212°F (100°C)	x	(Multiplier from chart)	=	Maximum Working Pressure at 250°F (121°C)
2,000 psi	x	(85%)	=	1,700 psi

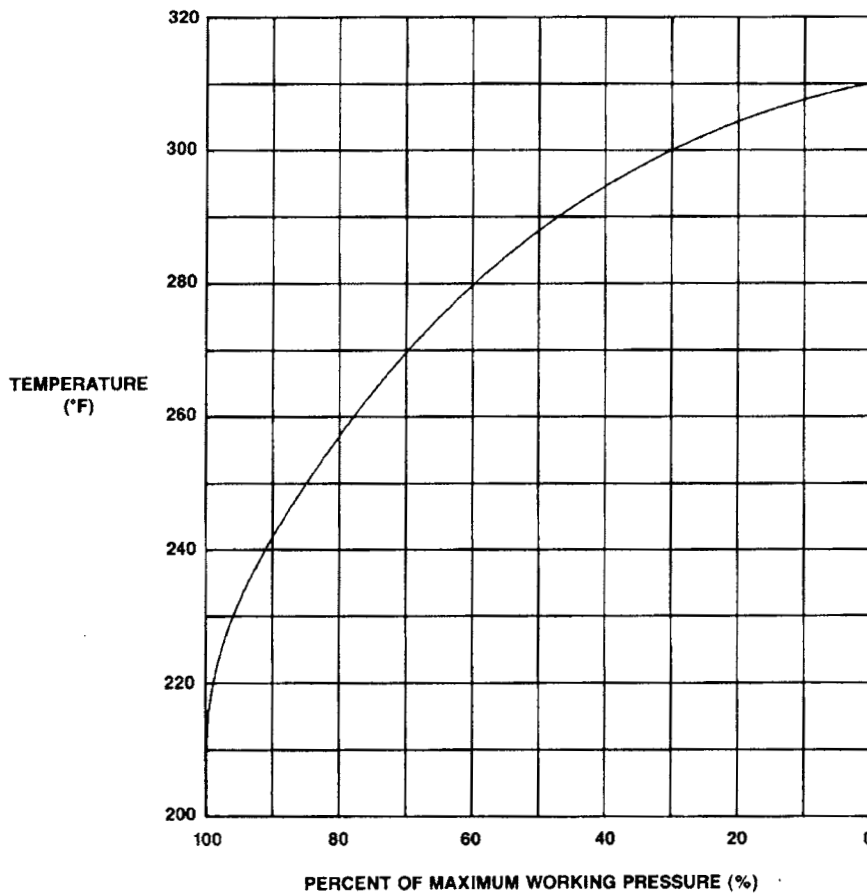

Hose  
**A**

Fittings  
**B**

Equipment  
**C**

Accessories  
**D**

Technical  
**E**

# T emperature

## Minimum/Maximum Temperature

(Page 1 of 4)

A  
Hose

B  
Fittings

C  
Equipment

D  
Accessories

M  
Technical

Hose	Petroleum base hydraulic fluids and lubricating oils	Antifreeze solutions	Diesel fuels	SAE J1942 Marine lube oil and diesel fuel systems (Application Code F)**
201*	-40°C to +150°C (-40°F to +302°F)	-40°C to +150°C (-40°F to +302°F)	-40°C to +150°C (-40°F to +302°F)	x
206*	-48°C to +150°C (-55°F to +302°F)	-48°C to +150°C (-55°F to +302°F)	-48°C to +150°C (-55°F to +302°F)	x
213*	-45°C to +150°C (-50°F to +302°F)	-45°C to +150°C (-50°F to +302°F)	-45°C to +150°C (-50°F to +302°F)	x
221FR	-20°C to +100°C (-4°F to +212°F)	x	-20°C to +100°C (-4°F to +212°F)	-20°C to +100°C (-4°F to +212°F)
225	-40°C to +100°C (-40°F to +212°F)	-40°C to +100°C (-40°F to +212°F)	-40°C to +100°C (-40°F to +212°F)	-40°C to +100°C (-40°F to +212°F)
266*	-48°C to +150°C (-55°F to +302°F)	-48°C to +150°C (-55°F to +302°F)	-48°C to +150°C (-55°F to +302°F)	x
271	x	x	x	x
293	-50°C to +150°C (-58°F to +302°F)	-50°C to +150°C (-58°F to +302°F)	-50°C to +150°C (-58°F to +302°F)	x
302	-40°C to +100°C (-40°F to +212°F)	x	x	-40°C to +100°C (-40°F to +212°F)
304	x	x	x	x
341	-40°C to +100°C (-40°F to +212°F)	x	x	-40°C to +100°C (-40°F to +212°F)
351TC/ST	-40°C to +100°C (-40°F to +212°F)	x	x	x
421WC	-40°C to +125°C (-40°F to +257°F)	x	x	x
422	-40°C to +100°C (-40°F to +212°F)	x	x	-40°C to +100°C (-40°F to +212°F)
424	x	x	x	x
426	-46°C to +150°C (-50°F to +302°F)	x	x	-46°C to +150°C (-50°F to +302°F)
431	-40°C to +125°C (-40°F to +257°F)	x	x	x
436	-48°C to +150°C (-55°F to +302°F)	x	x	x
451TC/ST	-40°C to +100°C (-40°F to +212°F)	x	x	x
471TC/ST	-40°C to +100°C (-40°F to +212°F)	x	x	x
472TC	-40°C to +100°C (-40°F to +212°F)	x	x	x
482TC/ST	-40°C to +100°C (-40°F to +212°F)	x	x	x
601	-40°C to +125°C (-40°F to +257°F)	x	x	x
701	-40°C to +100°C (-40°F to +212°F)	x	x	x
711	-40°C to +100°C (-40°F to +212°F)	x	x	x
721	-40°C to +125°C (-40°F to +257°F)	x	x	x
721TC/ST	-40°C to +125°C (-40°F to +257°F)	x	x	x
F42	x	x	x	x
301LT	-55°C to +100°C (-67°F to +212°F)	x	x	x

\* The maximum working pressures for these hoses are reduced at temperatures above +212°F (+100°C). Consult the pressure/temperature curve on E-5 for the reduced maximum working pressure.

\*\* Maximum service pressure for lube oil and fuel systems applications (Code F) may be less than maximum service pressure for other systems applications, e.g., Code H. Refer to individual hose listings in Section A and Hose Assemblies List, SAE J1942-1 or HPD Approval Bulletin #APR-004.

# T emperature

## Minimum/Maximum Temperature (Page 2 of 4)

Hose	Petroleum base hydraulic fluids and lubricating oils	Antifreeze solutions	Diesel fuels	SAE J1942 Marine lube oil and diesel fuel systems (Application Code F)**
731	-40°C to +100°C (-40°F to +212°F)	x	x	x
761	-40°C to +125°C (-40°F to +257°F)	x	x	x
772TC/ST	-40°C to +125°C (-40°F to +257°F)	x	x	x
774	x	x	x	x
781	-40°C to +125°C (-40°F to +257°F)	x	x	x
782TC/ST	-40°C to +125°C (-40°F to +257°F)	x	x	x
P35	-40°C to +125°C (-40°F to +257°F)	x	x	x
791TC	-40°C to +125°C (-40°F to +257°F)	x	x	x
792TC/ST	-40°C to +125°C (-40°F to +257°F)	x	x	x
801	-40°C to +100°C (-40°F to +212°F)	-40°C to +100°C (-40°F to +212°F)	x	x
804	x	x	x	x
811	-40°C to +100°C (-40°F to +212°F)	x	x	x
821	-40°C to +100°C (-40°F to +212°F)	-40°C to +100°C (-40°F to +212°F)	x	x
821FR	-40°C to +100°C (-40°F to +212°F)	-40°C to +100°C (-40°F to +212°F)	x	x
836	-48°C to +150°C (-55°F to +302°F)	-48°C to +150°C (-55°F to +302°F)	x	x
881	-40°C to +125°C (-40°F to +257°F)	x	x	x
AX	-40°C to +100°C (-40°F to +212°F)	x	x	x
BXX	-40°C to +100°C (-40°F to +212°F)	x	x	x
JK	-40°C to +49°C (-40°F to +120°F)	x	x	x
SS23CG	x	x	x	x
SS25UL	x	x	x	x
811HT	-46°C to +125°C (-50°F to +257°F)	x	x	x

\* The maximum working pressures for these hoses are reduced at temperatures above +212°F (+100°C). Consult the pressure/temperature curve on E-5 for the reduced maximum working pressure.

\*\* Maximum service pressure for lube oil and fuel systems applications (Code F) may be less than maximum service pressure for other systems applications, e.g., Code H. Refer to individual hose listings in Section A and Hose Assemblies List, SAE J1942/1 or HPD Approval Bulletin #APR-004.

Hose  
**A**

Fittings  
**B**

Equipment  
**C**

Accessories  
**D**

Technical  
**E**



# T emperature

## Minimum/Maximum Temperature

(Page 3 of 4)

Hose  
**A**

Fittings  
**B**

Equipment  
**C**

Accessories  
**D**

Technical  
**M**

Hose	Air	Water, water/oil emulsion	Water/glycol hydraulic	Water	Phosphate ester fluids	Polyol ester fluids
201*	+70°C (+158°F)	+85°C (+185°F)	+85°C (+185°F)	+85°C (+185°F)	x	x
206*	+100°C (+212°F)	+85°C (+185°F)	+85°C (+185°F)	+85°C (+185°F)	x	x
213*	+100°C (+212°F)	+85°C (+185°F)	+85°C (+185°F)	+85°C (+185°F)	x	x
221FR	+70°C (+158°F)	+85°C (+185°F)	+85°C (+185°F)	+85°C (+185°F)	x	x
225	+65°C (+150°F)	+85°C (+185°F)	+85°C (+185°F)	+85°C (+185°F)	x	x
266*	+93°C (+200°F)	+85°C (+185°F)	+85°C (+185°F)	+85°C (+185°F)	x	x
271	100°C (212°F)	x	x	x	x	x
293	+93°C (+200°F)	+85°C (+185°F)	+85°C (+185°F)	+85°C (+185°F)	x	x
302	+70°C (+158°F)	+85°C (+185°F)	+85°C (+185°F)	+85°C (+185°F)	x	x
304	+70°C (+158°F)	x	+85°C (+185°F)	+85°C (+185°F)	-40°C to +80°C (-40°F to +176°F)	x
341	+70°C (+158°F)	+85°C (+185°F)	+85°C (+185°F)	+85°C (+185°F)	x	x
351TC/ST	+70°C (+158°F)	+85°C (+185°F)	+85°C (+185°F)	+85°C (+185°F)	x	x
421WC	+70°C (+158°F)	+85°C (+185°F)	+85°C (+185°F)	+85°C (+185°F)	x	x
422	+70°C (+158°F)	+85°C (+185°F)	+85°C (+185°F)	+85°C (+185°F)	x	x
424	+70°C (+158°F)	x	+85°C (+185°F)	+85°C (+185°F)	-40°C to +80°C (-40°F to +176°F)	x
426	+70°C (+158°F)	+85°C (+185°F)	+85°C (+185°F)	+85°C (+185°F)	x	x
431	+70°C (+158°F)	+85°C (+185°F)	+85°C (+185°F)	+85°C (+185°F)	x	x
436	+70°C (+158°F)	+85°C (+185°F)	+85°C (+185°F)	+85°C (+185°F)	x	x
451TC/ST	+70°C (+158°F)	+85°C (+185°F)	+85°C (+185°F)	+85°C (+185°F)	x	x
471TC/ST	+70°C (+158°F)	+85°C (+185°F)	+85°C (+185°F)	+85°C (+185°F)	x	x
472TC	+70°C (+158°F)	+85°C (+185°F)	+85°C (+185°F)	+85°C (+185°F)	x	+65°C (+150°F)
482TC/ST	+70°C (+158°F)	+85°C (+185°F)	+85°C (+185°F)	+85°C (+185°F)	x	+65°C (+150°F)
601	+70°C (+158°F)	+85°C (+185°F)	+85°C (+185°F)	+85°C (+185°F)	x	x
701	+70°C (+158°F)	+85°C (+185°F)	+85°C (+185°F)	+85°C (+185°F)	x	x
F42	+70°C (+158°F)	x	+85°C (+185°F)	+85°C (+185°F)	-40°C to +80°C (-40°F to +176°F)	x
301LT	+70°C (+158°F)	+85°C (+185°F)	+85°C (+185°F)	+85°C (+185°F)	x	x

\* The maximum working pressures for these hoses are reduced at temperatures above +212°F (+100°C). Consult the pressure/temperature curve on E-5 for the reduced maximum working pressure.

\*\* Maximum service pressure for lube oil and fuel systems applications (Code F) may be less than maximum service pressure for other systems applications, e.g., Code H. Refer to individual hose listings in Section A and Hose Assemblies List, SAE J1942/1 or HPD Approval Bulletin #APR-004.



# T emperature

## Minimum/Maximum Temperature

(Page 4 of 4)

Hose	Air	Water, water/oil emulsion	Water/glycol hydraulic	Water	Phosphate ester fluids	Polyol ester fluids
711	+70°C (+158°F)	+85°C (+185°F)	+85°C (+185°F)	+85°C (+185°F)	x	x
721	+70°C (+158°F)	+85°C (+185°F)	+85°C (+185°F)	+85°C (+185°F)	x	x
721TC/ST	+70°C (+158°F)	+85°C (+185°F)	+85°C (+185°F)	+85°C (+185°F)	x	x
731	+70°C (+158°F)	+85°C (+185°F)	+85°C (+185°F)	+85°C (+185°F)	x	x
761	+70°C (+158°F)	+85°C (+185°F)	+85°C (+185°F)	+85°C (+185°F)	x	x
772TC/ST	+70°C (+158°F)	+85°C (+185°F)	+85°C (+185°F)	+85°C (+185°F)	x	+65°C (+150°F)
774	+70°C (+158°F)	x	+85°C (+185°F)	+85°C (+185°F)	-40°C to +80°C (-40°F to +176°F)	x
781	+70°C (+158°F)	+85°C (+185°F)	+85°C (+185°F)	+85°C (+185°F)	x	x
782TC/ST	+70°C (+158°F)	+85°C (+185°F)	+85°C (+185°F)	+85°C (+185°F)	x	+65°C (+150°F)
P35	+70°C (+158°F)	+85°C (+185°F)	+85°C (+185°F)	+85°C (+185°F)	x	x
791TC	+70°C (+158°F)	+85°C (+185°F)	+85°C (+185°F)	+85°C (+185°F)	x	x
792TC/ST	+70°C (+158°F)	+85°C (+185°F)	+85°C (+185°F)	+85°C (+185°F)	x	+65°C (+150°F)
801	+70°C (+158°F)	+85°C (+185°F)	+85°C (+185°F)	+85°C (+185°F)	x	x
804	+70°C (+158°F)	x	+93°C (+200°F)	+93°C (+200°F)	+80°C (+176°F)	x
811	+70°C (+158°F)	+85°C (+185°F)	+85°C (+185°F)	+85°C (+185°F)	x	x
821	+70°C (+158°F)	+85°C (+185°F)	+85°C (+185°F)	+85°C (+185°F)	x	x
821FR	+100°C (+212°F)	+85°C (+185°F)	+85°C (+185°F)	+85°C (+185°F)	x	x
836	+100°C (+212°F)	+85°C (+185°F)	+85°C (+185°F)	+85°C (+185°F)	x	x
881	+70°C (+158°F)	+85°C (+185°F)	+85°C (+185°F)	+85°C (+185°F)	x	x
AX	+70°C (+158°F)	+85°C (+185°F)	+85°C (+185°F)	+85°C (+185°F)	x	x
BXX	+70°C (+158°F)	+85°C (+185°F)	+85°C (+185°F)	+85°C (+185°F)	x	x
JK	x	x	x	x	x	x
SS23CG	x	x	x	x	x	x
SS25UL	x	x	x	x	x	x
811HT	+70°C (+158°F)	+85°C (+185°F)	+85°C (+185°F)	+85°C (+185°F)	x	x

\* The maximum working pressures for these hoses are reduced at temperatures above +212°F (+100°C). Consult the pressure/temperature curve on E-5 for the reduced maximum working pressure.

\*\* Maximum service pressure for lube oil and fuel systems applications (Code F) may be less than maximum service pressure for other systems applications, e.g., Code H. Refer to individual hose listings in Section A and Hose Assemblies List, SAE J1942/1 or HPD Approval Bulletin #APR-004.

Hose  
**A**

Fittings  
**B**

Equipment  
**C**

Accessories  
**D**

Technical  
**E**

# A Application

## Hose Installation Tips

Hose  
**A**

Fittings  
**B**

Equipment  
**C**

Accessories  
**D**

Technical  
**M**

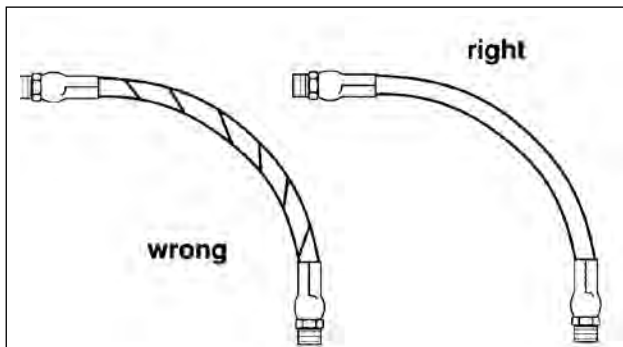

1. Hose is weakened when installed in twisted position. Pressure in twisted hose tends to loosen fitting connections. Design so that machine motion produces bending rather than twisting.

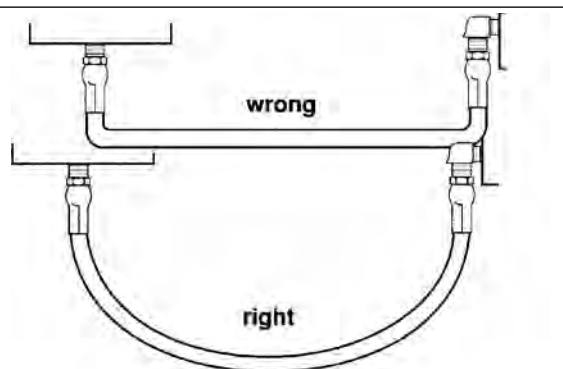

2. Ample bend radius should be provided to avoid collapsing of line and restriction of flow.

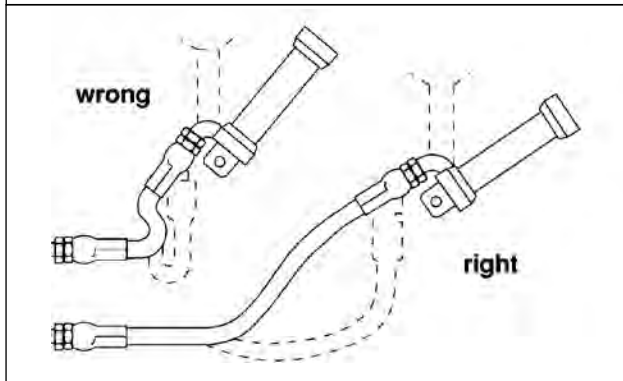

3. Exceeding minimum bend radius will greatly reduce hose assembly life.

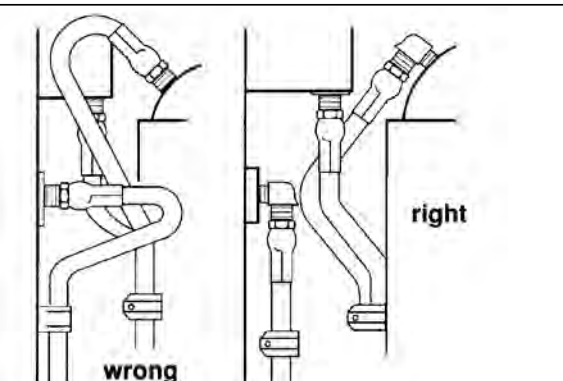

4. Use elbows or other adapters as necessary to eliminate excess hose length and to insure neater installation for easier maintenance.

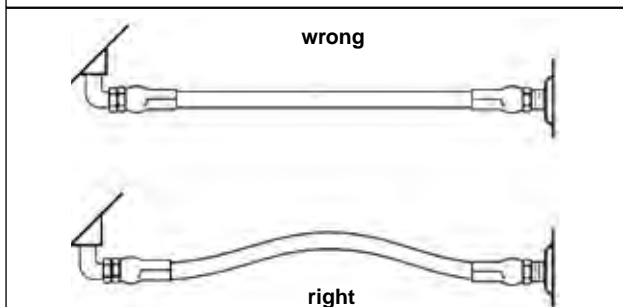

5. When hose assembly is installed in a flexing application, remember that metal hose fittings are not part of the flexible portion. Allow ample free length for flexing.

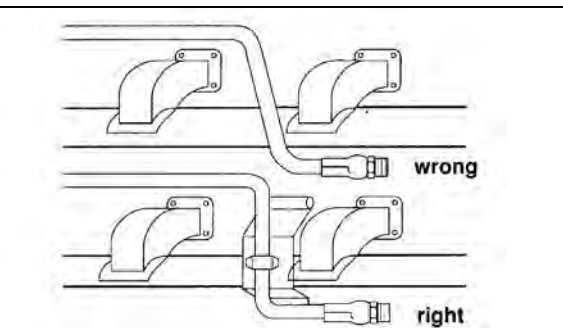

6. When properly routing, use clamps to secure the hose in its proper position.

# A Application

## Ferrule-Fix



### Fast, on-the-job repair for ruptured bent tube hose assemblies and power steering lines.

The life of the combination tube-hose assembly is often limited to the service life of the hose alone. A replacement assembly may not be available, some equipment dealers are unable to stock all of the many odd tube configurations.

Parker FERRUL-FIX, a field attachable, reusable hose end fitting, now makes it possible to salvage the bent tube section of the original assembly for replacement. Most important, it gets you back into operation FAST!

- Gets you back in operation fast - No costly delays while replacement assemblies are rushed from the factory.
- Lets you reuse expensive bent tube ends with Parker Hose fittings - You can replace the hose at a fraction of the cost of complete assembly.

- Eliminates the need for emergency brazing or welding in the field - Ferrul-Fix can be assembled without special tools or equipment when using Parker Reusable Hose fittings.

**3-Piece Design** - Body, nut and ferrule. Wedging action of ferrule, when drawn down by nut, forms seal between body and ferrule, while cutting edge of ferrule "bites" into tube wall forming another positive seal.

**Visible Bite** - Extent of bite at cutting edge of ferrule is completely visible when fitting is dis-assembled, an important safety feature. Self-centering action assures even bite around circumference of tube.

**Parkerized Finish** - Ferrul-Lok fittings have the Parkerized black finish, providing "built-in" lubrication which reduces wrench torque required.

## Ferrul-Fix Installation Instructions



1. Cut the formed tube off squarely next to the permanent hose fitting. Lightly deburr the end of the tube internally and externally.
2. Disassemble the Ferrul-Fix fitting, and lubricate threads and both ends of the ferrule with Parker Ferulube.
3. Slide nut and ferrule onto tubing, with the long, straight end of the ferrule pointing toward the tube end.
4. Insert tube end into the Ferrul-Fix body until it bottoms against the shoulder. Slide ferrule inside body, and screw nut down finger tight.
5. Wrench nut down 1-3/4 turns to preset the ferrule.
6. Disconnect nut and inspect lead edge of ferrule to make certain that the biting edge has turned up a shoulder to a height of at least 50% of the ferrule and completely around the tube.
7. Assemble Ferrul-Fix fitting to hose. Refer to assembly instructions listed in appropriate fittings section. Do not assemble to hose before steps 1-6.
8. Reassemble tubing into Ferrul-Fix end and turn nut down easily until a sudden increase in force is evident. Turn bent tube to proper position if required. Using two wrenches, one on the fitting nipple hex and the other on the nut tighten nut an additional 1/6 turn (one wrench flat).

Hose  
**A**

Fittings  
**B**

Equipment  
**C**

Accessories  
**D**

Technical  
**E**

# A Application

# Standards and Specifications

Hose	SAE J517	SAE Other	DOT FMVSS 106	USCG MTH (1)	ISO	DNV (2)	EN	MSHA (3)	German Lloyd	ABS	UL-21 LPG	Other
AX		J1942		H				X				
BXX	100R2AT	J1942		H				X				
JK												1J100
SS25UL											X	
SS23CG											X	CSA-CGA-8.1-M86
201	100R5	J1402 All	All									
206	100R5	J1402 All	All									
213		J1402 AI	AI									
221FR (4)		J1527 AI, J1942		HF	ISO 7840			X	X	X		ABYC
225	100R5	J1942		F*,H*,HF*				X				
235		J51-Type D						X				
244		J2064 Type B										
266		J1402 All	All									
285		J2064 Type C										
293		J1402 AI	AI									
302	100R2AT	J1942		F*,H*,HF*	ISO 1436-1 Type 2SN		EN 853 Type 2SN					
301LT	100R2AT	J1942		H				X				
304												
341	100R9AT	J1942		HF				X				
351ST								X				
351TC								X				
422	100R1AT	J1942		F*,H*,HF*	ISO 1436-1 Type 1SN		EN 853 Type 1SN					
421WC												
424	100R1AT											
426	100R1AT	J1942		HF				X		X		
431	100R16	J1942		H				X				
436	100R16	J1942		H				X		X		
451ST	100R17							X				
451TC	100R17	J1942		H				X		X		
471ST					ISO 11237-1 Type 2SC		EN857-Type 2SC	X				
471TC					ISO 11237-1 Type 2SC		EN857-Type 2SC	X		X		
472TC					ISO 11237-1 Type 2SC		EN857-Type 2SC	X				
482ST	100R1AT				ISO 1436-1 Type 1SN		EN853-Type 1SN	X				
482TC	100R1AT				ISO 1436-1 Type 1SN		EN853-Type 1SN	X	X			
601	100R3	J1942		H	ISO 4079-Type R3		EN854-Type R3	X				

Continued on next page

A Hose

B Fittings

C Equipment

D Accessories

E Technical

# A Application

# Standards and Specifications

Continued from previous page

Hose	SAE J517	SAE Other	DOT FMVSS 106	USCG MTH (1)	ISO	DNV (2)	EN	MSHA (3)	Ger-man Lloyd	ABS	UL-21 LPG	Other
604												
701		J1942		H	ISO 3862-1 Type 4SP		EN856-Type 4SP		X			
711												
721	100R12				ISO 3862-1 Type R12		EN856-Type R12	X				
721TC	100R12				ISO 3862-1 Type R12		EN856-Type R12	X				
731		J1942		H	ISO 3862-1 Type 4SH		EN856-Type 4SH					
772ST	100R12				ISO 3862-1 Type R12		EN856-Type R12	X				
772TC	100R12				ISO 3862-1 Type R12	X	EN856-Type R12	X		X		
774												
P35	100R13				ISO 3862-1 Type R13	X	EN856-Type R13	X		X		
781	100R13				ISO 3862-1 Type R13		EN856-Type R13	X				
782ST	100R13				ISO 3862-1 Type R13		EN856-Type R13	X				
782TC	100R13				ISO 3862-1 Type R13	X	EN856-Type R13	X		X		
791TC	100R15				ISO 3862-1 Type R15			X				
792ST	100R15				ISO 3862-1 Type R15			X				
792TC	100R15				ISO 3862-1 Type R15			X		X		
801								X				
804												
811	100R4											
821												
821FR												
831								X				
836								X				
881	100R4	J1942		H				X				

Notes:

(1) U.S.C.G./MTH (Marine Technical & Hazardous Materials Branch) hoses, hose assemblies and appropriate fittings meet 46CFR56.60-25(c) for use on commercial vessels. Hoses and hose assemblies meet the requirements of SAE J1942. Hose fittings meet the requirements of SAE J1475.

F = Fuel and lube systems.

H = Hydraulic Systems.

\*Some hoses are accepted for different pressures for F and H. Also, not all sizes are accepted for all applications. See HPD approval bulletin #APR-004 or consult the Parker Hose Products Division, Technical Services Department, for details. The Canadian Coast Guard accepts all hoses accepted by the U.S. Coast Guard.

(2) Det Norske Veritas (DnV) approvals are with permanent (crimp) type fittings only. See HPD Approval Bulletin #APR-006 or consult the Parker Hose Products Division, Technical Services Department, for details.

(3) Hose with MSHA (Mine Safety and Health Administration) approved flame resistant cover will be marked accordingly on the layline.

(4) 221FR is type accepted by Lloyd's Register. It meets the requirements of the American Boat and Yacht council. 221FR is certified to meet the EC Directive 94/25/EC in accordance with ISO 7840.

**For questions on standards and specifications please contact the Hose Products' Technical Services Department at (440) 943-5700 or visit our website at <http://www.parkerhose.com> and go to the products tab. Click on approvals to find a complete list of updated hose specifications.**

Hose  
**A**

Fittings  
**B**

Equipment  
**C**

Accessories  
**D**

Technical  
**E**

# A pplication

## Standards and Specifications

### JIS - Adapters

JIS B8363 Code	Parker Part Number	Mates with End Configuration
A1	F3T4	FU
A2	F3P4	GU
A3	F63P4	UT
E1	C3T4	FU
E2	C3P4	GU
E3	V3T4	FU
E4	V3P4	GU

Note: See website at [www.Parker/tfd.com](http://www.Parker/tfd.com), Catalog 4300 or call (614) 279-7070 for additional information.

### JIS - Hose Fittings

JIS B8363 Code	Parker End Configuration Code	Fitting Series 43	Fitting Series 70	Fitting Series 71	Fitting Series 73	Fitting Series 78	Fitting Series 79
R	UT	X		X			
F	FU	X		X			
C	GU	X	X	X	X	X	
MF	MU	X		X			
S	15	X	X	X	X	X	
4S	17	X	X	X	X	X	
9S	19	X	X	X	X	X	
H	6A		X	X	X	X	X
4H	6F			X	X	X	X
9H	6N		X	X	X	X	X

Note: Parker Hose Standards are listed on page E-12 and E-13

Hose  
A

Fittings  
B

Equipment  
C

Accessories  
D

Technical  
E

# A Application

## Assembly Methods

### JIC 37° and SAE 45° Flare

Parker's recommended assembly method for JIC 37° flare and SAE 45° flare is the Flats From Wrench Resistance (FFWR) method. This includes steel as well as other materials.

The torque values assigned by size are for reference only, and are only applicable to Parker system components using the FFWR method with trivalent chromate passivation on zinc plating of carbon steel components without lubrication.

Dash Size	Flats From Wrench Resistance (FFWR)	Swivel Nut Torque	
		Newton Meters (Ref)	Pound Feet (Ref)
-4	2	18	13
-5	2	23	17
-6	1-1/2	30	22
-8	1-1/2	57	42
-10	1-1/2	81	60
-12	1-1/4	114	84
-16	1	160	118
-20	1	228	168
-24	1	265	195
-32	1	360	265

### Seal-Lok®

Parker's recommended assembly method for Seal-Lok® connections is the torque method.

Dash Size	Swivel Nut Torque		Flats From Wrench Resistance (FFWR)
	Newton Meters (+10% / -0)	Pound Feet (+10% / -0)	
-4	25	18	1/2 - 3/4
-6	40	30	1/2 - 3/4
-8	55	40	1/2 - 3/4
-10	80	60	1/2 - 3/4
-12	115	85	1/3 - 1/2
-16	150	110	1/3 - 1/2
-20	205	150	1/3 - 1/2
-24	315	230	1/3 - 1/2
-32	-	-	-

Note: The assembly torques listed are higher than the test torques published in SAE J1453.

### Torque Conversion Equivalents

Torque Conversion Equivalents		
Pound Inch - Pound Foot - Newton Meter		
Pound Foot x 12	=	Pound Inch
Pound Foot x 1.356	=	Newton Meter
Newton Meter x 8.850	=	Pound Inch
Newton Meter x 0.737	=	Pound Foot
Pound Inch x .083	=	Pound Foot
Pound Inch x 0.113	=	Newton Meter

The torque values for other materials are as follows:

- Brass fittings and adapters - 65% of the torque value for steel.
- Stainless steel, and Monel - Use 5% higher than listed for steel. Threads to be lubricated for these materials.
- Dissimilar metals - use torque value designated for the lower of the two metals.
- All fittings are dry except as noted above.

The Flats From Wrench Resistance (FFWR) and torque values listed above are consistent with the values recommended by Parker Tube Fittings Division (614) 279-7070 or [www.parker.com/tfd](http://www.parker.com/tfd).



# A Application

# Thread Guide









Hose  
**A**









Fittings  
**B**

Equipment  
**C**

Accessories  
**D**

Technical  
**M**

size								
	NPTF Pipe Thread Size	SAE (JIC) 37 Flare Thread Size	SAE 45 Flare Thread Size	O-Ring Style Straight Thread Size	SAE Inverted Flare Thread Size	PTT 30 Flare Thread Size	SAE Flare-less Thread Size	Seal-Lok Thread
2	1/8 - 27	5/16 - 24	5/16 - 24	5/16 - 24	-	-	5/16 - 24	-
3	-	3/8 - 24	3/8 - 24	3/8 - 24	-	-	3/8 - 24	-
4	1/4 - 18	7/16 - 20	7/16 - 20	7/16 - 20	7/16 - 24	-	7/16 - 20	9/16 - 18
5	-	1/2 - 20	1/2 - 20	1/2 - 20	1/2 - 20	-	1/2 - 20	-
6	3/8 - 18	9/16 - 18	5/8 - 18	9/16 - 18	5/8 - 18	-	9/16 - 18	11/16-16
8	1/2 - 14	3/4 - 16	3/4 - 16	3/4 - 16	3/4 - 18	-	3/4 - 16	13/16 - 16
10	-	7/8 - 14	7/8 - 14	7/8 - 14	7/8 - 18	-	7/8 - 14	1 - 14
12	3/4 - 14	1 1/16 - 12	1 1/6 - 14	1 1/16 - 12	-	-	1 1/16 - 12	1 3/16 - 12
14	-	1 3/16 - 12	-	1 3/16 - 12	-	-	1 3/16 - 12	-
16	1 - 11 1/2	1 5/16 - 12	-	1 5/16 - 12	-	1 5/16 - 14	1 5/16 - 12	1 7/16 - 12
20	1 1/4 - 11 1/2	1 5/8 - 12	-	1 5/8 - 12	-	1 5/8 - 14	1 5/8 - 12	1 11/16 - 12
24	1 1/2 - 11 1/2	1 7/8 - 12	-	1 7/8 - 12	-	1 7/8 - 14	1 7/8 - 12	2-12
32	2 - 11 1/2	2 1/2 - 12	-	2 1/2 - 12	-	2 1/2 - 12	2 1/2 - 12	-

Fitting Size									
	DIN "L" Swivel Female Thread Size	DIN "S" Swivel Female Thread Size	DIN "L" Male Stud Thread Size	DIN "S" Male Stud Thread Size	Male BSPP Thread Size	BSP Swivel Female Thread Size	French Swivel Female Gaz Series	French Swivel Female Metric Series	French Male Stud Metric Series
4	-	-	-	-	1/4x19	1/4x19	--	-	-
6	M12x1,5	M14x1,5	M12x1,5	M14x1,5	3/8x19	3/8x19	-	M12x1	-
8	M14x1,5	M16x1,5	M14x1,5	M16x1,5	1/2x14	1/2x14	-	M14x1,5	-
10	M16x1,5	M18x1,5	M16x1,5	M18x1,5	5/8x14	5/8x14	-	M16x1,5	-
12	M18x1,5	M20x1,5	M18x1,5	M20x1,5	3/4x14	3/4x14	-	M18x1,5	-
-	-	-	-	-	-	-	M20x1,5	-	-
14	-	M22x1,5	-	M22x1,5	-	-	-	M20x1,5	-
15	M22x1,5	-	M22x1,5	-	-	-	-	M22x1,5	-
16	-	M24x1,5	-	M24x1,5	1x11	1x 11	-	M24x1,5	-
-	-	-	-	-	-	-	M24x1,5	-	-
18	M26x1,5	-	M26x1,5	-	-	-	-	M27x1,5	-
20	-	M30x2	-	M30x2	1 1/4x11	1 1/4x11	-	M27x1,5	-
-	-	-	-	-	-	-	M30x 1,5	-	-
22	M30x2	-	M30x2	-	-	-	-	M30x1,5	-
25	-	M36x2	-	M36x2	1 1/2x11	1 1/2x11	-	M33x1,5	-
-	-	-	-	-	-	-	M36x1,5	-	-
28	M36x2	-	M36x2	-	-	-	-	M36x1,5	-
30	-	M42x2	-	M42x2	2x11	2x11	-	M39x1,5	-
33	-	-	-	-	-	-	M45x1,5	-	-



# A Application

## Standard Fitting Configurations by Connection and End Code

	Description	End Code	
Pipe	Male NPTF Pipe - Rigid - Straight	01	
	Male NPTF Pipe - Swivel - Straight	13	
	Male NPTF Pipe - Swivel - 90° Elbow	1L	
	Male API Pipe - Rigid - Straight	AP	
	Female NPTF Pipe - Rigid - Straight	02	
	Female NPSM Pipe - Swivel - Straight (60° Cone)	07	
	Female NPTF Pipe - Swivel - Straight	S2	
	Female NPSM Pipe - Gasket Joint - Swivel - Straight	7G	
	Female Grease Connection - SPL-PTF Taper Thread - Rigid Straight - 1/2 x 27	GJ	
	Male NPTF Pipe - Rigid - 45° Elbow	31	
SAE Str. Thr.	Male NPTF Pipe - Rigid - 90° Elbow or Side Outlet	21	
	Male SAE Straight Thread with O-Ring - Rigid - Straight	05	
	Male SAE Straight Thread with O-Ring - Swivel - Straight	0G	
	Male SAE Straight Thread with O-Ring - Adjustable - 45° Elbow	25	
	Male SAE Straight Thread with O-Ring - Swivel - 90° Elbow	0L	
	Male SAE Straight Thread with O-Ring - Adjustable - 90° Elbow	35	
	Flare	Male JIC 37° - Rigid - Straight	03
		Male JIC 37° - Bulkhead without Locknut - Straight	LB
		Female JIC 37° - Swivel - Straight	06
		Female JIC 37° - Swivel - 45° Elbow - Short Drop	37
Female JIC 37° - Swivel - 45° Elbow - Medium Drop		L7	
Female JIC 37° - Swivel - 90° Elbow - Short Drop		39	
Female JIC 37° - Swivel - 90° Elbow - Medium Drop		L9	
Female JIC 37° - Swivel - 90° Elbow - Long Drop		41	
Female JIC 37° - Swivel - Straight		48	
Female JIC 37° - Swivel - 150° Elbow		4V	
Inverted Flare	Male SAE 45° - Rigid - Straight	04	
	Female SAE 45° - Swivel - Straight	08	
	Female SAE 45 / Swivel - 45° Elbow	77	
	Female SAE 45 / Swivel - 90° Elbow	79	
	Female SAE 45 / Swivel - 90° Elbow - Long Drop	81	
	Female JIC 37°/SAE 45° Dual Flare - Swivel - Straight	68	
	Male Inverted SAE 45° - Swivel - Straight	28	
	Male Inverted SAE 45° - Swivel - 45° Elbow	67	
	Male Inverted SAE 45° - Swivel - 90° Elbow	69	
	Male Inverted SAE 45° - Swivel - 90° Elbow - Long (In-Line)	71	
Tube-O	Female Inverted SAE 45° - Rigid - Straight	29	
	Male Tube-O - Swivel - Straight - Short Pilot	S5	
Tube-O	Male Tube-O - Swivel - Straight - Short Pilot with Charge Port for R12	S5-PR	
	Male Tube-O - Swivel - Straight - Long Pilot	45	
	Male Tube-O - Swivel - Straight - Long Pilot with Charge Port for R12	45-PR	

	Description	End Code
Tube-O	Male Tube-O - Swivel - Straight - Long Pilot with Charge Port for R134a	45-PT
	Female Tube-O - Swivel - 90° Elbow - Long Pilot	5L
	Female Tube-O - Swivel - 90° Elbow - Long Pilot with Charge Port for R12	5L-PB
	Female Tube-O - Swivel - 90° Elbow - Long Pilot with Charge Port for R12	5L-PR
	Female Tube-O - Swivel - 90° Elbow - Long Pilot with Charge Port for R134a	5L-PT
	Male Tube-O - Swivel - 90° Elbow - Long Pilot	5M
	Male Tube-O - Swivel - 90° Elbow - Long Pilot with Charge Port for R12	5M-PR
	Male Tube-O - Swivel - 90° Elbow - Long Pilot with Charge Port for R134a	5M-PT
	Male Tube-O - Swivel - 90° Elbow - Long Pilot with Charge Port for R134a	5M-PV
	Male Tube-O - Rigid - Straight - Internal Long Pilot (3-Step)	5G
Compressor	Male Tube-O - Rigid - Straight - Internal Long Pilot (3-Step) with Charge Port for R12	5G-PR
	Male Tube-O - Swivel - 45° Elbow - Short Pilot	5R
	Male Tube-O - Swivel - 45° Elbow - Long Pilot	5P
	Male Tube-O - Swivel - 45° Elbow - Long Pilot with Charge Port for R134a	5P-PT
	Male Tube-O - Swivel - 90° Elbow - Short Pilot	5K
	Male Tube-O - Swivel - 90° Elbow - Short Pilot with Charge Port for R134a	5K-PB
	Male Tube-O - Swivel - 90° Elbow - Short Pilot with Charge Port for R12	5K-PR
	Female Tube-O - Swivel - Straight - Short Pilot	5S
	Female Tube-O - Swivel - Straight - Long Pilot	59
	Female Tube-O - Swivel - Straight - Long Pilot with Charge Port for 134a	59-PB
Flange	Female Tube-O - Swivel - Straight - Long Pilot with Charge Port	59-PT
	Female Tube-O - Swivel - 45° Elbow - Short Pilot	5H
	Female Tube-O - Swivel - 45° Elbow - Long Pilot	5N
	Female Tube-O - Swivel - 45° Elbow - Long Pilot with Charge Port	5N-PB
	Female Tube-O - Swivel - 45° Elbow - Long Pilot with Charge Port	5N-PT
	Female Tube-O - Swivel - 90° Elbow - Short Pilot	5T
	Female Compressor - Swivel - 45° Elbow	5V
	Female Compressor - Swivel - 90° Elbow	5W
	Female Compressor - Swivel - 90° Elbow - Block Type	5Z
	Female Compressor - Swivel - 135° Elbow	RV
Flange	Female Compressor - Swivel - 180° Elbow - Block Type	RZ
	Male SAE Compression Seat (without Nut or Sleeve)	61
	Two Hole (2.25" X 0.44") Flange - Rigid - 90° Elbow	2H
	SAE Code 61 Flange Head - Straight	15
Flange	SAE Code 61 Flange Head - Straight (5,000 psi)	4A
	SAE Code 61 Flange Head - 22 1/2° Elbow -	16

Continued on next page

Hose  
**A**

Fittings  
**B**

Equipment  
**C**

Accessories  
**D**

Technical  
**M**

# A Application

Continued from previous page

	Description	End Code
Flange	SAE Code 61 Flange Head-30° Elbow	26
	SAE Code 61 Flange Head-45° Elbow	17
	SAE Code 61 Flange Head-45° Elbow (5,000 psi)	4F
	SAE Code 61 Flange Head-60° Elbow	27
	SAE Code 61 Flange Head - 67½° Elbow	18
	SAE Code 61 Flange Head - 90° Elbow	19
	SAE Code 61 Flange Head - 90° Elbow - (5,000 psi)	4N
	SAE Code 61 Flange Head - 90° Elbow - Long Drop	89
	SAE Code 61 Flange Head - 110° Elbow	2U
	SAE Code 62 Flange Head - Straight	6A
SAE Code 62 Flange Head - 22½° Elbow	6B	
SAE Code 62 Flange Head - 30° Elbow	6E	
SAE Code 62 Flange Head - 45° Elbow	6F	
SAE Code 62 Flange Head - 60° Elbow	6G	
SAE Code 62 Flange Head - 90° Elbow	6N	
Caterpillar® Flange Head - Straight	XA	
Caterpillar® Flange Head - 22½° Elbow	XB	
Caterpillar® Flange Head - 30° Elbow	XE	
Caterpillar® Flange Head - 45° Elbow	XF	
Caterpillar® Flange Head - 60° Elbow	XG	
Caterpillar® Flange Head - 67½° Elbow	XM	
Caterpillar® Flange Head - 90° Elbow	XN	
Seal-Lok	Male Seal-Lok - Rigid - Straight (with O-Ring)	J0
	Male Seal-Lok - Bulkhead without Locknut - Straight (with O-Ring)	JB
	Female Seal-Lok - Swivel - Straight - Long	JS
	Female Seal-Lok - Swivel - Straight - Short	JC
	Female Seal-Lok - Swivel - 221/2° Elbow	J6
	Female Seal-Lok - Swivel - 45° Elbow	J7
	Female Seal-Lok - Swivel - 90° Elbow - Short Drop	J9
	Female Seal-Lok - Swivel - 90° Elbow - Medium Drop	J5
	Female Seal-Lok - Swivel - 90° Elbow - Long Drop	J1
	Female Metric Swivel - Straight (30° Flare)	MU
Female Metric - Swivel - Straight (30° Flare)	XU	
Female BSP Parallel Pipe - Swivel - Straight (30° Flare)	FU	
JIS	Male BSP Taper Pipe - Rigid - Straight (60° Cone)	UT
	Female BSP Parallel Pipe - Swivel - Straight (60° Cone)	GU
	Female BSP Parallel Pipe - Swivel - 45° Elbow (60° Cone)	G1
	Female BSP Parallel Pipe - Swivel - 90° Elbow (60° Cone)	G2
	Male Metric L - Rigid - Straight (24° Cone)	D0
	Male Standpipe Metric L - Rigid - Straight	1D
	Female Metric - Swivel - Straight (Ball Nose)	C0
	Female Metric L - Swivel - Straight (Ball Nose)	C3
	Female Metric L - Swivel - 45° Elbow (Ball Nose)	C4
	Female Metric L - Swivel - 90° Elbow (Ball Nose)	C5

# Standard Fitting Configurations by Connection and End Code

	Description	End Code
Metric	Female Metric L - Swivel - Straight (24° Cone with O-Ring)	CA
	Female Metric L - Swivel - 45° Elbow (24° Cone with O-Ring) -	CE
	Female Metric L - Swivel - 90° Elbow (24° Cone with O-Ring) -	CF
	Male Metric S - Rigid - Straight (24° Cone)	D2
	Male Standpipe Metric S - Rigid - Straight	3D
	Female Metric S - Swivel - Straight (Ball Nose)	C6
	Female Metric S - Swivel - 45° Elbow (Ball Nose)	C7
	Female Metric S - Swivel - 90° Elbow (Ball Nose)	C8
	Female Metric S - Swivel - Straight (24° Cone with O-Ring)	C9
	Female Metric S - Swivel - 45° Elbow (24° Cone with O-Ring)	0C
BSP	Female Metric S - Swivel - 90° Elbow (24° Cone with O-Ring)	1C
	Male BSP Taper Pipe - Rigid - Straight	91
	Female BSP Parallel Pipe - Swivel - Straight (60° Cone)	92
	Male BSP Parallel Pipe - Rigid - Straight (60° Cone)	D9
	Female BSP Parallel Pipe - Swivel - 45° Elbow (60° Cone)	B1
	Female BSP Parallel Pipe - Swivel - 90° Elbow (60° Cone)	B2
	Female BSP Parallel Pipe - Swivel - 90° Elbow Block Type (60° Cone)	B4
	Female BSP Parallel Pipe - Swivel - Straight (Flat Seat)	B5
	Male BSP Taper Pipe - Rigid - 45° Elbow	BV
	Male BSP Taper Pipe - Rigid - 90° Elbow or Side Outlet	BZ
Fr. Gaz	Male French Gaz Series - Rigid - Straight (24° Cone)	FG
	Female French Gaz Series - Swivel - Straight (Ball Nose)	F4
	DIN Metric Banjo - Straight	49
	88 Series Heavy Duty Hose Clamp (Double Bolt Hose Clamp)	88DB
	88 Series Hose Clamp- SAE 100R4 Two-Bolt Clamp	88HC-H
	88 Series Hose Clamp (Worm Gear)	88HC
	Push-Lok Union	82
	Hose Splicer	88
	Male Standpipe - Rigid - Straight (Inch Size Tube O.D.)	34
	Male Ferulok Flareless-Rigid-Straight (24° Cone with Nut and Ferrule)	11
Specialty	Female Ferulok Flareless - Swivel - Straight (24° Cone)	12
	Female Air Brake Jounce Line - Swivel - Straight	7B
	Male Refrigerant Tube Mender - Straight (with Nut and Ferrule)	T1
	Female PTT 30° - Swivel	32

Hose  
**A**

Fittings  
**B**

Equipment  
**C**

Accessories  
**D**

Technical  
**M**

# A Application

## Metric Conversion

METRIC to ENGLISH EQUIVALENTS
ENGLISH to METRIC EQUIVALENTS
inches x 25.4 = millimeters (mm)
inches x 2.54 = centimeters (cm)
feet x .3048 = meters (m)
yard x .9144 = meters (m)
psi x .0689 = bar
psi x .0069 = Megapascals (MPa)
psi x .0703 = Kilogram force per square centimeter (Kgf/cm <sup>2</sup> )
pound force x 4.448 = Newtons
pound · inch x .113 = Newton · meters (N · m)
pound · foot x 1.356 = Newton · meters (N · m)
millimeter x .0394 = inch (in)
centimeter x .3937 = inch (in)
meters x 3.281 = feet (ft)
meters x 1.0936 = yards (yd)
bar x 14.5 = psi
Megapascals x 145.0 = psi
Kilogram force per square centimeter x 14.22 = psi
Newtons x .2248 = pounds force (lbf)
Newton · meter x 8.850 = pound · inches (lb · in)
Newton · meter x .737 = pound feet (lb · ft)

METRIC I.D. KIT
INTERNATIONAL HOSE FITTING IDENTIFICATION KIT
The booklet, gauges and caliper contained in this fitting I.D. Kit, can be used to identify most types of hydraulic hose fittings and adapters including:
U.S. Standards
British Standard Pipe
German (DIN) Metric
French Metric and GAZ
Japanese Standards (JIS)
Contents of Kit:
Instruction Book with Tables
Screw Pitch Gauge for U.S. Threads
International Gauge for Metric and British Threads
Inch and Millimeter Caliper
Carry Case
For information, contact your local distributor or the Parker Catalog Service Department - 1-800-272-7537 or 1-614-279-7070.

### MILLIMETERS to FRACTIONS to DECIMALS

MM	INCHES		MM	INCHES		MM	INCHES		MM	INCHES	
	FRACTION	DECIMAL		FRACTION	DECIMAL		FRACTION	DECIMAL		FRACTION	DECIMAL
0.3969	1/64	0.0156	6.7469	17/64	0.2656	13.0969	33/64	0.5156	19.4469	49/64	0.7656
0.7938	1/32	0.0312	7.1438	9/32	0.2812	13.4938	17/32	0.5312	19.8438	25/32	0.7812
1.1906	3/64	0.0468	7.5406	19/64	0.2968	13.8906	35/64	0.5468	20.2406	51/64	0.7968
1.5875	1/16	0.0625	7.9375	5/16	0.3125	14.2875	9/16	0.5625	20.2375	13/16	0.8125
1.9844	5/64	0.0781	8.3344	21/64	0.3281	14.6844	37/64	0.5781	21.0344	53/64	0.8281
2.3812	3/32	0.0937	8.7312	11/32	0.3437	15.0812	19/32	0.5937	21.4312	27/32	0.8437
2.7781	7/64	0.1093	9.1281	23/64	0.3593	15.4781	39/64	0.6093	21.8281	55/64	0.8593
3.1750	1/8	0.1250	9.5250	3/8	0.3750	15.8750	5/8	0.6250	22.2250	7/8	0.8750
3.5719	9/64	0.1406	9.9219	25/64	0.3906	16.2719	41/64	0.6406	22.6219	57/64	0.8906
3.9688	5/32	0.1562	10.3188	13/32	0.4062	16.6688	21/32	0.6562	23.0188	29/32	0.9062
4.3656	11/64	0.1718	10.7156	27/64	0.4218	17.0656	43/64	0.6718	23.4156	59/64	0.9218
4.7625	3/16	0.1875	11.1125	7/16	0.4375	17.4625	11/16	0.6875	23.8125	15/16	0.9375
5.1594	13/64	0.2031	11.5094	29/64	0.4531	17.8594	45/64	0.7031	24.2094	61/64	0.9531
5.5562	7/32	0.2187	11.9062	15/32	0.4687	18.2562	23/32	0.7187	24.6062	31/32	0.9687
5.9531	15/64	0.2343	12.3031	31/64	0.4843	18.6531	47/64	0.7343	25.0031	63/64	0.9843
6.3500	1/4	0.2500	12.7000	1/2	0.5000	19.0500	3/4	0.7500	25.4000	1	1.0000

A Hose  
 B Fittings  
 C Equipment  
 D Accessories  
 E Technical



# Media

## Chemical Resistance Information

Hose  
A

Fittings  
B

Equipment  
C

Accessories  
D

Technical  
M

**Warning:** This chemical compatibility guide must not be used in conjunction with any other compatibility guides from previous or future catalog editions, bulletins or publications. Incorrect use of these charts could result in death, personal injury or property damage.

### Hose Selection by Medium and Hose Type

This hose compatibility chart is a ready reference of Parker hose compatibility with various fluid media. It is intended as a guide to chemical compatibility with inner tube materials and assembly lubricant applied internally. The specific recommendations are based upon field experience, the advice of various polymer or fluid suppliers, and specific laboratory experiments. **It must be stressed, however, that this information is offered only as a guide.** Final hose selection depends also upon pressure, fluid temperature, ambient temperature, and special requirements or variations, which may not be known by Parker Hannifin. Legal and other regulations must be followed with particular care. Where an external compatibility problem may occur, or for fluids not listed, we encourage you to first contact the fluid manufacturer for a recommendation prior to contacting your Parker Hannifin Field Representative or the Technical Service Department, Hose Products Division, Wickliffe, Ohio.

#### Use the Chart as Follows:

1. Locate medium to be carried using the Chemical Resistance Table on the following pages.
2. Select suitability of hose and fitting material from the table based on the letter rating in the table. See resistance rating key below for explanation of compatibility ratings. See list of numerals below for an explanation when a numeral, or a numeral and a letter rating are present in the table.
3. The Column headings on the Chemical Resistance Table, I, II, III, IV, V, refer to specific groups of hoses.
4. Locate hose part number under Column I, II, III, IV, V from the list below.
5. For fitting material availability refer to appropriate fitting section of catalog.
6. Check hose specifications in this catalog. Contact Hose Division Technical Service Department on any items not cataloged.

#### Resistance Rating Key

- A = Preferred, good to excellent with little or no change in physical properties.
- F = Fair, marginal or conditional with noticeable affects on physical properties.
- X = Unsuitable, severe affects on physical properties.
- ~ = No rating, insufficient information.

#### Numerals

1. For air or gaseous applications above 250 PSI (1,7 MPa), the cover should be pin pricked.
2. Legal and insurance regulations must be considered. Contact Technical Service Department for more information.
3. Push-Lok hoses (801, 804, 821, 821FR, 831, 836) are not recommended for any type of fuel.
4. Use 285 or 244 hoses. The compatibility of the systems refrigeration oil with these hoses needs to be evaluated on a case by case basis. Contact HPD Technical Service Department for more information. Do not use mineral oil or Alkyl Benzene refrigeration oils with 244 hose. Chemical compatibility does not imply low permeation.
5. 150°F (65°C) maximum.
6. Satisfactory at some concentrations and temperatures, unsatisfactory at others.
7. For phosphate ester fluids use 304, 424, 774, 804 or F42 hoses.
8. Acceptable for flushing hose assemblies.
9. 221FR hose recommended.
10. For dry air applications, hoses with inner tubes from columns IV, and V are preferred. See hose specifications for maximum recommended temperatures with air.
11. 212°F (100°C) maximum.
12. 250°F (121°C) maximum.
13. Use SS23CG or SS25UL
14. Use SS23CG

#### Hose Types

##### Column I

AX, BXX, 201, 225, 301, 341, 601, 701, 711 721, 721TC, 721ST, 731, 761, P35, 781, 791TC, 881

##### Column II

SS25UL, 301LT, 351TC, 351ST, 421WC, 431, 451TC, 451ST, 471TC, 471ST, 801, 811, 811HT

##### Column III

221FR, 302, 422, 472TC, 482TC, 482ST, 772TC, 772ST, 782TC, 782ST, 792TC, 792ST, 821, 831, 302, JK

##### Column IV

206, 213, 266, 293, 426, 436, 821FR, 836

##### Column V

304, 424, 774, 804, F42

#### Caution:

The fluid manufacturer's recommended maximum operating temperature for any specific name-brand fluid should be closely observed by the user. Specific name brand fluids can vary greatly between manufacturers even though they are considered to be from the same family or type of fluids. Using fluids above the manufacturers maximum recommended temperature can cause the fluid to break down, creating by-products that can be harmful to elastomers or other materials used in the system. When selecting a hose type, both the fluid manufacturer and hose manufacturers maximum temperature limit must be taken into consideration, with the lower of the two taking precedence.



# Chemical Resistance Information (Page 1 of 9)

**Warning:** This chemical compatibility guide must not be used in conjunction with any other compatibility guides from previous or future catalog editions, bulletins or publications. Incorrect use of these charts could result in death, personal injury or property damage.

MEDIA	I	II	III	IV	V	Steel	Brass	SS
3M FC-75	A	A	A	A	A	A	A	A
Acetic Acid	X	X	X	A	6	X	X	A
Acetone	X	X	X	A	A	A	A	A
Acetylene	X	X	X	X	X	~	~	~
AEROSHELL Turbine Oil 500	X	X	X	X	X	A	A	A
Air	A,1,10	A,1,10	A,1,10	A,1,10	A,1,10	A	A	A
Air (dry)	X	F,1,10	F,1,10	A,1,10	A,1,10	A	A	A
Alcohol (Methanol-Ethanol)	F	F	F	F	F	F	A	A
Americas Choice AW ISO 46	~	F	F	~	X	A	A	A
Ammonia (Anhydrous)	X	X	X	X	X	X	X	X
Ammonium Chloride	A	A	A	A	A	X	X	X
Ammonium Hydroxide	F	F	F	A	A	F	X	A
Ammonium Nitrate	A	A	A	F	A	F	X	A
Ammonium Phosphate	A	A	A	A	A	X	X	F
Ammonium Sulfate	A	A	A	A	A	F	X	F
Amoco 32 Rykon	X	A	A	F	X	A	A	A
Ampol PE 46	X	X	X	X	A,7	A	A	A
AMSOIL Synthetic ATF	F	A	A	A	X	A	A	A
Amyl Alcohol	X	X	X	F	F	X	A	A
Anderol 495,497,500,750	X	X	X	F	X	A	A	A
Aniline	X	X	X	F	A	A	X	A
Animal Fats	X	F	F	F	F	6	6	A
Aquacent Light, Heavy	X	A	A	X	X	A	A	A
Aries/Athena	F	F	F	~	X	A	A	A
Aromatic 100,150	X	F	F	~	X	A	A	A
Arrow 602P	A	A	A	A	X	A	A	A
Asphalt	X	F	F	F	X	F	F	A
ASTM #3 Oil	F	F	F	F	X	A	A	A
Astrol 1044AW	A	A	A	~	X	A	A	A
ATF-M	F	A	A	A	X	A	A	A
Automotive Brake Fluid	X	X	X	X	~	X	X	X
AW 32,46,68	F	A	A	A	X	A	A	A
BCF	F	F	F	F	~	A	A	A
Benz Petraulic 32,46,68,100,150,220,320,460	F	A	A	A	X	A	A	A
Benzene, Benzol	X	X	X	F	X	A	A	A
Benzgrind HP 15	~	A	A	A	X	A	A	A
Benzine	X	X	X	F	X	A	A	A
Biodegradable Hydraulic Fluid 112B	X	A	A	X	~	A	A	A
Bio-Soy, Agri Industries	X	A	A	X	X	A	A	A
Borax	F	F	F	F	A	F	A	A
Boric Acid	A	A	A	X	A	X	6	A
Brayco 882	X	A	A	A	X	A	A	A
Brayco Micronic 745	X	A	A	F	X	A	A	A
Brayco Micronic 776RP	F	A	A	F	X	A	A	A

Hose  
**A**

Fittings  
**B**

Equipment  
**C**

Accessories  
**D**

Technical  
**M**



# MEDIA

## Chemical Resistance Information (Page 2 of 9)

**Warning:** This chemical compatibility guide must not be used in conjunction with any other compatibility guides from previous or future catalog editions, bulletins or publications. Incorrect use of these charts could result in death, personal injury or property damage.

MEDIA	I	II	III	IV	V	Steel	Brass	SS
Brayco Micronic 889	X	F	F	~	X	A	A	A
Brine	F	F	F	A	A	X	F	F
Butane	See numerals 2 and 13					A	A	A
Butyl Alcohol, Butanol	F	F	F	F	F	F	F	A
Calcium Chloride	A	A	A	F	A	F	F	X
Calcium Hydroxide	A	A	A	A	A	A	A	A
Calcium Hypochlorite	X	X	X	A	A	X	F	X
Calibrating Fluid	A	A	A	A	X	A	A	A
Carbon Dioxide, gas	F	F	F	F	6	A	A	A
Carbon Dioxide, liquid	X	X	X	X	X	X	X	X
Carbon Disulfide	X	X	X	F	X	A	F	A
Carbon Monoxide (hot)	F	F	F	F	6	F	6	A
Carbon Tetrachloride	X	X	X	F	X	6	6	6
Carbonic Acid	F	F	F	X	F	X	X	F
Castor Oil	A	A	A	A	A	A	A	A
Castrol 5000	X	F	F	A	X	A	A	A
Cellosolve Acetate	X	X	X	X	A	X	X	A
Cellugard	A	A	A	~	A	A	A	A
Cellulube 90, 150, 220 300, 550, 1000	X	X	X	~	A	A	A	A
Chevron Clarity AW 32, 46, 68	A	A	A	A	X	A	A	A
Chevron FLO-COOL 180	F	F	F	~	X	A	A	A
Chevron FR-8, 10, 13, 20	X	X	X	X	A,7	A	A	A
Chevron Hydraulic Oils AW MV 15, 32, 46, 68, 100	A	A	A	A	X	A	A	A
Chevron HyJet IV (9)	X	X	X	X	A,7	A	A	A
Chevron Rykon MV	F	A	A	~	X	A	A	A
Cindol 3204 PBR	~	A	A	A	X	A	A	A
Citric Acid	F	A	A	X	A	X	X	6
Commonwealth EDM 242, 244	A	A	A	~	X	A	A	A
CompAir CN300	X	X	X	F	X	A	A	A
CompAir CS100, 200, 300, 400	X	X	X	F	X	A	A	A
Coolanol 15, 20, 25, 35, 45	A	A	A	A	A	A	A	A
Copper Chloride	F	A	A	X	A	X	X	X
Copper Sulfate	A	A	A	X	A	X	X	F
Cosmolubric HF-122, HF-130, HF-144	X	F	A	X	X	A	A	A
Cosmolubric HF-1530	X	F	A	X	X	A	A	A
Cottonseed Oil	F	A	A	F	X	A	A	A
CPI CP-4000	X	X	X	F	X	A	A	A
Crude Petroleum Oil	F	A	A	A	X	F	F	A
CSS 1001 Dairy Hydraulic Fluid	F	A	A	A	X	A	A	A
Daphne AW32	A	A	A	A	X	A	A	A
Dasco FR 201-A	A	A	A	~	X	A	A	A
Dasco FR150, 200, 310	F	A	A	~	A	A	A	A
Dasco FR300, FR2550	X	X	X	~	X	A	A	A
Dasco FR355-3	X	F	A	X	X	A	A	A
Deicer Fluid 419R	A	A	A	~	~	A	A	A

A Hose

B Fittings

C Equipment

D Accessories

M Technical





# Chemical Resistance Information (Page 3 of 9)

**Warning:** This chemical compatibility guide must not be used in conjunction with any other compatibility guides from previous or future catalog editions, bulletins or publications. Incorrect use of these charts could result in death, personal injury or property damage.

MEDIA	I	II	III	IV	V	Steel	Brass	SS
Deionized Water	A	A	A	A	A	F	F	A
Dexron II ATF	F	A	A	A	X	A	A	A
Dexron III ATF (to 170°F)	A	A	A	A	X	A	A	A
Dexron III ATF (to 212°F)	X	F	F	A	X	A	A	A
Dexron III ATF (to 250°F)	X	X	X	A	X	A	A	A
Dexron III ATF (to 300°F)	X	X	X	X	X			
DexronIIIE/Mercon (at 212°F)	X	A	A	A	X	A	A	A
Diesel Fuel	F,3	A,3	A,3	A,3	X	A	A	A
Diester Fluids	X	X	X	F	X	A	A	A
Dow Corning 2-1802	~	~	~	F	~	A	A	A
Dow Corning DC 200, 510, 550, 560, FC126	A	A	A	F	~	A	A	A
Dow HD50-4	F	F	F	~	~	~	~	A
Dow Sullube 32	~	~	~	F	~	A	A	A
Dowtherm A,E	X	X	X	F	X	A	A	A
Dowtherm G	X	X	X	X	X	A	A	A
Duro AW-16, 31	A	A	A	~	X	A	A	A
Duro FR-HD	A	A	A	~	X	A	A	A
EcoSafe FR-68	A	A	A	~	~	A	A	A
Envirologic 3032, 3046, 3068	A	A	A	~	~	A	A	A
Ethanol	F	F	F	F	F	F	A	A
Ethers	X	X	X	F	X	A	A	A
Ethyl Acetate	X	X	X	F	F	F	A	A
Ethyl Alcohol	F	F	F	F	F	F	A	A
Ethyl Cellulose	F	F	F	F	F	X	F	F
Ethyl Chloride	X	X	X	X	A	F	F	F
Ethylene Dichloride	X	X	X	F	X	X	A	X
Ethylene Glycol	F	A	A	A	A	A	F	A
<b>Exxon 2380 Turbo Oil</b>	<b>X</b>	<b>F</b>	<b>F</b>	<b>X</b>	<b>X</b>	<b>A</b>	<b>A</b>	<b>A</b>
<b>Exxon 3110 FR</b>	<b>A</b>	<b>A</b>	<b>A</b>	<b>A</b>	<b>X</b>	<b>A</b>	<b>A</b>	<b>A</b>
Exxon Esstic	A	A	A	A	A	A	A	A
Exxon Mobil Rarus SHC 1026	~	~	~	A	~	A	A	A
Exxon Nuto H 46, 68	A	A	A	A	X	A	A	A
Exxon Tellura Industrial Process Oils	A	A	A	A	X	A	A	A
Exxon Terresstic, EP	A	A	A	A	A	A	A	A
Exxon Turbo Oil 2380	X	F	F	F	X	A	A	A
Exxon Univolt 60, N61	F	A	A	A	X	A	A	A
FE 232 (Halon)	X	X	X	X	F	A	A	A
Fenso 150	~	A	A	~	X	A	A	A
Formaldehyde	X	X	X	A	A	X	F	A
Formic Acid	X	X	X	X	A	X	6	X
Freons see refrigerants	~	~	~	~	~	~	~	~
Fuel Oil	F	A	A	A	X	A	A	A
Fyre-Safe 120C,126,155,1090E,1150,1220,1300E	X	X	X	X	A,7	A	A	A

Hose  
**A**

Fittings  
**B**

Equipment  
**C**

Accessories  
**D**

Technical  
**M**



# MEDIA

## Chemical Resistance Information (Page 4 of 9)

**Warning:** This chemical compatibility guide must not be used in conjunction with any other compatibility guides from previous or future catalog editions, bulletins or publications. Incorrect use of these charts could result in death, personal injury or property damage.

MEDIA	I	II	III	IV	V	Steel	Brass	SS
Fyre-Safe 200C, 225, 211	F	A	A	A	A	A	A	A
Fyre-Safe W/O	A	A	A	A	X	A	A	A
Fyrguard 150, 150-M, 200	A	A	A	A	A	A	A	A
Fyrquel 60, 90, 150, 220, 300, 550, 1000	X	X	X	X	A,7	A	A	A
Fyrquel EHC, GT, LT, VPF	X	X	X	X	A,7	A	A	A
Fyrtek MF, 215, 290, 295	X	X	X	X	X	A	A	A
Gardner-Denver GD5000, GD8000	X	X	X	F	X	A	A	A
Gasoline			See numeral 9			A	A	A
Glue	F	F	F	~	X	A	F	A
Glycerine, Glycerol	A	A	A	A	A	A	F	A
Grease	A	A	A	A	X	A	A	A
Green Plus ES	X	A	A	X	~	A	A	A
Greens Care 32, 46	F	A	A	F	~	A	A	A
Gulf-FR Fluid P37, P40, P43, P45, P47	X	X	X	F	A	A	A	A
H-515 (NATO)	A	A	A	~	X	A	A	A
Halon 1211, 1301	F	F	F	F	~	A	A	A
Helium Gas	X	X	X	X	X	A	A	A
Heptane	X	F	F	A	X	A	A	A
Hexane	X	F	F	A	X	A	A	A
HF-20, HF-28	~	A	A	A	A	A	A	A
Houghto-Safe 1055, 1110, 1115, 1120, 1130 (9)	X	X	X	X	A,7	A	A	A
Houghto-Safe 271 to 640	F	A	A	F	A	A	A	A
Houghto-Safe 419 Hydraulic Fluid	A	A	A	~	X	A	A	A
Houghto-Safe 419R Deicer Fluid	A	A	A	~	~	A	A	A
Houghto-Safe 5046, 5046W, 5047-F	A	A	A	A	X	A	A	A
HP 100C (Jack hammer oil)	F	A	A	A	X	A	A	A
HPWG 46B	F	A	A	F	~	A	A	A
Hul-E-Mul	A	A	A	~	X	A	A	A
Hychem C, EP1000, RDF	A	A	A	A	A	A	A	A
Hydra Safe E-190	A	A	A	F	X	A	A	A
Hydra-Cut 481, 496	A	A	A	~	X	A	A	A
Hydrafluid 760	A	A	A	~	X	A	A	A
Hydrochloric Acid	X	X	X	X	X	X	X	X
Hydrofluoric Acid	X	X	X	X	X	X	6	X
Hydrogen Gas	X	X	X	X	X	A	A	A
Hydrogen Peroxide	X	X	X	F	X	X	X	6
Hydrogen Sulfide	X	X	X	X	A	X	X	6
Hydrolube	A	A	A	F	A	A	A	A
Hydrolubric 120-B, 141, 595	F	A	A	F	A	A	A	A
Hydrosafe Glycol 200	A	A	A	A	A	A	F	A
HyJet IV	X	X	X	X	A,7	A	A	A
Hyspin SP 10	~	A	A	A	X	A	A	A
Ideal Yellow 77	A	A	A	A	X	A	A	A
Imol S150 to S550	X	X	X	~	~	A	A	A

A Hose

B Fittings

C Equipment

D Accessories

M Technical



# Chemical Resistance Information

(Page 5 of 9)

**Warning:** This chemical compatibility guide must not be used in conjunction with any other compatibility guides from previous or future catalog editions, bulletins or publications. Incorrect use of these charts could result in death, personal injury or property damage.

MEDIA	I	II	III	IV	V	Steel	Brass	SS
Ingersoll Rand SSR Coolant	X	X	X	F	X	A	A	A
Isocyanates	F	F	F	F	X	A	~	A
Isooctane	X	F	F	A	X	A	A	A
Isopar H	X	X	X	X	X	A	A	A
Isopropyl Alcohol	F	F	F	F	F	F	A	A
Jayflex DIDP	X	X	X	X	A	A	A	A
JP3 and JP4	X	A	A	~	X	A	A	A
JP5	X	A	A	F	X	A	A	A
JP9	X	X	X	X	X	A	~	A
Kaeser 150P, 175P, 325R, 687R	X	X	X	F	X	A	A	A
Kerosene	X	A	A	F	X	A	A	A
KSL-214, 219, 220, 222	X	X	X	F	X	A	A	A
Lacquer	X	X	X	F	X	X	A	A
Lacquer Solvents	X	X	X	F	X	X	A	A
Lactic Acids	X	X	X	X	X	X	X	A
Lindol HF	X	X	X	F	A	A	A	A
Linseed Oil	A	A	A	A	A	A	A	A
LP-Gas			See numeral 13			A	A	A
Magnesium Chloride	A	A	A	A	A	X	X	X
Magnesium Hydroxide	F	F	F	A	A	F	F	F
Magnesium Sulfate	A	A	A	A	A	A	F	A
Mercaptans	X	X	X	X	X	~	~	~
Methane			See numeral 14			A	A	A
Methanol	F	F	F	F	F	F	A	A
Methyl Alcohol	F	F	F	F	F	F	A	A
Methyl Chloride	X	X	X	F	X	A	A	A
Methyl Ethyl Ketone (MEK)	X	X	X	F	X	F	A	A
Methyl Isopropyl-Ketone	X	X	X	X	X	F	A	A
Metsafe FR 303-M	X	X	X	X	X			
Metsafe FR303, FR310, FR315, FR330, FR350	X	X	X	X	X	A	A	A
Microzol-T46	X	A	A	~	X	A	A	A
MIL-B-46176A	X	X	X	X	X	X	X	X
MIL-H-46170	X	F	F	F	X	A	A	A
MIL-H-5606	F	A	A	A	X	A	A	A
MIL-H-6083	F	A	A	A	X	A	A	A
MIL-H-7083	F	A	A	A	X	A	A	A
MIL-H-83282	F	A	A	A	X	A	A	A
MIL-L-2104, 2104B	F	A	A	A	X	A	A	A
MIL-L-23699	X	X	X	X	X	A	A	A
MIL-L-7808	F	A	A	~	X	A	A	A
Mine Guard FR	A	A	A	~	A	A	A	A
Mineral Oil	A	A	A	F	X	A	A	A
Mineral Spirits	8	8	8	8	X	A	A	A
Mobil Aero HFE	F	A	A	F	X	A	A	A

Hose  
**A**

Fittings  
**B**

Equipment  
**C**

Accessories  
**D**

Technical  
**M**



# MEDIA

## Chemical Resistance Information (Page 6 of 9)

**Warning:** This chemical compatibility guide must not be used in conjunction with any other compatibility guides from previous or future catalog editions, bulletins or publications. Incorrect use of these charts could result in death, personal injury or property damage.

MEDIA	I	II	III	IV	V	Steel	Brass	SS
Mobil DTE 11M, 13M, 15M, 16M, 18M, 19M	F	A	A	A	X	A	A	A
Mobil DTE 22, 24, 25, 26	F	A	A	A	X	A	A	A
Mobil EAL 224H	X	A	A	X	~	A	A	A
Mobil EAL Artic 10, 15, 22,32, 46, 68, 100	X	X	X	X	X	A	A	A
Mobil EAL Evirosyn 46	A	A	A	A	X	A	A	A
Mobil Glygoyle 11, 22, 30, 80	A	A	A	~	X	A	A	A
Mobil HFA	F	A	A	A	X	A	A	A
Mobil Jet 2	X	F	F	A	X	A	A	A
Mobil Nyvac 20, 30, 200, FR	F	A	A	F	A	A	A	A
Mobil Rarus 824, 826, 827	X	X	X	F	X	A	A	A
Mobil SHC 500 Series	F	A	A	A	X	A	A	A
Mobil SHC 600 Series	F	A	A	A	X	A	A	A
Mobil SHC 800 Series	F	A	A	A	X	A	A	A
Mobil SHL 624	~	A	A	A	X	A	A	A
Mobil Vactra Oil	A	A	A	F	X	A	A	A
Mobil XRL 1618B	X	X	X	X	A,7	A	A	A
Mobilfluid 423	F	A	A	A	X	A	A	A
Mobilgear SHC 150, 220, 320, 460, 680	F	F	F	F	X	A	A	A
Mobilrama 525	A	A	A	F	X	A	A	A
Molub-Alloy 890	X	X	X	F	X	A	A	A
Moly Lube 'HF' 902	F	F	F	F	X	A	A	A
Monolec 6120 Hydraulic Oil	A	A	A	A	X	A	A	A
Morpholine (pure additive)	X	X	X	X	X	X	X	A
Naptha	X	F	F	A	X	A	A	A
Napthalene	X	X	X	F	X	A	A	A
Natural Gas			See numeral 14			A	A	A
Nitric Acid	X	X	X	X	X	X	X	F
Nitrobenzene	X	X	X	F	X	X	X	A
Nitrogen, gas	F,1	F,1	F,1	F,1	F,1	A	A	A
Nitrogen, liquid	X	X	X	X	X	X	X	X
NORPAR 12, 13, 15	8	8	8	8	X	A	A	A
Nuto H 46, 68	A	A	A	A	X	A	A	A
Nyvac 20, 30, 200, FR	F	A	A	F	A	A	A	A
Nyvac Light	X	X	X	~	A	A	A	A
Oceanic HW	F	A	A	F	X	A	A	A
Oxygen	X	X	X	X	X	X	A	A
Ozone	F	F	F	~	A	A	A	A
Pacer SLC 150, 300, 500, 700	X	X	X	F	X	A	A	A
Pennzbell AWX	F	A	A	F	X	A	A	A
Perchloroethylene	X	X	X	X	X	F	X	A
Petroleum Ether	X	F	F	F	X	A	A	A
Petroleum Oils	A	A	A	A	X	A	A	A
Phenol (Carbolic Acid)	X	X	X	A	X	X	F	A
Phosphate Ester Blends	X	X	X	X	X	A	A	A

A Hose

B Fittings

C Equipment

D Accessories

M Technical



# Chemical Resistance Information (Page 7 of 9)

**Warning:** This chemical compatibility guide must not be used in conjunction with any other compatibility guides from previous or future catalog editions, bulletins or publications. Incorrect use of these charts could result in death, personal injury or property damage.

MEDIA	I	II	III	IV	V	Steel	Brass	SS
Phosphate Esters	X	X	X	X	A,7	A	A	A
Phosphoric Acid	X	X	X	X	X	X	X	F
Plurasafe P 1000, 1200	F	A	A	A	F	A	A	A
Polyalkylene Glycol	A	F	F	~	X	A	A	A
Polyol Ester	X	F	A	X	X	A	A	A
Potassium Chloride	A	A	A	A	A	X	F	F
Potassium Hydroxide	X	X	X	F	A	6	X	A
Potassium Sulfate	A	A	A	A	A	A	A	A
Propane			See numeral 13			A	A	A
Propylene Glycol	F	A	A	A	A	F	F	F
Pydraul 10-E, 29-E, 50-E, 65-E, 90-E, 115-E	X	X	X	X	A,7	A	A	A
Pydraul 230-C, 312-C, 68-S	X	X	X	X	A,7	A	A	A
Pydraul 60, 150, 625, F9	X	X	X	X	A,7	A	A	A
Pydraul 90, 135, 230, 312, 540, MC	X	X	X	X	X	A	A	A
Pydraul A-200	X	X	X	F	X	A	A	A
Pyro Gard 43, 230, 630	X	X	X	X	X	A	A	A
Pyro Gard C, D, R, 40S, 40W	F	A	A	F	X	A	A	A
Pyro Guard 53, 55, 51, 42	X	X	X	X	A,7	A	A	A
Quakerol 641, 720	X	F	A	X	F	A	A	A
Quintolubric 700	A	A	A	A	A	A	F	A
Quintolubric 807-SN	F	A	A	~	X	A	A	A
Quintolubric 822, 833	X	F	A	X	X	A	A	A
Quintolubric 822-68EHC (71°C, 160°F maximum)	X	F	A	~		A	A	A
Quintolubric 888	X	F	A	X	X	A	A	A
Quintolubric 957, 958	F	A	A	F	A	A	A	A
Quintolubric N822-300	~	~	A	~	~	A	A	A
Rando	A	A	A	A	X	A	A	A
Rayco 782	X	F	A	X	X	X	X	X
Refrigerant 124			See numeral 4			A	A	A
Refrigerant Freon 113, 114	X	X	X	X	X	A	A	A
Refrigerant Freon 12			See numeral 4			A	A	A
Refrigerant Freon 22			See numeral 4			A	A	A
Refrigerant Freon 502			See numeral 4			A	A	A
Refrigerant HFC134A			See numeral 4			A	A	A
Reolube Turbofluid 46	X	X	X	X	A,7	A	A	A
Rotella	A	A	A	A	X	A	A	A
Royal Bio Guard 3032, 3046, 3068, 3100	X	~	A	X	X	A	A	A
Royco 2200, 2210, 2222, 2232, 2246, 2268	X	X	X	X	X	A	A	A
Royco 4032, 4068, 4100, 4150	X	X	X	F	X	A	A	A
Royco 756, 783	A	A	A	A	X	A	A	A
Royco 770	X	F	F	F	X	A	A	A
RTV Silicone Adhesive Sealants	X	X	X	X	X	A	A	A
Safco-Safe T10, T20	~	~	~	~	A	F	F	A
Safety-Kleen ISO 32, 46, 68 hydraulic oil	F	A	A	~	X	A	A	A
Safety-Kleen Solvent	8	8	8	8	X	A	A	A

Hose  
**A**

Fittings  
**B**

Equipment  
**C**

Accessories  
**D**

Technical  
**M**



# MEDIA

## Chemical Resistance Information (Page 8 of 9)

**Warning:** This chemical compatibility guide must not be used in conjunction with any other compatibility guides from previous or future catalog editions, bulletins or publications. Incorrect use of these charts could result in death, personal injury or property damage.

MEDIA	I	II	III	IV	V	Steel	Brass	SS
Santoflex 13	F	F	F	~	F	A	A	A
Santosafe 300	X	X	X	~	X	A	A	A
Santosafe W/G 15 to 30	~	~	~	A	A	A	A	A
Sea Water	F	F	F	F	A	X	F	A
Sewage	F	F	F	A	F	X	F	A
Shell 140 Solvent	8	8	8	8	X	A	A	A
Shell Clavus HFC 68	X	X	X	X	X	A	A	A
Shell Comptella Oil	F	F	F	A	X	A	A	A
Shell Comptella Oil S 46, 68	F	F	F	A	X	A	A	A
Shell Comptella Oil SM	F	F	F	A	X	A	A	A
Shell Diala A, (R) Oil AX	F	A	A	F	X	A	A	A
Shell FRM	~	~	~	~	X	A	A	A
Shell IRUS 902, 905	A	A	A	~	A	A	A	A
Shell Pella-A	A	A	A	A	X	A	A	A
Shell Tellus	F	A	A	A	X	A	A	A
Shell Thermia Oil C	A	A	A	A	X	A	A	A
Shell Turbo R	X	F	F	A	X	A	A	A
SHF 220, 300, 450	X	X	A	X	X	A	A	A
Silicate Esters	A	F	F	A	X	A	A	A
Silicone Oils	A	A	A	~	~	A	A	A
Silicone Sealants	X	X	X	X	X	A	A	A
Skydrol 500B-4, LD-4	X	X	X	X	A,7	A	A	A
Soap Solutions	X	F	F	F	A	A	A	A
Soda Ash, Sodium Carbonate	A	A	A	A	A	A	F	A
Sodium Bisulfate	F	F	F	A	A	F	A	F
Sodium Chloride	F	F	F	A	A	X	F	A
Sodium Hydroxide	X	X	X	A	A	A	X	A
Sodium Hypochlorite	F	F	F	X	F	X	X	X
Sodium Nitrate	F	F	F	A	A	A	F	A
Sodium Peroxide	X	X	X	X	A	X	X	A
Sodium Silicate	A	A	A	A	A	A	A	A
Sodium Sulfate	A	A	A	A	A	A	A	A
Soybean Oil	F	A	A	A	A	A	A	A
SSR Coolant	X	X	X	F	X	A	A	A
Steam	X	X	X	X	X	F	A	A
Stoddard Solvent	8	8	8	8	X	A	A	A
Sulfur Chloride	X	X	X	F	X	X	X	X
Sulfur Dioxide	X	X	X	X	F	X	F	F
Sulfur Trioxide	X	X	X	F	F	X	X	X
Sulfuric Acid 0%-30% Room Temp	F	F	F	X	F,6	6	X	6
Summa-20, Rotor, Recip	X	X	X	F	X	A	A	A
Summit DSL-32,68,100,125	X	X	X	F	X	A	A	A
Sun Minesafe, Sun Safe	X	F	F	F	X	A	A	A
Sundex 8125	X	F	F	~	A	A	A	A
Suniso 3GS	A	A	A	A	X	A	A	A

A Hose

B Fittings

C Equipment

D Accessories

M Technical



# Chemical Resistance Information

(Page 9 of 9)

**Warning:** This chemical compatibility guide must not be used in conjunction with any other compatibility guides from previous or future catalog editions, bulletins or publications. Incorrect use of these charts could result in death, personal injury or property damage.

MEDIA	I	II	III	IV	V	Steel	Brass	SS
Sun-Vis 722	X	F	F	~	X	A	A	A
Super Hydraulic Oil 100, 150, 220	A	A	A	A	X	A	A	A
SUVA MP 39, 52, 66	X	X	X	X	X	A	A	A
SYNCON Oil	X	X	X	X	X	A	A	A
Syndale 2820	X	F	F	~	~	A	A	A
Synesstic 32,68,100	X	X	X	X	X	A	A	A
Syn-Flo 70,90	X	X	X	F	X	A	A	A
SYN-O-AD 8478	X	X	X	X	A,7	A	A	A
Tannic Acid	F	A	A	F	A	X	F	X
Tar	F	F	F	F	X	X	F	A
Tellus (Shell)	F	A	A	A	X	A	A	A
Texaco 760 Hydrafluid	~	~	~	~	X	A	A	A
Texaco 766, 763 (200 - 300)	~	~	~	~	A	F	F	A
Texaco A-Z Oil	A	A	A	F	X	A	A	A
Texaco Spindura Oil 22	F	F	F	F	X	A	A	A
Texaco Way Lubricant 68	A	A	A	A	X	A	A	A
Thanol-R-650-X	X	F	F	~	X	A	A	A
Thermanol 60	X	X	X	X	X	A	A	A
Toluene, Toluol	X	X	X	X	X	A	A	A
Transmission Oil	A	A	A	A	X	A	A	A
Tribol 1440	X	F	F	X	X	A	A	A
Trichloroethylene	X	X	X	F	X	X	A	A
Trim-Sol	F	A	A	F	X	A	A	A
Turbinol 50, 1122, 1223	X	X	X	X	A,7	A	A	A
Turpentine	X	X	X	F	X	A	A	A
Ucon Hydrolubes	F	A	A	F	A	A	A	A
UltraChem 215,230,501,751	X	X	X	F	X	A	A	A
Univis J26	A	A	A	A	X	A	A	A
Unleaded Gasoline			See numeral 9			A	A	A
Unocal 66/3 Mineral Spirits	8	8	8	8	X	A	A	A
Urea	F	F	F	A	F	F	~	F
Urethane Formulations	A	A	A	A	~	A	A	A
Van Straaten 902	A	A	A	A	X	A	A	A
Varnish	X	X	X	F	X	F	F	A
Varsol	8	F	F	8	X	A	A	A
Versilube F44, F55	~	A	A	A	~	A	A	A
Vinegar	X	X	X	F	A	F	X	A
Vital 29, 4300, 5230, 5310	X	X	X	X	X	A	A	A
Volt Esso 35	A	A	A	A	X	A	A	A
Water	F	A	A	A	A	F	A	A
Water / Glycols	A	A	A	A	A	A	F	A
Xylene, Xylol	X	X	X	X	X	A	A	A
Zerol 150	A	A	A	A	X	A	A	A
Zinc Chloride	A	A	A	X	A	X	X	F
Zinc Sulfate	A	A	A	X	A	X	A	A

Hose  
**A**

Fittings  
**B**

Equipment  
**C**

Accessories  
**D**

Technical  
**M**





# Pressure

## Working Pressure Chart

### PARKER HOSE SIZE / RECOMMENDED MAXIMUM WORKING PRESSURES

In addition to pressure, other factors must also be considered in the selection of the proper hose, e.g. fluid compatibility, temperatures, environment, etc. For additional information on a specific hose, consult the respective hose listing in this catalog.

Hose Size	Working Pressure (psi)												Standard Temp. Range °F	
	-3	-4	-5	-6	-8	-10	-12	-16	-20	-24	-32	-40		-48
601		1250		1125	1000		750	565						-40/+257
422		3250	3125	2600	2325	1875	1525	1275	900	725	575			-40/+212
424								1000	625	500	375			-40/+176
421WC		2750		2250	2000		1250	1000						-40/+257
426		2750		2250	2000	1500	1250	1000	625	500	375			-50/+302
AX		3000		3000	2500	1500	1250	1000						-40/+212
482TC 482ST		3250	3250	3000	2500	2000	1750	1275						-40/+212
BXX		5000		4000	3500	2750	2250	2000						-40/+212
431		5000	4250	4000	3500	2750	2250	2000						-40/+257
436				4000	3500	2750	2250	2000						-55/+302
304		5000		4000	3500		2250	2000	1625	1250	1125			-40/+176
301LT		5000		4000	3500		2250	2000						-67/+212
451TC 451ST		3000		3000	3000	3000	3000	3000	3000					-40/+212
341				4500	4000		3000	3000	2500					-40/+212
302		5800	5000	4750	4000	3600	3100	2400	1800	1300	1150			-40/+212
471TC 471ST		5800		5000	4250	3625	3125	2500						-40/+212
472TC									2250	1800	1300			-40/+212
351TC 351ST		4000	4000	4000	4000	4000	4000							-40/+212
721 721TC				4000	4000	4000	4000	4000	3000	2500	2500			-40/+257
721ST					4000	4000	4000	4000	3000					-40/+257
772TC/ST				4000	4000	4000	4000	4000	3000	2500	2500			-40/+257
774							4000	4000	3000	2500	2500			-40/+176
711										3000	3000			-40/+212
781 P35							5000	5000	5000	5000	5000			-40/+257
782TC 782ST							5000	5000	5000	5000				-40/+257
731							6000	5500	4700	4200	3600			-40/+212
701				6500	6000	5000								-40/+212
791TC							6000	6000	6000	6000				-40/+257
792TC 792ST							6000	6000	6000					-40/+257
761							8000							-40/+257
JK		10500		10000										-40/+120
F42					6000		6000	6000	6000					

(continued)

A Hose

B Fittings

C Equipment

D Accessories

M Technical

# Pressure

## Working Pressure Chart

### PARKER HOSE SIZE / RECOMMENDED MAXIMUM WORKING PRESSURES

In addition to pressure, other factors must also be considered in the selection of the proper hose, e.g. fluid compatibility, temperatures, environment, etc. For additional information on a specific hose, consult the respective hose listing in this catalog.

(continued from previous page)

	Hose Size	Working Pressure (psi)												Standard Temp Range F	
		-3	-4	-5	-6	-8	-10	-12	-16	-20	-24	-32	-40		-48
Suction & Return	811/811HT w/HC							100	70	50	50	50	62		-40/+212
	881 w/HC							100	70	50	50	50	62		-40/+257
	811/811HT w/81							300	250	200	150	100	62		-40/+257
	881 w/43/81/DB							300	250	200	150	100	62		-40/+257
Push-Lok	804		150		150	150		150							-40/+176
	801		250		250	250	250	250	175						-40/+212
	836		250		250	250	250								-55/+302
	821		350		300	300	250	250							-40/+212
	821FR		350		300	300	250	250							-40/+212
	831		350		300	300	300	300							-40/+212
	271				225	225									-50/+212
Transportation	SS23CG				350	350	350	350							-40/+250
	SS25UL		350	350	350	350	350	350							-40/+250
	293		500		500	500	450	450	450						-58/+302
	221FR			500	500	500	500	500	500						-4/+212
	213		2000	1500	1500	1250	1000	750	400	300	300	200			-50/+302
	266		2000	1500	1500	1250	1250	750	400	300	250				-55/+302
	201		3000	3000	2250	2000	1750	1500	800	625	500	350	350	200	-40/+302
	206		3000	3000	2250	2000	1750	1500	800	625	500	350	350		-55/+302
	225		3000	3000	2250	2000	1750	1500	800	625	500	350			-40/+212
	Refrigerant	285		500		500	500	500	500						
244								500	500	500					-22/+257

Hose  
**A**

Fittings  
**B**

Equipment  
**C**

Accessories  
**D**

Technical  
**M**

# Pressure

## Pressure Rating of Hose End Connections

**PRESSURE RATINGS HOSE ASSEMBLIES - PSI**

THE MAXIMUM DYNAMIC WORKING PRESSURE OF THE HOSE ASSEMBLY IS THE LESSER OF THE RATED WORKING PRESSURE OF THE HOSE AND THE END CONNECTIONS USED.

Hose End Connection Description	Part Number Codes	Inch Size Fittings (psi)										
		-2	-4	-5	-6	-8	-10	-12	-16	-20	-24	-32
Male Pipe (NPTF)	01	12,000	12,000		10,000	10,000		7,500	6,500	5,000	3,000	2,500
Female Pipe (NPTF, NPSM)	02 & 07	7,500	7,000		6,000	5,000		4,000	3,000	2,500	2,000	2,000
Male Pipe (BSP)	91 & D9	5,000	9,000		8,000	6,250		5,000	4,000	3,500	3,000	3,000
Female Pipe (BSP)	92, B1, B2 & B4	5,000	9,000		8,000	6,250	5,500	5,000	4,000	3,500	3,000	3,000
JIS	FU, GU, MU & UT		5,000		5,000	5,000		4,000	3,000	2,500	1,500	1,500
O-Ring Swivel and 45° Flare*	13, 1L, S2, 0G, 0L, 48, 08, 77 & 79		3,000	3,000	3,000	3,000	2,750	2,250	2,000	1,625	1,250	1,125
37° Flare and Straight Thread*	03, 05, 06**, 37, 39**, 41, L7 & L9		6,000	6,000	5,000	5,000	5,000	5,000	4,000	3,000	2,500	2,500
SAE Flareless	11 & 12		6,000	6,000	5,600	5,600	4,200	4,200	3,500	3,500	3,000	3,000
SAE Inverted Flare	28, 67 & 69		2,750	2,500	2,250	2,000						
Seal-Lok®* (O-ring Face Seal)	JM, JC, JS, J0, J1, J5, J7 & J9		9,200		9,200	9,200	6,000	6,000	6,000	4,000	4,000	
SAE Flanges Code 61	15, 16, 17, 18, 19, 26, 27 & 89						5,000	5,000	5,000	4,000	4,000	3,000
SAE Flanges Code 61 Special	4A, 4F & 4N									5,000	5,000	5,000
SAE Flanges Code 62	6A, 6E, 6F, 6G, 6N, XA, XF, XG & XN								6,000	6,000	6,000	6,000

\*NOTE: 45°, 37° and Seal-Lok Torque Tables are on page E-15

\*\*NOTE: For pressure rating of 06 and 39 end configurations in 73, 78, and 79 series, see each description in Section B.

Hose End Connection Description	Part Number Codes	Metric Fittings (psi)															
		-6	-8	-10	-12	-14	-15	-16	-18	-20	-22	-25	-28	-30	-35	-38	-42
DIN Light "L" without O-Ring	C3, C4, C5 & 1D	3,500	3,500	3,500	3,500		3,500		2,250		2,250		1,400		1,400		1,400
DIN Light "L" with O-Ring	D0, CA, CE & CF	4,500	4,500	4,500	4,500		4,500		2,250		2,250		2,250		2,250		2,250
DIN Heavy "S" without O-Ring	C6, C7, C8 & 3D		9,000	9,000	9,000	9,000		5,750		5,750		5,750		3,500		3,500	
DIN Heavy "S" with O-Ring	C9, 0C, 1C & D2		9,000	9,000	9,000	9,000		6,000		6,000		6,000		6,000		4,500	
DIN 20078 Form C	C0									900		900		900		900	
Banjo	49	3,000	3,000	3,000	3,000		3,000		3,000	3,000	3,000						
French Metric	F9 & FA			3,000	3,500	2,000			2,250	2,000	1,900			1,750			

Hose End Connection Description	Part Number Codes	French Gaz Fittings (psi)				
		-13	-17	-21	-27	-33
French Gaz	F4, FG, GJ & GE	5,250	3,900	3,700	3,000	2,500

\*NOTE: ALL THE ABOVE RATINGS ARE BASED ON LOW CARBON STEEL HOSE FITTINGS. HIGHER PRESSURE RATINGS CAN BE ATTAINED WITH MEDIUM CARBON AND ALLOY STEEL HOSE FITTINGS AND MATING ADAPTERS.

**PRESSURE RATING OF HOSE - PSI**

THE MAXIMUM WORKING PRESSURES OF HOSE ARE LISTED ON PAGE E-30 and E-31 AND WITH EACH HOSE DESCRIPTION IN SECTION A.

A Hose

B Fittings

C Equipment

D Accessories

E Technical

# Pressure

## Metric Pressure Conversions

PRESSURE CONVERSIONS									
Kilo-Pascals (kPa)	Mega-Pascals (MPa)	Bar (bar)	Kilograms per Square Centimeter (Kgf/cm <sup>2</sup> )	lbs per Square Inch (psi)	lbs per Square Inch (psi)	Kilo-Pascals (kPa)	Mega-Pascals (MPa)	Bar (bar)	Kilograms per Square Centimeter (Kgf/cm <sup>2</sup> )
100	0.1	1.00	1.0	14.50	10	68.9	0.07	0.7	0.70
200	0.2	2.00	2.0	29.00	20	137.9	0.14	1.4	1.41
300	0.3	3.00	3.1	43.50	30	206.8	0.21	2.1	2.11
400	0.4	4.00	4.1	58.00	40	275.8	0.28	2.8	2.81
500	0.5	5.00	5.1	72.50	50	344.7	0.34	3.4	3.52
600	0.6	6.00	6.1	87.00	60	413.7	0.41	4.1	4.22
700	0.7	7.00	7.1	101.50	70	482.6	0.48	4.8	4.92
800	0.8	8.00	8.2	116.00	80	551.6	0.55	5.5	5.63
900	0.9	9.00	9.2	130.50	90	620.5	0.62	6.2	6.33
1000	1.0	10.00	10.2	145.00	100	689.0	0.70	6.9	7.00
2000	2.0	20.00	20.4	290.10	200	1379.0	1.40	13.8	14.10
3000	3.0	30.00	30.6	435.10	300	2068.0	2.10	20.7	21.10
4000	4.0	40.00	40.8	580.20	400	2758.0	2.80	27.6	28.10
5000	5.0	50.00	51.0	725.20	500	3447.0	3.40	34.5	35.20
6000	6.0	60.00	61.2	870.20	600	4137.0	4.10	41.4	42.20
7000	7.0	70.00	71.4	1015.30	700	4826.0	4.80	48.3	49.20
8000	8.0	80.00	81.6	1160.30	800	5516.0	5.50	55.2	56.30
9000	9.0	90.00	91.8	1305.30	900	6205.0	6.20	62.1	63.30
10000	10.0	100.00	102.0	1450.00	1000	6895.0	6.90	68.9	70.30
20000	20.0	200.00	204.0	2901.00	2000	13790.0	13.80	137.9	140.70
30000	30.0	300.00	306.0	4351.00	3000	20684.0	20.70	206.8	211.00
40000	40.0	400.00	408.0	5802.00	4000	27579.0	27.60	275.8	281.30
50000	50.0	500.00	510.0	7252.00	5000	34474.0	34.50	344.7	351.60
60000	60.0	600.00	612.0	8702.00	6000	41369.0	41.40	413.7	421.90
70000	70.0	700.00	714.0	10153.00	7000	48263.0	48.30	482.6	492.30
80000	80.0	800.00	816.0	11603.00	8000	55158.0	55.20	551.6	562.60
90000	90.0	900.00	918.0	13053.00	9000	62053.0	62.10	620.5	632.90
100000	100.0	1000.00	1020.0	14504.00	10000	68948.0	68.90	689.0	703.00
200000	100.0	2000.00	2040.0	29008.00	20000	137895.0	137.90	1379.0	1406.00
300000	300.0	3000.00	3060.0	43511.00	30000	206843.0	206.80	2068.0	2110.00
					40000	275790.0	275.80	2758.0	2813.00

Hose  
**A**

Fittings  
**B**

Equipment  
**C**

Accessories  
**D**

Technical  
**M**

**A** Hose

**B** Fittings

**C** Equipment

**D** Accessories

**M** Technical

PART NUMBER	PAGE NUMBER	PART NUMBER	PAGE NUMBER	PART NUMBER	PAGE NUMBER
201	A-27	11843	B-41	113HY	B-113
206	A-27	11871	B-75	11C43	B-52
213	A-26	11943	B-41	11C70	B-65
225	A-28	11970	B-61	11C73	B-90
244	A-29	11971	B-75	11C78	B-103
266	A-26	11973	B-85	11D43	B-47
271	A-24	11978	B-97	11L43	B-30
285	A-29	12643	B-40	11LHY	B-114
293	A-25	12671	B-74	128HY	B-121
422	A-8	12743	B-41	129HY	B-122
424	A-8	12771	B-74	12U71	B-76
426	A-9	12826	B-14	134HY	B-121
431	A-11	12843	B-38	137HY	B-118
436	A-11	13726	B-12	139HY	B-118
601	A-8	13743	B-34	13D43	B-50
701	A-17	13771	B-71	13DHY	B-125
711	A-16	13926	B-12	141HY	B-119
731	A-18	13943	B-35	14526-PR	B-18
761	A-19	13970	B-60	14526-PT	B-18
774	A-16	13971	B-72	14A73	B-85
781	A-16	13973	B-84	14A78	B-97
801	A-22	13978	B-96	14AS6	B-104
804	A-22	14126	B-13	14F73	B-85
811	A-20	14143	B-36	14F78	B-97
821	A-23	14171	B-72	14FS6	B-104
836	A-22	14943	B-54	14N73	B-86
881	A-21	16726	B-15	14N78	B-98
10125	B-6	16743	B-39	14NS6	B-104
10126	B-11	16826	B-14	14V43	B-36
10143	B-29	16926	B-15	1588	B-185
10170	B-60	16943	B-39	15926-PB	B-20
10173	B-84	17726	B-13	15926-PT	B-20
10178	B-96	17743	B-37	15G26	B-19
10243	B-30	17926	B-14	15G26-PR	B-19
10326	B-11	17943	B-37	15H26	B-20
10343	B-32	18971	B-76	15K26	B-17
10370	B-60	19243	B-52	15K26-PB	B-17
10371	B-70	015301	C-6	15K26-PR	B-18
10426	B-13	017M	B-6	15L26	B-21
10443	B-36	0188	B-184	15L26-PB	B-21
10543	B-31	01TB	B-190	15L26-PR	B-22
10571	B-70	025411	C-6	15L26-PT	B-22
10626	B-12	0588	B-184	15M26-PR	B-18
10643	B-33	05TB	B-191	15M26-PT	B-19
10670	B-60	0688	B-185	15N26-PB	B-21
10671	B-71	10081	B-187	15N26-PT	B-21
10673	B-84	10171	B-70	15P26-PT	B-22
10678	B-96	101HY	B-113	15R26	B-17
10743	B-30	101S6	B-104	15S26	B-19
10825	B-6	102HY	B-114	15T26	B-20
10826	B-13	103HY	B-116	15T3	D-5
10843	B-36	105HY	B-115	15V26	B-23
11143	B-37	106HY	B-117	15W26	B-23
11243	B-38	106S6	B-104	15Z26	B-23
11343	B-29	107HY	B-114	167HY	B-121
11543	B-39	108HY	B-119	169HY	B-122
11571	B-73	10C43	B-51	16A70	B-61
11573	B-84	10C70	B-65	16A71	B-76
11578	B-96	10C73	B-89	16A73	B-86
11643	B-40	10C78	B-103	16A78	B-98
11671	B-73	10G43	B-31	16A79	B-108
11743	B-40	10GHY	B-115	16AS6	B-105
11770	B-61	10L43	B-32	16B78	B-98
11771	B-74	10LHY	B-116	16E78	B-98
11773	B-85	111HY	B-120	16F71	B-76
11778	B-97	11243	B-38	16F73	B-86

PART NUMBER	PAGE NUMBER	PART NUMBER	PAGE NUMBER	PART NUMBER	PAGE NUMBER
16F78	B-99	1GJHY	B-120	1XB78	B-100
16F79	B-108	1GU43	B-56	1XE78	B-100
16FS6	B-105	1GU70	B-64	1XF78	B-101
16G78	B-99	1GU71	B-80	1XF79	B-110
16G79	B-108	1GU73	B-88	1XG78	B-101
16N70	B-62	1GU78	B-103	1XN78	B-101
16N71	B-77	1GUHY	B-126	1XN79	B-110
16N73	B-86	1J043	B-42	1XU43	B-55
16N78	B-99	1J071	B-77	1XU71	B-81
16N79	B-109	1J0HY	B-122	1XUHY	B-126
16NS6	B-105	1J143	B-47	20120	B-128
177HY	B-120	1J170	B-63	20121	B-138
1788	B-186	1J171	B-79	20122	B-146
179HY	B-120	1J1HY	B-124	20130	B-154
17B25	B-6	1J543	B-46	20142	B-160
17B26	B-22	1J570	B-63	20320	B-128
17T3	D-5	1J571	B-79	20330	B-155
18A76	B-93	1J643	B-44	20342	B-161
18F76	B-93	1J726	B-16	20420	B-130
18N76	B-93	1J743	B-45	20530	B-154
19270	B-65	1J770	B-62	20542	B-160
193HY	B-119	1J771	B-78	20620	B-129
1988	B-186	1J773	B-87	20621	B-138
19T3	D-5	1J778	B-102	20622	B-146
1B143	B-53	1J779	B-109	20623	B-150
1B170	B-65	1J7HY	B-123	20630	B-155
1B173	B-91	1J926	B-16	20642	B-161
1B243	B-53	1J943	B-46	20820	B-131
1B270	B-66	1J970	B-63	20821	B-139
1B273	B-91	1J971	B-79	20822	B-146
1B443	B-53	1J973	B-87	20823	B-150
1B543	B-54	1J978	B-102	20830	B-156
1C043	B-51	1J979	B-109	20842	B-162
1C343	B-48	1J9HY	B-124	21120	B-132
1C443	B-48	1JB43	B-42	21130	B-157
1C543	B-48	1JC26	B-15	21230	B-157
1C643	B-50	1JC43	B-43	21330	B-154
1C943	B-51	1JC70	B-62	21342	B-160
1C970	B-66	1JC71	B-77	21520	B-133
1C971	B-80	1JCHY	B-122	21720	B-134
1C973	B-89	1JS43	B-44	2188	B-184
1C978	B-103	1JS70	B-62	21920	B-134
1CA43	B-49	1JS71	B-78	21D42	B-163
1CA70	B-66	1JS73	B-87	21TB	B-190
1CE43	B-49	1JS78	B-102	221FR	A-25
1CE70	B-66	1JS79	B-109	22820	B-132
1CF43	B-49	1JSHY	B-123	22821	B-140
1CF70	B-67	1JSS6	B-105	23220	B-133
1D043	B-47	1L743	B-34	23221	B-140
1D0HY	B-125	1L943	B-35	23223	B-150
1D243	B-50	1L971	B-72	23720	B-129
1D270	B-67	1LB43	B-33	23721	B-138
1D271	B-80	1MU43	B-55	23730	B-156
1D273	B-89	1MU71	B-81	23742	B-162
1D278	B-103	1RV26	B-23	239	C-22
1D943	B-52	1RZ26	B-24	23920	B-130
1D970	B-67	1S243	B-31	23921	B-139
1D973	B-90	1S526	B-16	23930	B-156
1D9HY	B-125	1S526-PR	B-17	23942	B-162
1F443	B-56	1T126	B-24	24120	B-130
1FG70	B-64	1UT43	B-56	24121	B-139
1FU43	B-56	1UT71	B-80	24130	B-156
1FU71	B-81	1UTHY	B-126	24142	B-162
1G173	B-88	1XA78	B-100	25H21	B-142
1G273	B-88	1XA79	B-110	25L21	B-142
1GJ43	B-38	1XAS6	B-105	25M21	B-141

Hose  
**A**

Fittings  
**B**

Equipment  
**C**

Accessories  
**D**

Technical  
**M**



**A** Hose  
**B** Fittings  
**C** Equipment  
**D** Accessories  
**E** Technical

PART NUMBER	PAGE NUMBER	PART NUMBER	PAGE NUMBER	PART NUMBER	PAGE NUMBER
25N21	B-142	3B282	B-175	80C-Axx	C-8
25S21	B-141	3C382	B-178	80C-R01	C-8
25T21	B-142	3C482	B-177	80C-R02	C-8
25TB	B-191	3C582	B-178	80C-SDR	C-25
26120	B-133	3CA82	B-177	80C-SDR-BASE	C-25
26720	B-132	3CF82	B-177	80C-SDR-LG	C-25
26721	B-140	3D082	B-174	80C-SDR-SM	C-25
26920	B-133	3D982	B-175	811HT	A-20
26921	B-141	3J182	B-173	81C-R01	C-21
2726	C-26	3J782	B-173	81C-R02	C-21
2727	C-26	3J982	B-173	821FR	A-23
27720	B-131	3JC82	B-173	82C-001	C-8
27721	B-139	40B-Cabinet	D-27	82C-002	C-8
27920	B-131	41T3	D-6	82C-00L	C-8
27921	B-140	421WC	A-9	82C-00L	C-8
28120	B-132	432-115V	C-24	82C-061	C-8
29242	B-164	451ST	A-12	82C-080	C-8
2C342	B-164	451TC	A-12	82C-0AP	C-20
2C642	B-164	451TC Twin Tough	A-12	82C-0EP	C-20
2J120	B-135	471ST	A-13	82C-0HP	C-20
2J720	B-134	471TC	A-13	82C-0HP	C-8
2J920	B-135	471TC Twin Tough	A-14	82C-R01	C-8
2J930	B-157	472TC	A-14	82C-R01-PDF	C-6
2J942	B-163	482ST	A-10	82C-R02	C-8
2JS20	B-134	482TC	A-10	832021	C-8
2JS30	B-157	4AH3	D-6	83C-001	C-14
2JS42	B-163	4AJM	D-8	83C-002	C-14
2S521	B-141	4FH3	D-7	83C-080	C-14
3/4 Reel Rack	D-27	4FJM	D-8	83C-081	C-14
30182	B-168	4NH3	D-7	83C-082	C-14
301LT	A-12	4NJM	D-8	83C-0DR	C-24
302	A-13	5050HK	D-11	83C-KDA	C-14
30282	B-169	50H	D-10	83C-OCB	C-12
30382	B-169	5151HK	D-11	83C-OCB	C-14
304	A-11	51H	D-11	83C-R02	C-12
30482	B-171	59RG	D-17	83C-R02	C-14
30682	B-170	601069	C-25	83C-R02H	C-12
30882	B-171	631075	C-22	83C-R02H	C-14
31382	B-168	652200	C-26	83C-S20	C-14
316	C-23	652201	C-26	83C-S40	C-14
3188	B-184	662451	C-24	85C-080	C-10
31D82	B-175	6AH3	D-7	85C-0EP	C-20
31TB	B-190	6AJM	D-9	85C-0HP	C-20
32882	B-172	6FH3	D-7	85C-12V	C-20
32982	B-172	6FJM	D-9	85C-R01	C-10
332T-115V	C-22	6NH3	D-8	85C-R02	C-10
33482	B-174	6NJM	D-9	871522	C-23
33782	B-170	711509	D-15	881540	C-23
339	C-22	711510	D-15	8888	B-187
33982	B-170	721	A-15	88C-081	C-12
341	A-13	721ST	A-15	88C-082	C-12
34182	B-170	721TC	A-15	88DB	B-187
34982	B-176	72B-Cabinet	D-27	88DB Clamp	D-24
351ST	A-14	72B-Cabinet	D-28	88HC	B-187
351TC	A-14	772ST	A-15	88HC-H	B-187
35TB	B-191	772TC	A-15	88HC-H Clamp	D-24
36782	B-172	782ST	A-17	89C-061	C-10
36982	B-172	782TC	A-17	89C-062	C-10
37782	B-171	791TC	A-18	8ARG	D-16
3788	B-185	792ST	A-19	8FH	D-12
37982	B-171	792TC	A-19	8FHFHK	D-12
37G82	B-169	80C-061	C-8	8GC-002	C-21
38282	B-174	80C-101	C-8	8PC-001	C-21
39282	B-175	80C-181	C-8	8PC-00P	C-21
3988	B-185	80C-9DR	C-24	8PC-030	C-21
39T3	D-6	80C-Axx	C-21	8WC-001	C-21



PART NUMBER	PAGE NUMBER	PART NUMBER	PAGE NUMBER	PART NUMBER	PAGE NUMBER
94C-001-PFD	C-6	Rotary Reel Rack	D-27		
94C-002-PFD	C-6	Saw Table	D-27		
94C-080-PD	C-6	Spring Guard (SG)	D-20		
Accrolube	C-25	SS23CG	A-24		
AM	B-176	SS25UL	A-24		
AM	B-54	Standard Pressure (Code 61)	D-10		
Armor Guard (AG)	D-20	T1RG	D-17		
AX	A-9	TH11-1	C-23		
BXX	A-10	TH2-7	C-24		
C9RG	D-15	TH2-7-ELS	C-24		
C9RG	D-15	TH2-7M25-6	C-26		
CL Clamp	D-23	TH2-7M25-8	C-26		
Clamp	B-187	TH7-4	D-26		
Conversion Kits	C-21	TH7-5-C	D-26		
CORG	D-17	TH7-5-C	D-27		
D9DT	D-15	TH7-5-HT	D-26		
F42	A-18	TH7-5-HT	D-27		
Firesleeve (FS-F)	D-21	TH7-5-R	D-27		
Firesleeve Accessories	D-22	TH7-5-S	D-27		
FSC Clamp	D-21	TH7-6	D-26		
HC Clamp	D-24	TH7-6	D-27		
HFH	D-12	TH7-6-C	D-26		
HFHFHK	D-12	TH7-6-C	D-27		
High Pressure (Code 62)	D-10	TH7-7	D-26		
Hose Adapters	D-4	TH7-7	D-27		
Hose Assembly Workstations	D-26	TH7-8	D-26		
Hose Oil	C-25	TH7-8	D-27		
HoseFab Table	D-27	TH7-8-F	D-26		
HP	D-25	TH7-8-F	D-27		
HP-13 RFL	D-25	TH9-1-26A	C-24		
HP-15 RFL	D-25	TH9-1-26B	C-24		
HP-18 RFL	D-25	TH9-1-43A	C-24		
HP-B	D-25	TH9-1-43B	C-24		
HP-B-13	D-25	TH9-1-70	C-24		
HP-B-13-RFL	D-25	TH9-1-71	C-24		
HP-B-13X18-KIT	D-25	TH9-1-73	C-24		
HP-B-15	D-25	TH9-1-78	C-24		
HP-B-15-RFL	D-25	TH9-1-HY	C-24		
HP-B-18	D-25	TH9-1-STD	C-24		
HP-B-18-RFL	D-25	XARG	D-16		
HR6 Hose Bin	D-28				
HT	D-25				
HT-12	D-25				
HT-12-KIT	D-25				
HT-16	D-25				
HT-16-KIT	D-25				
HT-22	D-25				
HT-22-KIT	D-25				
J0RG	D-16				
JC88	B-186				
JK	A-19				
JS88	B-186				
M1H	D-13				
M1M1HK	D-13				
M2H	D-14				
M2M2HK	D-14				
P35	A-17				
Parker Kart	D-28				
ParKoil (PG)	D-19				
Partek Sleeve	D-18				
Polyguard (HG)	D-19				
Protection Shields	D-25				
Pumps	C-20				
Push-Lok Kits	B-179				
Push-Lok Merchandiser	B-180				

Hose  
**A**

Fittings  
**B**

Equipment  
**C**

Accessories  
**D**

Technical  
**E**





Hose  
**A**

Male Pipe Thread Sizes



Fittings  
**B**



SAE (JIC) 37° Flare Nose Cone Sizes



Equipment  
**C**

SAE (JIC) 37° Flare Nose Cone Sizes

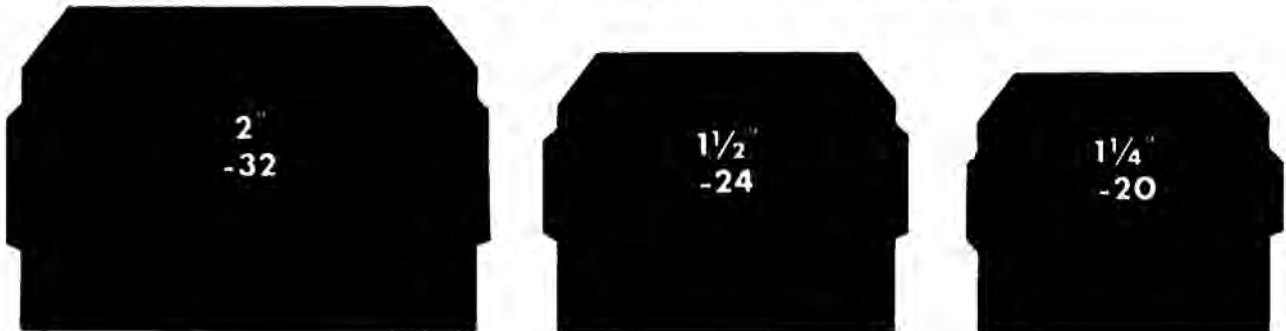

Accessories  
**D**



37° and 45° Flare  
Nose Angles

SAE 45° Flare  
Nose Cone Sizes



Technical  
**E**

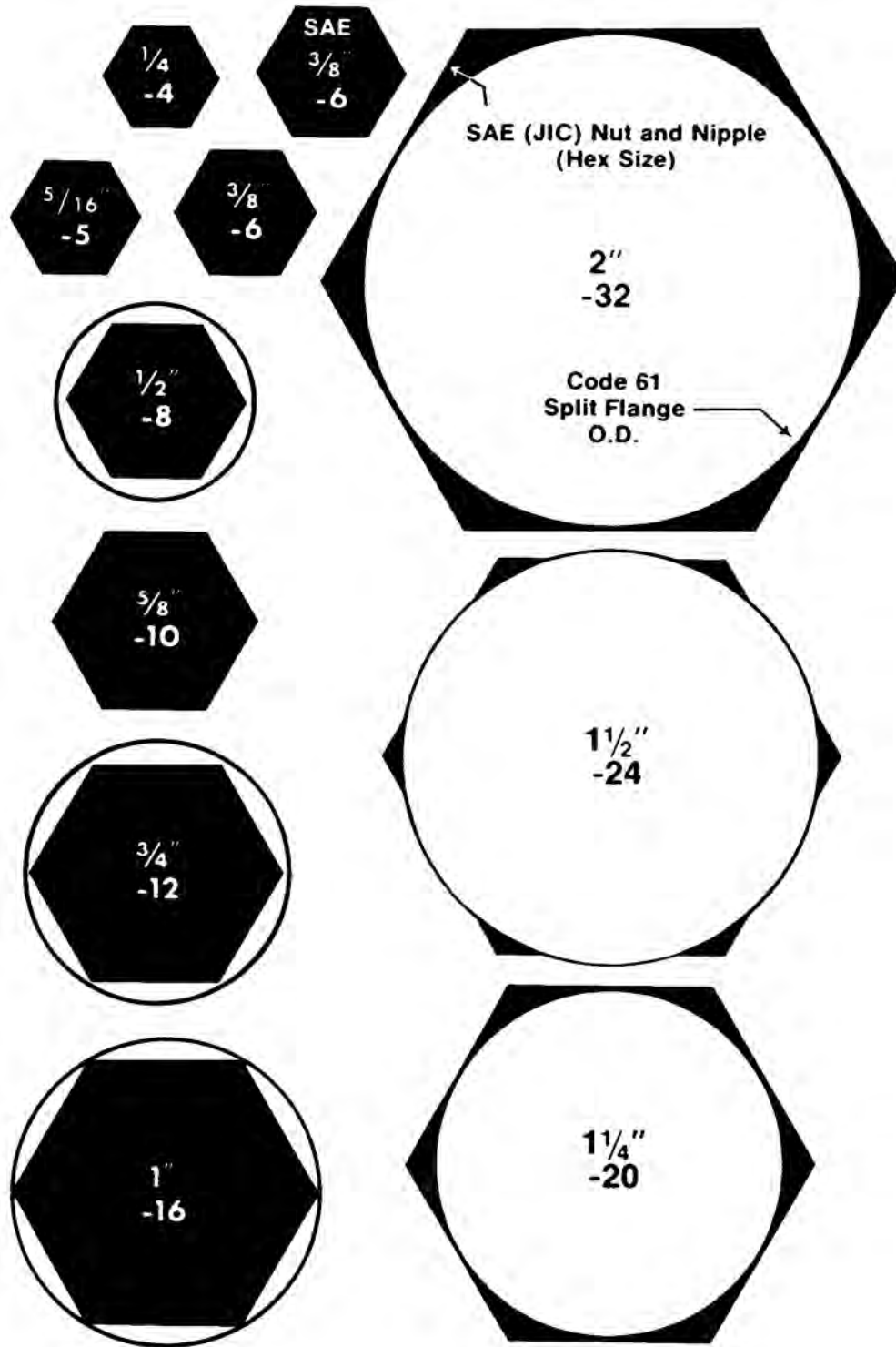

Hose  
**A**

Fittings  
**B**

Equipment  
**C**

Accessories  
**D**

Technical  
**E**

# Safety Guide

## Parker Safety Guide for Selecting and Using Hose, Tubing, Fittings and Related Accessories

Parker Publication No. 4400-B.1

Revised: November, 2007

**WARNING:** Failure or improper selection or improper use of hose, tubing, fittings, assemblies or related accessories ("Products") can cause death, personal injury and property damage. Possible consequences of failure or improper selection or improper use of these Products include but are not limited to:

- Fittings thrown off at high speed.
- High velocity fluid discharge.
- Explosion or burning of the conveyed fluid.
- Electrocutation from high voltage electric powerlines.

- Contact with suddenly moving or falling objects that are controlled by the conveyed fluid.
- Injections by high-pressure fluid discharge.
- Dangerously whipping Hose.
- Contact with conveyed fluids that may be hot, cold, toxic or otherwise injurious.
- Sparking or explosion caused by static electricity buildup or other sources of electricity.
- Sparking or explosion while spraying paint or flammable liquids.
- Injuries resulting from inhalation, ingestion or exposure to fluids.

Before selecting or using any of these Products, it is important that you read and follow the instructions below. Only Hose from Parker's Stratoflex Products Division is approved for in flight aerospace applications.

### 1.0 GENERAL INSTRUCTIONS

1.1 Scope: This safety guide provides instructions for selecting and using (including assembling, installing, and maintaining) these Products. For convenience, all rubber and/or thermoplastic products commonly called "hose" or "tubing" are called "Hose" in this safety guide. All assemblies made with Hose are called "Hose Assemblies". All products commonly called "fittings", "couplings" or "adapters" are called "Fittings". All related accessories (including crimping and swaging machines and tooling) are called "Related Accessories". This safety guide is a supplement to and is to be used with the specific Parker publications for the specific Hose, Fittings and Related Accessories that are being considered for use. Parker publications are available at [www.parker.com](http://www.parker.com). SAE J1273 ([www.sae.org](http://www.sae.org)) and ISO 17165 2 ([www.ansi.org](http://www.ansi.org)) also provide recommended practices for hydraulic Hose Assemblies.

1.2 Fail-Safe: Hose, Hose Assemblies and Fittings can and do fail without warning for many reasons. Design all systems and equipment in a fail safe mode, so that failure of the Hose, Hose Assembly or Fitting will not endanger persons or property.

1.3 Distribution: Provide a copy of this safety guide to each person responsible for selecting or using Hose and Fitting products. Do not select or use Parker Hose or Fittings without thoroughly reading and understanding this safety guide as well as the specific Parker publications for the Products.

1.4 User Responsibility: Due to the wide variety of operating conditions and applications for Hose and Fittings, Parker does not represent or warrant that any particular Hose or Fitting is suitable for any specific end use system. This safety guide does not analyze all technical parameters that must be considered in selecting a product. The user, through its own analysis and testing, is solely responsible for:

- Making the final selection of the Products.
- Assuring that the user's requirements are met and that the application presents no health or safety hazards.
- Providing all appropriate health and safety warnings on the equipment on which the Products are used.
- Assuring compliance with all applicable government and industry standards.

1.5 Additional Questions: Call the appropriate Parker technical service department if you have any questions or require any additional information. See the Parker publication for the Products being considered or used, or call 1 800 CPARKER, or go to [www.parker.com](http://www.parker.com), for telephone numbers of the appropriate technical service department.

### 2.0 HOSE AND FITTING SELECTION INSTRUCTIONS

2.1 Electrical Conductivity: Certain applications require that the Hose be nonconductive to prevent electrical current flow. Other applications require the Hose and the Fittings and the Hose/Fitting interface to be sufficiently conductive to drain off static electricity. Extreme care must be exercised when selecting Hose and Fittings for these or any other applications in which electrical conductivity or nonconductivity is a factor.

The electrical conductivity or nonconductivity of Hose and Fittings is dependent upon many factors and may be susceptible to change. These factors include but are not limited to the various materials used to make the Hose and the Fittings, Fitting finish (some Fitting finishes are electrically conductive while others are non-conductive), manufacturing methods (including moisture control), how the Fittings contact the Hose, age and amount of deterioration or damage or other changes, moisture content of the Hose at any particular time, and other factors.

The following are considerations for electrically nonconductive and conductive

Hose. For other applications consult the individual catalog pages and the appropriate industry or regulatory standards for proper selection.

2.1.1 Electrically Nonconductive Hose: Certain applications require that the Hose be nonconductive to prevent electrical current flow or to maintain electrical isolation. For applications that require Hose to be electrically nonconductive, including but not limited to applications near high voltage electric lines, only special nonconductive Hose can be used. The manufacturer of the equipment in which the nonconductive Hose is to be used must be consulted to be certain that the Hose and Fittings that are selected are proper for the application. Do not use any Parker Hose or Fittings for any such application requiring nonconductive Hose, including but not limited to applications near high voltage electric lines, unless (i) the application is expressly approved in the Parker technical publication for the product, (ii) the Hose is marked "nonconductive", and (iii) the manufacturer of the equipment on which the Hose is to be used specifically approves the particular Parker Hose and Fittings for such use.

2.1.2 Electrically Conductive Hose: Parker manufactures special Hose for certain applications that require electrically conductive Hose.

Parker manufactures special Hose for conveying paint in airless paint spraying applications. This Hose is labeled "Electrically Conductive Airless Paint Spray Hose" on its layline and packaging. This Hose must be properly connected to the appropriate Parker Fittings and properly grounded in order to dissipate dangerous static charge buildup, which occurs in all airless paint spraying applications. Do not use any other Hose for airless paint spraying, even if electrically conductive. Use of any other Hose or failure to properly connect the Hose can cause a fire or an explosion resulting in death, personal injury, and property damage.

Parker manufactures a special Hose for certain compressed natural gas ("CNG") applications where static electricity buildup may occur. Parker CNG Hose assemblies comply with the requirements of ANSI/IAS NGV 4.2-1999; CSA 12.52-M99, "Hoses for Natural Gas Vehicles and Dispensing Systems" ([www.ansi.org](http://www.ansi.org)). This Hose is labeled "Electrically Conductive for CNG Use" on its layline and packaging. This Hose must be properly connected to the appropriate Parker Fittings and properly grounded in order to dissipate dangerous static charge buildup, which occurs in, for example, high velocity CNG dispensing or transfer. Do not use any other Hose for CNG applications where static charge buildup may occur, even if electrically conductive. Use of other Hoses in CNG applications or failure to properly connect or ground this Hose can cause a fire or an explosion resulting in death, personal injury, and property damage. Care must also be taken to protect against CNG permeation through the Hose wall. See section 2.6, Permeation, for more information. Parker CNG Hose is intended for dispenser and vehicle use at a maximum temperature of 180°F (82°C). Parker CNG Hose should not be used in confined spaces or unventilated areas or areas exceeding 180°F (82°C). Final assemblies must be tested for leaks. CNG Hose Assemblies should be tested on a monthly basis for conductivity per ANSI/IAS NGV 4.2-1999; CSA 12.52-M99.

Parker manufactures special Hose for aerospace in flight applications. Aerospace in flight applications employing Hose to transmit fuel, lubricating fluids and hydraulic fluids require a special Hose with a conductive inner tube. This Hose for in flight applications is available only from Parker's Stratoflex Products Division. Do not use any other Parker Hose for in flight applications, even if electrically conductive. Use of other Hoses for in flight applications or failure to properly connect or ground this Hose can cause a fire or an explosion resulting in death, personal injury and property damage. These Hose assemblies for in flight applications must meet all applicable aerospace industry, aircraft engine and aircraft requirements.

A  
Hose

B  
Fittings

C  
Equipment

D  
Accessories

M  
Technical



## Safety Guide

**2.2 Pressure:** Hose selection must be made so that the published maximum working pressure of the Hose and Fittings are equal to or greater than the maximum system pressure. The maximum working pressure of a Hose Assembly is the lower of the respective published maximum working pressures of the Hose and the Fittings used. Surge pressures or peak transient pressures in the system must be below the published maximum working pressure for the Hose. Surge pressures and peak pressures can usually only be determined by sensitive electrical instrumentation that measures and indicates pressures at millisecond intervals. Mechanical pressure gauges indicate only average pressures and cannot be used to determine surge pressures or peak transient pressures. Published burst pressure ratings for Hose is for manufacturing test purposes only and is no indication that the Product can be used in applications at the burst pressure or otherwise above the published maximum recommended working pressure.

**2.3 Suction:** Hoses used for suction applications must be selected to insure that the Hose will withstand the vacuum and pressure of the system. Improperly selected Hose may collapse in suction application.

**2.4 Temperature:** Be certain that fluid and ambient temperatures, both steady and transient, do not exceed the limitations of the Hose. Temperatures below and above the recommended limit can degrade Hose to a point where a failure may occur and release fluid. Properly insulate and protect the Hose Assembly when routing near hot objects (e.g. manifolds). Do not use any Hose in any application where failure of the Hose could result in the conveyed fluids (or vapors or mist from the conveyed fluids) contacting any open flame, molten metal, or other potential fire ignition source that could cause burning or explosion of the conveyed fluids or vapors.

**2.5 Fluid Compatibility:** Hose Assembly selection must assure compatibility of the Hose tube, cover, reinforcement, and Fittings with the fluid media used. See the fluid compatibility chart in the Parker publication for the product being considered or used. This information is offered only as a guide. Actual service life can only be determined by the end user by testing under all extreme conditions and other analysis.

Hose that is chemically compatible with a particular fluid must be assembled using Fittings and adapters containing likewise compatible seals.

**2.6 Permeation:** Permeation (that is, seepage through the Hose) will occur from inside the Hose to outside when Hose is used with gases, liquid and gas fuels, and refrigerants (including but not limited to such materials as helium, diesel fuel, gasoline, natural gas, or LPG). This permeation may result in high concentrations of vapors which are potentially flammable, explosive, or toxic, and in loss of fluid. Dangerous explosions, fires, and other hazards can result when using the wrong Hose for such applications. The system designer must take into account the fact that this permeation will take place and must not use Hose if this permeation could be hazardous. The system designer must take into account all legal, government, insurance, or any other special regulations which govern the use of fuels and refrigerants. Never use a Hose even though the fluid compatibility is acceptable without considering the potential hazardous effects that can result from permeation through the Hose Assembly.

Permeation of moisture from outside the Hose to inside the Hose will also occur in Hose assemblies, regardless of internal pressure. If this moisture permeation would have detrimental effects (particularly, but not limited to refrigeration and air conditioning systems), incorporation of sufficient drying capacity in the system or other appropriate system safeguards should be selected and used.

**2.7 Size:** Transmission of power by means of pressurized fluid varies with pressure and rate of flow. The size of the components must be adequate to keep pressure losses to a minimum and avoid damage due to heat generation or excessive fluid velocity.

**2.8 Routing:** Attention must be given to optimum routing to minimize inherent problems (kinking or flow restriction due to Hose collapse, twisting of the Hose, proximity to hot objects or heat sources). For additional routing recommendations see SAE J1273 and ISO 17165-2. Hose Assemblies have a finite life and if possible, should be installed in a manner that allows for ease of inspection and future replacement. Rubber Hose because of its relative short life, should not be used in residential and commercial buildings for HVAC (heating, ventilating and air conditioning) applications.

**2.9 Environment:** Care must be taken to insure that the Hose and Fittings are either compatible with or protected from the environment (that is, surrounding conditions) to which they are exposed. Environmental conditions including but not limited to ultraviolet radiation, sunlight, heat, ozone, moisture, water, salt water, chemicals and air pollutants can cause degradation and premature failure.

**2.10 Mechanical Loads:** External forces can significantly reduce Hose life or cause failure. Mechanical loads which must be considered include excessive flexing, twist, kinking, tensile or side loads, bend radius, and vibration. Use of swivel type Fittings or adapters may be required to insure no twist is put into the Hose. Unusual applications may require special testing prior to Hose selection.

**2.11 Physical Damage:** Care must be taken to protect Hose from wear, snagging, kinking, bending smaller than minimum bend radius and cutting, any of which can cause premature Hose failure. Any Hose that has been kinked or bent to a radius smaller than the minimum bend radius, and any Hose that has been cut or is cracked or is otherwise damaged should be removed and discarded.

**2.12 Proper End Fitting:** See instructions 3.2 through 3.5. These recommendations may be substantiated by testing to industry standards such as SAE J517 for hydraulic applications, or MIL-A-5070, AS1339, or AS3517 for Hoses from Parker's Stratoflex Products Division for aerospace applications.

**2.13 Length:** When establishing a proper Hose length, motion absorption, Hose length changes due to pressure, and Hose and machine tolerances and movement must be considered.

**2.14 Specifications and Standards:** When selecting Hose and Fittings, government, industry, and Parker specifications and recommendations must be reviewed and followed as applicable.

**2.15 Hose Cleanliness:** Hose components may vary in cleanliness levels. Care must be taken to insure that the Hose Assembly selected has an adequate level of cleanliness for the application.

**2.16 Fire Resistant Fluids:** Some fire resistant fluids that are to be conveyed by Hose require use of the same type of Hose as used with petroleum base fluids. Some such fluids require a special Hose, while a few fluids will not work with any Hose at all. See instructions 2.5 and 1.5. The wrong Hose may fail after a very short service. In addition, all liquids but pure water may burn fiercely under certain conditions, and even pure water leakage may be hazardous.

**2.17 Radiant Heat:** Hose can be heated to destruction without contact by such nearby items as hot manifolds or molten metal. The same heat source may then initiate a fire. This can occur despite the presence of cool air around the Hose.

**2.18 Welding or Brazing:** When using a torch or arc welder in close proximity to hydraulic lines, the hydraulic lines should be removed or shielded with appropriate fire resistant materials. Flame or weld spatter could burn through the Hose and possibly ignite escaping fluid resulting in a catastrophic failure. Heating of plated parts, including Hose Fittings and adapters, above 450°F (232°C) such as during welding, brazing or soldering may emit deadly gases.

**2.19 Atomic Radiation:** Atomic radiation affects all materials used in Hose assemblies. Since the long-term effects may be unknown, do not expose Hose assemblies to atomic radiation.

**2.20 Aerospace Applications:** The only Hose and Fittings that may be used for in flight aerospace applications are those available from Parker's Stratoflex Products Division. Do not use any other Hose or Fittings for in flight applications. Do not use any Hose or Fittings from Parker's Stratoflex Products Division with any other Hose or Fittings, unless expressly approved in writing by the engineering manager or chief engineer of Stratoflex Products Division and verified by the user's own testing and inspection to aerospace industry standards.

**2.21 Unlocking Couplings:** Ball locking couplings or other Fittings with quick disconnect ability can unintentionally disconnect if they are dragged over obstructions, or if the sleeve or other disconnect member, is bumped or moved enough to cause disconnect. Threaded Fittings should be considered where there is a potential for accidental uncoupling.

### 3.0 HOSE AND FITTING ASSEMBLY AND INSTALLATION INSTRUCTIONS

**3.1 Component Inspection:** Prior to assembly, a careful examination of the Hose and Fittings must be performed. All components must be checked for correct style, size, catalog number, and length. The Hose must be examined for cleanliness, obstructions, blisters, cover looseness, kinks, cracks, cuts or any other visible defects. Inspect the Fitting and sealing surfaces for burrs, nicks, corrosion or other imperfections. Do NOT use any component that displays any signs of nonconformance.

**3.2 Hose and Fitting Assembly:** Do not assemble a Parker Fitting on a Parker Hose that is not specifically listed by Parker for that Fitting, unless authorized in writing by the engineering manager or chief engineer of the appropriate Parker division. Do not assemble a Parker Fitting on another manufacturer's

Hose  
**A**Fittings  
**B**Equipment  
**C**Accessories  
**D**Technical  
**M**

# Safety Guide

A Hose

B Fittings

C Equipment

D Accessories

M Technical

Hose or a Parker Hose on another manufacturer's Fitting unless (i) the engineering manager or chief engineer of the appropriate Parker division approves the Assembly in writing or that combination is expressly approved in the appropriate Parker literature for the specific Parker product, and (ii) the user verifies the Assembly and the application through analysis and testing. For Parker Hose that does not specify a Parker Fitting, the user is solely responsible for the selection of the proper Fitting and Hose Assembly procedures. See instruction 1.4.

To prevent the possibility of problems such as leakage at the Fitting or system contamination, it is important to completely remove all debris from the cutting operation before installation of the Fittings. The Parker published instructions must be followed for assembling the Fittings on the Hose. These instructions are provided in the Parker Fitting catalog for the specific Parker Fitting being used, or by calling 1 800 CPARKER, or at [www.parker.com](http://www.parker.com).

3.3 Related Accessories: Do not crimp or swage any Parker Hose or Fitting with anything but the listed swage or crimp machine and dies in accordance with Parker published instructions. Do not crimp or swage another manufacturer's Fitting with a Parker crimp or swage die unless authorized in writing by the engineering manager or chief engineer of the appropriate Parker division.

3.4 Parts: Do not use any Parker Fitting part (including but not limited to socket, shell, nipple, or insert) except with the correct Parker mating parts, in accordance with Parker published instructions, unless authorized in writing by the engineering manager or chief engineer of the appropriate Parker division.

3.5 Field Attachable/Permanent: Do not reuse any field attachable Hose Fitting that has blown or pulled off a Hose. Do not reuse a Parker permanent Hose Fitting (crimped or swaged) or any part thereof. Complete Hose Assemblies may only be reused after proper inspection under section 4.0. Do not assemble Fittings to any previously used hydraulic Hose that was in service, for use in a fluid power application.

3.6 Pre-Installation Inspection: Prior to installation, a careful examination of the Hose Assembly must be performed. Inspect the Hose Assembly for any damage or defects. DO NOT use any Hose Assembly that displays any signs of nonconformance.

3.7 Minimum Bend Radius: Installation of a Hose at less than the minimum listed bend radius may significantly reduce the Hose life. Particular attention must be given to preclude sharp bending at the Hose to Fitting juncture. Any bending during installation at less than the minimum bend radius must be avoided. If any Hose is kinked during installation, the Hose must be discarded.

3.8 Twist Angle and Orientation: Hose Assembly installation must be such that relative motion of machine components does not produce twisting.

3.9 Securement: In many applications, it may be necessary to restrain, protect, or guide the Hose to protect it from damage by unnecessary flexing, pressure surges, and contact with other mechanical components. Care must be taken to insure such restraints do not introduce additional stress or wear points.

3.10 Proper Connection of Ports: Proper physical installation of the Hose Assembly requires a correctly installed port connection insuring that no twist or torque is transferred to the Hose when the Fittings are being tightened or otherwise during use..

3.11 External Damage: Proper installation is not complete without insuring that tensile loads, side loads, kinking, flattening, potential abrasion, thread damage or damage to sealing surfaces are corrected or eliminated. See instruction 2.10.

3.12 System Checkout: All air entrapment must be eliminated and the system pressurized to the maximum system pressure (at or below the Hose maximum working pressure) and checked for proper function and freedom from leaks. Personnel must stay out of potential hazardous areas while testing and using.

3.13 Routing: The Hose Assembly should be routed in such a manner so if a failure does occur, the escaping media will not cause personal injury or property damage. In addition, if fluid media comes in contact with hot surfaces, open flame or sparks, a fire or explosion may occur. See section 2.4.

3.14 Ground Fault Equipment Protection Devices (GFEPDs): WARNING! Fire and Shock Hazard: To minimize the danger of fire if the heating cable of a Multitube bundle is damaged or improperly installed, use a Ground Fault Equipment Protection Device. Electrical fault currents may be insufficient to trip a conventional circuit breaker.

For ground fault protection, the IEEE 515:1989 ([www.ansi.org](http://www.ansi.org)) standard for heating cables recommends the use of GFEPDs with a nominal 30 milliampere trip level for "piping systems in classified areas, those areas requiring a high degree of maintenance, or which may be exposed to physical abuse or corrosive atmospheres".

## 4.0 HOSE AND FITTING MAINTENANCE AND REPLACEMENT INSTRUCTIONS

4.1 Even with proper selection and installation, Hose life may be significantly reduced without a continuing maintenance program. The severity of the application, risk potential from a possible Hose failure, and experience with any Hose failures in the application or in similar applications should determine the frequency of the inspection and the replacement for the Products so that Products are replaced before any failure occurs. A maintenance program must be established and followed by the user and, at minimum, must include instructions 4.2 through 4.7.

4.2 Visual Inspection Hose/Fitting: Any of the following conditions require immediate shut down and replacement of the Hose Assembly:

- Fitting slippage on Hose;
- Damaged, cracked, cut or abraded cover (any reinforcement exposed);
- Hard, stiff, heat cracked, or charred Hose;
- Cracked, damaged, or badly corroded Fittings;
- Leaks at Fitting or in Hose;
- Kinked, crushed, flattened or twisted Hose; and
- Blistered, soft, degraded, or loose cover.

4.3 Visual Inspection All Other: The following items must be tightened, repaired, corrected or replaced as required:

- Leaking port conditions;
- Excess dirt buildup;
- Worn clamps, guards or shields; and
- System fluid level, fluid type, and any air entrapment.

4.4 Functional Test: Operate the system at maximum operating pressure and check for possible malfunctions and leaks. Personnel must avoid potential hazardous areas while testing and using the system. See section 2.2.

4.5 Replacement Intervals: Hose assemblies and elastomeric seals used on Hose Fittings and adapters will eventually age, harden, wear and deteriorate under thermal cycling and compression set. Hose Assemblies and elastomeric seals should be inspected and replaced at specific replacement intervals, based on previous service life, government or industry recommendations, or when failures could result in unacceptable downtime, damage, or injury risk. See section 1.2. Hose and Fittings may be subjected to internal mechanical and/or chemical wear from the conveying fluid and may fail without warning. The user must determine the product life under such circumstances by testing. Also see section 2.5.

See section 1.2.

4.6 Hose Inspection and Failure: Hydraulic power is accomplished by utilizing high pressure fluids to transfer energy and do work. Hoses, Fittings and Hose Assemblies all contribute to this by transmitting fluids at high pressures. Fluids under pressure can be dangerous and potentially lethal and, therefore, extreme caution must be exercised when working with fluids under pressure and handling the Hoses transporting the fluids. From time to time, Hose Assemblies will fail if they are not replaced at proper time intervals. Usually these failures are the result of some form of misapplication, abuse, wear or failure to perform proper maintenance. When Hoses fail, generally the high pressure fluids inside escape in a stream which may or may not be visible to the user. Under no circumstances should the user attempt to locate the leak by "feeling" with their hands or any other part of their body. High pressure fluids can and will penetrate the skin and cause severe tissue damage and possibly loss of limb. Even seemingly minor hydraulic fluid injection injuries must be treated immediately by a physician with knowledge of the tissue damaging properties of hydraulic fluid.

If a Hose failure occurs, immediately shut down the equipment and leave the area until pressure has been completely released from the Hose Assembly. Simply

# Safety Guide & MSDS Statement

shutting down the hydraulic pump may or may not eliminate the pressure in the Hose Assembly. Many times check valves, etc., are employed in a system and can cause pressure to remain in a Hose Assembly even when pumps or equipment are not operating. Tiny holes in the Hose, commonly known as pinholes, can eject small, dangerously powerful but hard to see streams of hydraulic fluid. It may take several minutes or even hours for the pressure to be relieved so that the Hose Assembly may be examined safely.

Once the pressure has been reduced to zero, the Hose Assembly may be taken off the equipment and examined. It must always be replaced if a failure has occurred. Never attempt to patch or repair a Hose Assembly that has failed. Consult the nearest Parker distributor or the appropriate Parker division for Hose Assembly replacement information.

Never touch or examine a failed Hose Assembly unless it is obvious that the Hose no longer contains fluid under pressure. The high pressure fluid is extremely dangerous and can cause serious and potentially fatal injury.

4.7 Elastomeric seals: Elastomeric seals will eventually age, harden, wear and deteriorate under thermal cycling and compression set. Elastomeric seals should be inspected and replaced.

4.8 Refrigerant gases: Special care should be taken when working with refrigeration systems. Sudden escape of refrigerant gases can cause blindness if the escaping gases contact the eye and can cause freezing or other severe injuries if it contacts any other portion of the body.

4.9 Compressed natural gas (CNG): Parker CNG Hose Assemblies should be tested after installation and before use, and at least on a monthly basis per ANSI/IAS NGV 4.2-1999; CSA 12.52-M99 Section 4.2 "Visual Inspection Hose/Fitting". The recommended procedure is to pressurize the Hose and check for leaks and to visually inspect the Hose for damage.

Caution: Matches, candles, open flame or other sources of ignition shall not be used for Hose inspection. Leak check solutions should be rinsed off after use.

## 5.0 HOSE STORAGE

5.1 Age Control: Hose and Hose Assemblies must be stored in a manner that facilitates age control and first-in and first-out usage based on manufacturing date of the Hose and Hose Assemblies. The shelf life of rubber Hose or Hose Assemblies that have passed visual inspection and a proof test is 10 years (40 quarters) from the date of manufacture. The shelf life of thermoplastic and poly-tetrafluoroethylene Hose or Hose Assemblies is considered to be unlimited.

5.2 Storage: Stored Hose and Hose Assemblies must not be subjected to damage that could reduce their expected service life and must be placed in a cool, dark and dry area with the ends capped. Stored Hose and Hose Assemblies must not be exposed to temperature extremes, ozone, oils, corrosive liquids or fumes, solvents, high humidity, rodents, insects, ultraviolet light, electromagnetic fields or radioactive materials.

Hose  
**A**

Fittings  
**B**

Equipment  
**C**

Accessories  
**D**

Technical  
**E**

### MSDS (Available upon request.)

Federal OSHA regulation 29 CFR 1910.1200 requires that we transmit to our customers Material Safety Data Sheets for all material covered under the law. If you are an employer in SIC 20-39 who has not yet received them, you are required to obtain them from us and provide the information to employees as directed in Section (b) of the regulation. Please contact the Hose Products Division - Technical Services Department: (PH) 440-943-5700 (FAX) 440-943-3129.



## Offer of Sale

The items described in this document and other documents or descriptions provided by Parker Hannifin Corporation, as subsidiaries and its authorized distributors are hereby offered for sale at prices to be established by Parker Hannifin Corporation, its subsidiaries and its authorized distributors. This offer and its acceptance by any customer ("Buyer") shall be governed by all of the following Terms and Conditions. Buyer's order for any such item, when communicated to Parker Hannifin Corporation, its subsidiary or an authorized distributor ("Seller") verbally or in writing, shall constitute acceptance of this offer.

1. Terms and Conditions of Sale: All descriptions, quotations, proposals, offers, acknowledgments, acceptances and sales of Seller's products are subject to and shall be governed exclusively by the terms and conditions stated herein. Buyer's acceptance of any offer to sell is limited to these terms and conditions. Any terms or conditions in addition to, or inconsistent with those stated herein, proposed by Buyer in any acceptance of an offer by Seller, are hereby objected to. No such additional, different or inconsistent terms and conditions shall become part of the contract between Buyer and Seller unless expressly accepted in writing by Seller. Seller's acceptance of any offer to purchase by Buyer is expressly conditional upon Buyer's assent to all the terms and conditions stated herein, including any terms in addition to, or inconsistent with those contained in Buyer's offer. Acceptance of Seller's products shall in all events constitute such assent.
2. Payment: Payment shall be made by Buyer net 30 days from the date of delivery of the items purchased hereunder. Any claims by Buyer for omissions or shortages in a shipment shall be waived unless Seller receives notice thereof within 30 days after Buyer's receipt of the shipment.
3. Delivery: Unless otherwise provided on the face hereof, delivery shall be made F.O.B. Seller's plant. Regardless of the method of delivery, however, risk of loss shall pass to Buyer upon Seller's delivery to a carrier. Any delivery dates shown are approximate only and Seller shall have no liability for any delays in delivery.
4. Warranty: Seller warrants that the items sold thereunder shall be free from defects in material or workmanship for a period of 365 days from the date of shipment to Buyer, or 2,000 hours of use, whichever expires first. THIS WARRANTY COMPRISES THE SOLE AND ENTIRE WARRANTY PERTAINING TO ITEMS PROVIDED HEREUNDER. SELLER MAKES NO OTHER WARRANTY, GAURANTEE, OR REPRESENTATION OF ANY KIND WHATSOEVER. ALL OTHER WARRANTIES, INCLUDING BUT NOT LIMITED TO, MERCHANTABILITY AND FITNESS FOR PURPOSE, WHETHER EXPRESS, IMPLIED, OR ARISING BY OPERATION OF LAW, TRADE USAGE, OR COURSE OF DEALING ARE HEREBY DISCLAIMED. NOTWITHSTANDING THE FOREGOING, THERE ARE NO WARRANTIES WHATSOEVER ON ITEMS BUILT OR ACQUIRED WHOLELY OR PARTIALLY, TO BUYER'S DESIGNS OR SPECIFICATIONS.
5. Limitation Of Remedy: SELLER'S LIABILITY ARISING FROM OR IN ANY WAY CONNECTED WITH THE ITEMS SOLD OR THIS CONTRACT SHALL BE LIMITED EXCLUSIVELY TO REPAIR OR REPLACEMENT OF THE ITEMS SOLD OR REFUND OF THE PURCHASE PRICE PAID BY BUYER, AT SELLER'S SOLE OPTION. IN NO EVENT SHALL SELLER BE LIABLE FOR ANY INCIDENTAL, CONSEQUENTIAL OR SPECIAL DAMAGES OF ANY KIND OR NATURE WHATSOEVER, INCLUDING BUT NOT LIMITED TO LOST PROFITS ARISING FROM OR IN ANY WAY CONNECTED WITH THIS AGREEMENT OR ITEMS SOLD HEREUNDER, WHETHER ALLEGED TO ARISE FROM BREACH OF CONTRACT, EXPRESS OR IMPLIED WARRANTY, OR IN TORT, INCLUDING WITHOUT LIMITATION, NEGLIGENCE, FAILURE TO WARN OR STRICT LIABILITY.
6. Changes, Reschedules and Cancellations: Buyer may request to modify the designs or specifications for the items sold herunder as well as the quantities and delivery dates thereof, or may request to cancel all or part of this order, however, no such requested modification or cancellation shall become part of the contract between Buyer and Seller unless accepted by Seller in a written amendment to this Agreement. Acceptance of any such requested modification or cancellation shall be at Seller's discretion, and shall be upon such terms and conditions as Seller may require.
7. Special Tooling: A tooling charge may be imposed for any special tooling, including without limitation, dies, fixtures, molds and patterns, acquired to manufacture items sold pursuant to this contract. Such special tooling shall be and remain Seller's property notwithstanding payment of any charges by Buyer. In no event will Buyer acquire any interest in apparatus belonging to Seller which is utilized in the manufacture of the items sold hereunder, even if such apparatus has been specially converted or adapted for such manufacture and notwithstanding any charges paid by Buyer. Unless otherwise agreed, Seller shall have the right to alter, discard or otherwise dispose of any special tooling or other property in its sole discretion at any time.
8. Buyer's Property: Any designs, tools, patterns, materials, drawings, confidential information or equipment furnished by Buyer or any other items which become Buyer's property, may be considered obsolete and may be destroyed by Seller after two (2) consecutive years have elapsed without Buyer placing an order for the items which are manufactured using such property. Seller shall not be responsible for any loss or damage to such property while it is in Seller's possession or control.
9. Taxes: Unless otherwise indicated on the face hereof, all prices and charges are exclusive of excise, sales, use, property, occupational or like taxes which may be imposed by any taxing authority upon the manufacture, sale or delivery of the items sold hereunder. If any such taxes must be paid by Seller of if Seller is liable for the collection of such tax, the amount thereof shall be in addition to the amounts for the items sold. Buyer agrees to pay all such taxes or to reimburse Seller therefore upon receipt of its invoice. If Buyer claims exemption from any sales, use or other tax imposed by any taxing authority, Buyer shall save Seller harmless from and against any such tax, together with any interest or penalties thereon which may be assessed if the items are held to be taxable.
10. Indemnity For Infringement of Intellectual Property Rights: Seller shall have no liability for infringement of any patents, trademarks, copyrights, trade dress, trade secrets or similar rights except as provided in this Part 10. Seller will defend and indemnify Buyer against allegations of infringement of U.S. patents, U.S. trademarks, copyrights, trade dress and trade secrets (hereinafter "Intellectual Property Rights"). Seller will defend at its expense and will pay the cost of any settlement or damages awarded in an action brought against Buyer based on an allegation that an item sold pursuant to this contract infringes in the Intellectual Property Rights of a third party. Seller's obligation to defend and indemnify Buyer is contingent on Buyer notifying Seller within ten (10) days after Buyer becomes aware of such allegations of infringement, and Seller having sole control over the defense of any allegations or actions including all negotiations for settlement or compromise. If an item sold hereunder is subject to a claim that it infringes the Intellectual Property Rights of a third party, Seller may, at its sole expense and options, procure for Buyer the right to continue using said item, replace or modify said item so as to make it noninfringing, or offer to accept return of said item and return the purchase price less a reasonable allowance for depreciation. Notwithstanding the foregoing, Seller shall have no liability for claims of infringement based on information provided by Buyer, or directed to items delivered hereunder for which the designs are specified in whole or part by Buyer, or infringements resulting from the modification, combination or use in a system of any item sold hereunder. The foregoing provisions of this Part 10 shall constitute Seller's sole and exclusive liability and Buyer's sole and exclusive remedy for infringement of Intellectual Property Rights. If a claim is based on information provided by Buyer or if the design for an item delivered hereunder is specified in whole or in part by Buyer, Buyer shall defend and indemnify Seller for all costs, expenses or judgments resulting from any claim that such item infringes any patent, trademark, copyright, trade dress, trade secret or any similiar right.
11. Force Majeure: Seller does not assume the risk of and shall not be liable for delay or failure to perform any of Seller's obligations by reason of circumstances beyond the reasonable control of Seller (hereinafter "Events of Force Majeure"). Events of Force Majeure shall include without limitation, accidents, acts of God, strikes or labor disputes, acts, laws, rules or regulations of any government or government agency, fires, floods, delays or failures in delivery of carriers or suppliers, shortages of materials and any other cause beyond Seller's control.
12. Entire Agreement/Governing Law: The terms and conditions set forth herein, together with any amendments, modifications and any different terms or conditions expressly accepted by Seller in writing, shall constitute the entire Agreement concerning the items sold, and there are no oral or other representations or agreements which pertain thereto. This Agreement shall be governed in all respects by the law of the State of Ohio. No actions arising out of the sale of the items sold hereunder or this Agreement may be brought by either party more than two (2) years after the cause of action accrues.

A Hose

B Fittings

C Equipment

D Accessories

E Technical

Hose

**A**

Fittings

**B**

Equipment

**C**

Accessories

**D**

Technical

**E**



Hose  
**A**

Fittings  
**B**

Equipment  
**C**

Accessories  
**D**

Technical  
**E**

## Aerospace

### Key Markets

- Commercial transports
- Military aircraft
- Regional transports
- Aircraft engines
- Business and general aviation

### Key Products

- Flight control systems and components
- Hydraulic systems and components
- Fuel systems and components
- Pneumatic systems and components
- Inert oxygen generating systems
- Fluid metering, delivery and atomization devices
- Wheels and brakes
- Couplings, fittings, hoses and tubes



## Automation

### Key Markets

- Factory automation
- Transportation and automotive
- Life sciences and medical
- Machine tools
- Semiconductor and electronics

### Key Products

- Pneumatic motion and control
- Air preparation
- Vacuum controls and sensors
- Electromechanical stepper and servo motors, drives, and controls
- Human machine interface
- Electric actuators, gantry robots, slides and linear motors
- Structural extrusion



## Climate & Industrial Controls

### Key Markets

- Refrigeration and air conditioning
- Transportation/mobile
- Process
- Industrial machinery
- Medical/life sciences
- Fuel cells
- Precision cooling

### Key Products

- Pressure regulators
- Check, ball and service valves
- Value-added systems
- Thermostatic and expansion valves
- Electronic controllers
- Contaminant controls
- Heating/air conditioning hose
- Gerotors



## Filtration

### Key Markets

- Industrial machinery
- Process
- Mobile
- Marine
- Oil & gas
- Power generation and energy
- Transportation
- Food and beverage

### Key Products

- Hydraulic, lubrication and coolant filters
- Process, chemical, water and microfiltration filters
- Compressed air and gas purification filters
- Condition monitoring
- Analytical gas generators
- Nitrogen, hydrogen and zero air generators
- Engine air, fuel, oil filtration and systems



## Fluid Connectors

### Key Markets

- Construction machinery
- Agriculture
- Transportation
- Mobile
- Industrial machinery
- Oil & gas

### Key Products

- Rubber and thermoplastic hose
- Industrial hose
- Tube fittings and adaptors
- Tubing and plastic fittings
- Brass fittings and valves
- Hose couplings
- Quick disconnects



## Hydraulics

### Key Markets

- Construction machinery
- Agriculture
- Industrial machinery
- Oil & gas
- Truck hydraulics
- Power generation and energy

### Key Products

- Hydraulic cylinders and accumulators
- Hydraulic valves and controls
- Hydraulic motors and pumps
- Power take-offs
- Hydraulic systems



## Instrumentation

### Key Markets

- Power generation
- Oil & gas
- Petrochemical
- Microelectronics
- Biopharmaceutical

### Key Products

- Medium/high pressure fittings and valves
- Instrumentation fittings, valves, manifolds and regulators
- High purity fittings, valves and regulators
- Fluoropolymer fittings, valves, pumps and regulators
- Analytical systems



## Seal

### Key Markets

- Transportation
- Energy, oil & gas
- Semiconductor
- Aerospace
- Fluid power
- Life sciences
- Telecommunications

### Key Products

- Elastomeric O-rings
- Homogeneous and inserted elastomeric shapes and diaphragms
- Metal and plastic retained composite seals
- Polymeric and plastic dynamic seals
- Rubber and plastic boots/bellows
- Extruded and precision-cut/fabricated elastomeric seals
- Thermoplastic engineered seals





# Parker Fluid Connectors Regional Sales Offices & Service Centers

**Your complete source** for quality tube fittings, hose & hose fittings, brass fittings & valves, quick-disconnect couplings, and assembly tools, locally available from a worldwide network of authorized distributors.

### **Fittings:**

Available in inch and metric sizes covering SAE, BSP, DIN, GAZ, JIS and ISO thread configurations, manufactured from steel, stainless steel, brass, aluminum, nylon and thermoplastic.

### **Hose, Tubing and Bundles:**

Available in a wide variety of sizes and materials including rubber, wire-reinforced, thermoplastic, hybrid and custom compounds.

### **Worldwide Availability:**

Parker operates Fluid Connectors manufacturing locations and sales offices throughout North America, South America, Europe and Asia-Pacific.

**For information**, contact the nearest Regional Sales office listed, or call toll free...

**1-800-C-PARKER  
(1-800-272-7537)**

### **Central Region Sales Office & Service Center**

Hiawatha, IA  
phone 319 393 1221  
fax 319 393 1224

### **Cleveland Region Sales Office**

Cleveland, OH  
phone 216 896 2404  
fax 216 896 4022

### **Service Center**

Toledo, OH  
phone 419 878 7000  
fax 419 878 7001  
fax 419 878 7420  
(FCG Kit Operations)

### **Service Center**

Louisville, KY  
phone 502 937 1322  
fax 502 937 4180

### **Great Lakes Region Sales Office**

Otsego, MI  
phone 269 694 2550  
fax 866 498 7507

### **Minneapolis Region Sales Office**

Minneapolis, MN  
phone 763 513 3535  
fax 763 544 3418

### **Service Center**

Minneapolis, MN  
phone 952 469 5000  
fax 952 469 5729

### **Northeast Region Sales Office & Service Center**

Trenton, NJ  
phone 609 586 5151  
fax 609 586 6081

### **Pacific Region Sales Office & Service Center**

Portland, OR  
phone 503 283 1020  
fax 503 283 2201

### **Service Center**

Buena Park, CA  
phone 714 522 8840  
fax 714 994 1183

### **Southeast Region Service Center**

Conyers, GA  
phone 770 929 0330  
fax 770 929 0230

### **Southwest Region Sales Office**

Mansfield, TX  
phone 817 473 4431  
fax 817 453 8022

### **Canada Sales Office & Service Center**

Grimsby, ONT  
phone 905 945 2274  
fax 905 945 3946

**(Contact Grimsby for other  
Service Center locations.)**



### **Parker Hannifin Corporation**

Hose Products Division  
30240 Lakeland Blvd.  
Wickliffe, Ohio 44092  
Phone: (440) 943-5700  
Fax: (440) 943-3129  
www.parkerhose.com

## ***Introductory Section Index***

<b>Selecting the Right Hose</b>	<b>2</b>
<b>Hose Overview Chart</b>	<b>6</b>
<b>How to Select Hose and Fittings</b>	<b>7</b>
<b>Hose Specifics</b>	<b>8</b>
<b>Fittings Information</b>	<b>12</b>
<b>Parkrimp Crimpers</b>	<b>14</b>
<b>The Benefits of Parker Hose</b>	<b>18</b>
<b>The Parker Fluid Connectors Group</b>	<b>20</b>

