

SECTION 5

EXHAUST AFTERTREATMENT SYSTEM	3
FILTRATION AND REGENERATION UNIT	3
PASSIVE REGENERATION	3
ACTIVE REGENERATION	3
STATIONARY (PARKED) REGENERATION	3
DEF CLOGGING SEQUENCE – INSTRUMENT CLUSTER TELLTALE LIGHT	4
SELECTIVE CATALYTIC REDUCTION UNIT	5
DRIVER WARNING AND INDUCEMENT MEASURES	7
DRIVER INFORMATION DISPLAY (DID) MENUS	11
GAUGES	12
FUEL DATA	13
TIME/DISTANCE	14
VEHICLE MESSAGES	15
RESET TRIP DATA	15
DISPLAY SETTINGS	15
DIAGNOSTICS MENU	18
PRE-TRIP ASSISTANCE (OPTION)	19
DATA LOG	21
AFTERTREATMENT	22
PASSWORD	23
PREVOST LIAISON (OPTION)	23
INTELLIGENT SLEEP MODE (ISM)	25
TRANSMISSION RETARDER	25
ENGINE BRAKE	25
VOLVO ENGINE BRAKE (VEB)	26
CRUISE CONTROL AND ENGINE BRAKE	26
ABS, TRACTION CONTROL SYSTEM (TCS) & ELECTRONIC STABILITY CONTROL (ESC)	27
ANTILOCK BRAKING SYSTEM (ABS)	27
TRACTION CONTROL SYSTEM (TCS)	27
ELECTRONIC STABILITY CONTROL (ESC)	27
DRIVER CONTROLLED DIFFERENTIAL LOCK (DCDL)	28
OPERATION TIPS	28
LOCKING THE DCDL	29
UNLOCKING THE DCDL	29
RETRACTABLE TAG AXLE	29
VARIABLE ASSISTANCE STEERING GEAR (OPTIONAL)	29
KEYLESS ENTRY SYSTEM	29
KEYLESS OPERATING INSTRUCTIONS	30
PROGRAMMING AND MANAGING PERSONAL CODES	30

5-2 Other Features

REMOTE ENTRY TRANSMITTER	31
PROGRAMMING TRANSMITTERS	32
SLIDE-OUT OPERATION	32
SAFETY PRECAUTIONS	32
FRONT AND REAR SLIDE-OUT OPERATION	32
SLIDE-OUT MANUAL OVERRIDE PROCEDURE	33
MOBILE FLOOR HAND CRANK PROCEDURE	37
SLIDE-OUT TROUBLESHOOTING	37
SLIDE-OUT TROUBLESHOOTING TABLE	39

EXHAUST AFTERTREATMENT SYSTEM

The exhaust aftertreatment system consists of two units, the filtration and regeneration unit and the selective catalytic reduction SCR unit.

FILTRATION AND REGENERATION UNIT

The main purpose of the filtration and regeneration unit is to capture and oxidize (regenerate) the particulate matter (soot) in the engine exhaust gas. The exhaust gas first enters the Diesel Oxidation Catalyst (DOC) and then flow through the Diesel Particulate Filter (DPF); together they capture and regenerate the soot on a regular or passive basis. Through constant monitoring of the exhaust gas temperature and the system back pressure, the engine control module is able to manage regeneration.

PASSIVE REGENERATION

Passive regeneration is the process by which the particulate matter is oxidized due to the heat generated by the engine internal combustion process. During normal highway operation, exhaust temperatures alone are usually high enough to oxidize accumulating soot. In low ambient temperatures, however, or in some stop-and-go applications, the system needs a little help to regenerate, or clean itself. This process is called “active” regeneration.

ACTIVE REGENERATION

Active regeneration is necessary when the engine internal combustion process alone does not generate enough heat. A dosing system injects a mist of diesel fuel into the exhaust system to increase and maintain the aftertreatment system temperature. Exhaust temperature must be above 572°F (300°C) to initiate the oxidation catalyst, which in turn oxidizes the injected diesel fuel molecules to achieve up to 1200°F (650°C) exhaust temperature at the particulate filter. This process of active regeneration takes place during the normal operation cycle of the vehicle without charges in performance or control for the operator. EPA2010 compliant and later Volvo engines produce less soot, so less active or stationary regeneration will be required.







STATIONARY (PARKED) REGENERATION

In a small number of specific engine duty cycles, engine control module may not be capable of completing an active regeneration. In these situations, the operator will be notified that a stationary or parked regeneration may be required. A DPF telltale light will illuminate indicating the need for user interaction. The lamp gives the operator a grace period to allow this process to take place at a time when most convenient for the operator. This process requires the vehicle to be parked while a driver or maintenance technician initiates the regeneration process using the DID menus. Once initiated, the stationary regeneration process will be complete in about 45 minutes.

The driver will be notified of the need for a stationary regeneration (parked) by illumination of the DPF Regeneration telltale light.

5-4 Other Features

DEF CLOGGING SEQUENCE – INSTRUMENT CLUSTER TELLTALE LIGHT

LEVEL 1	 solid	<p>REGENERATION NEEDED</p> <p>Diesel particulate filter is becoming full</p> <p>The DPF Regeneration telltale light illuminates to notify the driver that a stationary regeneration (parked) will be required soon. When this lamp is lit, initiate stationary regeneration process at an appropriate time of day. THERE IS NO URGENCY AT THIS LEVEL.</p>
LEVEL 2	 flashing	<p>REGENERATION REQUIRED</p> <p>Diesel particulate filter full</p> <p>If no DPF regeneration occurs after the initial DPF Regeneration telltale light illumination, the lamp will begin blinking and a stationary regeneration should be initiated as soon as possible in order to prevent from entering into Level 3.</p>
LEVEL 3	 flashing + 	<p>ATD SERVICE REQUIRED</p> <p>ENGINE DERATE ACTIVE</p> <p>Diesel particulate filter overfull</p> <p>If the flashing DPF Regeneration telltale light is still ignored, the CHECK telltale light will illuminate. In that situation, engine performance is limited. Perform a parked regeneration IMMEDIATELY to avoid further derate and prevent from entering into Level 4.</p>
LEVEL 4	 flashing +  + 	<p>ATD SERVICE REQUIRED</p> <p>ENGINE SHUTDOWN ACTIVE</p> <p>A serious engine problem has occurred. The DPF may be over its maximum capacity.</p> <p>If a stationary regeneration is still not initiated, a standard Engine Protection Shutdown sequence will occur. All of the following dashboard lamps will be present:</p> <ul style="list-style-type: none"> • Blinking DPF Regeneration telltale light; • Solid CHECK telltale light; • Solid STOP telltale light. <p>Once engine derate and/or shutdown sequence is completed, a stationary regeneration must occur to continue vehicle operation. If the driver continues to operate the vehicle without regeneration, additional measures will be taken to protect the engine and ATD from damage, up to and including engine shutdown. Parked regeneration might no longer be possible.</p> <hr/> <p>If engine protection has been initiated and forces the engine to shutdown, you can immediately RE-START the engine and perform the necessary steps in order to initiate a stationary regeneration.</p> <p style="text-align: center;"><u>Find and solve the cause of the shutdown</u></p>

Initiating A Stationary (Parked) Regeneration

NOTE

At starting of the engine, if a stationary regeneration is required, the engine coolant temperature must reach 140°F (60°C) before any stationary regeneration may be initiated and completed. Permit the engine to idle for a short while or drive the vehicle until engine temperature increases sufficiently.



WARNING

Do not initiate a stationary regeneration in a closed area like a garage. Stationary regenerations must be undertaken outdoors only.



WARNING

During stationary regeneration, exhaust temperature may reach up to 1200°F (650°C) at the particulate filter. Before initiating stationary regeneration, make sure that the DPF outlet diffuser is clear of objects and that no one is working near the DPF outlet diffuser.



WARNING

Hot surfaces. Keep yourself clear of all hot Aftertreatment Device components, particularly during and after active or stationary regeneration. Hot surfaces can cause serious burns.

NOTE

STATIONARY REGENERATION

This process requires the vehicle to be parked while the driver or a maintenance technician initiates the regeneration process.

The DPF Regeneration telltale light illuminates to notify the driver of the need and urgency of a manual stationary regeneration.



DPF REGENERATION telltale light

If stationary regeneration is not performed, this telltale light will blink, indicating that a stationary regeneration is required immediately. If stationary regeneration is still not performed, “engine power derate and shutdown” sequence may occur as per level 1 to level 4 sequence.

To initiate a stationary regeneration:

- Park the vehicle in a clear area, vehicle speed must be 0 mph (0 km/h);
- Engine must be on normal idle and fully warmed up (coolant temperature above 140°F/60°C);
- Apply parking brakes and set the transmission to neutral (N).
- Press the DID ENTER button and then get to the DID Aftertreatment menu. Select sub-menu Request Parked REGEN and press ENTER button to confirm and initiate regeneration.

The regeneration will begin. Turn off the air conditioning to reduce engine load. The engine idling speed will increase to 1600 rpm. Once the regeneration is completed, the engine speed will return to normal idle.

Voluntary Interruption Of A Stationary Regeneration

It is possible to interrupt a stationary regeneration at all time. To do so, get to the DID’s Aftertreatment menu, select Cancel REGEN and press ENTER button to confirm. You can stop regeneration simply by releasing the parking brake. Use this procedure in order to move the vehicle in a safe area only.

If regeneration is interrupted, it is very important to reinitiate the regeneration as soon as possible.



CAUTION

If an active regeneration is stopped repeatedly, the vehicle may need to be taken to a service facility. The service facility will use a service tool to manually initiate the regeneration. Moreover, the interruption of active regeneration should not be considered as a normal practice. Some components of the aftertreatment system might be damaged in the long term.

SELECTIVE CATALYTIC REDUCTION UNIT

Selective Catalytic Reduction (SCR) is a technology that uses Diesel Exhaust Fluid (DEF) and a catalytic converter to reduce nitrogen oxides (NOx) emissions.

SCR is an exhaust aftertreatment system that injects small amount of DEF into the exhaust gas between the DPF and the selective reduction catalytic converter. DEF turns to ammonia and carbon dioxide when heated. The exhaust stream

5-6 Other Features

then passes over a catalyst, the ammonia reacts with the NOx to form nitrogen and water vapor.

The basic elements of the SCR system consist of a 15.9 gallons (60 liters) DEF tank complete with pump, lines and heating system, a dosing injector, a catalytic converter and the control and monitoring system.

Diesel Exhaust Fluid (DEF)

When handling DEF solution, keep electrical connectors properly connected or well capped, otherwise there is a risk that the DEF will cause oxidation that cannot be removed. Water or compressed air will not help, since DEF quickly oxidizes certain metals. If a disconnected connector comes into contact with the DEF solution, it must be replaced immediately to prevent the DEF solution from creeping further into the copper wiring, which takes place at a speed of about 2.4 in (60 mm) per hour.



CAUTION

Diesel Exhaust Fluid (DEF) is a nontoxic aqueous solution of urea (32.5%) and ultra-pure water (67.5%). Urea is a compound of nitrogen that turns to ammonia when heated. The fluid is non flammable, and is not dangerous when handled as recommended. However, it is highly corrosive to certain metals, especially copper and brass.

When detaching hoses and components, do not spill DEF on disconnected or unsealed connectors. If DEF is spilled on a disconnected or unsealed connector, the connector must be removed immediately and replaced.

Things to know about spilt diesel exhaust fluid (DEF):

- If urea solution comes into contact with the skin, rinse with plenty of water and remove contaminated clothing.
- If urea solution comes into contact with the eyes rinse for several minutes and call for medical help if necessary.
- If inhaled breathe fresh air and call for medical help if necessary.
- Do not allow the DEF solution to come into contact with other chemicals.
- The DEF solution is not flammable. If the DEF solution is exposed to high temperatures, it breaks down into ammonia and carbon dioxide.
- The DEF solution is highly corrosive to certain metals, including copper and aluminum.
- If the DEF solution is spilled onto the vehicle, wipe off the excess and rinse with water. Spilled DEF solution can form concentrated white crystals on the vehicle. Rinse off these crystals with water.



CAUTION

DEF freezing and expansion

DEF will begin to crystallize and freeze at 12°F (-11°C). DEF expands by approximately 7% when frozen. During freezing weather, do not store a DEF container on the coach unless it is designed to allow for expansion.

Make sure the DEF container is not completely full. DEF expansion may split an inappropriate container, causing a spill and corrosion as a result.



WARNING

DEF spilt onto hot components will quickly vaporize. Turn your face away!

Diesel Exhaust Fluid Consumption

DEF consumption is related to fuel consumption. In order to meet EPA requirements, DEF tanks are sized so one refill will be necessary every two refills of the fuel tank.

DRIVER WARNING AND INDUCEMENT MEASURES

Auxiliary Emission Control Device (EACD) defines as any element of design which senses temperature, vehicle speed, engine RPM, transmission gear, manifold vacuum, or any other parameter for the purpose of activating, modulating, delaying, or deactivating the operation of any part of the emission control system.









Disconnection of the following EACD produces immediate activation of the Malfunction Indicator Lamp MIL and **25% engine derate** after three (3) hours of a continuous open circuit condition.









- Intake throttle position sensor
- Ambient air temperature sensor
- Vehicle speed
- Engine oil pressure sensor
- Exhaust back pressure sensor
- Camshaft speed sensor
- EGR delta pressure
- Fuel rail pressure
- Engine timing sensor
- Engine coolant temperature
- EGR temperature sensor

Exhaust Aftertreatment System (EATS) components must not be removed, altered or modified in any way. In order to protect the emission control system from tampering, inducement measures will occur if the following states are detected:









- Disconnection of DEF tank level sensor
- Blocked DEF line or dosing valve
- Disconnection of DEF dosing valve
- Disconnection of DEF pump
- Disconnection of SCR wiring harness
- Disconnection of NOx sensor
- Disconnected exhaust temperature sensor
- Disconnected DEF temperature sensor
- Disconnected DEF quality sensor

5-8 Other Features

DEF TANK LEVEL - DRIVER WARNING AND INDUCEMENT				
Conditions / Triggers		DEF Tank LOW LEVEL Indicator, DID Message and audible warning		Inducement
1	<p>Normal</p> <p>DEF tank level sensor reads between 100% and 12%</p>	None		None
2	<p>Low DEF tank warning</p> <p>DEF tank level sensor reads between 12% and 0.1%</p> 	 solid	<p>DEF TANK LEVEL LOW</p> <p>REFILL DEF SOON TO PREVENT ENGINE DERATE</p> <p>🔊 3 beeps</p>	Warning message
3	<p>DEF tank near empty</p> <p>DEF tank level sensor reads less than 0.1%</p> 	 blinking	<p>DEF TANK EMPTY</p> <p>REFILL DEF TO AVOID 5 MPH LIMIT</p> <p>ENGINE IN DERATE</p> <p>🔊 3 beeps</p>	Engine torque reduction of 25%
4	<p>DEF tank empty and one (1) hour of operation in engine derate mode</p> 	 blinking	<p>DEF TANK EMPTY</p> <p>REFILL DEF TO AVOID 5 MPH LIMIT</p> <p>ENGINE IN DERATE</p> <p>🔊 3 beeps</p>	Engine torque reduction of 40%
5	<p>DEF tank empty and either</p> <ol style="list-style-type: none"> 1. Diesel fuel refueling done with a fuel level sensor reading increase of 15%, or more 2. Vehicle stationary (speed=0) for 20 minutes with engine off or at idle 	 blinking	<p>REFILL DEF TANK</p> <p>VEHICLE SPEED LIMITED TO 5 MPH (8 KM/H)</p> <p>🔊 constant tone</p>	<p>Vehicle road speed limited (RSL) to 5 mph (8 km/h)</p> <p>Note: The vehicle has to be stationary before 5 mph (8 km/h) road speed limit becomes active</p>

DEF QUALITY - DRIVER WARNING AND INDUCEMENT				
Conditions / Triggers		Amber Warning Light & Did Message And Audible Warning		Inducement
1	Good DEF quality	None		None
2	Poor DEF quality detected	 solid	POOR DEF QUALITY DETECTED SERVICE DEF SYSTEM AT NEXT STOP  3 cycles of 2 beeps	Warning message Engine will derate 25% in < 60 mins
3	Poor DEF quality detected and one (1) hour of operation with active diagnostic troubleshooting code	 solid	POOR DEF QUALITY DETECTED ENGINE IN DERATE 5 MPH (8KM/H) LIMIT IN < XXX MINS  3 cycles of 2 beeps	Engine derated 25% Engine will derate 40% in <240 mins
4	Poor DEF quality detected and four (4) hours of operation with active diagnostic troubleshooting code	 solid	SERVICE DEF 5 MPH (8KM/H) LIMIT NEXT 20MIN VEHICLE STOP  3 cycles of 2 beeps	Engine derated 40% 5 mph (8 km/h) limit after next 20 min vehicle stop
5	Poor DEF quality detected Diesel fuel refueling done with a fuel level sensor increase of 15% or more or Vehicle stationary (speed=0) for 20 minutes with engine off or at idle or Key cycle trigger	 solid	SERVICE DEF VEHICLE SPEED LIMITED TO 5 MPH (8 KM/H)  continuous cycle of 2 beeps	Service DEF Vehicle road speed limited (RSL) to 5 mph (8 km/h) Note: The vehicle has to be stationary before 5 mph (8 km/h) road speed limit becomes active

5-10 Other Features

SCR SYSTEM TAMPERING - DRIVER WARNING AND INDUCEMENT				
Conditions / Triggers		Amber Warning Light, Did Message And Audible Warning		Inducement
1	Normal No diagnostic troubleshooting code active	None		None
2	SCR system tampering diagnostic troubleshooting code confirmed	 solid	SCR SYSTEM FAULT ENGINE WILL DERATE IN < XXX MINS  constant tone	Warning message
3	Reached one (1) hour of operation with active SCR system tampering diagnostic troubleshooting code confirmed	 solid	SCR SYSTEM FAULT ENGINE IN DERATE 5 MPH (8KM/H) LIMIT IN < XXX MINS  constant tone	Engine torque reduction of 25%
4	Reached four (4) hours of operation with active SCR system tampering diagnostic troubleshooting code confirmed	 solid	SCR SYSTEM FAULT REPAIR NEEDED 5 MPH (8KM/H) LIMIT NEXT VEHICLE STOP  constant tone	Engine torque reduction of 40%
5	Diesel fuel refueling done with a fuel level sensor increase of 15% or more	 solid	SCR SYSTEM FAULT VEHICLE SPEED LIMITED TO 5 MPH (8 KM/H)  constant tone	Vehicle road speed limited (RSL) to 5 mph (8 km/h)

DRIVER INFORMATION DISPLAY (DID) MENUS

There are Driving and Non-Driving menus. Several sub-menus are password-protected while the vehicle is parked. The Non-Driving menu is accessible only when the vehicle is parked.

DRIVING MODE MENUS	NON-DRIVING / STATIONARY MODE MENUS
<u>GAUGES</u> <ol style="list-style-type: none"> 1. Current Gear Position (I-Shift) 2. Outside Temperature 3. Engine Oil Temperature 4. Transmission Fluid Temperature 5. Prevost Liaison Compass 6. Accessories Air Pressure 7. Battery Voltage 8. A/C Compressor Pressure 9. Allison Transmission Oil Life 10. Battery State Of Charge 11. Electric Cooling Fan Status 	<u>DISPLAY SETTINGS</u> <ol style="list-style-type: none"> 1. Language 2. Units 3. Time/Date 4. Favorite Display Setting 5. Display Light 6. Change Password
<u>FUEL DATA</u> <ol style="list-style-type: none"> 1. Fuel Flow 2. Fuel Flow / ECO % 3. Trip Fuel Used 4. Distance to Empty 	<u>DIAGNOSTICS MENU</u> <ol style="list-style-type: none"> 1. View Active Faults 2. View Inactive Faults 3. Cluster Self-Test 4. Part Number 5. Reset Inactive Faults 6. Vehicle Tests
<u>TIME/DISTANCE</u> <ol style="list-style-type: none"> 1. Time and Date 2. Alarm Clock 3. Trip Odometer 1 and 2 4. Average Trip Speed 5. Estimated Time of Arrival (ETA) 	<u>PRE-TRIP ASSISTANCE (OPTION)</u> <ol style="list-style-type: none"> 1. Exterior Light Inspection 2. Air Leakage Monitor
<u>VEHICLE MESSAGES</u>	<u>DATA LOG</u> <ol style="list-style-type: none"> 1. Vehicle ID 2. Total Data 3. Trip Data 4. Reset Trip Data
<u>RESET TRIP DATA</u>	<u>AFTERTREATMENT</u> <ol style="list-style-type: none"> 1. Request Parked REGEN 2. ATS Status 3. Cancel REGEN
	<u>PASSWORD</u> <ol style="list-style-type: none"> 1. Enter Password
	<u>PREVOST LIAISON (OPTION)</u> <ol style="list-style-type: none"> 1. Read Message 2. Send Message 3. Other Info

5-12 Other Features

GAUGES

There are several gauges in this menu. The gauges are used to view current status of important functions in the vehicle.

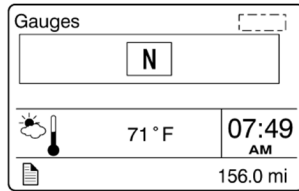

1. Current Gear Position (I-Shift transmission only)

Indicates the current gear position selected on the I-Shift transmission.

D= drive

N= neutral

R= reverse

M= manual

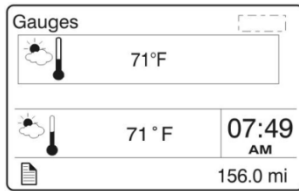

2. Outside Temperature

Selecting this gauge will display the engine oil temperature.

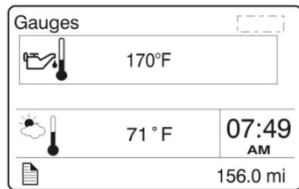

3. Engine Oil Temperature

Selecting this gauge will display the engine oil temperature.

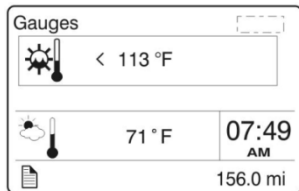

4. Transmission Fluid Temperature

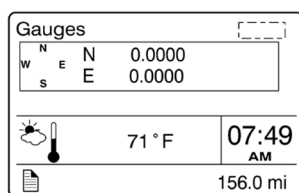

5. Prevost Liaison Compass

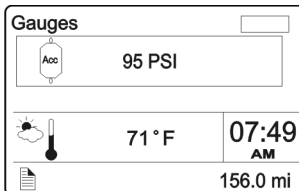

6. Accessories Air Pressure

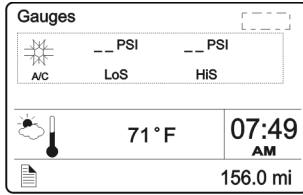

7. A/C Compressor Pressure

Displays the A/C compressor suction pressure value (LoS=low side) and discharge pressure value (HiS=high side).

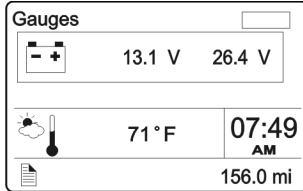

8. Battery Voltage

Displays current 12-volts and 24-volts systems voltage.

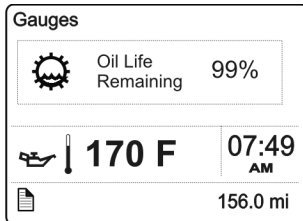

9. Allison Transmission Oil Life

Displays the percentage of the calculated remaining life of the transmission oil. New oil is displayed as 99%. Refer to Appendix C for more details.

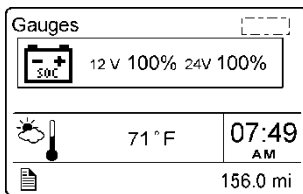

10. Battery State Of Charge

Displays the state of charge of the 12-volt and 24-volt systems, expressed in percentage.

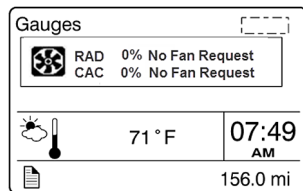

11. Electric Cooling Fan Status

Displays the speed and the state of both Charge Air Cooler and radiator cooling fans, expressed in percentage from 0 to 100%.

FUEL DATA

The Fuel Data menu provides information on the fuel consumption of the vehicle in various situations. For example, how much fuel has been used, how much fuel is remaining before refueling the vehicle.

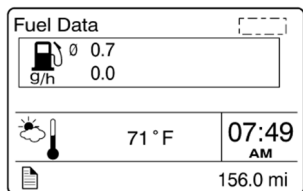

1. Fuel Flow (gph)

The lower numerical value (0.0) indicates the instantaneous fuel consumption. In this menu, you can reset the upper numerical value which is the average fuel consumption (0.7). To reset, hold ENTER button for 1 second.

5-14 Other Features

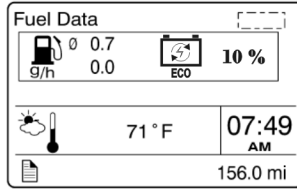

2. Fuel Flow/ ECO%

The lower numerical value (0.0) indicates the instantaneous fuel consumption. In this menu, you can reset the upper numerical value which is the average fuel consumption (0.7). To reset, hold ENTER button for 1 second.

This menu also displays the percentage of trip made on regenerated electricity (10%).

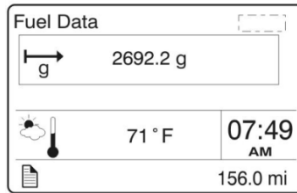

3. Trip Fuel Used

Indicates the total fuel consumption (gallons/liters) since the last reset.

Note: You should use Reset function before each new trip.

You can reset the fuel consumption value in this menu. To reset, hold ENTER button for 1 second.

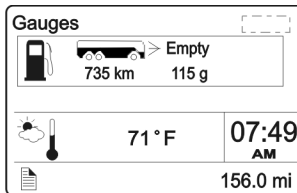

4. Distance to Empty

The left numerical value indicates the distance that can be traveled with the quantity of fuel that remains in the tank as indicated by the right numerical value.

TIME/DISTANCE

The time and date can be set in the Time/Distance menu. The alarm clock can also be set from this menu. Following the alarm clock menu is the Trip Odometer 1 and 2 selection, which allows the operator to see the distance traveled since the last reset. Average trip speed is also shown. By specifying the distance to your destination, the vehicle can calculate the estimated time of arrival (ETA).

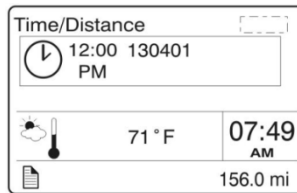

1. Time And Date

Adjust time and date with this menu. The instrument cluster has its own internal battery, so the date and date setting is keep in memory even if the vehicle's battery is disconnected.

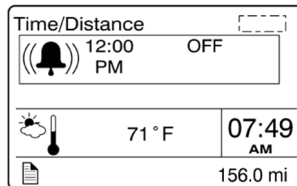

2. Alarm Clock

Use this function to program and activate an alarm on the instrument cluster clock. When the alarm clock goes off, a warning signal is sounded. The alarm shuts off after 60 seconds or if the ESCAPE button is depressed.

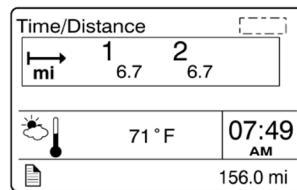

3. Trip Odometer 1 and 2

Allows the operator to see the distance traveled since the last reset. You can reset the trip odometer 1 or 2 in this menu. To reset, depress ENTER button, use UP/DOWN button to select between odometer 1 or 2 and then hold ENTER button for 1 second.

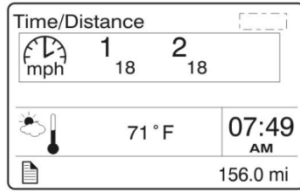

4. Average Trip Speed

This function displays the average speed for the current travel. The average trip speed is calculated as the distance traveled divided by the time the engine has been running (since the last reset). Two average trip speeds can be measured, corresponding to leg 1 and leg 2. Use Reset function before each new travel to start new measurements.

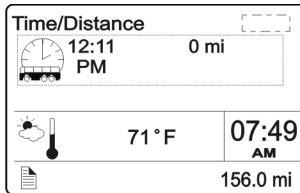

5. Estimated Time of Arrival (ETA)

This function will display the estimated time of arrival if the distance to be traveled is entered first, in this menu. To set distance to be traveled, press ENTER and enter the distance left to drive in mile or km using ENTER and UP/DOWN buttons.

VEHICLE MESSAGES

Use this function to consult the vehicle active messages that were previously displayed as pop-up messages and then acknowledged. When consulting a message, the corresponding STOP, CHECK or INFORMATION warning light will illuminate. Scroll through the messages using the up/down button. Press ESC button to return to main menu.

RESET TRIP DATA

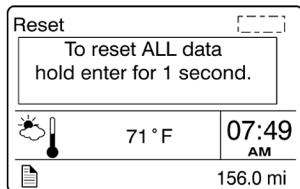

When the Reset Trip Data menu is open, pressing and holding down the Enter  button for 1 second resets the functions listed below. This function will permit to the system to calculate new value from the point of resetting.

- Trip Fuel Used
- Average Trip Speed

DISPLAY SETTINGS

The Display Settings menu is used to change languages and units. The password, time and date can also be changed. The backlight and contrast of the display screen can be adjusted.

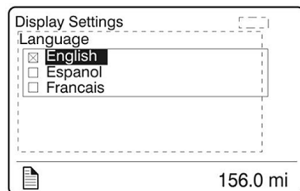

1. Language

5-16 Other Features

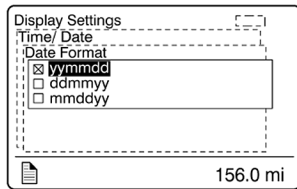
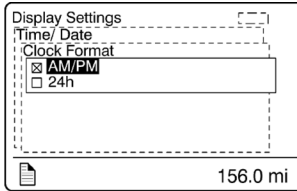
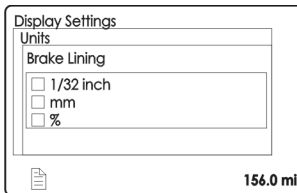
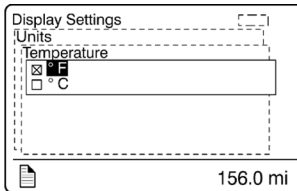
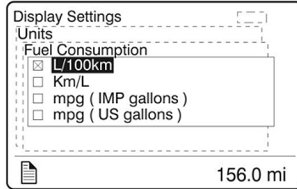
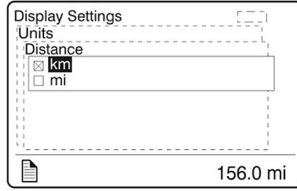

2. Units

Use this function to select desired unit formats for:

- Distance (miles or km);
- Fuel consumption (km/l, l/100km, mpg US or IMP);
- Temperature (°C or °F).
- Brake lining: 1/32 inch, mm, %. Available on vehicles equipped with a pad wear indicator.

3. Time/Date

Select the time and date format using this function.

- am, pm, 24h
- yymmdd, ddmmyy, mmddy



4. Favorite Display Setting

Use this menu to select your favorite display gauges 1, 2 and 3 and replace the default gauges. On vehicles provided with the I-Shift transmission, Favorite Display Gauge 3 cannot be edited as it is kept for display of the transmission status.

Example: You wish to display the engine oil temperature at the Gauge 1 position.

1. Use UP/DOWN button until Gauge 1 position is selected.
2. Press ENTER button to confirm.

Use UP/DOWN button to scroll through the available gauges. When the engine oil temperature gauge is displayed, press ENTER button to confirm (repeat steps 1-3 to change Gauge 2 and Gauge 3 if needed).

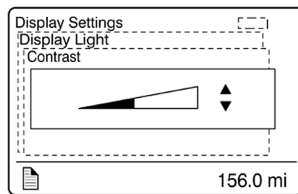

5. Display Light

The Display Light menu has three sub-menus:

- Contrast

Adjust the contrast with the UP/DOWN button and press ENTER button to confirm.

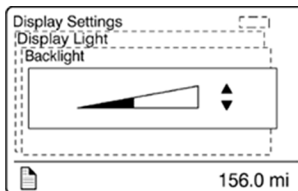

- Backlight

In this menu, the display lighting can be adjusted relative to other instrument lighting with the UP/DOWN button.

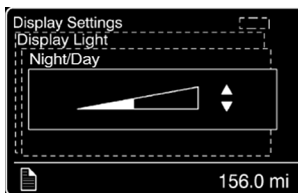

- Night/Day

Use the Night/Day menu to choose a dark background with light text and images or a light background with dark text and images. Press ENTER button to toggle between Night and Day.

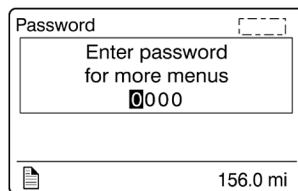

6. Change Password

Use this menu to change the current password. This menu is only accessible if the correct password is entered. The default password is 0000.

1. Mark which password is to be changed with the display UP/DOWN button.
2. Confirm with ENTER button.
3. Set the first digit with the UP/DOWN button.
4. Step to the next digit using ENTER button.
5. Step backwards with ESC button.

5-18 Other Features

DIAGNOSTICS MENU

The Diagnostics menu enables fault tracing on the control units in the vehicle to check for faults. Instrument tests are available to check the telltales, gauges, display and speaker. The part number of a control unit can be identified in the part number menu.

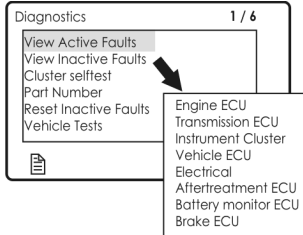

1. View Active Faults

A list of the control units on the vehicle is displayed. Use this function to check for active faults on specific control units.

2. View Inactive Faults

Use this function to check for inactive faults on specific control units.

3. Cluster Selftest

Use this menu to check proper functioning of the following components:

- Telltale lights
- Analog gauges
- Display
- Speakers

The following table describes the available tests. To cancel a test, press the ESC button).

Telltale lights test	Telltales illuminate for approximately five seconds. Press the Esc button to cancel the test.
Analog gauges	The indicators move forwards and backwards between the end positions. They do not show any particular value. This is just a check to confirm that the indicators move, and to make sure the operators are working. Press the Esc button to cancel the test.
Display test	The entire display lights up until the Esc button is pressed.
Speaker Test	A sound is emitted through the speakers. Press the Esc button to cancel the test.

4. Part Number

A list of the control units on the vehicle with their part numbers is displayed in the Part Number menu.

5. Reset Inactive Faults

Use this menu to delete an inactive fault for a particular control unit. Note: it is not possible to delete inactive faults of the Engine ECU.

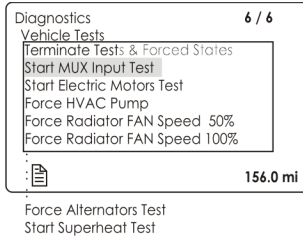

6. Vehicle Tests

Use this menu to perform tests on several components and systems:

- Dashboard switches (Mux Input Test)
- Electric motors, valve and pump contactors (Electric Motors Test)

In case of overheating of the engine due to a malfunction of the radiator fan you can force activation of the fan using ACTIVATE RADIATOR FAN SPEED 50% or 100%.

The DID status line will show TEST to confirm that one of the test modes is active. To cancel an active test, turn the ignition switch to the OFF position or press ESCAPE button, select Terminate Tests & Forced States submenu and then press ENTER button twice. "TEST" will disappear from the DID status line.

For further information concerning these functions, refer to Maintenance Manual section 06: Electrical, under "Available Test Modes" and "Limp-home Modes".

PRE-TRIP ASSISTANCE (OPTION)

The Pre-Trip Assistance option is a tool to assist the driver in completing the pre-trip inspection of the vehicle. This option is not a substitute for a complete pre-trip inspection. If any system of the vehicle does not pass inspection, the error must be corrected before operating the vehicle. The available pre-trip tests include the Exterior Light Inspection check, and the Air Leakage check.

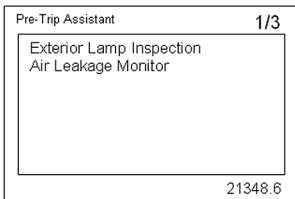

1. Exterior Light Inspection

The Exterior Light Inspection function turns on all the exterior lights simultaneously. This allows the operator to start the test, exit the vehicle and do a visual check that all exterior lights function properly. Press ESCAPE button to end the test and turn off all the exterior lights.

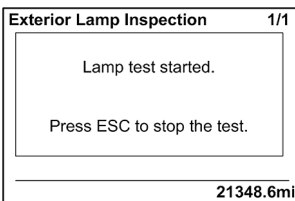
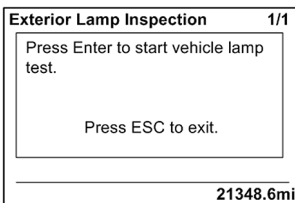

5-20 Other Features

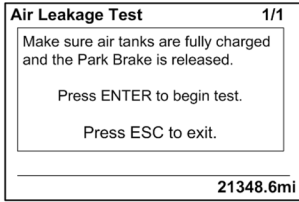

2. Air leakage Monitor

The Air Leakage check allows the driver to accurately measure the amount of air pressure drop in the front and rear brake air systems. After selecting this test from the DID, you are prompted to apply the service brake for 60 seconds. After applying and holding the service brake for 60 seconds, the DID will display the amount of pressure drop in the brake system.

Before starting the test through the DID, complete the following:

- A. Chock the wheels to prevent the vehicle from rolling.
- B. Start the engine and check that the brake systems air pressure is greater than 100 psi.
- C. Turn engine off.
- D. Release the parking and service brakes and allow the system to settle (air gauge needle stops moving).
- E. Press the ENTER button to start the test.
- F. If the air tanks pressure is too low to perform the test (pressure must be greater than 100 psi), the following messages will appear.
- G. You must press and hold brake pedal for 60 seconds, as instructed.
- H. Once the brake pressure test is completed the pressure leak test results are displayed.

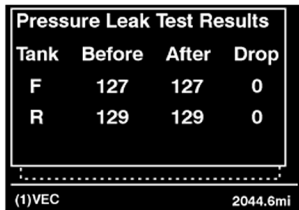
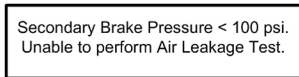
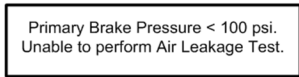

DATA LOG

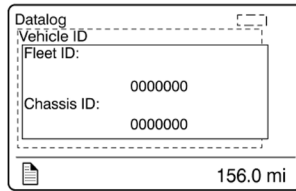

1. Vehicle ID

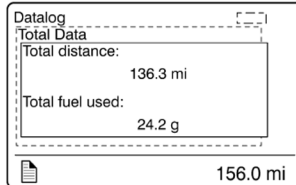

2. Total Data

Total Data menu indicates the accumulated engine values that have been logged during the lifetime of the engine ECU.

Available information:

- Total distance traveled
- Total fuel used
- Total engine hours
- Total idle time
- Total PTO hours
- Total engine revolutions

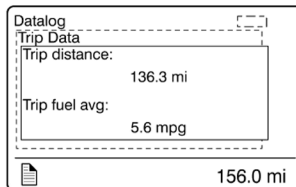

3. Trip Data

This menu displays the trip information listed below. This function must be reset before each measurement (before each new trip or leg) using the Reset Trip Data menu.

Available information for the trip or leg is:

- Trip distance (miles or km)
- Trip fuel average (mpg, liter/100km; km/liter)
- Trip fuel used (gallons or liters)
- Trip duration on cruise control (hours)
- Trip duration with engine rpm greater than economy rpm (hours)
- Trip duration while engine rpm is greater than the desire maximum rpm RPM Limit set in Fleet Limits sub-menu (hours)
- Trip fuel used with engine rpm greater than the economy rpm (gallons/liters)
- Trip average speed (mph, km/h)
- Trip duration with speed greater than the maximum desired speed as set in Fleet Limits sub-menu (hours)
- Trip engine hours
- Trip duration on engine idle (hours)
- Trip fuel used while in engine idle (gallons, liters)

5-22 Other Features

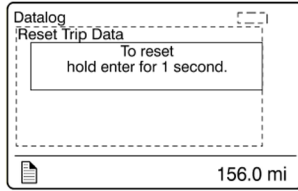

4. Reset Trip Data

This menu can only be accessed if the correct password has been entered.

Use this function to reset measurements of the Trip Data menu before each new trip or leg.

AFTERTREATMENT

This menu permits to the driver to initiate a stationary regeneration, to check the status of the aftertreatment system and to interrupt regeneration.

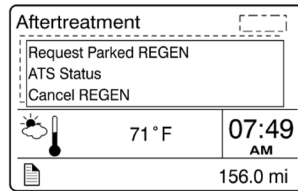

1. Request Parked REGEN

Use this function to initiate a stationary (parked) regeneration.

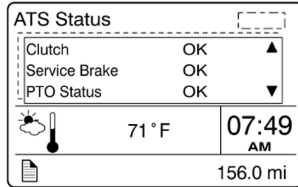

2. ATS Status

The Aftertreatment status sub-menus provide information about the conditions required for performing regeneration. The status can be OK (regeneration allowed), CHECK (regeneration not allowed) or N/A (not applicable). When ATS Status is selected, the following displays (images at left) will show.

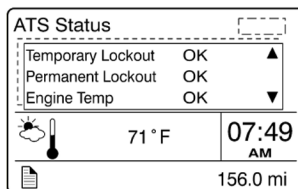
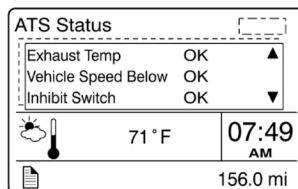
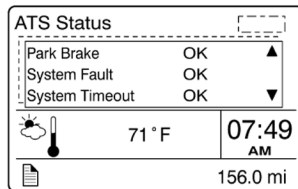
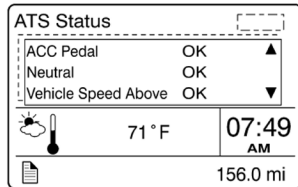

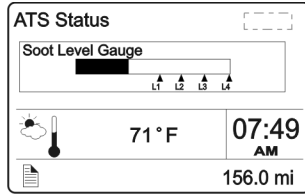

Soot Level Gauge

From the ATS Status sub-menu, you can view the soot level for the Aftertreatment system. When the soot level is high, regeneration is necessary. L1, L2, L3 and L4 under the scale correspond to Level 1 up to Level 4 (see "[DEF CLOGGING SEQUENCE – INSTRUMENT CLUSTER TELLTALE LIGHT](#)" on page 4).



3. Cancel REGEN

From the Aftertreatment main menu, you can cancel a REGEN cycle.

PASSWORD

Certain functions are password-protected. These passwords give the user access to all password-protected functions. The default password is 0000.

1. Password

The following menus are password-protected and marked with a key symbol in the menus:

- Change Password
- Fleet ID
- Reset Trip Data
- Fault Diagnostics
- Inactive Faults

PREVOST LIAISON (OPTION)

The Prevost Liaison system provides cellular communication between the driver and the fleet operator. The driver can send and receive short text messages, which are visible through the Driver Information Display.

5-24 Other Features

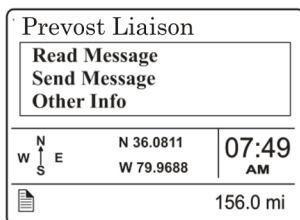

The following menus are available:

1. **Read Message**

- Quick Response (only available if there is a message available)

2. **Send Message**

- Driver & Equipment
- Dispatch Messages
- Free Text

3. **Other Info**

- Comm Liaison Info
- Mailbox Info
- GPS Info
- INI Info
- Configuration Info

INTELLIGENT SLEEP MODE (ISM)

The ISM is a battery-saving mode designed to protect the battery State Of Charge (SOC). The ISM will automatically change the vehicle electrical system from normal functional state to sleep mode if the battery SOC falls below 65%.

Once the vehicle has entered into sleep mode, the only actions needed to put the vehicle back into its normal functional state are:

- To cycle the ignition key from OFF to ON;
or
- To open the entrance door;
or
- To turn on the hazard lights.

The ISM forces the vehicle to go into sleep mode if all the following conditions are met:

1. The engine is not running;
2. The parking brake is applied;
3. The ignition switch is at the ON, ACC positions or at the OFF position but the 15 minutes “wake up” period after engine shutdown is not expired;
4. The battery state of charge of 12V or 24V system falls below 65%.

The red ALTERNATOR telltale will turn on 30 seconds before activation of the sleep mode.



TRANSMISSION RETARDER

The transmission retarder is an optional device that helps to reduce the speed of a vehicle. It improves vehicle control, increases driving safety and permits more economical operation. The retarder provides slowing power when it is most needed, such as when descending mountain roads, in stop-and-go traffic and on crowded freeways.

The transmission retarder is a vehicle-slowng device, not a vehicle-stopping device. It is not a substitute for the service braking system. The service brake must be used to bring the vehicle to a complete stop.

The retarder is provided with control buttons on the steering wheel and a lever on the steering column (refer to ["TRANSMISSION RETARDER"](#) on [page 11](#) in Section 4 Controls and instruments).

NOTE

Extended use will raise the temperature of the transmission fluid.

The retarder helps reduce speed on grades without using the vehicle's conventional service braking system. This virtually eliminates brake overheating and reduces the risk of a runaway vehicle. A retarder greatly increases the service life of brake pads and discs, resulting in reduced brake maintenance costs.



WARNING

Do not use the retarder during inclement weather or slippery road conditions.

NOTE

The stoplights automatically illuminate when the vehicle is slowing down after application of the transmission retarder.

NOTE

For vehicles equipped with the Antilock Braking System (ABS), as the wheels start to lock up on slippery roads, the output retarder automatically deactivates until the wheels roll freely.

ENGINE BRAKE



WARNING

A vehicle speed retarding device (such as engine brake) is not intended to replace the service brake systems on your vehicle nor intended to bring your vehicle to a stop. A vehicle speed retarding device is only intended to reduce the speed of your vehicle under certain conditions.

Several types of engine brake can be installed or are standard on certain engines. All are used to reduce wear on the vehicle brake linings.

5-26 Other Features



WARNING

When descending significant grades, use the service brake as little as possible. If the engine does not slow the vehicle to a safe speed, apply service brake and shift to a lower range. Let the engine (and engine brake) slow the vehicle. Keep brakes cool and ready for emergency stopping.

VOLVO ENGINE BRAKE (VEB)

On vehicles equipped with the Volvo Engine Brake (VEB), the engine brake mode is by default, set to the AUTO mode (A) at vehicle start-up.

When running in AUTO (A) mode, the engine brake is gradually applied to 100% of the braking power when the driver pushes the brake pedal. Since AUTO (A) mode will not reduce vehicle momentum unless the brakes are applied, it will have no impact on fuel consumption.

The driver can also choose two other modes using the steering wheel switches; Engine brake LOW (1) and engine brake HIGH (2).

When set to the engine brake LOW (1) mode, 50% of the engine brake power will be applied when the driver releases the accelerator pedal. Using engine brake HIGH (2) will apply 100% of the braking power.

It must be noted that since engine brake LOW (1) and engine brake HIGH (2) will reduce vehicle speed upon release of the throttle pedal, they may negatively impact fuel consumption if used for extended periods of time.

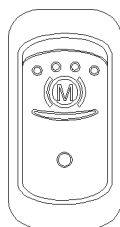

On vehicles equipped with an engine brake switch, it is possible to deactivate the engine brake (OFF mode). To do so, the driver must press the engine brake switch located on the left side of the dashboard.



Engine Brake Switch

NOTE

When using engine brake LOW (1) or HIGH (2) mode, pressing the steering switch OFF button will switch back to the default AUTO (A) mode.

DRIVER PEDALS	ENGINE BRAKE MODE	ENGINE BRAKE FORCE
ANY POSITION	(OFF)	0%
ACCELERATOR PEDAL RELEASED 	(A)	0%
BRAKE PEDAL PUSHED 	(A)	100%
ACCELERATOR PEDAL RELEASED 	(1)	50%
	(2)	100%

ENGINE BRAKE FORCE APPLIED ACCORDING TO SELECTED MODE AND DRIVER PEDAL POSITION





NOTE

Engine brake is safe to use in any road conditions including adverse conditions.

CRUISE CONTROL AND ENGINE BRAKE

When cruise control is enabled by the driver, the engine brake mode is forced to AUTO (A) mode and the engine brake will progressively engage up to

100% if the selected cruise speed is exceeded by approximately 2 km/h (1.25 mph). Manually switching to engine brake LOW (1) or HIGH (2) using the steering wheel switches will deactivate the cruise control.

CRUISE CONTROL & SPEED	ENGINE BRAKE MODE	ENGINE BRAKE FORCE
<div style="border: 1px solid black; padding: 5px; display: inline-block; font-weight: bold; font-size: 2em;">CRUISE</div> + CRUISE SPEED SET + 2 Km/h		0%
		UP TO 100%
		N/A
		N/A

ENGINE BRAKE FORCE APPLIED WITH CRUISE CONTROL

NOTE

On vehicles equipped with the Allison transmission, if cruise control is enabled, the current engine brake mode is saved in the vehicle computer (MCM) memory and the engine brake mode is set to Auto mode (A). When the cruise control is disabled, the engine brake mode changes back to the mode saved in the MCM memory.

ABS, TRACTION CONTROL SYSTEM (TCS) & ELECTRONIC STABILITY CONTROL (ESC)

ANTILOCK BRAKING SYSTEM (ABS)

The purpose of the Antilock Braking System (ABS) is to maintain vehicle stability and control during braking and to minimize the stopping distance in any road condition.

On slippery roads and more generally in emergency situations, over-braking frequently induces wheel locking. Wheel locking greatly increases braking distance on any road surface. Locked wheels also impede directional control and cause severe tire abrasion. An antilock braking system provides

maximum braking performance while maintaining adequate control on slippery roads.

The basis of ABS is constant monitoring of wheel parameters during braking. Sensors on each wheel of the front, drive and tag axles constantly measure wheel speed during braking. This information is transmitted to a six-channel electronic processor which senses when any wheel is about to lock. Modulating valves quickly adjust brake pressure (up to 5 times every second) to prevent wheel lock. Each wheel is therefore controlled according to the available grip.

In this way, the vehicle is brought to a stop in the shortest possible time while remaining stable and under the driver's control.

 **WARNING**

Vehicles following ABS-equipped vehicles may not be able to brake as fast on slippery roads.

TRACTION CONTROL SYSTEM (TCS)

TCS controls wheel spin during vehicle acceleration to improve traction.

- The TCS system will intervene automatically and apply braking pressure to a spinning wheel transferring engine power to the other drive wheel that have better traction. This feature is active only at speeds below 25 mph (40 km/h).
- If all of the drive wheels begin to spin, the TCS system will reduce engine throttle to improve traction at all of the drive wheels.

If drive wheels begin to lose traction during acceleration, TCS will engage automatically to assist the driver in accelerating the vehicle. The TCS icon in the DID will flash rapidly to let you know whenever TCS is actively functioning.

ELECTRONIC STABILITY CONTROL (ESC)

The ESC stability system is an optional feature for ABS-equipped vehicles that reduces the risk of rollovers and loss of control. The ESC system features include the RSP Roll Stability Program and Yaw Control.

The RSP system counteracts the tendency of a vehicle to tip over while changing direction (typically, while turning).

5-28 Other Features

To reduce the risk of rollover, the RSP system detects potential rollover conditions and slows the vehicle both by reducing engine throttle (and hence, engine torque) and by applying service brakes as needed at the appropriate wheels.



WARNING

During an RSP system intervention, the vehicle automatically decelerates. The RSP system can slow the vehicle with or without you applying the brake pedal, and even when you are applying the throttle.

During an RSP system intervention, you can always use your service brake pedal to increase the braking pressure that will be applied. However, if you were to apply less braking pressure than needed or even if you release the brake pedal entirely during an intervention, the RSP system will continue to apply the necessary amount of braking pressure automatically to the appropriate wheels to mitigate a potential rollover.

Yaw Control is a feature that reduces the risk of loss of control. If a vehicle's tires start to slide during a turn, Yaw Control counteracts the tendency of that vehicle to spin (or yaw), thereby reducing the risk of loss of control. Many factors, including road conditions, load distribution and driving behavior, can contribute to the development of a spin.



WARNING

In the case where a vehicle equipped with the ESC system pulls a trailer, the latter must be equipped with ABS.



WARNING

Even with ESC-equipped vehicles, the driver remains responsible for ensuring vehicle stability during operation.

NOTE

For further details, consult "Bendix ABS Operator's Manual"

DRIVER CONTROLLED DIFFERENTIAL LOCK (DCDL)

By actuating the dashboard switch, the driver can lock or unlock differential action.

The purpose of the DCDL is to provide maximum vehicle traction and control on unfavorable road surface conditions. When the DCDL is actuated, a clutch collar completely locks the differential case, gearing, and axle shafts together. This feature maximizes traction to both wheels. The lock position will also protect against spinout damage to the differential. The DCDL should not be actuated when favorable road conditions exist. DCDL is an optional feature.

OPERATION TIPS

1. The DCDL can be locked or unlocked if the vehicle is standing still or moving at a constant low speed when the wheels are not spinning, slipping, or losing traction.
2. When the DCDL is locked, operate the vehicle at low speeds. DCDL will not engage and will disengage in speed higher than 5 MPH (8 km/h).
3. When the DCDL is locked, the vehicle's turning radius will increase. This condition is called "understeer." The driver must use caution, good judgment and drive at low speeds when operating the vehicle with the DCDL locked.
4. Always unlock the DCDL as soon as the need for maximum traction has passed and the vehicle is traveling on a good road.
5. Do not lock the DCDL when the wheels are slipping or losing traction, or damage to the axle can result.
6. Do not lock the DCDL when the vehicle is traveling down steep grades, or potential loss of vehicle stability could occur.

LOCKING THE DCDL

When encountering poor road conditions where maximum traction is needed, follow the recommended procedures:

1. Without the wheels spinning, slipping or losing traction, flip the DCDL control switch to the "LOCK" position while maintaining a constant vehicle speed.
2. Let up momentarily on the accelerator to relieve torque on the gearing, allowing the DCDL to lock.
3. When the DCDL is fully locked, the vehicle will have an "understeer" condition when making turns. Proceed cautiously over poor road conditions.

UNLOCKING THE DCDL

When the vehicle can safely operate and driving conditions have improved, disengage the DCDL following the recommended procedures:

1. Flip the control switch to the "UNLOCK" position, when the vehicle is stopped or when traveling at low speed while the wheels are not spinning, slipping or losing traction.
2. Let up momentarily on the accelerator to relieve torque on the gearing, allowing the DCDL to unlock.
3. Resume driving at normal speed using good driving judgment.

RETRACTABLE TAG AXLE

Tag axle is controlled by a valve located on the lateral control panel. The valve can be switched to either the wheels up or wheels down position. The axle will be automatically raised or lowered by air pressure according to the valve position. Refer to ["TAG AXLE CONTROL VALVE" on page 14](#) in Section 4, Controls and Instruments.

The tag axle service brakes operate only when the tag axle is in the wheels down position. Never lower the tag axle while the coach is moving. A pictogram appears in the Driver Information Display if the vehicle speed exceeds 12 mph (20 km/h) with tag axle raised. The tag axle can be raised in tight maneuvering areas like in a parking lot or to make it

easier to turn a short corner. The tag axle shortens the wheelbase and allows tighter turning. Raising the tag axle transfers extra weight and additional traction to the drive wheels providing improved control on slippery roads.



CAUTION

Do not use tag axle in raised position for an extended period. Raising tag axle increases load on the drive axle, suspension and tires.

Do not drive vehicle with tag axle raised when speed is exceeding 12 mph (20 km/h).

In order to prevent damage to the suspension, always raise the tag axle before lifting the coach.

VARIABLE ASSISTANCE STEERING GEAR (OPTIONAL)

The steering effort is controlled automatically in relation to vehicle speed. For more information, refer to Maintenance Manual Section 14: Steering.

KEYLESS ENTRY SYSTEM

This system, located below the entrance door handle, is used to lock or unlock the entrance door, the baggage compartment and the service compartment. Unlocking the entrance door using the keyless system will also disarm the intrusion protection and the anti-theft system.

At the time of purchase, the new owner will be given a default four (4) digit access code to unlock the vehicle and a permanently programmed six (6) digit authority code that will allow him to program up to 40 alternate four (4) digit personal access codes (see "programming and managing personal codes" instructions below).

Do not push the keyless buttons with a key, pencil or any other hard or sharp object as the buttons could be damaged. Although each button is provided with two digits separated by a vertical line, there is only one contact per button. Press in the center of the button.

NOTE

Pressing a system key will illuminate the keyboard, unlocking the entrance door will also illuminate the vehicle step lights. Both illumination will go off after a 30 seconds period of inactivity.

5-30 Other Features

KEYLESS OPERATING INSTRUCTIONS

Entering a valid access code enables secure operation. After entering the access code, the keypad is enabled for 5 seconds and a fifth button press initiate an action.

NOTE

A double beep after entering an access code indicates a correct code and readiness for an action command.

To Unlock The Entrance Door And Disarm The Anti-theft System:

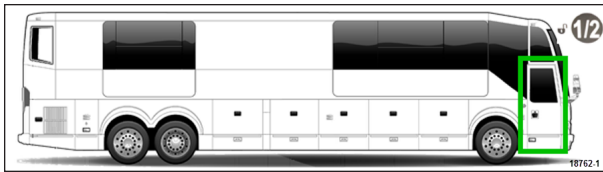

- Enter your personal or the default access code followed within 5 seconds by the 1/2 key.

To Unlock The Baggage And Service Compartment Doors:



- Enter your personal or the default access code followed within 5 seconds by the 5/6 key.

To Unlock All Doors Simultaneously:

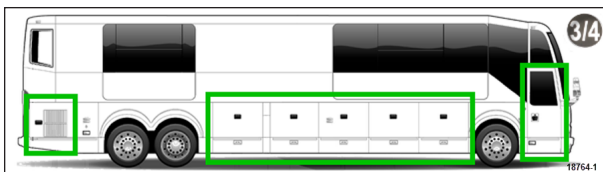

- Enter your personal or the default access code followed within 5 seconds by the 3/4 key.

To Lock The Doors And Activate The Anti-theft System:



- Press the 9/0 key for 2 seconds (no access code required).

NOTE

The lock function will not function when the ignition is in the ON position or the entry door is open.

NOTE

After repeated attempts to enter codes (20 button presses without enabling), the keypad will enter in an inactive mode that disables buttons for 60 seconds. The lock indicator will flash amber and red during this state.

If a partial validation code is entered or no action button is pressed within 5 seconds, the keypad will revert back to disabled condition and the access code will have to be entered again.

PROGRAMMING AND MANAGING PERSONAL CODES

It is possible to program up to 40 four (4) digit personal access codes to unlock the entrance door and compartments. These codes do not replace the default code that is factory supplied with the vehicle.

When programming codes, do not choose codes that present the numbers in sequential order, studies show that people who idly press the buttons usually press a sequential pattern. Also, do not select a code that uses the same button four times, thieves can easily figure out these types of codes.

To Add A New Personal Code:

- Choose and memorize a four (4) digit personal code.
- Press and hold the 5/6 key for five seconds (keypad will start to beep and flash).
- Enter the vehicle factory six (6) digit authority code.
- Press the 1/2 key (a short beep will be heard, validating the action).

NOTE

- If the 40 codes memory is already full, a long beep will be heard.

- At any time, press the 9/0 key to exit programming mode.

- Enter the chosen personal code (three confirmation beeps will be heard).
- Re-enter the code to confirm the entry (four confirmation beeps will be heard).

Press the 1/2 key and repeat the last two steps to enter additional codes.

To Delete A Personal Code:

- Press and hold the 5/6 key for five seconds (keypad will start to beep and flash).
- Enter the vehicle factory six (6) digit authority code.
- Press the 3/4 key (a short beep will be heard, validating the action).

NOTE

- If the 40 codes memory is already empty, a long beep will be heard.
 - At any time, press the 9/0 key to exit programming mode.

- Enter the code to be deleted (three confirmation beeps will be heard).
- Re-enter the code to confirm the deletion (four confirmation beeps will be heard).

Repeat the process to delete additional codes.

To Delete All Stored Personal Codes:

- Press and hold the 5/6 key for five seconds (keypad will start to beep and flash).
- Enter the vehicle six (6) digit authority code.
- Press the 3/4 key (a short beep will be heard, validating the action).

NOTE

-If the 40 codes memory is already empty, a long beep will be heard.
 -At any time, press the 9/0 key to exit the programming mode.

- Press the 1/2 and the 9/0 keys simultaneously (a confirmation double beeps will be heard).
- Re-enter the authority code to confirm the deletion (four confirmation beeps will be heard, a two second beep indicates an incorrect authority code).

REMOTE ENTRY TRANSMITTER

Hand held transmitters (key FOB) can be used to control the keyless door lock system.



To Lock Doors And Arm The Intrusion Protection And Anti-theft System Simultaneously:

- Press LOCK (top) button on the transmitter once..

NOTE

The lock function will not function when the ignition is in the ON position or the entry door is open.

NOTE

The intrusion protection and anti-theft system will be set after a 10 seconds delay.

To Unlock The Entrance Door:

- Press UNLOCK DOOR (bottom) button on the transmitter. This will unlock the door and disarm the anti-theft system.

To Unlock The Baggage Compartment Doors:

- Press UNLOCK BAGGAGE (right) button. This will not disarm the alarm.

To Set Off The Personal Security Alarm (Panic Mode):

- Press and hold the red (left) PANIC button for two seconds. The horn will sound and the marker lights will flash for 30 seconds.

To Deactivate The Personal Security Alarm:

- Press any FOB button again or unlock the entrance door using the keypad.

5-32 Other Features

PROGRAMMING TRANSMITTERS

Up to 20 transmitters can be used with the keyless entry system. To add or replace transmitters, the system must be first put into learn mode using the vehicle keypad.

To program transmitters perform the following steps:

- Hold the 5/6 button of the keypad for 5 seconds (keypad will start to beep and flash).
- Enter the vehicle factory six (6) digit authority code.
- Hold button 7/8 for 5 seconds, a double beep will play, confirming that the system is now in learn mode.
- Press the lock button on each transmitter to be programmed for 5 seconds with a two seconds pause between each transmitter.
- Press the 9/0 button twice to exit learn mode (the keypad will beep twice and stop flashing).

NOTE

If more than 20 transmitters are programmed, additional transmitters will over-write the first ones.

SLIDE-OUT OPERATION

H3-45 VIP vehicles can accommodate up to 4 slide-out units. Slide-out units located in the front right (front curb side) position have a mobile floor system creating a flush floor at room extension.

Due to the high current demand and safety requirements of the slide-out system, room operation is on a "first in first served" basis, meaning only one slide-out unit may be operated at a time.

SAFETY PRECAUTIONS

Before operating both slide-out units, proceed to the following verifications:

- Make sure that the area outside of the slide-out is clear and that there are no persons or objects within 3 feet of the slide-out outside wall. *Serious personal injury or damage to the vehicle components may occur.*
- Make sure that the area inside the motor home where the room retracts (30" for the front and 24" for the rear slide-out) is free of people or obstacles. *Serious personal injury*

or damage to the vehicle components may occur.

- For slide-out units with flush floor option, make sure there are no objects or persons on the floor during operation.
- In temperatures below freezing point, make sure that the entire sliding surface outside the slide-out is free of snow, ice or sleet. *Failure to clear all ice or snow may seriously damage the inflatable seal.*
- The parking brake must be applied.
- The transmission must be in the "NEUTRAL" position.
- Open a window to avoid slide-out movement restriction.
- Level the vehicle.

FRONT AND REAR SLIDE-OUT OPERATION

Before extending or retracting the slide-out, please make sure all the following conditions are met:

1. Make sure the air pressure is 110 psi minimum on the auxiliary air pressure gauge.
2. Make sure the parking brake is applied and that transmission is in the "NEUTRAL" position.
3. Turn the ignition key to the "ON" position, start the engine and set the RPM to fast idle.



CAUTION

Before extending or retracting the slide-out, always open a window to avoid movement restriction and to prevent the motor from stopping in overcurrent because of a vacuum or pressure build up inside the vehicle.

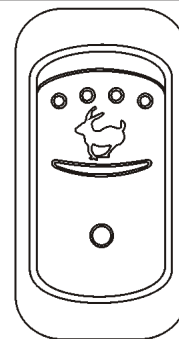

06264_1

FAST IDLE BUTTON

Slide-out Extending Operation

With the ignition switch to the "ON" position and the engine running, press and hold down the rocker switch on the control pad to the "OUT" position. The green indicator light "ROOM IN OPERATION" will come on to indicate that the slide-out operation cycle is activated. The following actions will be done in sequence:

- Deflation of the inflatable seal
- Movement of the slide-out to its full "OUT" position
- Optional flush floor rises, slight retract of the room to secure and reduce gaps in flooring.

Then releasing the rocker switch will permit the following actions:

- Re-inflation of the seal

When the rocker switch is released, the green indicator light goes out. Note that for safety reasons, releasing the rocker switch will stop the slide-out movement instantly. At any time, releasing the rocker switch from the "OUT" position and pressing it to the "IN" position will reverse the operation.



CAUTION

The inflatable seals can be re-inflated only when the slide-out is in its full "OUT" or full "IN" position. Do not leave the slide-out in any position other than the full extended or closed position as water infiltration may occur. The indicator light on the control pad must be OFF.

NOTE

A green blinking light on the control pad indicates an error condition or missing operation condition on the corresponding slide-out. Refer to "[SLIDE-OUT TROUBLESHOOTING](#)" on [page 37](#) if that situation occurs.

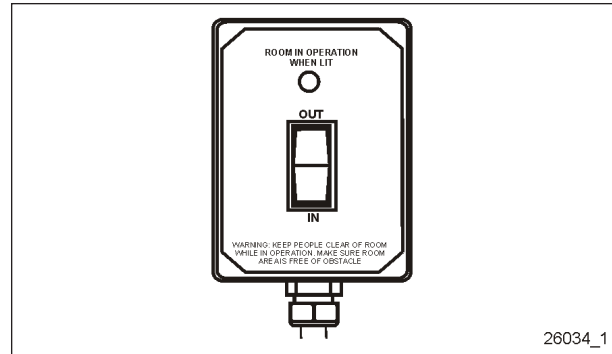

SLIDE-OUT CONTROL PAD

Slide-out Retracting Operation

With the ignition switch to the "ON" position and the engine running, press and hold down the rocker switch to the "IN" position to retract the slide-out. Note that the green indicator light "ROOM IN OPERATION" will come on. When the movement of the slide-out to its full "IN" position is completed, the rocker switch can be released to allow the re-inflation of the seal. The green indicator light goes out as the rocker switch is released. At any time during the slide-out movement, releasing the rocker switch will stop the operation instantly.



CAUTION

The inflatable seals can be re-inflated only when the slide-out is in its full "OUT" or full "IN" position. Do not leave the slide-out in any position other than the full extended or closed position as water infiltration may occur.

SLIDE-OUT MANUAL OVERRIDE PROCEDURE



CAUTION

Never use an impact power tool to manually operate the slide-out. Doing so would damage the various mechanical components of the slide-out.

Do not over extend or over retract the slide-outs. Always refer to the slide-out decal for correct direction of rotation (clockwise or counter clockwise).

In case of power retracting system failure, it is possible to use the manual override procedure to retract or extend the slide-out.

The manual override procedure consist in rotating the slide-out motor shaft extension using a cordless power drill with a 3/8" hexagonal bit.

5-34 Other Features

However, it is very important to follow all the instructions very carefully to assure that the inflatable seal or the retraction mechanisms are not damaged.



CAUTION

Manually extending the optional front right Prevost slide-out with flush floor should be attempted with extra care as a last resort.

Serious damage to the mechanical components may result.

This particular slide-out configuration uses two electronically synchronized motors for room extension. As a result, manually extending the room is not recommended.

Refer to the procedures and guidelines in the maintenance manual.

However the floor lifting portion of the mechanism can be hand operated. Refer to particular instructions below.

Preliminary Conditions For Manual Override Procedure

Before using the slide-out manual override procedure, make sure that the problem cannot be solved by one of the following simple checks:

- Make sure that none of the breakers are tripped (the breakers are located inside the VEC on the slide-out control panel and the main slide-out breaker is located in the engine R.H. side access compartment).
- Make sure the parking brake is applied and that transmission is in the "NEUTRAL" position.
- Make sure the voltage is high enough by running the engine at fast idle or having the battery charger connected.



CAUTION

Before extending or retracting the slide-out, always open a window to avoid movement restriction and to prevent the motor from stopping in over current because of a vacuum or pressure build up inside the vehicle.

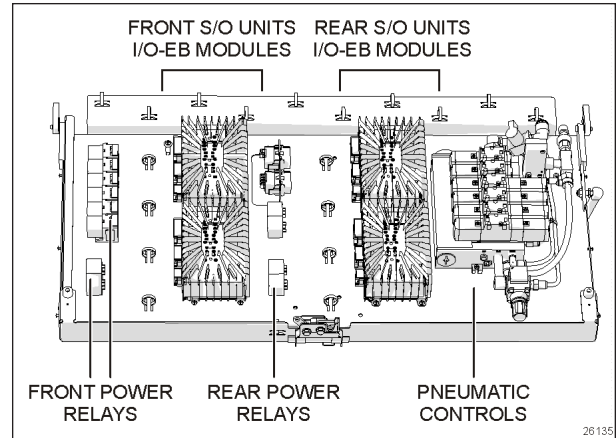

SLIDE-OUT CONTROL PANEL

Manual Retracting Procedure – Front And Rear Slide-out

1. Turn the ignition switch to the "OFF" position, and remove the ignition key for more safety.
2. Deflate the inflatable seal by using the relieving shut-off valve located on the slide-out control panel. Turn the handle clockwise to deflate the seal. Make sure the pressure indicator reading is "0 psi".



CAUTION

The pressure in the inflatable seal must be completely relieved to prevent any damage to the seal.

NOTE

When air pressure is relieved using the shut-off valve, the normal extending and retracting operation cycle is disabled, for that reason the slide-out cannot be moved using the control pad.

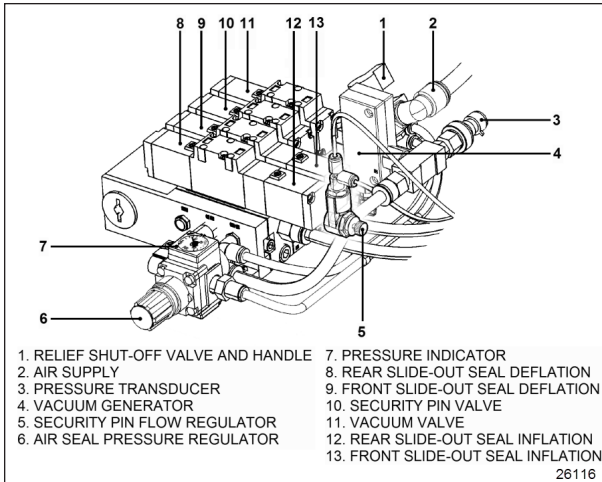

PNEUMATIC CONTROL PANEL

NOTE

Refer to the slide-out decal for correct direction of rotation (clockwise or counter clockwise).

3. To move the slide-out, use a cordless power drill with a 3/8" hexagonal bit on the shaft extension of the slide-out motor.
4. Rotate the slide-out motor shaft extension with the power drill until the slide-out comes to its closed position.
5. Once the slide-out room is lined up to its closed position, remove the tool from the motor.

NOTE

The front slide-out motor is located inside the 2nd baggage compartment while the rear slide-out motor is accessible from inside the vehicle, under the bed structure.

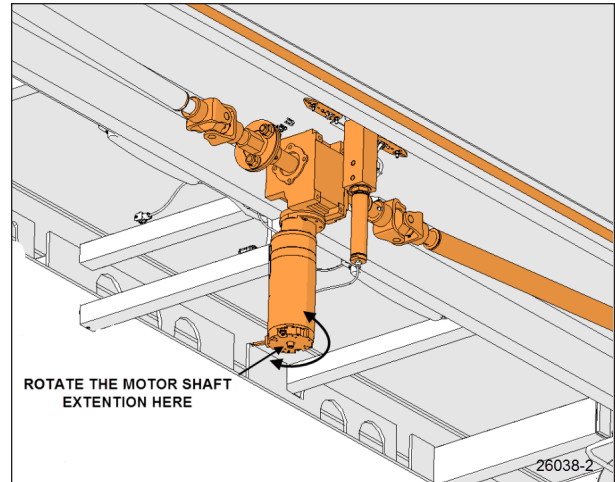

SLIDE-OUT MOTOR MANUAL ACTIVATION



CAUTION

Slow down on the closing speed as the slide-out approaches its closed position. As soon as the "in limit" stoppers come in contact with their bearing surface, stop immediately the power drill rotating movement. Not doing so could overload the drive mechanism and cause damage to the reduction gearbox.

6. Finally, the inflatable seal can be re-inflated by turning the shut-off valve handle counterclockwise. Check the pressure gage on the inflatable seal regulator to see if the pressure is increasing to around 15 psi. Needle should point between the green indicator pegs.

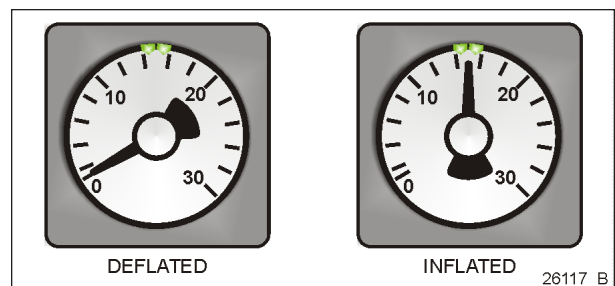

INFLATABLE SEAL PRESSURE GAGE

NOTE

The slide-out control system inhibits transmission range selection to prevent the vehicle from moving if the slide-out is not in its full "IN" position.

5-36 Other Features

Manual Extending Procedure – Front And Rear Slide-out

1. Apply parking brake to disengage the security pin from the receptacle.
2. Turn the ignition switch to the "OFF" position, and remove the ignition key for more safety.
3. Deflate the inflatable seal by using the relieving shut-off valve located in the slide-out control panel. Turn the handle clockwise to deflate the seal. Make sure the pressure indicator reading is "0 psi".



CAUTION

The pressure in the inflatable seal must be completely relieved to prevent any damage to the seal.

NOTE

When air pressure is relieved using the shut-off valve, the normal extending and retracting operation cycle is disabled, for that reason the slide-out cannot be moved with the control pad.

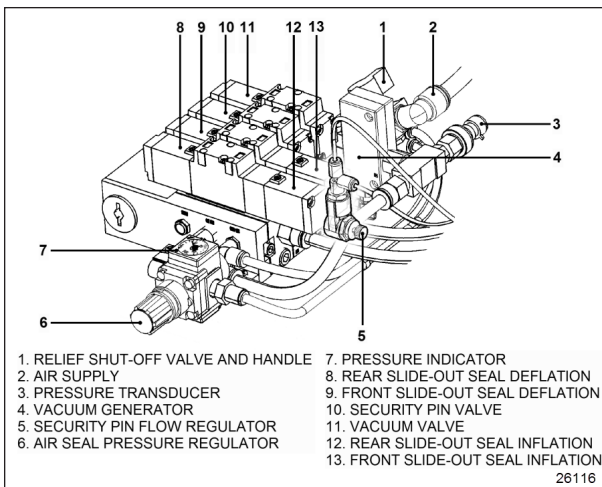

PNEUMATIC CONTROL PANEL

NOTE

Refer to the slide-out decal for correct direction of rotation (clockwise or counter clockwise).

4. To move the slide-out, use a cordless power drill with a 3/8" hexagonal bit on the shaft extension of the slide-out motor.

5. Rotate the slide-out motor shaft extension with the power drill until the slide-out comes to its opened position.
6. Once the slide-out is lined up to its opened position, remove the tool from the motor.

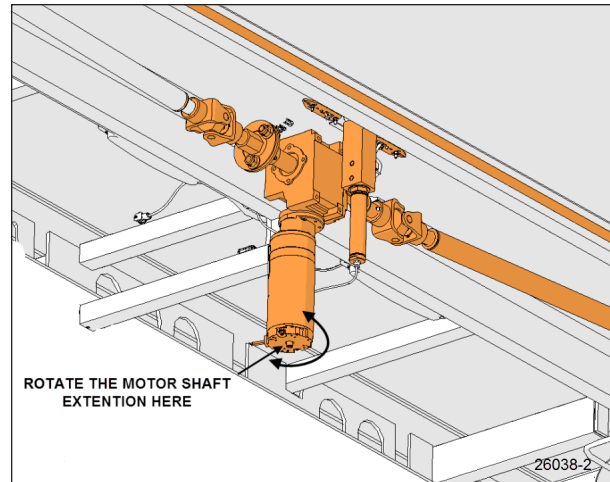

SLIDE-OUT MOTOR MANUAL ACTIVATION

NOTE

The front slide-out motor is located inside the 2nd baggage compartment while the rear slide-out motor is accessible from inside the vehicle, under the bed structure..



CAUTION

Slow down on the closing speed as the slide-out approaches its extended position. As soon as the "out limit" stoppers come in contact with their bearing surface, stop immediately the power drill rotating movement. Not doing so could overload the drive mechanism and cause damage to the reduction gearbox.

7. Finally, the inflatable seal can be re-inflated by turning the shut-off valve handle counterclockwise. Check the pressure gage on the inflatable seal regulator to see if the pressure is increasing to around 15 psi. Needle should point between the green indicator pegs.

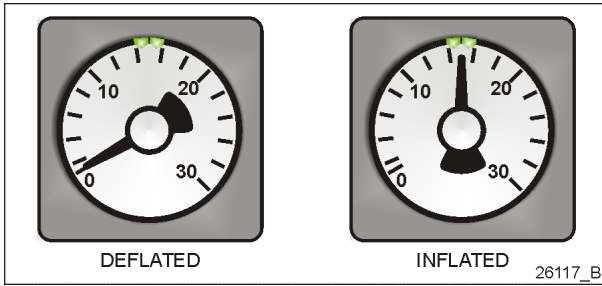

INFLATABLE SEAL PRESSURE GAGE

NOTE

The slide-out control system inhibits transmission range selection to prevent the vehicle from moving if the slide-out is not in its full "IN" position.

MOBILE FLOOR HAND CRANK PROCEDURE

The floor lifting mechanism of the front right (curb side) slide-out room can be manually operated in the event of a power failure. You will need a 6mm (1/4") Allen key to operate the actuator.

CAUTION

Do not use an electric drill or other similar tool to operate the linear actuator. Permanent damage to the unit may result.

As a safety measure, unplug the unit before attempting to hand crank the unit.

NOTE

If the actuator is operated as a hand crank, it must only be operated by hand, otherwise there is a potential risk of overloading and hereby damaging the actuator.

Hand Crank Torque: 6-8 Nm.

Hand Crank Max Speed: . 65 rpm

The actuator is located under the floor in the second right luggage compartment.

After removing the cover (4 screws), locate the hand crank hex socket on the actuator (arrow below).

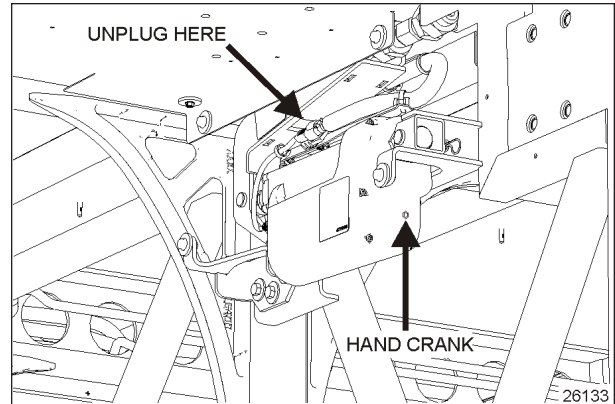

MOBILE FLOOR HAND CRANK HEX SOCKET LOCATION

The cover over the Allen Key socket must be unscrewed before the 6mm Allen Key can be inserted to operate the hand crank.

CAUTION

Make sure there are no objects or persons on or around the floor while hand cranking. Slowly operate the actuator at the indicated speed and torque.

SLIDE-OUT TROUBLESHOOTING

Error Condition Or Missing Operation Condition

When an error condition or a missing operation condition is present on a slide-out, the green indicator light on the corresponding control pad starts blinking upon releasing of the IN/OUT rocker switch.

Turning the ignition OFF and ON again, will stop the blinking and reset the fault. If the error condition or a missing operation condition is still present, the blinking will start again the next time that the slide-out is operated.

To initiate fault diagnostic, use the DID right after operating the slide-out without cycling the ignition switch.

NOTE

The DID is the main tool for troubleshooting a multiplex vehicle. It is essential to have it in working condition.

Fault Diagnostic

To get detailed information about the error condition or the missing operation condition, request a diagnostic using the dashboard Driver's Info Display (DID). Check if there are active errors in the slide-out

5-38 Other Features

electrical system. With the DIAGNOSTICS menu, highlight VIEW ACTIVE FAULTS and then highlight ELECTRICAL SYSTEM to request a diagnostic of the electrical system from the MCM.

Press the enter key. If applicable, the DID shows the device ID, the fault messages or fault codes recorded. When more than one fault is recorded, an arrow pointing down appears on the right of the display. Use the down arrow to see all the fault messages.

Once the problem is corrected, the DID will still show the fault as being active. Leave VIEW ACTIVE FAULTS up to the main menu. Then return to DIAGNOSTICS, VIEW ACTIVE FAULTS, and then ELECTRICAL SYSTEM. The DID should not display any faults.

SLIDE-OUT TROUBLESHOOTING TABLE

PROBLEM	CAUSE	CORRECTIVE ACTION
<p>The slide-out functions normally but the control pad green indicator light blinks.</p>	<p>Something is defective and may eventually create an issue if not repaired. The problem may be:</p> <p>A. Faulty limit sensor causing the slide-out to stop in overcurrent;</p> <p>B. CAN network problem causing the transmission inhibit safety to be non-operational;</p> <p>C. Vacuum pressure transducer disconnected or damaged (vacuum is applied for a fixed time of 7 seconds);</p> <p>D. Seal inflating valve solenoid open circuit (the seal is not re-inflated and water can penetrate in the vehicle);</p> <p>E. Security pin valve solenoid open circuit (the security pin is not extended while vehicle is riding).</p>	<p>Using the Driver Information Display (DID), request a diagnostic of the electrical system.</p>
<p>FLUSH FLOOR S/O ONLY Problem: The slide-out stops extending/retracting and the green indicator light flashes rapidly 3 times then one long flash (cycle repeats).</p>	<p>At least one of the mobile floor position switches is defective and the system requires operator's input to resume normal operation. The floor might also be out of level.</p>	<p>Depress the handheld control in the desired direction 3 times rapidly and hold it the fourth time until the slide out has reached the desired position.</p>
<p>FLUSH FLOOR S/O ONLY Problem: Slide out does not extend/retract.</p>	<p>The slide out stopped moving due to an obstruction.</p>	<p>Clear the path of the S/O and /or mechanism and resume operation.</p>
<p>FLUSH FLOOR S/O ONLY Problem: The slide-out does not extend/retract.</p>	<p>At least one of the motors is defective.</p>	<p>Refer to manual override procedure.</p>
<p>FLUSH FLOOR S/O ONLY Problem: Motor stopping temporarily during extend/retract sequence.</p>	<p>The slide out motors goes out of synchronization.</p>	<p>Make sure that load is distributed evenly across the slide out. Check for wear/obstructions in the slide out mechanism.</p>

5-40 Other Features

PROBLEM	CAUSE	CORRECTIVE ACTION
The slide-out does not extend.	The parking brake is not seen by the controller as being applied;	Make sure the parking brake is applied. Confirm parking brake application with the parking brake light on the telltale panel.
	Not enough air pressure in the accessory air tank to permit proper operation of the vacuum generator;	Run the engine at fast idle a few minutes to increase air pressure in the accessory air tank and try again.
	Faulty vacuum generator, connection to the vacuum generator open, seal deflating valve solenoid open circuit;	Turn the relieving shut-off valve handle clockwise to deflate the inflatable seal, disconnect the pressure transducer. Do not forget to reconnect the pressure transducer and to close the relieving shut-off valve. Failure to do so could damage the seal and lead to water infiltration;
	I/O-B module output defective, regulated 5- volt supply to sensors shorted to ground, "out limit" sensor shorted to ground, connection to the motor negative relay solenoid open circuit;	Operate the slide-out with the manual override procedures.
The slide-out does not retract.	Not enough air pressure in the accessory air tank to permit proper operation of the vacuum generator;	Run the engine at fast idle a few minutes to increase air pressure in the accessory air tank and try again.
	Faulty vacuum generator, connection to the vacuum generator open, seal deflating valve solenoid open circuit;	Turn the relieving shut-off valve handle clockwise to deflate the inflatable seal, disconnect the pressure transducer. CAUTION, do not forget to reconnect the pressure transducer and to close the relieving shut-off valve. Failure to do so could damage the seal and lead to water infiltration;
	I/O-B module output defective, "in limit" sensor shorted to ground, connection to the motor positive relay solenoid open circuit;	Operate the slide-out with the manual override procedures.
When extending, the slide-out stops after having extended by 1 inch.	The security pin valve solenoid circuit is shorted to (+) 24-volt and the pin remains engaged;	Disconnect air supply from the safety pin cylinder;
Transmission DRIVE range or REVERSE cannot be selected (the slide-out telltale light is illuminating).	Slide-out not in full "in" position;	Retract slide-out.
	Faulty "in limit" sensor. The slide-out is retracted but the controller doesn't see it as retracted.	Confirm that all slide-outs are retracted. On the slide-out control panel, disconnect the 5 pins green connector on the I/O-B module to disable the transmission inhibit. CAUTION, this is a temporary measure, the vehicle must be serviced as soon as possible.

PROBLEM	CAUSE	CORRECTIVE ACTION
Slide-out does not retract or extend when depressing the control switch.	Electrical motor failure;	Replace motor.
	Speed reduction gearbox failure;	Inspect gearbox components, particularly: bronze wheel or first reduction stage output shaft. Replace damaged components.
	Security pin still engaged in receptacle;	Disengage pin and check if air cylinder is damaged.
Slide-out is not straight once retracted or during retracting or extending operation.	Broken rack tooth;	Replace rack.
	Faulty rack attachment;	Tighten mounting bolts, apply proper torque and use "Loctite Threadlocker" (replace rack if necessary).
	Faulty shaft key at speed reduction gearbox or jaw coupling;	Replace key or component having a damaged keyway.
	Shaft breaking;	Replace shaft.
	Flange bearing attachment loose.	Reposition shaft and tighten flange bearing mounting bolts.
Slide-out moves out slightly when vehicle is traveling.	Lower "in limit" stoppers are not leaning against the structure at the moment when the "in limit" sensor detects the magnet;	Adjust the sensor position in order to have contact of the stoppers against the structure at the time when the system stops the slide-out retraction.
Slide-out moves when vehicle is moving.	Inflatable seal not inflated	Adjust the sensor position in order to have contact of the stoppers against the structure at the time when the system stops the slide-out retraction.
Slide-out moves when vehicle is moving.	Inflatable seal not inflated	Check seal condition and seal air supply system.
Slide-out retracts or extends with difficulty.	Foreign matter accumulated in the linear bearing;	Inspect the linear bearing end seals to see if they are in good condition. If not, replace the end seals and clean the inside of linear bearing.
Slide-out oscillates vertically when retracting or extending.	Linear bearing balls hardened due to a too heavy load;	If balls clearance is excessive, replace linear bearing.
	Linear bearing mounting bolts loose;	Tighten mounting bolts.
Slide-out vibrating or noisy when extending or retracting.	Worn-out anti-friction coating on wiper seal around slide-out;	Replace wiper seal.
	Lower acetal plastic block rubbing against rail;	Remove lower acetal plastic block and machine down 1mm (0.039").
Slide-out does not retract up to its full "in" position.	Interference between the exterior extrusion and the vehicle upper horizontal member above the slide-out;	Check for outer wiper seal lip straightness on the slide-out roof.

5-42 Other Features

PROBLEM	CAUSE	CORRECTIVE ACTION
Bottom of slide-out not flush with vehicle body.	Broken or misadjusted lower "in limit" stopper;	Replace or adjust lower "in limit" stopper.
	Lower "in limit" stoppers are not leaning against the structure at the moment when the "in limit" sensor detects the magnet;	Adjust the sensor position in order to have contact of the stoppers against the structure when slide-out is stopped.
Top of slide-out not flush with vehicle body.	Broken or misadjusted leveling or retaining screw;	Check and replace screw.
	Faulty upper "in limit" stopper;	Replace upper "in limit" stopper.
Lower edge of slide-out not parallel with vehicle body opening.	Faulty leveling and retaining screw (4 screws on each side).	Inspect screws, replace and adjust slide-out level.
Water tightness problem.	Inflatable seal and/or wiper seal damaged or unstuck;	Check both seals condition.
	Insufficient air pressure in the seal;	Check the pressure regulator, the relieving shut-off valve and the seal valve condition.
	No air pressure in the slide-out pneumatic system;	Check the slide-out air pressure inlet valve condition and the accessory air tank pressure.
	Sealant missing;	Check the exterior extrusion screws, the windows and the exterior panels sealant condition
	Wiper seal draining hole clogged;	Unclog draining hole.
	Faulty water recovery pan;	Check the recovery pan.
	Faulty internal gutter;	Check internal gutter.
Knocking sound at end of travel when extending slide-out.	Inner stoppers not adjusted properly;	Readjust the inner stoppers.
Knocking sound when parking brake is released.	Security pin retracts too rapidly;	Adjust security pin air flow regulator.
Inflatable seal damaged or removed, or wiper seal unstuck from the structure.	Slide-out has been retracted or extended with the manual procedure with the inflatable seal not deflated;	Always deflate the seal when manually retracting or extending the slide-out.
	Pressure transducer malfunction;	Check the pressure transducer condition, replace if necessary.
	Seal valve malfunction;	Check the seal valve condition.
	Excessive load in the slide-out;	Reduce load or distribute load evenly in order to respect the deflection criterion and slide-out load capacity.
	Slide-out not centered in the structure opening;	Readjust the slide-out height and center horizontally in opening.

PROBLEM	CAUSE	CORRECTIVE ACTION
Friction at end of travel when in full OUT position or at beginning of retraction.	Interference between upper structure key and upper inner stopper;	Readjust the upper inner stopper.

