

SHORE PLUG 110V

CHARGER PLUG

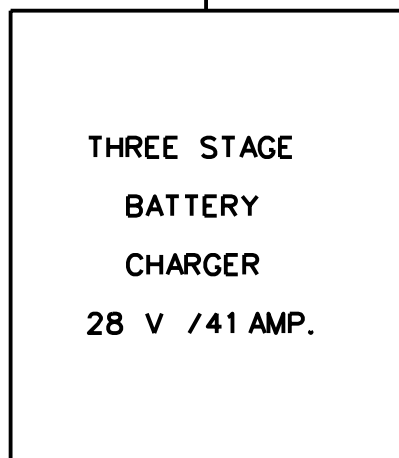
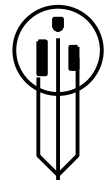

TO BOOSTER BLOCK SEE P. 1.1

BATTERY CHARGER OR IN-STATION LIGHTING

FRONT R.H.

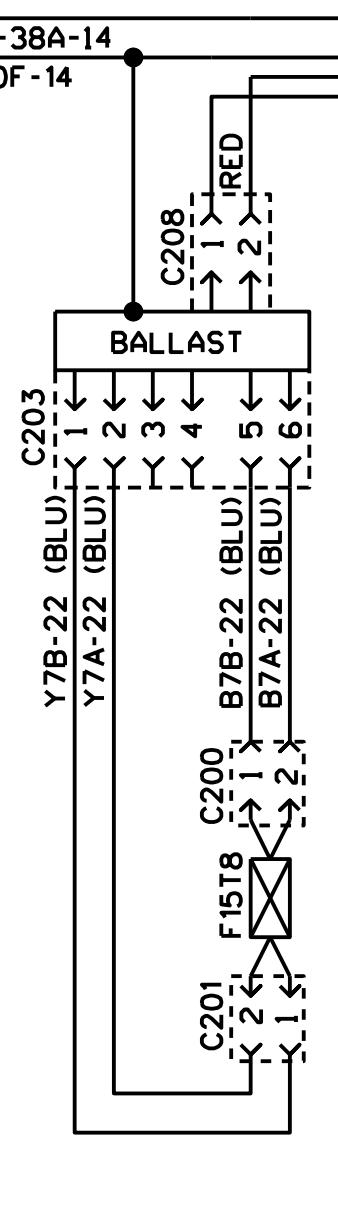
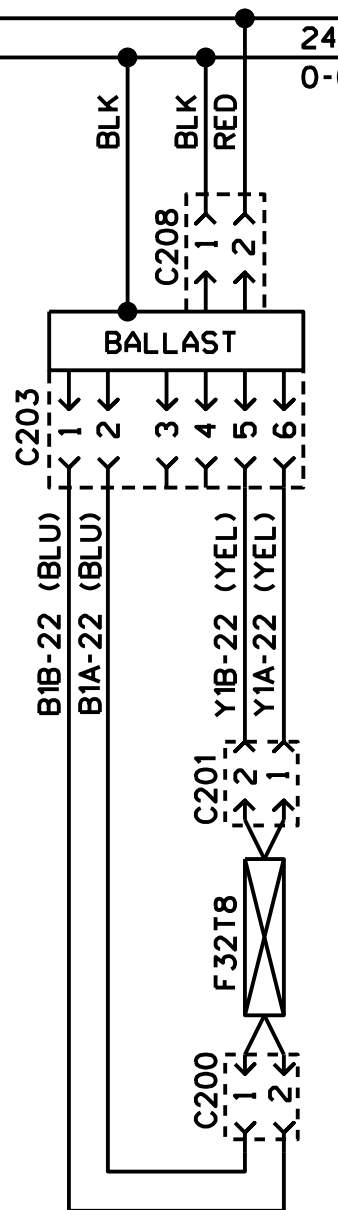
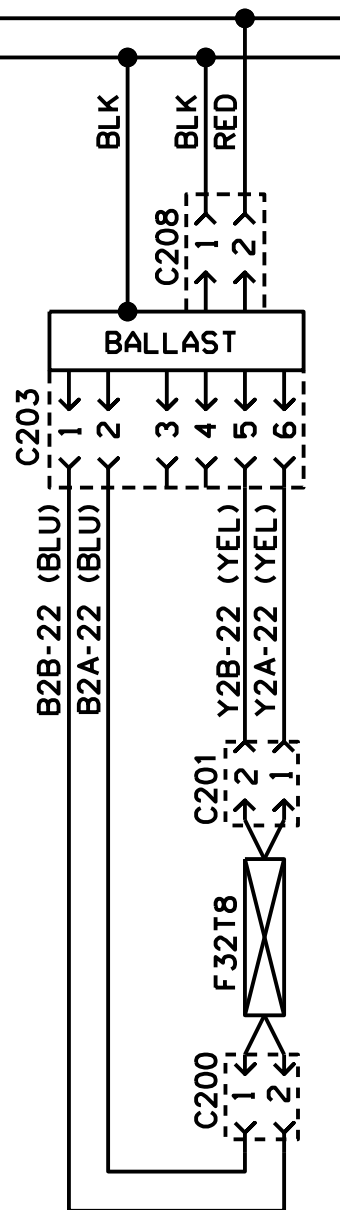
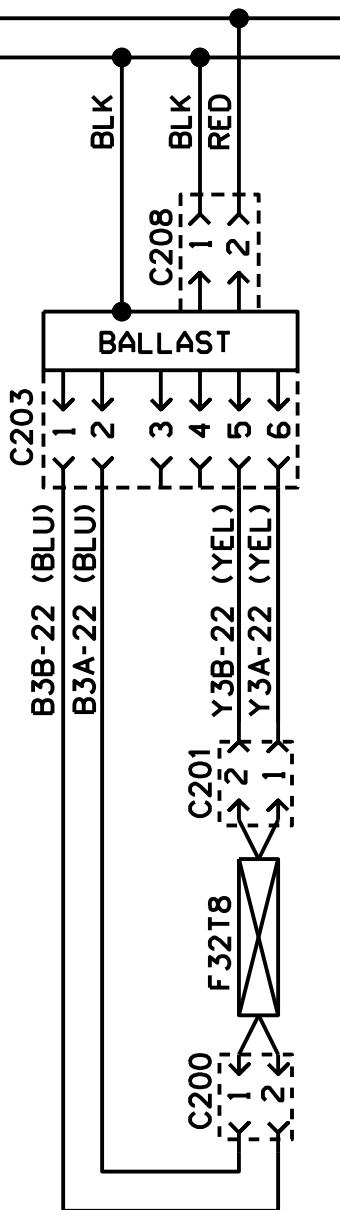
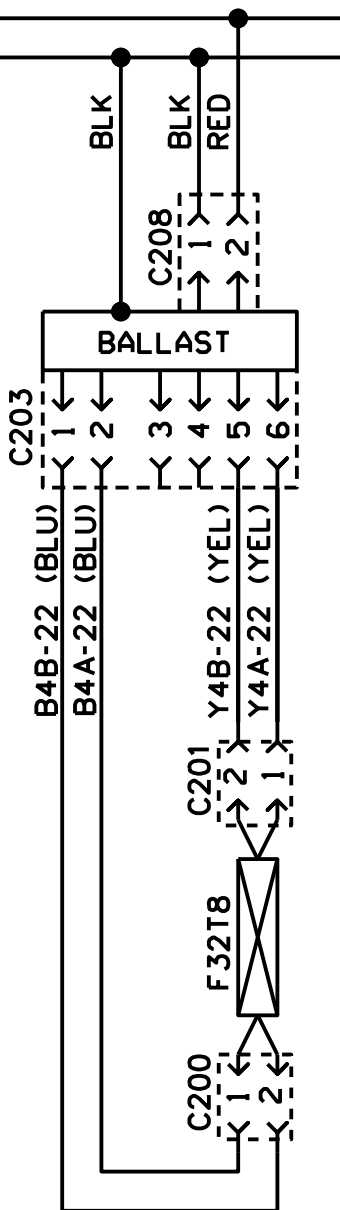
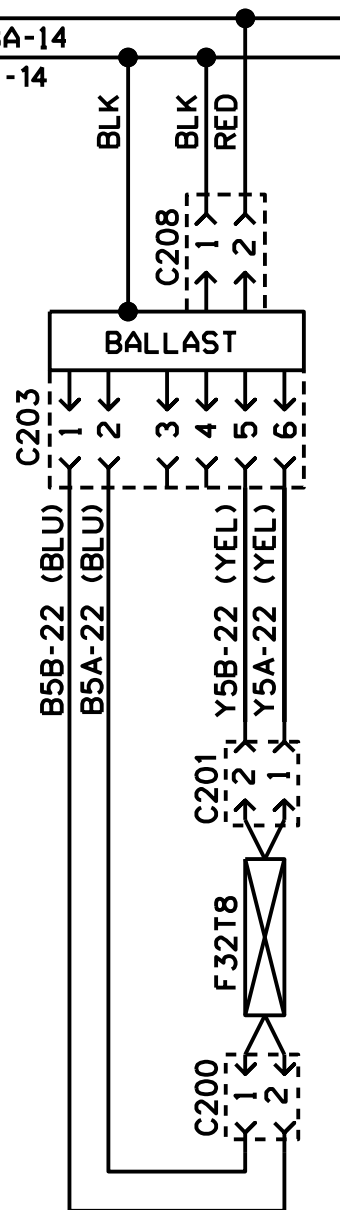
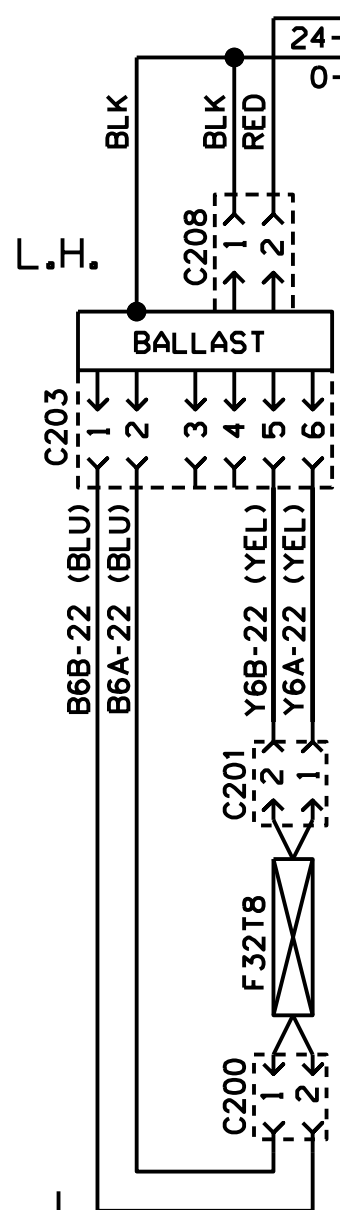
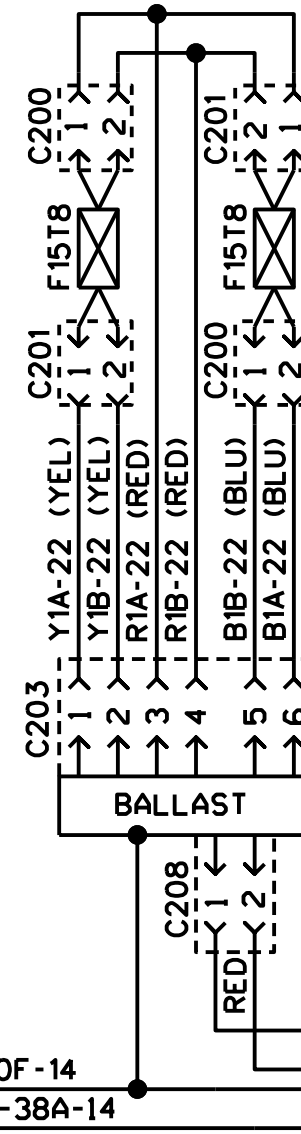
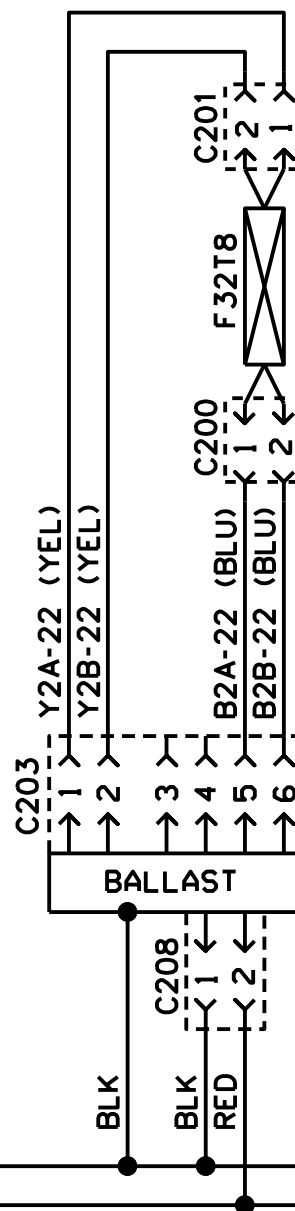
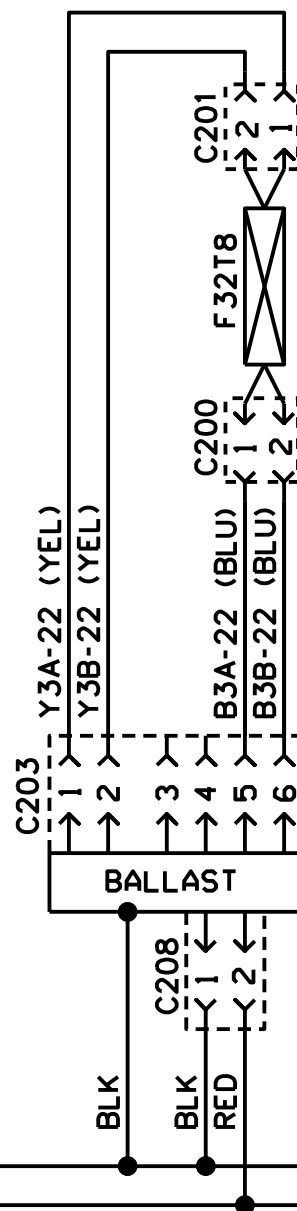
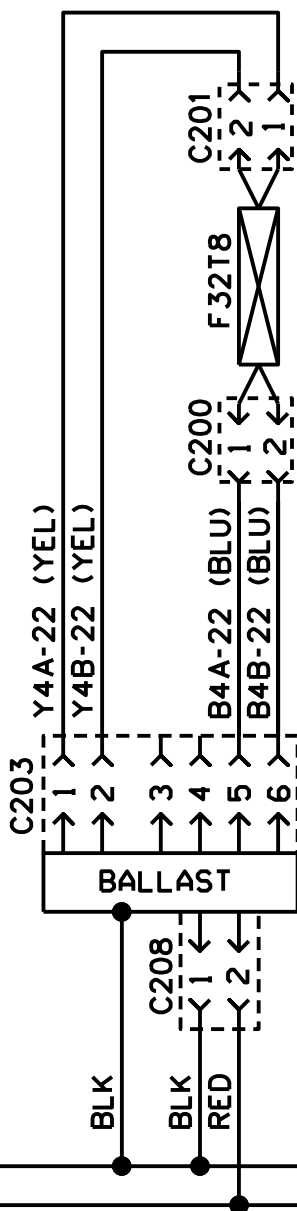
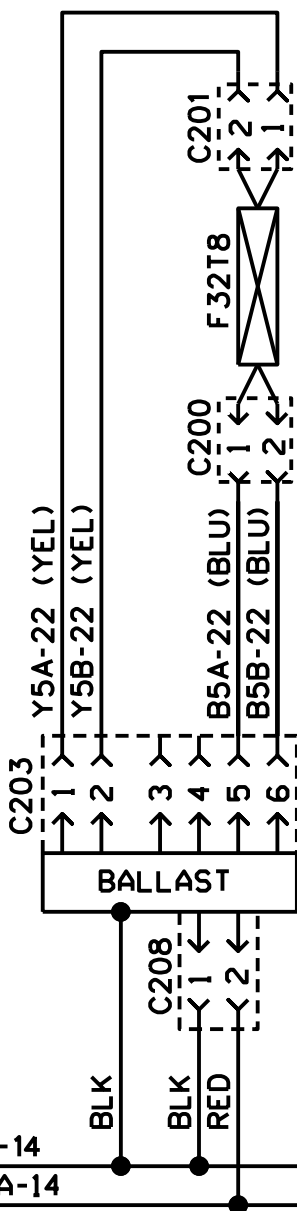
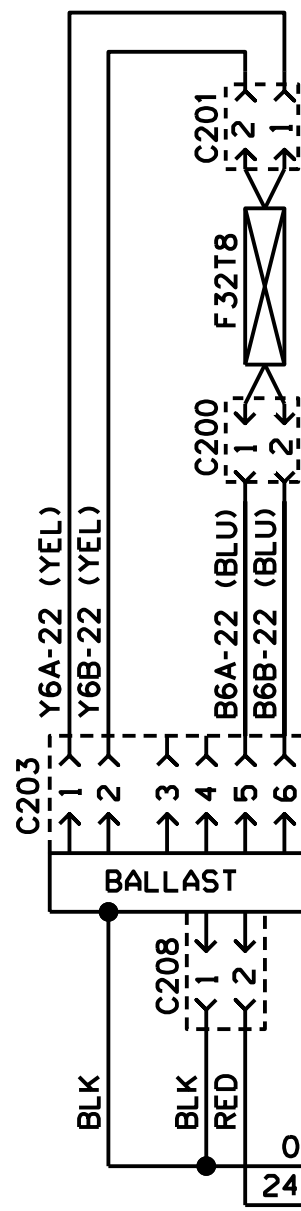

REAR R.H.

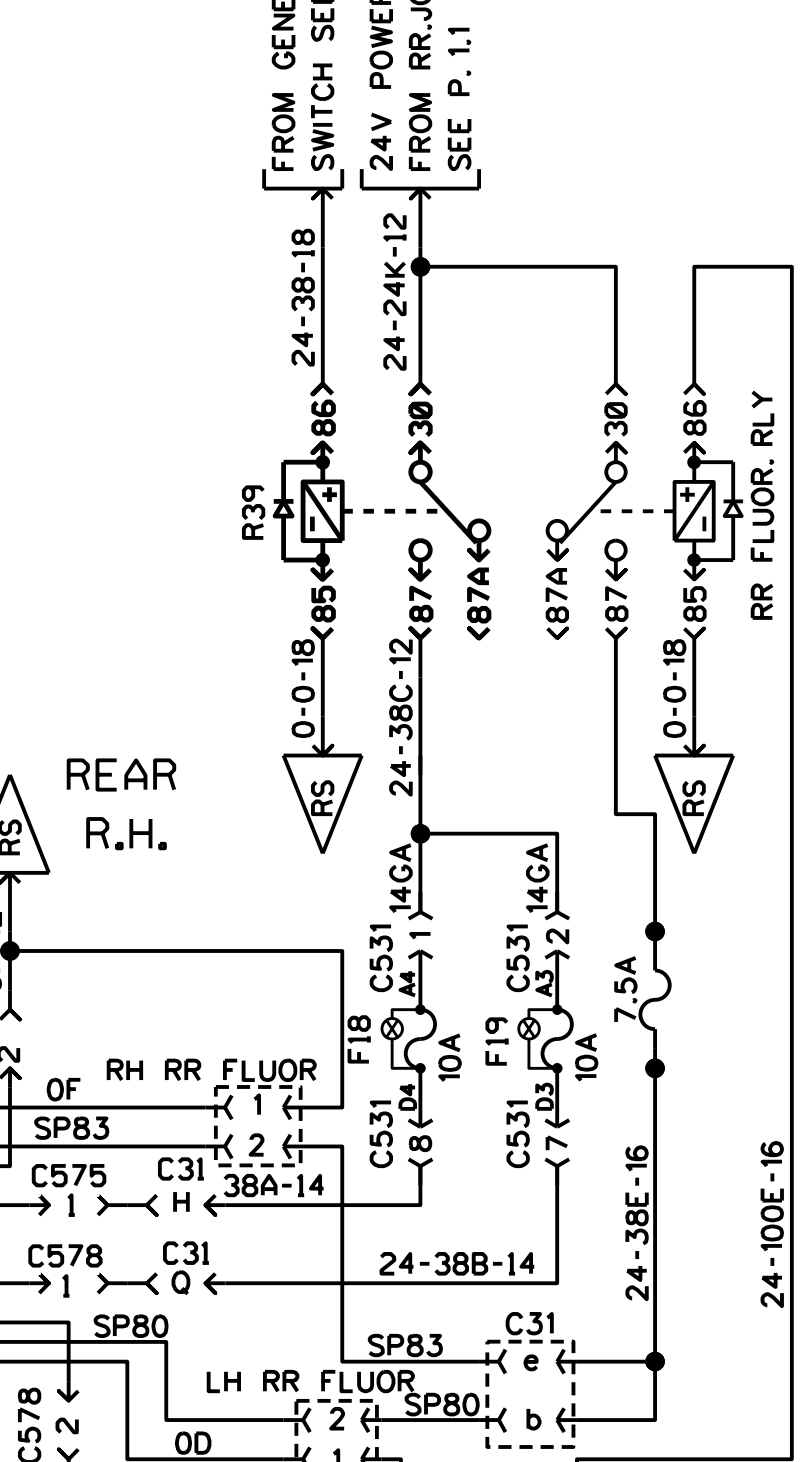

24V FLUORESCENT INTERIOR LIGHTING

LAST FLUOR. SW. (SPECIAL)