

# xantrex™

A MISSION CRITICAL ELECTRONICS BRAND

---



## Owner's Guide

### Solar MPPT Remote Panel

710-0010

---

Copyright © 2019 Xantrex LLC. All Rights Reserved.

All trademarks are owned by Xantrex LLC and its affiliates.

## **Exclusion for Documentation**

UNLESS SPECIFICALLY AGREED TO IN WRITING, SELLER (A) MAKES NO WARRANTY AS TO THE ACCURACY, SUFFICIENCY OR SUITABILITY OF ANY TECHNICAL OR OTHER INFORMATION PROVIDED IN ITS MANUALS OR OTHER DOCUMENTATION; (B) ASSUMES NO RESPONSIBILITY OR LIABILITY FOR LOSSES, DAMAGES, COSTS OR EXPENSES, WHETHER SPECIAL, DIRECT, INDIRECT, CONSEQUENTIAL OR INCIDENTAL, WHICH MIGHT ARISE OUT OF THE USE OF SUCH INFORMATION. THE USE OF ANY SUCH INFORMATION WILL BE ENTIRELY AT THE USER'S RISK; AND (C) REMINDS YOU THAT IF THIS MANUAL IS IN ANY LANGUAGE OTHER THAN ENGLISH, ALTHOUGH STEPS HAVE BEEN TAKEN TO MAINTAIN THE ACCURACY OF THE TRANSLATION, THE ACCURACY CANNOT BE GUARANTEED. APPROVED CONTENT IS CONTAINED WITH THE ENGLISH LANGUAGE VERSION WHICH IS POSTED AT <http://www.xantrex.com>.

**Document Number:** 975-1013-01-01      **Rev A Date:** Oct 2019

## **Product Name and Part Number**

Solar MPPT Remote Panel | 710-0010

## **Contact Information**

**Telephone:** +1-800-670-0707 / +1-408-987-6030

**Email:** [customerservice@xantrex.com](mailto:customerservice@xantrex.com),  
<http://www.xantrex.com/power-products-support/>

**Web:** <http://www.xantrex.com>

# IMPORTANT SAFETY INFORMATION

READ AND SAVE THIS OWNER'S GUIDE FOR FUTURE REFERENCE.

Read these instructions carefully and look at the equipment to become familiar with the device before installing, operating, configuring, maintaining, and troubleshooting it. The following special messages may appear throughout this documentation or on the equipment to warn of potential hazards or to call attention to information that clarifies or simplifies a procedure.



The addition of either symbol to a "Danger" or "Warning" safety label indicates that an electrical hazard exists which will result in personal injury if the instructions are not followed.



This is the safety alert symbol. It is used to alert you to potential personal injury hazards. Obey all safety messages that follow this symbol to avoid possible injury or death.

**Table 1 Abbreviations and acronyms**

AGM	Absorbent Glass Mat lead-acid battery
BTS	Battery Temperature Sensor
BMS	Battery Management System
LCD	Liquid Crystal Display
LFP, LiFePO <sub>4</sub>	Lithium-ion Iron Phosphate
MPPT	Maximum Power Point Tracking
PV	Photovoltaic
SOC	State-of-Charge

# Product Safety Information

1. Before using the remote panel, read all instructions and cautionary markings on the remote panel's components, the batteries, and all appropriate sections of this guide.
2. Use of accessories not recommended or sold by the manufacturer may result in injury to persons, a risk of electric shock, or a risk of fire.
3. The remote panel is designed to be connected to your DC electrical systems. The manufacturer recommends that all wiring be done by a certified PV technician or electrician to ensure adherence to the local and national electrical codes applicable in your jurisdiction.
4. To avoid a risk of fire and electric shock, make sure that existing wiring is in good condition and that wire is not undersized. Do not operate the remote panel with damaged or substandard wiring.
5. Do not operate the remote panel if it has been damaged in any way.
6. This remote panel does not have any user-serviceable parts. Do not disassemble the remote panel except where noted for connecting wiring and cabling. See your warranty for instructions on obtaining service. Attempting to service the remote panel yourself may result in a risk of electrical shock or fire.
7. To reduce the risk of electrical shock, disconnect all DC power sources from the remote panel before attempting any maintenance or cleaning or working on any components connected to the remote panel.
8. Do not expose the remote panel to rain, snow, or liquids of any type. This product is designed for dry-locations-use only. Damp environments will significantly shorten the life of this product and corrosion caused by dampness will not be covered by the product warranty.
9. To reduce the chance of short-circuits, always use insulated tools when installing or working with this equipment.

# DANGER

## **HAZARD OF FIRE, ELECTRICAL SHOCK, EXPLOSION, OR ARC FLASH**

This Xantrex SOLAR MPPT Remote Panel Owner's Guide is in addition to, and incorporates by reference, the relevant product manuals for each product in the power system. After reviewing this guide you must read the relevant product manuals. Unless specified, information on safety, specifications, installation, and operation is as shown in the primary documentation received with the product. Ensure you are familiar with that information before proceeding.

**Failure to follow these instructions will result in death or serious injury.**

# DANGER

## **ELECTRICAL SHOCK AND FIRE HAZARD**

Installation must be done by qualified personnel to ensure compliance with all applicable installation and electrical codes and regulations. Instructions for installing the Xantrex SOLAR MPPT Remote Panel are provided here for use by qualified personnel trained in Recreational Vehicle and Solar power systems.

**Failure to follow these instructions will result in death or serious injury.**

# CAUTION

## **EQUIPMENT DAMAGE**

Do not integrate this remote panel with a residential electrical system.

**Failure to follow these instructions can result in injury or equipment damage.**

# End of Life Disposal

The Xantrex SOLAR MPPT Remote Panel is designed with environmental awareness and sustainability in mind. At the end of its useful life, the remote panel can be decommissioned and disassembled. Components which can be recycled must be recycled and those that cannot be recycled must be disposed of according to local, regional, or national environmental regulations.

Many of the electrical components used in the Xantrex SOLAR MPPT Remote Panel are made of recyclable material like steel, copper, aluminum, and other alloys. These materials can be auctioned off to traditional scrap metal recycling companies who resell reusable scraps.

Electronic equipment such as the circuit boards, connectors, and fuses can be broken down and recycled by specialized recycling companies whose goal is to avoid having these components end up in the landfill.

For more information on disposal, contact Xantrex.

# Contents

Important Safety Information .....	3
Product Safety Information .....	4
End of Life Disposal .....	7
Materials List .....	9
Basic Installation Steps .....	9
Unit Features .....	12
Remote Panel LCD Display and Function Buttons .....	13
Status Icons .....	15
Event Indicators .....	17
Operation Using the Remote Panel .....	18
Automatic Status Display Screens .....	23
Specifications .....	24
Mounting Template .....	25



# Materials List

The remote panel base package includes the following items:

1	Xantrex SOLAR MPPT Remote Panel
2	Xantrex SOLAR MPPT Remote Panel bezel
2	Owner's Guide
3	Mounting screws (#4 x 3/8" wood screws)

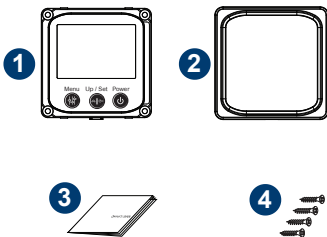

**NOTE:** If any of the items are missing, contact Xantrex or any authorized Xantrex dealer for replacement. See *Contact Information on page 1*.

## Basic Installation Steps

1. Prepare the tools for installation.
  - #2 Phillips screwdriver
  - hole saw
  - pencil
  - power drill with bit set (see NOTE)
  - other tools such as wire stripper, cutter, crimper, wrench

Figure 1 Preparing for mounting

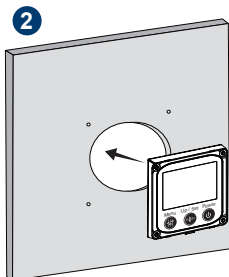
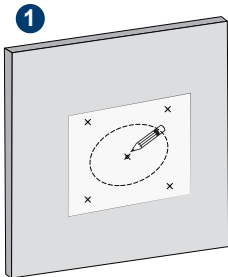

- |   |  |
|---|--|
| 1 | Using the mounting template at the end of this guide, mark the positions of the center hole and the mounting holes on the wall where you plan to mount the remote panel.                                       |
| 2 | Using a hole saw with a minimum diameter of 3" (76.2mm) and a maximum of 3.5" (88.9mm) and with the center hole marker, cut a circular hole on the wall. Insert the back of the remote panel through the hole. |

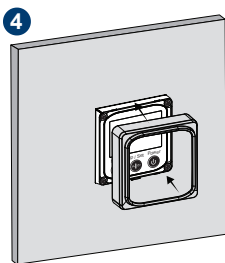
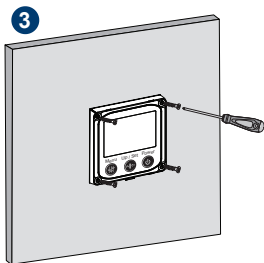

- |   |   |
|---|---|
| 3 | Using the provided mounting screws, secure the remote panel on the wall.<br><b>NOTE:</b> For drilling on hard wood use bit size 1/16 and on soft wood use bit size 3/64 |
| 4 | Attach the bezel to conceal the unit's mounting screws.   |

Figure 2 Wiring connections diagram

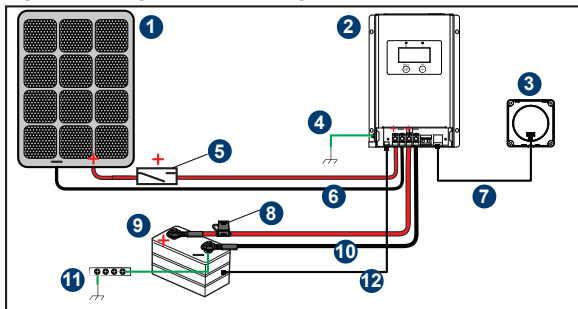

1	PV panel	7	Xantrex SOLAR MPPT Remote Panel cable
2	Solar charge controller	8	Pos [+] Battery cable with battery fuse
3	Xantrex SOLAR MPPT Remote Panel	9	Battery
4	DC equipment ground	10	Neg [-] Battery cable
5	Pos [+] PV cable with PV disconnect device	11	DC battery / Chassis ground
6	Neg [-] PV cable	12	Battery temperature sensor (BTS) cable

2. Install the power system. **IMPORTANT:** Follow the installation instructions for each component in the power system.
3. Mount the remote panel near other controller units in your power system for easy access.
4. Connect the cable connector to the port on the back of the remote panel.
5. Route the remote panel cable from its mounting location to the charge controller unit.
6. Connect the cable connector to the remote panel port on the charge controller unit.

# Unit Features

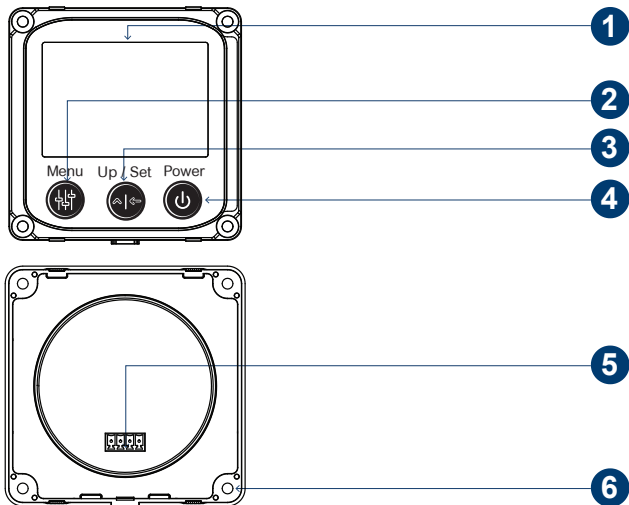



1	LCD display
2	MENU button
3	UP / SET button
4	Power [Standby] button
5	Remote port
6	Mounting holes



















# Remote Panel LCD Display and Function Buttons







Button	Action	Description
<p>Menu</p> 	Short press	<p>Allows you to:</p> <ul style="list-style-type: none"> <li>• browse devices such as BAT1, PV, and BAT2</li> <li>• browse settings for each device</li> <li>• show automatic status display setting</li> </ul>

Button	Action	Description
Up / Set 	Short press	Allows you to: <ul style="list-style-type: none"> <li>• browse PV Array settings</li> <li>• browse BAT1 settings</li> <li>• browse BAT2 settings</li> </ul>
	Long press (5 sec)	<ul style="list-style-type: none"> <li>• configure the temperature unit</li> <li>• configure the battery type</li> <li>• en/disable automatic status display</li> </ul>
Power 	Short press	Turn on the Remote panel screen
	Long press (5 sec)	Turn off the Remote panel screen

# Status Icons









Icon	Description	Icon	Description
	BAT1 SOC 0~12%		BAT2 SOC 0~12%
	BAT1 SOC 13~35%		BAT2 SOC 13~35%
	BAT1 SOC 36~61%		BAT2 SOC 36~61%
	BAT1 SOC 62~86%		BAT2 SOC 62~86%
	BAT1 SOC 87~100%		BAT2 SOC 87~100%
	BAT1 Charging		BAT2 Charging
	Daytime		Nighttime
	Display BAT1 parameters		Display BAT2 parameters
	PV Panel		Display PV parameters

Icon	Description	Icon	Description
	BAT1 temperature	<b>Batt Type</b>	Battery type
	Settings (Parameters)	<b>Min</b>	Minimum voltage
	Auto screen cycle	<b>Max</b>	Maximum voltage
	Event		





# Event Indicators

**NOTE:** When an event is detected the LED indicators flash and the individual icons on the LCD Display also flash.

LCD Icon/s	Event Description
	Over-charging event on BAT1
	Over-charging event on BAT2
	BAT1 discharged
	BAT2 discharged
	Over-temperature event on BAT1
	BAT1 charging voltage outside of range
	BAT2 charging voltage outside of range
	BAT1 and/or BAT2 batteries are not connected. PV is connected.





# Operation Using the Remote Panel

To browse different devices and their settings:





1. Short press  to turn on the panel.
2. Press  repeatedly to display each device screen.
3. Short press  to turn off the panel screen.

**NOTE:** Pressing this button does not turn off the solar charger unit, only the display panel screen.

*Table 2 Device screen*









LCD Icon	Device
	Remote panel's automatic status display
	BAT1 settings
	PV array settings
	BAT2 settings

## To enable automatic status display:









1. Short press  to turn on the panel, if not already on.
2. Press  once to display *RUt α*.
3. Press and hold  for 5 seconds until  appears. After 2 seconds each device setting will be displayed in sequence every 2 seconds. See *Automatic Status Display Screens on page 23*.

**NOTE:** Pressing  subsequently will disable automatic status display. To enable it again, perform step 3 again.







## To change the temperature unit setting:

1. Short press  to turn on the panel, if not already on.
2. Press  repeatedly until the BAT1  device screen is displayed.
3. Press  repeatedly until the temperature, the  icon, and the  icon are displayed.
4. Press and hold  for 5 seconds until the temperature value changes and flashes to *dE9C* (or *dE9F*).
5. Press  to browse the desired temperature unit (*dE9C* or *dE9F*), then press  to confirm your selection.















## To change the battery type setting:

1. Short press  to turn on the panel, if not already on.
2. Press  repeatedly until the BAT1  (or BAT2  ) device screen is displayed.
3. Press  repeatedly until the current battery type, the **Batt Type** icon, and the  icon are displayed.
4. Press and hold  for 5 seconds until the current battery type flashes.
5. Press  to browse the desired battery type (for more on battery types, see your charge controller's owner's guide), then press  to confirm your selection.

## To reset the PV Harvest:

1. Short press  to turn on the panel, if not already on.
2. Press  repeatedly until the PV  device screen is displayed.
3. Press  repeatedly until the cumulative PV Harvest status screen  is displayed.
4. Simultaneously, press and hold   buttons for 5 seconds until the PV Harvest value is reset to **0WH**.

# Automatic Status Display Screens

 <p>start</p>		
Shows input PV voltage.	Shows input PV current.	Shows input PV power.
		
Shows cumulative PV Harvest in watt-hours.	Shows battery 1 (BAT1) voltage.	Shows BAT1 current.
		
Shows BAT1 maximum voltage.	Shows BAT1 minimum voltage.	Shows BAT1 battery temperature.
		
Shows BAT1 Battery type.	Shows battery 2 (BAT2) voltage.	Shows BAT2 current.
		starting screen
Shows BAT2 maximum voltage.	Shows BAT2 minimum voltage.	

# Specifications

**NOTE:** Specifications are subject to change without prior notice.

<b>Specifications</b>	<b>Solar MPPT Remote Panel</b>
<b>Part number</b>	710-0010
<b>Power consumption</b>	10mA/5VDC
<b>Minimum power consumption</b>	3mA
<b>Operating temperature</b>	-20 – 70 °C (-4 – 158 °F)
<b>Storage temperature</b>	-20 – 70 °C (-4 – 158 °F)
<b>IP protection</b>	IP20
<b>Unit weight</b>	110 g (0.25 lbs.)
<b>Physical dimensions</b>	98 × 98 mm (3.8 × 3.8 inches)



# Mounting Template

**NOTE:** You may tear the next page.

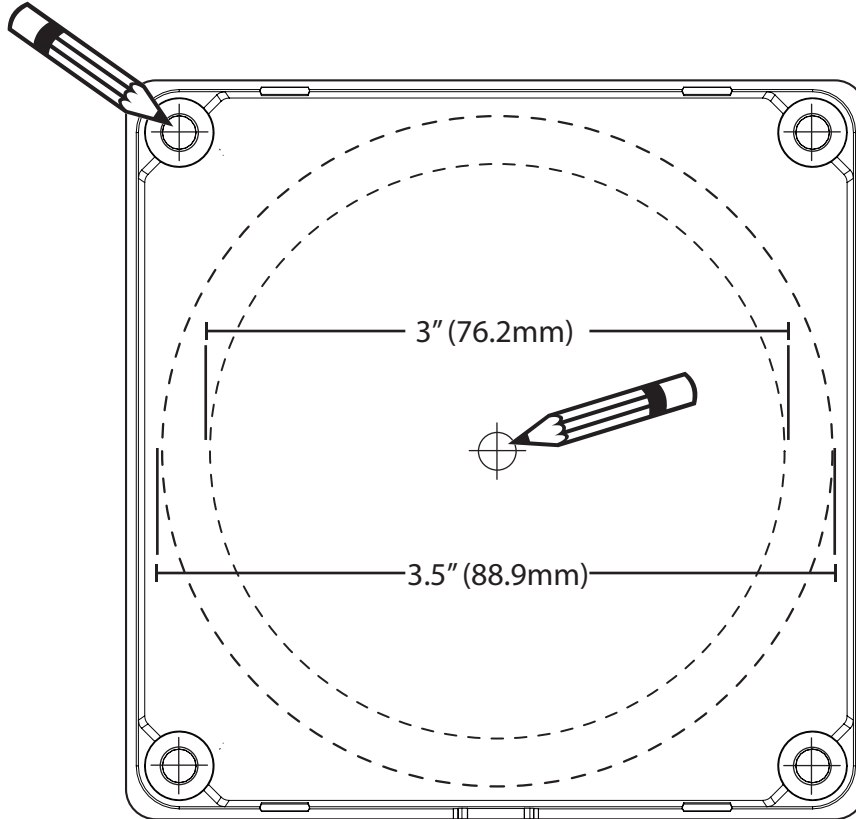

**NOTE:** Mark the positions of the center hole and the mounting holes on the wall where you plan to mount the remote panel. Use a hole saw with a minimum diameter of 3" (76.2mm) and a maximum of 3.5" (88.9mm) to cut a circular hole on the wall.



This page has no content.

# xantrex™ SOLAR



+1-800-670-0707

+1-408-987-6030



customerservice@xantrex.com

<http://www.xantrex.com/power-products-support/>



<http://www.xantrex.com>