



Hand-Held Tool

System configuration and communication with the tire sensor



User manual



Hand-held tool

Contents

1	General.....	7
1.1	Information on this user manual	7
1.2	Liability disclaimer	7
1.3	Copyright.....	7
1.4	Abbreviations.....	8
1.5	Explanation of symbols.....	9
1.6	Warnings	10
1.7	Manufacturer's address.....	10
1.8	Warranty terms	11
1.9	After-sales service	11
1.9.1	Eliminating errors.....	11
1.9.2	Updates.....	11
2	Safety.....	12
2.1	General safety instructions	12
2.2	Particular hazards.....	13
2.2.1	Electric shock hazard	13
2.2.2	Danger in potentially explosive areas	13
2.2.3	Danger when using hazardous goods transporters	14
2.3	Spare parts and accessories	15
2.4	Intended use.....	15
2.5	Foreseeable misuse.....	16
3	Technical data.....	17
4	Description.....	19
4.1	Description of functions	19
4.2	Tool overview.....	20
4.2.1	Control elements.....	20
4.2.2	Underside.....	21
4.2.3	Connections.....	22
4.2.4	Slot for SD memory card.....	22
4.3	Menu structure.....	23

Table of Contents

4.4	Menu control	25
4.4.1	Calling a menu function	25
4.4.2	Changing a selection	25
4.4.3	Scroll symbol	25
4.4.4	Dynamic help.....	26
4.5	Type plate	27
5	Commissioning	28
5.1	Checking contents and packaging.....	28
5.2	Charging the hand-held tool	29
5.2.1	Charging state display	30
5.3	Change the memory card	31
5.4	Switch the hand-held tool ON/OFF	33
5.5	Setting up the hand-held tool.....	34
6	Operation.....	37
6.1	General instructions	37
6.2	Handling the hand-held tool.....	37
6.2.1	Reading an accessible sensor.....	38
6.2.1.1	Problem when reading - communication failed	38
6.2.1.2	Problem when reading - other sensor in range	39
6.2.2	Fetching a sensor fitted in the tire.....	39
6.2.2.1	Problem when fetching - 2 different sensors.....	40
6.3	Screen displays	41
6.4	Tire Sensor menu	44
6.4.1	Check sensor	45
6.4.2	Activate Sensor	47
6.4.3	Deactivate Sensor	48
6.4.4	Actions on Tire.....	49
6.4.4.1	Select axle configuration.....	49
6.4.4.2	Fetching tire sensors	50
6.4.4.3	Communicating with the sensors.....	51

6.4.5	Check all tires	53
6.4.5.1	Enter vehicle names	54
6.4.5.2	Select vehicle configuration	55
6.4.5.3	Read/fetch tire sensors.....	56
6.4.5.4	Display the tire sensor data.....	58
6.4.6	Sniffing Tool.....	59
6.4.7	Trigger Tool	60
6.5	Initialization of the CPC system when reinstalling	62
6.5.1	Enter vehicle names.....	63
6.5.2	Select vehicle configuration.....	64
6.5.2.1	Special case "Married".....	71
6.5.2.2	Automatic Trailer Learning with Surrounding Observer.....	72
6.5.2.3	Automatic Trailer Learning + Position.....	74
6.5.3	Define axle-specific characteristics	75
6.5.3.1	Nominal pressure.....	75
6.5.3.2	Lift axle	76
6.5.4	Fetching tire sensors.....	78
6.5.5	Transfer of the configuration to the CPC system	80
6.5.6	Log file	82
6.5.7	Possible problems.....	83
6.5.7.1	Sensor not found after 2 attempts.....	83
6.5.7.2	2 Different sensors found simultaneously	85
6.5.7.3	Sensors not activated	86
6.5.7.4	Further termination criteria during the fetching process.....	87
6.5.7.5	Configuration transfer not possible	88
6.5.7.6	Transferred configuration not accepted	89
6.6	Resume initialization	90
6.6.7.1	Identification name belongs to vehicle	90
6.6.7.2	Identification name does not belong to vehicle.....	90

Table of Contents

6.7	Test drive.....	91
6.7.1	Truck/Bus test drive, MARRIED or Mining / Harbor.....	93
6.7.2	Trailer test drive.....	98
6.7.3	Possible error codes during test drives.....	101
6.7.3.1	Warnings.....	101
6.7.3.2	No CAN data.....	102
6.7.3.3	Timeout.....	103
6.7.3.4	Failed.....	104
6.7.3.5	Pressure control indicator.....	106
6.8	Modify Installation.....	107
6.8.1	Modify existing installation.....	108
6.8.1.1	Checking the installation.....	109
6.8.1.2	Modify Parameters.....	110
6.8.1.3	Modify Sensor IDs.....	112
6.9	Deactivate/activate ContiPressureCheck system.....	113
6.9.1	Deactivate CPC.....	113
6.9.2	Activate CPC.....	114
6.10	Diagnosis.....	115
6.10.1	DTCs (error codes).....	115
6.10.1.1	Read general error codes (DTCs).....	118
6.10.1.2	Read tire-relevant error codes (DTCs).....	125
6.10.1.3	Erase all error codes (DTCs).....	130
6.10.1.4	Save error codes (DTCs).....	131
6.10.2	Software updates.....	132
6.10.2.1	Available software on the hand-held tool.....	133
6.10.2.2	Truck/Bus, married or Mining / Harbor.....	134
6.10.2.3	Trailer.....	136
6.10.2.4	Errors during a software update.....	138
6.10.3	CAN check.....	139
6.10.3.1	Basic mode.....	139
6.10.3.2	Expert mode.....	140

7	SD memory card.....	141
7.1	General instructions on the SD memory card	141
7.2	Handling data on the SD memory card.....	142
7.3	Directory structure.....	143
7.4	Log files.....	143
8	Maintenance.....	145
8.1	Software Update for the hand-held tool.....	145
8.2	Connection to the PC.....	146
8.3	Replacing the fuse in the diagnosis cable	148
8.4	Cleaning.....	149
8.5	Storage.....	149
9	Troubleshooting	149
9.1	Resetting	149
10	Disposal	150
10.1	Electrical/electronic components	150
11	EC Declaration of Conformity	150
12	Homologation.....	151
12.1	Overview	151
12.2	Canada	151
13	Index	152

1 General

1.1 Information on this user manual

This user manual is part of the TPM-02 hand-held tool and provides important instructions on the intended use, safety, startup and operation of the hand-held tool.

The user manual must be read and utilized by every person who operates this hand-held tool and troubleshoots the hand-held tool.

Inform the subsequent owner of the hand-held tool of this manual.

1.2 Liability disclaimer

The manufacturer assumes no liability for damage and operational faults resulting from:

- failure to observe this user manual,
- use for other than the intended purpose,
- improper repairs,
- unauthorized modifications or
- use of non-approved spare parts

1.3 Copyright

This user manual is copyrighted.

The user manual may not be duplicated in whole or in part for other purposes without the express permission of Continental Reifen Deutschland GmbH.





1.4 Abbreviations

The following abbreviations are used in this user manual:

Abbreviation:	Meaning
ADR	European convention on international carriage of dangerous goods by road (Accord européen relatif au transport international des marchandises Dangereuses par Route)
ATL	Automatic Trailer Learning
CCU	Central Control Unit
CPC	ContiPressureCheckTM
CSW	CAN switch - switching module (integrated into the CCU trailer)
DSP	Display
DTC	Diagnostic Trouble Code
HHT	Hand-Held-Tool
RX	Add. Receiver
SO	Surrounding Observer



1.5 Explanation of symbols

Warnings in this user manual are also indicated by warning symbols. The following warning symbols are used in this user manual:

Symbol	Meaning
	General warning
	Warning of electric current
	General instructions and useful suggestions on handling
	Note on observing environmental regulations for disposal
	Electric/electronic components with this symbol may not be disposed of in the normal household waste.

1.6 Warnings

In the current user manual, the following warnings are used:

	<p style="text-align: center;">▲ WARNING</p> <p>A warning of this hazard level indicates a hazardous situation.</p> <p>If the hazardous situation is not avoided, it can result in serious injuries.</p> <ul style="list-style-type: none">▶ Follow the instructions in this warning to avoid serious injuries to persons.
	<p style="text-align: center;">ATTENTION</p> <p>A warning of this category indicates potential danger to property.</p> <p>If the situation is not avoided, it may lead to damage to property.</p> <ul style="list-style-type: none">▶ Follow the instructions in this warning to avoid damage to property.
	<p style="text-align: center;">NOTE</p> <ul style="list-style-type: none">▶ A note contains additional information that is important for further processing or for simplifying the procedure step explained.

1.7 Manufacturer's address

Continental Reifen Deutschland GmbH

Büttnerstraße 25

30165 Hannover

Germany

www.contipressurecheck.com

1.8 Warranty terms

The statutory warranty terms apply, with the exception of possible contractual agreements.

Please refer to the General Terms and Conditions for further information.

1.9 After-sales service

1.9.1 Eliminating errors

	NOTE
	▶ If the handling instructions in this user manual do not lead to the elimination of the fault, contact the after-sales service of the respective country.

All necessary information can be obtained from:
www.contipressurecheck.com

1.9.2 Updates

The current version of this user manual and further information can be obtained from
www.contipressurecheck.com/downloads

Further information on the topic of Conti PressureCheck can be obtained at:
www.contipressurecheck.com

2 Safety

2.1 General safety instructions

Observe the following general safety instructions to ensure safe handling of the hand-held tool:

- Check all parts of the hand-held tool for visible damage before use. Do not use a damaged hand-held tool.
- Do not allow the hand-held tool to fall down or subject it to hard knocks.
- With the exception of the slot for the SD memory card, do not open the hand-held tool. There are no maintenance-relevant parts inside the hand-held tool.
- The rechargeable battery of the hand-held tool can not be replaced.
- Only allow the manufacturer to repair the hand-held tool. Improper repairs or opening the tool will invalidate the guarantee.
- Protect the hand-held tool against humidity or penetration of liquids or objects. If the tool comes into contact with liquids, disconnect it from the power supply immediately.

2.2 Particular hazards

2.2.1 Electric shock hazard

	⚠ WARNING
	<p>Danger to life from electric current! Contact with live wires or components can lead to serious injury or even death!</p> <ul style="list-style-type: none">▶ Only use the power adapter supplied otherwise the hand-held tool could be damaged.▶ Do not use the hand-held tool if the connecting cable or the housing or the power adapter is damaged.▶ Never open the housing of the power adapter. Danger from electric shock if live connections are touched and/or the electrical and mechanical configuration is changed.▶ Never immerse the hand-held tool or the mains plug into water or other liquids.

2.2.2 Danger in potentially explosive areas

	⚠ WARNING
	<p>Risk of explosion! If the hand-held reader is used in locations with explosive gases and/or gas mixtures, in particular at petrol stations, there is a risk of explosion.</p> <ul style="list-style-type: none">▶ Do not use the hand-held reader in hazardous areas under any circumstances.

2.2.3 Danger when using hazardous goods transporters

	⚠ WARNING
	<p>Hazardous goods!</p> <p>Various hazards when using the hand-held reader in the vicinity of dangerous goods/transporters (e.g., risk of explosion).</p> <p>The hand-held reader may be used on vehicles for the transport of dangerous goods (ADR) under the following conditions:</p> <ul style="list-style-type: none">▶ Inside the driver's cabin▶ Outside the driver's cabin, when<ul style="list-style-type: none">- the vehicle is stationaryand- no hazardous goods are loaded or unloaded. <p>The following instructions must also be observed:</p> <ul style="list-style-type: none">▶ The hand-held reader may not come into contact with hazardous material.▶ The safety instructions for transported hazardous goods must be observed.

2.3 Spare parts and accessories

	ATTENTION
	<p>Damage and malfunctions due to incorrect spare parts and accessories.</p> <p>The hand-held tool or vehicle components can be damaged or malfunction if wrong or non-original spare parts are used.</p> <ul style="list-style-type: none">▶ Use original parts only.▶ Only use the original diagnosis cable for transferring data between the hand-held tool and the CPC system otherwise data transfer errors can occur.

2.4 Intended use

The hand-held tool is intended to be used only

- for communicating with and setting the tire sensors,
- for reading the pressure and temperature values,
- for setting up/adjusting the CPC system on the vehicle,
- for checking the system performance,
- for error diagnostics,
- for transferring data between the PC and the hand-held tool,
- updating the software and
- for testing the CAN connection of the CPC system with the vehicle bus.

Use for any other purpose is not considered as intended use.

No claims of any kind will be accepted for damage resulting from use of the appliance for other than its intended purpose.

In such cases, the risk must be borne solely by the user.

2.5 Foreseeable misuse

	⚠ WARNING
	<p>Danger resulting from improper use!</p> <p>If used for other than its intended purpose, the hand-held tool can be a source of danger and cause damage to equipment.</p> <p>▶ Use the hand-held tool only for its intended purpose.</p>

Any use for a purpose other than that specified in the section „**2.4 Intended use**“ on page 15 is considered improper and is therefore not permitted.

For example, misuse is when

- the information in this manual is not observed,
- the limits specified in the technical data are not complied with
- the hand-held tool is operated in a modified or faulty condition
- the hand-held tool is used in a potentially explosive zone,
- not observing the safety instructions given in the section „**2.2 Particular hazards**“ on page 13 .

3 Technical data

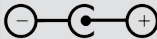
Hand-held tool		
Dimensions (L x W x H)	160 x 90 x 38	mm
Weight	325	g
Weight of the electronic components	292	g
Display	3-inch 128 x 64 pixel monochrome graphic LCD with backlighting	
Degree of protection	IP 54	
Power pack	Lithium-ion rechargeable battery 800 mAh / 11.1 V	
Operating temperature	-10 to 50 14 to 122	°C °F
Storage temperature	-20 to 25 -4 to 77	°C °F
Connections		
USB 2.0 (PC)	Type A	
Diagnostic cable	Hirose, 24-pole	
Power adapter connection	Barrel connector, 1.3/3.5 mm 	
Memory card		
Card type	SD card	
Max. capacity	32 GB (scope of supply 8 GB)	

High-frequency part		
HF frequency range	433.92 MHz	
HF transmission power	Reception only	
Low frequency part		
LF frequency range	126.304 kHz	
LF transmission power	24.52 dBuA/m @ 180%	
Number of plugging cycles, min.		
USB plug	1,000	cycles
Diagnosis plug	100	
Power adapter plug	10,000	
Power adapter		
Type	Sinpro SPU 15-106	
Input	90 ... 264 VAC / 47 ... 63 Hz	
Output	13 V - 16 V / max. 0.94 A - 1.15 A	

4 Description

4.1 Description of functions

The TPM-02 hand-held tool is a configuration and diagnostics device with the following functions:

- Tire sensor check,
- Tire pressure and temperature measuring,
- Tire sensor activation/deactivation,
- New Installation on the vehicle/trailer,
- Checking and changing the existing configuration,
- Checking the system performance (test drive),
- Reading of error codes (DTCs),
- Updating firmware for the display (DSP), CCU and switching module (CSW),
- Logging vehicle and setting data,
- Communication between the PC and the hand-held tool.
- Testing the CAN connection of the CPC system with the vehicle bus.

4.2 Tool overview

4.2.1 Control elements

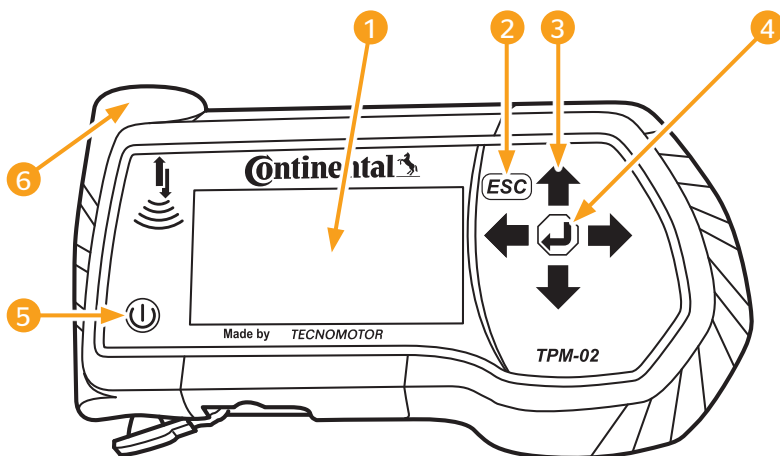

Pos	Designation	Task
1	Screen	Menu display.
2	ESC key	Exit a sub-menu. Scroll back in some menus.
		Press the ESC key for 3 s. = cancel an action.
3	Arrow keys	Navigate within a menu. Setup values
4	Return key	Confirm selection. Acknowledge a message. Exit dynamic help.
5	ON/OFF key	Switch the hand-held tool ON/OFF.
6	Antenna	Antenna for responding to the tire sensors.

4.2.2 Underside

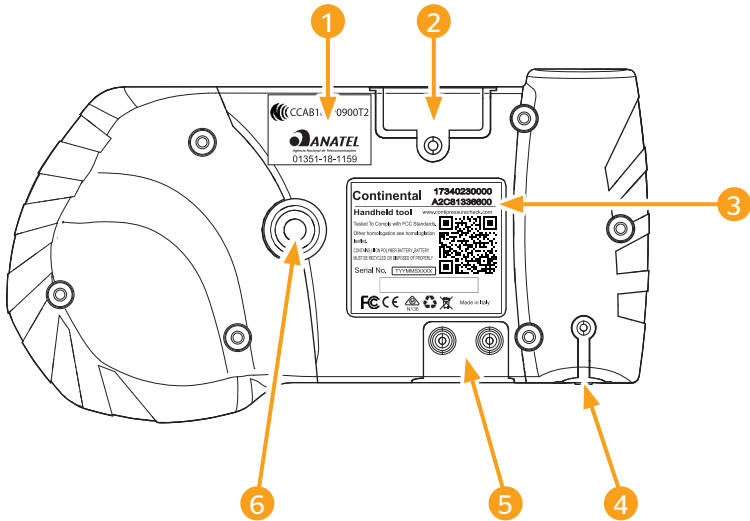

Pos	Designation
1	Additional homology label
2	Slot for SD memory card
3	Type plate
4	Cover for power adapter connection sockets
5	Cover for USB and diagnosis cable connection sockets
6	Fixing for carrying strap* (not included in the scope of supply)

4.2.3 Connections

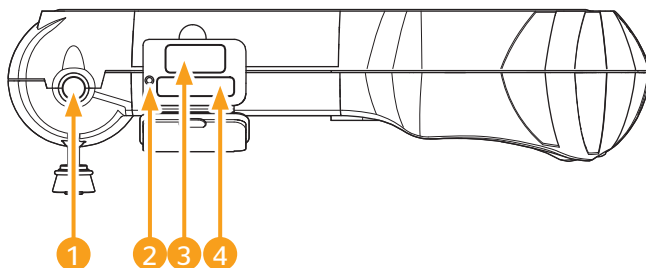

Pos	Designation
①	Connection for power adapter
②	Internal reset button
③	Connection for USB cable
④	Connection for diagnosis cable

4.2.4 Slot for SD memory card

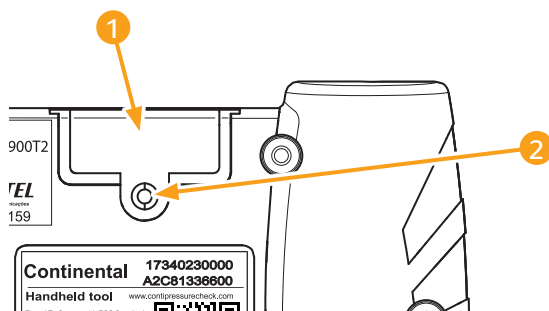

Pos	Designation
①	Cover for SD memory card slot
②	Fixing screw for cover

4.3 Menu structure

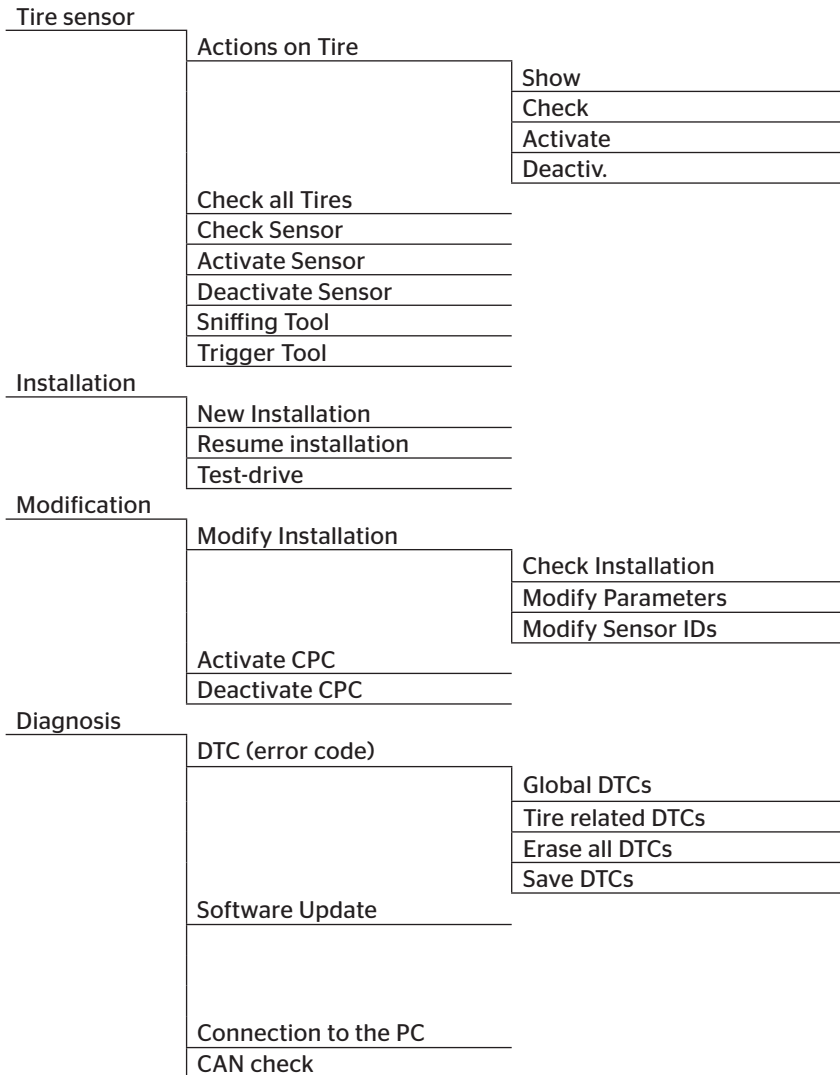





Setup

Language	Česky / Czech
	Dansk / Danish
	Deutsch / German
	English / English
	Español / Spanish
	Français / French
	Italiano / Italian
	Magyar / Hungarian
	Nederlands / Dutch
	Norske / Norwegian
	Polski / Polish
	Português / Portuguese
	Româna / Rumanian
	Slovenský / Slovak
	Soumi / Finnish
Svenskt / Swedish	
Türkçe / Turkish	
Meas. Unit	Pressure
	Temperature
Sound set.	Sound
	Vibration
Tool Properties	Auto power-off
	Date/time
	Use date
Configuration	Startup settings
	Help
	REDI sensor
	Nominal pressure
Release	

4.4 Menu control

Operating the hand-held tool takes place menu-driven via the keys of the tool. The following lists the possible operating steps:



4.4.1 Calling a menu function

- ◆ Use the arrow keys \uparrow \downarrow to select the desired menu item.
- ◆ Confirm selection with the Return key  and call up the menu item.
- ◆ If the menu includes submenus, use the arrow keys \uparrow \downarrow to select the desired menu item and confirm selection with the Return key .
- ◆ Press the ESC key  to return to the previous menu level.
- ◆ Press the ESC key  for 3 s to cancel an action.

4.4.2 Changing a selection

- ◆ Use the arrow keys \leftarrow \rightarrow to select between the settings/options.
- ◆ Confirm selection with the Return key .

4.4.3 Scroll symbol

If the space on the screen is not sufficient to display all entries, a scroll symbol  or  on the right-hand side. All entries can be called with the arrow keys \uparrow \downarrow .

4.4.4 Dynamic help

The so-called dynamic aids appear in some submenus after a specified time has elapsed. These provide helpful information on parameters or settings in the respective menu automatically.

- ◆ The dynamic help can be exited with the return and ESC keys.
- ◆ This function can be switched off or on and a desired time can be set via the "**Settings/Configuration/Help**" menu path.

4.5 Type plate

The type plate is located on the underside of the tool.

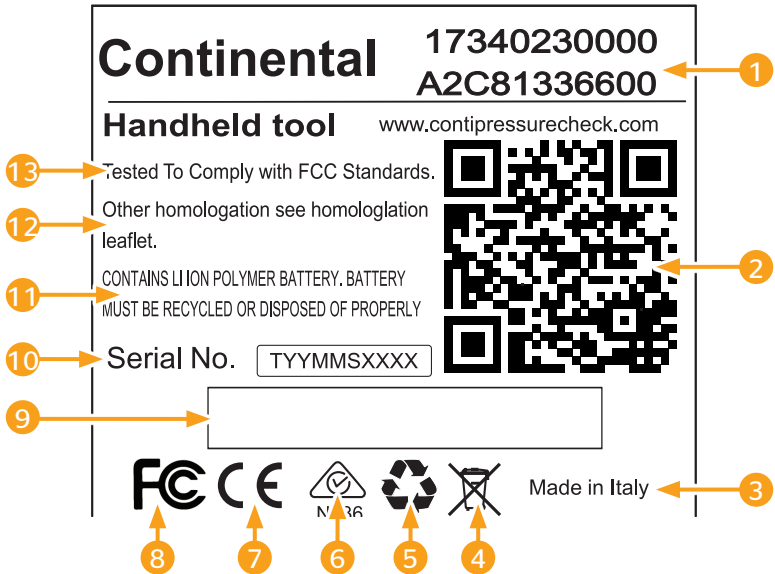

Pos	Meaning
1	Article number
2	Homologation marking according to FCC
3	Country of origin
4	Do not dispose of in the household garbage
5	Contains materials that can be recycled
6	Note on the Homologation marking, Australia
7	Note on CE conformity in the European Union
8	Note on compliance with FCC standards
9	Barcode
10	Serial number
11	Contains lithium-polymer rechargeable battery. The battery must be recycled or be disposed of properly.
12	See homologation leaflet for further homologation
13	Homologation marking according to FCC

5 Commissioning

5.1 Checking contents and packaging



As standard, the hand-held tool is supplied with the following components:

- Hand-held tool (incl. 8 GB SD memory card)
- Diagnosis cable
- USB cable
- Power adapter
- 4 power adapters EU (European Union), UL (USA), UK (England), AU (Australia)
- 2 replacement fuses for the diagnosis cable
- Transport case
- Brief instructions
- Homologation supplement (art. no. 17340480000)
- Test reports
- Declaration of Conformity

	NOTE
	▶ Check for visible signs of damage or missing items on delivery. Report an incomplete or damaged delivery to your supplier/retailer immediately.



5.2 Charging the hand-held tool

- ◆ Switch on the hand-held tool.
- ◆ Remove the cover for the connection socket of the power adapter.
- ◆ Connect the connecting cable of the power adapter and plug the power adapter into a mains socket.
- ◆ After approx. 10 seconds, the tool switches itself off automatically and a charging symbol  is displayed on the screen.



	NOTE
	▶ If the charging symbol  is not displayed during charging, the tool is not being charged sufficiently.

	NOTE
	<ul style="list-style-type: none">▶ Only use the power adapter supplied.▶ The charging process takes approx. 7 hours.▶ Before using the hand-held tool for the first time, charge the tool for at least 7 hours according to the charging instructions.▶ Charge the hand-held tool once a month for at least 7 hours.▶ For accreditation reasons, the hand-held tool may not be operated when the mains adapter is connected.

5.2.1 Charging state display

- If the hand-held tool is running on battery power, the charging state is displayed by a battery symbol  in the top right corner of the screen. The level indicated on the battery symbol corresponds to the charging state of the rechargeable batteries .

NOTE	
	<ul style="list-style-type: none">▶ The "Low clock battery" warning appears when the hand-held tool is switched on, if the hand-held tool has not been charged for a longer period of time. The date and time must therefore be set again.

- The charging symbol  appears on the display when charging via the mains adapter.
- When the battery is fully charged, the text "100%" appears instead of the charging symbol .

5.3 Change the memory card

The files required for updating the firmware of the display, CCU and the switching module (CSW) are stored on the SD memory card built into the hand-held tool.

The data for the system languages is also stored on the SD memory card serves as storage location for the log files created by the hand-held tool.

	NOTE
	<ul style="list-style-type: none"><li data-bbox="374 443 1006 496">▶ An SD memory card is supplied with the hand-held tool by default.<li data-bbox="374 507 1006 647">▶ For communicating with the SD memory card, the hand-held tool is connected to the PC/Laptop via a USB cable, see section „8.2 Connection to the PC“ on page 146. The SD memory card remains in the hand-held tool.<li data-bbox="374 659 1006 745">▶ Do not erase or modify the data on the memory card as this leads to malfunctions or even total failure of the hand-held tool.<li data-bbox="374 756 1006 809">▶ The log files are an exception! These can be erased without influencing the system.

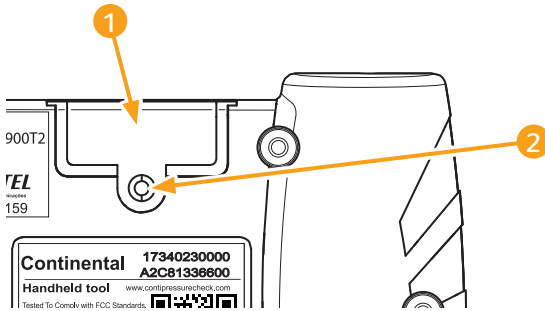



To replace the SD memory card if it is defective, proceed as follows:

- ◆ Loosen the fixing screw **2** of the cover **1** and remove it.
- ◆ Push the card lightly to release the locking mechanism of the memory card.
- ◆ Change the memory card. Pay attention to proper location of the contacts when inserting.
- ◆ Push in the memory card until it snaps in.
- ◆ Replace the cover **1** and tighten the fixing screw **2**.

NOTE	
	<ul style="list-style-type: none"> ▶ Reinstall the current software on the hand-held reader to set up the new SD memory card. ▶ The latest hand-held reader software for setting up a new SD memory card can be found on the Internet page <i>www.contipressurecheck.com/hht</i>.

5.4 Switch the hand-held tool ON/OFF

Press the ON/OFF key  to switch the hand-held tool.

Pressing the  key again for approx. 3 seconds switches the hand-held tool off.

	NOTE
	<ul style="list-style-type: none">▶ After switching on for the first time and after selecting the preferred language (menu path "SETUP/LANGUAGE"), the hand-held reader must be completely set up (see section „5.5 Setting up the hand-held tool“ on page 34).▶ The date and time display can be activated in the main menu under Setup- Tool Properties- Use Date.



5.5 Setting up the hand-held tool

Fundamental tool settings such as language, units etc. are determined in the **"Setup" menu**.

Menu item	Meaning	Selection	
Language	Operating language of the screen	Danish, German, English, Finnish, French, Italian, Dutch, Norwegian, Polish, Portuguese, Rumanian, Swedish, Slovak, Spanish, Czech, Turkish, Hungarian	
Meas. Unit	Unit for pressure and temperature	Pressure	bar/psi
		Temperature	°C/°F
Sound set.	Signal output as sound and/or vibration	Sound	On/off
		Vibration	On/off
Tool Properties	Time, after which the hand-held tool is switched off automatically.	Auto power-off	Off 5min 10min 15min
	System date and time	Data and time setting. Date format can be selected.	
	Use date	Use date and time (yes / no). – Display in the main menu – Use with log files	

Commissioning

Menu item	Meaning	Selection	
Configuration	Startup settings	Determines whether the settings should be displayed after each power-up.	On/off
	Help	Dynamic help pages appear after the set time has elapsed or are switched off.	Off/5 s/10 s
	REDI sensor	Processing REDI sensors.	On/off
Release	Information on the firmware	Display of the FW version and the serial number	

- ◆ Select the desired menu item with the arrow keys \updownarrow and confirm with the Return key .
- ◆ Navigate between the menu items with the arrow keys \updownarrow and change the values / settings with the arrow keys $\leftarrow \rightarrow$.
- ◆ Confirm selection with the Return key  or exit the menu with the ESC key **(ESC)**.
The selection is accepted and you are returned to the next highest level of the menu.
- ◆ All changes made are automatically saved when exiting the "**Settings**" menu with the ESC key **(ESC)**.

	NOTE
	<ul style="list-style-type: none"> ▶ The menu begins with the main setting in English. Select the desired language by following the menu path: "SETUP/LANGUAGE". ▶ If no SD memory card is inserted in the hand-held tool or it is defective, only "ENGLISH" is available. ▶ The "SETTINGS / CONFIGURATION / STARTUP SETTINGS" menu item can be used to set the desired start page. If the "Startup settings" option is configured with "ON", the language selection appears each time the hand-held reader is switched on, followed by the "Configuration" menu ▶ If the "REDI Sensor" option is set to "ON" in the "SETTINGS/CONFIGURATION", the information on the value changed from the factory settings will be displayed automatically each time the hand-held reader is switched on.

6 Operation

6.1 General instructions

For trouble-free operation, pay attention to the following instructions:

- Always operate the hand-held tool with fully-charged batteries so that full transmission power is ensured.
- Keep the cover of the hand-held tool closed so that not dirt particles or fluids can penetrate the hand-held tool.

6.2 Handling the hand-held tool

In order to communicate with the tire sensors, the hand-held tool is equipped with an antenna. The following describes the procedure for communication that is used in all menus.

	NOTE
	<ul style="list-style-type: none">▶ Always hold the antenna in the direction of the sensor in order to ensure the best possible communication.▶ If sound and/or vibration was switched on during set-up, a corresponding signal is emitted after successful reading.▶ The read operation takes place via 3 steps with increasing transmission power. If communication beyond that is still not possible, the process is aborted.

6.2.1 Reading an accessible sensor

In the event that the sensor is easily accessible, proceed as follows for reading:

- ◆ Hold the hand-held tool with antenna  directly in front of the sensor as illustrated.

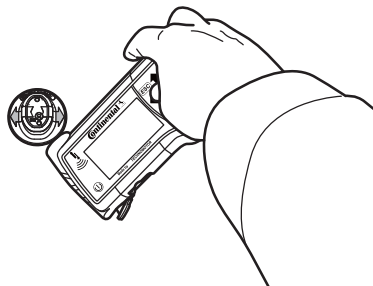

6.2.1.1 Problem when reading - communication failed

If communication with the sensor is not possible, the following message appears:

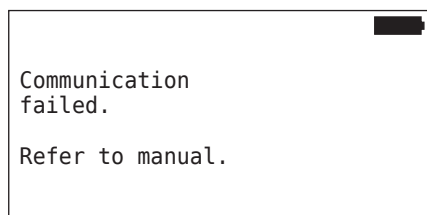

Remedy:

1. Check the charging state of the hand-held tool and charge if necessary.
2. Repeat the procedure with another tire sensor.
 - ▶ If communication is possible, the 1st tire sensor is defective.
 - ▶ If communication is still not possible, contact after-sales service.

6.2.1.2 Problem when reading - other sensor in range

If a further sensor is within radio range, the sensor to be checked cannot be safely read.

The following appears:

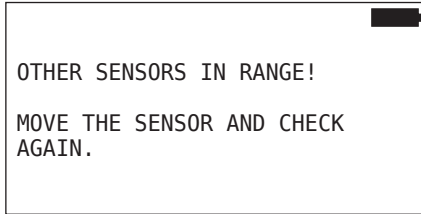

Remedy:

- ◆ Put the sensor out of range of the other sensors or sources of interference.

6.2.2 Fetching a sensor fitted in the tire

When fetching the tire sensors, the following is displayed:

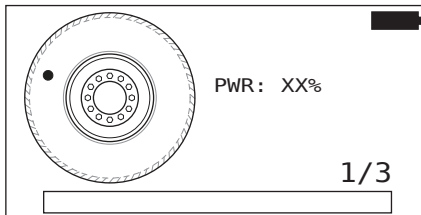

In the animation, the marker point moves along the side wall in a specified direction and at a specified speed.

	NOTE
	▶ The percentage indicates the current pending transmission power (PWR) of the query signal.

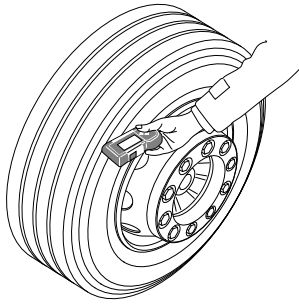

- ◆ Hold the hand-held tool with antenna  in front of the side wall of the tire as illustrated. The marker point is the starting point.



- ◆ Move the hand-held tool along the side wall of the tire at the same speed of the animation.

The hand-held tool transmits the query signals at 3 transmission power levels. The levels are represented on the screen.

- ◆ Move the hand-held tool along the side wall around the whole circumference of the tire once for each power level.

	NOTE
	<ul style="list-style-type: none"> ▶ The mark  must be aligned vertically to the side wall and the antenna below the tread when moving. ▶ Pay attention to the location of the starting point and the direction of rotation in the animation.

6.2.2.1 Problem when fetching - 2 different sensors

If the hand-held tool reaches 2 different sensors, the following message appears:

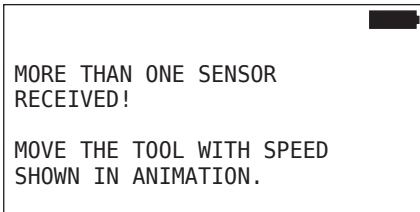

- ◆ Repeat the fetching procedure for this tire.

6.3 Screen displays

Vehicle depiction:

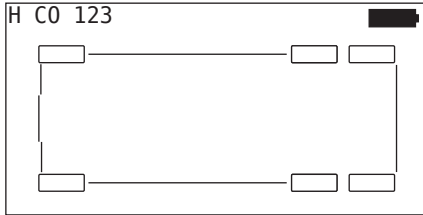

Shows the vehicle configuration from the top.

	NOTE
	<p>► If the option is selected for more than 6 axes, the 7th and 8th axes are displayed on a second page. The second page can be called up by pressing the right arrow key on the 6th axis. It is indicated by an arrow symbol ➔ on the right side of the screen.</p>



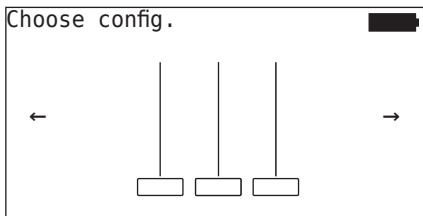



Axle depiction:



Shows the axle/tire configuration at a part of the vehicle.



Tire depiction:

To visualize the tire sensor data, the color and the content of the tire symbol changes.

Illustration	Meaning
	Existing tires.
	Fetched sensor with data: <ol style="list-style-type: none"> 1. Tire pressure. or 2. number of telegrams or RSSI (see „6.7 Test drive“ on page 91).
	Faulty sensor. Show details on faults: <ul style="list-style-type: none"> ■ Select tire with the corresponding arrow keys. (tire marked with "[]"). ■ Confirm selection with the Return key . (for possible faults, see chart in section „6.4.1 Check sensor“ on page 45)
	Fetched, deactivated sensor (shipping mode)
	Sensor not found.
	The tires are shown in this way when <ul style="list-style-type: none"> ■ the focus is on the axle. ■ a tire has already been fetched (this can be the case if the teach-in process is interrupted or sensor IDs are modified).

A tire symbol marked with "[]" is focused in the menu.

To visualize additional information in the case of error codes (DTC), the tire symbol could be displayed inverted or flashing.

Illustration	Meaning
	The following applies when indicating errors:
	Symbol is flashing: active DTCs pending. Symbol not flashing: passive DTCs pending. (see „6.10.1.2 Read tire-relevant error codes (DTCs)“ on page 125)

6.4 Tire Sensor menu

Sensors can be checked, activated and deactivated in "**Tire sensor**" menu. Tire-related sensors can be queried for a specific vehicle under the submenu items "Actions on Tire" and "Check all Tires". Furthermore, the surroundings of the hand-held tool can be checked for existing sensors and what power transmission level of the query signal is required for them to respond.

6.4.1 Check sensor

Tire sensor - Check Sensor

- ◆ Read sensor as described in section „6.2.1 Reading an accessible sensor“ on page 38.

The following is displayed on the screen:

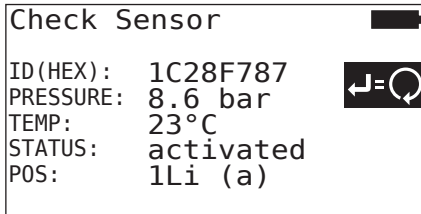

Field	Meaning	
ID (hex)	Identification number of the sensor.	
PRES-SURE	Tire pressure (in a dismantled state, 0 bar/0 psi).	
TEMP	Temperature in the tire.	
STATE	Enabled = park mode	Sensor is at idle. A telegram is transmitted every 2 minutes.
	Disabled = shipping mode	Sensor only transmits telegrams when specifically queried.
	START Mode	Beginning at a speed of approx. 30 km/h (18 mph), a telegram is transmitted 40-times every 16 seconds. DRIVE Mode follows.
	DRIVE Mode	Sensor is moving. A telegram is transmitted every 2 minutes.
POS	Tire position on trailer	Tire position for the ATL + Position function (Example: 1Li - 1st axle on the inside left)

The following error messages are possible:

Fault	Meaning
Sensor DEFECTIVE	The tire sensor is no longer operational. Replace with a new sensor.
LOW Battery	The capacity of the battery in the tire sensor is no longer sufficient for continued use. Replace with a new tire sensor.
Sensor is LOOSE	It is possible that the tire module has become loose in the tire or was mounted head over heels. If this error occurs in the case of a tire sensor, it is no longer operational and must be replaced by a new sensor.
ACC > 5 g < -5 g	If this error occurs when the tire sensor is not in motion, it is no longer operational and must be replaced by a new sensor.

	NOTE
	<p>▶ If the  is displayed on the screen, the test procedure can be repeated by pressing the Return key .</p>

6.4.2 Activate Sensor

By default, the sensor is deactivated and does not transmit any telegrams automatically. In order to be able to operate the sensor at the vehicle, it must be activated.

Tire Sensor - Activate Sensor

- ◆ Read sensor as described in section „**6.2.1 Reading an accessible sensor**“ on page 38.

The following is displayed on the screen:

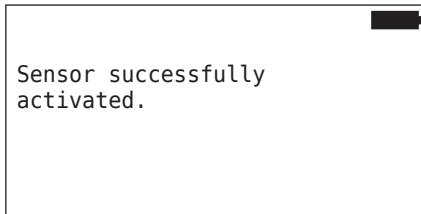

The following messages appears after 3 seconds:

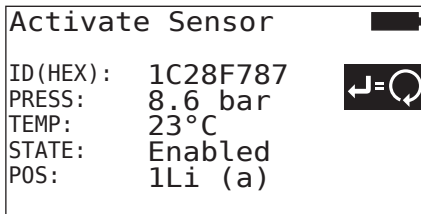

6.4.3 Deactivate Sensor

The sensor must be deactivated for longer periods of storage or for shipping.

Tire Sensor - Deactivate Sensor

- ◆ Read sensor as described in section „**6.2.1 Reading an accessible sensor**“ on page 38.

The following is displayed on the screen:

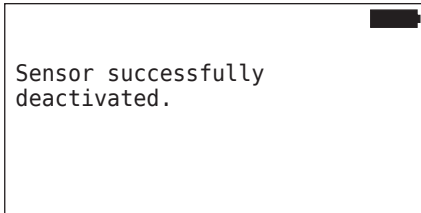

The following messages appears after 3 seconds:

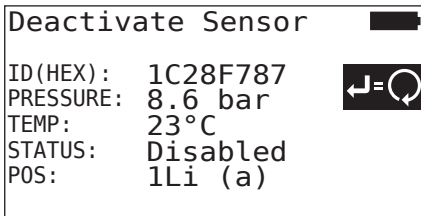

NOTE

- ▶ If the sensor is in a "Disabled" state, it is in "shipping mode" and no longer transmits telegrams automatically.
- ▶ The tire sensor must be deactivated for transport in an airplane.

6.4.4 Actions on Tire

For tire-related query/operation of sensors installed in a vehicle, the sensors with their associated tires must be fetched first.

Tire sensor - Actions on Tire

Querying the tires takes place in 4 steps:

1. Query whether the vehicle type is "Mining / Harbor".
2. Selection of the axle configuration.
3. Fetching the tire sensors.
4. Specific communication with the tire sensors.

	NOTE
	► Tires not fitted with sensors on "Mining / Harbor" vehicle types can only be skipped with the ESC key.

6.4.4.1 Select axle configuration

The following is displayed on the screen:

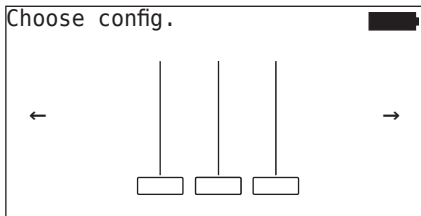

- ◆ Move between the axle configurations with the arrow keys ← →.
- ◆ Confirm selection with the Return key .

6.4.4.2 Fetching tire sensors

Now each individual sensor can be fetched. The current tire to be fetched is marked on the screen by "[]":

The following is displayed on the screen:

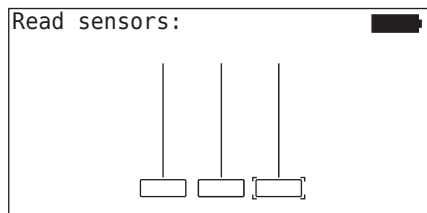

- ◆ Read the sensor with the hand-held tool as described in the section **„6.2.2 Fetching a sensor fitted in the tire“ on page 39.**

When the sensor is found in the marked tire, the tire pressure at the time of fetching tire is displayed in the tire symbol and the next tire to be fetched is displayed.

Fetch all tires as specified on the screen. The following message appears for the last tire to be fetched:

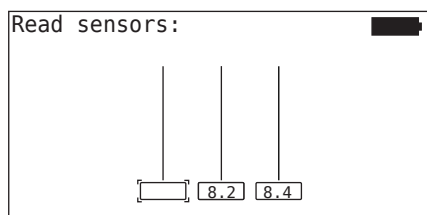

When the fetching procedure including the last tire is completed, the individual sensors can be addressed specifically.

	NOTE
	<ul style="list-style-type: none"> ▶ Remedy possible errors during fetching of the tire sensors as described in the sections 6.5.7.1, 6.5.7.2, 6.5.7.3 and 6.5.7.4. ▶ If a sensor is not acquired, fetching will be aborted. Fetching will continued for the next tire.

6.4.4.3 Communicating with the sensors

For specific communication with the tire sensors:

- ◆ Use the arrow keys ← → to navigate between the tires.
- ◆ Use the arrow keys ↑ ↓ to navigate between the 4 menu items.
- ◆ Execute the selected action by pressing the Return key (↵).

The following is displayed on the screen:

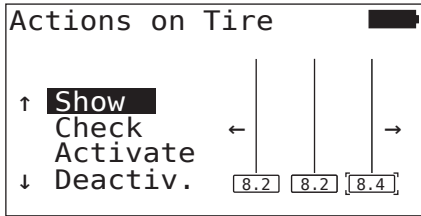

Menu item	Meaning
SHOW	Shows the previously read sensor data for 15 seconds. Data output as in section „6.4.1 Check sensor“ on page 45
CHECK	Query the tire sensor again and to show the current sensor data for 15 seconds. Data output as in section „6.4.1 Check sensor“ on page 45
ACTIVATE	Activates the selected sensor. Corresponds to the function in section „6.4.2 Activate Sensor“ on page 47.
DEACTIV.	Deactivates the selected sensor. Corresponds to the function in section „6.4.3 Deactivate Sensor“ on page 48.

- ◆ To exit the "Actions on Tire" menu, press the ESC key **ESC** for 3 seconds.

The following screen appears.

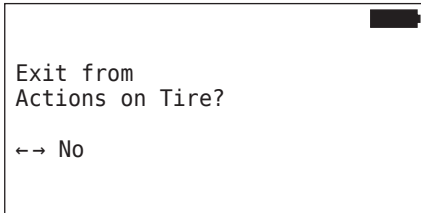

- ◆ Select "Yes" with the arrow keys ← → and confirm with the Return key .

6.4.5 Check all tires

This menu item is used to create and change a vehicle configuration in the ContiConnect web portal. It can also be used to query sensor data for vehicles without their own CCU and display. The entire vehicle configuration must be fetched.

Tire sensor - Check all Tires

Querying the tires takes place in 5 steps:





1. Name of the vehicle
2. Selection of the vehicle configuration
3. Read/fetch the tire sensors
4. Create a log file
5. If required: display details of the sensor data

6.4.5.1 Enter vehicle names

The vehicle name serves to identify the vehicle and the associated configuration. The vehicle name is stored in the log file.

See also „7.4 Log files“ on page 143.

VEHICLE NAME													
<input type="text" value="—"/>													
1	2	3	4	5	6	7	8	9	0	←			
Q	W	E	R	T	Y	U	I	O	P				
A	S	D	F	G	H	J	K	L					
Z	X	C	V	B	N	M	↵	OK					

- ◆ Use the arrow keys   to select the numbers and letters.
- ◆ Confirm selection with the Return key .
- ◆ Select "OK" and confirm with the Return key  when the vehicle name is complete.

	NOTE
	<ul style="list-style-type: none"> ▶ 19 characters - max. length of the vehicle name. ▶ If an individual name is not entered, "NO VEHICLE NAME" is used as vehicle name. ▶ As an example for this description, "H CO 123" was used as the vehicle name.

6.4.5.2 Select vehicle configuration

Characteristic	Meaning	Selection
Vehicle type	Type of vehicle	Truck/bus
		Trailer
		Mining / Harbor
Number of axles	The selection options depend on the vehicle type.	1-8 (trailer 1-6)

When selection is complete, the birds-eye-view of a possible vehicle appears:

- ◆ Select the axle to be changed with the arrow keys ← →.
- ◆ Change the tire configuration of the respective axle with the arrow keys ↑ ↓.

	NOTE
	▶ If more than six axes are selected, the seventh and eighth axes are on the second side, indicated by an arrow symbol → on the right side of the screen.

6.4.5.3 Read/fetch tire sensors

Now each individual sensor can be read/fetched. The current tire to be fetched is marked on the screen by "[]":

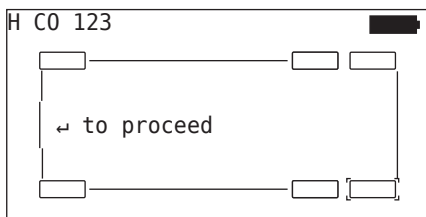

- ◆ Take the hand-held tool and go to the marked tire on the vehicle.
- ◆ Start the fetching process by pressing the Return key (↵).

An animation of the fetching process appears on the screen:

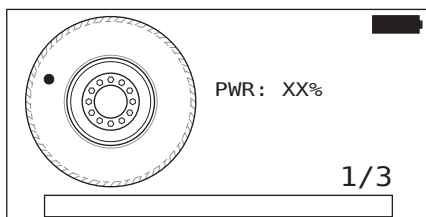

- ◆ Read the sensor with the hand-held tool as described in the section „6.2.2 Fetching a sensor fitted in the tire“ on page 39.

	NOTE
	<ul style="list-style-type: none"> ▶ Pay attention to the starting point and the direction of rotation in the animation. ▶ Tires not fitted with sensors can be skipped with the ESC key (ESC). These are shown in the bird's eye view with a crossed out box.

Fetches tires are illustrated as in section „6.3 Screen displays“ on page 41.

	NOTE
	<ul style="list-style-type: none">▶ Remedy possible errors during fetching of the tire sensors as described in the sections 6.5.7.1, 6.5.7.2, 6.5.7.3 and 6.5.7.4.▶ If a sensor is not acquired, fetching will be aborted. Fetching will continued for the next tire.

After completion of reading/*fetching*, a log file is created automatically and stored to the SD memory card. See also section „**7.4 Log files**“ on **page 143**“.

The following is displayed on the screen:

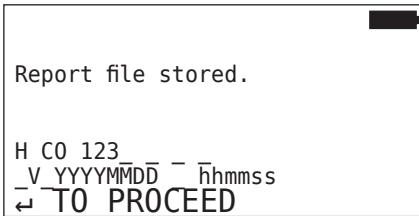



- ◆ Exit display of the log file with the Return key .

The overall view of the vehicle appears on the screen.

6.4.5.4 Display the tire sensor data

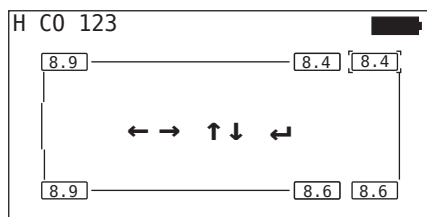
Now any tire sensor can be selected.





- ◆ Select the desired tire sensor with the arrow keys .
- ◆ Confirm selection of the tire sensor with the Return key .

The data of the selected tire sensor is displayed. See section „**6.4.1 Check sensor**“ on page 45.

To return to the overall view of the vehicle:

- ◆ Press the Return button  or the ESC key **(ESC)**.
- ◆ Returning to the overall view takes place automatically after 15 seconds.

To exit the menu item:

- ◆ Press the ESC key **(ESC)** for 3 seconds.
- ◆ When prompted to exit the menu item, use the arrow keys   and press the Return key  and confirm with "Yes".

6.4.6 Sniffing Tool

For identification of all sensors within the transmitting/receiving range of the hand-held tool, data can be collected via the "Sniffing Tool" menu.

The sensors transmit:

- Identification number of the sensor (hex)
- Pressure (bar or psi)
- Temperature (°C or °F)

The header of the screen displays further information:

- Number of telegrams received

This menu item can be used to identify sensors that are unintentionally located within the work area.

Tire sensor - Sniffing Tool

The following is displayed on the screen:

	5	█
1C451F3D	0.0	21
1C989F4D	8.6	20
1C46258E	8.6	20
1C498156	8.6	19
1C75483E	8.4	21

- ◆ Signal reception is stopped with the ESC key (**ESC**).

The following is displayed on the screen:

STOP	5	█
1C451F3D	0.0	21
1C989F4D	8.6	20
1C46258E	8.6	20
1C498156	8.6	19
1C75483E	8.4	21

- ◆ Confirming a second time with the ESC-Taste (**ESC**) cancels the "Sniffing Tool" function.

6.4.7 Trigger Tool

A signal with defined transmission power can be emitted to query the sensors surrounding the hand-held tool. The sensors in the radius of action of the signal responds with the following data:

- Identification number of the sensor (hex)
- Status of the sensor (hex)
- Specification of the duration between two response telegrams received (in ms).

The header of the screen displays further information:

- Transmission power of the querying signal as a percentage (%)
- Number of telegrams received

The trigger analysis is able to recognize the proportional transmission power required in order for the sensor to respond.

Tire sensor - Trigger Tool

The following is displayed on the screen:

Power	4%	15	
1C451F3D	Dh	40	
1C989F4D	9h	1690	
1C46258E	Dh	720	
1C498156	Dh	80	
1C75483E	9h	140	
1C468756	Dh	1230	
1C125F2E	Dh	20	

- ◆ The proportional transmission power of the querying signal can be increase or decreased with the arrow keys .

	NOTE
	▶ When starting the function, the proportional transmission power is 0% and must be increased as described.

	ATTENTION
	<p>Damage to equipment!</p> <p>The <MLF3> and <MLF5> function modes in the Trigger-Analysis menu are developer functions. Using these two modes is reserved for system developers. Improper use can lead to destruction of your CPC system.</p> <ul style="list-style-type: none">▶ The <MLF3> and <MLF5> functions should only be used by system developers.

- ◆ Querying is stopped and the function canceled with the ESC key **ESC**.

6.5 Initialization of the CPC system when reinstalling

	NOTE
	▶ Before initializing the system, make sure that all tire sensors are activated.

Initialization of the system takes place in 6 steps:

1. Name of the vehicle
2. Selection of the vehicle configuration
3. Definition of axle-specific characteristics
4. Fetching the tire sensors
5. Transfer of the configuration to the CPC system
6. Create a log file

	NOTE
	<ul style="list-style-type: none"> ▶ The installation process can be canceled at any time by pressing the ESC key (ESC) for 3 seconds. ▶ It is possible to resume the installation process from the point where it was aborted via the "Resume installation" menu item. See section „6.6 Resume initialization“ on page 90.



Installation - New Installation

	NOTE
	▶ By selecting the "Installation" item in the main menu, the charging state of the battery is checked. If this is not sufficient, the following message appears: "Low battery! Power ON the HHT to charge it." Charge the hand-held tool as described in the section „ 5.2 Charging the hand-held tool “ on page 29.

6.5.1 Enter vehicle names

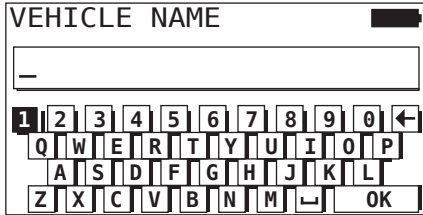
The vehicle name serves to identify the vehicle and the associated configuration. The vehicle name is stored in the CCU and in the log file. See also „7.4 Log files“ on page 143.



- ◆ Use the arrow keys  to select the numbers and letters.
- ◆ Confirm selection with the Return key .
- ◆ Select "OK" and confirm with the Return key  when the vehicle name is complete.

	NOTE
	<ul style="list-style-type: none">▶ 19 characters - max. length of the vehicle name.▶ If an individual name is not entered, "NO VEHICLE NAME" is used as vehicle name.▶ As an example for this description, "H CO 123" was used as the vehicle name.

6.5.2 Select vehicle configuration

The vehicle-specific parameters are configured after entering the vehicle name. The following table lists all parameters to be configured.

The number of parameters can contain more or fewer entries, depending on the selection of parameters. The corresponding arrows \updownarrow on the right side of the screen indicate if further parameters are available below or above the entries shown.

- The respective parameter can be selected with the arrow keys \updownarrow .
- The corresponding selection for a parameter can be changed by selecting the arrow keys $\leftarrow \rightarrow$.

	NOTE
	<p>The recommended default values for the warning thresholds are</p> <ul style="list-style-type: none"> ▶ 90% ("LOW PRESSURE") <p>and</p> <ul style="list-style-type: none"> ▶ 80% ("VERY LOW PRESSURE") of the nominal pressure.

	ATTENTION
	<p>Damage to equipment!</p> <p>Adjust the warning thresholds according to the area of application of the tires is at your own risk. The factory settings are for orientation only.</p> <ul style="list-style-type: none"> ▶ No liability is assumed for the correctness of the warning signal speeds.

Characteristic	Meaning	Selection	
Vehicle type	Type of vehicle	Truck/bus	
		Trailer	
		Married	
		Mining / Harbor	
Blink code	Blink code for the warning lamp on the trailer. (Selection only possible with selected vehicle type "Trailer")	EU	
		USA	
Number of axles >6?	Configuration whether the vehicle has more than 6 axles. Up to 8 axles can be configured depending on the type of vehicle. (Selection only possible with selected vehicle type "Truck/bus")	Yes	No
ATL (AutoTrailerLearning)	Automatic recognition of the newly-connected trailer with optional surrounding observer (SO). (Selection only possible with selected vehicle type "Truck/bus"). For further information, see the section „ 6.5.2.2 Automatic Trailer Learning with Surrounding Observer “ on page 72)	Yes	No

Characteristic	Meaning	Selection	
ATL + Position	Activates ATL including the position assignment of the tires on the trailer. Only possible for trailers with a maximum of 3 axles. (Selection only possible with selected vehicle type "Truck/bus"). For further information, see section 6.5.2.3)	Yes	No
ATL nominal pressure	Nominal pressure for trailer tires that are monitored with ATL.	1,8 ... 11,9 bar 26 ... 170 psi	
CAN Bus Format	CPC + J1939 format must be configured when using a CPC display or trailer lamp.	CPC + J1939	
	Only the "J1939" standard must be configured for integrating to the vehicle's CAN bus.	J1939	
Add. Receiver	Configuration of whether an additional receiver is installed on the vehicle. (Configuration is defined automatically when "ATL" or vehicle type "Married" is activated)	Yes	No
Low pressure	Warning threshold for low pressure. % value refers to the configured nominal pressure.	-3%...-15%	

Characteristic	Meaning	Selection	
Very low pressure	Warning threshold for severe low pressure. % value refers to the configured nominal pressure.	-13%...-25%	
Temperature	Defines the temperature threshold at which the CPC system displays a message. (Temperature inside the tire)	50...115°C 122...239°F	
Pressure diff.	Configuration of whether a warning should be generated if the pressure difference in twin tires exceeds a specified value. (Function is only possible when CAN Bus Format "CPC + J1939" is selected)	Yes	No
Warning lamps	For vehicles with J1939 CAN Bus only. Allows control of warning lights in the dashboard (RSL, AWL). (Selection only possible with selected vehicle type "Truck/bus") or "Married".)	Yes	No



	NOTE
	<p>For "ATL (AutoTrailerLearning)" characteristic.</p> <p>The CPC system automatically detects when a single tire with tire sensor is replaced.</p> <p>Also see: <i>ContiPressureCheck -Installation manual- section "Automatic Wheel Change Detection"</i>.</p> <p>► When selecting the ATL function, "Automatic Wheel Change Detection" is deactivated!</p>

	NOTE
	<p data-bbox="356 225 799 248">For ATL nominal pressure characteristic</p> <ul data-bbox="356 260 981 574" style="list-style-type: none"><li data-bbox="356 260 981 288">▶ Only one nominal pressure can be defined for all axles!<li data-bbox="356 300 981 352">▶ The nominal pressure applies to all newly-connected trailers!<li data-bbox="356 363 981 416">▶ The nominal pressure can be set between 1.8 bar (26 psi) and 11.9 bar (173 psi).<li data-bbox="356 427 981 512">▶ At a nominal pressure below 4.5 bar (65 psi) even small deviations in pressure can lead to a warning / alarm.<li data-bbox="356 523 981 574">▶ When determining the nominal pressure, consider the instructions from the tire manufacturer.

	NOTE
	<p data-bbox="356 679 981 818">Not all features and settings may be available when the CPC system is integrated into a third-party solution. Follow the third-party's instructions during installation. In particular, ATL with position is not supported by all third-party vendors, which may cause the function to fail.</p>

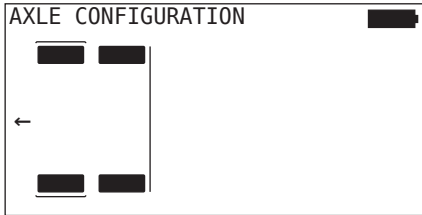
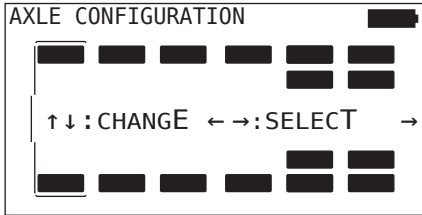
Different axle-tire configurations are possible depending on the vehicle type and configuration of the parameters.



- ◆ Change the tire configuration of the respective axle with the arrow keys .
- ◆ Select the axle to be changed with the arrow keys .
- ◆ Confirm configured selection with the Return key .

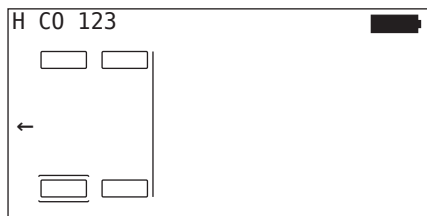
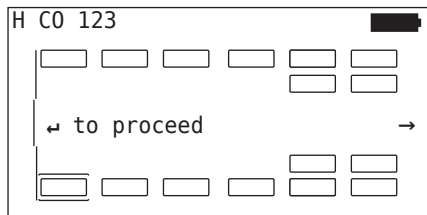

NOTE	
i	<ul style="list-style-type: none"> ▶ If more than six axes are selected, the seventh and eighth axes are on the second side, indicated by an arrow symbol → on the right side of the screen. The second page can be reached by pressing the right arrow key on the sixth axle. ▶ Depending on vehicle type, not all vehicle configurations are supported.

6.5.2.1 Special case "Married"

Select this vehicle type when the tire sensors of the trailer are to be received and indicated in the display of the CPC system of the truck.

The sensors of the trailer are permanently programmed into the CCU of the truck for this purpose.

An additional receiver is necessary for this vehicle type and is therefore automatically linked into the CPC configuration by the hand-held tool.



The trailer must be permanently married to the truck otherwise "NO SIGNAL" is displayed in the display for the trailer sensors (see Display in the user manual)

For the "Married" vehicle type, the number of axles for the respective truck and trailer is selected separately.

Altogether, it is not possible to select more than 8 axles.

In the special case "Married", the axle configurations for the truck and trailer are selected one after the other. First of all, the axles are configured on the truck and then the trailer is configured after pressing the RETURN key .

After configuring the axle for truck and trailer, the axle-specific properties are defined according to the same principle first for the truck and then for the trailer.

- ◆ Modify the selection with the arrow keys .
- ◆ Confirm selection with the Return key .

	NOTE
	<ul style="list-style-type: none">▶ The "ATL" function cannot be selected with this configuration.▶ "Automatic Wheel Change Detection" is active. Also see: <i>ContiPressureCheck -Installation manual- section "Automatic Wheel Change Detection"</i>.

6.5.2.2 Automatic Trailer Learning with Surrounding Observer

The Surrounding Observer (SO) is an additional option for Automatic Trailer Learning (ATL).

	NOTE
	<ul style="list-style-type: none"> ▶ The trailer monitor by means of ATL only works when the trailer is moved for at least 10 minutes at a speed of >30 km/h (19 mph). ▶ Warnings can only be displayed after completion of the automatic learning phase.

In order to be able to detect a tire with severe low pressure at the beginning of the journey, the Surrounding Observer (SO) at the CPC system can be activated using the hand-held tool. When ATL + SO and the CPC system is switched on, the surrounding observer evaluates all signals received from tire sensors and checks whether they have a severe low pressure.

The ATL function can be configured by the HHT in three different ways.

"NO" [ATL off]	>	The ATL and surrounding observer functions are switched off.
"ATL" [ATL on]	>	Only the ATL function is switched on.
"ATL + SO(D)"	>	The ATL function and the surrounding observer are switched on during the journey.
"ATL + SO(ST+D)"	>	The ATL function and the surrounding observer are switched on when stopped.

SO option	Meaning	Task
SO (D)	D = Driving	SO (D) displays all "VERY LOW PRESSURE" warnings received from moving vehicles, not from stationary vehicles.
SO (ST+D)	ST = Stopped + D = Driving	SO (D) displays all "VERY LOW PRESSURE" warnings received when the vehicle is stationary and when the vehicle is moving.

NOTE	
	<ul style="list-style-type: none">▶ The surrounding observer only displays the VERY LOW PRESSURE warning. All other warnings are only displayed when ATL is connected.▶ The "VERY LOW PRESSURE" warning from the surrounding observer may not come from the own trailer but can also come from the neighboring vehicle. However, the driver has the option in the event of a warning to check his own trailer for low pressure.

For further information, see user manual.

6.5.2.3 Automatic Trailer Learning + Position

The "**Automatic Trailer Learning**" function can be configured optionally with position detection.

Position detection allows the trailer to be displayed graphically with the respective tire positions after automatic trailer learning has been completed.

If the "**ATL + Position**" function is active, the sensors of the trailer(s) must be set up after configuring the CCU on the "**Truck/BUS**".

	NOTE
	<p>All trailers potentially connected to the "Truck/BUS" can be checked via the hand-held tool (firmware 7.00 or higher) using the "Check all Tires" function (see section „6.4.5 Check all tires“ on page 53).</p> <p>The respective position of the tire on the trailer is stored in the sensors following the function.</p>

6.5.3 Define axle-specific characteristics

6.5.3.1 Nominal pressure

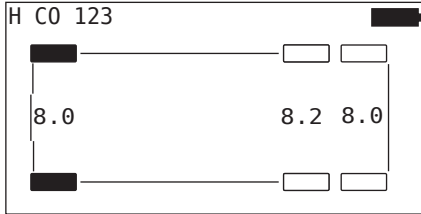

- ◆ Use the arrow keys \leftarrow \rightarrow to navigate between the axles.
- ◆ Set the required nominal pressure with the arrow keys \updownarrow .
- ◆ Confirm the set nominal pressures with the Return key .



NOTE

- ▶ The nominal pressure can be set between 1.8 bar (26 psi) and 11.9 bar (173 psi).
- ▶ At a nominal pressure below 4.5 bar (65 psi) even small deviations in pressure can lead to a warning / alarm.
- ▶ When determining the nominal pressure, consider the instructions from the tire manufacturer.

6.5.3.2 Lift axle

Depending on the vehicle type, an axle can also be defined as a lift axle.

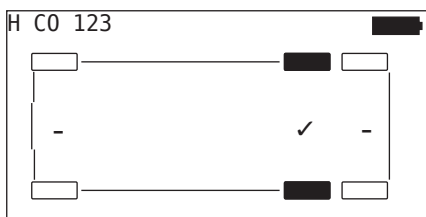

- ◆ Use the arrow keys ← → to navigate between the axles.
- ◆ Change the status with the arrow keys ↑ ↓:
 - „✓“ = lift axle
 - „-“ = no lift axle
- ◆ Confirm selection with the Return key ↵.

General conditions:

- If the selected configuration only has 2 axles (a truck or drawbar trailer) or only 1 axle (semitrailer), the page for determining the lift axle is not displayed.
- In the case of trucks or drawbar trailers, at least 2 axles may not be lift axles and in the case of the semitrailer only 1 axle.
- In the case of a truck or drawbar trailer, the 1st axle can not be set as lift axle.
- Altogether for each installation, a maximum of 2 axles can be set as lift axle (if the vehicle type is selected as "married", this is considered as one installation).





NOTE

- ▶ Lift axle setup must be made carefully.
- ▶ If the lift axles are wrongly determined, correct function of the CPC system cannot be ensured.
- ▶ If there are more than 2 lift axles on the vehicle, the two lift axles furthest away from the receiver must be specified as such in the HHT. Further lift axles must be configured as "normal" axles without lift function. This configuration may result in unjustified "Sensor not found" false warnings on the nonconfigured lift axle.

6.5.4 Fetching tire sensors

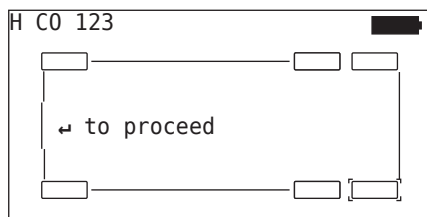
Now each individual sensor can be fetched. The current tire to be fetched is marked on the screen by "[]":



- ◆ Take the hand-held tool and go to the marked tire on the vehicle.
- ◆ Start the fetching process by pressing the Return key .

An animation of the fetching process appears on the screen:

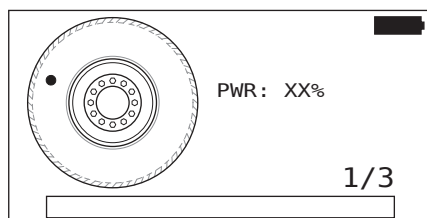

- ◆ Read the sensor with the hand-held tool as described in the section **„6.2.2 Fetching a sensor fitted in the tire“ on page 39.**
- ◆ The respective tire position is written to the sensor after the sensor has been read. This information is necessary for the use of the "ATL + POS" function (necessary to see the section **„6.5.2 Select vehicle configuration“ on page 64).**

	NOTE
	▶ Pay attention to the starting point and the direction of rotation in the animation.

Operation

When the sensor in the marked tire is found, the tire symbol changes and the entry is displayed with the detected tire pressure.

The next tire to be fetched is displayed.

Fetch all tires as specified on the screen. The following message appears for the last tire to be fetched:

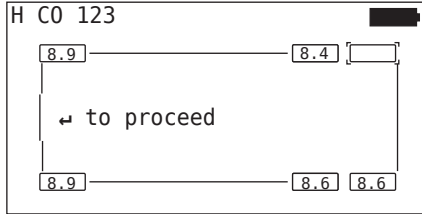

When the fetching process for all tires including the last is complete, the configuration is transmitted to the CPC system.

	NOTE
	▶ To fetch the tire sensor of the inner twin tires, the tool can remain on the outer of twin tires.

6.5.5 Transfer of the configuration to the CPC system

In order for the data to be transferred to the CPC system, the hand-held tool must be connected to the CPC system via the diagnosis cable.

The following message appears on the screen of the hand-held tool:

```
H C0 123 █  
  
CONFIGURATION COMPLETED.  
  
CONNECT TOOL WITH CPC.  
IGNITION ON.  
START UPLOAD.
```

	NOTE
	▶ To ensure safe transfer of the configuration, do not switch off the hand-held tool during data transfer or interrupt data transfer.

To transfer the configuration for a truck/bus, proceed as follows:

- ◆ Connect the hand-held tool to the unused plug socket of the display via the diagnostic cable or via the diagnostic connection of the K or L subharness.
- ◆ Switch on the ignition.
- ◆ Start transmission with the Return key .

To transfer the configuration for a trailer, proceed as follows:

- ◆ Release the plug connection between the pressure control indicator and the trailer wiring harness.
- ◆ Connect the hand-held tool to the wiring harness via the diagnosis cable.
- ◆ Switch on the ignition.
- ◆ Start transmission with the Return key .

	NOTE
	▶ If the trailer has no power supply during installation, The CCU of the trailer is supplied with current via the hand-held tool. This procedure is automatic.

The following message appears during transfer:

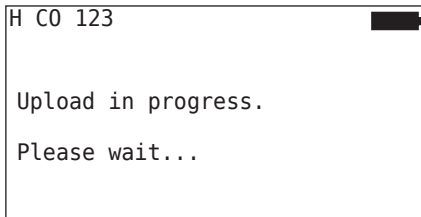

- ◆ Disconnect the hand-held tool after transferring data and establish the plug connection to the pressure control indicator.

6.5.6 Log file

To complete transmission of the configuration data to the CPC system, a log file is created automatically and stored on the SD memory card. See also section „7.4 Log files“ on page 143“.

The following is displayed on the screen:

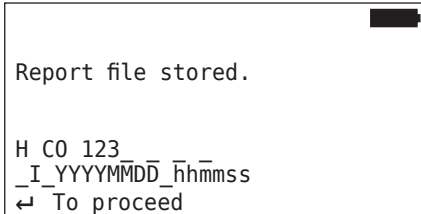

After successful data transmission, the following appears:

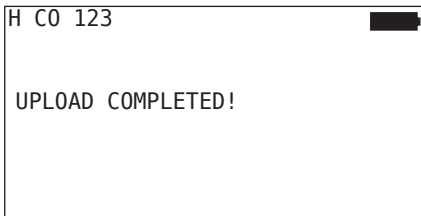

	NOTE
	<ul style="list-style-type: none"> ▶ The previously-set configuration is always stored on the hand-held tool. The advantage of this is that initialization of several vehicles with the same configuration is easier.

	NOTE
	<ul style="list-style-type: none"> ▶ During every software update or every parameter modification on the CCU (“New Installation“, “Modify Parameters“, “Modify Sensor IDs“) all saved DTCs (error codes) are erased! The existing DTCs (error codes) are automatically stored in a DTC report before each software update! See also section „6.10 Diagnosis“ on page 115

6.5.7 Possible problems

6.5.7.1 Sensor not found after 2 attempts

Sensor was not found after the first fetching attempt. The following message appears on the screen:

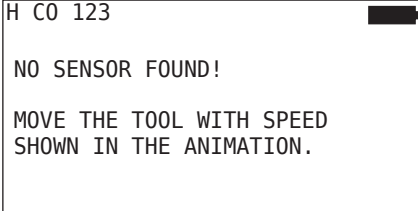

```
H C0 123  
  
NO SENSOR FOUND!  
  
MOVE THE TOOL WITH SPEED  
SHOWN IN THE ANIMATION.
```

- ◆ Repeat the fetching process of the tire.

If the hand-held tool does not find the sensor after the second attempt, the fetching process is stopped and the following message appears:

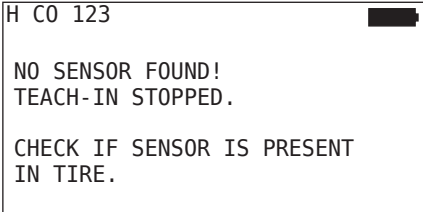

```
H C0 123  
  
NO SENSOR FOUND!  
TEACH-IN STOPPED.  
  
CHECK IF SENSOR IS PRESENT  
IN TIRE.
```

- ◆ Acknowledge the message with the Return key .

Remedy:

1. Check the charging state of the hand-held tool.
 - ▶ The charging state must be at least 40%.
 - ▶ If the charging state is sufficient, there is no sensor on the tire, the sensor is not operational or is defective.
2. Dismantle the tire for exact checking.
3. In the case of some tires and special vehicles, it is possible that the strength of the querying signal is not sufficient. Contact after-sales service for adjustment.
4. To initialize the CPC system, proceed as described in the section **„6.6 Resume initialization“ on page 90.**

	NOTE
	<ul style="list-style-type: none">▶ Only one fetch process may take place at a time in the immediate vicinity. Otherwise the fetch process can be disturbed and after completion, the function of CPC system may be restricted or not work at all.

6.5.7.2 2 Different sensors found simultaneously

The following message appears on the screen:

```
H C0 123   
  
MORE THAN ONE SENSOR  
RECEIVED!  
  
MOVE TOOL WITH SPEED  
SHOWN IN ANIMATION.
```

- ◆ Repeat the fetching process of the tire.

If the hand-held tool finds 2 sensor again, the fetching process is stopped and the following message appears:

```
H C0 123   
  
MORE THAN ONE SENSOR  
RECEIVED!  
TEACH-IN STOPPED.  
  
REFER TO MANUAL.
```

- ◆ Acknowledge the message with the Return key .

Remedy:

Check whether additional sensors are located within a range of 2 m of the tires.

- ▶ If yes, remove the sensors from the communication range and repeat the fetching procedure.
- ▶ If no, move the vehicle approx. 1 m forwards or backwards and repeat the fetching procedure.

6.5.7.3 Sensors not activated

The following message appears on the screen:

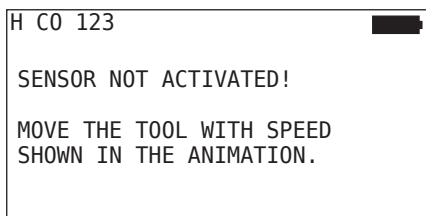

- ◆ Acknowledge the message with the Return key .

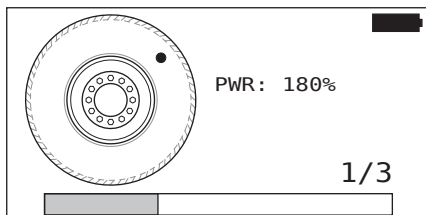

- ◆ Repeat the fetching process of the tire.

	NOTE
	▶ The sensor is automatically reset to park mode and fetched.

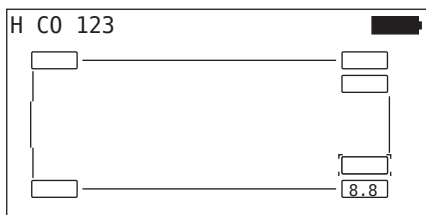

- ◆ Fetch the next sensor.

6.5.7.4 Further termination criteria during the fetching process

The following errors constitute termination criteria during the fetching process:

- Sensor DEFECTIVE
- LOW Battery
- Sensor is LOOSE

If a tire sensor has one of the errors stated, the tire must be dismantled and the sensor replaced.

If the tire sensor is not renewed, the fetching process cannot be completed.

6.5.7.5 Configuration transfer not possible

If there is no CAN bus connection, transmission of the configuration is not possible and the following message appears.

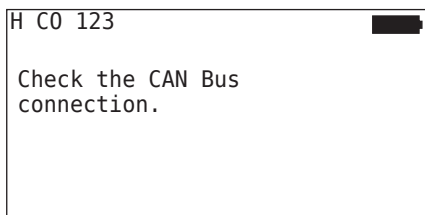

Remedy:

1. Check the connection between the hand-held tool, the diagnosis cable and the CPC components.
 - Checking the CAN connections between HHT and components in the "DTC (error code)" menu (see the section "**„6.10.1 DTCs (error codes)“ on page 115**" for this).
 - Checking the CAN connection to the vehicle's own CAN in the "CAN Check" menu (see the section "**„6.10.3 CAN check“ on page 139**").
2. In the case of a truck installation, check that the ignition is switched on.
3. Repeat transfer of the configuration.
4. If there is still no CAN bus connection, exit the menu and check the cabling of the CPC system.

	NOTE
	▶ If the above troubleshooting is not successful, contact Customer Service or your local company.

6.5.7.6 Transferred configuration not accepted

If configuration of the system is not successful, the following message appears:

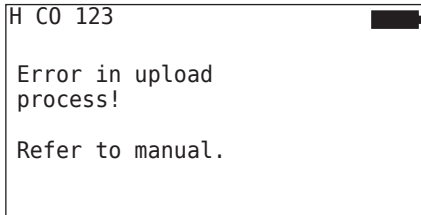

Remedy:

In this case, communication to the CCU has failed.

- ◆ Repeat transfer of the configuration.

If the message appears again:

- ◆ Reinstall and check the configuration.

	NOTE
	▶ If the above troubleshooting is not successful, contact Customer Service or your local company

6.6 Resume initialization

The **"Resume installation"** menu item is only active when the "New Installation" procedure was interrupted.

Installation - Resume installation

The following message appears on the screen:

```

H C0 123
DOES IDENTIFICATION
BELONG TO THIS VEHICLE?

←→ no

NO -> GO TO MODIFY PARAMETERS
  
```

6.6.7.1 Identification name belongs to vehicle

- ◆ Select "Yes" with the arrow keys ← → and confirm the vehicle name with the Return key ↵.

The initialization process is then continued from the point where "New Installation" was interrupted.

	NOTE
	▶ The tires already taught are displayed as black tire symbols after an interruption of the fetch process.

6.6.7.2 Identification name does not belong to vehicle

- ◆ Select "No" with the arrow keys ← → and confirm with the Return key ↵ to exit the menu item otherwise a wrong configuration is installed for this vehicle.
- ◆ Carry out a new installation for this vehicle, see section „**6.5 Initialization of the CPC system when reinstalling**“ on page 62.

6.7 Test drive

The "Test-drive" menu item is used for checking the reception quality of the CPC system built into the vehicle.

For this purpose, the following data is acquired:

1. The number of telegrams from the individual sensors received.
2. The signal strength of the individual sensors acquired by the receiver.

The data received is evaluated by the hand-held tool and the result output in 3 steps:

- Good reception
- Enough reception
- Just sufficient reception

	NOTE
	<ul style="list-style-type: none">▶ In order to be able to check the reception quality of all installed tire sensors, all lift axles must be lowered.▶ Do not take the sensors of raised lift axles into consideration during the test drive.▶ When the ATL function is activated, the tires of the trailer are not taken into consideration during the test drive.

	NOTE
	<ul style="list-style-type: none">▶ A route should be selected for the test drive that allows a speed of at least 30 km/h (18 mph).

	NOTE
	<ul style="list-style-type: none">▶ The "Test-drive" can be stopped at any time by pressing the ESC key (ESC) for 3 seconds.

The following applies to all test drives:

If the test drive is not completed with the "Good reception" result, the following remedial action is possible:

Variant	Remedial action
Only a CCU is used.	<ul style="list-style-type: none">■ Optimize position and alignment of the CCU.■ Retrofit an additional receiver
A CCU and an additional receiver are used.	<ul style="list-style-type: none">■ Optimize position and alignment of both components.
The "MARRIED" application is used.	<ul style="list-style-type: none">■ If the reception of the tire sensors of the trailer cannot be improved by the previous remedies, the trailer must be retrofitted with its own CPC system.

6.7.1 Truck/Bus test drive, MARRIED or Mining / Harbor

In order to enable the data to be transmitted from the CPC system to the hand-held tool, a connection must be established with the diagnostics cable.

- ◆ Connect the hand-held tool to the unused plug socket of the display via the diagnostic cable or via the diagnostic connection of the K or L subharness.
- ◆ Switch on the ignition.

	NOTE
	▶ If the vehicle is moved, it must stand still for at least 20 min. before the test drive can be started.

Installation - Test-drive

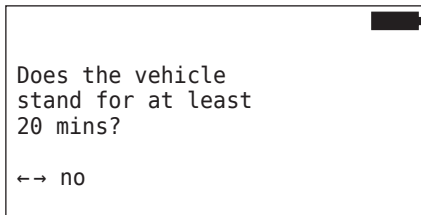

The following query appears on the screen:



Standing time less than 20 minutes:

- ◆ Select "No" with the arrow keys ← → and confirm with the Return key  to exit the menu.
- ◆ Wait for the required standing time and restart the "Test-drive" menu.

Standing time at least 20 minutes:

- ◆ Select "Yes" with the arrow keys ← → and confirm with the Return key .
- ◆ Read the disclaimer and confirm with the Return key .

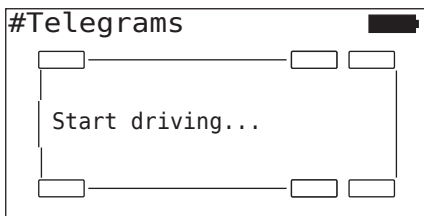

- ◆ Begin the test drive with the vehicle and continue until the end of the test drive is indicated by the corresponding instructions on the screen.

The following display appears on the screen during the test drive:

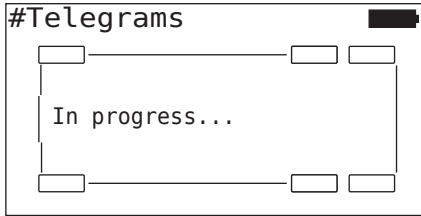

The test drive is completed and the hand-held tool creates a log file:

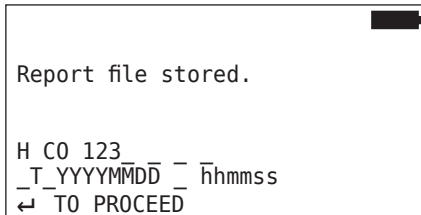

Following the message for creating the log file:

- ◆ Press the Return key 



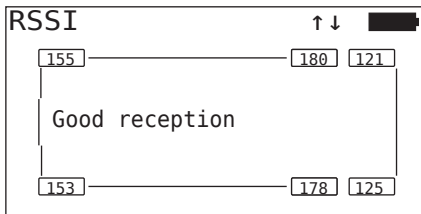
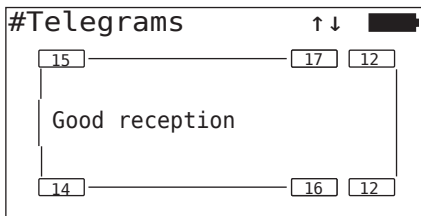

For example, the following information appears:



Area	Meaning
Header	<p>Telegrams: the number of telegrams received per sensor in the tires is displayed.</p> <p>RSSI: the signal strength detected for the respective sensor in the tires is displayed.</p>
Tire symbols	<p>In the case of the RSSI display, the tire symbols change their appearance according to the reception quality.</p> <ul style="list-style-type: none"> ■ Good reception - tire is "white" (see image) ■ Enough reception - tire is "black" (inverted) ■ Just sufficient reception - tire "flashes"
Middle row	<p>The result of the test drive is displayed here. Good, sufficient or borderline reception is indicated.</p> <ul style="list-style-type: none"> ■ Good reception No reception disturbance is expected. ■ Enough reception In rare cases, it is possible that reception for the tires displayed could be disturbed (radio disturbance; extreme weather conditions). ■ Just sufficient reception Frequent disturbances to reception for the tires displayed are possible.

	NOTE
	<p>► Generally, the higher the RSSI value the better the reception.</p>

	NOTE
	<p>► If a lift axle was raised during the test drive, no figures are displayed in the tire symbols for the lift axles.</p>

- ◆ Switch between the "Telegrams" and "RSSI" display with the arrow keys  .
- ◆ In the case of the "MARRIED" vehicle type, it is possible to switch between truck and trailer with the arrow keys  .
- ◆ Confirm the result of the test drive with the Return key .

If the test drive is completed with a "Good reception" result, remedial action is possible. See section „**6.7 Test drive**“ on page 91.

	NOTE
	<p>If an error occurs when the log file is stored:</p> <ul style="list-style-type: none">▶ Make sure that the SD memory card is inserted in the tool. See section „5.3 Change the memory card“ on page 31▶ Check access to the SD memory card with "Diagnose/Connection to the PC". See section „8.2 Connection to the PC“ on page 146

6.7.2 Trailer test drive

In order to carry out a test drive for a CPC system installed in a trailer, the CCU of the trailer must be set to a "Test drive mode".

Contrary to the truck, the following must be done for the trailer for the test drive:

1. Activate the trailer system for the test drive (with the hand-held tool).
2. Carry out test drive (WITHOUT hand-held tool).
3. Evaluate the results of the test drive (with hand-held tool).

For steps 1 and 3, the following must be considered:

- ◆ Release the plug connection between the pressure control indicator and the trailer wiring harness.
- ◆ Connect the hand-held tool to the wiring harness via the diagnosis cable.
- ◆ Switch on the ignition.
(if the vehicle power supply is not present, the hand-held tool supplies the CCU on the trailer.)
- ◆ Subsequently disconnect the hand-held tool and reconnect the plug to the pressure control indicator.

	NOTE
	<ul style="list-style-type: none"> ▶ If the CSW software version is <10, a test drive for the trailer is not possible. ▶ Please update the CSW software accordingly. See section „6.10.2 Software updates“ on page 132

Installation - Test-drive

- ◆ Process the query for the identification number of the vehicle as in section „**6.7.1 Truck/Bus test drive, MARRIED or Mining / Harbor**“ on page 93.

The following query appears on the screen:

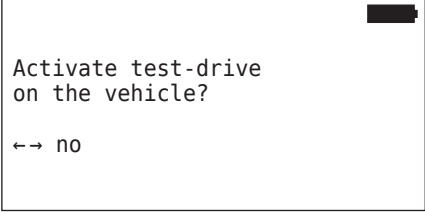

A screenshot of a handheld device screen. The screen displays the text "Activate test-drive on the vehicle?" followed by a cursor and the text "← → no". There is a small black rectangular mark in the top right corner of the screen.

- ◆ Select "Yes" with the arrow keys ← → and confirm with the Return key .

The hand-held tool confirms with a corresponding message that the trailer system is activated for the test drive

- ◆ Disconnect the hand-held tool and establish the plug connection to the pressure control indicator.
- ◆ Begin the test drive with the vehicle and continue until the pressure control indicator emits an optical signal (lights up continuously for 60 seconds).
- ◆ Connect the hand-held tool with the vehicle as described and restart the "Test-drive" menu, evaluate the data.
Evaluation takes place automatically and assessment takes place analogous to sect. „6.7.1 Truck/Bus test drive, **MARRIED or Mining / Harbor**“ on page 93.

NOTE	
	<ul style="list-style-type: none"> ▶ If the vehicle is moved, it must stand still for at least 20 min. before the test drive can be started. ▶ As long as the qualifying criteria for the test drive are not reached, the pressure control indicator flashes with a special code (double flash every 2 seconds).

6.7.3 Possible error codes during test drives

If an error occurs during the test drive, the test process is canceled. If not already mentioned, the error messages described in this section apply to all vehicle types. After elimination of the error, the test drive must be started again from the beginning.

	NOTE
	▶ If the vehicle is moved, it must stand still for at least 20 min. before the test drive can be restarted.

6.7.3.1 Warnings

If a warning occurs during the test drive (such as LOW PRESSURE), the test drive is aborted and the following message is displayed on the screen:

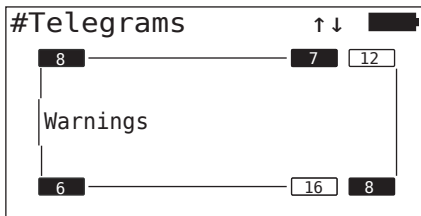

A log file is created automatically and stored on the SD memory card.

In this case:

- ◆ Stop the test drive.
- ◆ Acknowledge the message with the Return key .
- ◆ Read the error codes via the menu described in section „**6.10.1 DTCs (error codes)**“ on page 115 and remedy the error correspondingly.
- ◆ Allow the vehicle to stand still for **at least 20 min.**
- ◆ Execute the "Test-drive" menu again.

6.7.3.2 No CAN data

	NOTE
	► The error message can only occur during "Truck/Bus test drive, MARRIED or Mining / Harbor" !

If CAN communication is interrupted during the test drive, the test drive is aborted and the following message is displayed on the screen:

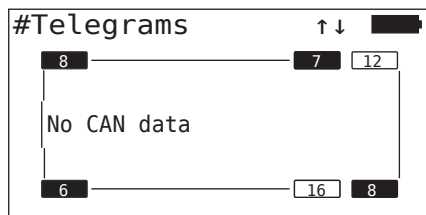

A log file is created automatically and stored on the SD memory card.

In this case:

- ◆ Stop the test drive.
- ◆ Acknowledge the message with the Return key .
- ◆ Error elimination according to the instructions in sections „**6.5.7.5 Configuration transfer not possible**“ on page 88 and „**6.5.7.6 Transferred configuration not accepted**“ on page 89 ff.
- ◆ Allow the vehicle to stand still for **at least 20 min.**
- ◆ Execute the "Test-drive" menu again.

6.7.3.3 Timeout

The tire sensor telegrams in START Mode are used to evaluate the test drive (see sect. „6.4.1 Check sensor“ on page 45). If an insufficient number of telegrams per wheel are received in START Mode 20 minutes after the "Test-drive" menu item was executed, the "Time out" message is displayed on the screen.

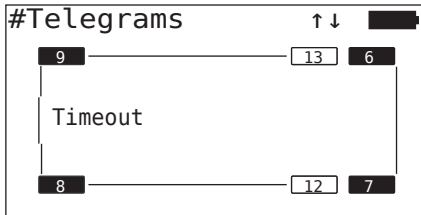

A log file is created automatically and stored on the SD memory card.

In this case:

- ◆ Stop the test drive.
- ◆ Acknowledge the message with the Return key .

Possible causes:	Remedy
Vehicle moved too long at a speed of < 30 km/h (18 mph)	Move the vehicle faster during a new drive.

- ◆ Park the vehicle
- ◆ Allow the vehicle to stand still for **at least 20 min.**
- ◆ Execute the "Test-drive" menu again.

6.7.3.4 Failed

Only tire sensor telegrams in START Mode are used to evaluate the test drive (see sect. „6.4.1 Check sensor“ on page 45). If a telegram for one wheel in DRIVE Mode is received, before an insufficient number of telegrams per wheel in START Mode are received, The "Failed" message is displayed on the screen.

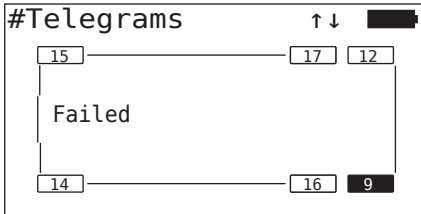

A log file is created automatically and stored on the SD memory card.

In this case:

- ◆ Stop the test drive.
- ◆ Acknowledge the message with the Return key .

i	NOTE
	▶ If a lift axle was raised during the test drive, no figures are displayed in the tire symbols for the lift axles.

i	NOTE
	▶ It is possible to switch between the "Telegrams" and "RSSI" display with the arrow keys  (see also section „6.7.1 Truck/Bus test drive, MARRIED or Mining / Harbor“ on page 93).

Possible causes:	Remedy
Test-drive with vehicle was started although the vehicle was moved previously for less than 20 minutes.	Allow the vehicle to stand still for at least 20 min. before beginning the test drive.
The CCU and / or the additional receiver was unsuitably mounted or unsuitably aligned so that an insufficient number of telegrams from some wheel positions could be received in START Mode. These wheel positions are displayed inverted in the "TELEGRAMS" screen.	Check the position and alignment of the CCU and the additional receiver and change if necessary.

- ◆ Park the vehicle
- ◆ Check the error source according to the chart and eliminate the error if necessary.
- ◆ Allow the vehicle to stand still for **at least 20 min.**
- ◆ Execute the "Test-drive" menu again.

6.7.3.5 Pressure control indicator

If the defined flashing code is not displayed after activating the pressure control indicator (short double flash every 2 seconds), do not start the test drive with the trailer.

Possible causes:	Remedy
Activation failed.	Repeat activation.
Pressure control indicator defective	Connect the hand-held tool to the components via the diagnosis cable. Switch on the hand-held tool. Check whether the pressure control indicator lights up.
No power supply to the CPC trailer system from the vehicle.	Establish power supply.

6.8 Modify Installation

	NOTE
	<ul style="list-style-type: none">▶ By selecting the "Modification" item in the main menu, the charging state of the battery is checked. If this is not sufficient, the following message appears: "Low battery! Power ON the HHT to charge it." Charge the hand-held tool as described in the section „5.2 Charging the hand-held tool“ on page 29.

	NOTE
	<p>Not all features and settings may be available when the CPC system is integrated into a third-party solution. Follow the third-party's instructions during installation. In particular, ATL with position is not supported by all third-party vendors, which may cause the function to fail.</p>

	NOTE
	<p>The recommended default values for the warning thresholds are</p> <ul style="list-style-type: none">▶ 90% ("LOW PRESSURE") <p>and</p> <ul style="list-style-type: none">▶ 80% ("VERY LOW PRESSURE") of the nominal pressure.

	ATTENTION
	<p>Damage to equipment!</p> <p>Adjust the warning thresholds according to the area of application of the tires is at your own risk. The factory settings are for orientation only</p> <ul style="list-style-type: none">▶ No liability is assumed for the correctness of the warning thresholds.

6.8.1 Modify existing installation

Modification - Modify Installation

This menu item contains the following submenu items:

- Check Installation
- Modify Parameters
- Modify Sensor IDs

Requirements for using the submenu items:

- To communicate with the CCU, the hand-held tool must be connected to the CPC system.

	NOTE
	<p>▶ If communication between the hand-held tool and the CCU is not possible, the process is aborted and a corresponding message is displayed. Remedy:</p> <p style="padding-left: 20px;">» See the sections „6.5.7.5 Configuration transfer not possible“ on page 88 and „6.5.7.6 Transferred configuration not accepted“ on page 89.</p>

	NOTE
	<p>▶ During every parameter modification on the CCU (“New Installation”, “Modify Parameters”, “Modify Sensor IDs”) all saved DTCs (error codes) are erased! See also section „6.10 Diagnosis“ on page 115</p>

6.8.1.1 Checking the installation

Modification - Modify Installation - Check Installation

The parameters of the existing installation are displayed under the **"Check Installation"** menu item. No changes can be made.

The list of parameters varies according to vehicle type and configuration.

After the parameter overview, the RETURN key  is used to display the known bird's-eye views of the set target pressures and lift axes.

After the overview of the serial numbers of existing components (ECU, DSP, RX) the **"Modify installation"** submenu appears again.

6.8.1.2 Modify Parameters

Modification - Modify Installation - Modify Parameters

The following parameters can be changed in the "Modify Parameters" menu item:

The following parameters are excluded from any changes:

- Vehicle type
- Number of axles
- Tire configuration

i	NOTE
	<p>The CPC system automatically detects when a single tire with tire sensor is replaced.</p> <p>Also see: <i>ContiPressureCheck -Installation manual- section "Automatic Wheel Change Detection"</i>.</p> <p>▶ When selecting the ATL function, "Automatic Wheel Change Detection" is deactivated!</p>

After selecting the menu item, the vehicle name is queried first.

VEHICLE NAME █

H C0 123

1	2	3	4	5	6	7	8	9	0	←
Q	W	E	R	T	Y	U	I	O	P	
A	S	D	F	G	H	J	K	L		
Z	X	C	V	B	N	M	↵	OK		

As described in section „6.5.1 Enter vehicle names“ on page 63, it is possible to enter or modify the vehicle name via the virtual keyboard or confirm the existing name with the Return key (↵).

After the parameters are modified, they can be transferred to the CCU.

The following messages appear:

```
H C0 123 ██████████  
  
CONFIGURATION COMPLETED.  
  
CONNECT TOOL WITH CPC.  
IGNITION ON.  
START UPLOAD.
```

- ◆ Start the upload with Return key (↵).

```
H C0 123 ██████████  
  
Upload in progress.  
  
Please wait...
```

If data transfer was not successful proceed as in sect. „**6.5.7.5 Configuration transfer not possible**“ on page 88 or in sect. „**6.5.7.6 Transferred configuration not accepted**“ on page 89. Otherwise the "Modify Installation" submenu appears.

A log file is created for every parameter modification and stored on the SD memory card.

6.8.1.3 Modify Sensor IDs

Modification - Modify Installation - Modify Sensor IDs

It is possible to make changes in the "**Modify Sensor IDs**" menu item when the CPC system setup remains the same and only the assignment of sensor IDs is necessary (e. g., after several wheel changes or swapping the tire positions).

The configuration is loaded from the vehicle's CCU after selecting the "Change Sensor IDs" submenu.

The tires to be changed are queried after successful loading of the configuration. Selecting "**Some**" allows you to change all instead of individual tires. The tires to be changed are to be selected in the following bird's eye view.

Subsequently, the hand-held tool is ready for the fetching process.

To fetch the tire sensors, remove the diagnosis cable from the hand-held tool and proceed as in section „**6.5.4 Fetching tire sensors**“ on **page 78**.

When the tire sensors are successfully fetched, the hand-held tool must be connected to the CPC system via the diagnosis cable to transmit the new configuration to the CPC system.

A log file is created for every modification of the sensor IDs and stored on the SD memory card.

6.9 Deactivate/activate ContiPressureCheck system

6.9.1 Deactivate CPC

In the case that the CPC system exhibits a malfunction that could disturb the driver and cannot be quickly remedied, it is possible to temporarily deactivate the CPC system.

- ◆ Connect the hand-held tool to the CPC system via the diagnosis cable.

Modification - Deactivate CPC

The menu item serves to deactivate the entire system.

The following message appears:

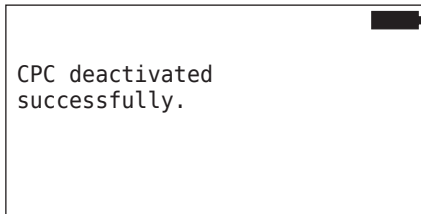

When the CPC system is successfully deactivated, this is indicated at system level as follows:

- Truck: display message "SYSTEM NOT ACTIVE"
- Trailer: pressure control indicator without function.
Even in the case of "Ignition on", the display does not light up for 15 seconds.

NOTE	
	<ul style="list-style-type: none">▶ If communication between the hand-held tool and the CCU is not possible, the process is aborted and a corresponding message is displayed. Remedy:<ul style="list-style-type: none">» See the sections „6.5.7.5 Configuration transfer not possible“ on page 88 and „6.5.7.6 Transferred configuration not accepted“ on page 89.

6.9.2 Activate CPC

To activate the CPC system in the vehicle,

- ◆ Connect the hand-held tool to the CPC system via the diagnosis cable.

Modification - Activate CPC

This menu item serves to activate the entire system in the vehicle.

The following message appears:

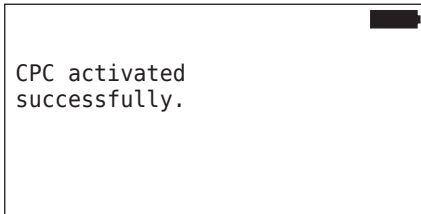



After successful activation, the CPC system is fully functional again.

	NOTE
	<p>► If communication between the hand-held tool and the CCU is not possible, the process is aborted and a corresponding message is displayed. Remedy:</p> <ul style="list-style-type: none"> » See the sections „6.5.7.5 Configuration transfer not possible“ on page 88 and „6.5.7.6 Transferred configuration not accepted“ on page 89.

6.10 Diagnosis

6.10.1 DTCs (error codes)

	NOTE
	<ul style="list-style-type: none">▶ Max. 20 active DTCs are stored for each system component.▶ During every software update or every parameter modification on the CCU ("New Installation", "Modify Parameters", "Modify Sensor IDs") all saved DTCs (error codes) are erased!

	NOTE
	<ul style="list-style-type: none">▶ The charging state of the battery is checked by selecting the "DTC (error code)" item in the main menu. If this is not sufficient, the following message appears: "Low battery! Power ON the HHT to charge it."

Diagnosis - DTC (error code)

In the case of error messages, there is a difference between global and tire-relevant error messages.

First of all, the connection to the CAN bus is checked.

If there is no connection, the message appears:

```
H C0 123
Check the CAN Bus
connection.
```

- ◆ Check CAN bus communication to the components (CCU, display and CAN switch).

If connected, the vehicle name is queried. A message subsequently appears containing the status information of all components:

```
Connected:
CCU - Yes
DSP - Yes
CSW - No
↵ TO READ DTC
```

- ◆ Call the "DTC (error code)" submenu with the Return key .

```
DTC (failure code)
Global DTCs
Tire related DTCs
Erase all DTCs
Save DTCs
```

	NOTE
	<p>If the "Error reading DTCs" message appears during reading although the CCU, DSP or CSW components indicate a "Married" status, then:</p> <ul style="list-style-type: none">▶ Check whether the software for these components was correctly installed. See also section „Errors during a software update“ on page 138“.

	NOTE
	<p>If an additional receiver is installed in the system, it must be ensured that the CCU is configured accordingly with the parameter "Additional receiver: YES". If the RX is wrongly displayed as not connected in the "Diagnosis - DTC (error code)" menu overview, the CCU configuration may be faulty.</p> <ul style="list-style-type: none">▶ In this case, check the configuration of the CCU and change it if necessary (see the sections „6.8.1.1 Checking the installation“ on page 109 and „6.8.1.2 Modify Parameters“ on page 110).

6.10.1.1 Read general error codes (DTCs)

Diagnosis - DTC (error code) - General DTCs

General error codes can be read for the following components:

- CCU (control unit)
- CSW (switching module)
- DSP (display)

All errors are listed. All listed messages can be viewed with the arrow keys .

	NOTE

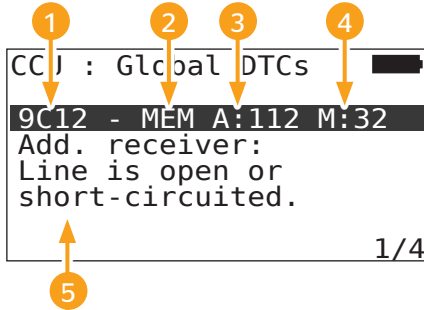

1	Error code	
2	Error status	ACT: active error
		MEM: passive error
3	Active counter	In the above example, the error was active for 112 ignition cycles (A: 112).
4	Passive counter	In the above example, the error has been passive for 32 ignition cycles (M: 32).
5	Error description	

- The error codes with a description and measures to correct them can be found on the following pages.
- There is still an active error (status ACT) and must be eliminated. A passive error (Status MEM) has already been eliminated.
- The active counter indicates how many ignition cycles an error already exists (for active errors) or after how many ignition cycles it has been corrected (for passive errors). The active counter reaches a maximum value of 255. This means that if "A: 255" is displayed, the error is/was active for/for 255 ignition cycles or longer.
- As soon as an error has been corrected (status MEM), the passive counter shows how many ignition cycles the error was corrected previously. Passive faults are automatically cleared after 40 ignition cycles (M: 40).
- The ignition cycles are not counted in the case of error codes affecting the display.

Note on eliminating error:

- ◆ Before a component is replaced, all DTCs must be stored and then erased.
- ◆ Switch off the CPC system and start again after one minute.
- ◆ Check DTCs again 2 minutes after restarting the CPC system.
- ◆ If the corresponding occurs again, the components must be replaced.

	NOTE
	▶ If a component is replaced, the corresponding DTC must always be notified or the DTC log file transmitted.

The following error codes are possible:

For the **CCU**:

DTC	Description	Remedy
9C01	CAN communication error.	» Check plug-in connector on the display. » Check cable. » Check CCU.
9C10	No communication with additional receiver.	» Check plug-in connector on the additional receiver and the CCU. » Check cable. » Check the additional receiver.
9C12	Add. receiver: Line is open or short-circuited.	» Check plug-in connector on the additional receiver and the CCU. » Check cable. » Check the additional receiver.
9A01	Supply voltage too low.	» Check whether on board voltage is at least 12 V.
9A02	Supply voltage too high.	» Check whether on board voltage is max. 28 V. » Replace CCU.
1F16	Data reception from tire sensors via RF is disturbed.	» Change location (indication of radio interference).
9B02	CCU defective.	» Replace CCU.
9B03	CCU defective.	» Replace CCU.

DTC	Description	Remedy
9F15	No Tire Sensors mounted or they are not activated.	<ul style="list-style-type: none"> » Use the hand-held tool to check whether tire sensors are really installed. For this purpose, carry out the fetching process according to sect. „6.4.5 Check all tires“. or » Configure the CPC system according to sect. „6.5 Initialization of the CPC system when reinstalling“.
9F13	CPC system not configured.	<ul style="list-style-type: none"> » Configure the CPC system according to sect. „6.5 Initialization of the CPC system when reinstalling“.

For the display:

DTC	Description	Remedy
9B04	Display defective.	<ul style="list-style-type: none"> » Replace display.

For the switching module (CSW):

DTC	Description	Remedy
9F02	CCU-Trailer defective.	» Replace CCU.
9F03	CAN communication error.	» Check plug-in connector on the CCU. » Check cable between CCU and pressure control indicator. » Check CCU.
9F04	External power supply too low.	» Check whether on board voltage is at least 12 V.
9F05	External power supply too high.	» Check whether on board voltage is max. 28 V.
9F06	Internal power supply too low.	» Check whether on board voltage is at least 12 V.
9F07	Internal power supply too high.	» Check whether on board voltage is max. 28 V. » Replace CCU.
9F08	Power supply for additional receiver too low.	» Check whether on board voltage is at least 12 V.
9F09	Power supply for additional receiver too high.	» Check whether on board voltage is max. 28 V. » Replace CCU.
9F0A	Short circuit at Pressure check indicator.	» Check cable between CCU and pressure control indicator. » Check whether the pressure control indicator is intact. (Connect the hand-held tool to the components via the diagnosis cable. Switch on the hand-held tool. Check whether the pressure control indicator lights up.)

DTC	Description	Remedy
9F0B	Open circuit at Pressure check indicator.	<ul style="list-style-type: none"> » Check cable between CCU and pressure control indicator. » Check the pressure control indicator with the hand-held tool (see instructions on the DTC 9F0A) <p>If the diagnosis plug on the pressure control indicator remains open for 5 minutes without DTC query, this DTC (9F0B) is activated.</p>

6.10.1.2 Read tire-relevant error codes (DTCs)

Errors for a certain tire can be read in the **"Tire related DTCs"** menu item.

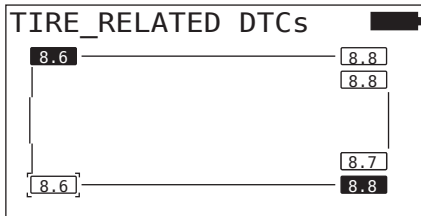

Diagnosis - DTC (error code) - Tire related DTCs

The configuration appears on the screen as bird-eye-view. The tire positions with error message are marked in black: see also section **„6.3 Screen displays“ on page 41**.



NOTE

- ▶ Flashing, black tire: there is at least one active error for this tire.
- ▶ Flashing, black tire: there is at least one passive error for this tire.
- ▶ The error codes (DTCs) are updated automatically every 30 seconds.
- ▶ In the case of a configuration with ATL, the DTCs of the trailer tires cannot be acquired by the hand-held tool.
- ▶ If there are no tire related DTCs, the "No tire related DTCs found." message is displayed.
 - » Change to the bird-eye-view with the Return key 
 - » Only the tire pressures are displayed.

- ◆ Select the desired tire with the arrow keys . The selected tire is indicated by "[]".
(In the case of the "Married" configuration it is possible to go to the axles of the trailer or the truck by pressing the arrow keys )
- ◆ Press the Return key  to display the error (only possible for black or flashing tires).

	NOTE
	▶ The numbers in the tire symbols indicate the current tire pressures in bar or psi.
	▶ It can take up to 2 minutes until the pressures of all tires are displayed.
	▶ If no pressure values are displayed after 2 minutes, the tire sensor is located at an unfavorable position and can not be received or it is defective.
	▶ If the "J1939" standard is selected as CAN format only, no pressures are displayed for the tire-related DTCs.

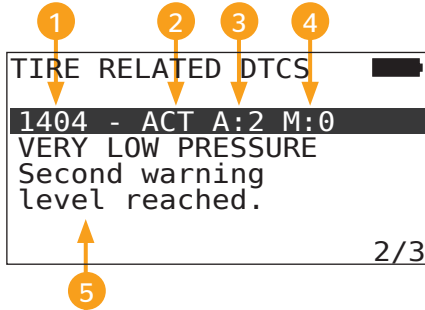

1	Error code	
2	Error status	ACT: active error
		MEM: passive error
3	Active counter	
4	Passive counter	
5	Error description	

- The error codes with a description and measures to correct them can be found on the following pages.
- There is still an active error (status ACT) and must be eliminated. A passive error (Status MEM) has already been eliminated.
- The active counter indicates how many ignition cycles an error already exists (for active errors) or after how many ignition cycles it has been corrected (for passive errors). The active counter reaches a maximum value of 255. This means that if "A: 255" is displayed, the error is/was active for/for 255 ignition cycles or longer.
- As soon as an error has been corrected (status MEM), the passive counter shows how many ignition cycles the error was corrected previously. Passive faults are automatically cleared after 40 ignition cycles (M: 40).

The following error codes are possible:

DTC	Description	Remedy
90##	NO SIGNAL No reception of tire sensor data.	Poor reception » Check installed position and alignment of the CCU and/or additional receiver.
91##*	WHEEL JAMMED	» Check whether the wheel can be freely rotated.
92##	Tire sensor battery is low.	» Replace TTM.
13##	LOW PRESSURE First warning level reached.	» Increase tire pressure to recommended value.
14##	VERY LOW PRESSURE Second warning level reached..	» Check for damage. » If the tire is undamaged, increase the tire pressure to the recommended value.
15##	FAST PRESS. LOSS The tire is losing pressure very fast.	» Check tire, valve and wheel rim for leaks.
16##	TEMPERATURE The tire sensor has detected a critical temperature.	Tire sensor was subject to too high temperature. » Check function of tire and brakes.
1A##	PRESSURE DIFFERS compared to twin tires.	» Increase tire pressure to recommended value.
97##	SENSOR DEFECTIVE Tire sensor is defective.	» Replace the tire sensor.

DTC	Description	Remedy
18##	The tire sensor is shut-down due to maximum temperature.	Tire sensor was subject to too high temperature. » Check function of tire and brakes.
19##	CHECK SENSOR The tire sensor is mounted wrongly.	» Dismantle tire. Renew tire sensor.
1D##	CHECK SENSOR The tire sensor lost contact in tire.	» Dismantle tire. Renew tire sensor.

* This error message is optional and not available in all CPC versions.

	NOTE
	► ## is a placeholder for the hex code that specifies the tire position. This position is dependent on the selected configuration.

6.10.1.3 Erase all error codes (DTCs)

The error messages of all components can be erased in the "**Erase all DTCs**" sub-menu.

Diagnosis - DTC (error code) - Erase all DTCs

The following message appears on the screen:

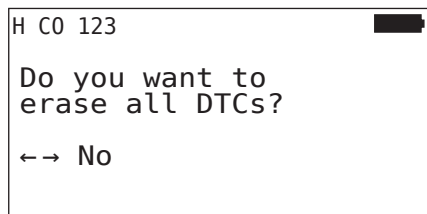

- ◆ Select "YES" with the arrow keys ← →.
- ◆ Press the Return key (↵) to erase the error codes of all components.

The "DTCs successfully erased" message or "DTCs not completely erased" message appears. In the case of the latter, repeat the erase process.

6.10.1.4 Save error codes (DTCs)

Error messages can be saved using this menu item.

Diagnosis - DTC (error code) - Save DTCs

The following message appears on the screen:

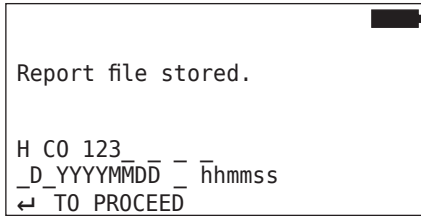

A log file was created automatically and stored on the SD memory card.

	NOTE
	<ul style="list-style-type: none">▶ If there are no general DTCs, the "No general DTCs" message is displayed.▶ Saving DTCs is only possible when the SD memory card is inserted. See also section „7.4 Log files“ on <i>page 143</i>“.

6.10.2 Software updates

Diagnosis - Software Update

	NOTE
	<ul style="list-style-type: none"> ▶ The CSW (switching module) component is only available for a CPC with trailer. ▶ The DSP (Display) component is only available in the case of the CPC for truck/bus. ▶ The charging state of the rechargeable batteries is checked before the software date starts. If this is not sufficient, the following message appears: Low battery! Switch the tool on to charge“ Charge the hand-held tool as described in the section „5.2 Charging the hand-held tool“ on page 29 . ▶ To ensure safe software updating, do not switch off either the hand-held tool during data transfer or interrupt data transfer. There is a risk that the components to be updated (CCU, DSP, CSW) could be damaged permanently.

A software update is possible for the following components:

- CCU (control unit)
- CSW (switching module)
- DSP (display)

6.10.2.1 Available software on the hand-held tool

To control the current component software on the hand-held tool, it is possible to call the menu item in offline mode (without connection to the CPC system).

Only the versions for the individual components stored on the hand-held tool are then displayed.

```
SW available: ██████████
CCU:          --
NEW VERSION: 1.09
DSP:         --
NEW VERSION: 3.00
CSW:         --
NEW VERSION: 10
NO CAN CONNECTION.
```

6.10.2.2 Truck/Bus, married or Mining / Harbor

To update the software for Truck/Bus, Married or Mining / Harbor, proceed as follows:

- ◆ Connect the hand-held tool to the unused plug socket of the display via the diagnostic cable or via the diagnostic connection of the K or L subharness.
- ◆ Switch on the ignition.

If a new software version is available on the hand-held tool, the following message is displayed:

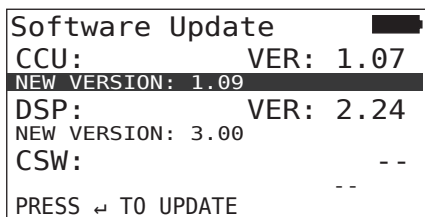

	NOTE
	<p>▶ During updating of the CCU software, it is possible that "SYSTEM ERROR" appears in the display. This is not displayed after successful updating of the CCU.</p>

- ◆ Start the software transmission for the CCU with the Return key .

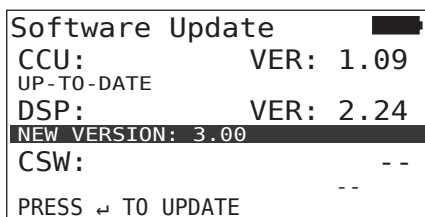

- ◆ Start software transmission for the display with the Return key .

If the software for the components was updated successfully, the following message appears:

```
Software Update
CCU:          VER: 1.09
UP-TO-DATE
DSP:          VER: 3.00
UP-TO-DATE
CSW:          --
              --
```

	NOTE
	<ul style="list-style-type: none">▶ No software versions are displayed for the CSW because the CCU for Truck/bus does contain a CSW.▶ If the "HHT IS NOT UP TO DATE" message is displayed, update the software of the hand-held tool. See section „8.1 Software Update for the hand-held tool“ on page 145.▶ If updating the CCU fails, the stored vehicle configuration is lost. The vehicle configuration must be renewed after renewed, successful software updating. See section „6.5 Initialization of the CPC system when reinstalling“ on page 62.

	NOTE
	<ul style="list-style-type: none">▶ Pressing the ESC key (ESC) returns to the diagnosis menu from every software update page.

6.10.2.3 Trailer

To update the software for a trailer, proceed as follows:

- ◆ Release the plug connection between the pressure control indicator and the trailer wiring harness.
- ◆ Connect the hand-held tool to the wiring harness of the trailer via the diagnosis cable.
- ◆ Switch on the ignition.

i	NOTE
	▶ If the trailer has no power supply during installation, The CCU of the trailer is supplied with current via the hand-held tool. This procedure is automatic.

If a new software version is available on the hand-held tool, the following message is displayed:

```

Software Update █
CCU:                VER: 1.07
NEW VERSION: 1.09
DSP:                -- --
CSW:                VER: 08
NEW VERSION: 10
PRESS ↵ TO UPDATE
    
```

- ◆ Start the software transmission for the CCU with the Return key .

```

Software Update █
CCU:                VER: 1.09
UP-TO-DATE
DSP:                -- --
CSW:                VER: 08
NEW VERSION: 10
PRESS ↵ TO UPDATE
    
```

- ◆ Start software transmission for the CSW (switching module) with the Return key .

If the software for the components was updated successfully, the following message appears:

Software Update	
CCU:	VER: 1.09
UP-TO-DATE	
DSP:	--
	--
CSW:	VER: 10
UP-TO-DATE	

- ◆ After successfully updating the trailer CCU, disconnect the hand-held tool and reconnect the plug to the pressure indicator.

	NOTE
	<ul style="list-style-type: none">▶ No software versions are displayed for the DSP because the trailer configuration has no display.▶ If the "HHT IS NOT UP TO DATE" message is displayed, update the software of the hand-held tool. See section „8.1 Software Update for the hand-held tool“ on page 145.▶ If updating the CCU fails, the stored vehicle configuration is lost. The vehicle configuration must be renewed after renewed, successful software updating. See section „6.5 Initialization of the CPC system when reinstalling“ on page 62.

	NOTE
	<ul style="list-style-type: none">▶ Pressing the ESC key (ESC) returns to the diagnosis menu from every software update page.

6.10.2.4 Errors during a software update

If the SW update fails, a corresponding warning is displayed.

```

H C0 123
Error in update
process.

Refer to manual.
  
```

The current version number can not be read and is displayed as follows.

```

Software Update
CCU:          VER:  --
NEW VERSION: 1.09
DSP:          --
CSW:          VER:  08
NEW VERSION: 10
PRESS ↵ TO UPDATE
  
```

In this case:

- ◆ Repeat the software update.

If the error occurs again:

- ◆ Replace components.

6.10.3 CAN check

The "**CAN-Check**" menu is used to check the CAN bus connection between the CPC system and the vehicle's own CAN.

The hand-held tool supports the baud rates 250 kbit/s and 500 kbit/s. When the CAN bus is connected, the hand-held tool checks and selects the appropriate baud rate automatically.

The selected CAN speed is shown in the bottom line of the screen.

	NOTE
	<p>▶ If the hand-held tool is not correctly connected to the CAN bus or the CAN bus is faulty, the error message "Check the CAN bus connection" appears. In this case, the cabling to the CPC system must be checked.</p>

6.10.3.1 Basic mode

If the CPC system and the hand-held tool are properly connected to the vehicle CAN bus, the message "**Connected**" appears.

- In this case, both the CPC system and the vehicle's own CAN bus are properly connected.

If the CPC system and the hand-held tool are not properly connected to the vehicle CAN bus, the message "**Not connected**" appears.

- In this case, the CPC system is connected to the hand-held tool properly, but there is no connection to the vehicle's own CAN bus.
- ◆ The desired CAN bus connection to the vehicle CAN must be checked.

6.10.3.2 Expert mode

	NOTE
	Expert mode is only recommended for trained experts.

In expert mode, all addresses of the ECUs connected to the CAN bus are displayed.

Example: 0x33 - CCU of the CPC system

7 SD memory card

7.1 General instructions on the SD memory card

	NOTE
	<ul style="list-style-type: none">▶ Without SD memory card, the hand-held tool only has the "English menu language"!▶ It is not possible to set the language without an SD memory card!▶ Storing of DTCs and log files is not possible without an SD memory card.▶ If the SD card is connected to the PC, and the user has changed something on the SD card via the PC, the HHT must be turned off and on again for the changes to take effect.

7.2 Handling data on the SD memory card

Access to the SD memory card takes place via a USB connection to the PC, see section „**8.2 Connection to the PC**“ on page 146.

- The directory structure and names may not be changed.
- The contents of all files as well as their names may not be changed.
- Do not erase any files on the memory card!
The "Log Files" in the "REPORT" directory are an exception and may be copied and erased.

	ATTENTION
	<p>Failure of the system due to incorrect handling of files on the SD memory card!</p> <p>Failure to observe the specification for "Handling data on the SD memory card" can:</p> <ul style="list-style-type: none"> – lead to total failure of the hand-held tool. – lead to incorrect functionality or total failure of the CPC system. – make log files for further processing unusable. <p>▶ Follow the instructions on "Handling data on the SD memory card" to avoid damage to property.</p>

7.3 Directory structure

SD MEMORY CARD

CONFIG
LANGUAGE
REPORT
TEMP
UPDATE

7.4 Log files

The log files that are created when working with the hand-held tool are stored in the "REPORT" directory on the SD memory card, see section „7.3 Directory structure“.

To identify the individual log files, unique names are automatically assigned. These consist of the following data:

- Vehicle name
- Code letter for the menu function executed
 - T = Test-drive
 - D = DTC
 - I = Installation
 - V = "Check all Tires"
- Consecutive counter or date and time

	NOTE
	<p>▶ The use of date and time can be activated under Setup- Tool Properties- Use Date.</p> <p>In this case:</p> <ul style="list-style-type: none">– the file name, date and time are used instead of the consecutive counter.– the date and time are stored in the log files.

The log files can be transmitted to the PC (see sect. „**8.2 Connection to the PC**“ on page 146) and erased if required.

	NOTE
	<ul style="list-style-type: none">▶ Storing of DTCs and log files is not possible without an SD memory card! An error message appears. Remedy:<ul style="list-style-type: none">» Make sure that the SD memory card is inserted in the tool. See section „5.3 Change the memory card“ on page 31» Check access to the SD memory card with "Diagnose/Connection to the PC". See section „8.2 Connection to the PC“ on page 146

	NOTE
	<ul style="list-style-type: none">▶ A software program is offered for evaluating the log files . (See www.contipressurecheck.com/hht).

8 Maintenance

8.1 Software Update for the hand-held tool

To update the software of the hand-held tool, follow the instructions on the homepage:

www.contipressurecheck.com/hht

	NOTE
	<ul style="list-style-type: none">▶ The menu begins with the main setting in English. Select the desired language by following the menu path: "SETUP/LANGUAGE".▶ If no SD memory card is inserted in the hand-held tool or it is no longer responding, only "ENGLISH" is available.▶ After a software update, the hand-held tool must be set up again after selecting the preferred language. See the section „5.5 Setting up the hand-held tool“ on page 34.▶ The previously saved vehicle configurations of the Installation main menu were overwritten with the factory settings during the SW update and must be redefined.

	NOTE
	<ul style="list-style-type: none">▶ Check the website regularly for software updates.

8.2 Connection to the PC

The menu item allows communication between the SD memory card and a PC/Laptop in order to:

- transmit the log files to the PC/Laptop.

Diagnosis - Connection to the PC

For communication (data transfer) with the SD card, the SD card can remain in the hand-held tool. Communication with the PC/laptop takes place via the USB cable.

To establish communication, proceed as follows:

- ◆ Select the "**Diagnosis/Connection to the PC**" menu item and press Enter to confirm.

The following appears:

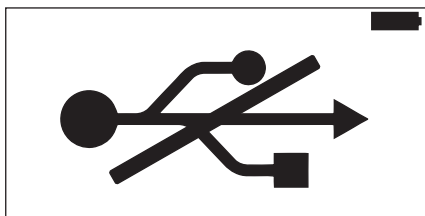

	NOTE
	<p>If the SD memory card is missing or does not respond, language setting is not possible.</p> <ul style="list-style-type: none">▶ Follow the menu path "Diagnosis/Connection to PC" to connect the hand-held tool to the PC.

- ◆ Connect the hand-held tool to the PC/laptop via the USB cable.

The following appears:

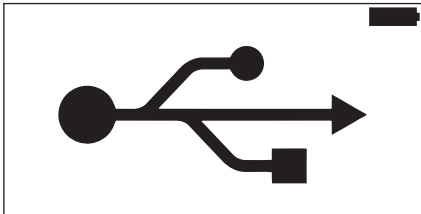

	NOTE
	<ul style="list-style-type: none">▶ This procedure can take a little longer the first time until the hand-held tool is recognized.▶ The connection procedure can take place in reverse order: Connect the USB cable first and then run "Diagnosis/Connection to the PC".

- ◆ The log files in the REPORT directory can be copied or moved to the PC/Laptop.
- ◆ After completing data transfer, log the hand-held tool out of Windows and remove the USB cable.

8.3 Replacing the fuse in the diagnosis cable

If communication with the pressure control indicator or the power supply of the CCU of the trailer system via the diagnosis cable is not possible, the fuse in the diagnosis cable must be replaced.

	NOTE
	<ul style="list-style-type: none">▶ Only use original 315 mA series 373 TR5 fuses from Wickmann.▶ Two replacement fuses are provided for the hand-held tool.

To replace the fuse in the diagnosis cable, proceed as follows:

- ◆ Remove the old fuse (see arrow).

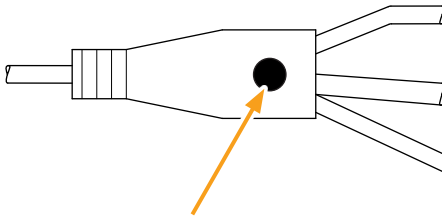

- ◆ Carefully insert the new fuse, pay attention to the position of the pins.

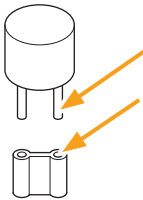

8.4 Cleaning

If dirty, clean the housing of the hand-held tool with a slightly damp, lint-free cloth. Do not use cleaners containing solvents.

8.5 Storage

The following regulations apply to storage:

- Store at a dry place. Maximum relative humidity: 80%, non-condensing
- Protect against direct sunlight. Keep storage temperature between -20 ... +25 °C/-4...77 °F.

i	NOTE
	▶ After using, store the hand-held tool in the transport case supplied.

9 Troubleshooting

9.1 Resetting

If the hand-held tool should not longer react despite charged batteries, it must be reset. To reset the hand-held tool, press in the reset key next to the connecting sockets with a ball-point pen tip or the tip of straightened paper clip.

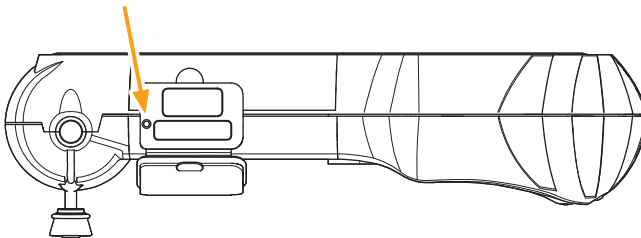

10 Disposal

10.1 Electrical/electronic components

This tool may not be disposed of in the domestic refuse.

The tire hand-held tool contains a lithium battery that is cast into the housing and cannot be replaced. After reaching the end of its service life, the tool must be disposed of in accordance with all current local, regional and national laws and regulations. The tool can be taken to collection points for electrical/electronic component or the CPC sales partner. It can also be sent back to the following CPC collection point.

Address of the central CPC collection point:

Continental Trading GmbH

"Abteilung Entsorgung"

VDO-Straße 1,

Gebäude B14,

64832 Babenhausen

Germany

11 EC Declaration of Conformity

The complete original Declaration of Conformity including the serial number of your device is included in the scope of delivery.

A version without serial number can be found at

www.contipressurecheck.com/hht.

12 Homologation

12.1 Overview

An overview of the existing homologations can be obtained from the corresponding supplementary sheet (Hand-Held Tool Homologation Overview Art. no. 17340490000).

It can also be found at www.contipressurecheck.com/hht/homologation.

12.2 Canada

- Canada, Industry Canada (IC) Notices
“This device complies with Industry Canada license-exempt RSS standard(s). Operation is subject to the following two conditions:
(1) this device may not cause interference,
and
(2) this device must accept any interference, including interference that may cause undesired operation of the device.”

- Canada, avis d'Industry Canada (IC)
“Le présent appareil est conforme aux CNR d'Industrie Canada applicables aux appareils radio exempts de licence. L'exploitation est autorisée aux deux conditions suivantes :
(1) l'appareil ne doit pas produire de brouillage,
et
(2) l'utilisateur de l'appareil doit accepter tout brouillage radioélectrique subi, même si le brouillage est susceptible d'en compromettre le fonctionnement.”

This Class B digital apparatus complies with Canadian ICES-003 plus the RES-GEN, 003 (2010-12) and RSS210, issue 8 (2010-12).

13 Index

Symbole

Disposal150

A

Abbreviations 8

C

Charging state..... 30

Cleaning.....149

Commissioning..... 28

 Charge tool..... 29

 Set up tool 34

 Switch tool ON/OFF 33

Connections..... 22

Connection to the PC146

Control elements 20

Customer service..... 11

 Eliminating errors 11

 Repairs.....11

 Updates..... 11

D

Declaration of Conformity150

Description of functions 19

H

Homologation.....151

I

Intended use 15

L

Liability disclaimer 7

Log files143

M

Manufacturer's address..... 10

Menu control.....25

Menus

Diagnosis

 DTCs.....115

 Software updates132

Installation

 New Installation..... 62

 Resume installation.....90

Modification

 Check Installation.....109

 Modify Parameters.....110

 Modify Sensor IDs.....112

Tire sensor 44

 Activate Sensor 47

 Check sensor 45

 Clear LOOSE state..... 49

 Deactivate Sensor..... 48

Menu structure 23

Modify Installation.....107

O

Operating

 Code sensor.....39

 Handling the tool.....37

 Read sensor 38

R

Replacing the fuse in the
diagnosis cable..... 148

Reset.....149

S

Safety	12
Scope of supply	28
SD memory card	
Change card.....	31
Slot	22
Software Update for the hand-held tool.....	145
Storage.....	149
Symbols.....	9

T

Technical data.....	17
Type plate.....	27

W

Warnings.....	10
Warranty	11

Continental Reifen Deutschland GmbH

Büttnerstraße25

30165 Hanover

Germany

www.contipressurecheck.com

www.continental-truck-tires.com

www.continental-corporation.com