

# INSTALLATION INSTRUCTIONS EASYSTART TIMER



CONTROL UNIT FOR  
EBERSPÄCHER PARKING HEATERS



Eberspächer

A WORLD OF COMFORT

# CONTENTS

CHAPTER	CHAPTER TITLE	PAGE
	CHAPTER CONTENTS	
1	INTRODUCTION	
	Please read first	4
	Safety instructions	4
	Intended use	4
	General information	4
	– Automatic operating time calculation	4
	Ventilation operating mode	4
	– Installation instructions for special functions	4
	Technical data	5
	Order No.	5
	Scope of supply	5
	Can be ordered as an optional extra	5
	Sketch of EasyStart Timer scope of supply	6
	Sketch of optional components	6
2	INSTALLATION	
	Installing the EasyStart Timer	7
	Installing the tab connector of the EasyStart Timer lead harness	7
	Timer installation sketch	8
	Chamber assignment of connector housing (Item 4) and bush housing (Item 5)	8
	-XS10 / -XB10 connector pin assignment table	9
	Connection of bush housing to the control unit lead harness	9
	Install the (optional) temperature sensor	9

# CONTENTS

3	STARTUP / CONFIGURATION	
	Initial startup	10
	Configuring the EasyStart Timer	10
	Opening the vehicle workshop menu	11
	Selecting the settings for the standard configuration	11
	– Selecting the temperature units – Item 2:	11
	– Changing the preset operating time – Item 4.1:	11
	– Resetting to as-delivered condition – Item 5:	12
	– Setting the language – Item 8:	12
	– Select departure time or start time – Item 10:	12
	– Activating or deactivating automatic operating time calculation for water heaters – Item 11.1:	13
	– For automatic operating time calculation, copy the vehicle's engine size (cubic capacity) – Item 11.2:	13
	– For automatic operating time calculation, enter the operating time – Item 11.3:	14
4	WHAT TO DO IF ...?	
	Possible displays in the event of a fault:	15
5	CIRCUIT DIAGRAM	
	– EasyStart Timer connection to Hydronic, Hydronic II, Hydronic II C, Hydronic II Comfort, Hydronic M II	17
	– EasyStart Timer connection to Airtronic, Airtronic M, Airtronic L	18
6	SERVICE	
	EC Declaration of Conformity	19
	Hotline	19

# 1 INTRODUCTION

## PLEASE READ FIRST

Before you start to install the EasyStart Timer, always read through these installation instructions carefully.

These installation instructions contain important information, which you need to install the EasyStart Timer.

## SAFETY INSTRUCTIONS



### **DANGER!**

Always note and follow all information and notes, especially the safety instructions in this document and in the heater's technical description!

## INTENDED USE

The EasyStart Timer is used to select the operating mode, to set the operating time, to preselect the switching on time and to switch On / Off the heater and / or add-on unit installed in the vehicle.

### **PLEASE NOTE!**

Improper use and use outside the specified purpose cancels all liability and warranty.

## GENERAL INFORMATION

### AUTOMATIC OPERATING TIME CALCULATION

To use the AUTOMATIC OPERATING TIME CALCULATION function of a water heater, the optionally available temperature sensor must be used.

For temperature sensor Order No. [see page 5](#).

### VENTILATION OPERATING MODE

In VENTILATION mode the fan of water heaters is actuated directly by bypassing heating mode. If the  symbol is not displayed the VENTILATION function is not available for the heater.

If you have any further questions about VENTILATION mode, please dial the service telephone number [see page 19](#).

### INSTALLATION INSTRUCTIONS FOR SPECIAL FUNCTIONS

These installation instructions describe the standard configuration. For enhanced configuration of the EasyStart Timer and for special functions, e.g. combinations with different EasyStart control units, installation in ADR vehicles, operating the heater and additional unit, etc. refer to the Installation Instructions Plus "Special Functions and Diagnosis": these can be viewed and downloaded from the Eberspächer Service portal.

# 1 INTRODUCTION

## TECHNICAL DATA

Operating voltage	12 volt / 24 volt
Dimensions	W: 82 mm, H: 37 mm, D: 12 mm
allowable ambient temperature	- 40 °C to +85 °C
LCD ambient temperature	The display becomes sluggish in temperatures below -10 °C, i.e. the flashing sequence of the symbols is somewhat slower, the contrast becomes weaker above +70 °C.

## ORDER NO.

EasyStart Timer 12 / 24 volt	22 1000 34 15 00
------------------------------	------------------

## SCOPE OF SUPPLY

Sketch [see page 6](#).

No. in sketch	Quantity	Designation
1	1	EasyStart Timer 12 / 24 volt
2	1	Bracket
3	1	Foam underlay
4	1	Connector housing, 10-pin (in the bag)
5	1	Bush housing, 10-pin (in the bag)
6	2	Contact locking devices (in the bag)
7	8	Contacts (in the bag)
8	1	Self-tapping screws (in the bag)
9	1	Template
10	1	Installation instructions
11	1	Quick start guide

## CAN BE ORDERED AS AN OPTIONAL EXTRA

Sketch of optional components [see page 6](#).

No. in sketch	Quantity	Designation	Order No.
12	1	Temperature sensor	22 1000 34 22 00
13	1	Cover	22 1000 51 41 00

# 1 INTRODUCTION

## SKETCH OF EASYSTART TIMER SCOPE OF SUPPLY

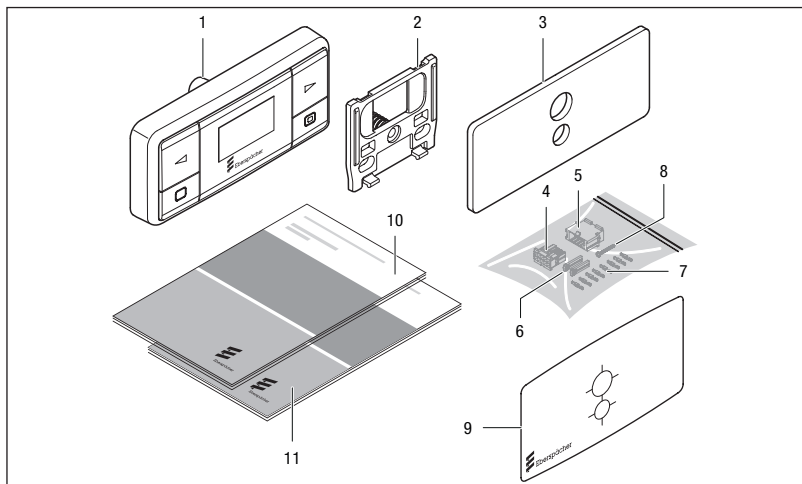

Key [see page 5](#)

## SKETCH OF OPTIONAL COMPONENTS

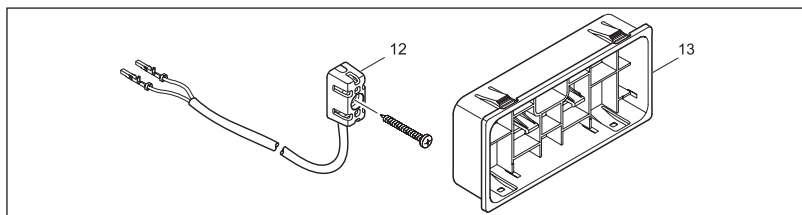

Key [see page 5](#)

### PLEASE NOTE!

- Note on the temperature sensor: A temperature sensor is not required for air heaters. The temperature sensor that is installed in the heater and which controls the temperature inside the vehicle is also used for the EasyStart Timer temperature display.
- Detailed operating instructions are available to view and download from [www.eberspaecher-standheizung.com/download](http://www.eberspaecher-standheizung.com/download).

## 2 INSTALLATION

### INSTALLING THE EASYSTART TIMER



#### CAUTION!

When drilling the fixing and connection holes in the dashboard, concealed components behind it could be damaged.

- ➔ Check that the space behind the installation area is free from components.

Install the EasyStart Timer in a suitable place on the dashboard, within the driver's view and connect as shown in the sketch on [page 8](#) and the circuit diagram [from page 17](#).

- Use the self-adhesive drilling template supplied to position and drill the two holes  $\varnothing 6.5$  mm and  $\varnothing 9$  mm. After drilling the holes, remove the drilling template.
- The foam underlay can be used if necessary to level out unevenness. To do this, pull off the protective film and stick the foam underlay onto the installation area. Then pull off the second protective film.
- Insert the holder with expansion plug into the drillhole  $\varnothing 6.5$  mm.
- Align the holder, if applicable, press the holder firmly onto the foam underlay.
- Screw the fixing screw into the expansion plug and therefore fasten the holder.
- Feed the lead harness from the EasyStart Timer through the drillhole  $\varnothing 9$  mm.
- Clip the EasyStart Timer into the holder.

### INSTALLING THE TAB CONNECTOR OF THE EASYSTART TIMER LEAD HARNESS

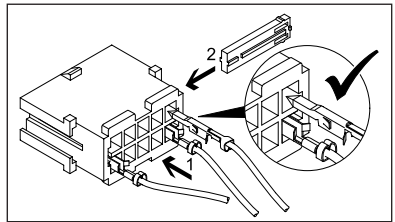

- Plug the tab connector (1) of the EasyStart Timer lead harness into the 10-pin connector housing (For details of connector housing pin assignment [see page 8](#) and [page 9](#)).
- Push the contact locking device (2) into the connector housing.

#### PLEASE NOTE!

When installing the connector, ensure that the locking tangs always face the middle of the connector. Only in this position to the tangs latch into the housing (see sketch).

## 2 INSTALLATION

### TIMER INSTALLATION SKETCH

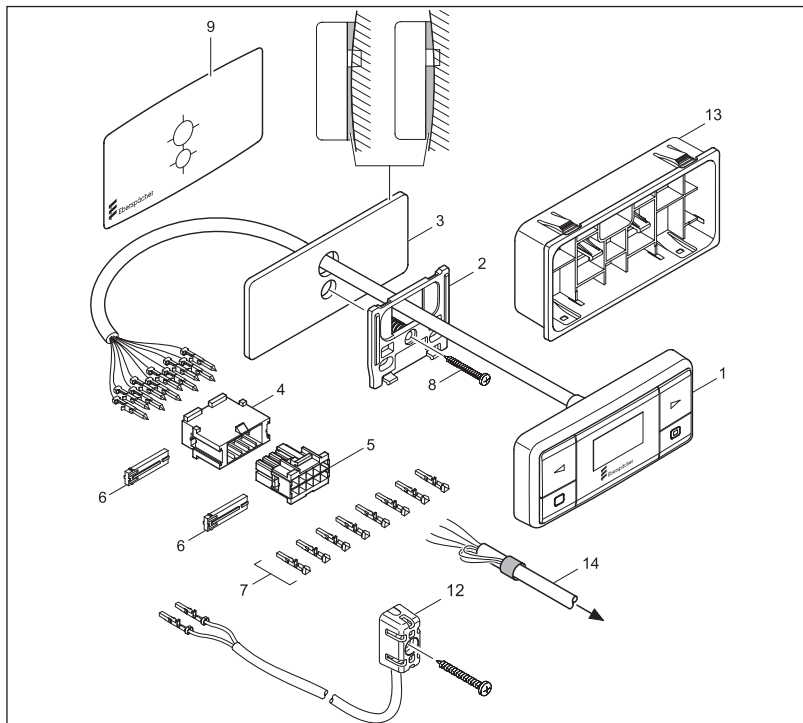

Key [see page 5](#)

### CHAMBER ASSIGNMENT OF CONNECTOR HOUSING (ITEM 4) AND BUSH HOUSING (ITEM 5) (Assignment seen from the cable inlet side)

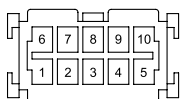

-XS10 (Item 4)

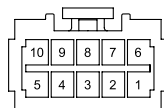

-XB10 (Item 5)



## 2 INSTALLATION

### -XS10 / -XB10 CONNECTOR PIN ASSIGNMENT TABLE

Pin	Signal	Cable colour	Cross-section
1	Terminal 30	red	0.35 mm <sup>2</sup>
2	Terminal 58	grey / black	0.22 mm <sup>2</sup>
3	Terminal 31	brown	0.35 mm <sup>2</sup>
4	Diagnosis	blue / white	0.22 mm <sup>2</sup>
5	DAT cable	violet	0.22 mm <sup>2</sup>
6	S+	yellow	0.35 mm <sup>2</sup>
7	ADR	brown / yellow	0.22 mm <sup>2</sup>
8	ADR	white / red	0.22 mm <sup>2</sup>
9	Temp (-)	brown / white	0.22 mm <sup>2</sup>
10	Temp (+)	grey	0.22 mm <sup>2</sup>

### CONNECTION OF BUSH HOUSING TO THE CONTROL UNIT LEAD HARNESS

- Clip the control unit lead harness into the 10-pin bush housing; note and follow the circuit diagram.
- Push the contact locking device into the bush connector housing.
- Connect the bush housing of the control unit lead harness and the connector housing of the EasyStart Timer lead harness.
- Insulate and tie back any cable ends that are not needed.

### INSTALL THE (OPTIONAL) TEMPERATURE SENSOR

Plug the connector of the (optional) room temperature sensor lead harness into the 10-pin bush housing of the control unit lead harness. For connection details, see -XS10 / -XB10 connector pin assignment table.

Use the screw provided to fasten the temperature sensor inside the vehicle so that it measures the representative interior temperature.

Recommendation:

Install the temperature sensor in the centre console, at the level of the seats.

#### PLEASE NOTE!

- Install the EasyStart Timer in the vehicle interior only.
- Do not position the temperature sensor in an area in which is exposed to direct sunlight, near the outlet vents of the vehicle or in the footwell.
- For circuit diagrams see [from page 17](#).
- Do not insert the control unit 5 A fuse into the fuse holder until all work has been completed.

## 3 STARTUP / CONFIGURATION

### INITIAL STARTUP

For the initial startup, the following steps must be carried out one after the other.

#### APPLYING THE OPERATING VOLTAGE

The operating voltage is applied by inserting the 5 A fuse into the fuse holder.

After applying the operating voltage INIT appears in the display.



Note: The timer checks which type of heater is connected and configures the Menu bar (automatic detection).

#### SETTING THE TIME

Use the ◀ or ▶ button to set the hours.



Press the ◻ button to confirm the setting.

Use the ◀ or ▶ button to set the minutes.



Press the ◻ button to confirm the setting.

#### SETTING THE WEEKDAY

Use the ◀ or ▶ button to set the weekday.



Press the ◻ button to confirm the setting. Then configure the EasyStart Timer.

#### CONFIGURING THE EASYSTART TIMER

The system must be configured according to its use.



#### PLEASE NOTE!

These installation instructions describe the standard configuration. For details of enhanced configuration of the EasyStart Timer and special functions, you can view and download the “Special Functions and Diagnosis” installation instructions from [www.eberspaecher-standheizung.com/download](http://www.eberspaecher-standheizung.com/download).

## 3 STARTUP / CONFIGURATION

### OPENING THE VEHICLE WORKSHOP MENU

Display On, the Start display appears.

Use the ◀ or ▶ button to select the  symbol in the Menu bar.

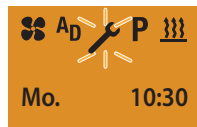

Confirm the SETTINGS menu item by pressing the  button.



Press the  LONGPRESS button for longer than 5 sec.; the Workshop menu is displayed.

### SELECTING THE SETTINGS FOR THE STANDARD CONFIGURATION

#### SELECTING THE TEMPERATURE UNITS – ITEM 2:

Default: °C

Use the ◀ or ▶ button to select Item 2: and confirm by pressing the  button.

Use the ◀ or ▶ button to select the temperature units °C or °F.

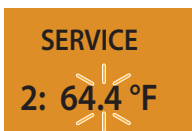

Press the  button to confirm the selection.

#### CHANGING THE PRESET OPERATING TIME – ITEM 4.1:

Default: Water heater = 30 min. / Air heater = continuous heating mode

Use the ◀ or ▶ button to select Item 4.1: and confirm by pressing the  button.

The ◀ or ▶ button can be used to set the operating time.

Operating time setting range:

10 – 120 min. in 1 min. increments, continuous heating mode is possible for air heaters. From the 120th min. the operating time can be extended in 5 min. increments up to 720 min.





Press the  button to confirm the setting.

### 3 STARTUP / CONFIGURATION

RESETTING TO AS-DELIVERED CONDITION –  
ITEM 5:

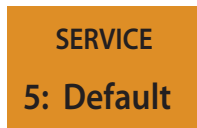
Use the  or  button to select Item 5.



Press the  button to confirm the selection.



Press the  button to confirm the selection.





Following the automatic detection the current time and the current weekday must be entered.

Then the Start display appears.

SETTING THE LANGUAGE – ITEM 8:

Default: DE

Use the  or  button to select Item 8: and confirm by pressing the  button.



Use the  or  button to select the language DE or EN.





Press the  button to confirm the selection.

SELECT DEPARTURE TIME OR START TIME –  
ITEM 10:

Default: "Off" for departure time

Use the  or  button to select Item 10: and confirm by pressing the  button.

Use the  or  "Off" button for the departure time or "On" to select the start time.



Departure time

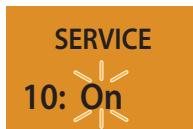

Start time





Press the  button to confirm the selection.

After confirming you must reset the system by removing the 5 A fuse.

### 3 STARTUP / CONFIGURATION

#### ACTIVATING OR DEACTIVATING AUTOMATIC OPERATING TIME CALCULATION FOR WATER HEATERS – ITEM 11.1:

Default: "Off"

Use the  or  button to select Item 11.1: and confirm by pressing the  button. Use the  or  button to select "Off" or "On".



Press the  button to confirm the selection. After confirming you must reset the system by removing the 5 A fuse.





#### **PLEASE NOTE!**

Automatic operating time calculation is not possible for air heaters; if Item 11.1: is selected the following appears in the display:



#### FOR AUTOMATIC OPERATING TIME CALCULATION, COPY THE VEHICLE'S ENGINE SIZE (CUBIC CAPACITY) – ITEM 11.2:

Default: 1800 cm<sup>3</sup>

Use the  or  button to select Item 11.2: and confirm by pressing the  button. Use the  or  button to enter the engine size in 100 cm<sup>3</sup> increments. Setting range: 1000 cm<sup>3</sup> to 4000 cm<sup>3</sup>.



Press the  button to confirm the setting.

#### **PLEASE NOTE!**

The engine size entered can be increased by 500 cm<sup>3</sup> for a larger heat requirement. If the valve 25 2014 80 62 00 or 25 2014 80 72 00 is used in the water circuit, the engine size entered can be reduced by 500 cm<sup>3</sup>.

The values for the increase or reduction in the engine size entered are only valid for cooling water circuit, whose vehicle fan heat exchanger is flowed through before the vehicle engine.

### 3 STARTUP / CONFIGURATION

FOR AUTOMATIC OPERATING TIME  
CALCULATION, ENTER THE OPERATING TIME –  
ITEM 11.3:

Default: 60 minutes

Use the ◀ or ▶ button to select Item  
11.3: and confirm by pressing the ◻ button.

Use the ◀ or ▶ button to set the operat-  
ing time.

Setting range: 10 – 60 minutes.







Press the ◻ button to confirm the setting.

#### PLEASE NOTE!

- Press the ◻ button to exit the Workshop menu.
- If the vehicle is only used for short trips, consult the customer and reduce the maximum operating time.
- Carry out a function test after configuration.

## 4 WHAT TO DO IF ...?

### POSSIBLE DISPLAYS IN THE EVENT OF A FAULT:

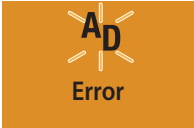
DISPLAYS	DESCRIPTION	REMEDY / WORKSHOP
	<ul style="list-style-type: none"> <li>Automatic detection is active.</li> <li>The timer has been disconnected from the voltage and reconnected.</li> </ul>	Wait until the automatic detection has ended, then set the time and weekday.
	<ul style="list-style-type: none"> <li>The timer has been disconnected from the voltage and reconnected.</li> <li>The automatic detection has ended.</li> </ul>	Set the time (hours and minutes) and the weekday. Then the Start display appears.
	<ul style="list-style-type: none"> <li>No communication.</li> </ul>	<ul style="list-style-type: none"> <li>Check and if necessary renew the heater fuse.</li> <li>Check the voltage supply.</li> <li>Check the wiring.</li> </ul>
	<ul style="list-style-type: none"> <li>1st heater fault.</li> </ul>	Perform the heater diagnosis.
	<ul style="list-style-type: none"> <li>2nd heater fault.</li> </ul>	Perform the heater diagnosis.

## 4 WHAT TO DO IF ...?

### DISPLAYS



### DESCRIPTION

- Voltage too low.

### REMEDY / WORKSHOP

- Charge the battery.
- Check the heater's power supply.

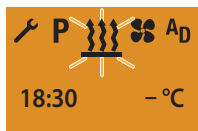

- Temperature sensor is defective.

Check and if necessary renew the temperature sensor.

### PLEASE NOTE!

If the error or fault could not be corrected, dial the service phone number [on page 19](#).



## 5 CIRCUIT DIAGRAM

### CIRCUIT DIAGRAM

EasyStart Timer connection to Hydronic, Hydronic II, Hydronic II C, Hydronic II Comfort, Hydronic M II

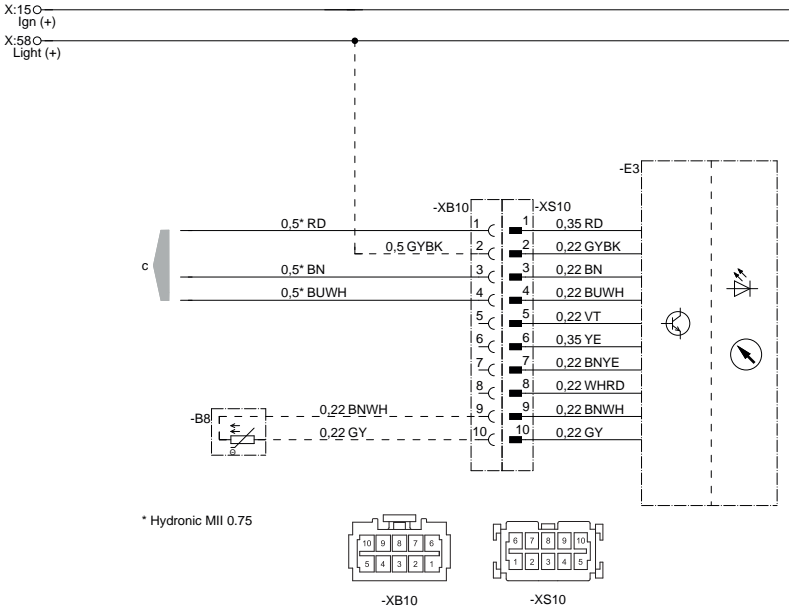

22 1000 34 97 01

- E3 EasyStart Timer
- B8 Temperature sensor (optional)
- c to the heater

### CABLE COLOURS

RD	red	GY	grey	BK	black
BU	blue	YE	yellow	GN	green
WH	white	VT	violet	BN	brown

## 5 CIRCUIT DIAGRAM

### CIRCUIT DIAGRAM

EasyStart Timer connection to Airtronic, Airtronic M, Airtronic L

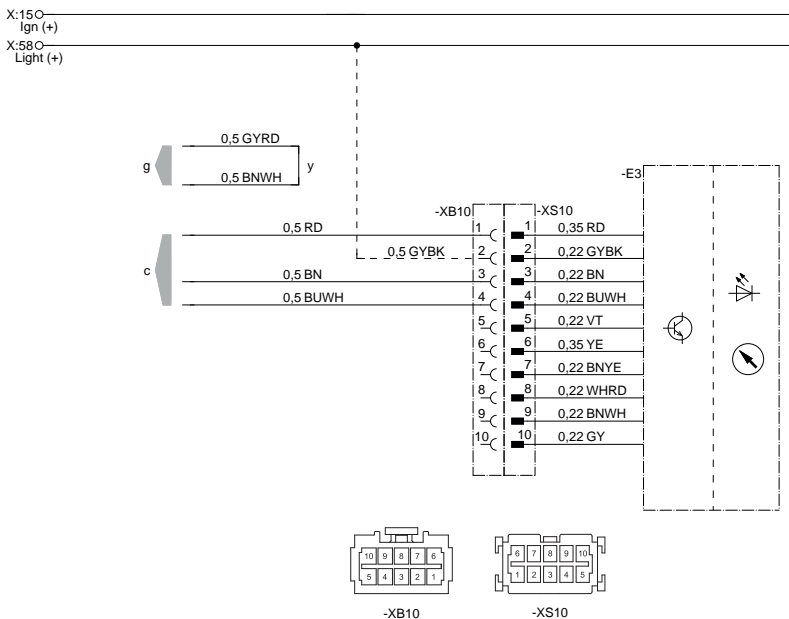

22 1000 34 97 02

-E3 EasyStart Timer

- c to the heater
- g to the heater
- y Connect cables and insulate

### CABLE COLOURS

RD	red	GY	grey	BK	black
BU	blue	YE	yellow	GN	green
WH	white	VT	violet	BN	brown

## 6 SERVICE

### EC DECLARATION OF CONFORMITY

The manufacturer:

**BURY GmbH & Co. KG**

herewith declares that the

#### **EasyStart Timer**

unit complies with the fundamental requirements and the other relevant provisions of Directive 2004/108/EC and 2009/19/EC Annex VII, VIII.

A copy of the Declaration of Conformity is available from Bury GmbH & Co. KG on request.

### HOTLINE

If you have any technical questions, a problem with the EasyStart Timer or the heater, dial the following service phone number from within Germany:

Hotline: 03976 2350235

Fax hotline: 01805 262624

Outside of Germany, please contact the respective Eberspächer national representative.

**Headquarters:**

Eberspächer Climate Control Systems

GmbH & Co. KG

Eberspächerstraße 24

73730 Esslingen

Hotline: 03976 2350235

Fax hotline: 01805 262624

[info@eberspaecher.com](mailto:info@eberspaecher.com)

[www.eberspaecher.com](http://www.eberspaecher.com)

