

DHOLLANDIA

DH-CH103

DOT-Public Use Lift OPERATION MANUAL

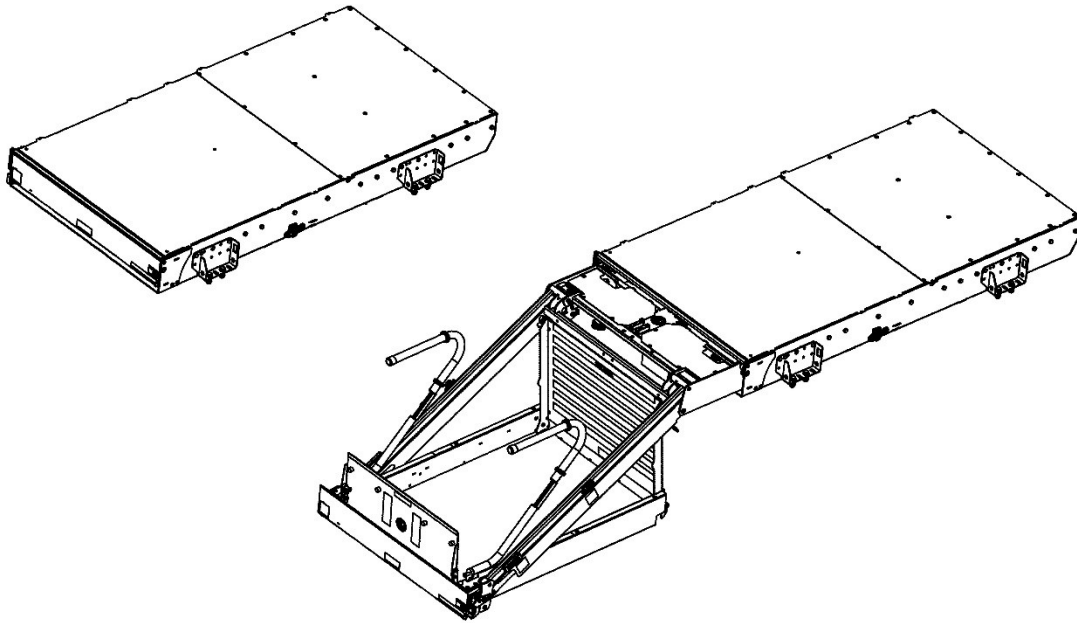

Manufacturer:
DHOLLANDIA US, L.L.C.
E-mail : us.info@dhollandia.com
270 Southridge Parkway
Bessemer City North Carolina, 28016
website : www.dhollandia.com



Read the manual in its entirety before operating the wheelchair lift

Keep this manual in the vehicle cab, as reference for the driver and wheelchair lift operator

“DOT-Public Use Lift’ verifies that this platform lift meets the “public use lift” requirements of FMVSS No. 403. This lift may be installed on all vehicles appropriate for the size and weight of the lift, but must be installed on buses, school buses, and multi-purpose passenger vehicles other than motor homes with a gross vehicle weight rating (GVWR) that exceeds 4536 kg (10000 lb).

TABLE OF CONTENTS

1	INTRODUCTION	3
1.1	General introduction	3
1.2	Public use lift	3
1.3	Contact information and disclaimers	4
1.4	Understanding safety and warning signs	5
1.5	Safety precautions for operation	6
1.6	Identification	7
2	DESCRIPTION AND WHEELCHAIR LIFT TERMINOLOGY	8
2.1	General	8
2.2	Safety measures	12
3	THRESHOLD MODULE	16
4	SAFETY INSTRUCTIONS FOR USING THE WHEELCHAIR LIFT	17
4.1	DO NOT use wheelchair lift without adequate safety and operator training	17
4.2	General safety instructions	18
4.3	Danger zones, risk of crush and shear injury	22
4.4	Additional instructions for the wheelchair occupants/ standees	25
4.5	Loading diagram	27
4.6	Recommended daily pre-trip inspection	29
4.7	Importance of preventative maintenance	30
5	OPERATING INSTRUCTIONS - PRINCIPLES AND PROCEDURES	31
5.1	Control unit	31
5.2	Switching the main power on/off	31
5.3	Standard operation instructions	32
6	EMERGENCY OPERATION	38
7	TROUBLESHOOTING AND REPAIR	41
7.1	Introduction	41
7.2	General troubleshooting diagram	41
8	DECALS	42
8.1	Regular decals	42
8.2	Decals on inside of bus	44
9	MEANING OF SAFETY AND WARNING SIGNS	46
10	END NOTE	48

1 INTRODUCTION

1.1 GENERAL INTRODUCTION

- This OPERATION MANUAL explains how the DHOLLANDIA wheelchair lift is manufactured, what safety devices are incorporated in its design and how to use the wheelchair lift in a correct manner, that preserves the integrity of the machine over the intended lifetime and helps maximize the safety of the operator and any bystanders.
- The MAINTENANCE AND REPAIR MANUAL (separate) explains how to maintain and service the wheelchair lift in the appropriate manner, maximizing the safety of the operator and any bystanders and ensuring the reliability of the wheelchair lift over the intended lifetime.
- The manuals must be kept with the wheelchair lift at all times, as a reference book for the operators and technical service.



WARNING

- Improper use of the wheelchair lift will put the operator and other parties at great risk of serious bodily injury and death. Therefore, the use of the wheelchair lift is restricted to skilled operators only; who have been properly trained, and who know and understand the full contents of this manual.
- Unauthorized modifications to the wheelchair lift can put the operator and other parties at great risk of serious bodily injury and death. Therefore, it is strictly forbidden to modify the wheelchair lift and its safety devices in any way.
- The use of aftermarket or non-OEM replacement parts to repair the wheelchair lift is strictly prohibited and may result in serious bodily injury or death of the operator or any bystanders.

1.2 PUBLIC USE LIFT

- **DHOLLANDIA public use lifts** [DH-CH...series used for commercial purposes] are designed to be fitted to vehicles with a gross vehicle weight rating (GVWR) that exceeds 4,536 kg (10,000 lb) (buses, school buses, and multi-purpose passenger vehicles other than motor homes), and shall be used exclusively to assist wheelchair passengers to embark and disembark the vehicle.
- The lift shall be used with obedience of the loading diagram, and the user's- and safety instructions contained in this manual.



WARNING

- Improper use of the lift will put the operator and bystanders at great risk of serious bodily injury and death. Therefore, it is strictly forbidden to use the lift in a different way, or for different purposes than described in the operation manual.
- The lift shall NEVER be used as an elevated work platform, to push loads, to move snow or other debris.
- DHOLLANDIA disclaims liability for any personal injury and / or property damage that results from improper use.

1.3 CONTACT INFORMATION AND DISCLAIMERS

DHOLLANDIA wheelchair lifts are regularly being adapted to new vehicle- and chassis developments and specialized customer requirements. Therefore, DHOLLANDIA reserves the right to alter product specifications without prior notice and potentially modifications or new developments might not have been taken into account at the time of printing.

NOTICE

Please confirm you have reviewed the most up-to-date version of this manual prior to operation of the associated DHOLLANDIA wheelchair lift. See below for instructions to download the latest version of the manual.

Contact your national DHOLLANDIA distributor if you have any questions regarding the installation, operation, repair and maintenance of DHOLLANDIA wheelchair lifts, to obtain replacement copies of manuals or decals, or to learn about available equipment options for DHOLLANDIA wheelchair lifts.

DHOLLANDIA US, LLC
United States - West
12968 Santa Ana Avenue
Fontana CA 92337
Tel: 855-856-8225
Sales.USA@dhollandia.com

DHOLLANDIA US, LLC
United States - East
200 Hilton Street West
Easton PA 18042
Tel: 855-894-1188
Sales.USA@dhollandia.com

DHOLLANDIA CANADA, Inc.
Canada
2105 Boulevard des Entreprises
Terrebonne Quebec J6Y1W9
Tel: 888-750-5438
Sales.CANADA@dhollandia.com

DHOLLANDIA MEXICO, Inc.
Mexico
Fraccionamiento Industrial
Dinamo del Norte,
Calle Tierra 103-105
C.P. 65500, Salinas Victoria,
Monterrey- Nuevo Leon
Tel: +52 81 13340968
Sales.MEXICO@dhollandia.com



The latest version of all manuals can also be downloaded from the DHOLLANDIA website

www.dhollandia.com → **Downloads** → **User's manuals** → ... select required manual

- Take notice of following important disclaimers:

DISCLAIMERS

- DHOLLANDIA disclaims liability for any personal injury, death, or property damage that results from **operating a wheelchair lift that has been modified from the original design**, without explicit written approval from the manufacturer.
- DHOLLANDIA disclaims liability for any personal injury, death, or property damage that results from the **use of aftermarket or non-OEM replacement parts for service or repair of the wheelchair lift**.
- DHOLLANDIA disclaims liability for any personal injury, death, or property damage that results from **improper use of the wheelchair lift**.
- DHOLLANDIA disclaims liability for any personal injury, death, or property damage that results from **overloading or improperly loading the platform**, disregard of the maximum rated lift capacity and the applicable load charts.
- There are no warranties, express or implied, including the warranty of merchantability or a warranty of fitness for a particular purpose extending beyond that set forth in this manual.

1.4 UNDERSTANDING SAFETY AND WARNING SIGNS

- Many safety signs and symbols used in this manual are based on international standards, others refer to specific situations or actions.
- Consult section 9 for an overview of signs and symbols used in DHOLLANDIA manuals and their meaning. Make sure you understand these signs and symbols prior to starting the installation.

Examples of standard ANSI signs				
Examples of DHOLLANDIA purpose made signs				

- Please take special notice of the following signs used in the manual. They indicate the likelihood and severity of a potential injury if a person fails to follow the instructions presented on the safety sign.



DANGER: indicates an imminently hazardous situation which, if not avoided, will result in death or serious injury. [white letters on red background]



WARNING: indicates a potentially hazardous situation which, if not avoided, could result in death or serious injury. [black letters on orange background]



CAUTION: indicates a potentially hazardous situation which, if not avoided, could result in minor or moderate injury. [black letters on yellow background]



NOTICE: is used to address practices not related to physical injury. [white letters on blue background]



SAFETY INSTRUCTIONS: indicate general instructions relative to safe work practices, reminders of proper safety procedures, or the location of safety equipment. [white letters on green background]



SAFETY ALERT SYMBOL: is used to alert the user to potential hazards. All safety messages that accompany this sign shall be obeyed to avoid possible harm. [free-standing, or on background colours red, orange, yellow or black]



- Failure to understand and to follow the instructions in this manual can put the operator and any bystanders at great risk of serious bodily injury and death.
- Prior to operating the wheelchair lift, make sure you understand the safety and warning signs used, and read them in conjunction with the instructions in this manual.
- If in doubt, DO NOT operate the wheelchair lift. Contact your national DHOLLANDIA distributor. See page 4 for contact info.

1.5 SAFETY PRECAUTIONS FOR OPERATION



- It is essential that the personnel involved in installing, servicing and repairing wheelchair lifts know, understand and apply the safety instructions and precautions contained in the OPERATION MANUAL issued with the wheelchair lift.
- Therefore, make sure you consult the OPERATION MANUAL prior to installing or operating the wheelchair lift.



WARNING

- Improper use of the wheelchair lift will put the operator and other parties at great risk of serious bodily injury and death.
- To reduce the risk of serious bodily injury to the operator and any bystanders, the use of the wheelchair lift is restricted to skilled operators, who have been properly trained, and who know and understand the full contents of the OPERATION MANUAL.
- To reduce the risk of serious bodily injury or death, THE OPERATOR MUST COMPLY WITH ALL SAFETY INSTRUCTIONS AND WARNING LABELS IN THE OPERATION MANUAL before and while operating the wheelchair lift.
- Please confirm you have reviewed the most up-to-date version of this manual prior to installation and operation of the associated DHOLLANDIA wheelchair lift.

1.6 IDENTIFICATION

- Every DHOLLANDIA wheelchair lift is identified by and labelled with a **unique 8-digit serial number** (with or without a space between the first and last 4 digits). Use this number for any inquiry on a particular wheelchair lift, or when ordering replacement parts.
- In addition to the wheelchair lift type and serial number, the various serial number labels provide additional information such as: the maximum rated lift capacity and load chart, the date of manufacture, etc...
- These labels are usually affixed to various wheelchair lift components and can be found in following locations (the yellow arrows point to the serial numbers):



Affixed to the side of the vehicle body, or on the platform

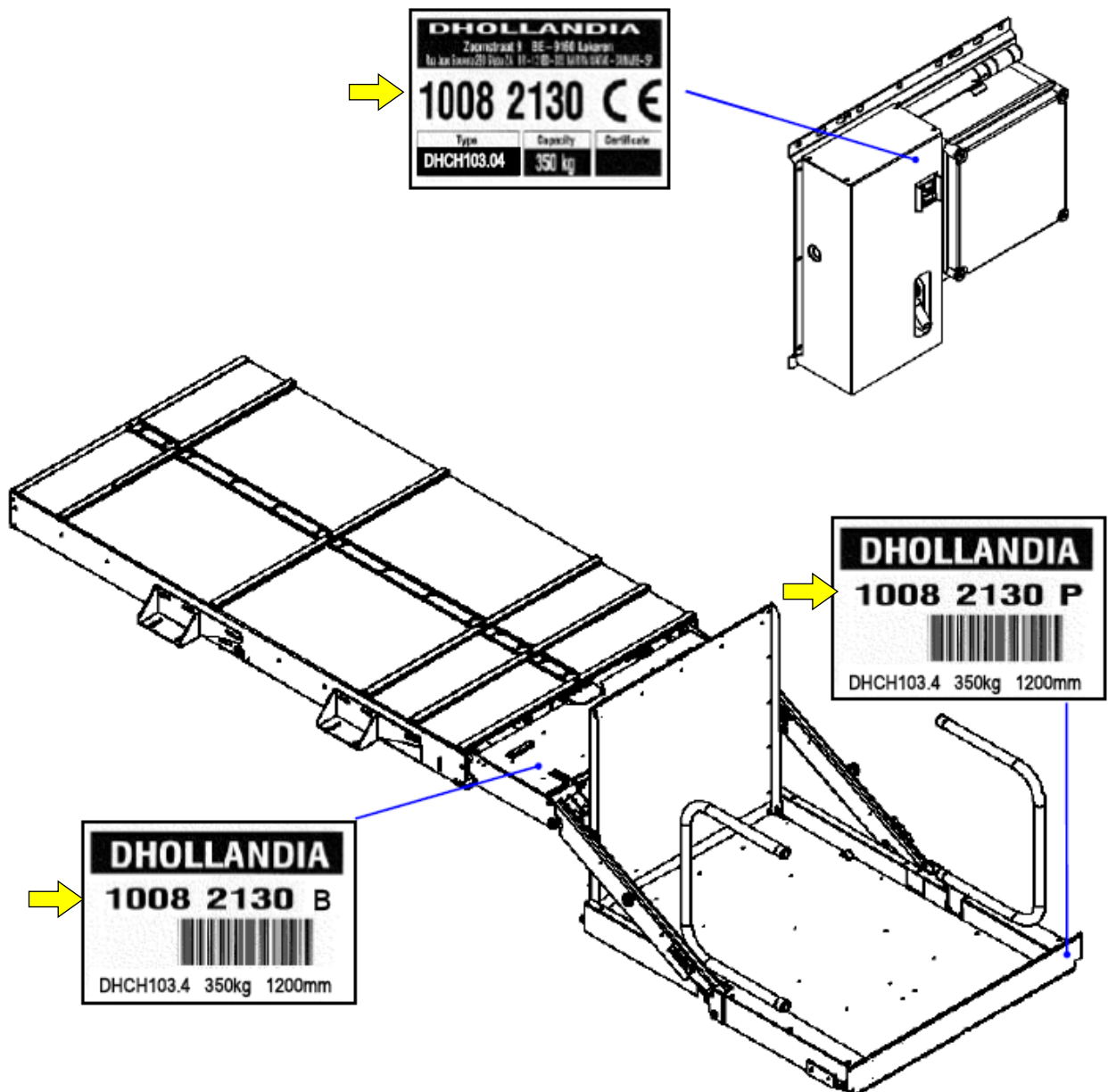

2 DESCRIPTION AND WHEELCHAIR LIFT TERMINOLOGY

2.1 GENERAL

- DHOLLANDIA lifts are developed and manufactured using state-of-the-art technology, high quality materials and components, and comply with the European CE safety regulations mentioned in the Declaration of Conformity (unless agreed otherwise upon ordering - export outside CE region) and the FMVSS 403-404 for US.
- The **DH-CH... series passenger lifts** are retractable lifts, whose lift mechanism and platform are stowed in a closed cassette box in travel position. This cassette can be mounted to the chassis of the vehicle, in a luggage compartment or integrated in one of the steps of the stairs at the access door.
- Main details and terminology: see below

DH-CH103* • TERMINOLOGY

See figure below for parts corresponding to numbers in this table

#	Description
1	Cassette: sealed box housing the lift frame and platform when stowed in travel position, and protecting the mechanism against adverse weather conditions. The cassette is equipped with slide rails and a retraction system to slide the lift frame and the platform from a travel position deep inside the cassette to a work position at the outboard edge of the cassette, and vice versa.
2	Mounting brackets: brackets used to mount the cassette to the vehicle.
3	Lift frame: steel assembly incorporating the lift arms and lift cylinders, who together carry the platform. The lift frame is moved in and out of the cassette by means of an electric motor and gearwheel system.
4	Lift arms + lift cylinders: 2 lift arms L+R actuated by the lift cylinders, used to lift / lower the platform and its load (= functions UP / DOWN).
5	Platform: carries the load during lifting / lowering. The platform is covered with an aluminium top plate with a non-slip surface. It is further equipped with a bridge plate, handrails and a roll stop flap.
6	Flashing platform lights: used to make the platform visible to other parties in traffic.
7	Bridge plate: plate mounted at the inboard platform edge, used to bridge any gap between the platform and the vehicle floor when the platform is raised to its maximum height.
8	Handrails: Rails mounted at both sides of the platform. Lift occupants should hold on to these handrails to prevent them from falling off the platform. Handrails must be deployed manually and secured in vertical position prior to using the lift, they must be stowed manually before retracting the lift back into its travel position.
9	Roll stop: roll stop mounted at the outboard platform edge. The roll stop is tilted up automatically when the platform leaves the ground, it is tilted down automatically when the platform touches the ground. The roll stop prevents the wheelchair from slowly and unexpectedly rolling off the platform during lifting and lowering. It is not designed to stop fast and powered movements.
10	Automatic cassette lock: in regular conditions, the lift frame and platform are automatically locked inside the cassette by means of a lock mounted at the inboard edge of the cassette.
11	Emergency cassette lock: in emergency conditions (in case of an electrical power failure) the automatic cassette lock can be disengaged, and the platform and lift frame can be pulled out by hand.
12	Wander lead with spiral cable: control box to execute all functions DEPLOY – UP – DOWN - STOW. In standard configuration, the wander lead features 4 buttons for 4 functions. The wander lead is equipped with an emergency button that immediately stops all electrical functions when activated.
13	Hydraulic power pack: contains the electric motor driving the hydraulic pump, the oil tank, and the control valves.
14	Threshold module: Guarantees a safe departure from the vehicle floor. It also makes sure the wheelchair lift will only initiate and continue the lift action when the threshold area is clear, in conformity with FMVSS requirements.

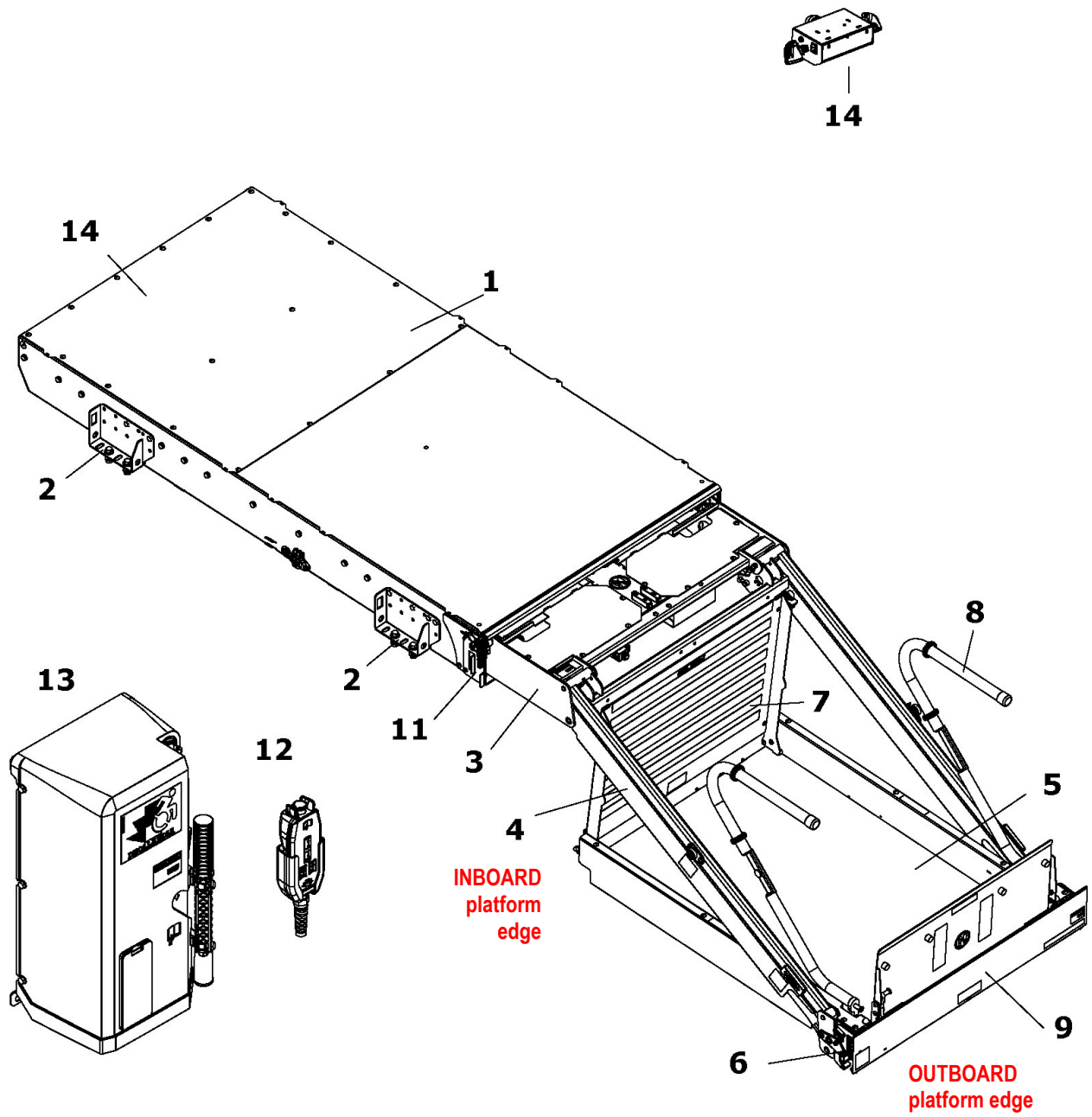

POWER PACK • TERMINOLOGY

See figure below for parts corresponding to numbers in this table

#	Description
1	Power pack: sealed box containing the electric motor and hydraulic pump, the oil tank, control valves, electronic control unit and various emergency controls that can be operated in case of an electrical power failure.
2	Removable cover: can be removed to get access to the electric motor and hydraulic pump, the oil tank, control valves and electronic control unit.
3	Hydraulic hand pump: manual back-up pump to lift the platform in case of an electrical power failure (= function UP). The lever [# 3a] for the hand pump is stored at the front face of the cover of the power pack.
4	Emergency Descent button: manual back-up button to lower the platform in case of an electrical power failure (=function DOWN).
5	EMR = Emergency Motor Release: in regular mode, the lift frame and platform are blocked inside the cassette, and cannot be pulled out by hand easily. When turning the EMR button, the lift frame and platform are unlocked inside the cassette, and they can be pulled out by hand much more easily. After emergency use, the EMR button MUST be reset in its initial position.
6	Electric connection: plug for the connection of the wander lead with spiral cable.

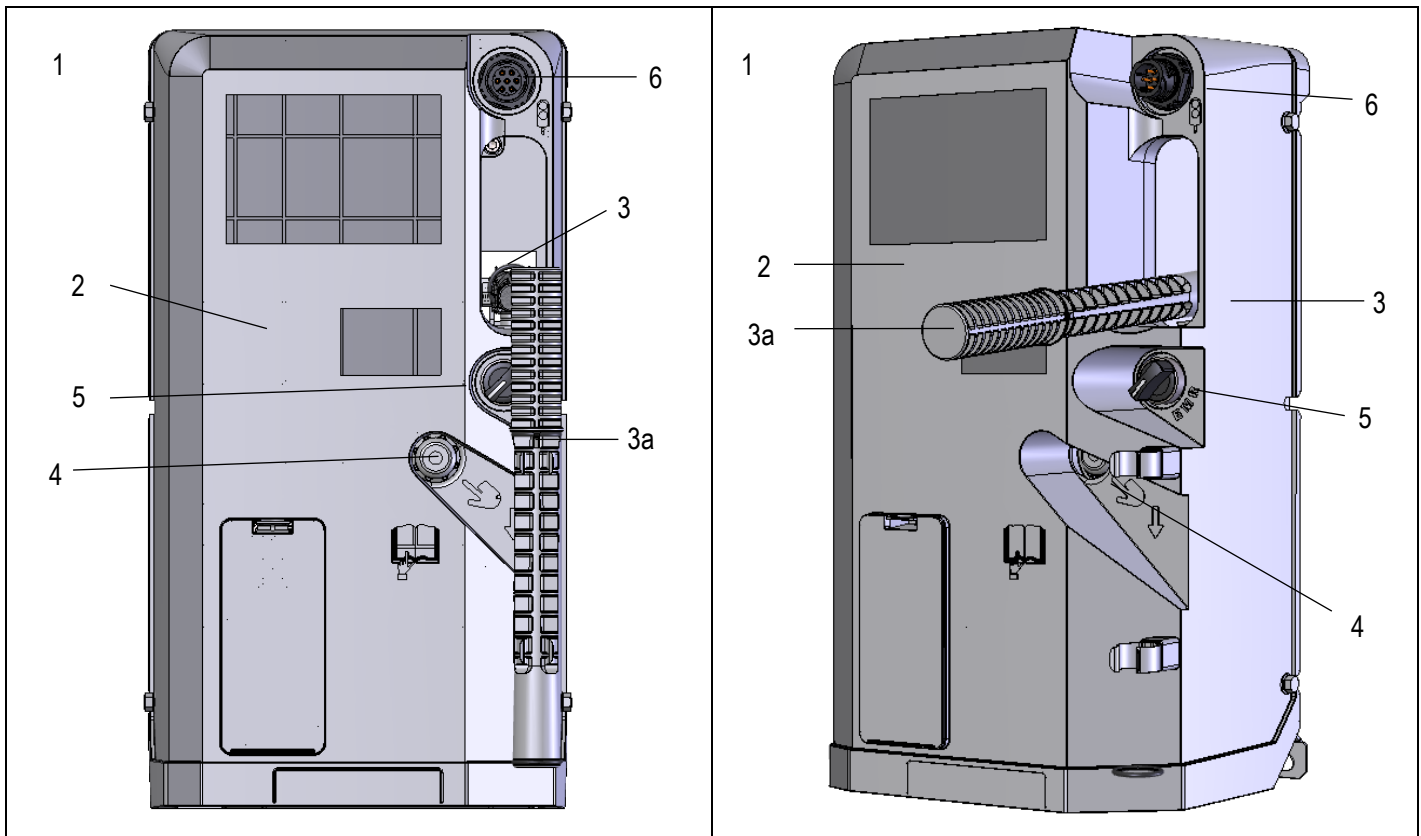



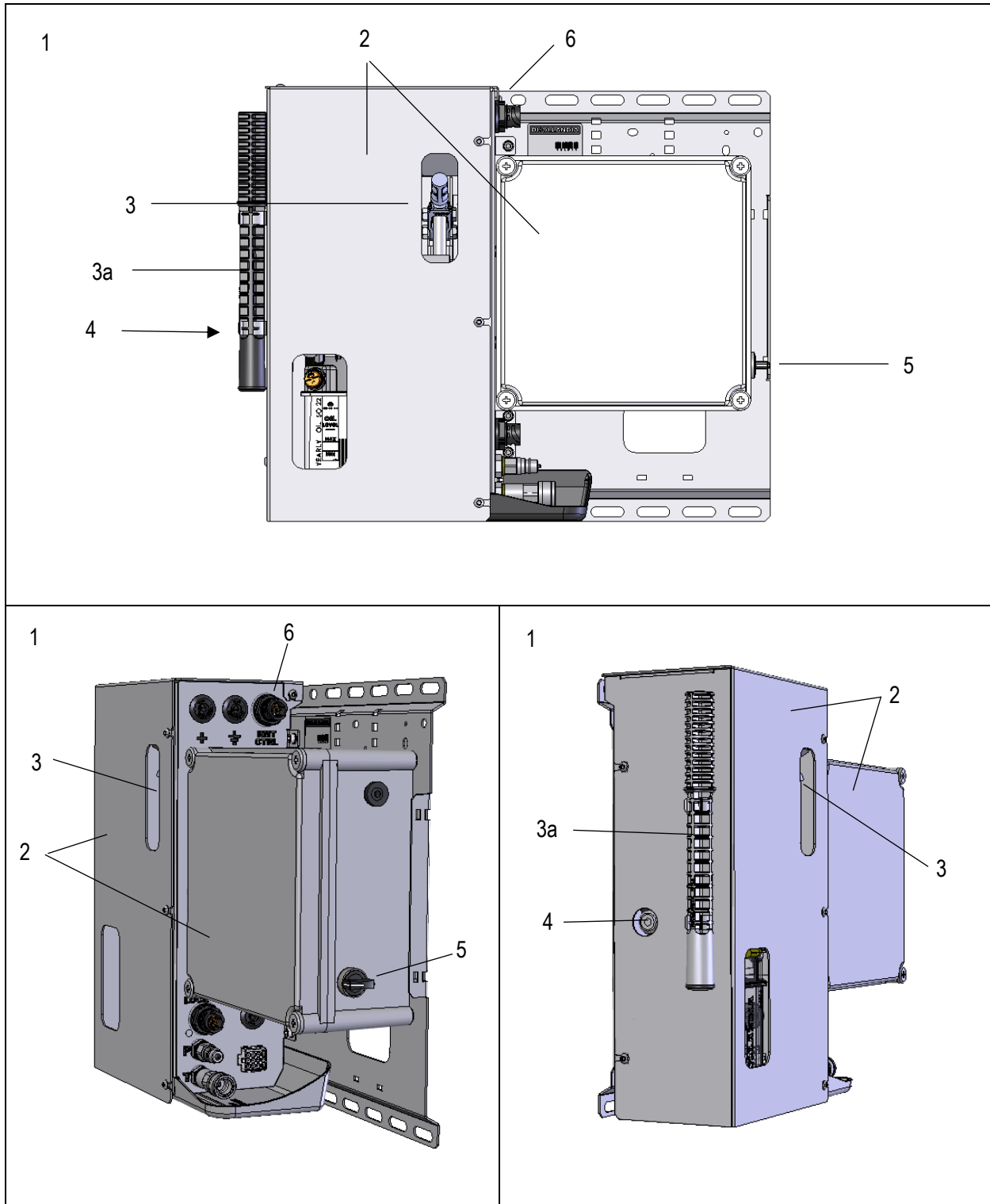

- Note: depending on the lift type and the installation environment, other types of power packs can be used. Despite different appearances, the main devices and components are identical. For example:



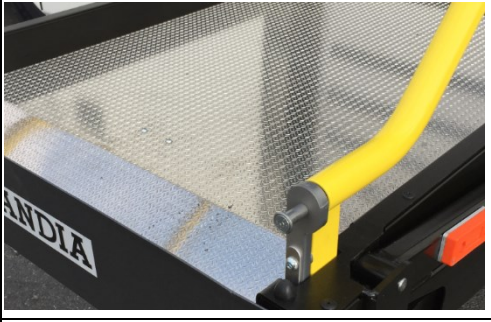

- The electric control box and the hydraulic power pack are connected to the vehicle battery (or auxiliary battery) during installation, according to the fitting instructions of DHOLLANDIA and the requirements imposed by the vehicle manufacturer. See the INSTALLATION MANUAL for further info. Electrical and hydraulic parts should only be repaired or serviced by a qualified service technician. Contact your national DHOLLANDIA distributor/ service point for support.

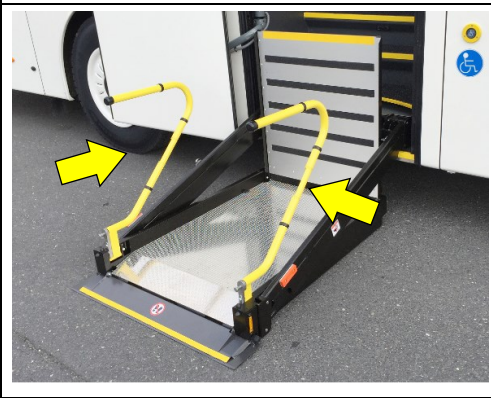

2.2 SAFETY MEASURES

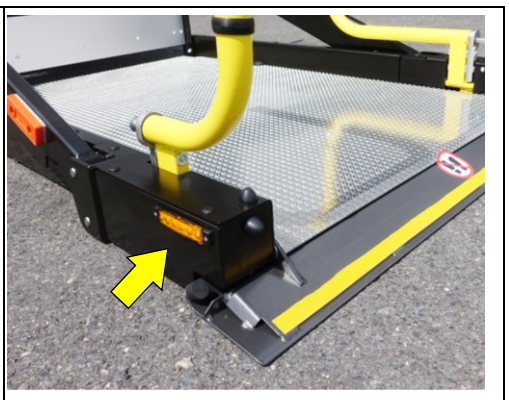
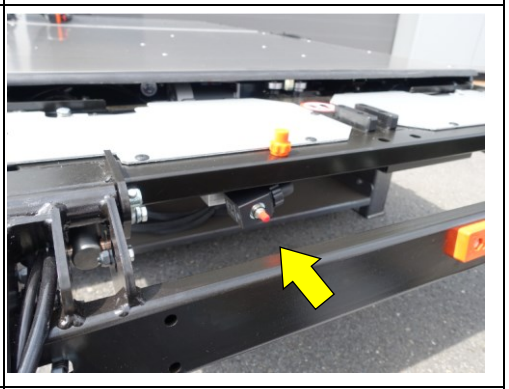
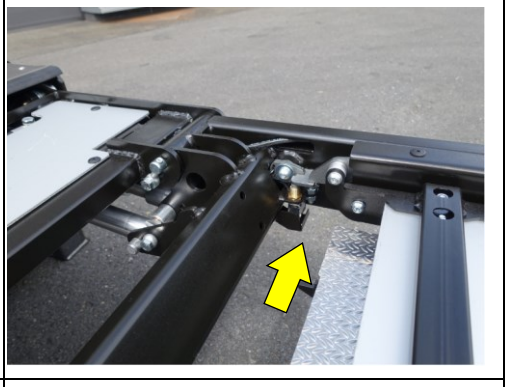
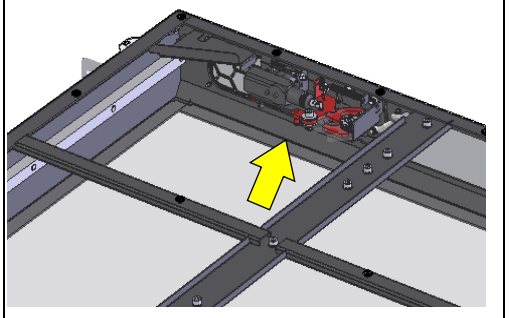
- DHOLLANDIA lifts are equipped with a wide range of safety measures, to enable its intended use with a maximum degree of safety for the operator, the wheelchair passenger on the platform and bystanders.
- The following safety devices are incorporated on the DH-CH... Series:

N°	Description	Image
1	<p>Non-slip surface: the platform surface incorporates a non-slip profiling to prevent the operator and platform occupants from slipping and falling.</p>	
2	<p>Roll stop: roll stop mounted at the outboard platform edge. The roll stop is tilted up automatically when the platform leaves the ground, it is tilted down automatically when the platform touches the ground. The roll stop prevents the wheelchair from slowly and unexpectedly rolling off the platform during lifting and lowering. It is not designed to stop fast and powered movements.</p>	
3	<p>Handrails: Rails mounted at both sides of the platform. Lift occupants should hold on to these handrails to prevent them from falling off the platform. Handrails must be deployed manually and secured in vertical position prior to using the lift, they must be stowed manually before retracting the lift back into its travel position.</p>	
4	<p>Bridge plate: plate mounted at the inboard platform edge, used to bridge any gap between the platform and the vehicle floor when the platform is raised to its maximum height. The bridge plate tilts down automatically as the platform approaches the vehicle floor. It tilts up automatically as the platform lowers to the ground. It also forms a toe-guard for the operator and the wheelchair occupant while travelling up / down on the platform.</p>	

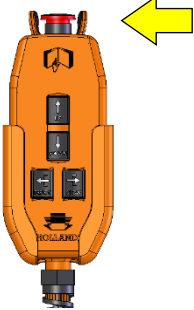
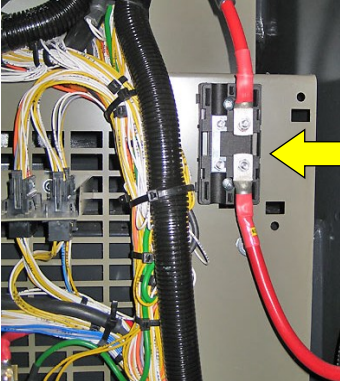
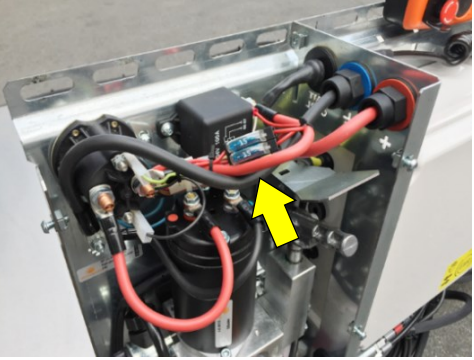
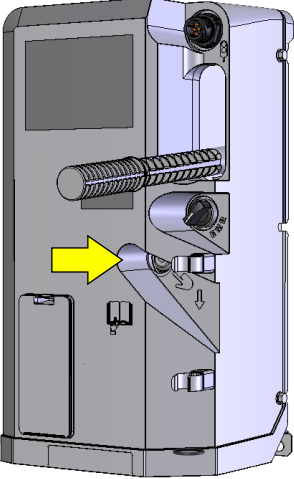
5	<p>Flashing platform lights: used to make the platform visible to other parties in traffic.</p>	
6	<p>Safety valve on the roll stop cylinder: the valve keeps the roll stop secured in the upright position as long as the platform has not reached the ground.</p>	
7	<p>End stop for STOW: combination of a cam and a switch to automatically stop the platform at the correct height to slide in and STOW the platform in its travel position.</p>	
8	<p>Automatic cassette lock: in regular conditions, the lift frame and platform are automatically locked inside the cassette by means of a lock mounted at the inboard edge of the cassette.</p>	
9	<p>Emergency cassette lock: in emergency conditions (in case of an electrical power failure) the automatic cassette lock can be disengaged, and the platform and lift frame can be pulled out by hand (= function DEPLOY).</p>	

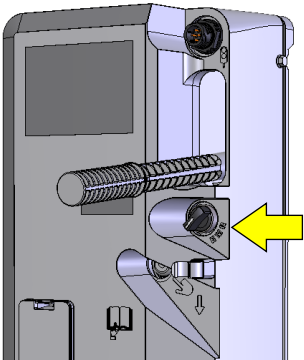
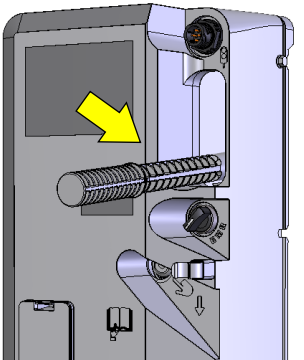
10	<p>Electric emergency stop: enables the operator to switch-off the electric power to the control unit and to cause an immediate stop of all electrically actuated lift movements. This switch is usually incorporated in the wander lead with spiral cable.</p>	
11	<p>Main battery fuse: a main fuse 100 – 150A is supplied by the vehicle manufacturer or by DHOLLANDIA. It protects the main battery cable from the batteries to the power pack of the lift against short circuits and amperage peaks.</p>	
12	<p>15A fuse: lighter fuses are used to protect the control unit, associated wires and the printed circuit against short circuits and amperage peaks.</p>	
13	<p>Emergency descent button: manual back-up button to lower the platform in case of an electrical power failure (= function DOWN).</p>	

14	<p>EMR = Emergency motor release: in regular mode, the lift frame and platform are blocked inside the cassette, and cannot be pulled out by hand easily. When turning the EMR button, the lift frame and platform are unlocked inside the cassette, and they can be pulled out by hand much more easily. After emergency use, the EMR button MUST be reset in its initial position.</p>	
15	<p>Hydraulic hand pump: manual back-up pump to lift the platform in case of an electrical power failure (= function UP).</p>	
16	<p>Pressure relief valve: safety device integrated in the power pack, enabling the manufacturer and the installer of the lift to limit the real lift capacity to the maximum rated capacity of the lift sold, and protect it against overload while lifting (= function UP).</p>	
17	<p>Pressure compensated flow valves: flow valves are integrated in the hydraulic circuits to ensure the platform lowers at a safe speed, both empty and when fully loaded.</p>	
18	<p>Decals: the lifts are supplied with a number of operation decals, load diagrams and safety decals. Some of these decals are premounted by DHOLLANDIA on the lift. Some of these decals are supplied loose and shall be affixed by the installer near to the lift at a location clearly visible to the operator. The decals must be kept clean and legible at all times, and replaced whenever required.</p>	
19	<p>Bridge plate load detection: Prevents the wheelchair lift from departing from the vehicle floor when a load is still applied on the bridge plate.</p>	
20	<p>Roll-stop load detection: Prevents the wheelchair lift from initiating the LIFT-action when a load is still applied on the roll-stop at floor level.</p>	
21	<p>Threshold warning sensor (see section 3): it guarantees a safe departure from the vehicle floor. It also makes sure the wheelchair lift will only initiate and continue the lift-action when the threshold area is clear.</p>	

3 THRESHOLD MODULE

As requested by FMVSS, a threshold module is used to detect an object in the threshold area. This guarantees a safe departure from the vehicle floor. It also makes sure the wheelchair lift will only initiate and continue the lift-action when the threshold area is clear.

The installation and adjustment of this threshold module are incorporated in the INSTALLATION MANUAL.

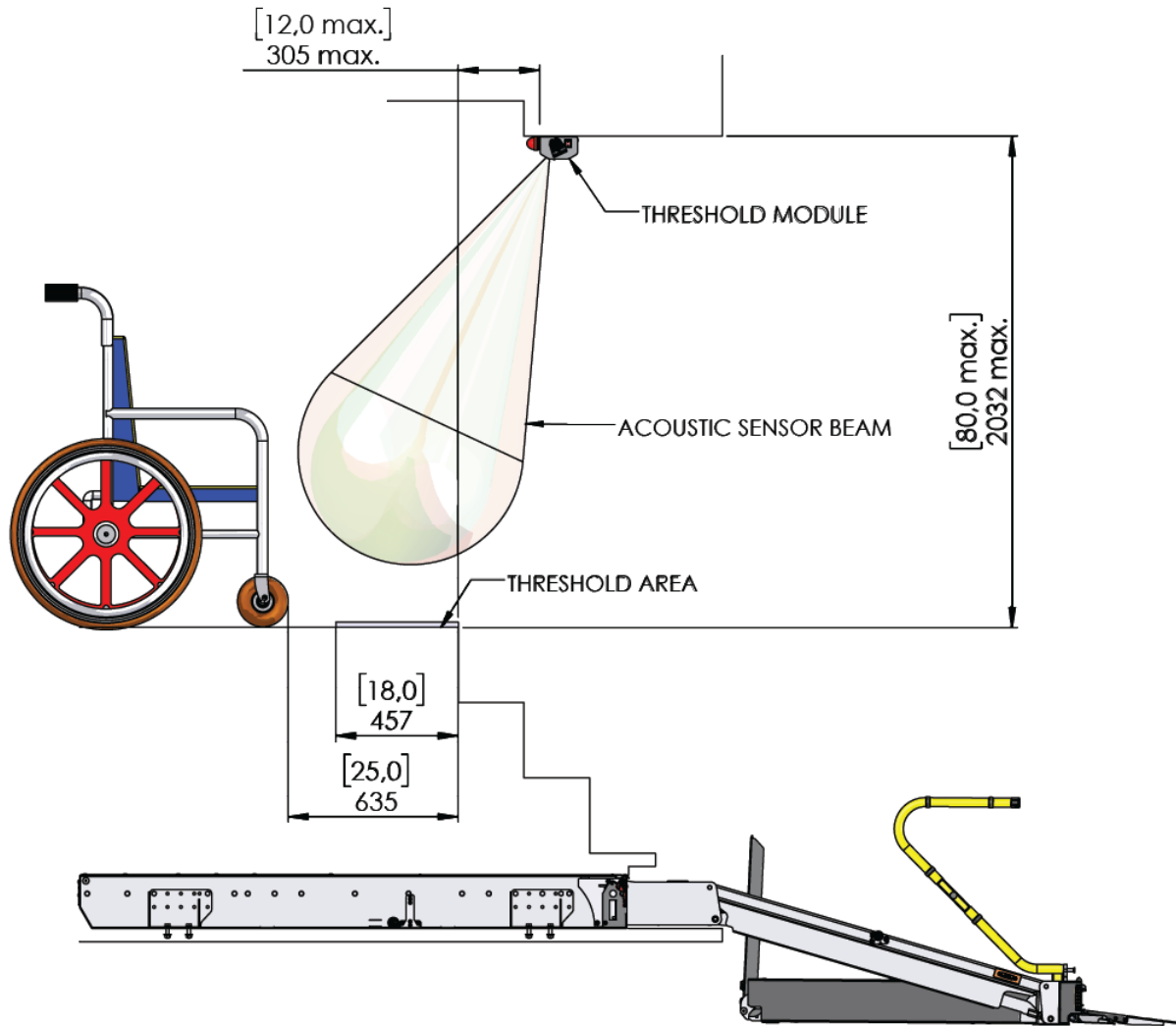

4 SAFETY INSTRUCTIONS FOR USING THE WHEELCHAIR LIFT

4.1 DO NOT USE WHEELCHAIR LIFT WITHOUT ADEQUATE SAFETY AND OPERATOR TRAINING

- DHOLLANDIA lifts shall be exclusively used to assist wheelchair occupants and persons with impaired mobility to embark and disembark the vehicle, within the limits of the applicable load chart, in compliance with the operator instructions and safety instructions in this manual.



WARNING

- In order to ensure the safety of the operator, the wheelchair occupants and occasional bystanders, the use of the lift is strictly reserved to skilled operators, who have been duly trained, who know and understand the full content of this manual and conscientiously apply the safety instructions given in this manual.
 - ALL passengers and wheelchair lift operators should read and UNDERSTAND the operation manual before operating the lift.
 - Negligence can put the operator and third parties at great risk.
 - To reduce the risk of serious bodily injury or death, THE OPERATOR MUST COMPLY WITH ALL SAFETY INSTRUCTIONS AND WARNING LABELS IN THIS SECTION AND THE ENTIRE MANUAL before and while operating the wheelchair lift.
-
- Simultaneously, the operator should follow all other prescriptions and instructions applicable to his work situation (e.g. health & safety regulations, road traffic regulations, company procedures, Driver Periodic Training according to 2003/59/CE, etc...).
 - The operator should have passed the minimum age of 18 years.
 - These safety instructions are of general nature, applicable for the whole range of wheelchair lifts. Some images might show deviating products, but the same principles apply.

4.2 GENERAL SAFETY INSTRUCTIONS



WARNING

- To avoid serious bodily injury or death, the operator must use appropriate work clothes. NEVER wear loose-fitting clothes that may be trapped in the moving parts of the lift. ALWAYS wear professional safety-toe shoes, protective gloves, and eye protection. Use of a hardhat is recommended.

Must



Recommended



- Slipping (and falling) can result in serious bodily injury and death. To prevent injury by slipping:
 - ALWAYS wear professional safety-toe shoes with a good non-slip sole.
 - DO NOT use the lift if it is covered with snow, mud, dirt, debris, liquids or other substances.
 - DO NOT run on the platform.



- Tripping (and falling) can result in serious bodily injury and death. To prevent injury by tripping:
 - DO NOT use lift platform as a step. NEVER leave the lift unattended in partially deployed position.
 - Pay attention to protruding items on the platform surface at all times (ex. platform lights, roll stops and their levers, foreign objects, etc...).
 - DO NOT run on the platform.



- Falling from the platform can result in serious bodily injury and death. To prevent injury by falling:
 - Make sure your footing is solid and you maintain 3 points of contact (2 feet on the platform, 1 hand on a handrail).
 - Use handrails where available.
 - NEVER move the vehicle while a person is standing on the platform or inside the vehicle body.
 - NEVER use the platform as an elevated working platform.



- Prior to operating the lift, the vehicle must be safely parked on level and solid ground, have the parking brake applied, and the engine switched off. Open any doors located in front of the lift and secure any moving parts of the vehicle body. Failure to abide by these instructions can result in serious bodily injury or death to the operator or bystanders.

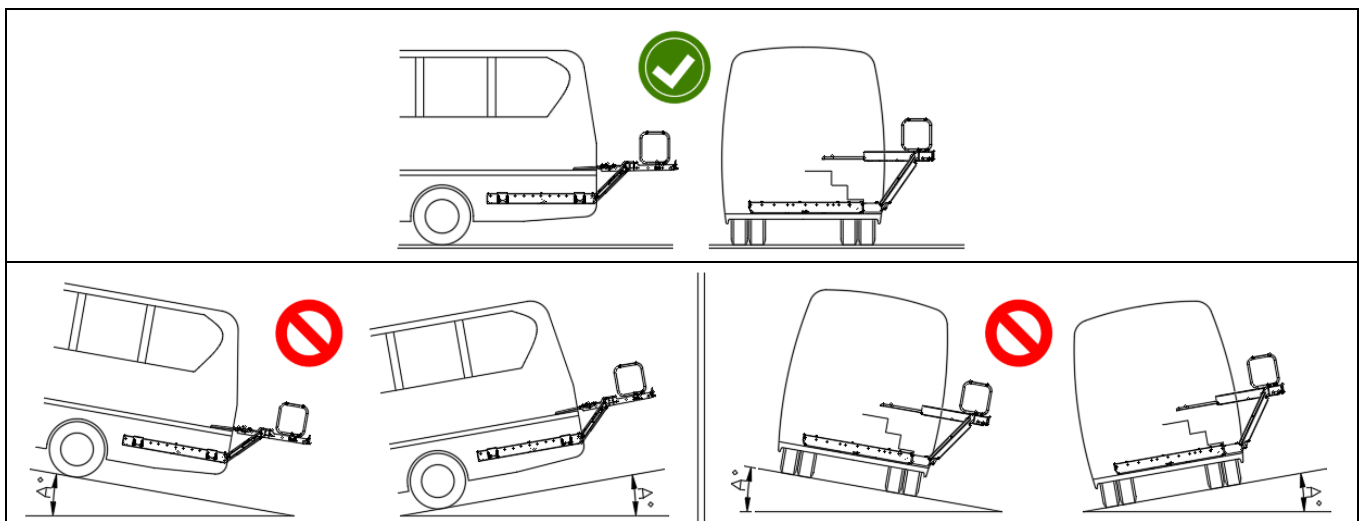

WARNING

- To reduce the risk of serious bodily injury or death which may result from other vehicles when parked, ALWAYS make sure a safety distance of 16 ft. or 5 m is kept between the back of the vehicle and the following vehicle.

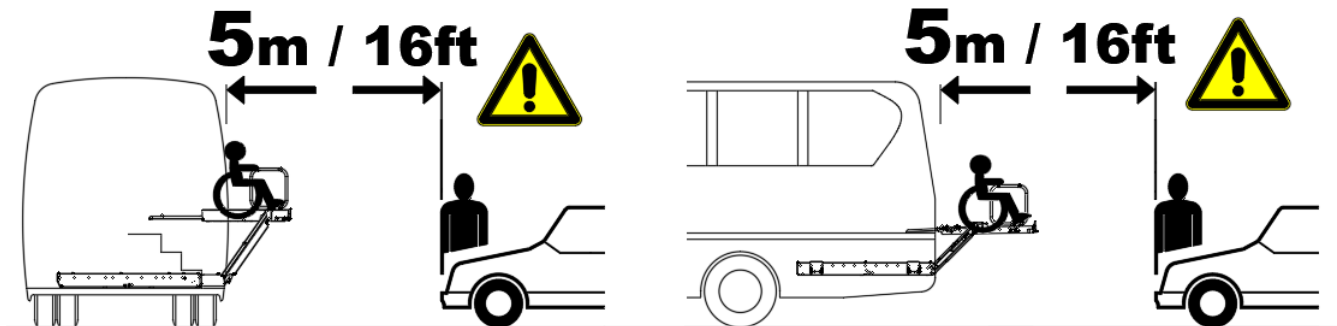

- Ensure that the vehicle cannot tip-over when putting weight on the platform. If the vehicle is equipped with mechanical or hydraulic stabilizing legs, deploy these before opening the platform. Ensure that the stabilizing legs are positioned on solid even ground. In case of soft terrain (sand, gravel...), solid support blocks must be used under the stabilizing legs. Failure to abide by these instructions can result in serious bodily injury or death to the operator or bystanders.
- To reduce the risk of serious bodily injury or death, ALWAYS make sure the platform is clearly visible to other persons from all approach directions. The lifts are equipped with flashing platform lights. Nevertheless, DHOLLANDIA recommends the use of 4 warning cones, placed around the work area of the platform.
- To reduce the risk of serious bodily injury or death, make sure the working zone is sufficiently lighted.
- Inspect the lift prior to each use. If any unsafe condition exists or unusual noises or movements are noticed, DO NOT use the lift and contact an authorized DHOLLANDIA service agent for repair. Please see 'pre-trip inspection' procedures under 4.6 from page 29 onwards.
- Read and comply with all warning decals, pictograms and instructions affixed to the lift. Failure to abide by warnings and instructions may result in serious bodily injury or death.
- The lift must not be used if the operator is intoxicated, impaired or distracted in any way. NEVER use a phone or mobile device when operating the lift.
- The lift shall be used by means of original control units only. Operating the lift with unauthorized control units will increase risk of serious bodily injury or death to the operator or any bystanders.
- Limit the operation of the lift to one single operator. Operation of the lift by more than one operator at a time may cause confusion and increase the risk of serious bodily injury or death.

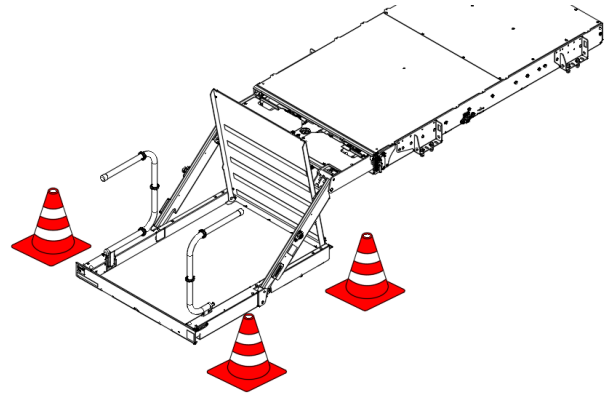



WARNING

- To prevent people from being hit by the platform, by objects falling off the platform; being caught in pinch points or being pinched by the moving parts of the lift:

	→ Keep visual control over the entire working area of the lift and its platform at all times, including the area DIRECTLY BEHIND and UNDER the platform.
	<p>→ Upon deployment, DO NOT allow any other person to stand in the proximity of the lift and its platform. ENSURE AT ALL TIMES THAT NOBODY STANDS UNDER OR WITHIN REACH OF THE MOVING PLATFORM.</p> <div data-bbox="581 527 1187 972" data-label="Image"> </div> <p>→ Upon lifting and lowering: DO NOT allow any other person, except the person to be lifted or lowered, to be in the proximity of the lift and its platform.</p>

- Careful supervision is necessary if used on behalf of, or near children.
- NEVER** leave the lift unattended in open position. Before leaving the vehicle unattended, close the doors of the vehicle, stow the platform in its travel position and switch off the electrical power to the lift. Leaving the lift in open position unattended can result in serious bodily injury or death to unaware bystanders. See 5 from page 31 onwards for instructions on properly stowing platform into its travel position.
- NEVER** move the vehicle with the lift in the open position. **ALWAYS** stow the lift in its travel position, close and secure the doors of the vehicle and switch off the electrical power to the lift before moving the vehicle. Failure to properly stow the lift in its travel position prior to moving the vehicle may result in serious bodily injury or death.



WARNING

- Use of the lift near vehicular traffic may result in serious bodily injury or death from being struck by another vehicle. When operating the lift on or near a street or parking lot, be sure to stay clear of vehicular traffic. **ALWAYS** be sure to clearly identify to other drivers that the lift is in use. DHOLLANDIA recommends use of warning cones to clearly identify to drivers that the lift is being operated. When the lift is operated near vehicular traffic, wear working clothes in high-visibility colours and a retro-reflective safety vest.
- DO NOT** raise the lift with the rear doors partially open. Doing so may damage the doors or the lift platform and may also result in serious bodily injury or death to the operator or any bystanders.
- Above all, **USE GOOD COMMON SENSE** when operating the lift. **DO NOT** operate the lift until the contents of this manual have been read and fully understood. Improper use of the lift increases the risk of serious bodily injury or death to the operator and any bystanders.

NOTICE

- The most important safety and operation instructions are summarized in a product video that can be viewed online at:

<http://www.dhollandia.com/uservideo/CH102-EN-2020>

- Please consider that the video is representing a generic lift. Your product could differ from the one displayed. Always follow the guidelines of this manual closely.
- Make sure you review these instructions prior to operation of the associated DHOLLANDIA wheelchair lift.



NOTICE

- The safety instructions in this manual are drawn up with an average, common use of the lift in mind.
- For specific applications or work conditions, other instructions might be appropriate to reach a higher level of safety. If contradictions exist, a formal risk analysis must be performed by the client's health and safety management and safe work procedures for the drivers and operators must be issued.

4.3 DANGER ZONES, RISK OF CRUSH AND SHEAR INJURY

- There are several main danger zones on and around the platform that can be hazardous to the operator and any other persons nearby.



Correct operator position



Danger zone



ALWAYS stay clear of the area behind the platform and the range of motion of the platform.

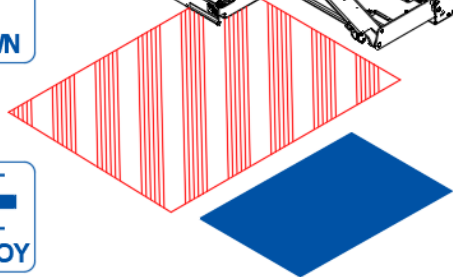
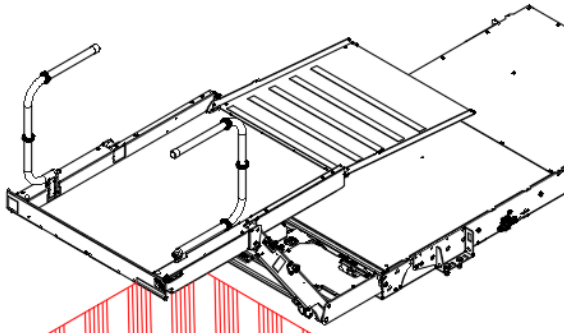

ALWAYS beware of the crushing zone between the lowering platform and the ground.

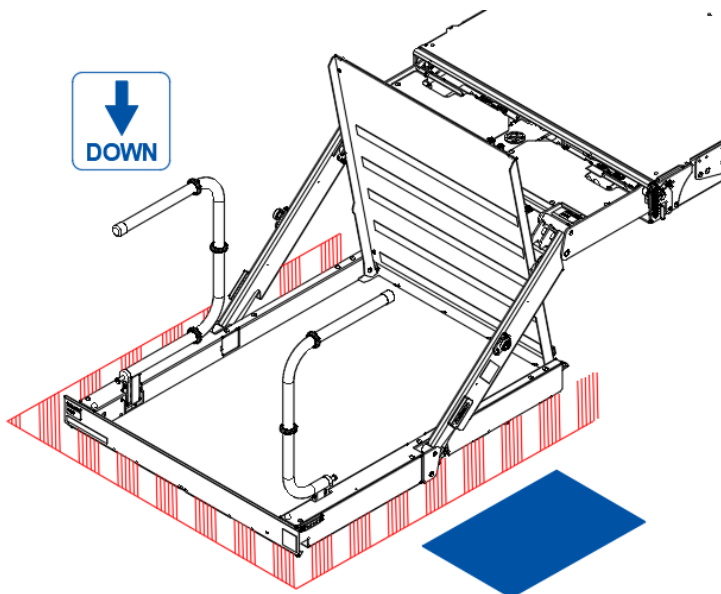

WARNING



Impact by the platform or the moving parts of the lift will result in serious bodily injury or death. To prevent people from being hit by the platform, by objects falling off the platform or being caught in pinch points or being pinched by the moving parts of the lift:

- Keep visual control over the entire working area of the lift at all times, including the area directly behind and under the platform;
- DO NOT allow any person to stand near the lift and its platform. Ensure at all times that nobody stands under, or within reach of the moving platform and its load.



WARNING



Lowering an empty or fully loaded platform on one's feet may result in serious bodily injury. To prevent people from having their feet crushed or sheared by the lowering platform:

- Keep visual control over the entire working area of the lift at all times, including the area directly behind and under the platform;
- When operating the lift from a position on the ground, ALWAYS stand at the side of vehicle body, at a safe distance of minimum 50 cm away from the moving platform.



ALWAYS beware of the crushing zone between rising platform and the lift arms, and between the moving parts of the lift generally.

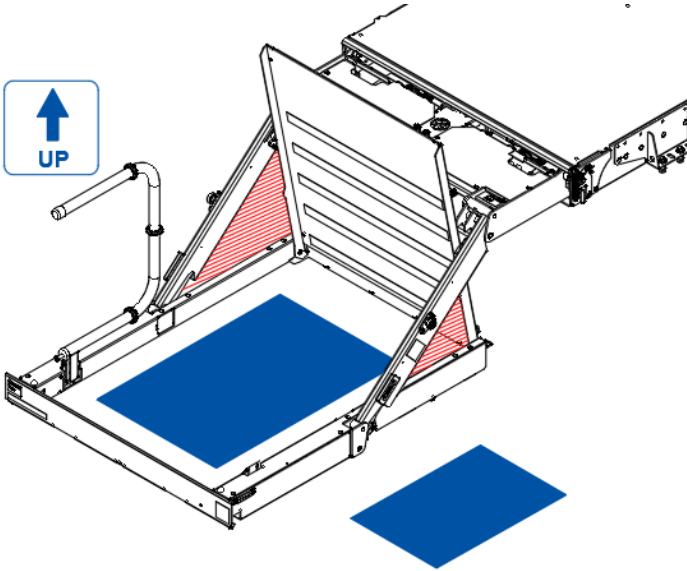

When standing inside the vehicle, ALWAYS beware of the crushing zone between the bridge plate and the vehicle floor.

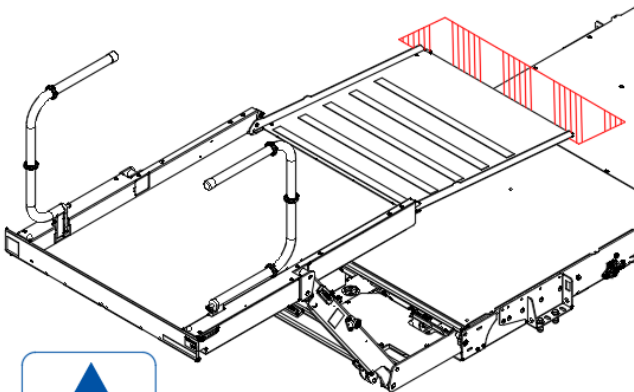

WARNING



- The triangular area between the platform and the lift arms diminishes as the platform rises. Parts of the body protruding into that area can be crushed or sheared upon lifting. This will result in serious bodily injury.
- Therefore, ALWAYS keep arms, feet and clothing clear of pinch points and moving parts of the lift.
- NEVER reach over or through any of the moving parts of the lift.
- ALWAYS keep visual control over the entire working area of the lift.



WARNING



Impact by the platform or moving parts of the lift can result in bodily injury.

- Therefore, also when standing inside the vehicle, ALWAYS stay clear of the moving platform.
- ALWAYS stand at a safe distance from the bridge plate as it approaches the vehicle floor.



WARNING

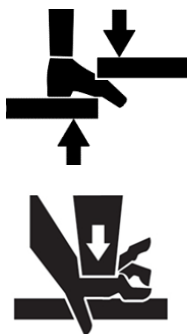

The operator or other persons approaching too close to these danger zones risk serious bodily injury or death by pinching, crushing or shearing of limbs, upper body or head. To prevent these hazards:

- ALWAYS stand clear of the range of motion of the platform and moving parts of the lift.
- Keep hands, feet and upper body clear of pinch points and moving parts of the lift.
- When standing on the platform, ALWAYS hold onto the handrails.
- When operating the lift from a different position, ALWAYS stand on the ground at a safe distance from the platform and the moving parts of the lift.
- DO NOT allow any other person to stand near the lift and its platform.

NOTICE

- NEVER allow anybody to stand on or hinder the bridge plate at the inboard platform edge when the platform is set in motion or is in motion.

- NEVER allow anybody to stand on or hinder the roll stop at the outboard platform edge when the platform is set in motion or is in motion.

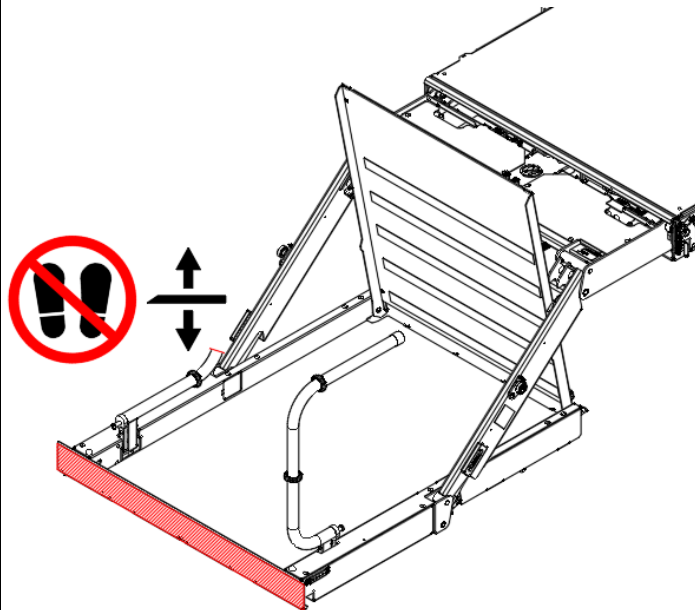
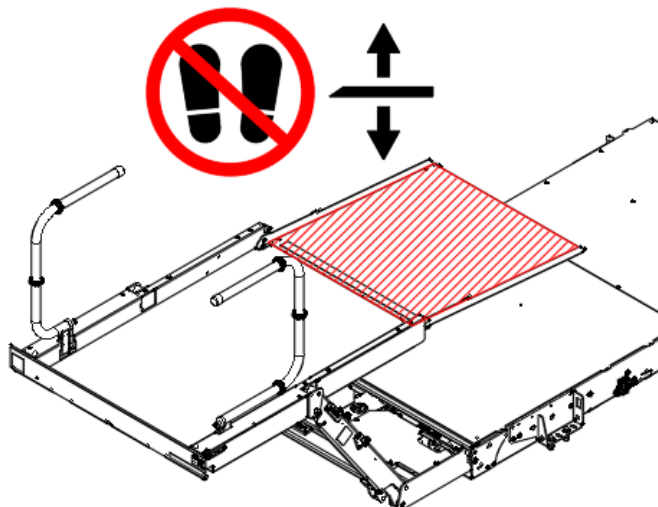

WARNING

- The operator and the wheelchair occupant or platform occupant SHALL NOT attempt to leave the platform before it has reached its final position for embarkation or disembarkation, either at the ground or at the vehicle floor.
- Any persons assigned to assisting the wheelchair or platform occupant with embarkation or disembarkation, MUST stay out of reach of the platform until it has reached its final position and has come to a complete stop, either at the ground or at the vehicle floor.

4.4 ADDITIONAL INSTRUCTIONS FOR THE WHEELCHAIR OCCUPANTS/ STANDEES

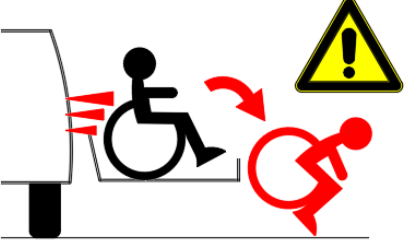
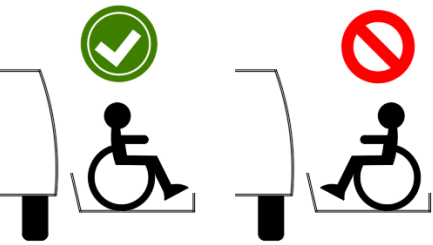
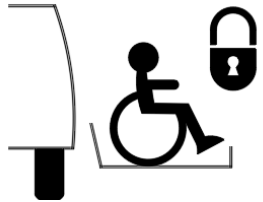
 WARNING	
	<ul style="list-style-type: none"> The roll stop prevents the wheelchair from slowly and unexpectedly rolling off the platform during lifting and lowering. It is NOT designed to stop fast and powered movements. When the wheelchair rolls and falls off the platform, this can cause serious bodily injury to the wheelchair occupants or any persons standing near the platform.
	<ul style="list-style-type: none"> To maximise the effectiveness of the roll stop, ALWAYS direct the small front wheels of the wheelchair towards to the roll stop. The roll stop is NOT designed to bring the big rear wheels of a wheelchair to a positive stop in case of abrupt or fast movement.
	<ul style="list-style-type: none"> ALWAYS board the platform slowly and cautiously. DO NOT ride against the roll stop as a mean of braking. ALWAYS engage the parking brakes of the wheelchair prior to moving the platform. For electric wheelchairs, ALWAYS put the controls in neutral position and switch the power off. If possible, the controls should be switched off and set to manual mode before embarking the platform, and the wheelchair be pushed manually onto the platform to reduce and control the speed.

- Make sure the wheelchair, wheelchair occupant and the standee don't interfere with the roll stop at the outboard platform edge and the automatic bridge plate at the inboard platform edge.
- Make sure the wheelchair occupant and standee are positioned as close as possible to the vehicle without interfering with the automatic bridge plate; and centrally between the 2 lift arms

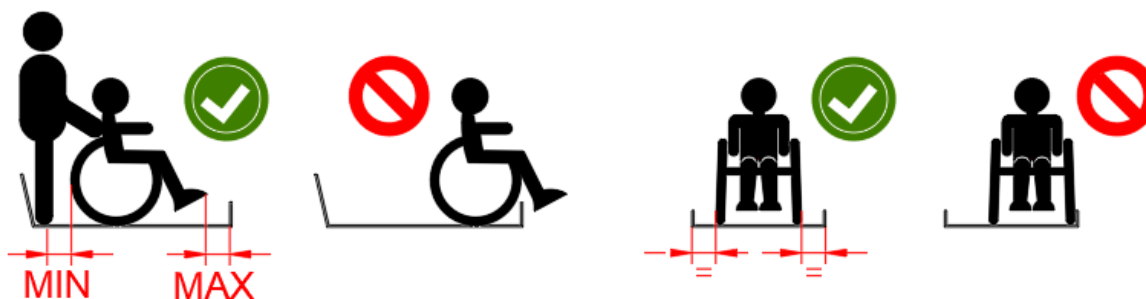

- When exiting the vehicle, never back onto the platform. Always face outward, ensure the platform is safely in place at the loading floor of the vehicle, the handrails are secured in the upright position and the roll stop is raised and secured in vertical position.
- Use extreme care in wet or slippery conditions. Wheelchair brakes are less effective if the platform and / or wheels of the wheelchair are wet or dirty.



WARNING



- A fall of the platform may cause serious bodily injury or death to the platform occupants.
- Standees on the platform **MUST ALWAYS** make sure their footing is solid.
- Standees and wheelchair occupants physically capable of doing so, **MUST ALWAYS** hold onto the handrails at the side of the platform.



WARNING



- Whenever available, position and secure the wheelchair-equipped safety belt (torso restraint) before loading the wheelchair onto the platform.

- Different disabilities require different types of wheelchairs and different types of wheelchair-equipped safety belts (torso restraint systems). It is the responsibility of the wheelchair occupant to have his or her wheelchair equipped with suitable safety devices.
- Wheelchair lift attendants should be instructed on any special needs and / or procedures required for the safe transport of the wheelchair occupants.
- Attendants on the platform pushing the wheelchair on and off, **MUST** face the same direction as the wheelchair itself, to maintain visual control over the wheelchair occupant while lifting and lowering.
- Standees alone shall face the direction of travel, toward the vehicle when embarking, or away from the vehicle when disembarking. They shall stand in the centre of the platform and hold onto the handrail(s) at the side of the platform.
- It is **FORBIDDEN** to remove the handrails or any other safety devices.

4.5 LOADING DIAGRAM

NOTICE

- Wheelchair and commercial lifts are NOT designed to lift / lower weights corresponding to their **maximum rated capacity** over the **entire** surface of the platform. The maximum rated capacity is valid at a **centre point of maximum load of 500 mm** behind the inboard platform edge. Behind that point, the maximum safe working load diminishes.
- When lifting (= function UP), the wheelchair lift is normally protected against overload by the pressure relief valve in the hydraulic circuit. Most of overload events and resulting damage happen when lowering loads (= function DOWN).

- In order to prevent premature wear or damage of the lift, possibly resulting in accidents with injuries, it is important to follow the instructions below.
- The **maximum rated capacity** is indicated on the serial number decal and on the CE certificate of conformity. It is the maximum weight allowed to be carried on the platform in the best possible circumstances. This is under the following conditions:
 - In longitudinal direction: the load or wheelchair is placed as close as possible to the vehicle and the inboard platform edge.
 - In lateral direction: the load or wheelchair is placed in a central position between the lift arms (not out of center to one of the sides of the platform).

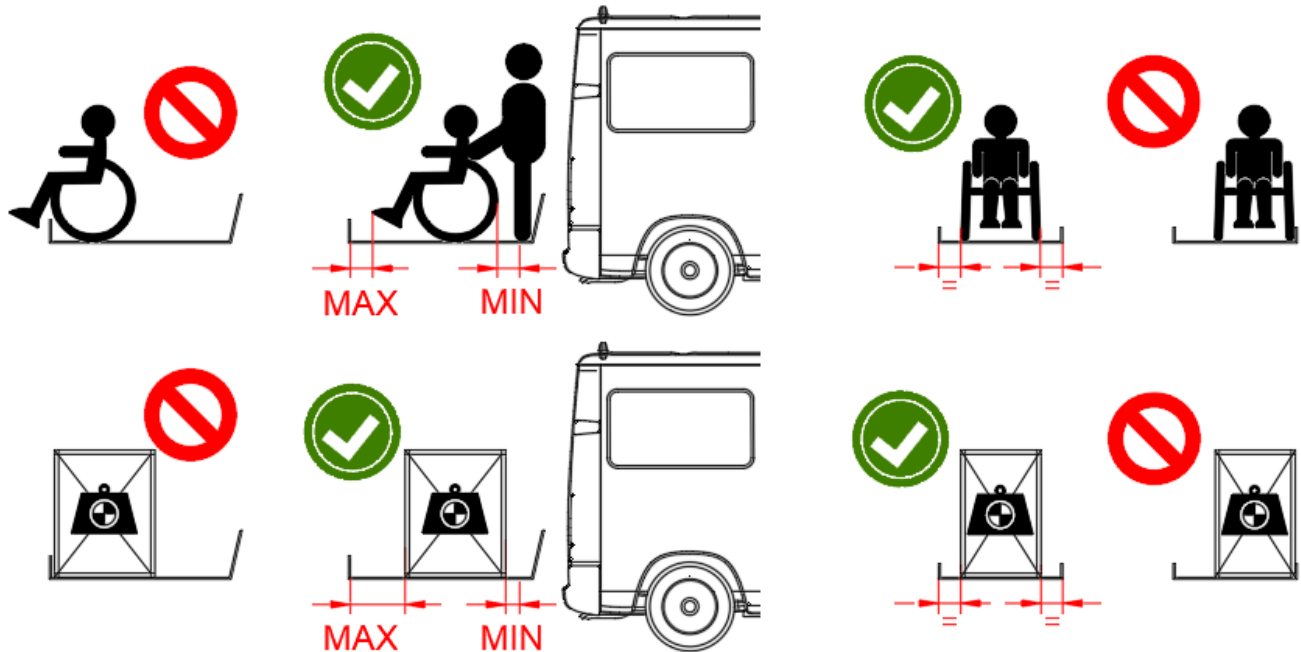

- Whenever the loading circumstances deviate from these best possible conditions, the safe working load (=SWL) decreases by 30%.

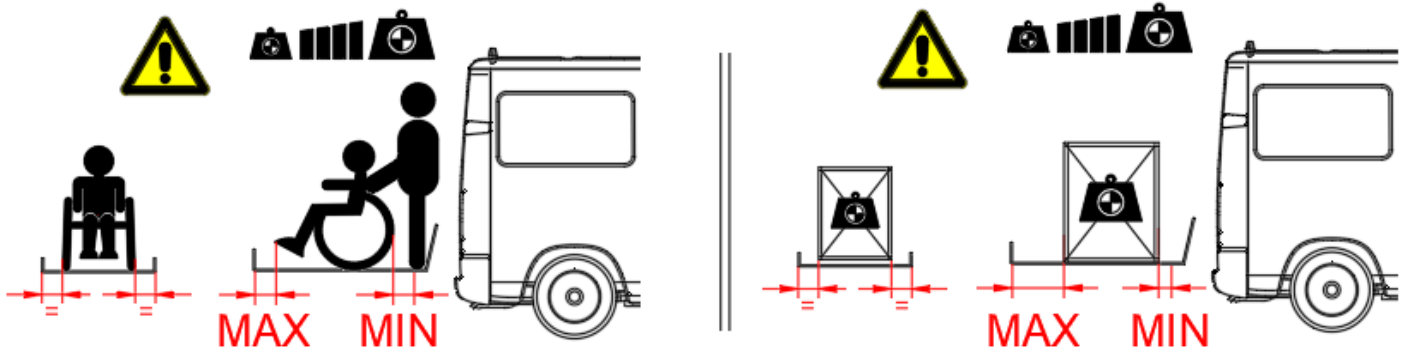

- The dimensions of the load or wheelchair should never exceed those of the platform. The load or wheelchair should never protrude beyond the perimeter of the platform.

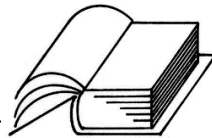
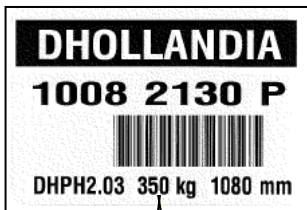
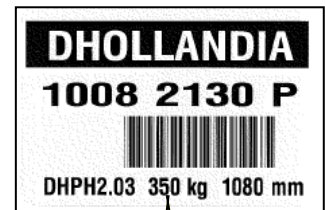
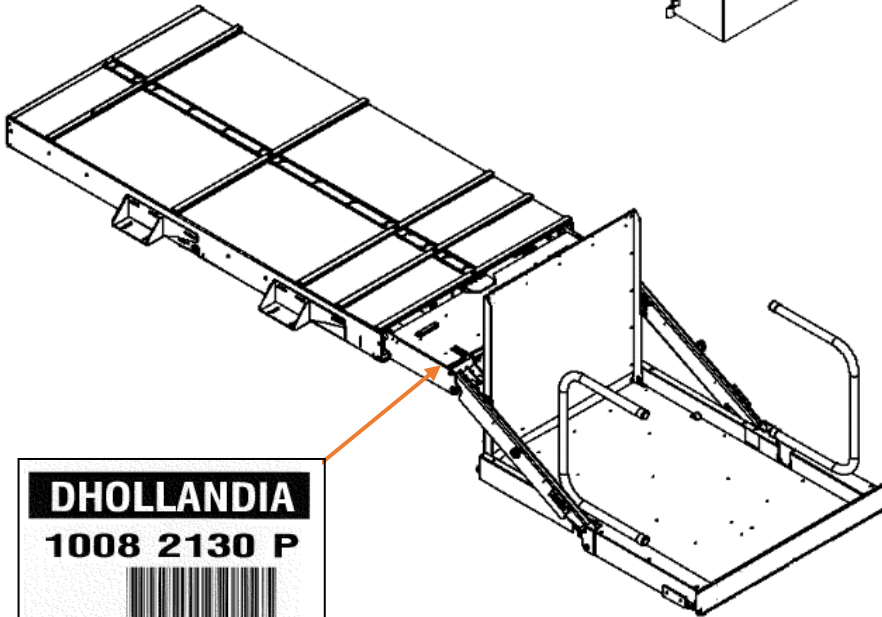
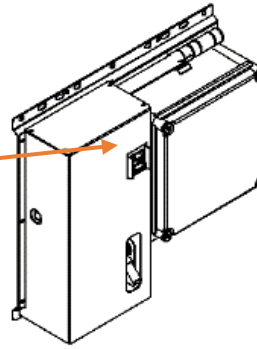

2. CE-DECLARATION OF CONFORMITY
Corresponding Directive 2006/42/EC, annex 2, A)

Identification of the lift device:



We hereby declare that the **DHOLLANDIA** lift device identified in this certificate, based on its design and its construction, complies to the relevant fundamental health and safety requirements of the CE-Directives, and is destined to be mounted on a vehicle.

This declaration of conformity is only valid, and the use of the lift device is only permitted, once the following conditions are met:

- The lift device is fitted to a vehicle and the fitting complies with the conditions of the CE-Directives, with the fitting instructions of **DHOLLANDIA** and the Fitting and Body Building Instructions of the vehicle manufacturer.
- After the fitting of the lift device, the risk analysis, the weight test and put-into-service test has been carried out with positive results and the fitting declaration has been filled out completely and correctly.

This Declaration of Conformity and the responsibility of the manufacturer are no longer valid if any modification to the lift device is made without the prior written permission of the manufacturer, or if the maintenance instructions have been neglected and/or the periodic inspections have not been executed.

Applicable CE-Directives:
• 2006/42/EC

Signature + stamp manufacturer

Belsele, / /

DHOLLANDIA NV
Gentstraat 49
9111 BELSELE
Tel: +32 - (0)9.349.06.92
Fax: +32 - (0)9.349.09.77
BTW 432.147.371

4.6 RECOMMENDED DAILY PRE-TRIP INSPECTION



WARNING

- Using a lift that is damaged or improperly serviced, can put the operator and bystanders at great risk of serious bodily injury and death.
- To avoid this risk, inspect the lift prior to the first use of each day. Ensure that all safety systems and all functions operate correctly, and that no maintenance or repair is required.
- If any unsafe condition exists or unusual noises or movements are noticed, DO NOT use the lift and contact an authorized DHOLLANDIA agent. [see Notice].
- DO NOT cover up any accidents or damage; it can be dangerous to you, your co-workers, and other persons.

NOTICE

Authorized DHOLLANDIA service agents may be found at www.dhollandia.com or by calling your regional DHOLLANDIA distributor. See page 4 for contact info.

Before operating the lift, the operator must conduct the following daily pre-trip inspection. Use caution: stay clear of the area directly behind and underneath the platform while conducting the daily pre-trip inspection.

- Replace missing, worn or illegible warning decals immediately. See page 4 for contact info.
- Make sure the cabin switch and / or main battery disconnect switch on the power pack switch on and off accordingly.
- Make sure the battery is fully charged, the main fuse is in good condition, and battery terminal connections are corrosion-free and tight.
- Check the overall condition of the wander lead with spiral cable, its buttons and emergency stop. Confirm that all buttons swiftly return to the neutral position after releasing them. When engaging the emergency stop (if so equipped), all movements should be interrupted. It should not be able to re-initiate any movements as long as the emergency stop has not been reset.
- Check the overall condition of the cables entering the various control units and the cables to the power pack. Make sure cables are not chafed, lose or damaged.
- Ensure the cover of the power pack is properly installed and secured.
- Check the power pack, the cassette and its mounting environment for visible oil leaks.

Follow the instructions in section 5 to deploy the platform and continue the checks:

- Visually inspect the general condition of the lift frame and lift arms. Look for cracks or deformations in the material and welds.
- Make sure all pivot pins in the lift frame, lift arms and platform are properly locked and secured.
- Visually inspect the general condition of the platform. Look for cracks or deformations in the material and welds.
- Verify and make sure the flashing platform lights are working OK.
- Inspect the automatic bridge plate at the inboard platform edge. Look for cracks or deformations in the material and welds. Test it. Make sure the bridge plate tilts progressively down towards the vehicle floor as the platform goes up, and vice versa. At the highest platform position, make sure the bridge plate provides a smooth and safe passage between the platform and the vehicle floor.
- Inspect the roll stop at the outboard platform edge. Look for cracks or deformations in the material and welds. Test it. Make sure the roll stop tilts down as the platform touches the ground. Make sure the roll stop tilts up and gets locked in the upright position as the platform lifts off the ground.
- Inspect the handrails. Look for cracks or deformations in the material and welds. Test them. Make sure they can be secured in the upright position.
- Make sure the platform surface is clean and can be accessed safely. Remove any snow, mud, dirt, debris, or slippery liquids. Make sure you wear safety-toe shoes with a good non-slip sole.

- Check the lift cylinders and the inside of the cassette for visible oil leaks. Follow the hydraulic pipes and fittings to the power pack. Make sure all wires and hydraulic pipes are undamaged, not pinched or chafed anywhere, and adequately secured with cable ties. Check for visible oil leaks.

Perform all movements several times with an unloaded platform with all available control units. Use the operating instructions in section 5 for guidance.

- Make sure all movements occur smoothly and quietly, without jerking motion or unusual noises. The functions DEPLOY – STOW use an electric motor and gear wheel system. The function UP uses the hydraulic power pack. The function DOWN is based on gravity. While lowering, no noticeable sounds should be audible.



Remember: if any part of the pre-trip inspection reveals a need for service or repair

- **DO NOT use the lift until it has been serviced or repaired by a qualified service technician.**
- **Switch OFF power at the main battery disconnect switch or cabin switch**

4.7 IMPORTANCE OF PREVENTATIVE MAINTENANCE

NOTICE

- Competent and regular preventative maintenance is essential to the operational reliability of the lift as well as the safety of the operator and all bystanders.
 - All maintenance and repair work must be performed by authorized DHOLLANDIA service agents and using original DHOLLANDIA replacement parts only.
 - Please consult the separate MAINTENANCE AND REPAIR MANUAL for specific instructions regarding periodic maintenance.
- If a lift cannot be repaired immediately in case of breakdown, it must be put out of operation and secured against unauthorized use.
 - If required, use the emergency procedures of section 6 on page 38 to manually stow the platform in its travel position. If this doesn't go smoothly, do NOT apply brutal force as this might cause physical damage to the lift.
 - Avoid using the help of external devices (forklift, gantry crane, etc.) to stow a lift back in its travel position. When doing so, the platform will not be supported by its hydraulic cylinders. When trying to deploy it again, the platform will drop in free fall, without any possibility to stop the fall by means of the regular controls.



WARNING



Incorrect handling in case of a breakdown, or impact by a falling platform, can result in serious bodily injury or death. To reduce the risk of injury:

- Secure the platform inside the cassette by means of ratchet straps, hoists etc.
- Attach a clear and highly visible warning to the platform and the external control box.
- Warn your supervisor and have the vehicle put out of service.
- Contact an authorized DHOLLANDIA service agent to repair the lift prior to any further use.

- To prevent damage or malfunction of the lift, it is **ESSENTIAL** that you keep the platform and its switches, the cassette, and the switches on the lift arms clean. Bad weather (snow, rain, etc.), mud and dirt, other debris can deteriorate the condition of the cassette lift quickly and cause malfunctions if the cassette, the moving parts of the lift and their switches are not kept clean properly.

5 OPERATING INSTRUCTIONS - PRINCIPLES AND PROCEDURES

NOTICE

- The DH-CH... PUBLIC USE lift models provided by DHOLLANDIA may only be operated by an attendant who is accustomed to the operating- and safety instructions provided in this OPERATION manual. Incorrect use of the wheelchair lift or ignoring safety precautions can result in damage, personal injury or death.

5.1 CONTROL UNIT

- This control unit has 4 separate and dedicated buttons to control the functions DEPLOY – UP – DOWN - STOW.
- Press DEPLOY to slide the platform out of the cassette. Then press UP to raise the platform. Open the bridge plate and the handrails.
- To stow the platform, start from a platform position approx. 15 cm/ 6 inches above the cassette. Stow the handrails and bridge plate in the travel position. Press DOWN to lower the platform on the lift arms. Then press STOW to slide the platform back in the cassette.
- Operation:

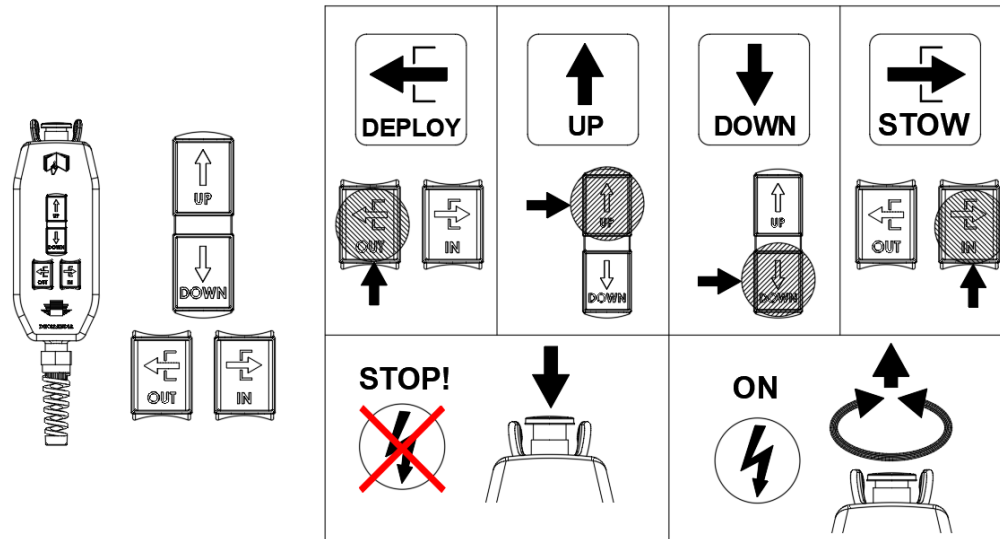

5.2 SWITCHING THE MAIN POWER ON/OFF

- The electrical power to the wheelchair lift is switched ON / OFF by means of a cabin switch, usually mounted near the driver's position.

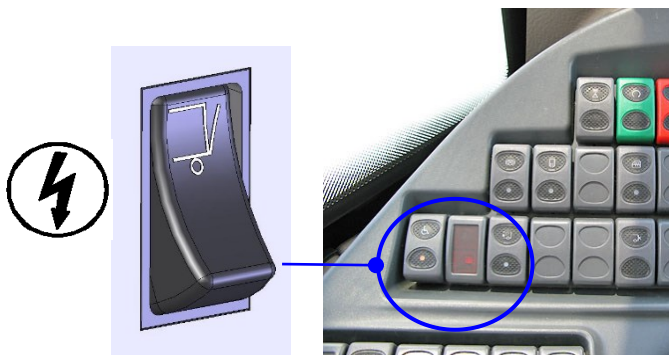

Push the button to switch the electrical power to the wheelchair lift ON.

Push the button in opposite direction to switch the electrical power to the wheelchair lift OFF.

- Note: besides this industry-standard cabin switch, the vehicle manufacturer might add additional switches or safety features. Refer to the operation manual of the vehicle manufacturer for further detail.

OPERATING INSTRUCTIONS FOR DH-CH... SERIES

Before using the DH-CH... PUBLIC USE wheelchair lift, the attendant **MUST** be aware of the door system of the vehicle where the DH-CH... wheelchair lift is mounted to. Incorrect usage of the door system of the vehicle can cause damage, personal injury or death to the attendant, bystanders or passenger of the wheelchair lift. These instructions are **NOT** provided by DHOLLANDIA since the DH-CH... wheelchair lift can be mounted to multiple types and brands of vehicles.

OPENING THE WHEELCHAIR LIFT

1 Consult the operations manual before getting started. Follow all safety instructions.

After consulting the manual also perform the recommended pre-trip inspection.

Ensure that the vehicle is safely parked – AWAY from traffic, the engine is switched off and the vehicle doors are properly opened and locked before starting to operate the DH-CH... wheelchair lift.



WARNING

If any unsafe condition exists or unusual noises or movements are noticed, **DO NOT** use the wheelchair lift and attach a warning sign or note that the lift is out of service in a position clearly visible to other potential operators. Contact an official DHOLLANDIA service agent for repair/service.

2 Switch on the electrical power to the lift by toggling the switch located in the cabin or the battery switch located on the power pack.

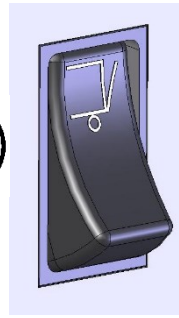

3 Ensure the emergency button is disengaged by turning the button clockwise and pulling the button up.

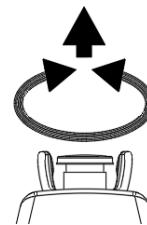
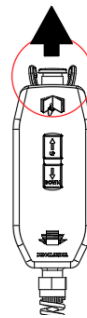

4 Press the DEPLOY-button to slide the platform out of the cassette. Hold the button until the platform comes to a complete stop after reaching the end stops at the work position.

Make sure the operating area is clear of any objects or persons.



5 Press up to raise the platform approx. 10-15 cm.



6 Manually open the bridge plate at the inboard platform edge.



7 Raise the handrails at the left and right side of the platform.

ALWAYS make sure the handrails are properly secured in the upright position.

Also lock the extension of the roll stop to the roll stop.



LOADING AND UNLOADING

Follow the safety instructions and loading diagrams at all times.

- 8 Press the DOWN- button to lower the platform to the ground, wait until the platform has come to a complete stop and the roll stop automatically drops DOWN.



Make sure the surface of the floor is level and flat, to guarantee the correct operation of the automatic roll-stop flap at the front edge of the platform.



- 9 Press UP to raise the platform from the ground to the vehicle floor.

When going UP, the roll-stop will automatically raise upon departure of the platform off the ground.

While lifting (= UP), the bridge plate will tilt down automatically as the platform approaches the vehicle floor. DO NOT stand on the bridge plate before the platform has come to a complete stop.

Press UP until the platform has come to a complete stop. DO NOT disembark before the bridge plate is level with the vehicle floor and is solidly supported by it from underneath.

Load and unload at the vehicle floor, help wheelchair occupants embark and disembark in accordance with the instructions of section 4.4 from page 25 onwards.



- 10 Repeat step 8 to disembark the vehicle and to lower the lift to ground level.

CLOSING THE WHEELCHAIR LIFT

- 11 Press UP to raise the platform approx. 15 cm/ 6 inches above the level of the cassette.

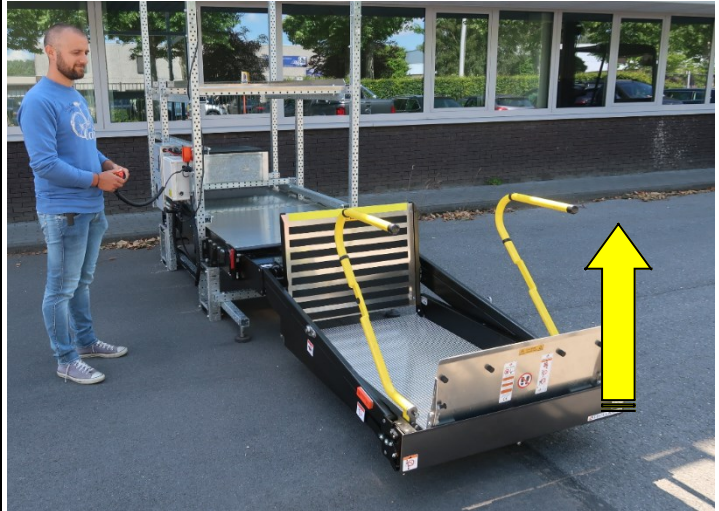



- 12 Unlock the handrails at the left and right side of the platform.
Fold the handrails back onto the platform surface.



- 13 Fold the bridge plate back on top of the safety handrails.

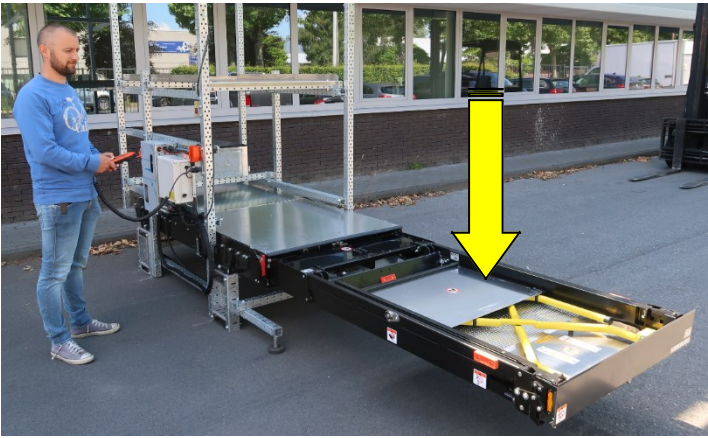

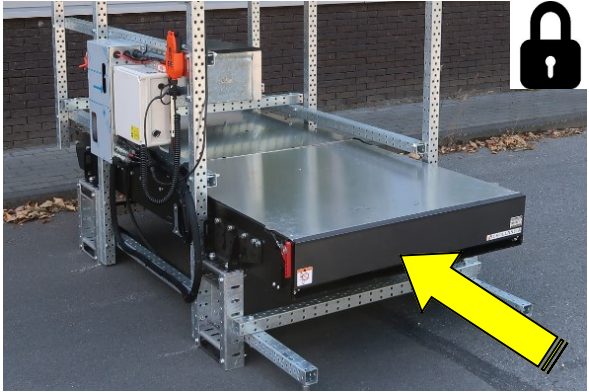
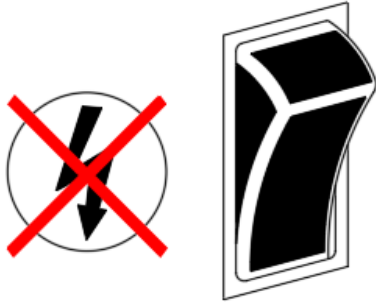
14	<p>Press the DOWN-button to lower the platform until it stops automatically at the level of the cassette.</p> 	
15	<p>Press the STOW-button to stow the platform in its travel position inside the cassette. STOW fully until the lift frame is locked by the automatic cassette lock.</p> 	
16	<p>Switch OFF the electrical power to the lift by means of the cabin switch.</p>	

• Note:



- Where mentioned on the decals or in the manual, this sign refers to a normal operation by means of the electric controls.



- Where mentioned on the decals or in the manual, this sign refers to a manual emergency operation by means of the back-up devices (Emergency Descent button and hand pump).

6 EMERGENCY OPERATION

- In case of a failure in the electrical power supply to the wheelchair lift (insufficient battery power, damaged fuse, damaged electrical controls,...), the various functions of the lift can be operated manually as explained below.



WARNING

- Negligence or ignorance during the emergency operation can put the operator and third parties at great risk of serious bodily injury or death.
- Therefore, the emergency operation of the wheelchair lift is restricted to skilled operators, who have been properly trained, and who know and understand the full contents of this manual.
- Prior to operating the manual emergency controls of the lift, ALWAYS make sure you follow all applicable instructions.
- In case of doubt, DO NOT CONTINUE, but contact the national **DHOLLANDIA** distributor for further help and instructions. See contact info on page 4.



WARNING



- To avoid unexpected movements, the electric power to lift must be switched off before starting the emergency operation.
- Always stand clear of the platform area.
- Keep head, hands and feet clear of pinch points and moving parts.

Emergency operation

STEP	Initiating manual operation
1	<p>In regular mode, the lift frame and platform are blocked inside the cassette by an automatic cassette lock.</p> <p>Locate the Emergency Motor Release or EMR button at the side of the hydraulic power pack. Turn the switch to put the electric motor in idle mode.</p>

STEP 1

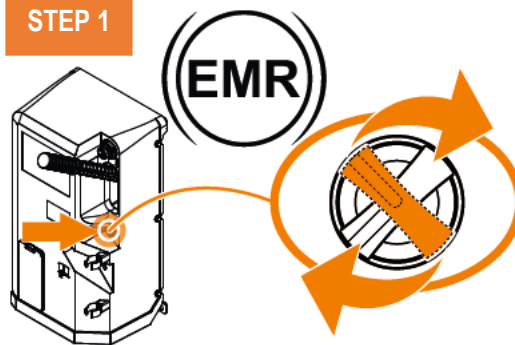

Emergency operation: DEPLOY platform

STEP	Manual operation: DEPLOY
2	Locate the red emergency release handle at the front of the cassette. Pull the handle to disengage the automatic cassette lock.
3	PULL the platform out by hand, until it comes to a complete stop at the dedicated work position. DO NOT apply brutal force as this may cause mechanical damage to the lift.

Emergency operation: LIFT platform

STEP	Manual operation: LIFT
-	Locate the handle of the hand pump on the cover of the power pack. Fit it over the lever arm of the hand pump.
4	Move the lever of the hand pump up and down slowly to lift the platform (= UP). Stop at approx. 15 cm – 6" above cassette height. The platform stops as soon as you stop pumping.
5	Manually open the bridge plate at the inboard platform edge. Raise the handrails at the left and right side of the platform and ALWAYS secure them in the upright position.
-	Operate the hand pump to raise the platform until the desired position has been reached.

Emergency operation: LOWER platform

STEP	Manual operation: DOWN
6	To lower the platform (= DOWN), press the Emergency Descent button on the power pack. Depending on executions, this button can be positioned at the side or at the front of the cover.
7	To LOWER the outer roll-stop, locate the electro valve between the lift arms. A screw is located underneath the nut. Remove the nut and turn the screw counter-clockwise to open the valve. Press the button on the side of the power pack to LOWER the roll-stop of the platform.

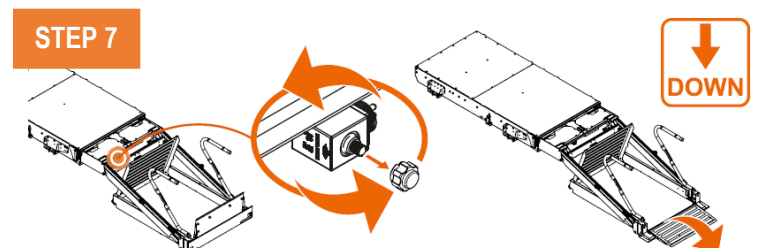
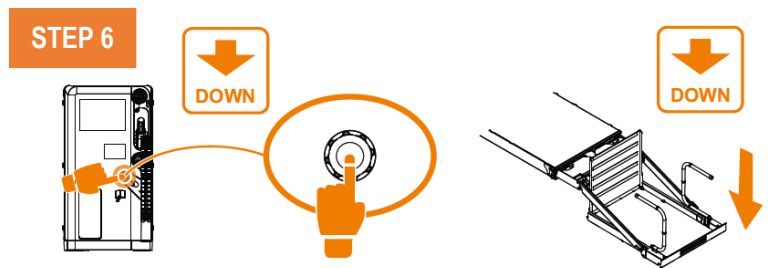
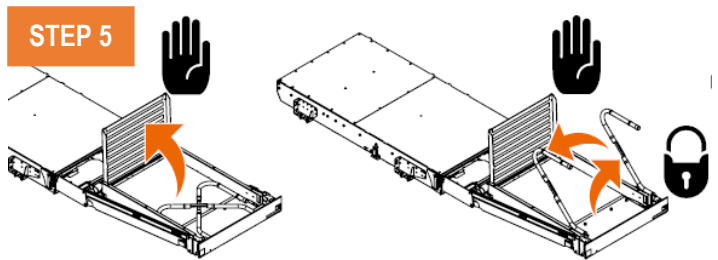
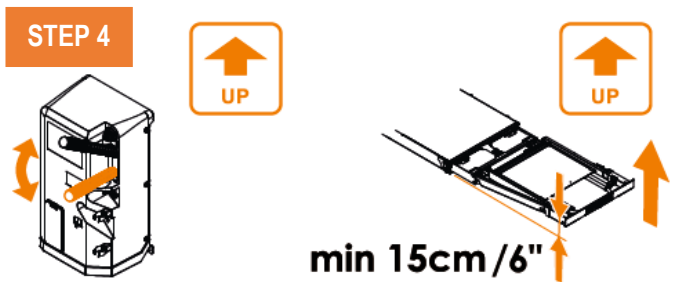
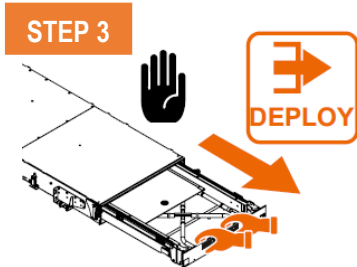

Emergency operation: STOW platform

STEP	Manual operation: STOW
8	Locate the electro valve between the lift arms. A screw is located underneath the nut. Remove the nut and turn the screw clockwise to close the valve.
9	Operate the hand pump to LIFT the platform and to close the roll stop. Lift the platform 15cm – 6 inches above the cassette-height. The platform stops as soon as the pump action has ended.
10	Release the lock on the roll stop and place it back on to the platform. Close the safety handrails manually by lifting them up to unlock. Place the bridge plate on the platform.
11	Press the Emergency Descent button on the power pack to lower the platform (= DOWN) until it comes to a stop. Cams on the lift arms will stop the platform at the correct height to initiate the STOW function.
12	Manually push the platform in the cassette (= STOW) until the platform comes to a complete stop. Make sure the platform is fully retracted inside the cassette and properly locked.

STEP 8

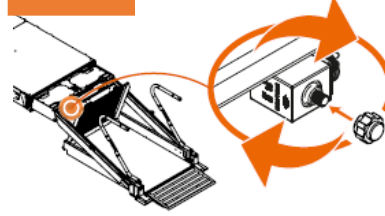

STEP 9

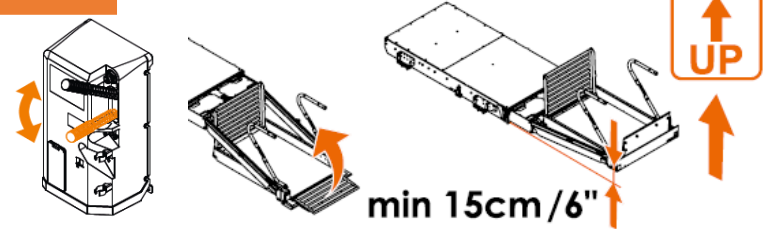

STEP 10

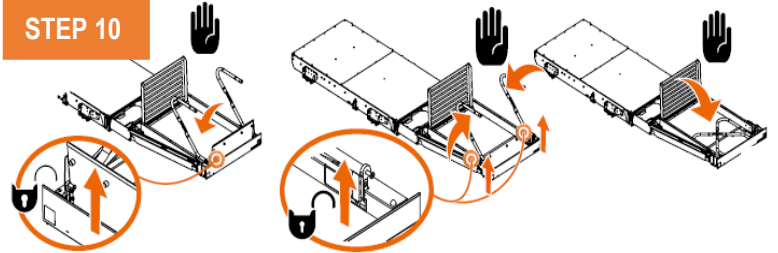

STEP 11

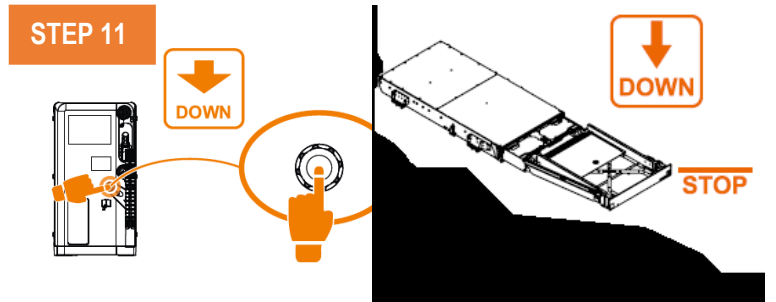

STEP 12

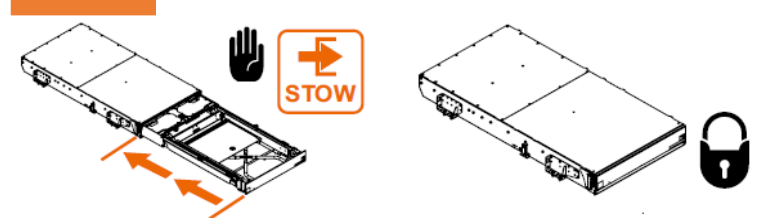

STEP 13

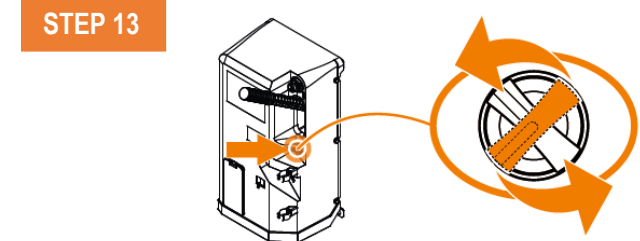

Emergency operation

STEP	Restoring automatic mode
13	Turn the EMR button back in its normal operative mode. Upon release of the emergency cassette lock, it should no longer be possible to pull out the platform manually.

- In order to put any of the emergency systems out of service again, proceed in opposite order.

7 TROUBLESHOOTING AND REPAIR

7.1 INTRODUCTION

- Troubleshooting chart can be used in two occasions:
 - For the operator to explain the severity and scope of the problem when contacting a DHOLLANDIA service agent.
 - For the DHOLLANDIA service agent to find and resolve the problem more quickly.
- It is very important that the troubleshooting is performed in a logical and systematic way. Too often components are replaced at random until the malfunction disappears. However, such methods can be very expensive for labor hours and the replacement parts costs.
- Therefore, it is very important to **identify quickly and precisely if a malfunction has an electric, a hydraulic or a mechanical cause.**
- The tables below can be used to guide you through the troubleshooting. Contact your national DHOLLANDIA distributor if further advice is needed.
- Refer to the MAINTENANCE AND REPAIR MANUAL of the lift for a complete copy of the troubleshooting charts.



- The latest version of the MAINTENANCE AND REPAIR MANUAL can be downloaded from the DHOLLANDIA website:
www.dhollandia.com → Country & language selection → Downloads → Operation manuals → ... select required manual



WARNING

Some steps in the troubleshooting instructions require special skills and specific knowledge, that can be acquired through the DHOLLANDIA training programs for maintenance and repair. In case of doubt, DON'T go any further, but ask your local DHOLLANDIA distributor for professional advice.

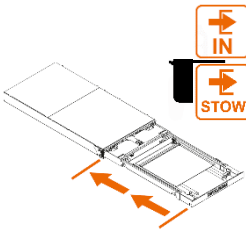
FUNCTIONS TEST / SELF-DIAGNOSIS			
Lift function	Condition	PCB lay-out	Check items
STOW/ IN 	<ul style="list-style-type: none"> • SWpower: ON • Emergency stop: OFF • Emergency Motor Release (S0): OFF • Battery voltage: 11-14 / 22-28V 		<ul style="list-style-type: none"> • SWdown • SWin (4 button ctrl) • R2 IN • COIL R2 • D • +BAT 12/24V • UNSTOW • +Rbat • LIFT ON • WORKING • +12/24V DC • SW0 • PARKING BRAKE • DOOR OPEN • INTERLOCK • Me power (5A) • Light • Buzzer • Rbat • EMG stop • SWpower

7.2 GENERAL TROUBLESHOOTING DIAGRAM

- A general troubleshooting diagram is provided in the appendix of the MAINTENANCE & REPAIR manual.
- Use this to locate and solve problems but keep in mind that repair or maintenance should always be done by certified DHOLLANDIA service agents.

8 DECALS

8.1 REGULAR DECALS

- The following decals are supplied with each new wheelchair lift and should be affixed to the vehicle body during installation in the manner set forth in the adjacent drawings.
- NEVER remove or paint over any decal. Missing, worn or illegible warning decals must be immediately replaced. Get free replacement decals from DHOLLANDIA. Contact your national DHOLLANDIA distributor. See page 4 for contact info.
- The operator should comply with all affixed safety and operation decals. Be aware that the decals merely summarize the main points, and that the operator must know, understand, and comply with the full contents of the operation manual.
- Note: the decals marked as “EXAMPLE” can vary in function of the maximum rated capacity of the wheelchair lift or the chosen type of external control box.

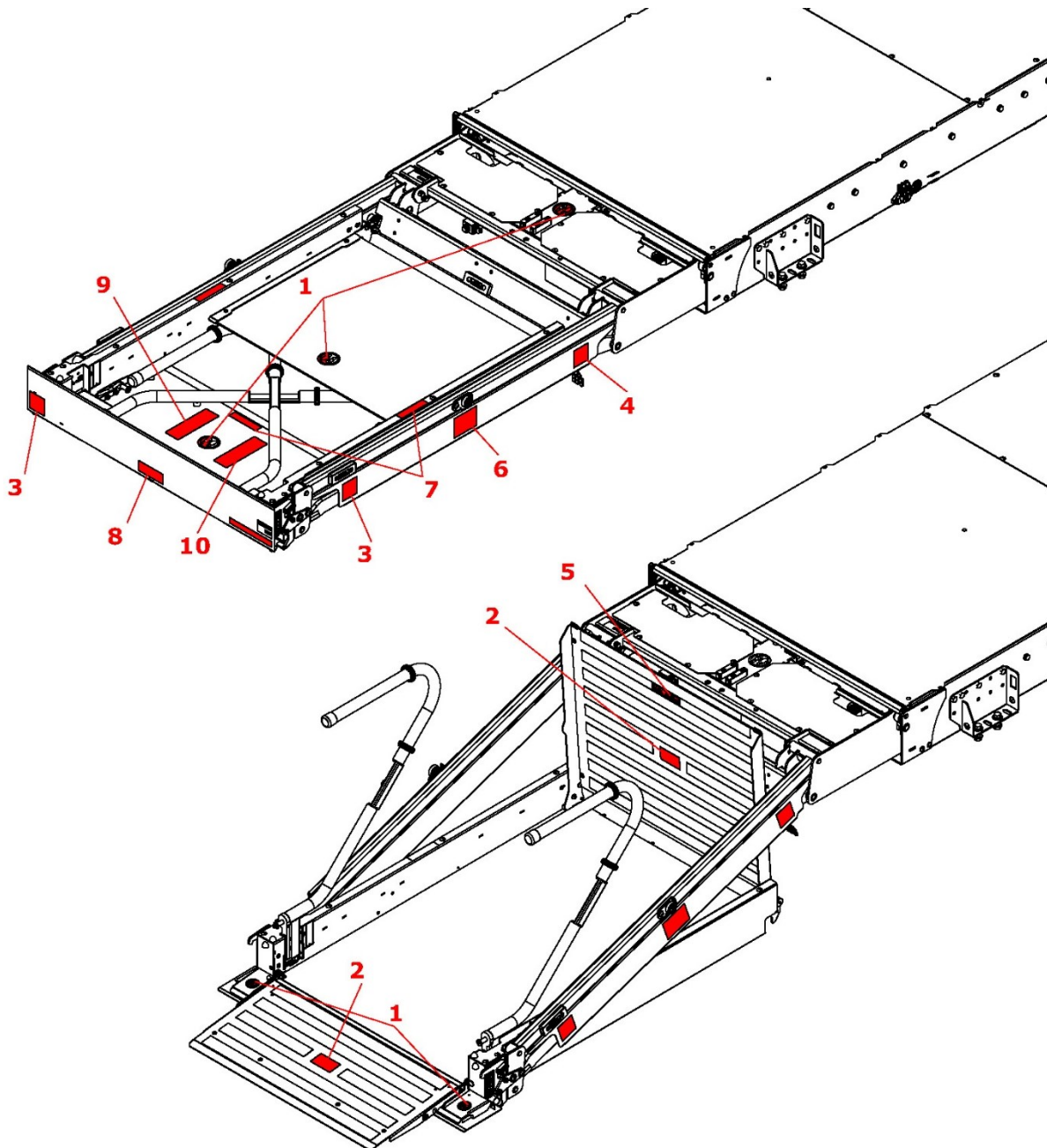

1

EF0505



2

EF0505.B



3

EF0506



4

EF0503



5

EF0570.CAP



6

EF0562.B

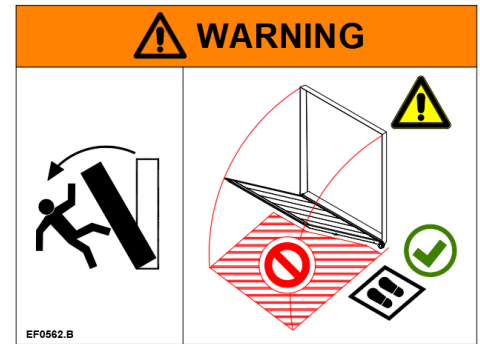

7

EF0593.EN



8

EF0562.EN



9

EF0507.170.05

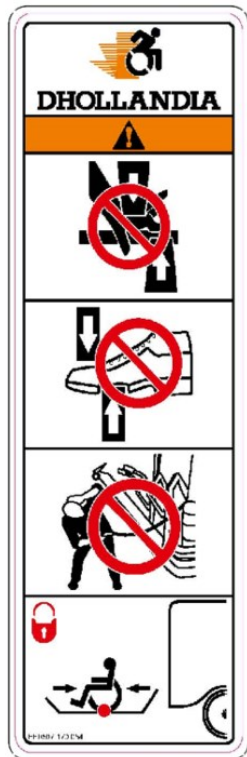

10

EF0504.170.05

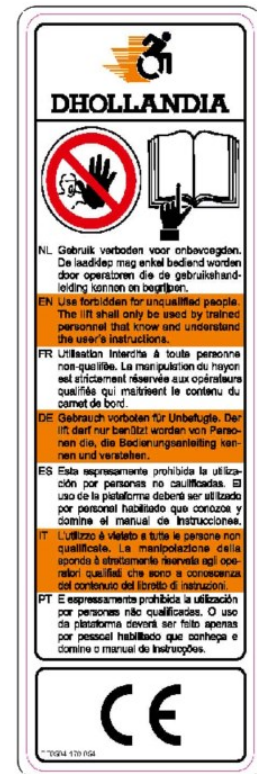

8.2 DECALS ON INSIDE OF BUS

- The following decals are supplied loose with the wheelchair lift and shall be affixed by the installer near to the lift at a location clearly visible to the operator, preferably inside the bus to maximize longevity.

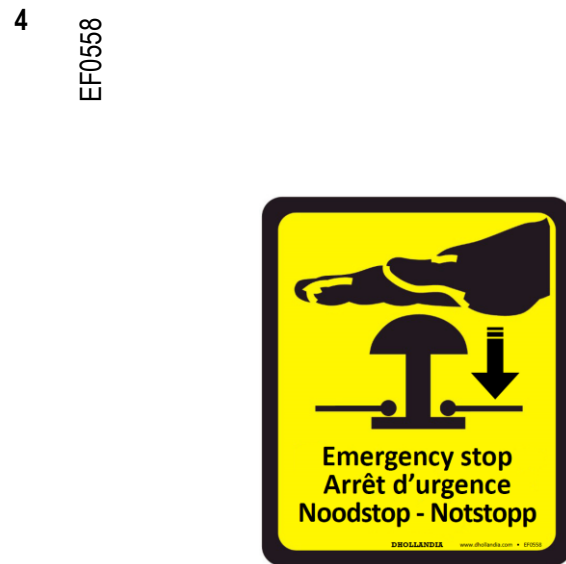
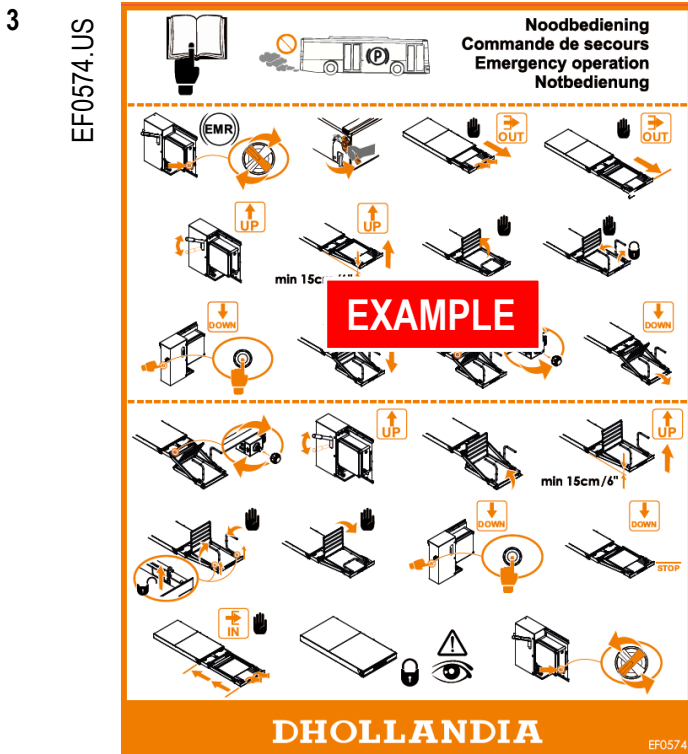
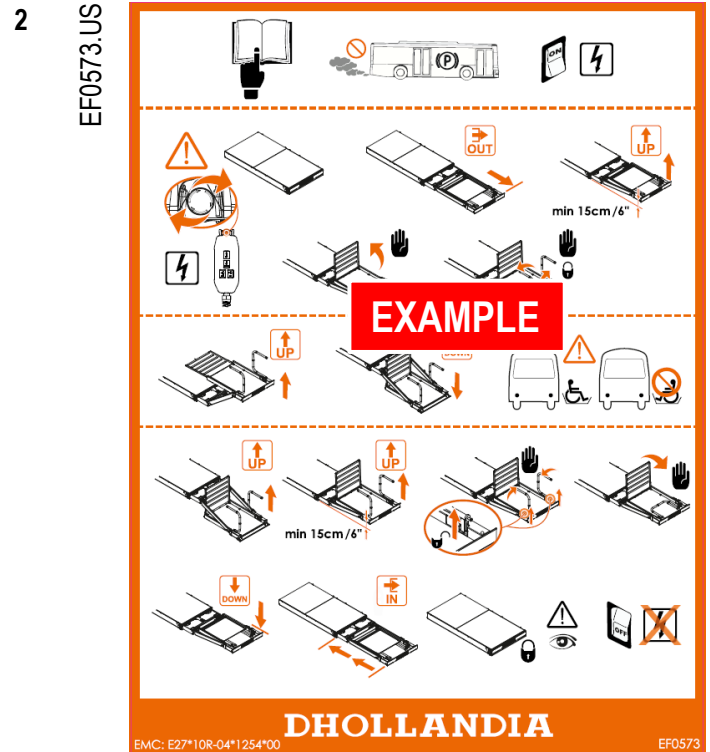
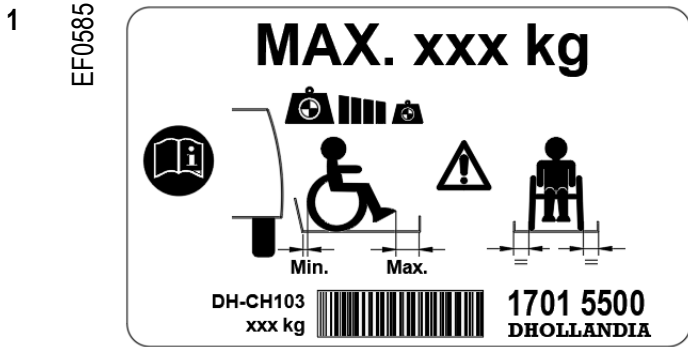

5

EF0504

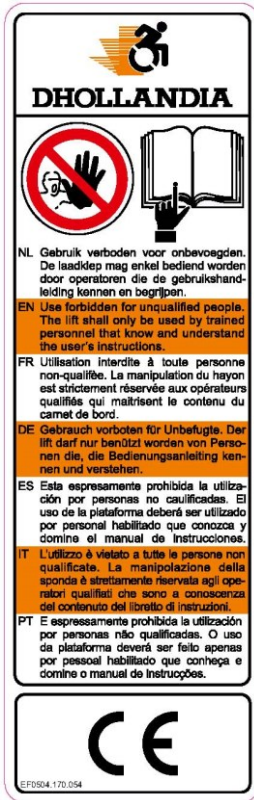

6

EF0507

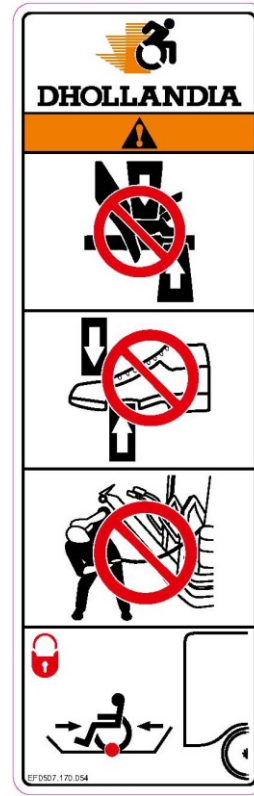

7

EF0563.EN







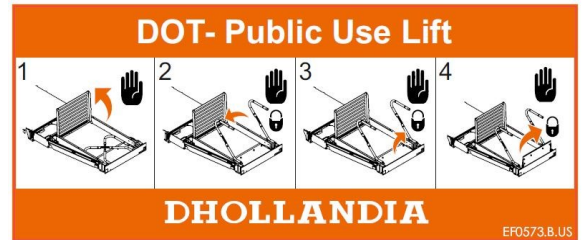













8





















EF0573.B.US

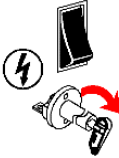

9 MEANING OF SAFETY AND WARNING SIGNS

WARNING signs		MANDATORY ACTION signs	
	Overview and keep visual control over the working area of the lift at all times.		Contact your regional DHOLLANDIA distributor.
	General warning sign used to alert the user to potential hazards. All messages that follow this sign shall be obeyed to avoid possible harm.		Consult the DHOLLANDIA website. Download from DHOLLANDIA website.
	Entrapment hazard. Keep hands, limbs, loose clothes and long hair away from moving parts.		Read the manual or instructions.
	Crushing & shearing hazard. Keep hands away from moving parts.		Hold onto handrail. Protect yourself from falling off the platform, or vehicle floor.
	Crushing & shearing hazard. Keep feet away from moving parts.		Wear safety gloves.
	Slipping hazard.		Wear safety-toe shoes.
	Tripping hazard.		Wear appropriate work clothes, avoid loose-fitting clothes that might be trapped in the moving parts of the lift.
	Hazard caused by tilting objects.		Wear safety protection, eye protection and a safety hard hat.
	Hazard of falling from heights.		
	Crushing & entrapment hazard. Keep head, upper body and limbs away from moving parts.		

PROHIBITION signs			
	General prohibition. DO NOT do!		DO NOT use machine by more than 1 operator!
	General prohibition. DO NOT do!		DO NOT step or stand here!

Other frequently used signs		Signs for electro/hydraulic functions	
	Yes, do this way. Correct work procedure.		Deploy the platform from its travel position to its work position.
	No, DO NOT do this way. -Incorrect work procedure.		Lower the platform.
	Position the load at the applicable center of gravity or load center. - Follow the load instructions.		Lift the platform
	Emergency stop. Will cause an immediate stop of the lift.		Stow the platform from its work position to its travel position.
	Emergency exit. Provision (lever, valve) creating an emergency exit.		LEG(S) DOWN: lower down the stabilizing legs
	Unlock. Disengage the mechanical locking system.		LEG(S) UP: raise the stabilizing legs
	Lock. Engage the mechanical locking system.		SWITCH between internal and external controls
	Switch ON the electrical power.		Normal operation by means of the electric controls
	Switch ON the electrical power to the lift via the main battery disconnect switch and / or cabin switch.		Switch OFF the electrical power to the lift via the main battery disconnect switch and / or cabin switch.
	Switch OFF the electrical power.		Manual emergency operation
	This is an operation to be executed manually (as opposed to an electrical function controlled by means of one of the control units).		

NOTICE

- The most important safety and operation instructions are summarized in a product video that can be viewed online at:

<http://www.dhollandia.com/uservideo/CH102-EN-2020>

- Please consider that the video is representing a generic lift. Your product could differ from the one displayed. Always follow the guidelines of this manual closely.
- Make sure you review these instructions prior to operation of the associated DHOLLANDIA lift.



NOTICE

- Competent and regular preventative maintenance is essential to the operational reliability, and the safety of the operator and bystanders.



- The latest update of our check-list for preventative maintenance & inspection can be downloaded from:

www.dhollandia.com → **Country & language selection** → **Downloads** → **Checklists** →
... **select required manual**

- All maintenance and repair work should be performed by authorized DHOLLANDIA service agents and using only authorized OEM DHOLLANDIA replacement parts.
- Consult the separate MAINTENANCE AND REPAIR MANUAL for safety instructions, maintenance guidelines, and troubleshooting support.
- Lubricate the lift on a regular basis to maximize its durability and operational reliability. This is at least 3 times per year in a single shift operation; more frequently in case of very intensive use (multiple shift, 24h operation, etc.) or use in hostile environment conditions (frequent high pressure cleaning with strong detergents, etc.).



- The latest version of the MAINTENANCE AND REPAIR MANUAL can be downloaded from the DHOLLANDIA website:

www.dhollandia.com → **Country & language selection** → **Downloads** → **Operation manuals** →
... **select required manual**