

# PREVOST<sup>®</sup>

COACH MANUFACTURER

OWNER'S MANUAL  
X3-45 VIP &  
LE MIRAGE XLII BUS SHELL



PA1583

PA1583 1<sup>ST</sup> Edition  
Date: March, 2011  
Starting from vehicle: B-5011  
Featuring: EPA 2010

This *Owner's Manual* for the PREVOST X3-45 VIP & Le Mirage XLII Bus Shell conforms with the new EPA 2010 regulations, featuring an engine with selective catalytic reduction SCR system. This manual has been prepared to thoroughly acquaint you, the owner, with vehicle's equipment and features in order to fully appreciate and safely enjoy your vehicle. Of course, you are anxious to drive your new private motorcoach and test its features, but first please read this publication carefully to help ensure enjoyable and trouble free operation. This book should be kept inside the vehicle at all times for convenient reference. It is also suggested that it remains with the vehicle at the time of resale. Please notify **Prevost Car, a division of Prevost Car (US) Inc.** when the vehicle's ownership is transferred so that our records can be kept up to date. Do this by filling out the appropriate form at the end of this manual.

The specifications, descriptions and figures given are based on the latest information available at printing time. And because at **Prevost Car, a division of Prevost Car (US) Inc.** we are constantly striving to improve our products, we reserve the right to make changes at any time without notice and/or obligation on our part.

Please note that this publication applies to factory-prepared, conversion-ready luxury motorcoaches, manufactured by **Prevost Car, a division of Prevost Car (US) Inc.** It describes and explains the equipment and options available for installation in our factory. Therefore, there may be equipment described herein that is not installed on your vehicle. This publication also does not cover equipment installed by your interior designer or system manufacturer.

This manual, or portions thereof, cannot be reproduced in any form whatsoever, in whole or in part, without the written consent of **Prevost Car, a division of Prevost Car (US) Inc.**

The following words are used to emphasize particularly important information:



## DANGER

Directs the operator's attention to unsafe practices which could result in serious personal injury or death.



## WARNING

Directs the operator's attention to unsafe practices which could result in serious personal injury or severe damage to the vehicle.



## CAUTION

Directs the operator's attention to unsafe practices where personal injury is not likely but damage to vehicle components could occur.

## *NOTE*

*Indicates supplementary information essential to the proper operation of the vehicle.*

For your own safety and to ensure prolonged service life of your private motorcoach, heed our warning labels: **DANGER**, **WARNING**, **CAUTION** and *NOTE*. Ignoring them could result in extensive damage and/or serious personal injury.





<b>Safety Precautions .....</b>	<b>1</b>
<b>Vehicle Exterior .....</b>	<b>5</b>
<b>Vehicle Interior .....</b>	<b>17</b>
<b>Controls and Instruments .....</b>	<b>23</b>
<b>Other Features.....</b>	<b>77</b>
<b>Starting and Stopping Procedures .....</b>	<b>111</b>
<b>Safety Features and Equipment.....</b>	<b>117</b>
<b>Care and Maintenance .....</b>	<b>129</b>
<b>Technical Information .....</b>	<b>149</b>
<b>Abbreviations .....</b>	<b>161</b>
<b>Appendix A – Service Literature .....</b>	<b>163</b>
<b>Appendix B – Troubleshooting Guide for Multiplex Vehicles .....</b>	<b>167</b>
<b>Appendix C – Allison Diagnostic Troubleshooting Codes .....</b>	<b>173</b>
<b>Appendix D – TPMS Troubleshooting Guide .....</b>	<b>185</b>
<b>Index.....</b>	<b>187</b>



# **Safety Precautions 1**

---

<b>SAFE OPERATING PRACTICES .....</b>	<b>2</b>
<b>DEFENSIVE DRIVING PRACTICES.....</b>	<b>2</b>
<b>OTHER PRECAUTIONS .....</b>	<b>3</b>

## 2 Safety Precautions

---

To ensure safe and reliable operation, heed the following safety precautions.

### SAFE OPERATING PRACTICES

- Operation and maintenance of the vehicle must be performed only by qualified personnel.
- Before driving, conduct a walk around inspection and check that all baggage compartment doors and equipment access doors are securely shut.
- Make sure good visibility is maintained at all times. Keep windshields clean and free of obstructions.
- Adjust the driver's seat so that all controls can be reached easily.
- Always wear the safety belt when driving.
- Check the instrument panel frequently. Do not operate the vehicle when dials or indicators are not in their normal operating condition.
- Always pay attention to pedestrians passing in front and behind the vehicle. Always yield to pedestrians at pedestrian walkways.
- Do not drive over obstacles on the road. Empty boxes, piles of leaves, and snowdrifts could conceal hidden dangers that could damage the vehicle suspension and underbody.
- When turning or changing lanes, signal your intention well in advance.
- When approaching to make a right turn, reduce the space between the vehicle and the curb to make sure another vehicle cannot pass on the right. Since the vehicle makes wide turns, allow enough space to make safe turns.
- Switch from high beams to low beams when meeting or following other vehicles within 500 feet (150 meters).
- Never leave the vehicle unattended with the engine running or with the key in the ignition. Turn off the engine, remove keys and apply the parking brake before leaving the vehicle.
- Shut-off the engine before refueling, adding oil, performing maintenance or servicing tasks, unless stated otherwise.

- Fuel is highly flammable and explosive. Do not smoke when refueling. Keep away from open flames or sparks.
- Do not run the engine or HVAC system with access doors left open. Close compartment doors before operating any equipment.
- Do not remove the surge tank filler cap or the cooling system pressure cap when the engine is hot. Let the engine cool down before removing filler caps.
- Do not attempt to push or pull-start a vehicle equipped with an automatic transmission.
- The service life of the vehicle depends on the kind of maintenance it receives. Always record any problems and report them immediately to maintenance personnel.
- Do not use the trailer hitch before reading the safety, technical and operational requirements on page 14 of this manual.

### DEFENSIVE DRIVING PRACTICES

- For city driving, allow a four to six second travel interval between your vehicle and the vehicle ahead. Increase this travel interval to six to eight seconds for highway driving. Increase time interval for driving at night or in foul weather.
- Be prepared to stop when approaching an intersection. The stopping distance of the vehicle increases with the weight and speed.
- Establish eye-to-eye contact with other drivers and with pedestrians. Use, high beam and low beam headlights, turn signals and horn as needed.
- On highway, don't stare at the road ahead. Keep your eyes moving. Check mirrors and dashboard instruments frequently.
- To keep the vehicle from drifting across lanes during highway driving, always look over the horizon on the road ahead.
- Adjust your speed to road conditions, traffic and visibility. Never exceed the posted speed limits.
- If another vehicle is following close behind, reduce your speed to let the vehicle pass.

For additional information about safe operation and defensive driving practices, contact the local department of motor vehicles authority.

**OTHER PRECAUTIONS****DANGER**

Prior to working on a system inside the vehicle, make sure to cut electrical power and air supply. A component could be supplied with electricity even if battery master switch is set to the *OFF* position and/or a component could be pressurized even if air tanks are emptied. Always refer to the appropriate wiring and pneumatic diagrams prior to working on electrical and/or pneumatic systems.

**CAUTION**

Prior to welding or soldering on the vehicle, disconnect all electronic modules, positive and negative battery connections. If these modules (ECM, CPC or VECU, TCM, ECU, ABS) are not disconnected, electronic components (EPROM, CHIPS) could be permanently damaged.

Refer to Section 00 of your maintenance manual for all related procedures.



<b>ENGINE COMPARTMENT COMPONENTS</b> .....	<b>8</b>
ENGINE COMPARTMENT R.H. SIDE DOOR.....	9
ENGINE COMPARTMENT REAR DOORS.....	9
<b>EXHAUST AFTERTREATMENT SYSTEM ACCESS DOOR</b> .....	<b>10</b>
<b>RADIATOR DOOR</b> .....	<b>10</b>
<b>CATALYTIC CONVERTER ACCESS DOOR</b> .....	<b>10</b>
<b>CONDENSER COMPARTMENT (A/C)</b> .....	<b>11</b>
<b>EVAPORATOR COMPARTMENT</b> .....	<b>11</b>
<b>FRONT ELECTRICAL AND SERVICE COMPARTMENT</b> .....	<b>11</b>
<b>BAGGAGE COMPARTMENTS</b> .....	<b>12</b>
<b>RECLINING BUMPER COMPARTMENT</b> .....	<b>13</b>
<b>FUEL AND DIESEL EXHAUST FLUID (DEF) FILLER DOOR</b> .....	<b>13</b>
<b>ENTRANCE DOOR</b> .....	<b>14</b>
KEYLESS ENTRY SYSTEM.....	14
<b>REAR VIEW MIRRORS</b> .....	<b>15</b>
<b>BACK-UP CAMERA</b> .....	<b>15</b>
<b>110-120 VOLT CONNECTOR</b> .....	<b>15</b>
<b>TRAILER HITCH</b> .....	<b>16</b>

## 6 Vehicle Exterior

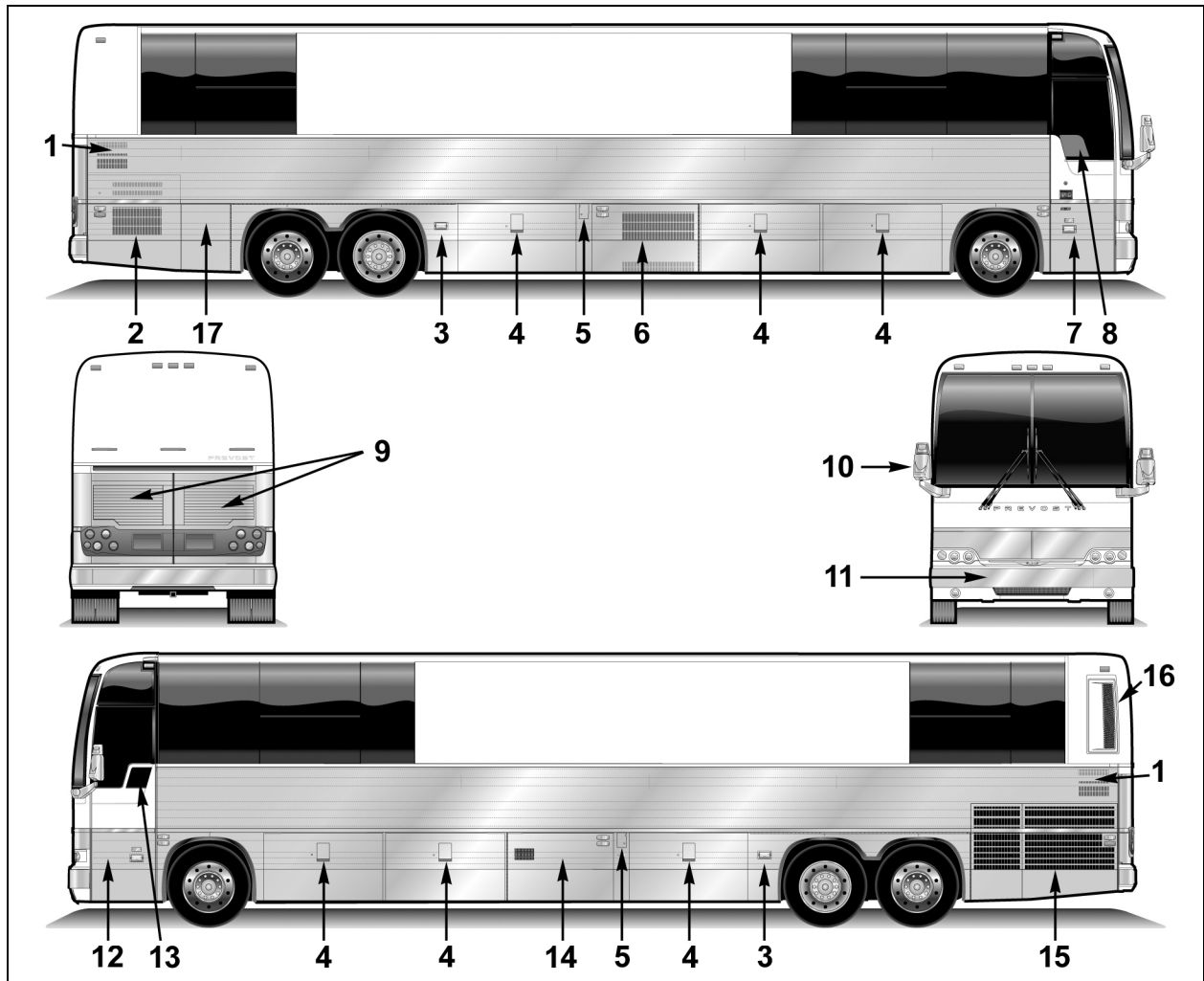

X3-45 VIP EXTERIOR VIEW (TYPICAL)

18576

- |                                      |   |
|--------------------------------------|---|
| 1. Engine air intake                 | 10. Rear-view mirror  |
| 2. Engine compartment R.H. side door | 11. Reclining bumper  |
| 3. Hinged rear fender                | 12. Front electrical and service compartment                |
| 4. Baggage compartment               | 13. Driver's power window                                   |
| 5. Fuel filler door                  | 14. Evaporator or baggage compartment                       |
| 6. Condenser or baggage compartment  | 15. Radiator door   |
| 7. Entrance door                     | 16. Diesel Particulate Filter (DPF) compartment access door |
| 8. Entrance door power window        | 17. R.H. side rear service compartment                      |
| 9. Engine compartment rear doors     |   |



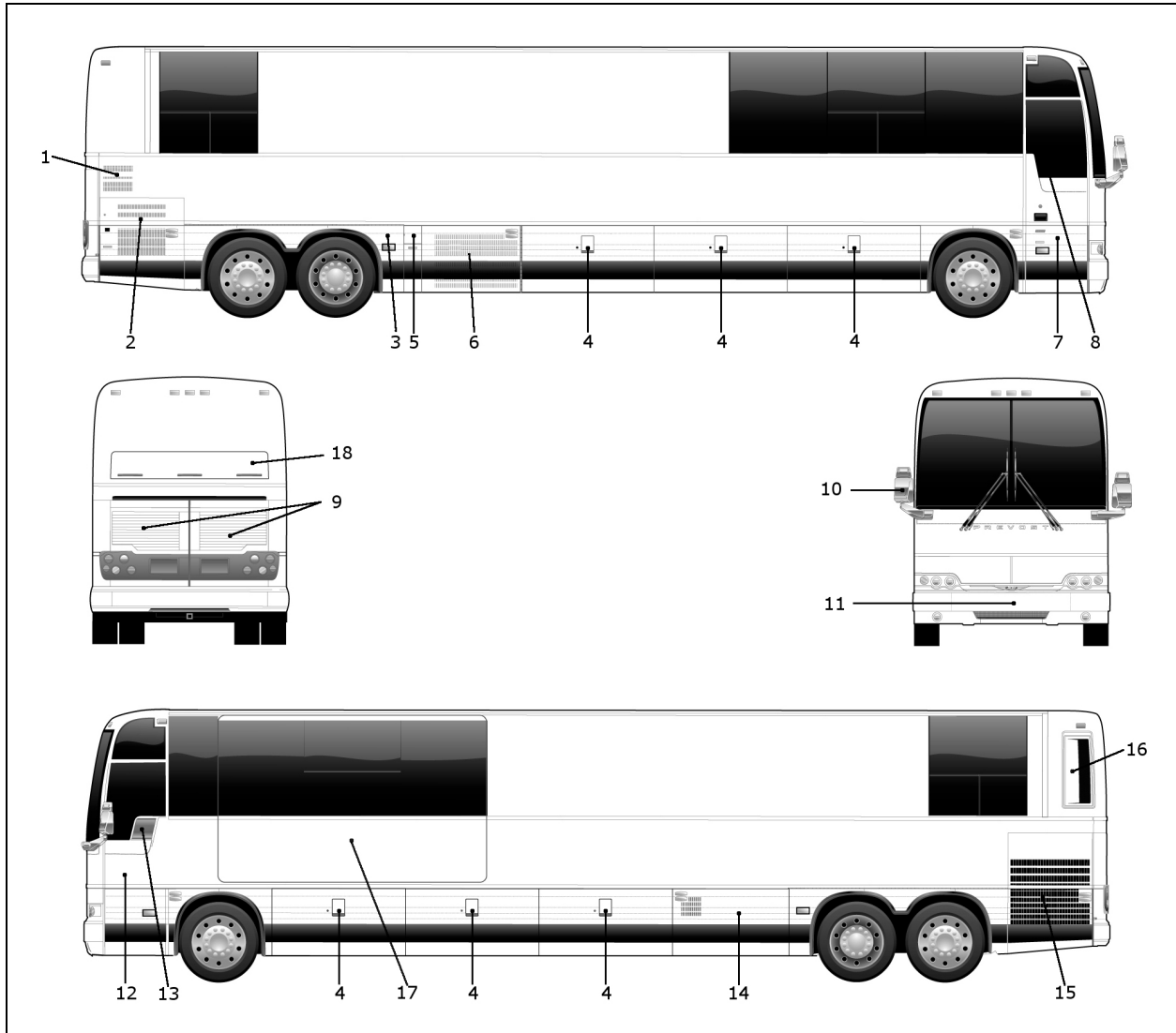

LE MIRAGE XLII BUS SHELL EXTERIOR VIEW (TYPICAL)

18622

- |                                      |   |
|--------------------------------------|---|
| 1. Engine air intake                 | 10. Rear-view mirror                          |
| 2. Engine compartment R.H. side door | 11. Front reclining bumper                    |
| 3. Hinged rear fender                | 12. Front electrical and service compartment  |
| 4. Baggage compartment               | 13. Driver's power window                     |
| 5. Fuel filler door                  | 14. Evaporator compartment                    |
| 6. Condenser compartment             | 15. Radiator door                             |
| 7. Entrance door                     | 16. Catalytic Converter access door           |
| 8. Entrance door power window        | 17. Front Slide-Out (Optional)                |
| 9. Engine compartment rear doors     | 18. Exhaust Aftertreatment System access door |

### ENGINE COMPARTMENT COMPONENTS

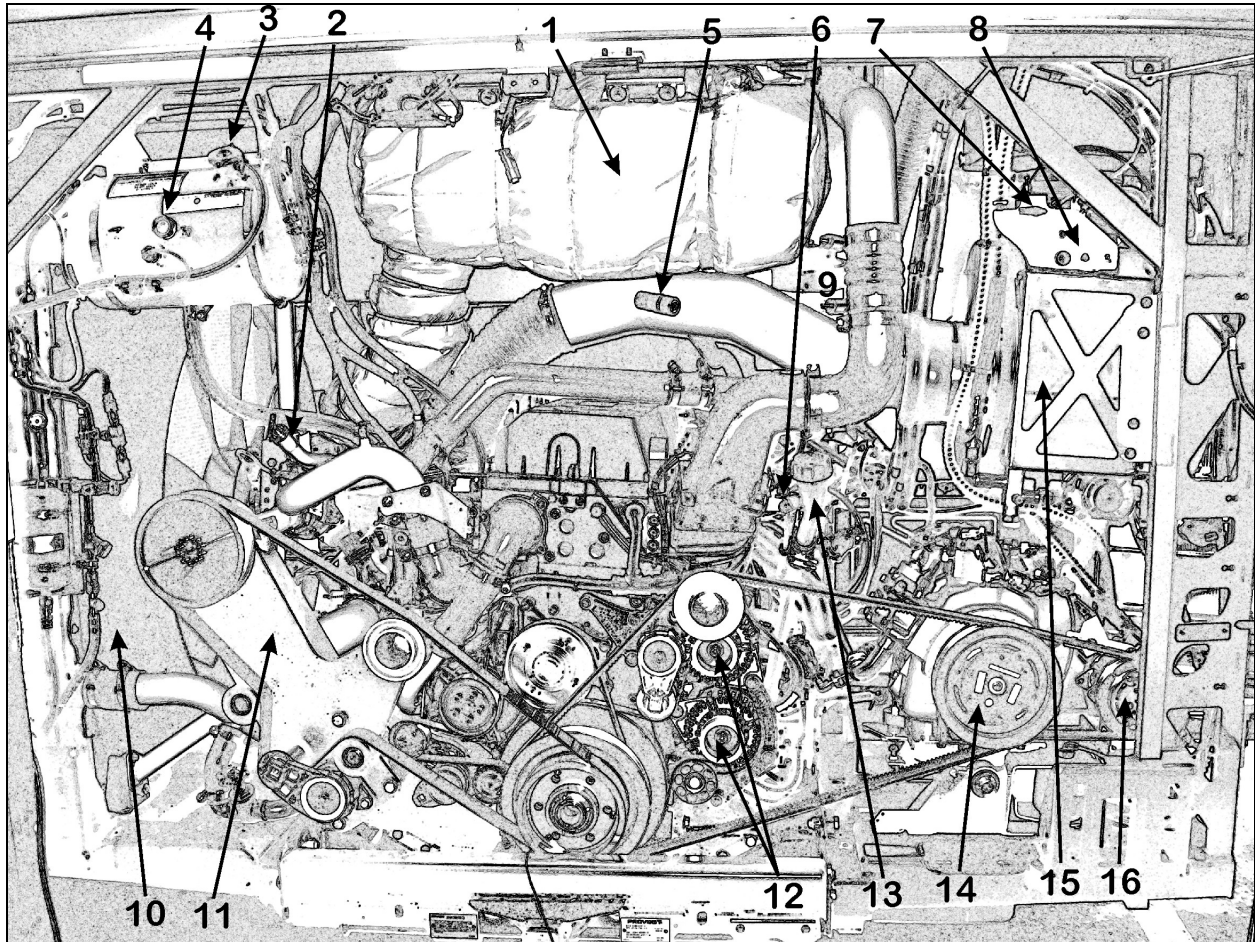

ENGINE COMPARTMENT FEATURING VOLVO D13 ENGINE

01184

1. Diesel Oxidation Catalyst (DOC) & Diesel Particulate Filter (DPF) Assembly;
2. Transmission fluid dipstick (if equipped with Allison transmission);
3. Coolant fluid surge tank filler cap;
4. Coolant fluid surge tank sight glass;
5. Air filter restriction indicator;
6. Engine oil dipstick;
7. Belt tensioner control valve;
8. Starter selector switch and Engine rear start push-button switch, Engine compartment Lights Switch;
9. Power steering fluid reservoir;
10. Radiator and charge air cooler;
11. Radiator fan drive mechanism support;
12. Alternators;
13. Engine oil filler tube;
14. Central A/C compressor;
15. Air filter;

Most serviceable parts may be accessed through exterior compartments. There may be slight differences in the location of parts and in the configuration of compartments between models, depending on options.

**ENGINE COMPARTMENT R.H. SIDE DOOR**

The engine compartment R.H. side door provides access to the following (if equipped):

- Engine compartment rear door release lever;
- Batteries;
- Battery equalizer;
- Circuit breakers Panel;
- Rear Junction Box;
- Booster terminals;
- Alternator(s);
- Allison Transmission Control Module (TCM);
- Primary air circuit fill valve and drain cock;
- Fuel filter/water separator;
- 110-120 volt connector.
- A/C Compressor.

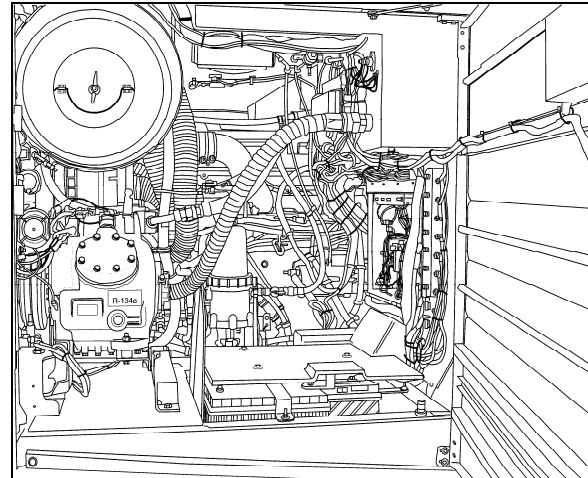

ENGINE COMPARTMENT R.H. SIDE 18513

**ENGINE COMPARTMENT REAR DOORS**

To open the engine compartment rear doors, open the engine compartment R.H. side door and pull the lever located on the rear door, close to the bottom door hinge. The engine compartment doors swing out to provide access to the following:

- Engine;
- Alternator(s);
- Compressor(s);

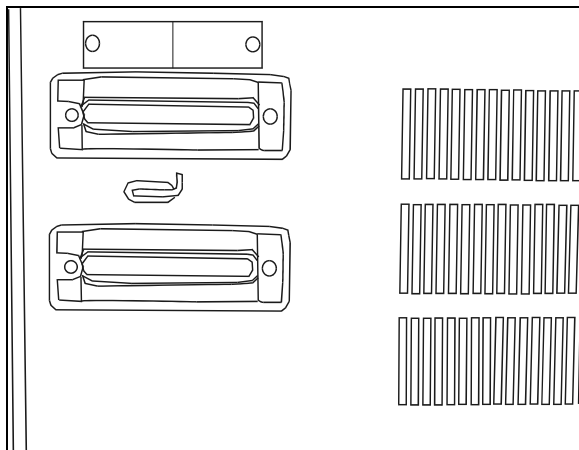

ENGINE COMPARTMENT R.H. DOOR 18559

This door can be locked or unlocked using the exterior compartment key or, if so equipped, by the central door locking system. To open, push sideways the small lever located between the marker lights.

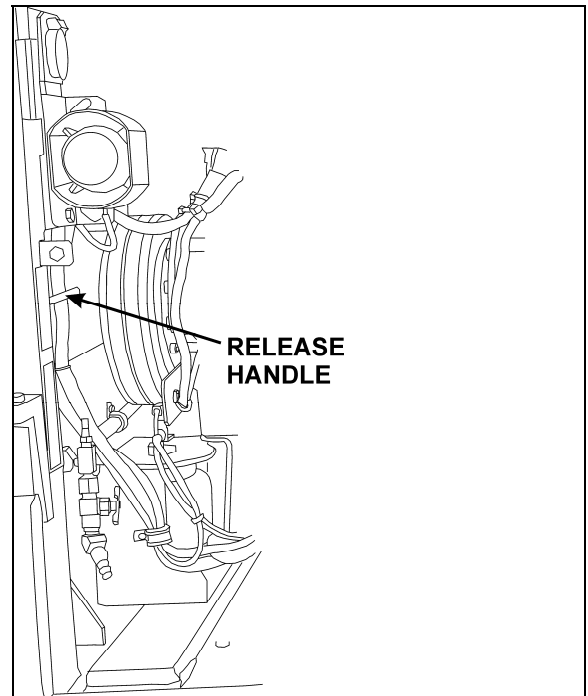

OPENING THE ENGINE COMPARTMENT REAR DOORS FROM R.H. SIDE DOOR 18547

- Belt tension valve (refer to Care and Maintenance chapter);

## 10 Vehicle Exterior

- Engine starting selector (refer to Starting and Stopping Procedures chapter);
- Certification plates;
- Engine coolant surge tank;
- Air cleaner restriction indicator;
- Engine oil dipstick;
- Power steering fluid reserve tank;
- Automatic transmission oil dipstick and filler tube;
- Engine coolant filler cap.

A catch holding each door open engages when the door is fully open. Release the catches before closing the doors. Close the L.H. door first, then firmly shut the R.H. door.

Turn the lights ON in the engine compartment using the switch on the rear start panel.



### WARNING

Unless otherwise specified, do not run engine when the engine compartment rear doors are open. Close the engine compartment rear doors before starting the engine.

### EXHAUST AFTERTREATMENT SYSTEM ACCESS DOOR

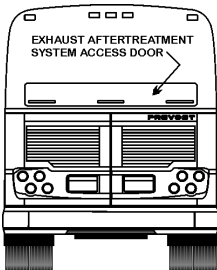

The engine door must be open before opening the exhaust aftertreatment system access door. To open the access door, lower the latch release lever, using a flat tip screwdriver.

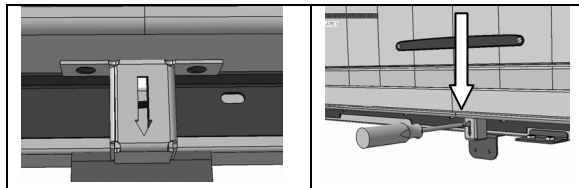

To close the door, lower the door and push against the release lever spring to latch the door shut.

### RADIATOR DOOR

Open the engine radiator door by pushing sideways the release lever.

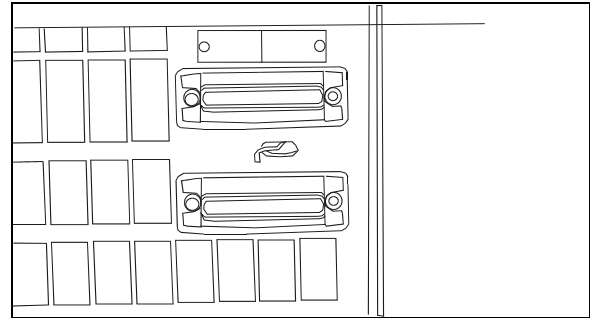

RADIATOR DOOR

18560

### CATALYTIC CONVERTER ACCESS DOOR

To gain access to the catalytic converter, open the radiator door first. At the top of the radiator compartment, pull the catch connecting rod to unlock the catalytic access door and lift the door open.

Hold the door open by inserting the support rod free end into the receptacle located on the left side of the catalytic converter.

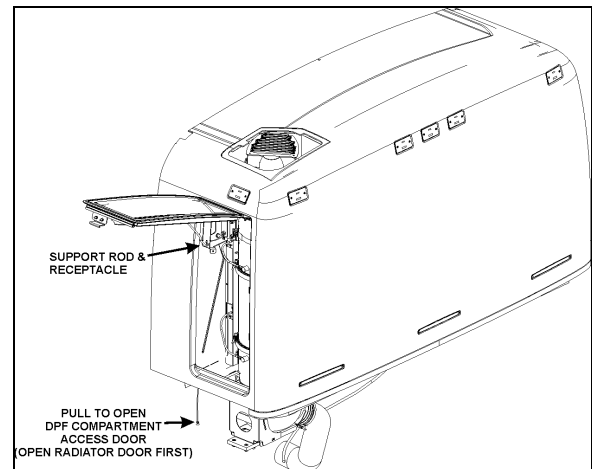

ACCESS TO THE CATALYTIC CONVERTER

04018



### WARNING

After inserting the support rod into the receptacle, make sure the rod supports the door securely from falling down on to your head or body.

 **WARNING**

External and internal temperatures remain hot long after engine has been shutdown. Allow the Aftertreatment Device and DPF to cool before handling. Wear protective clothing and glove while servicing.

**CONDENSER COMPARTMENT (A/C)**

Pull the release latch located inside the adjacent baggage compartment to open the condenser door.

The condenser compartment provides access to the following:

- Diesel Exhaust Fluid (DEF) tank;
- Condenser;
- Condenser fans and motors;
- Filter dryer and moisture indicator;
- Receiver tank.

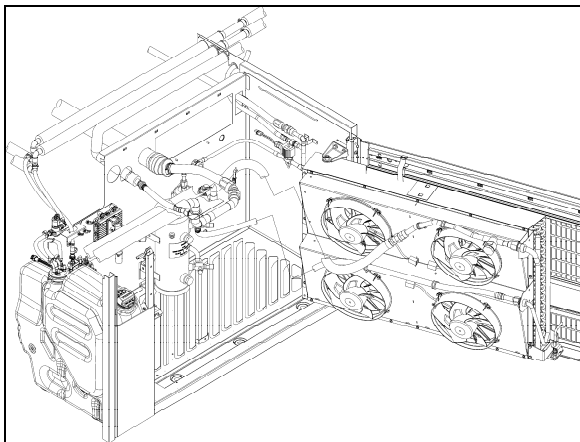

CONDENSER COMPARTMENT (A/C)

**EVAPORATOR COMPARTMENT**

The HVAC (Heating, Ventilating and Air-Conditioning) evaporator blower and coolant heater are located in this compartment. The compartment door release latch is located on the right side of the baggage compartment and to the left of the HVAC compartment door. Pull the release latch then swing the HVAC compartment door open.

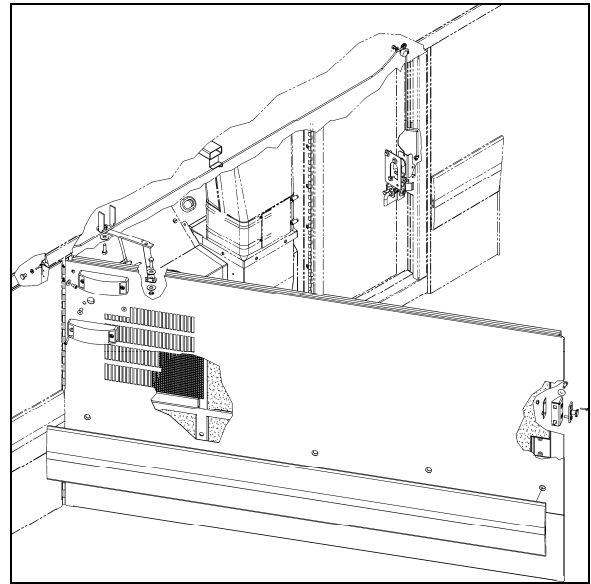

EVAPORATOR COMPARTMENT

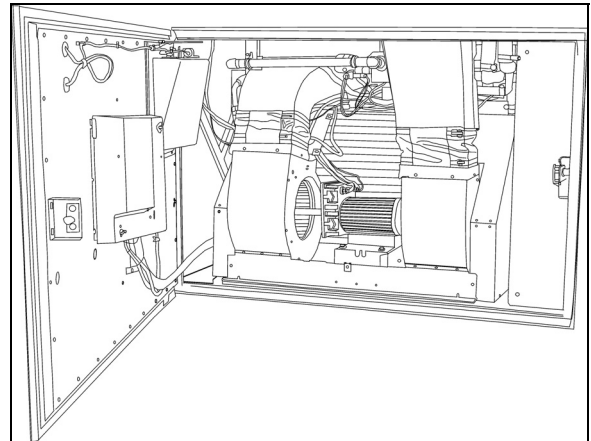

EVAPORATOR COMPARTMENT

22274

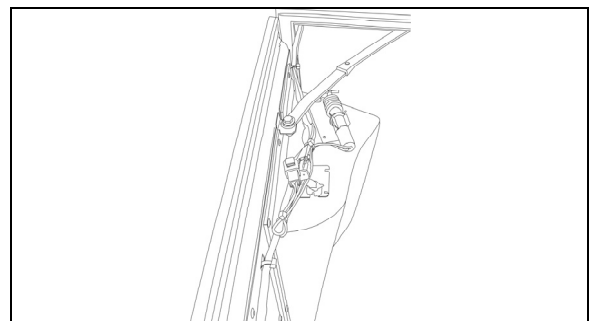

RECIRCULATION DAMPER

22302

**FRONT ELECTRICAL AND SERVICE COMPARTMENT**

To open the front electrical and service compartment door, pull the rod inside the vehicle, next to the driver's power window or use the key to open from outside the vehicle. The

## 12 Vehicle Exterior

front electrical and service compartment provides access to the following:

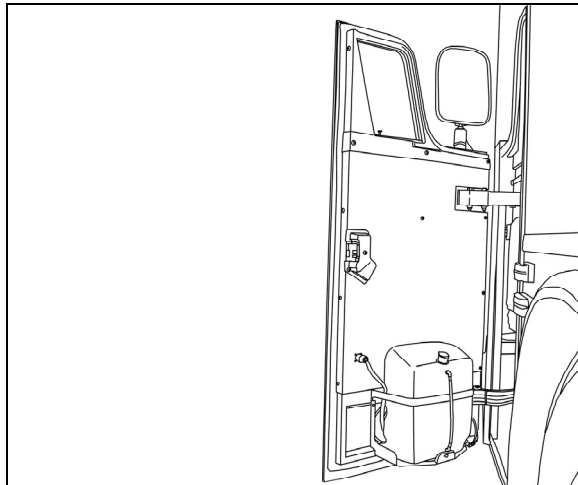

FRONT SERVICE COMPARTMENT DOOR 18381

- Front terminal block;
- VECU;
- Vehicle Electrical Center Front (VECF) CECM and Multiplex Modules;
- Keyless module;
- Relays and fuses;
- Windshield washer reservoir & headlights washer reservoir;
- Accessory air tank drain valve;
- Accessory system fill valve;
- ABS Electronic Control Unit (ECU).

The light in the front electric & service compartment turns *ON* automatically when the door is opened.

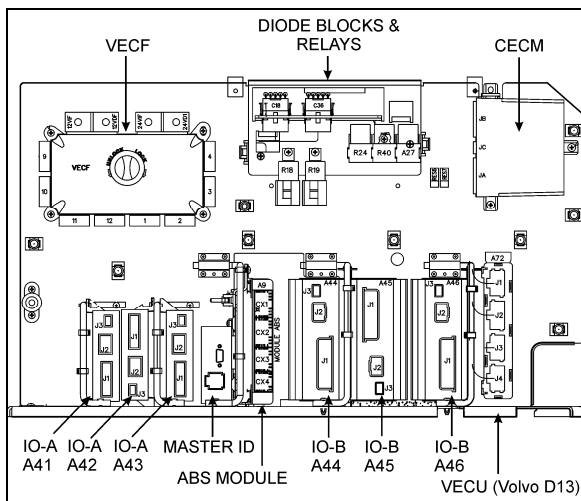

FRONT ELECTRICAL COMPARTMENT 06665

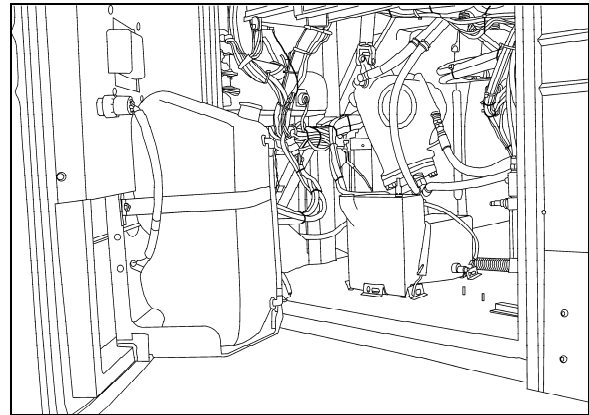

FRONT SERVICE COMPARTMENT 06532

## BAGGAGE COMPARTMENTS

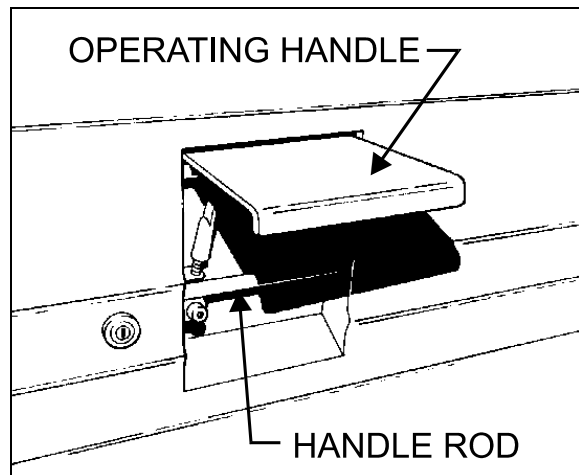

BAGGAGE DOOR LOCK AND LEVER 18043

The baggage compartment doors of the “X” Series models provide 407 ft<sup>3</sup> (11,53 m<sup>3</sup>) of storage capacity. The compartments can be locked or unlocked by using the exterior compartment key. Pull up operating handle to release the latch, and then pull the door open. Pressurized cylinders assist the opening and closing of the baggage compartment doors and hold the doors open.

To close, pull the door down by the handle rod. Complete the closing of the door by returning the operating handle to its initial position.



### CAUTION

Do not slam shut the baggage compartment doors. Damage to door weather-stripping or locking mechanism could result.

Lights in the baggage compartments turn *ON* automatically when the door is opened.



**WARNING**

To avoid injury, keep hands clear of baggage compartment door edge and door frame when closing.

**NOTE**

To prevent theft and vandalism, always lock the baggage compartment doors before leaving the vehicle unattended.

**NOTE**

For added safety, use the safety catch to keep the door securely opened.

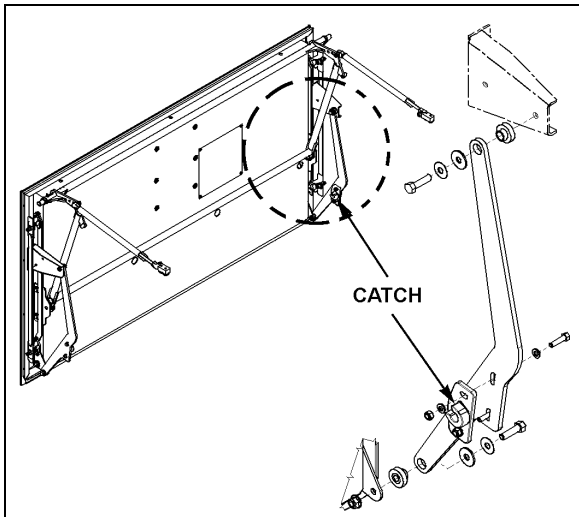

BAGGAGE DOOR CATCH

18612

**NOTE**

The baggage compartment doors can be locked/unlocked from the driver's position by the optional central locking system. The switch is on the L.H. control panel. Refer to "Controls & Instruments" chapter.

**RECLINING BUMPER COMPARTMENT**

The front bumper can be tilted downward to give access to the bumper compartment. Pull the release handle located inside front service compartment to unlock. Tilt down the entire bumper assembly to access the compartment. Push the bumper back up firmly in place to lock in position.



**WARNING**

The compartment behind the bumper is not designed for storage. Never store loose objects in this compartment since they can interfere with the steering linkage mechanism. Use care when opening or closing the reclining bumper compartment to prevent personal injury.

**FUEL AND DIESEL EXHAUST FLUID (DEF) FILLER DOOR**

The fuel and Diesel Exhaust Fluid (DEF) filler door is located on the R.H. side of the coach providing easy filling. A spring keeps the door either open or shut. A key is provided for unlocking the door if the option was chosen.

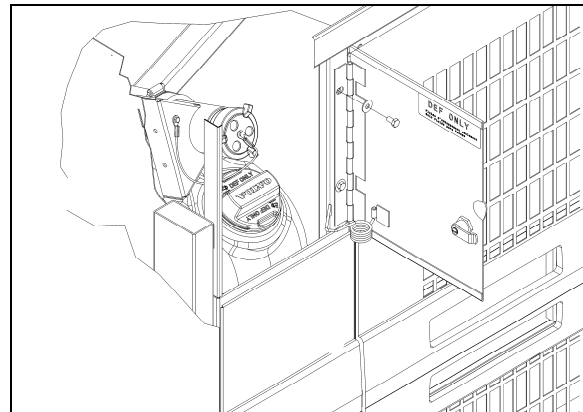

FUEL & DEF FILLER DOOR

03046

**NOTE**

Provided the vehicle is parked on level ground, an automatic nozzle will automatically shut off when tank is approximately 95% full.



**CAUTION**

Do not fill to more than 95% of the tank capacity. Do not "top off" the tank, doing so may result in fuel spillage when the fuel expands.

**NOTE**

The fuel filler door locks must be in the unlocked position before closing.

### ENTRANCE DOOR

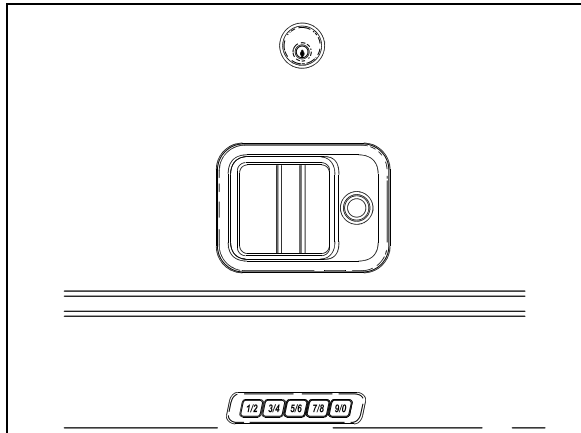

ENTRANCE DOOR

18380

Lock or unlock the entrance door from outside the vehicle by either turning the key in the door lock (counterclockwise to lock, clockwise to unlock), by using the outside key pad (see “Keyless Entry System” in this chapter), or by using the remote control (electronic key). Open the door by pulling on the lever. Close by pushing the door shut.

There are two ways of unlocking the entrance door from the inside. The first consists in actuating the rocker switch on the R.H. dashboard panel. This operation will also unlock the baggage compartments. Also, you can unlock the entrance door by sliding its lock lever to the left. If the orange tab on the door-lock lever is visible, the door is unlocked.

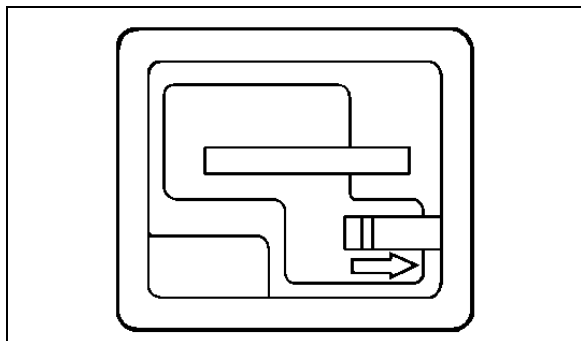

DOOR-LOCK PANEL

18187

### KEYLESS ENTRY SYSTEM

By using this system, you can lock or unlock the entrance door and the baggage and service compartment doors. The keyboard is located below the entrance door handle. The master code in the microprocessor/relay module is pre-programmed by the manufacturer and cannot be deleted. Moreover, you can program your own entry code (e.g. a birthday or part of a social security number).

The master code is:

- Printed on the owner's wallet card;
- Printed on three decals, joined to the owner's wallet card.
- Printed on decal affixed to the keyless system microprocessor/relay module in the front console;

When you use the keyless entry system, the keyboard and step lights illuminate.

Do not push the buttons with a key, pencil or any other hard or sharp object as the buttons could be damaged. Although each button is provided with two digits separated by a vertical line, there is only one contact per button. Press in the center of the button (between the two digits, on the vertical line).

You must unlock the entrance door before you unlock any other baggage or service compartment door. If you let more than five seconds pass between the numbers you press, the system shuts down, and you have to enter your code again. If the keyless entry system does not work properly, use the key to lock or unlock entrance or compartment doors.

### Keyless Operating Instructions

1. To unlock the entrance door, enter the five digits of the code. After pressing the fifth digit, the door will unlock. During the night, press any button to illuminate the keyboard, and then enter the code.
2. When pressing any button, the keyboard lights up for five seconds and the step lights illuminate for twenty-five seconds.
3. To unlock the baggage and service compartment doors, press button 3|4 within five seconds of entering the code.
4. To lock entrance door and compartments all at the same time, press buttons 7|8 and 9|0 at the same time.

### Programming Your Personal Code

#### **NOTE**

*To avoid erasing your personal code from the system memory, you should connect the keyless entry system to house batteries, otherwise the code will be erased each time battery main disconnect switches are set to the OFF position.*



You can program a personal code to unlock the entrance door and compartments. This code does not replace the permanent code that is programmed into the system. Use your personal code in the same manner that you would use the original code.

Do not choose a code that presents the numbers in sequential order, such as 1|2, 3|4, 5|6, 7|8, 9|0. Studies show that people who idly press the buttons usually press a sequential pattern. Also, do not select a code that uses the same button five times. Thieves can easily figure out these types of codes.

1. Choose and memorize your personal code.
2. Enter the original code, and within five seconds, press button 1|2.
3. Within five seconds of pressing button 1|2, enter your personal code, pressing each button within five seconds of the previous digit. The keyboard light will immediately turn OFF if the code is correctly entered.

The keyless entry system registers your personal code. To unlock the entrance door, you can use either code.

To erase your personal code, enter the original code, press button 1|2, then wait six seconds.

Refer to "Controls and instruments" chapter, for instructions on remote unlock key fob. Refer to "Other Features" chapter, for full details on keyless entry system.

### REAR VIEW MIRRORS

The vehicle is equipped with flat-type and convex-type rear-view mirrors. Convex mirrors give a wide angle view. Objects viewed in convex-type rear-view mirrors appear smaller and are actually closer than they appear.

To provide good visibility in cold weather, the mirrors are equipped with heating elements. The elements are activated by a rocker switch located on the dashboard. Refer to "Controls & Instruments" chapter. Thermostats are used to prevent continuous operation of the heating elements.

	<h3>CAUTION</h3>
<p>Do not attach stick-on type convex mirror accessories to the heated mirror glass. This could impede uniform heat distribution on the mirror surface and could break the mirror glass.</p>	

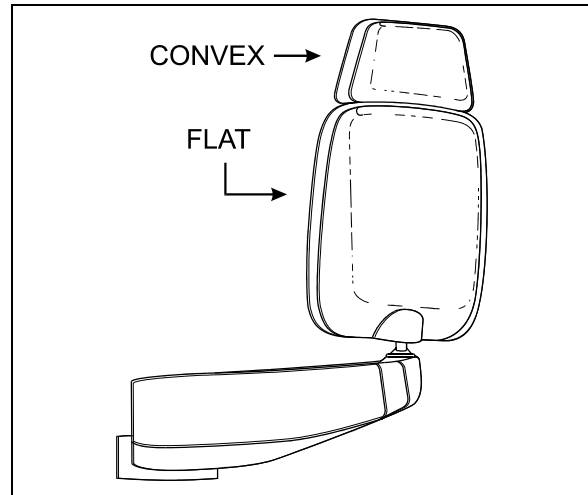

REAR VIEW MIRRORS 18376

The mirrors are adjusted using the controls located on the L.H. control panel. Refer to "Controls & Instruments" chapter. Manual adjustment is also possible.

Adjust the side-view mirrors until the side of the vehicle is visible. Adjust the flat-type mirror until the road behind is in full view.

### BACK-UP CAMERA

An optional back-up camera is available which provides the driver with visual assistance when backing-up. For additional information, refer to "Controls & Instruments" and 'Care and maintenance' chapters.

### 110-120 VOLT CONNECTOR

This connector is connected to the electric block heater and uses a 110-120 VAC power source. It is located near the engine compartment rear doors release handle. (Refer to chapter "Starting and Stopping Procedures").

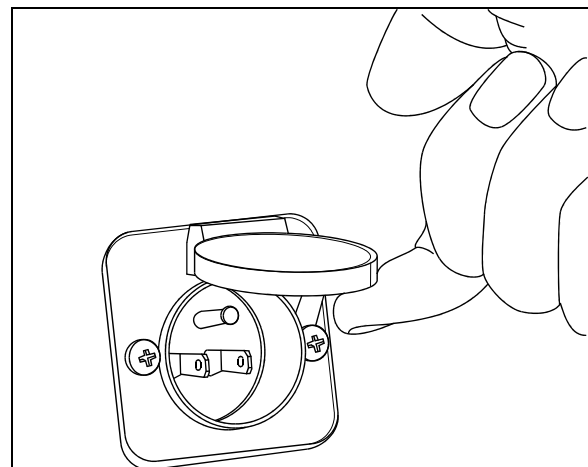

110-120 VOLT CONNECTOR 06390

**TRAILER HITCH**

**20 000 lb max. Gross trailer weight capacity (optional)**

Your vehicle may be equipped with a factory installed trailer hitch which has been designed to meet the following rating:

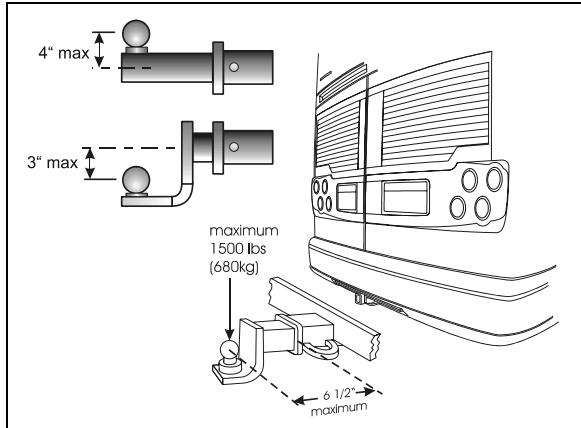

TRAILER HITCH

23337

- **Maximum gross trailer weight: 20,000 lb (9072 kg)**
- **Maximum tongue weight at 6 1/2 inches (165 mm) or less from coupling receiver: 1,500 lb (680 kg)**

**DANGER**

The draw bar and the ball used for towing the trailer should be rated for 20,000 lbs capacity or more.

**WARNING**

Pulling a trailer weighing more than the recommended maximum gross weight may cause engine and transmission overheating, and also possible hitch failure.

**NOTE**

*Pulling a trailer over long distances is considered as a "severe operating condition" for the vehicle and therefore, power plant requires more frequent servicing.*

**NOTE**

*The minimum requirement for a trailer weighing up to 20,000 lbs when coupled to a 20,000 lb Prévost Trailer Hitch is as per the following:*

1. Trailer must comply with **Federal Motor Carrier Safety Regulations 393.52** regarding trailer breaking capability.
2. The trailer coupling attachments meet the following minimum static test load requirements :
  - Longitudinal tension and compression: (1.5 x GVWR of trailer)
  - Transverse thrust: (0.5 x GVWR of trailer)
  - Vertical tension and compression: (0.5 x GVWR of trailer)

Loads indicated must be applied without incurring loss of attachments or distortion or failure which could affect the safe towing of trailer.
3. The ball and trailer coupling should meet the following minimum test load requirements without incurring failure:
  - Longitudinal tension and compression: (Gross Trailer Weight of trailer x 3)
  - Transverse thrust: (Gross Trailer Weight of trailer x 1)
  - Vertical tension and compression: (Gross Trailer Weight of trailer x 1.3)

*In this case, failure is identified as the point at which the coupling or ball will accept no additional test load without separation of the ball from the coupling ball socket, or the occurrence of a metal fracture of either coupling ball or coupling assembly, which results in separation of the ball from the coupling ball socket.*
4. Two lengths of safety chain shall be used. The strength rating (minimum breaking force) of each individual chain and its connecting means shall be equal to, or exceed the trailer GVWR.
5. Towing vehicle must be equipped with engine or transmission retarder. The engine or the transmission retarder on the vehicle must be functional at all time (to be inspected frequently).
6. This hitch must be used for recreational use only.

- DRIVER’S SEAT - DELIVERY ..... 18**
- DRIVER’S AND CO-PILOT’S SEATS - *ISRI* (OPTIONAL) ..... 18**
  - PNEUMATIC *ISRI* SEATS ..... 18
  - ELECTRIC *ISRI* SEATS ..... 18
- SAFETY BELTS ..... 19**
- STEERING WHEEL ADJUSTMENT ..... 20**
- SUNSHADES (BLINDS)..... 20**
- INSIDE MIRROR..... 20**
- ADJUSTABLE HVAC REGISTERS..... 20**
- WINDOWS ..... 20**
  - DRIVER’S POWER WINDOW ..... 20
  - FIXED WINDOWS ..... 20
  - AWNING WINDOWS ..... 20
  - SLIDING WINDOWS ..... 21

## 18 Vehicle Interior

### DRIVER'S SEAT - "DELIVERY"

The driver's "delivery" seat is standard and legal only for driving the vehicle on its initial delivery. It is a conventional van seat equipped with tracks for fore and aft adjustments.

### DRIVER'S AND CO-PILOT'S SEATS - ISRI (OPTIONAL)

Two distinct *ISRI* model driver's and co-pilot's seats may be supplied with your vehicle: both with a sophisticated air suspension system, one being pneumatically operated, while the other is electrically operated. Both seats may be equipped with lumbar supports, heated cushions and adjustable armrests. Seats can be adjusted to the desired driving position by following the instructions listed below:

#### PNEUMATIC ISRI SEATS

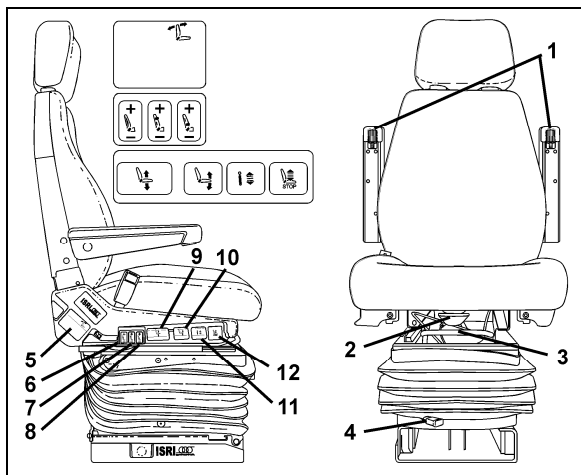

PNEUMATIC DRIVER'S SEAT

18385



### DANGER

Never try to adjust seat while driving vehicle as this could result in loss of vehicle control.

#### Armrest (1)

Rotate control knob to select desired arm-resting angle. When not in use, raise armrest parallel with backrest.

#### Seat Cushion (2)

Provides optimum comfort and support for any leg shape or size. Adjustable to 50 mm (2 inch) length.

#### Fore-and-aft (3)\*

Pull handle up and slide seat forwards or backwards to adjust distance between seat and dashboard.

#### Isolator (4)

Reduces horizontal vibration, ensuring smooth ride.

#### Backrest (5)

Lift lever to select proper adjustment angle of backrest.

#### Air Side Bolster (6)

Offers desired side support to avoid body side-way.

#### Air Lumbar (7) (8)

Provides back support with upper and lower settings, ensuring comfort during lengthy sitting.

#### Air Height Adjustment (9)

Moves seat up or down independently of other seat settings. 100 mm (4 inch) total travel.

#### Adjustable Seat Recline (10)

Allows easy adjustment of four-setting inclination.

#### Adjustable Shock Absorber (11)

Choose stiff or soft ride infinitely.

#### Quick Air Release (12)

Exhausts all air from suspension, allowing for easy entry/exit. Returns seat to previous position.

### ELECTRIC ISRI SEATS

Adjust electric seats as follows:

#### Tilt (rear) (1)

Pull switch up to raise rear section of seat. Push switch down to lower rear section of seat.

**Fore-and-aft/Up-Down (2)**

Push switch towards dashboard to move seat forwards or back to move seat backwards. Pull switch up to raise seat or push switch down to lower seat.

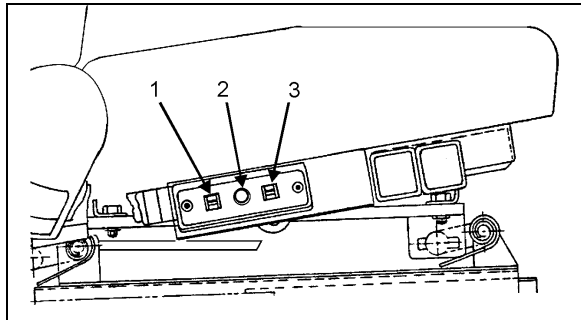

SEAT CONTROLS

18040

**Tilt (front) (3)**

Pull switch up to raise front section of seat. Push switch down to lower front section of seat.

**SAFETY BELTS**

The driver's seat is equipped with a retractable safety belt as required by State, Provincial and Federal regulations. To fasten, pull seat belt out of the retractor and insert the latch plate into the buckle until it clicks. No special adjustment is required since the reel device is self-adjusting. If seat belt operation becomes defective, report to Manufacturer's Service Center.

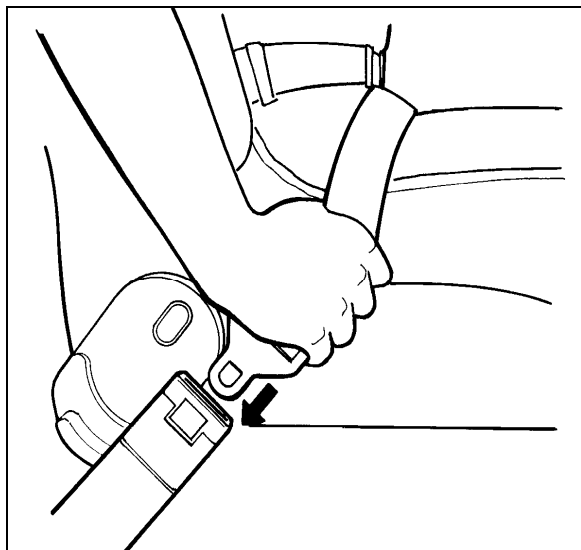

SEATBELT

18028

**NOTE**

*The safety belt must be pulled out slowly and continuously, otherwise it will lock the reel before the latch plate reaches the buckle. If this happens, allow the belt to retract completely and repeat the procedure correctly.*

**WARNING**

A snug fit with the lap belt positioned low on the hips is necessary to ensure motorist's safety. The belt should not be worn twisted. Avoid pinching belt and/or belt hardware in seat mechanism. Do not wear belt over rigid or breakable objects, such as eyeglasses, pens or keys as these may cause injuries.

**CAUTION**

Never bleach or dry clean safety belt.

To unfasten belt, press the red button in center of buckle and allow belt to retract. If the belt does not fully retract, pull it out and check for kinks or twists. Make sure that it remains untwisted as it retracts.

**DANGER**

Safety belts should always be worn by motorists using seats supplied with belts since this is required by most State and Provincial laws.

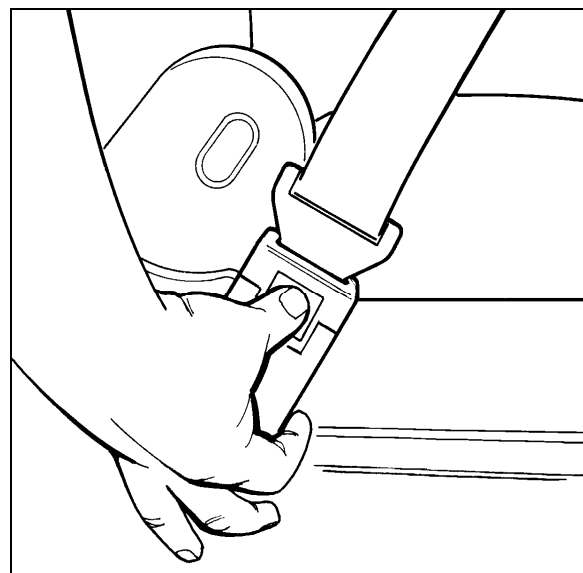

SEATBELT

18029

### STEERING WHEEL ADJUSTMENT

Push on the valve button with the left foot to unlock the steering wheel for tilt and telescopic adjustment.

 <b>DANGER</b>
Do not adjust the steering wheel while the vehicle is moving. Loss of control could result. Park the vehicle safely and apply parking brakes before adjusting the steering wheel.

### SUNSHADES (BLINDS)

This vehicle is provided with three pivoting type sun visors which are installed as standard equipment. Pivot the appropriate sun visor to the desired position. Two electrically operated sunshades may also be selected (optional) but are not factory installed.

Moreover, an optional spring release type sunshade is provided for the driver's window to protect him from side glare. To operate, pull down the shade by its hem to the appropriate position and release it. It will remain automatically in position. To lift, depress the unlocking lever.

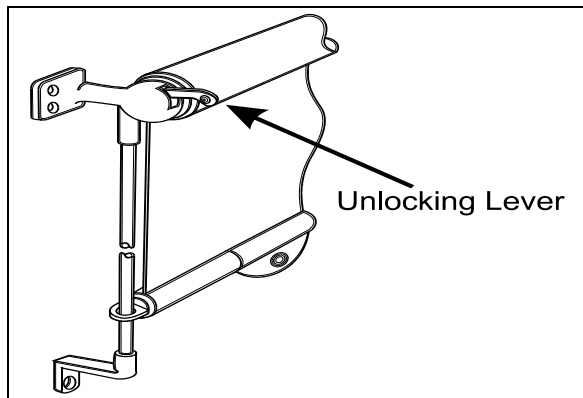

SPRING RELEASE SUNSHADE

23143

### INSIDE MIRROR

One (optional) mirror is located in the driver's area, the central mirror allows the driver to see in the central cabin aisle.

### ADJUSTABLE HVAC REGISTERS

The HVAC system has adjustable registers to control air flow. They are located on the dashboard; refer to Chapter, Controls & Instruments. The direction and volume of air flow are adjustable.

### WINDOWS

The vehicle is equipped with single pane or double pane (thermos) windows. There are two automobile-like power windows and a possible combination of three types of side windows, all of them flush-mounted to the structure: fixed, awning and sliding windows. Following is a description and operating instructions for these types of windows:

#### DRIVER'S POWER WINDOW

The driver's area is equipped with a power window on the driver's side and another power window in the entrance door. The windows are controlled by rocker switches located on the L.H. control panel. Refer to Chapter, Controls & Instruments.

#### FIXED WINDOWS

These windows are glued to the structure and form an integral part of the body of the vehicle, helping reduce vibration and noise. Fixed windows cannot be opened.

#### AWNING WINDOWS

To open or close an electrically-operated awning window, use the rocker switch button located on the wall, next to the window. After closing the window, maintain the rocker switch button depressed to latch the window.

 <b>CAUTION</b>
Avoid holding the rocker switch button depressed after the window has reached its full opened position or after the window has been latched.

 <b>CAUTION</b>
Never try to open or close the awning window by pulling or pushing directly on the window; this could damage the opening mechanism gearbox.

A telltale light on the dashboard illuminates when an awning window is opened. Refer to Controls and instruments chapter for more information.

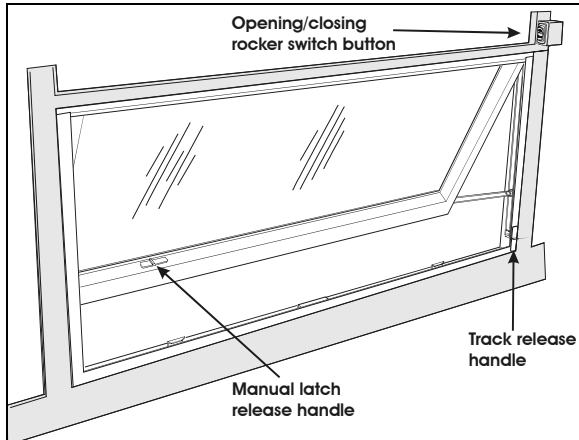

**ELECTRIC AWNING WINDOW** 18585

**NOTE**

The awning window electrical circuit is equipped with a thermistor protecting the components from overheating. If the awning window is opened and closed repeatedly, causing overheating of the components, the thermal protection will interrupt the operation of the window for a short while to permit cooling down of the components. This feature also prevents personal injuries and damages to the components if something obstructs the window movement.

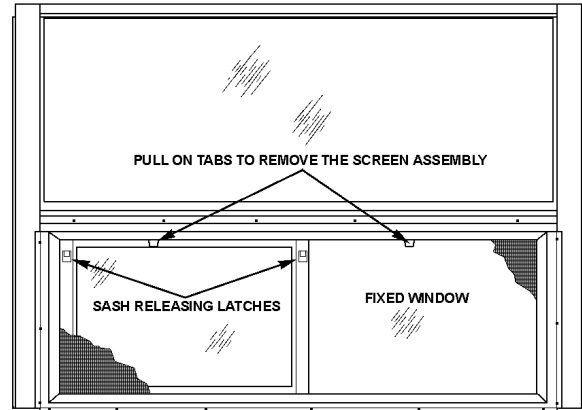

**SLIDING WINDOW** 18206

**NOTE**

The sliding window electrical circuit is equipped with a thermistor protecting the components from overheating. If the sliding window is opened and closed repeatedly, causing overheating of the components, the thermal protection will interrupt the operation of the window for a short while to permit cooling down of the components. This feature also prevents personal injuries and damages to the components if something obstructs the window movement.

**SLIDING WINDOWS**

To open or close an electrically-operated sliding window, use the rocker switch button located on the wall, next to the window.



**CAUTION**

Never try to open or close the sliding window by pulling or pushing directly on the window; this could damage the opening mechanism gearbox.

**NOTE**

If the sliding window electrical circuit is inoperative, the power sliding window can be manually closed by removing the lateral plastic trim located on the R. H. side of the window to access the drive belt. Manually move the drive belt to close the window.





<b>KEYS</b> .....	<b>26</b>
EXTERIOR COMPARTMENTS KEY .....	26
ENTRANCE DOOR KEY .....	26
FUEL FILLER DOOR KEY.....	26
<b>IGNITION SWITCH</b> .....	<b>26</b>
<b>REMOTE ENTRY TRANSMITTER</b> .....	<b>27</b>
<b>LATERAL CONTROL PANEL</b> .....	<b>28</b>
TRANSMISSION CONTROL PAD.....	28
CONTROL SWITCHES .....	28
MIRROR CONTROLS .....	29
LEVEL LOW SYSTEM.....	29
PARKING BRAKES CONTROL VALVE.....	30
TAG AXLE CONTROL VALVE .....	30
CIGARETTE LIGHTER.....	30
ASHTRAY .....	31
ACCESSORY POCKET.....	31
12-VOLT DC POWER OUTLET .....	31
TRAILER AIR SUPPLY CONTROL VALVE .....	31
AUTOMATIC FIRE DETECTION AND SUPPRESSION SYSTEM (AFSS).....	31
CRUISE CONTROL.....	31
TIRE PRESSURE MONITORING SYSTEM (TPMS).....	38
<b>DASHBOARD</b> .....	<b>42</b>
<b>CONTROL SWITCHES</b> .....	<b>43</b>
L.H. DASHBOARD PANEL.....	43
R.H. DASHBOARD PANEL .....	45
HVAC CONTROL MODULES.....	46
AIR VENTS .....	47
<b>INSTRUMENT CLUSTER</b> .....	<b>48</b>
ANALOG INDICATORS.....	49
TELLTALE LIGHTS .....	52
DRIVER INFORMATION DISPLAY .....	56
<b>STEERING COLUMN CONTROLS</b> .....	<b>65</b>
MULTI-FUNCTION LEVER.....	65
STEERING WHEEL CONTROLS.....	66
HORNS .....	67
TRANSMISSION RETARDER.....	68
<b>FOOT-OPERATED CONTROLS</b> .....	<b>68</b>

## 24 Controls and Instruments

---

SERVICE BRAKES.....	68
ACCELERATOR PEDAL.....	69
<b>ALLISON AUTOMATIC TRANSMISSION.....</b>	<b>69</b>
OPERATION.....	69
PUSH BUTTON SHIFT SELECTOR.....	69
FUNCTIONS OF THE "MODE" BUTTON.....	70
TRANSMISSION SERVICE INDICATOR.....	70
DESCRIPTION OF AVAILABLE RANGES.....	70
<b>VOLVO I-SHIFT TRANSMISSION.....</b>	<b>72</b>
PUSHBUTTON SHIFT SELECTOR.....	72
DISPLAY.....	72
ACCELERATOR PEDAL.....	73
ECONOMY AND PERFORMANCE MODE.....	73
ECO-ROLL MODE (FREEWHEEL FUNCTION).....	73
LIMP HOME MODE.....	73
STARTING AND STOPPING.....	74
STARTING THE VEHICLE UPHILL AND DOWNHILL.....	74
DRIVING.....	75
TOWING.....	76

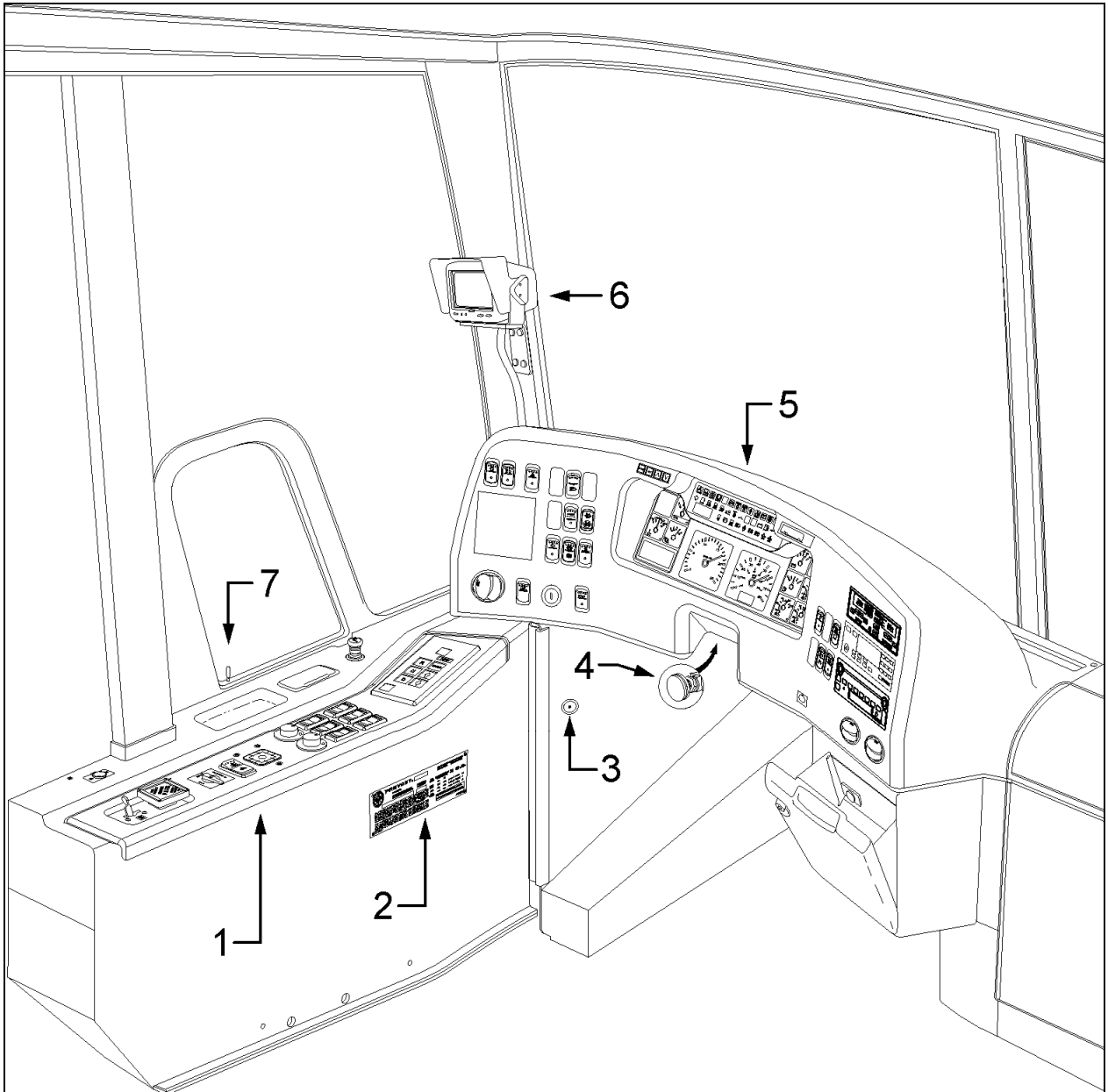

DRIVER'S AREA

18563

1. Lateral control panel
2. DOT certification plate
3. Diagnostic Data Reader (DDR) receptacle
4. Foot operated steering wheel adjustment unlock air valve
5. Dashboard
6. Rear view TV monitor (optional)
7. Front service door unlocking pull-rod

**KEYS**

Four different key models are provided with the vehicle:

**EXTERIOR COMPARTMENTS KEY**

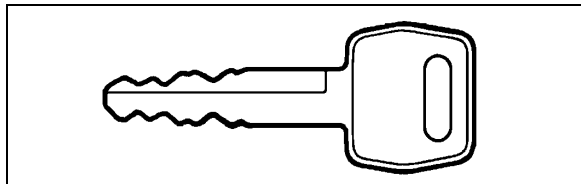

Use one of the two exterior compartment keys provided to lock or unlock any exterior compartment door, including the electrical or service compartment doors, but excluding the fuel tank filling access doors. It is also possible to lock or unlock the baggage compartments and service compartments from the inside by means of a switch located on the dashboard.

**ENTRANCE DOOR KEY**

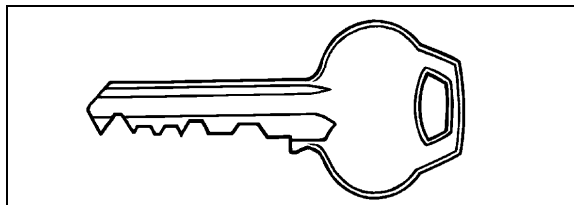

Use the entrance door key to lock or unlock the door from the outside. It is also possible to lock or unlock the entrance door using the exterior compartment door lock, the entrance door unlocking switch or using the keyless entry system.

**FUEL FILLER DOOR KEY**

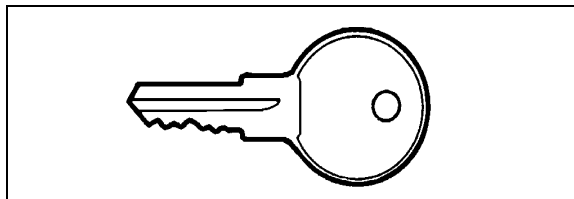

Use this key to lock or unlock the fuel filler door.

**IGNITION SWITCH**

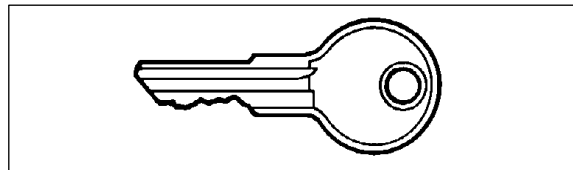
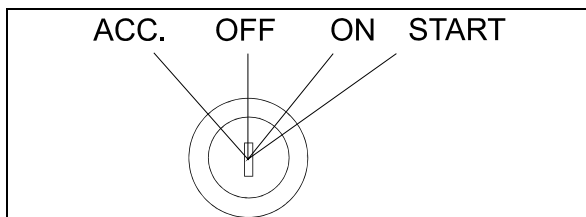

**IGNITION KEY**

23056

The ignition switch doubles as the battery master switch. Any position other than OFF activates the battery electrical circuit. The battery electrical circuit is also activated when the hazard switch is depressed.

Use the ignition key to activate the battery electrical circuit by turning it counterclockwise to the ACC position.

To start the engine, turn the key clockwise to the START position, and then release it. The key will set to ON position.



**CAUTION**

When the vehicle is parked overnight or for an extended period of time, the battery master switch (ignition switch) should be set to the OFF position.

**NOTE**

When the battery master switch (ignition switch) is set to the OFF position, all electrical supply from the batteries is cut off, with the exception of battery equalizer check module, ECM ignition and power supply, TCM power (Allison Transmission), coolant heater electronic timer, coolant heater and water recirculating pump, pro-driver, power-verter, keyless entry system and fire alarm.

**NOTE**

For your protection against theft, record the key numbers and keep this information in a safe place. Do not keep these records inside vehicle. It is also advisable to deposit a duplicate of each key in a safe place, so they can be obtained without difficulty in case of an emergency or loss.

The ignition switch is located on the lower left side of the dashboard. It has four positions:

**Off**

In the OFF position, ignition cannot take place. The key can be removed in this position.

The electrical circuits are not activated when the switch is in this position. Only the accessories connected directly to the batteries can be activated. These are: the coolant heater and water pump, the keyless entry system and anti-

theft alarm, the central locking system, entry lights electric horn and Message Center Display (MCD). Maintain the switch in this position when parked overnight or for an extended period.

**Accessories**

To operate the accessories only, turn the ignition key counterclockwise. The key cannot be removed in this position.

The battery electrical circuits are activated when the switch is in this position or when the hazard flashers are activated.

The features enabled when the key is in the ACC position are all those linked directly to the battery plus the exterior temperature display, the radio or entertainment system, exterior and interior lighting.

**On**

To place ignition switch to ON, turn the key clockwise to the first position. The key cannot be removed in this position.

The electrical circuits activated are the same than when the switch is in the ACC position plus the transmission, engine and accessories, ABS system, wipers, level low system, dashboard cluster gauges and buzzers, air horn and air dryer heater are activated when the key is in this position. Do not leave the key in this position unless the engine is running.

**Start**

Turn the key clockwise to the second position and release as soon as the engine starts. The key will return to the ON position. If the engine did not start, return the ignition key to the OFF position before trying to restart the engine.

	<p><b>CAUTION</b></p>
<p>To avoid overheating the starter, do not engage the starter for more than 15 seconds at a time. Allow the starter to cool before trying to restart the engine.</p>	

The features activated when the engine is running are all those described above plus the HVAC system and day time running lights. The optional ether cold-start system is automatically deactivated once the engine runs.

**REMOTE ENTRY TRANSMITTER**

Up to four hand held (electronic key) transmitters can control electronic door lock system.

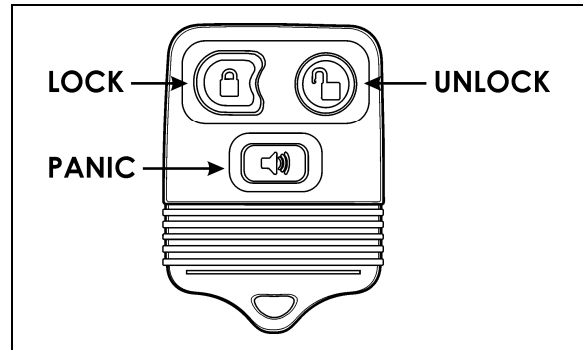

REMOTE ENTRY TRANSMITTER 23383

To lock the entrance door and the baggage compartment doors simultaneously and arm the intrusion protection and anti-theft system:

- Press LOCK  on the transmitter once.

<p><i><b>NOTE</b></i></p> <p><i>The intrusion protection and anti-theft system will be set after a 30 seconds delay.</i></p>
--

To confirm that the entrance door and baggage compartment doors have been locked and that the intrusion protection and anti-theft system is armed:

- Press LOCK  again within five seconds of the first lock. The front and rear side markers will flash once if the doors have locked. If the entrance door or one of the baggage compartment doors is open, a door ajar signal prevents arming of the system.

To unlock the entrance door:

- Press UNLOCK  on the transmitter. This will unlock the door and disarm the intrusion protection and anti-theft system.

To unlock the baggage compartment doors:

- Press UNLOCK  a second time within five seconds of the first unlock.

To set off the personal security alarm:

- Press the red PANIC  button on any transmitter. The horn will sound and the marker lights will flash for a maximum of three minutes.

To deactivate the personal security alarm:

- Press the red PANIC  button again on any transmitter or turn the ignition key ON.

<p><i><b>NOTE</b></i></p> <p><i>The remote entry features will not function when the ignition is in the ON or ACC. position.</i></p>
--

**LATERAL CONTROL PANEL**

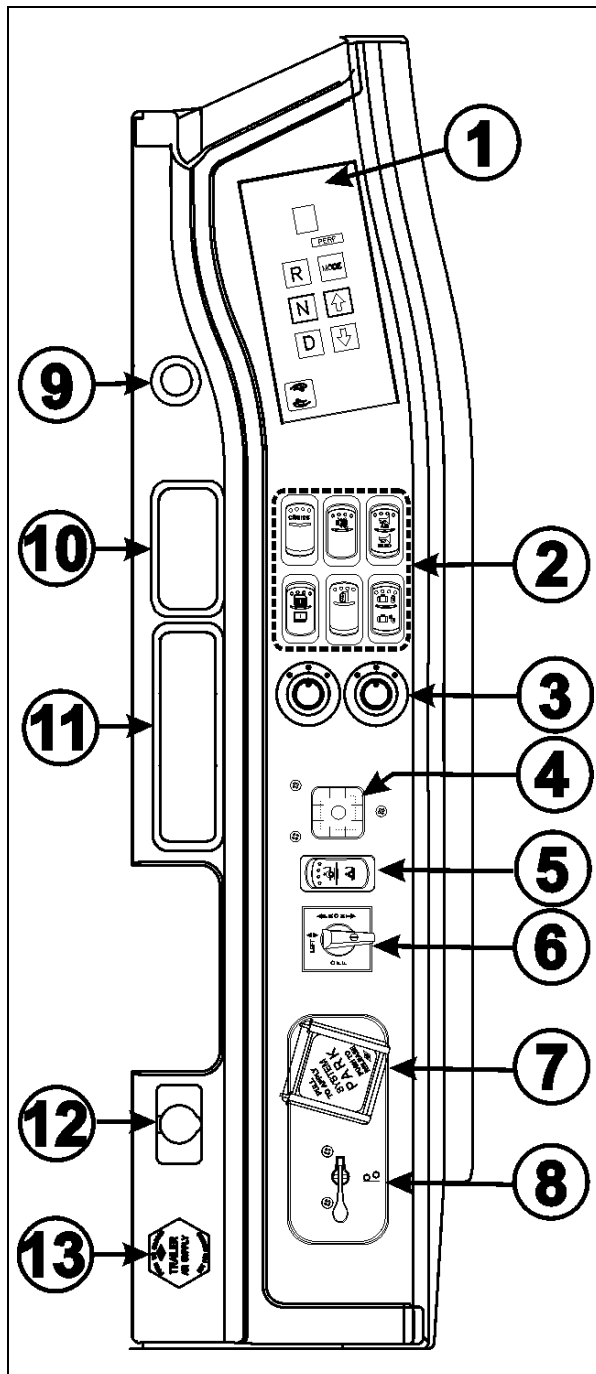

L.H. CONTROL PANEL

06643

1. Transmission Control Pad
2. Control Switches
3. Mirror Controls
4. Level Indicator
5. Height Control Switch
6. Level Low Selector Switch

7. Parking Brakes Control Valve
8. Tag Axle Control Valve
9. Cigarette Lighter (Optional)
10. Accessory Pocket or Ashtray (Optional)
11. Accessory Pocket
12. 12 Volt DC Power Outlet
13. Trailer Air Supply Control Valve (Optional)

**TRANSMISSION CONTROL PAD (1)**

The control pad for the transmission is located as shown. Refer to "Automatic Transmission" in this chapter for operating instructions and more information.

**CONTROL SWITCHES (2)**

**Cruise Control Switch**

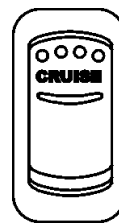

06701

For operation of the cruise control, refer to "Regular Cruise Control" or "Prevost Aware Adaptive Cruise Braking" paragraph in this chapter

**Back-up Alarm Cancel**

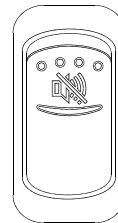

06311

Press down this switch to cancel the Back-Up Alarm

*NOTE: After use, return to normal operation.*

**Horn Selector**

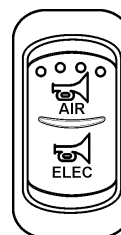

06700

Use this switch the toggle between the air horn and the electric horn when pressing the steering wheel center pad.

**Power Window Switch**

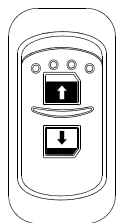

06338

Use this rocker switch to open or close the driver's power window.



**CAUTION**

Close power window when parked or leaving the coach unattended.

**Outside Rear View Mirror Heat (Optional)**

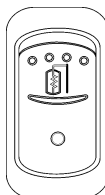

06261

Press this rocker switch to clear fog, frost or thin ice from outside mirror.

**Central Locking System**

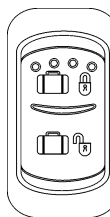

06266

This system enables locking all baggage compartment doors by pressing the switch forward. To unlock, press the switch rearward.

**NOTE**

Service compartment doors are not linked to the central locking system.

**NOTE**

Doors must be unlocked using the key first, they can then be unlocked or locked using the central locking system.

**MIRROR CONTROLS (3)**

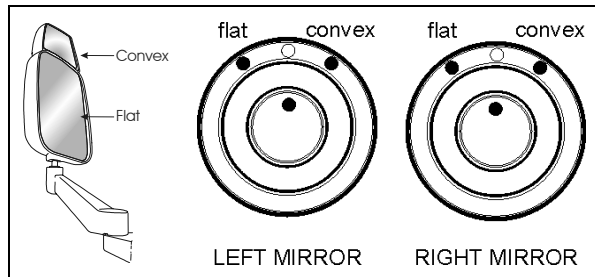

MIRROR CONTROLS

06374

Turn left pointer knob counterclockwise for outside flat mirror adjustments and to the right for convex mirror adjustments, then use the joystick control to adjust the selected mirror's viewing angle. Adjust the right outside mirror similarly but by using the right side control.

**NOTE**

If the mirror assemblies on your vehicle do not include convex mirrors, only one (1) mirror control knob will be installed for both mirrors. To operate, turn pointer knob to the left for L.H. mirror adjustments and to the right for R.H. mirror adjustments, then use the joystick control to adjust the selected mirror's viewing angle.

**LEVEL LOW SYSTEM (4, 5, 6)**

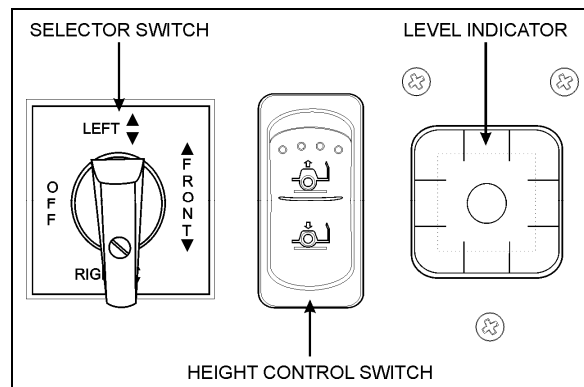

LEVEL LOW SYSTEM CONTROLS

16094

When driving, the conventional air leveling system of the vehicle controls the height at three points: the front, the left rear and the right rear. Your vehicle is equipped with a suspension system that consists of air springs (pressurized air bellows) located near each wheel. The amount of air in each air spring (and thus the vehicle height) is controlled by automatic leveling valves that operate between the chassis and the axles of the vehicle.

The three leveling valves are located as follows: one at the front which controls the amount of air in both front air springs, one at the left rear which controls the left rear corner of the vehicle and one at the right rear which controls the right rear corner of the vehicle. During normal driving, these valves work automatically to maintain the chassis at the proper level above the axles, indifferent of road conditions or vehicle weight.

**NOTE**

Prevost vehicles are designed to operate within specific weight load/ranges for each axle (GAW) and for total vehicle weight (GVW). If the coach is heavier than the design limits, Level Low System (LLS) components damage and problems can occur.

## 30 Controls and Instruments

When parked, and **ONLY** when parked, the level of the vehicle can be manually adjusted within the range of travel of the air springs. Thus, if the vehicle is parked on uneven ground, the manual override leveling system can be used to level the chassis of the vehicle. With the ignition **ON** (engine running or not), turn the selector switch located on L.H. side control panel to the area of the vehicle requiring leveling, then press the rocker switch accordingly (up or down) to inflate or deflate the selected set of air springs. The front position raises or lowers the front only and does not tilt the vehicle to its sides. Each rear position raises or lowers its respective side, therefore, the rear positions can be used to tilt the vehicle to one side or the other, or they can be used to raise or lower the rear of the vehicle. When leveling, it is often necessary to run the engine in order to get an adequate air supply.

### NOTE

*For maximum ease of ingress and egress as well as for maximum leveling range, lower the vehicle completely before leveling.*

### NOTE

*It is always better to first level the rear of the vehicle (right to left) before raising or lowering the front. After adjusting the rear, watch the level indicator as you adjust the front. If the level indicator shows that the vehicle is starting to tilt to either side, stop adjusting the front as one of the air springs has come to the end of its travel range.*

After manual leveling, turn **OFF** the engine. The vehicle will stay in the leveled position (the air is "locked" in the air springs) as long as there are no air leaks. The vehicle will hold this position for several days. When engine is restarted, with the level selector switch in the **OFF** position and air pressure is adequate, the vehicle will automatically level itself for driving conditions.



## DANGER

Do not drive the vehicle with the level low selector switch in any position other than **OFF**, as this may render the vehicle unsafe and uncontrollable. If this is the case, the Level Low warning telltale light in the dashboard will flash, reminding you that the selector is not in the **OFF** position.

### NOTE

*If, for any reason, you wish to start the engine without moving the vehicle (to warm up the engine for instance) while keeping the vehicle in the manually leveled position, place selector switch in any position except **OFF**. When ignition switch is turned to the **OFF** position, reset the selector switch to the **OFF** position.*

### PARKING BRAKES CONTROL VALVE (7)

Spring-loaded parking brakes are applied by pulling up the control valve knob and protector assembly. Lift the safety cover and push down to release brakes. Refer to "Emergency and Parking Brakes" in "Chapter: Emergency Features and Safety Equipment".

### TAG AXLE CONTROL VALVE (8)

Lift the tag axle by pushing the lever forward. Pulling the lever back will lower the tag axle. Refer to "Other Features" chapter for additional information.

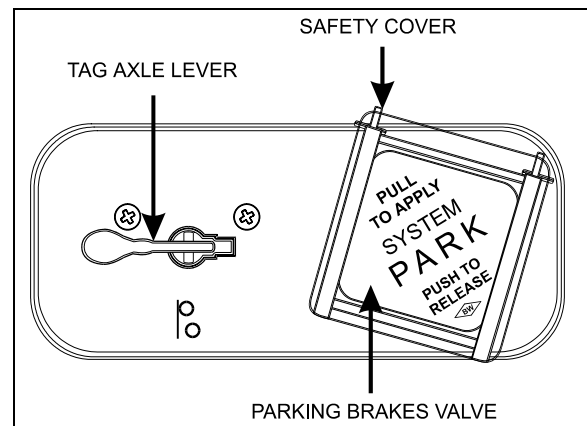

CONTROL VALVES

12177

### CIGARETTE LIGHTER (9)

Push lighter in to activate. When ready to use, it will spring out automatically. Replace lighter in non-activated position. The cigarette lighter socket can be used to power 12-volt appliances (e.g. flashlight, vacuum cleaner). The maximum power consumption allowed for appliances plugged in this socket is 130 watts. Make sure the appliances are equipped with suitable plugs that will not damage the socket.

### NOTE

*The cigarette lighter can still be used after the ignition key has been removed.*



**ASHTRAY (10)**

If no astray is installed, the space becomes an accessory pocket.

To open the ashtray, push slightly on the cover's side. The ashtray can be removed for cleaning by pulling it out.

 <p><b>WARNING</b></p>
<p>To prevent a fire, never put paper or plastic wrappers in the ashtray. Empty ashtray often.</p>

**ACCESSORY POCKET (11)**

To open the compartment, lift the cover.

**12-VOLT DC POWER OUTLET (12)**

This socket can be used to power small 12 volt DC appliances such as a cellular phone or a vacuum cleaner. The maximum power consumption allowed for appliances plugged in this socket is 130 watts. Make sure appliances are equipped with suitable plugs that will not damage the socket.

**TRAILER AIR SUPPLY CONTROL VALVE (OPTION) (13)**

The trailer air braking system is supplied by pushing this control valve.

**Diagnostic Data Reader (DDR) Receptacle**

To facilitate troubleshooting of the DDEC, Allison Transmission and ABS systems and to obtain data logged in the ECM (Electronic Control Module) memory, a Diagnostic Data Reader (DDR) (not supplied) can be connected through the DDR receptacle. A user's manual is supplied with the optional DDR.

The DDR receptacle is located inside the footwell, on the upper left side wall.

**AUTOMATIC FIRE DETECTION AND SUPPRESSION SYSTEM (AFSS)**

**Protection Panel**

The protection panel displays the current system status. The protection panel contains "SYSTEM OK", fire "ALARM" and "TROUBLE" lamps, the audio alarm, the "TEST/RESET" switch, and the "ALARM SILENCE" switch.

The "SYSTEM OK" lamp indicates power is on the system and that there are no trouble conditions present. The "TROUBLE" lamp blinks

if there is a fault in the detection circuitry and illuminates solid if there is a fault in the extinguishing circuitry. When the "TROUBLE" lamp is on, the "SYSTEM OK" lamp will be off and the audible alarm will sound intermittently. The "SYSTEM OK" lamp will flash when the system is low on battery power. Depressing the "TEST/RESET" switch tests the protection panel lamps and audio alarm. The "ALARM SILENCE" switch will disable the audio alarm.

When a fire detector automatically detects a fire, the fire "ALARM" lamp and audio alarm activate. When the Manual Activation Switch is activated, the fire "ALARM" lamp blinks and the audio alarm activates. The lamp will remain blinking until power is cycled to the system.

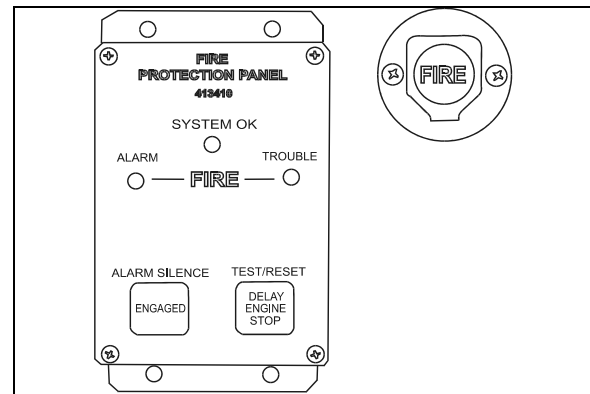

**AFSS PROTECTION PANEL & MANUAL ACTIVATION SWITCH**

**Manual Activation Switch**

The manual activation switch allows immediate system activation (extinguisher discharge and engine shutdown) by the operator at any time. Activation of the switch is accomplished by twisting and pulling the tamper seal to remove, lifting the cover and pressing the red "FIRE" button for more than half a second. After the manual activation switch has been activated, the protection panel will blink the fire "ALARM" indicator until power has been cycled to the system.

Refer to chapter "SAFETY FEATURES AND EQUIPMENT" for more information on *Kidde Dual Spectrum* Automatic Fire detection and Suppression System (AFSS).

**CRUISE CONTROL**

**Regular Cruise Control**

The cruise control allows you to cruise the vehicle at a desired speed over 18 mph (30

## 32 Controls and Instruments

km/h) without having to use the accelerator pedal.

### Turning the system on

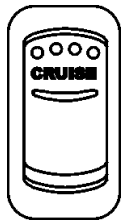

06701

To operate the cruise control, press the **cruise** rocker switch located on the lateral control panel to the on position. This turns the system on. The dashboard telltale turns on; you can now set the vehicle at a desired cruising speed. To turn off the system, press the rocker switch to the off position.

#### **NOTE**

The **cruise** switch and **resume** button do not operate at speeds below 30 mph (50 km/h).

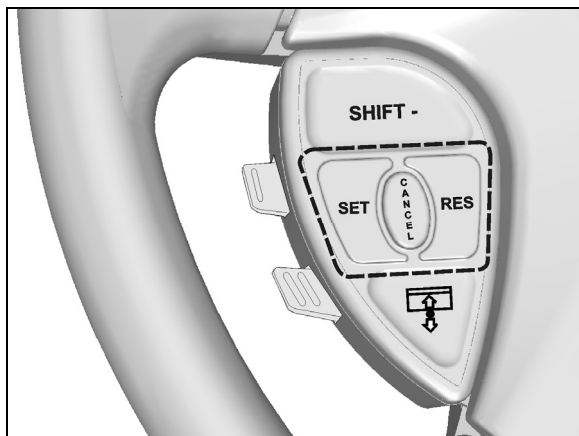

CRUISE CONTROL BUTTONS

### Setting at a desired speed

Accelerate the vehicle to the desired cruising speed using the accelerator pedal. Press and release the **SET** button then remove foot from the accelerator pedal. This will set the vehicle cruise speed and store it in memory. The set speed will appear in the driver information display.

#### Increasing set speed

The vehicle cruise speed setting can be increased by one of the following methods.

1. Accelerate using the accelerator pedal until the desired cruising speed is reached. Press and release the **SET** button.

or

2. Press and hold the **RES** (RESUME) button until the desired cruising speed is reached. When the **RES** button is released, the new cruising speed will be stored in the cruise control memory.

or

3. When driving with cruise control, each time the **RES** button is momentarily depressed, the cruising set speed is raised by 1 mph (2 km/h).

#### **NOTE**

When driving with cruise control, the vehicle can still be accelerated by depressing the accelerator pedal in the usual manner. Once the accelerator pedal is released, the vehicle will return to the previously set cruising speed.

### Decreasing set speed

The vehicle cruise speed setting can be decreased by one of the following methods.

1. Press and hold the **SET** button until the desired cruising speed is reached. When the **SET** button is released, the new cruising speed will be stored in the cruise control memory.

or

2. Each brief pressing of the **SET** button will decrease set cruising speed by 1 mph (2 km/h).

or

3. Slightly apply the service brake and when desired cruise speed is reached, press and release the **SET** button.

### Canceling the preset speed

You can cancel the preset cruising speed by:

1. Pressing momentarily the **CANCEL** button;
2. Depressing the brake pedal.

### Resuming Set Speed

If the preset speed is cancelled by pressing the **CANCEL** button or depressing the brake pedal, pressing the **RES** (RESUME) button will restore the speed set prior to cancellation, providing that your speed is above 30 mph (50 km/h).

#### **NOTE**

When driving downhill with the cruise control on and set, the engine brake or the transmission retarder engage automatically (if previously activated) when the selected cruise speed is exceeded by approximately:

- 4 mph (7 km/h) with the engine brake activated;
- 0.6 mph (1 km/h) with the transmission retarder activated.
- The engine brake or the transmission retarder is then disengaged when speed has returned near to selected cruise speed.
- The engine brake will provide low braking power or high braking power depending on which of the two steering wheel engine brake control buttons is activated;
- ① = engine brake low
- ② = engine brake high
- The transmission retarder maximum braking level is determined by the retarder hand lever position on the steering wheel.

**NOTE**  
To avoid sudden vehicle hesitation, slightly depress the accelerator pedal before disengaging the cruise control.

**NOTE**  
When the **cruise** rocker switch is released, the cruise control is completely shut off and the cruise speed setting is erased from the cruise control memory.

**IMPORTANT NOTE**  
If the engine was stopped and the cruise rocker switch was in the on position, the rocker switch must be reset by turning it off then on again in order for the cruise control to be reactivated.

 **WARNING**  
Do not use the cruise control when driving speed must be constantly adjusted, such as in heavy traffic or on winding, icy, snow-covered or slippery roads, or on gravel roads.

 **WARNING**  
Do not put the transmission in the neutral (n) position while driving with cruise control. This may cause the engine to over-speed and result in a loss of driving control.

**Prevost AWARE • Adaptive Cruise Braking**

Prevost AWARE Adaptive Cruise Braking (ACB) is an optional cruise control that not only maintains the set speed, but will also intervene, as needed, to help the driver maintain a set following distance behind the forward vehicle by reducing speed as necessary. As soon as the forward vehicle is at a safe distance, the coach will accelerate back to the cruise set speed.

**NOTE**  
The following paragraphs briefly sum up the information concerning the operation and function of the ACB. Before driving the vehicle, be certain that you have read and that you fully understand each and every step of the driving and handling information found in Bendix Wingman ACB Active Cruise with Braking Operator's Manual. The driver should fully understand all the audible alerts and visual indicators that the system provides. Bendix Wingman ACB Active Cruise with Braking Operator's Manual (available on Prevost web site and included on the Technical Publications CD) will assist in explaining what each of them means and what actions the driver may be required to take to avoid potential collisions.

 **WARNING**  
Even with ACB, the driver must remain alert, react appropriately and in a timely manner, and use good driving practices. Ultimate responsibility for the safe operation of the vehicle remains with the driver at all times.  
Be certain that you have read all safety warnings found in Bendix Wingman ACB Active Cruise with Braking Operator's Manual.

The driver will benefit all the audible and visual warnings that the system provides whether or not ACB is turned on. In addition to the audible and visual warnings, when the ACB is turned on and a cruise speed is set, the driver benefits from active interventions like engine throttle reduction, retarder or engine brake application and service brakes application to help maintain a set following distance.



### WARNING

Adaptive Cruise Braking must be used only in the same conditions that are normally recommended for ordinary cruise control. Refer to "Regular Cruise Control" paragraph.

#### Turning the ACB system on

Activation of the adaptive cruise braking is similar to the regular cruise control activation. Press the CRUISE rocker switch to the ON position, accelerate the vehicle to the desired cruising speed and then, press the SET button. ACB is now engaged with the set following distance and driver warnings features. Whenever the cruise control is engaged, the ACB is also engaged. You cannot engage the cruise control without also using the ACB features.

#### Turning off the ACB system

You can turn off the ACB system, simply by applying service brakes, setting the CRUISE rocker switch to the OFF position or pressing the cruise control CANCEL button on the steering wheel.

#### NOTE

*Whenever the service brakes are applied by intervention of the ACB or by the driver, normal cruise will automatically be cancelled. The driver must resume or set the cruise mode in order for the vehicle to throttle up.*

#### Maintaining a set following distance

Using a radar sensor mounted to the front bumper, the ACB system measures the distance between the coach and the forward vehicle and intervenes to help maintain a safe set following distance behind the vehicle. This feature engages automatically once the driver turns on and sets cruise speed.

Following distance refers to the time gap, measured in seconds, between the coach and the vehicle ahead. The actual physical distance between the coach and the vehicle ahead will vary based on your set cruise speed; although the set time gap remains the same for all set cruise speeds. Prevost's default set time gap is 1.7 seconds.

With cruise control engaged and a cruise speed set, you are maintaining a set following distance between the coach and the forward vehicle:

- **If the vehicle in front of the coach slows down** below your cruise control set speed, the system will progressively intervene as follows, in this order:
  - 1) reduce the engine throttle;
  - 2) apply the engine brake or transmission retarder;
  - 3) apply about 30% of the service brakes available braking power in an attempt to maintain the set following distance.

The driver must apply additional braking power when required, to avoid collision or to maintain a safe distance from the vehicle ahead.

#### NOTE

*If the ACB is actively decelerating or braking the coach in an attempt to maintain the set following distance at the moment when the driver cancels the ACB system, the ACB system will continue deceleration or braking intervention until a safe following distance is established, then will cancel.*

*Even though the cruise control doesn't operate at speeds below 30 mph (50 km/h), the ACB system will continue deceleration or braking intervention in an attempt to maintain the set following distance if the coach speed reduces to less than 30 mph (50 km/h).*

- **If the vehicle ahead slows below your cruise control's set speed**, but then accelerates away, and the ACB system did not need to use the service brakes as it managed the intervention, the coach will automatically accelerate back to the original cruise control set speed, and again maintain a set following distance behind the forward vehicle.

#### NOTE

*The maximum radar range is approximately 500 feet (150 meters). Rain, snow, fog, ice and other severe weather conditions may affect the performance of the ACB system and shorten radar range.*

**NOTE**

As part of your pre-trip vehicle inspection, check to see that there is no mud, snow, ice build-up or other obstruction in front of the radar sensor. You should inspect the radar sensor mounting and remove any obstruction that may impair the sensor functioning.

**Driver warnings**

Before using the ACB, the driver should fully understand all the audible and visual warnings that the system provides. Any audible warning (beeping or tone) means that your vehicle is too close from the vehicle ahead.

**DASHBOARD TELLTALE**

When ACB is turned on and a cruise speed is set, if the forward vehicle is detected (in range) by the radar, the FORWARD VEHICLE DETECTED telltale light on the dashboard will illuminate. This is an indication to the driver that the forward vehicle is being tracked, that the ACB is actively managing the distance between the coach and the vehicle ahead and that the ACB system may automatically intervene to maintain the set following distance.



**FORWARD VEHICLE DETECTED telltale light**

There are three types of warnings with this telltale light:

- Green: The forward vehicle is detected (in range).
- Flashing red: Collision alert. The forward vehicle is too close to follow safely or a metallic stationary object such as a stopped or stalled vehicle in your lane of travel is detected. The driver must intervene to avoid a collision.
- Solid red: ACB system malfunction. The ACB system and the alert functions are not available.

**SPEEDOMETER LEDs**

With the cruise control engaged and a cruise speed set, a green LED illuminates above the cruise control set speed on the speedometer.

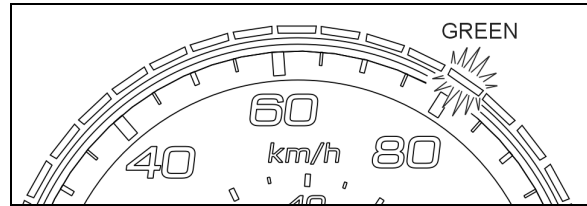

THE CRUISE SET SPEED IS 80 km/h

With a cruise speed set, the vehicle ahead slows moderately. The system will display to the driver the approximate speed of the vehicle ahead with yellow LEDs above the speedometer.

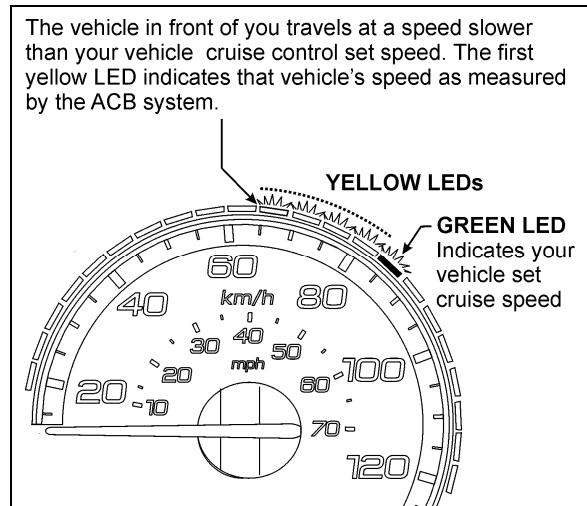

EXAMPLE OF THE SPEEDOMETER LED DISPLAY WHEN THE FORWARD VEHICLE IS SLOWER WHILE THE COACH TRAVELS WITH THE ACB CRUISE CONTROL ON AND SET

06729\_3

**FOLLOWING DISTANCE ALERT (FDA)**

Following Distance Alert provides both audible and visual warnings whenever the distance between the coach and the forward vehicle is less than the set distance and getting closer. Once the audible warning is given, the driver must increase the distance between the coach and the vehicle ahead until the audible warning stops or maneuver clear of the forward vehicle.

**WARNING**

Following Distance Alert is always active whenever the coach is moving to a speed greater than 37 mph (60 km/h), whether or not ACB is turned on. Active interventions of ACB to maintain safe following distance (throttle reduction, engine brake/retarder application, service brakes application) are only operational when the ACB is engaged with a cruise speed set.

## 36 Controls and Instruments

---

### IMPACT ALERT

The Impact Alert warning is the most severe warning issued by the ACB system. This alert indicates that the driver must take immediate evasive action by applying more braking power and/or steering clear of the vehicle ahead to avoid a potential collision.

The Impact Alert is also applicable to stationary metallic objects such as stopped or stalled vehicles. This alert provides a warning given up to 3.0 seconds before a potential collision with a stationary metallic object in the coach's lane of travel. The driver can either slow down or maneuver in an attempt to avoid the object. The Impact Alert will only warn and will not actively decelerate or brake the coach when approaching stationary objects.



 <b>WARNING</b>
Impact Alerts are always operational when the vehicle is running, whether or not ACB is turned on. Active interventions of ACB to maintain safe following distance (throttle reduction, engine brake/retarder application, service brakes application) are only operational when the ACB is engaged with a cruise speed set.

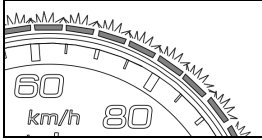
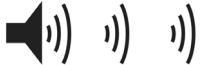

### BRAKE OVERUSE WARNING

ACB provides a warning when the system is intervening and using the service brakes excessively. Overuse of the foundation brakes can lead to the brakes overheating and a potential loss of braking performance from brake fade. For example, the use of ACB on downhill runs may cause this alert to be activated. It is recommended that ACB be disengaged on downhill grades. The driver should use appropriate gearing and brake techniques, and not rely on ACB, on downhill grades.

If the driver does not respond to the Brake Overuse Warning after a brief delay, the ACB will switch off.

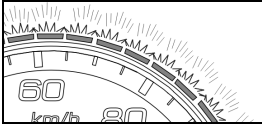
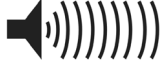
FOLLOWING DISTANCE ALERT	
CONDITION	The Following Distance Alert feature is only available when the coach speed is greater than 37 mph (60 km/h), whether or not ACB is engaged.
	The forward vehicle is slowing down and the distance between your vehicle the coach and the forward vehicle is less than the set distance
ACTIONS BY ACB SYSTEM	<p>"Distance Alert" pop-up message appears on the DID</p> <div style="text-align: right;">  </div> <p>The speedometer LEDs illuminate in <b>red</b></p> <div style="text-align: right;">  </div> <p>If the vehicles remain to close from each other for more than 15 seconds, an audible warning will sound (<b>beeping</b>)</p> <div style="text-align: right;">  </div>

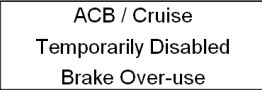
IMPACT ALERT	
SITUATION	ACB system detects a risk of collision with forward moving vehicle or a stationary metallic object in your lane of travel.
ACTIONS BY ACB SYSTEM	<p>On the dashboard, the Forward Vehicle Detected telltale <b>flashes</b> in <b>red</b></p> <div style="text-align: right;">  </div> <p>"Impact Alert" pop-up message appears on the DID</p> <div style="text-align: right;">  </div> <p>The speedometer LEDs <b>flash</b> in <b>red</b></p> <div style="text-align: right;">  </div> <p>An audible warning will sound (<b>continuous modulating tone</b>)</p> <div style="text-align: right;">  </div>

BRAKE OVERUSE WARNING	
SITUATION	ACB system is using the service brakes excessively to maintain the set following distance (for example, the use of ACB on long, steep downhill runs). Excessive application of the service brakes can cause the brakes to overheat resulting in increasing stopping distances.
ACTIONS BY ACB SYSTEM	<p>After a brief delay, the ACB system will stop functioning and be disabled.</p> <p>On the dashboard, the Forward Vehicle Detected telltale <b>illuminates</b> in <b>red</b></p> <div style="text-align: right;">  </div> <p>"ACB/Cruise Temporarily Disabled Brake Over-use" pop-up message appears on the DID</p> <div style="text-align: right;">  </div> <p>"ACB Not Available" pictogram appears on the DID status line</p> <div style="text-align: right;">  </div>

## 38 Controls and Instruments

### SELF-DIAGNOSTIC AT START-UP

Initiate the self-diagnostic as follows:

- The engine must be running since at least 15 seconds with parking brake applied.
- Trip the CRUISE rocker switch located on the lateral control panel from OFF to ON position.

The following sequence will begin:

1. Pop-up message “Impact Alert” will show in the DID;
2. The speedometer LEDs will flash in red;
3. FORWARD VEHICLE DETECTED telltale will flash in red;
4. The Impact Alert audible alarm will sound.

At the end of the self-diagnostic sequence, pop-up message « ACB SELF CHECK OK » will show on the DID if the system functions properly or « ACB SELF CHECK NOT OK » if a fault condition is detected.

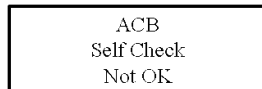
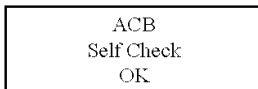

### SYSTEM MALFUNCTION

In case of system malfunction, visual warnings will illuminate in the instrument cluster or the driver information display to warn the driver that the ACB is disabled. In that situation, the Impact Alert and Distance Alert functions are not available.

If the ACB is not available, the FORWARD VEHICLE DETECTED telltale light will illuminate in red and will stay on and “ACB NOT AVAILABLE” pictogram will appear on the DID status line.



FORWARD VEHICLE DETECTED telltale light



ACB NOT AVAILABLE pictogram

For proper functioning of the system, the radar must be perfectly aligned and not blocked. If a radar fault condition is detected, one of the following pop-up messages will show in the DID.

### ACB RADAR MISALIGNMENT

### ACB RADAR FAULT

### ACB RADAR DATA LINK FAILURE

### ACB RADAR BLOCKED

### TIRE PRESSURE MONITORING SYSTEM (TPMS)

This system is a sensing device designed to identify and display tire operating data and activate an alert or warning when pressure or temperature irregularities are detected.

#### NOTE

*It is the responsibility of the driver to react promptly and with discretion to alerts and warnings. Abnormal tire inflation pressures should be corrected at the earliest opportunity.*

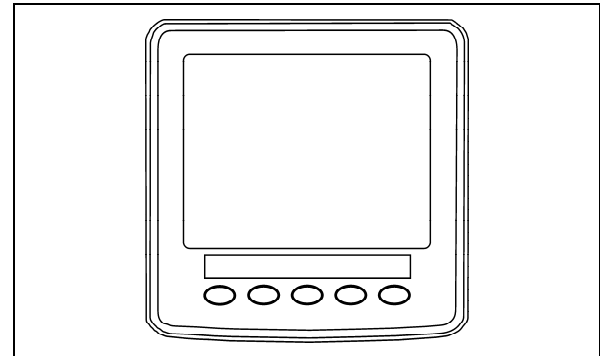

TPMS DISPLAY

### TPMS Display

The TPMS display knows where the sensors are located. It receives the raw temperature and pressure readings from the TPMS receiver, it reads several signals from the vehicle and does the calculation required to generate the various screens.

When no readings have been received for a tire location or when the received data correspond to a parameter range defined as unavailable, then the reading is considered as not available and appears as two dash lines “\_ \_”.

The TPMS display is initially configured to define how many axles and running tires are present on the vehicle. For current Prevost vehicle models, there are two axle / tire configurations. These configurations are:

**Config 1:** Axle 1 (Front) Two tires, Axle 2 (Drive) 4 tires, Axle 3 (Tag) 2 tires.

**Config 2:** Axle 1 (Front) Two tires, Axle 2 (Drive) 2 tires (super Singles), Axle 3 (Tag) 2 tires.



The TPMS display is also configured with several other parameters, including threshold levels for the alarms.

The TPMS display power supply turns OFF when the ignition key is switched OFF.

**Operation**

The system will monitor all vehicle tires (6 or 8) plus the spare tire when a spare is supplied.

**NOTE**  
Some vehicle models do not come with a spare tire.

There are two configurations of vehicle tires to be supported. One configuration (the most common) consists of 8 tires total: two tires on the front axle, 4 tires on the drive axle and 2 tires on tag axle. All screen figures shown in this document relates to this vehicle configuration. The second tire configuration consist of 6 tires total: 2 tires on the front axle, 2 tires on the drive axle (super single tires) and 2 tires on the tag axle. The vehicle tire configuration is selected with a parameter (Refer to chapter « SAFETY FEATURES AND EQUIPMENT » for more information). When the display is configured for 6 tires, the drive axle tires appears as one large tire on both side instead of twin tires as illustrated in this document and there is one reading appearing on each side instead of two as illustrated in this document.

**Start-up**

When turning the ignition switch to ON, the screen shown below appears on the TPMS Display. Dash lines are displayed meaning that no pressure data have been received by the display.

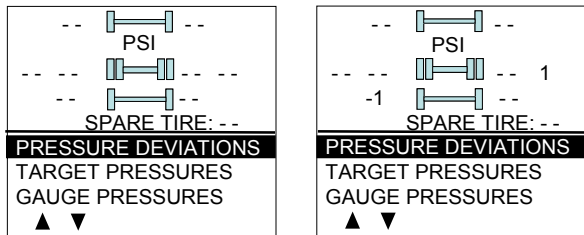

As illustrated, the pressure readings will appear replacing the dash lines as the TPMS display starts to receive pressure data from the TPMS receiver. It can take 1 minute to get all pressure readings updated since the sensors transmit at a one minute interval.

The user can flip through the menus.

**Pre-Trip Check**

When one of the preconditions defined to start the pre-trip check is met, the TPMS display enters into a pre-trip check routine and the screen shown below appears. The preconditions to initiate the pre-trip are: Park brake removed Or No activity on the display menu keys for a defined time (Key pressed timeout). After a pre-trip, the display is in a “drive” mode with bottom menu replaced by the alarm status. The display remains in this mode until one of the following occurs: A menu key is touched while the park brake is applied, or the park brake does a transition from released to park brake applied.

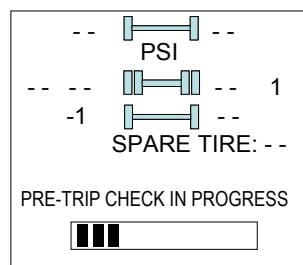

During the pre-trip check, the pressure readings for the different wheels become all available.

The pre-trip check ends, either when the pressure readings have been received for all running wheels or the pre-trip check maximum time has elapsed. It was selected to provide sufficient time for all wheel sensors to wake-up and send a first reading.

The pre-trip check is aborted and the bottom menu reappears if the park brake was active and the user press one of the menu keys.

Upon completion of the pre-trip check, the TPMS display will come up with one of the screens shown hereafter:

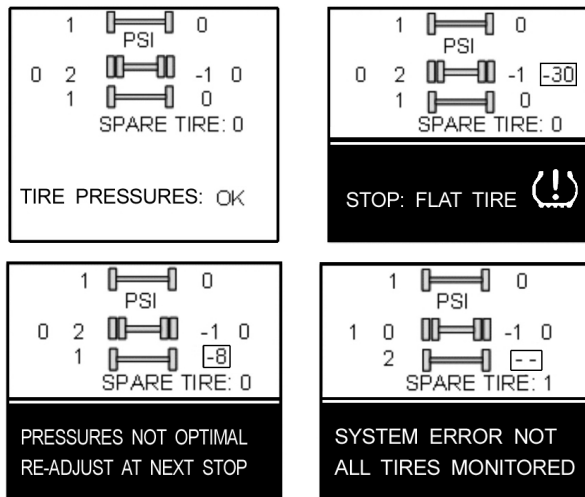

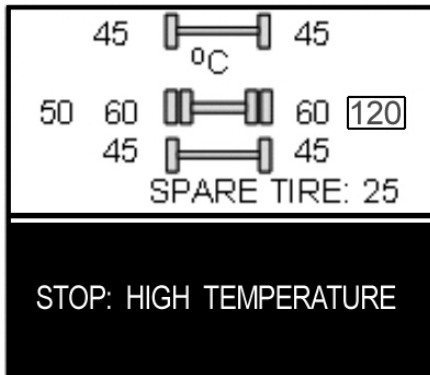

A rectangle around each pressure / temperature reading of the tires that have an issue is blinking to draw the attention to the defective tires.

In the case of multiple errors at the same time, the highest priority error is displayed at the bottom. “Flat Tire” has the highest priority followed by “High Temperature”, “Not all tires monitored” and “Tire pressure not Optimal”.

To get the driver’s attention to the alarms, the bottom section of the screen where the alarm message appears will blink to reverse contrast at the following rate: 0.7 sec normal contrast, 0.3 sec reverse contrast. Pressing any key will acknowledge the alarms that are considered as non critical and stop the blinking of these alarms message for the remaining of the trip. The non critical alarms are: “Pressure not optimal” and “Not all tires monitored”. The “flat tires” and “high temperature” alarms are critical and will keep blinking even when a key is pressed. If a different alarm occurs, blinking will start again. The blinking rectangle around the pressure/temperature readings is not impacted by the acknowledgement and keeps blinking until the error condition disappears.

The spare tire does not contribute to alarms and so never blinks.

On the road, the TPMS display shows one of the 5 previous screens.

In the event of a temperature alarm, the display switches automatically to temperature readings.

The driver can also press any of the menu keys to momentarily switch the display to temperature readings. In this case, the temperature reading appears for 15 seconds and the display returns to pressure.

The switching to temperature by pressing a key does not take place if there is an acknowledgeable alarm active, since in this case pressing the key does acknowledge the alarm.

The switching to temperature does not take place either if there is an alarm of Temperature or Flat Tire.

The switching to temperature works when the bottom message indicates either: Tire Pressure OK, Pressure Not Optimal non flashing or not all tires monitored non flashing. When the switch is done to temperature readings, the bottom portion of the screen is not affected and still shows the status message.

**NOTE**

*High temperature is not likely to occur during the pre-trip.*

The pressure and temperature readings are continuously updated with the displayed readings of the wheel having issues blinking. The bottom line message is automatically updated to the highest priority alarm prevailing. There is a hysteresis on the alarm levels to assure that the error conditions do not flicker ON and OFF.

On the occurrence of an alarm, a beep will sound. The alarm beep could be turned OFF in the alarm settings menu.

**Spare tire:**

The spare tire is monitored but it is not taken into account when setting the bottom alarm messages. This is to prevent unnecessary alarms that would otherwise occur, if for example, the spare tire is removed from a vehicle.

The user will have the possibility to check the pressure of the spare tire by accessing the TPMS display menu. For vehicles that have no spare tires, the title “spare tire” will still appear on the screens but the pressure will remain with two dash lines at all time.

**Post Trip Operation**

When parking the vehicle (park brake applied), the TPMS display keep the drive mode display active. The driver can press any keys to get the bottom lines showing the status information replaced with the menus.

The pressure readings are still displayed and updated as new readings are received and the readings are blinking if not within the optimum pressure range.

From this point the user can scroll through the menus to get more detailed information and

inflate / deflate the tires to bring them back to their optimum target pressures. Scrolling through these menus is also available prior to departure.

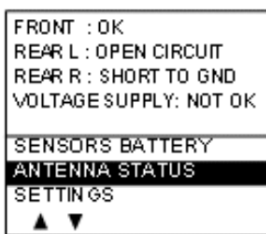
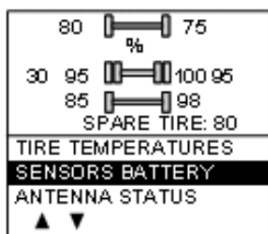
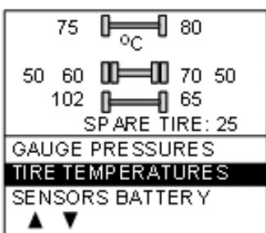
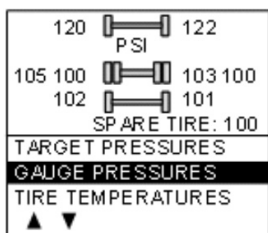
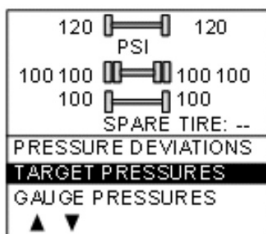
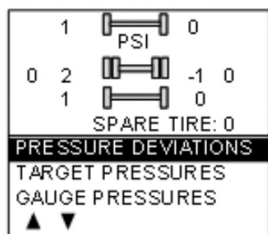

The display remains in this mode with the menus appearing at the bottom until the pre-trip check sequence starts again.

Scrolling down below the Battery life menu will show the Settings menu. Highlighting the Settings and pressing OK allows entering the settings menu. Refer to chapter "SAFETY FEATURES AND EQUIPMENT" for more information on "SETTINGS MENU".

Refer to "Appendix G" for TPMS Troubleshooting Guide.

Highlighting the Exit menu and pressing OK exits the settings and comes back to the pressure display mode.



**DASHBOARD**

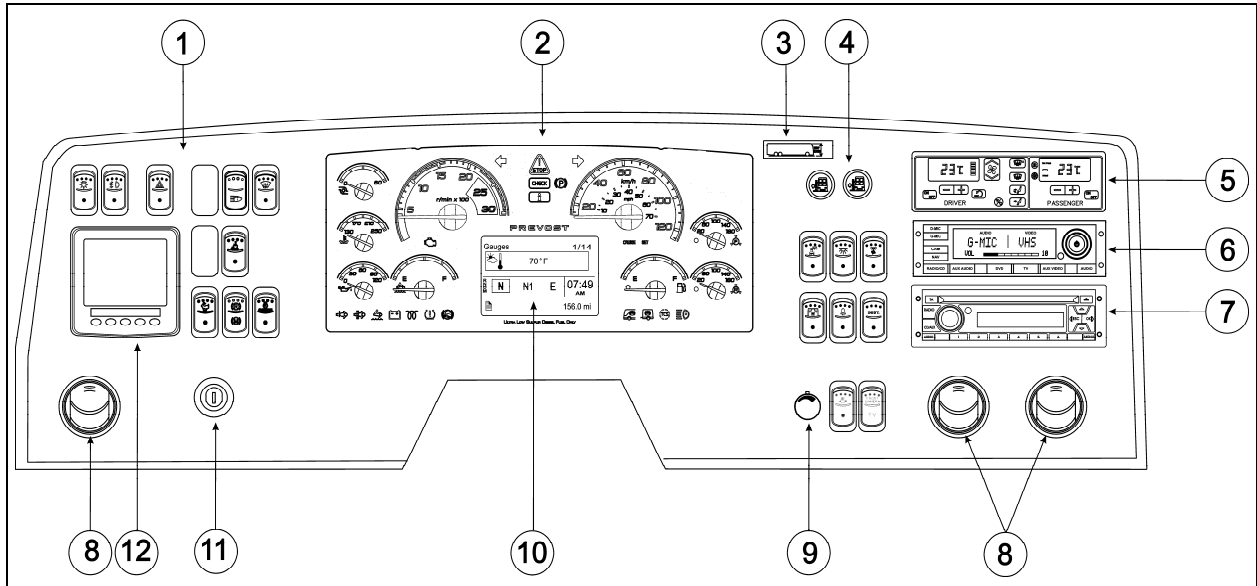

**DASHBOARD**

1. **L. H. Dashboard Panel**
2. **Instrument Cluster**
3. **Vehicle Clearance Information**
4. **R. H. Dashboard Panel**
5. **HVAC Control Unit**
6. **Audio-video Selector Panel VSS-05**
7. **AM/FM CD Radio**
8. **Air Vents**
9. **Brightness Control**
10. **Diver Information Display (DID)**
11. **Ignition Switch**
12. **Tire Pressure Monitoring System (TPMS) Display**

## CONTROL SWITCHES

High quality laser-engraved switches are used to control many of the features of the vehicle. Many switches have an embedded witness LED to inform the driver at a glance which features are active. Some switches' LED will turn *OFF* after a short while when the engine is running. This is normal and is designed to reduce glare when driving. The functions still operate even if the LED is *OFF*. If the switches are still *ON* when the engine is turned *OFF*, the LEDs will illuminate to warn the driver to turn them *OFF*. Switches are described in the order they appear, from left to right, top to bottom.

### L.H. DASHBOARD PANEL

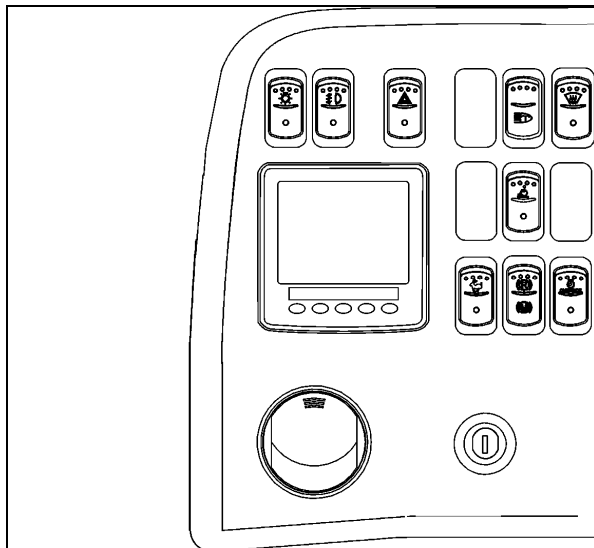

L.H. DASHBOARD PANEL 06762

The dashboard is designed with driver-exclusive controls at the left side and controls shareable with travel companions at the right side.

### Headlights

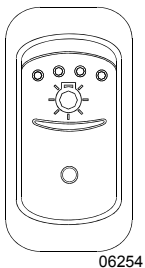

Push down rocker switch to the first position to activate clearance, tail and marker lights. Push down fully to turn *ON* both the clearance and marker lights and the headlights. The controls and instrument lights will illuminate.

#### NOTE

Daytime running lights will be automatically cancelled when the exterior lighting switch is fully depressed.

### Fog Lights

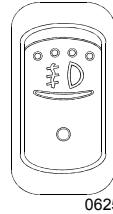

Optional halogen fog lights provide better visibility in fog and precipitation. They improve close range visibility and provide added safety. Remove protective covers from fog lights before use.



#### WARNING

Turn *OFF* engine and apply parking brake before removing fog light covers.

#### NOTE

Some states and provinces restrict the use of fog lights. Verify local state or provincial regulations before using.

### Hazard Warning Flashers

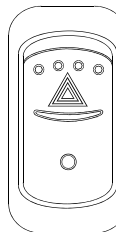

Depress the rocker switch to make all turn signal lights flash at once. The dashboard telltale lights will flash when the hazard warning flashers are *ON*.

Activating the hazard flashers also activates the vehicle's electrical circuits.



#### CAUTION

Do not use the hazard flashers for an extended period of time unless necessary because the electrical circuits are activated when the hazard switch is depressed.

### Headlights washer

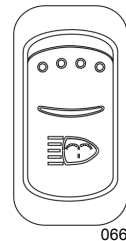

Momentarily press this rocker switch downwards to spray the headlights washer fluid. Each pressing of this switch produces 2 successive jets.



#### CAUTION

To avoid damaging the pump mechanism, do not use the windshield washer when the fluid level is very low or empty.

**Windshield Upper Section De-icing**

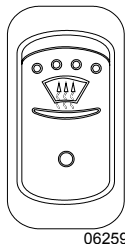

Optionally on Entertainers only, the vehicle may be equipped with a de-icing system in the windshield upper section. Press the rocker switch to activate the blower in order to clear fog, frost or thin ice from either side of the windshield upper sections.

**Docking/Cornering Lights**

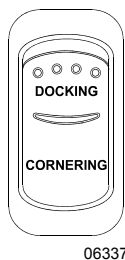

Depress the upper portion of the switch to activate both the docking and the cornering lights. Depress the lower portion of the switch to activate the cornering lights.

Two sealed beam halogen lights are installed on each side of the vehicle. One near the front and one near the rear.

When the switch is set to *DOCKING*, all four beams illuminate to ease parking.

When the switch is set to *CORNERING* and the left or right turn signal is activated, the corresponding front beam will illuminate to increase lateral visibility.

**Fast Idle**

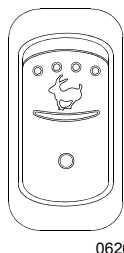

For extended idling periods, run the engine at fast idle. Press down the rocker switch to engage fast idle. This increases the engine speed to approximately 1,000 rpm. Return to slow idle before driving or when stopping engine.

**NOTE**

*If the parking brake is released and/or the transmission is engaged with the engine running at fast idle, the engine will return to low idle and remain there as long as the parking brake is not applied and/or transmission is not placed in neutral (N).*



**CAUTION**

Reduce the engine to low idle before shutting the engine OFF.

**Engine Brake With I-Shift Transmission**



On vehicles equipped with the I-shift transmission, use this switch to enable the engine brake.

Upon activation of this switch, the engine brake is in the auto mode (A). In this case, the engine brake interacts with the I-shift transmission according to the I-shift's eco-roll mode e+.

In the auto mode (A), the engine braking power varies with the brake pedal position.

Once this switch is activated, the driver can use the buttons located on the steering wheel to select between two other engine brake modes:

- Engine brake low (1)
- Engine brake high (2)

On the other hand, this selection will deactivate the auto mode (A) and the eco-roll mode will not be available.

**NOTE**

*On vehicles equipped with the I-shift transmission, any increase of the braking power, such as from auto mode (A) to engine brake low (1), from auto mode (A) to engine brake high (2) or engine brake low (1) to engine brake high (2) will deactivate the cruise control.*

**Engine Brake / Transmission Retarder (Optional)**

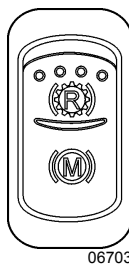

Use this switch to select between the transmission retarder and the engine brake when using the vehicle speed retarding device switches on the steering wheel. Both systems cannot be in function at the same time. This rocker switch will be found on the dashboard only if the vehicle is equipped with both systems. Refer to "Transmission Retarder" heading in this chapter. Refer also to "Transmission Retarder" & "Engine Brake" in "OTHER FEATURES" chapter.

**Engine Stop Override and DDEC Diagnostic Request**

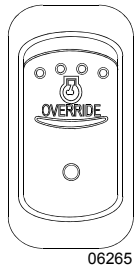

Press down this switch and release to override emergency engine shut down protection. Engine emergency shut down will be turned OFF for 30 seconds. This procedure can be repeated if done before the 30 seconds are up.



**CAUTION**

Use sparingly and in order to move the vehicle to a safe parking place only. Excessive use can cause severe engine damage.

**Driver Controlled Differential Lock (DCDL) (Optional)**



Press the rocker switch to lock or unlock differential action. Refer to "Other Features" chapter for the complete operating instructions.



**CAUTION**

- Engage DCDL only under poor road surface conditions.
- DCDL will not engage and will disengage in speed higher than 5 MPH.
- Do not lock DCDL when one or more wheels are slipping, spinning or losing traction. You can damage the drive axle.
- Using the rocker switch, unlock DCDL when the need for improved traction has passed otherwise it will reengage automatically as speed gets below 5 MPH. Over a prolonged period, this situation will increase tire wear and stress to the vehicle.
- Do not engage during downhill operation.

**R.H. DASHBOARD PANEL**

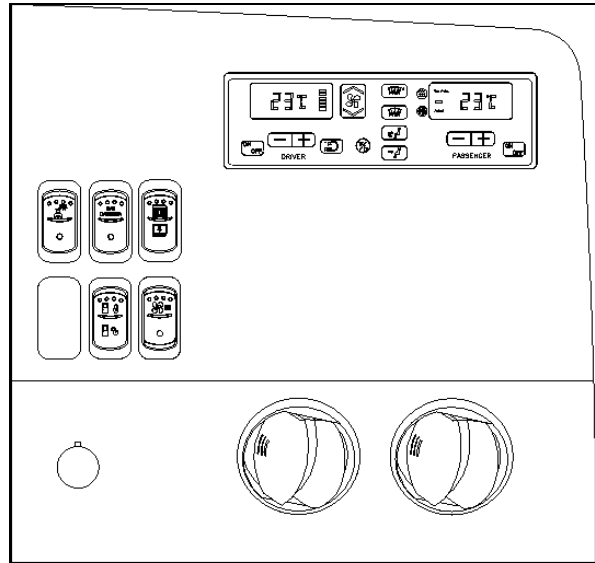

R.H. DASHBOARD PANEL

06644

The HVAC control module as well as the cluster dimmer switch, miscellaneous control switches and air vents, are located in the R.H. dashboard panel.

**Driver's Area Lighting**

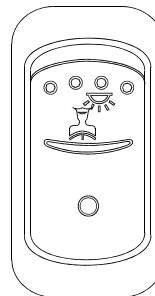

06244

Press down the rocker switch to illuminate the ceiling lights in the driver's area as needed.

**Back-Up Camera Switch**

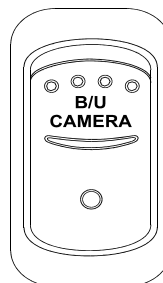

06314

Press down this switch to turn ON the Back-up Camera monitor when the transmission is not in reverse gear.

**Entrance Door Power Window**

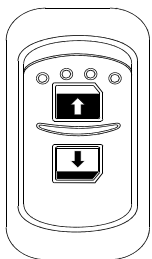

06338

Use the rocker switch to open or close the power window in the entrance door. The switch for the driver's power window is on the Lateral control panel.

**Entrance Door Switch**

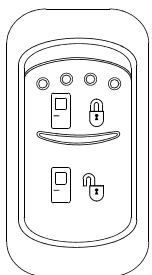

06313

Use this rocker switch located on the dashboard's R.H. side panel for locking or unlocking the entrance door from the driver's seat.

**Cabin Fan Speed Control Switch**

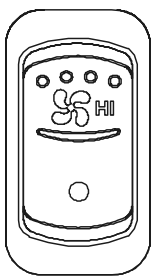

06566

Switches fan speed to HI for cabin ventilation (only available on models equipped with central HVAC).

**Brightness Control**



06565

Adjusts the brightness of the dashboard instruments and switches.

**HVAC CONTROL MODULES**

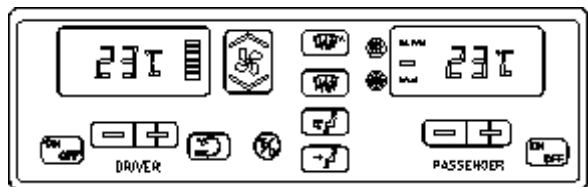

CENTRAL HVAC SYSTEM CONTROL MODULE

22296

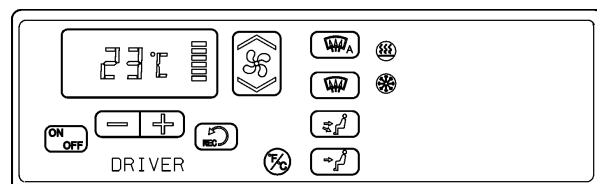

SMALL HVAC SYSTEM CONTROL MODULE

22333

The vehicle is slightly pressurized by the central HVAC system to prevent dust and moisture from entering. Air flow and controls divide the vehicle into two areas: driver's area with defroster and cabin area.

Fresh air is fed in each area and has a separate return air and discharge air duct.



**WARNING**

Warm temperatures may cause drowsiness and affect alertness while driving. For optimum driving conditions, keep temperature between 68°F and 72°F (20°C to 22°C).

**NOTE**

To operate the air conditioning system when stationary, run engine at fast idle. When the A/C system is running, keep windows and door closed.

To prevent battery run-down, the A/C and heating systems will not operate if the charging system is not working properly.

When the A/C system is running, park at least 4 feet (1,5 m) from other vehicles or buildings to allow sufficient air flow through the condenser core.

Separate driver's and passenger (cabin) heating, ventilation and air conditioning controls are located on this module. To operate, the vehicle's engine must be running.

The driver's HVAC unit or the cabin HVAC unit may be turned ON by pressing or or buttons. If the vehicle is equipped with a central HVAC system, the driver's HVAC unit turns on automatically at starting of the engine and uses the settings that were kept in memory before turning off of the system.

**Heating Mode Indicator**



22135

Illuminates when system is heating.

**Cooling Mode Indicator**



22134

Illuminates when system is cooling.



**Fan Speed**

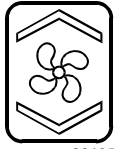

22135

The driver's fans have six speeds. Increase speed by pressing on the upper portion of the button, decrease by pressing on the lower portion.

**Driver's area temperature display**

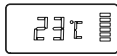

The temperature displayed on the driver's side HVAC control module is the temperature set point.

**Cabin area temperature display**

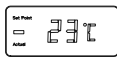

The temperature displayed on the passenger's side HVAC control module is the actual temperature in the cabin area.

**Temperature Set Button**

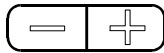

22132

The driver's side and the passenger's side have independent temperature controls.

These buttons determine the heating and cooling set points.

To increase the temperature set point, press on the "+" sign, to decrease the temperature set point, press on the "-" sign. Temperature range is between 55°F and 85°F (13°C to 29°C).

**Air Recirculation**



22138

Closes or opens the fresh air damper. A red LED in the top right corner of the button illuminates when driver's area air is recirculated. Use for faster driver's section heating.

**NOTE**

*Upon starting of the vehicle, when the ambient temperature is very cold and so is the inside of the vehicle, the HVAC control module will permit a temperature overshoot up to 3° over the cabin area set point to help warming up of the area because some parts of the vehicle like the seats and furniture accumulate cold.*

**Windshield Defogger**



Upon pressing this button, the dashboard damper sends air only to the lower windshield. The fan is

turned on to maximum speed, the fresh air damper opens completely (REC off) and the driver set point is increased to 4°F (2°C) over the passenger's section set point.



22139

The dashboard damper sends air only to the lower windshield when activated. The footwell damper is closed also but the fan speed can be reduced or increased.

**NOTE**

*If the windshield is continuously fogged, check that the driver's air filters are not clogged.*

**All Vents Open**



22140

Air is sent to defogger vents as well as panel and footwell vents.

**Panel and Footwell**



22137

Air is sent to panel and footwell vents only.

**Panel**



22136

Air is sent to panel vents only.

**Temperature Degree Selector**



22133

Toggles between Fahrenheit and Celsius units (Driver's HVAC unit must be turned ON).

**AIR VENTS**

Three adjustable driver air vents in the dashboard feed air to the driver's area. Use the HVAC control module to set air temperature.

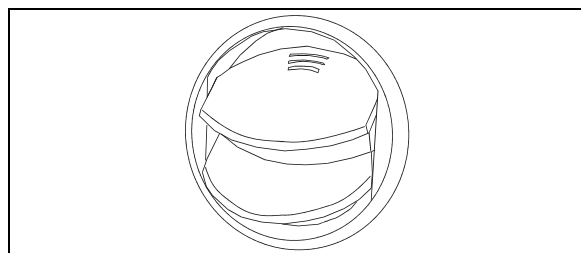

AIR VENT

**INSTRUMENT CLUSTER**

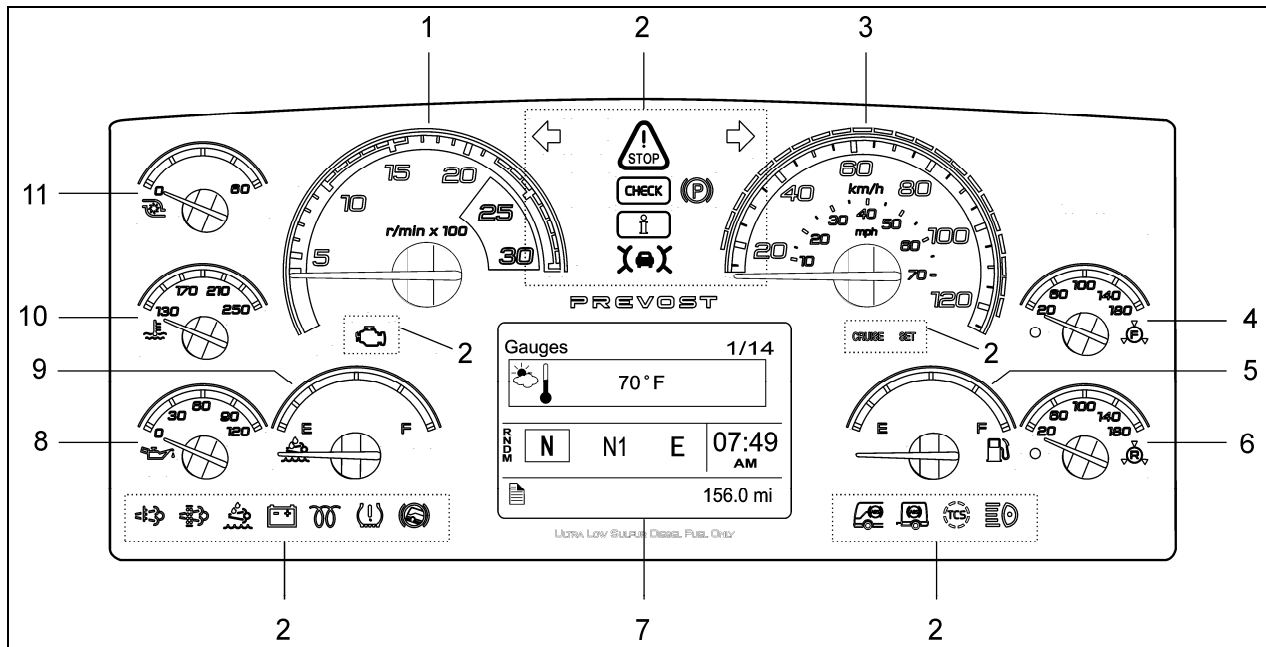

06727

- |   |   |
|---|---|
| <ul style="list-style-type: none"> <li>1. TACHOMETER</li> <li>2. TELLTALE LIGHTS</li> <li>3. SPEEDOMETER</li> <li>4. FRONT BRAKE AIR PRESSURE (SECONDARY)</li> <li>5. FUEL LEVEL</li> <li>6. REAR BRAKE AIR PRESSURE (PRIMARY)</li> </ul> | <ul style="list-style-type: none"> <li>7. DRIVER INFORMATION DISPLAY (DID)</li> <li>8. OIL PRESSURE INDICATOR</li> <li>9. DEF LEVEL (DIESEL EXHAUST FLUID) INDICATOR</li> <li>10. ENGINE COOLANT TEMPERATURE</li> <li>11. TURBO BOOST PRESSURE</li> </ul> |
|---|---|

The instrument cluster includes the analog instruments. It also presents two devices to communicate information to the driver, the telltale lights and the Driver Information Display (DID).

Indications and warnings are presented according to three levels of attention required:

**1. THE TELLTALE LIGHTS**

The highest level of attention. The telltale lights are temporary and exceptional; they present information critical to safety or vehicle integrity.

**2. THE POP-UP MESSAGES**

The second level of attention. The pop-up messages appear in the Driver Information Display DID without the driver's intervention and acknowledgement. Pop-up messages present supplemental information to the driver.

**3. THE STATUS LINE**

The lowest level of attention. The status line monitors certain systems and gives feedback to the driver concerning current actions and functions.

**ANALOG INDICATORS**

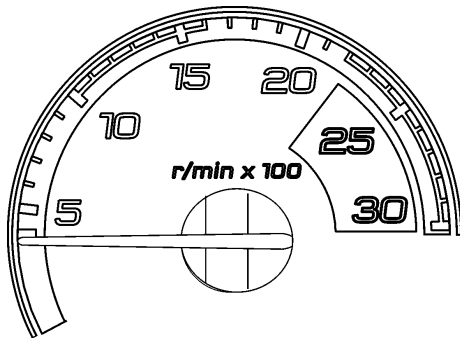

06728

**Tachometer (rpm x 100)**

Indicates the operating speed of the engine in hundreds of revolutions per minute. The tachometer serves as a guide for gear shifting and helps to prevent engine over-speeding when driving downhill with the engine brake operating. Use the green field for normal driving (1000 to 1600 rpm).



**CAUTION**

Never allow the engine to go into the red field. This could lead to severe engine damage.

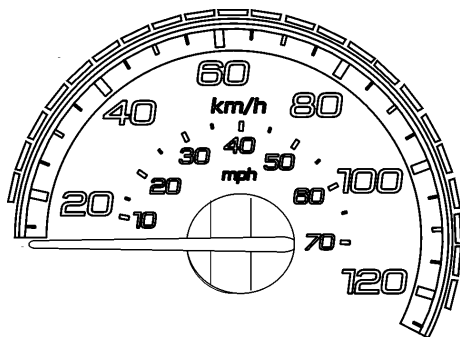

06729

**Speedometer (mph, km/h)**

Indicates the vehicle speed in miles per hour (mph) and kilometers per hour (km/h). The LEDs above the instrument work in conjunction with AWARE Adaptive Cruise Braking (ACB) system. Refer to “Prevost AWARE Adaptive Cruise Braking” paragraph.

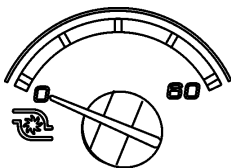

06730

**Turbo Boost Pressure (Psi)**

Indicates the turbo boost pressure in psi. This pressure should be the same at a given engine temperature, speed, and load. An unusual reading could indicate an engine failure.

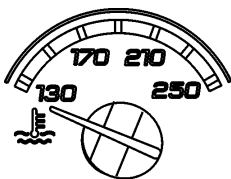

06731

**Engine Coolant Temperature (°F)**

Indicates the operating temperature of the engine coolant in °f. The normal reading should be between 170°f and 222°f (80°c to 106°c).

The temperature limit is dependent on the electronic program for the engine model. When coolant temperature is excessive, the stop telltale light turns on, an audible alarm sounds and a pop-up message appears on the DID. If the engine is at risk, the EECU may decrease the engine power. Stop at the first safe place where the problem can be checked.

If the temperature remains below or exceeds the normal temperature range, the cooling system should be checked for problems.



STOP telltale light

**Engine Oil Pressure (Psi)**

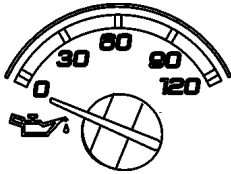

06732

Indicates the engine oil pressure in psi. When the oil pressure is too low, the stop telltale light turns on, an audible alarm sounds and a message appears on the DID. If the engine is at risk, the EECU may decrease the engine power. Bring the vehicle to a safe stop where the problem can be checked.



STOP telltale light



OIL PRESSURE pictogram



**WARNING**

Failure to take necessary action when the stop telltale light is on can ultimately result in automatic engine shutdown and loss of power steering assist. Vehicle crash can occur, resulting in severe personal injuries.

**Front Brake Air Pressure (Psi)**

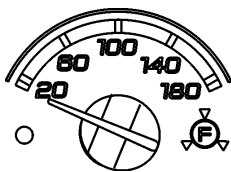

06737

Indicates the front brake air system pressure in psi. The normal operating pressure is from 95 to 125 psi.

A low air pressure indicator led illuminates when the front (secondary) air system pressure drops below 66 psi. If the air pressure drops below 60 psi, the stop telltale light will turn on, an audible alarm will sound and a message will appear on the DID. If the air pressure drops below 40 psi, the emergency spring brake applies at full capacity.



**WARNING**

Do not drive the coach when the brake air pressure is low.

**NOTE**

Do not refer to dashboard instruments during adjustment procedures. Use only calibrated gauges.

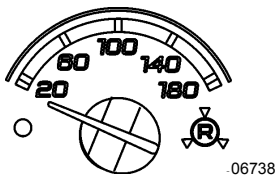

**Rear Brake Air Pressure (Psi)**

Indicates the rear brake air system pressure in psi. The normal operating pressure is from 95 to 125 psi.

A low air pressure indicator led illuminates when the rear (primary) air system pressure drops below 66 psi. If the air pressure drops below 60 psi, the stop telltale light will turn on, an audible alarm will sound and a message will appear in the DID. If the air pressure drops below 40 psi, the emergency spring brake applies at full capacity.



STOP telltale light



**WARNING**

Do not drive the coach when the brake air pressure is low.

**DEF Level**

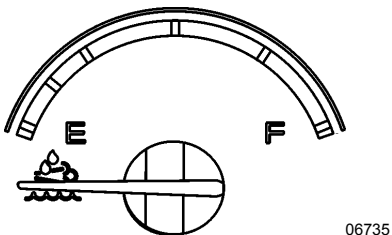

Indicates the amount of DEF (diesel exhaust fluid) remaining in the DEF tank. The DEF tank is considered as being full when it contains 16 gallons (60 liters) of DEF. DEF consumption will be approximately 2% of the diesel fuel consumed.



**CAUTION**

DEF will begin to crystallize and freeze at 12°F (-11°C). DEF expands by approximately 7% when frozen. In order to permit DEF expansion without causing damages to the DEF tank, do not fill the DEF tank with more than 16 gallons (60 liters).

**Fuel Level**

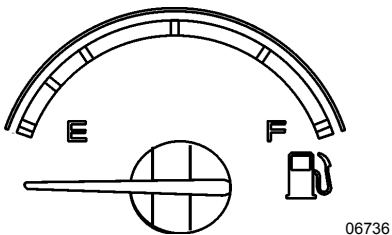

Indicates the amount of fuel remaining in the fuel tank. At the beginning of the red area, there is approximately 48 gallons (182 liters) left in the tank.

**NOTE**

A pop-up message will appear in the DID informing that there is only 24 gallons (92 liters) left in the fuel tank.

**TELLTALE LIGHTS**

The telltale lights illuminate during 5 seconds at the start of every ignition cycle as a light bulb check.



**STOP**

Indicates that a serious problem has been detected. Immediately park the coach in a safe place and stop the engine. This telltale light may be accompanied with a message in the DID and a diagnostic troubleshooting code will be stored to ease identification of the problem.



**CHECK**

Indicates that a problem has been detected and must be checked at the next stop. This telltale light may be accompanied with a message in the DID and a diagnostic troubleshooting code will be stored to ease identification of the problem.



**FORWARD VEHICLE DETECTED – ADAPTIVE CRUISE BRAKING**

When the ACB is engaged with a cruise speed set and the forward vehicle is in range, the FORWARD VEHICLE DETECTED telltale light illuminates, indicating the ACB system is actively tracking the forward vehicle.

**GREEN:** The vehicle ahead of you is detected by the radar.

**FLASHING RED:** Impact alert. The vehicle ahead of you is too close. The driver must take immediate evasive action by applying more braking power and/or steering clear of the vehicle ahead to avoid a potential collision.

**RED:** System malfunction. The Adaptive Cruise Braking is not available.



**INFORMATION**

This telltale light illuminates when there is a new information message or an abnormal status is detected by the electronic control unit. A pictogram, text or both are shown in the DID in addition to the info telltale light. Make sure the indicated fault is checked at the next stop.



**TURN SIGNAL INDICATORS**

Flashes when the right or left turn signals are activated. Signal right and left turns by operating the multi-function lever. See “Steering Column Controls” in this chapter.

***NOTE***  
*The turn signals are automatically activated when the vehicle is backing up.*



**PARKING BRAKE OR EMERGENCY BRAKE APPLIED**

Illuminates when the emergency/parking brake is applied. The control valve is located on the L.H. control panel. An audible alert will sound if ignition is turned to off and the parking brake is not engaged.



**AFTERTREATMENT SYSTEM MALFUNCTION (MALFUNCTION INDICATOR LAMP)**

Indicates a failure of an emission control device. May illuminate at the same time as the CHECK amber warning light. The lamp will go out after 3 completed *ignition on-ride-ignition off* cycles. Vehicle can be driven to end of shift. Call for service.

**CRUISE CRUISE CONTROL**  
Indicates that the cruise control is enabled.

**SET CRUISE CONTROL SET SPEED**  
Indicates that a cruising speed is set and stored in the memory.



06740\_A

**HIGH EXHAUST SYSTEM TEMPERATURE (HEST)**

Illuminates to notify the driver of potentially hazardous exhaust gas temperature at the exhaust system diffuser.



**WARNING**

During regeneration, exhaust temperature may reach up to 1200°f (650°c) at the particulate filter. When parking the vehicle, if this telltale light is illuminating, make sure that the exhaust system diffuser is away from people or any flammable materials, vapors or structures.



06740\_B

**DPF REGENERATION REQUEST**

Illuminates to notify the driver that a manual stationary regeneration will be required soon. Refer to “Exhaust Aftertreatment System” paragraph in *Other Features* chapter.



06740\_C

**LOW DEF LEVEL**

Illuminates when there is less than 2.6 gallons (10 liters) of DEF left in the tank.



**CAUTION**

This telltale light starts flashing when there is only 2.5 liters (0.6 gallons) left in the tank.

If the vehicle is kept in operation with an empty DEF tank, and engine derate will eventually occur, limiting the speed to 5 mph.



06740\_D

**ALTERNATORS**

Indicates an alternator problem. One of the alternators is not charging.



06740\_E

**INTAKE AIR PREHEATER ON – WAIT BEFORE STARTING**

Illuminates when the intake air preheater element is in function. Wait until this telltale light has turned off before starting the engine. For more information on this feature, refer to paragraph “Cold Weather Starting” in *Starting And Stopping Procedures* chapter.



06740\_F

**FLAT TIRE (WITH OPTIONAL TIRE PRESSURE MONITORING SYSTEM)**

Illuminates when a tire pressure is 25% below the target tire pressure.



06740\_G

**HILL START ASSIST**

Indicates a malfunction of the hill start assist function. This function might not be available.



06740\_H

**ANTILOCK BRAKE SYSTEM (ABS)**

Illuminates when the ABS is not available or when the ABS is malfunctioning. Since the ABS system does not operate at less than 4 mph (7 km/h), the indicator will remain illuminated until the coach reaches that speed. Refer to *Other Features* chapter.



06740\_I

**TRAILER ANTILOCK BRAKE SYSTEM (ABS)**

Illuminates when the trailer ABS is not available or when the trailer ABS is malfunctioning.



06740\_AA

**TCS/ESC - TRACTION CONTROL SYSTEM AND ELECTRONIC STABILITY CONTROL**

This telltale illuminates and stays on whenever TCS or ESC is disabled due to a diagnostic fault code.

During an ESC or TCS intervention, the telltale will blink rapidly to indicate this action.

When in TCS mud/snow mode, this telltale will blink continuously to indicate that this mode is active. When the TCS mud/snow is active, the ESC is disabled at speed lower than 25 mph (40 km/h), for this reason, the telltale will stop blinking and will stay on.



06740\_K

**HIGH BEAM**

Illuminates when the high beams are selected. High and low beams are selected with the multi-function lever. Refer to "Steering Column Controls" paragraph in this chapter.



**STOP, CHECK AND INFORMATION  
TELLTALE LIGHTS**

STOP, CHECK and INFORMATION telltale lights illuminate automatically to draw the attention of the driver and their associated messages are displayed in the DID. More than one message (see “Acknowledging Messages” below) can be active at the same time. A displayed message can be replaced by a new message provided the new message has a higher priority. Only fault codes that have a direct impact on vehicle operation are displayed. All fault codes are stored in the appropriate ECU for access by service technicians.

**STOP Telltale light**

In the event of a serious fault, the red STOP telltale light comes on and an audible alarm will sound if the engine is running. An illuminated stop message light indicates a serious problem has been detected, and the driver must respond immediately to the problem.



When illuminating, this telltale light means the vehicle must be safely pulled off the road and stopped. In some instances, the engine must be switched off immediately.

	<p><b>WARNING</b></p>
<p>Failure to stop and take necessary action when the STOP telltale light is on can result in automatic engine shutdown and loss of power steering assist. This can result in vehicle accident and severe personal injuries.</p>	

In some cases preventive action may be taken by the engine ECU to protect the engine, for example:

- 1- If oil pressure or coolant level drop too low, the engine is forced to low idle and when the vehicle speed is zero, the engine shuts down.
- 2- With excessive coolant temperature, the engine will gradually reduce power output to 50%. This telltale light always activates an audible alarm.

After the automatic engine shutdown sequence, the engine may be restarted after the key is turned off and then back on. However, it will only operate for 30 seconds unless the problem is resolved. The Engine Stop Override switch can be used to override the automatic engine shutdown protection. The automatic engine emergency shutdown will be turned OFF for 30 seconds. This procedure can be repeated if done before the 30 seconds are up. Use this function sparingly and in order to move the vehicle to a safe parking place only.

**CHECK Telltale light**

This telltale light means that a fault or an abnormal operating condition has been detected. The vehicle must be checked at the next stop.



If the CHECK telltale light illuminates, an associated message is displayed in the DID. Always pay attention to the associated messages (see “Acknowledging Messages” below).

**INFORMATION Telltale light**

The INFO indicator light comes on when there is a new information message or an abnormal status is detected by the electronic control unit. A pictogram or text or both are shown in the DID in addition to the INFO telltale light (see “Acknowledging Messages” below).



**Acknowledging Messages**

A fault message associated to a STOP, CHECK or INFORMATION telltale light must be acknowledged by pressing the ESCAPE or ENTER button after which the display returns to the same status that existed before the fault occurred. All messages can be acknowledged. Acknowledged but inactive messages are displayed again when the ignition key is turned to the START position or they can be read in the DID menu. Refer to *Other Features* for more information on the DID menus.

**DRIVER INFORMATION DISPLAY**

The DID (Driver Information Display) is located in the center of the instrument cluster. It displays digital gauges, main menus and sub-menus that provide necessary and important information to the driver. The information available to the driver depends on vehicle configuration, and whether the vehicle is in operation or parked. For the list of the available menus and sub-menus, refer to "Driver Information Display Menus" in *Other Features* chapter.

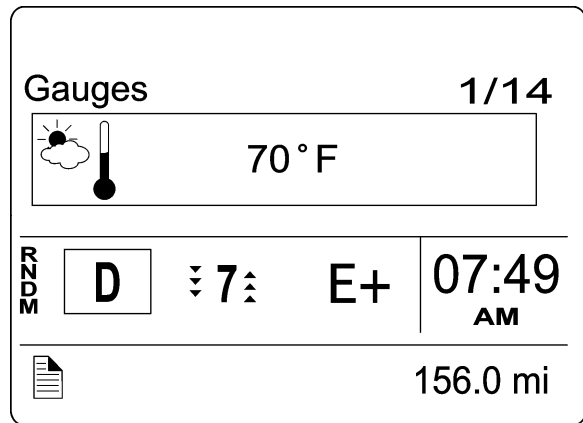

06746

The outside air temperature, fuel flow and the odometer (Allison transmission) or the current gear position (transmission I-Shift) are part of the default display. You can replace the default display by your selection of favorite gauges using the Driver Information Display sub-menu Favorite Display Setting. Refer to *Other Features* chapter for more information.

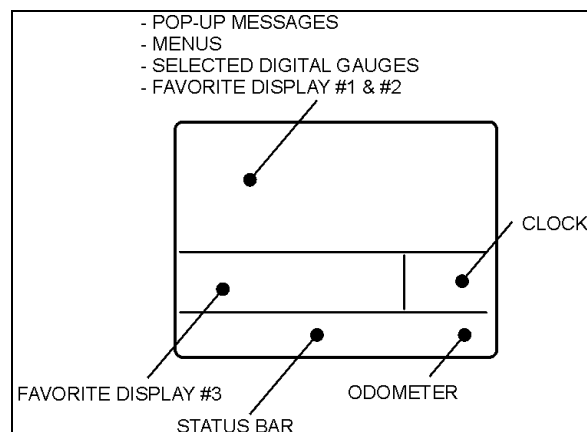

06742

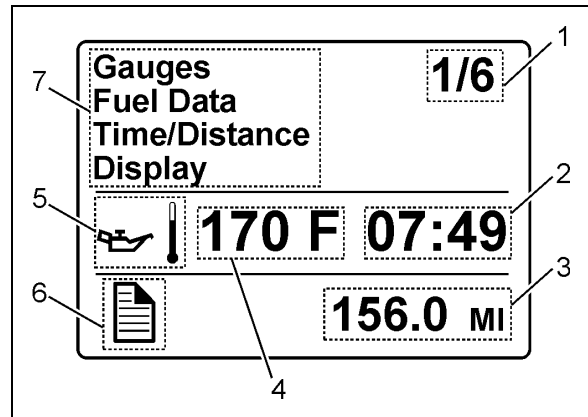

06743

1. Indicates first of six available menus (varies by menu)
2. Clock
3. Odometer
4. Value or data (in this example, the engine oil temperature)
5. Pictogram relevant to the displayed value or data
6. Status bar active pictogram
7. Messages or available menus

**Selecting a menu**

Menus are placed in a cascade arrangement. Use the steering wheel controls buttons to scroll through them.

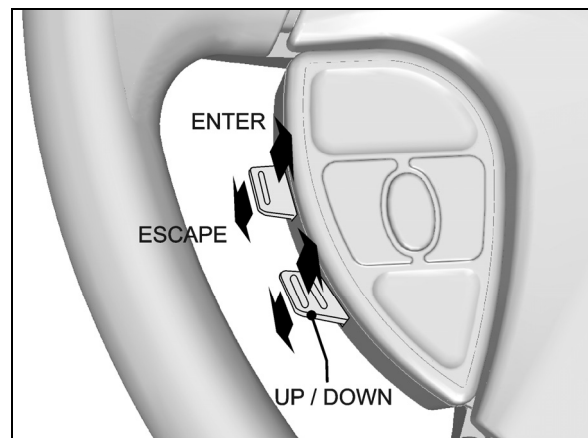

14069\_3

To select a menu:

1. Press the ENTER or ESCAPE button to display the list of available menus.
2. Use the UP/DOWN button to scroll up or down through the menus.

3. Use the ENTER button to open a menu.
4. Use the ESCAPE button to return to the previous menu or display or to cancel a setting or operation.

**To change settings**

To change a setting, like the clock for example:

5. Use the UP/DOWN button to increase or decrease the numerical value of the selected field.
6. Use the ENTER button to confirm your choice and to move to the next field.
7. Press the ESCAPE button to return to the previous field or to cancel a setting or operation.

In alternate mode, use the multi-function lever as follows:

- Move the lever up = UP
- Move the lever down = DOWN
- Push the lever away from you = ENTER
- Pull the lever towards you = ESCAPE

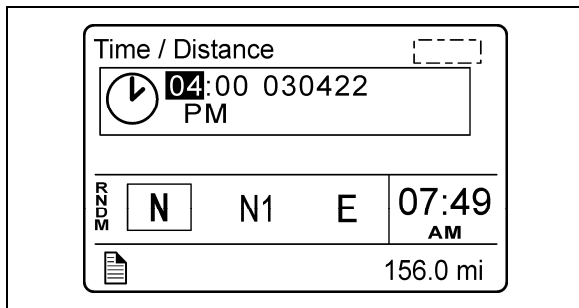

06743

**Scrolling through the menus without using the steering wheel buttons**

In case of failure of the steering wheel buttons, it is still possible to gain access to the menus or acknowledge the pop-up messages to return to the default display.

This alternate mode is possible only if the steering wheel buttons are faulty.

To enable the alternate mode:

1. Apply the parking brake;
2. Depress and hold the service brake pedal.

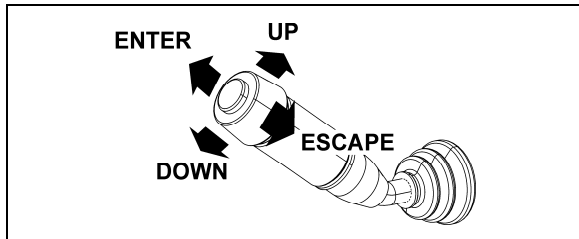







**MULTI-FUNCTION LEVER**











**PICTOGRAMS DISPLAYED ON THE DRIVER INFORMATION DISPLAY (DID)**

**NOTE**

*In certain situations, the pictogram displayed represents a system or a function of the vehicle. A particular pictogram may be displayed with different messages. In that situation, it is very important to pay attention to the message displayed with the pictogram.*

**Warning pictograms, pop-up message pictograms, verifications and information pictograms**

DRIVER INFORMATION DISPLAY “GAUGES” MENU PICTOGRAMS	
Pictogram	Description
	<b>Engine oil temperature</b>
	<b>Outside air temperature</b>
	<b>A/c compressor pressure</b> This pictogram is displayed with A/C compressor suction pressure value (low side) and discharge pressure value (high side).
	<b>Accessories air pressure</b> Normal pressure should be between 95 and 125 psi.
	<b>Voltmeter</b> This pictogram is displayed with both the 12-volt and 24-volt electrical system current voltage value. When the engine is running, the 24-volt electrical system voltage value should be between 26,5 et 28,0 volts.
	<b>Transmission oil temperature</b>
	<b>Current gear position (I-Shift transmission)</b> Indicate the current transmission gear position on the Volvo I-Shift transmission. R= reverse N = neutral D= drive M= manual mode

POP-UP MESSAGES	
Pictogram	Description
	<b>High engine oil temperature</b>
	<b>Engine coolant temperature</b>
	<b>Engine oil pressure</b>
	<b>Intake air preheater failure</b>
	<b>Engine temperature too low for Volvo Engine Brake (VEB) operation</b>
	<b>High transmission oil temperature</b> This pictogram indicates that the transmission oil temperature is too high. Turn the transmission retarder off to allow the oil to cool down.
	<b>Allison transmission– oil or filter replacement required</b> This pictogram may be displayed with many different messages. Pay attention to the displayed message which can advise that the transmission oil or filter change is necessary. Refer to Appendix C for more information on the Allison transmission prognostic features (oil life monitor, filter life monitor, transmission health monitor).
	<b>Trailer braking system low air pressure / trailer parking brake</b> This pictogram appears when the trailer emergency/parking brake is unexpectedly applied as when the vehicle is moving and a parking brake air line rupture happens.
	<b>Low brake or ABS air pressure</b>
	<b>A/C system pressure high</b> This pictogram indicates that the A/C system pressure is too high. If the A/C pressure is too high, the compressor clutch is disengaged, but the fan remains activated.
<p><b>NOTE</b></p> <p>When outside temperature is high, it is possible and normal for that pictogram to appear.</p>	



**A/C system pressure low**

This pictogram indicates that the A/C system pressure is too low. If the A/C pressure is too low, the compressor clutch disengages and the fan stops.

**NOTE**

When outside temperature is low, it is possible and normal for that pictogram to appear.



**Battery voltage warning**

This pictogram indicates that the battery voltage is too high, too low or the 12-volts/24-volts battery arrangement is not equalized.

The value LOW or HIGH is displayed at the right of the pictogram to indicate if the voltage is too low or too high.

**NOTE**

This pictogram will illuminate for a few seconds after the engine is started because of the voltage drop when the starter is engaged.

**NOTE**

To identify the battery problem (too high, too low or not equalized voltage), using the DID menus, perform a system diagnostic by selecting DIAGNOSTIC, VIEW ACTIVE FAULTS, ELECTRICAL SYSTEM and see the fault messages.

**NOTE**

To prevent discharge of the batteries when the engine is not running, some functions are automatically switched off if the batteries voltage drops below 24.0 volts for more than 30 seconds. Set the ignition key to the OFF position and then turn the ignition key to the ON position to reactivate the functions for a period of 30 seconds before they switch off again.

**NOTE**

If the battery equalizer indicator illuminates, make sure that the battery equalizer circuit breakers are reset before requesting breakdown assistance. Wait 15 minutes after setting breakers to allow batteries to equalize. The breakers are located on the rear junction panel, on the engine compartment R.H. side.



**Engine door ajar**

This pictogram indicates that the engine compartment door is ajar.



**Emergency window open**

This pictogram indicates that an emergency window is open or unlocked.



**Baggage compartment door ajar**

This pictogram indicates that one or more baggage bay doors are ajar.



**Low windshield washer or headlights washer fluid level**

Illuminates when the windshield washer or the headlight washer fluid level is low. The washer fluid containers are located inside the front service compartment.



**WARNING**

Do not drive without sufficient washer fluid.



**Wheelchair lift**

This pictogram indicates that the wheelchair lift system is enabled and the wheelchair access door or the lift compartment door is open. It is necessary to stow the wheelchair lift, close the doors and set the wheelchair lift system enable switch to the off position to permit release of the parking brake.



**Lavatory occupied**

This pictogram indicates that the lavatory compartment is occupied. This pictogram will appear only when the engine is shut down in order to advise the driver of the presence of a passenger in the lavatory compartment during a stop.



**Lavatory compartment emergency call**

If the vehicle is moving, this pictogram indicates that a passenger has activated the lavatory compartment emergency call button.



**Differential lock (option)**

This pictogram indicates that the differential action is locked.



**Freezing conditions**

This pictogram appears when the temperature is in the range between 0°c and 2°c (32°f et 35°f), when the road is most slippery.



**Fuel level**

This pictogram appears when approximately 24 US gallons (92 liters) of fuel remains in the tank. Refuel as soon as possible.



**Automatic traction control**

This pictogram appears when the automatic traction control system intervenes to prevent excess wheel spin during acceleration.



**Parking brake applied**



**DPF regeneration**



### High exhaust gas temperature

This pictogram appears to notify the driver of potentially hazardous exhaust gas temperature at the DPF outlet.



### WARNING

During regeneration, exhaust temperature may reach up to 1200°F (650°C) at the particulate filter. When parking the vehicle, if this pictogram is displayed, make sure that the DPF outlet diffuser is away from people or any flammable materials, vapors or structures.



### Fuel economy

This pictogram is displayed with fuel consumption value of the vehicle. Proper units for the displayed value are written under the pictogram: liters/100km, km/liter, mpg, liters/hour.



### Leg fuel consumption

This pictogram is displayed with the value for the fuel consumption for the current leg.



### Trip data

Function of the DID's "Time/Distance" menu. Refer to "Driver Information Display Menus" in *Other Features* chapter.



### Estimated time of arrival

Function of the DID's "Time/Distance" menu. Refer to "Driver Information Display Menus" in *Other Features* chapter.



### Fuel filter/water separator

Indicates that the draining the fuel filter/water separator is required. See *Care And Maintenance* chapter.



### Raised tag axle

This pictogram appears if the vehicle speed exceeds 12 mph (20 km/h) while the tag axle is raised.



### Low buoy

This pictogram appears if the vehicle speed exceeds 12 mph (20 km/h) while the front suspension of the vehicle (kneeling) or the entire vehicle suspension is lowered (low buoy).



**Fire in engine compartment**

This pictogram appears if a fire is detected in the engine compartment while the vehicle is on the road. An audible alarm informs the driver when a fire is detected. In case of fire detection when parked (parking brake applied, engine running or not), the electric horn is activated to alert the driver. Refer to *Safety Features And Equipment* chapter.

**WARNING**

In case of a fire, stop the vehicle immediately, stop the engine and evacuate the vehicle.

***NOTE***

*It is possible to cancel an alarm while on the road. To do so, stop the vehicle. Cycle the ignition between the ON and OFF position and then start the vehicle normally. This can be done on a temporary basis when a false alarm is activated by a defective fire detector. The driver can go on without being annoyed by the alarm.*













***NOTE***

*To stop the electric horn alarm when parked, cycle the ignition between the ON and OFF position twice within 3 seconds.*

***NOTE***

*For extinguisher's location, refer to SAFETY FEATURES AND EQUIPMENT chapter.*

Status Line Pictograms

Pictogram	Description
	<b>Message active</b>
	<b>Alarm clock activated</b>
	<b>Raised tag axle</b>
	<b>Kneeling/front suspension hi-buoy active</b> Indicates that the front suspension (kneeling) or the entire vehicle suspension (low buoy) is lowered.
	<b>Baggage compartments locked</b> Confirm that all the baggage compartment doors are locked.
	<b>Baggage compartments unlocked</b> Indicates that at least one baggage compartment door is unlocked.
	<b>Adaptive Cruise Braking (ACB) not available</b> Indicates that the Adaptive Cruise Braking system is disabled.
	<b>Engine brake</b> Confirm that the engine brake is disabled.
	<b>Engine brake - Auto Mode (available with I-Shift transmission)</b> Indicates that the engine brake is in the Auto mode. When in this mode, the engine brake is activated upon pressing of the brake pedal. To select the Auto mode, set the dashboard engine brake switch to the ON position. When in Auto mode, the engine brake interacts with the I-Shift transmission according to the transmission's Eco-Roll mode <b>E+</b> .
	<b>Engine brake – Engine Brake Low (1) and Engine Brake High (2)</b> Confirm which engine braking power is selected with the steering wheel control buttons.
	<b>Allison transmission retarder</b> Confirm that the Allison transmission retarder is off.
	<b>Allison transmission retarder – braking level 0, 1, 2, 3, 4, 5, 6</b> Confirm the retarder hand lever position. Each position corresponds to a given braking level. Refer to “Transmission Retarder” heading in this chapter.

**VEHICLE CLEARANCE INFORMATION**

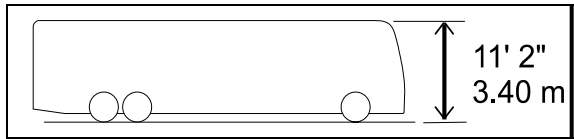

Safe vehicle clearance height is 11'2" (3.40 m).



**CAUTION**

Vehicle clearance is higher when the ventilation hatch is open, hi-buoy is selected or if additional equipment is installed on the roof.

**STEERING COLUMN CONTROLS**

Many of the most frequently used controls are conveniently placed on the steering column or the steering wheel, just like a passenger car. The multi-function lever is located on the left side of the steering wheel while the optional transmission retarder lever is located on the right side of the steering wheel. Switches for the electric horn and the air horn are located directly on the steering wheel.

**MULTI-FUNCTION LEVER**

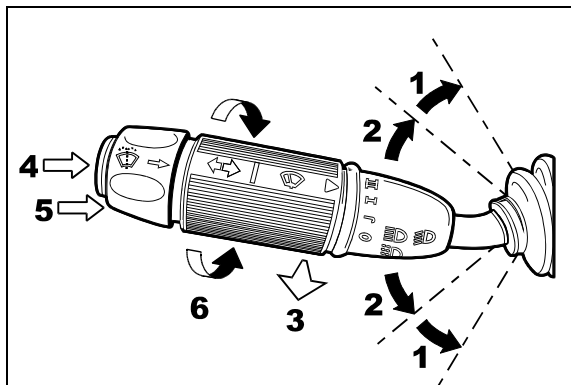

MULTI-FUNCTION LEVER

23133

The multi-function lever is used to operate the following:

**Turn Signal (1)**

Move the lever all the way up until it locks in position to signal a right turn. Move the lever all the way down until it locks in position to signal a left turn. The lever automatically returns to the horizontal OFF position once the turn is completed.

**Lane Change Signal (2)**

Move the lever part way to the catch position and hold until the lane change maneuver is completed. The lever will spring back into the OFF position once released.

**Headlight Beam Toggle Switch (3)**

Toggle between high and low beams by pulling the lever up towards you. To flash the headlights, pull the lever up halfway. The lever will spring back into normal position once released.

**Courtesy Blinkers (4)**

Clearance and parking lights can be flashed by pressing the button located on the lever tip.

**Windshield Washer Control (5)**

Push the external ring at the end of the lever toward the steering column to activate the windshield washers. The wipers come ON and continue wiping for a few seconds after the ring is released.



**WARNING**

Before using the windshield washers in cold weather, heat the windshield with the defroster to prevent icing and reduced visibility.



**CAUTION**

To avoid damaging the pump mechanism, do not use the windshield washer when the fluid level is very low or empty.

**Windshield Wipers (6)**

Turn the lever counterclockwise to activate the windshield wipers. The first position activates the wipers intermittently. The second position is the slow speed and the third position is for high speed wiping.



**CAUTION**

To avoid scratching the windshield, do not operate the wipers when the windshield is dry. To avoid damaging the wiper motor, free wiper blades that may be frozen to the windshield before operating the wipers.

### STEERING WHEEL CONTROLS

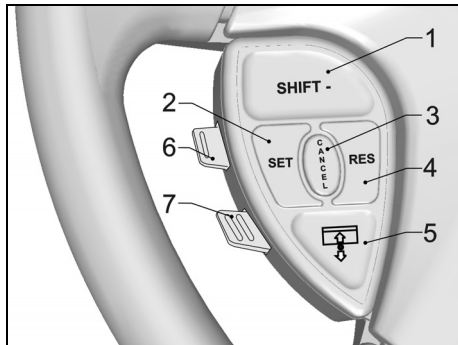

LEFT STEERING WHEEL CONTROLS

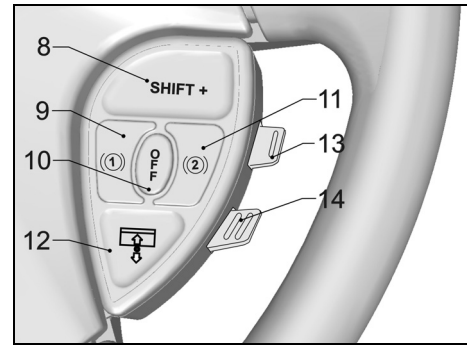

RIGHT steering wheel CONTROLS

The steering wheel controls include the following functions:

**1, 8 Shift Down, Shift Up (I-Shift Transmission)**

Use these buttons to shift down or shift up manually the transmission range as would do the “-” & “+” keys on the I-Shift gear selector keypad.

**2 Set (Cruise Control)**

For the cruise control operating instructions, refer to “Cruise Control” paragraph in this chapter.

**3 Cancel (Cruise Control)**

For the cruise control operating instructions, refer to “Cruise Control” paragraph in this chapter.

**4 Resume (Cruise Control)**

For the cruise control operating instructions, refer to “Cruise Control” paragraph in this chapter.

**5, 12 Left Sunshade, Right Sunshade**

Press and hold the button to lower the left or right sunshade. Press twice rapidly and hold the button to raise the left or right sunshade.



**CAUTION**

Do not attempt to raise or lower these shades manually. Damage to electric motor or roller mechanism could result.

**6 Escape/Enter (Driver Information Display)**

Enter: lift this button briefly.

Escape: press briefly on this button.

**7 Up/Down (Driver Information Display)**

Use this button to scroll up or down through the menus.

**9 Retarder / Engine Brake Low (Ⓛ)**

If your vehicle is equipped with a transmission retarder, press this button to simply enable the transmission retarder. Afterwards, operate the transmission retarder with the hand lever mounted on the steering wheel or the brake pedal. For more information about the operation of this system, refer to “Transmission Retarder” heading in this chapter.

On vehicles equipped with an engine brake, the engine brake provides two levels of braking power. Press this button for low engine braking power (about 66 % of full braking power). Refer to *Other Features* chapter for more information about the engine brake operation.

 <b>WARNING</b>
Engine brake must be used on dry road only. Never use the engine brake on slippery roads; loss of control could result.

**10 Retarder / Engine Brake Off**

Press this button to cancel operation of the transmission retarder or the engine brake.

On vehicles equipped with the I-Shift transmission, activation of this button set the engine brake in Auto mode (A). You must set the Engine Brake switch located on the dashboard to the OFF position to turn off the engine brake.

**11 Retarder / Engine Brake High (2)**

If your vehicle is equipped with a transmission retarder, this button has the same effect than the Retarder/Engine Brake Low (1) button.

On vehicles equipped with engine brake, pressing this button will permit full application of engine brake (100 % of braking power). Refer to *Other Features* chapter for more information concerning the engine brake operation.

 <b>WARNING</b>
Engine brake must be used on dry road only. Never use the engine brake on slippery roads; loss of control could result.

**13 Volume (Dashboard Radio)**

Use this button to increase or decrease the dashboard radio (driver’s radio) volume.

**14 Seek (Dashboard Radio)**

Use this button to seek up or down for a radio station.

**HORNS**

The electric horn (city horn) and air horn (highway horn) are operated from the steering wheel center pad. Use the Horn Selector switch located on the lateral control panel to select the appropriate horn type.

<p><b>NOTE</b></p> <p><i>When the vehicle is stationary, the electric horn will sound to inform the driver that a fire is detected in the engine compartment.</i></p>
---

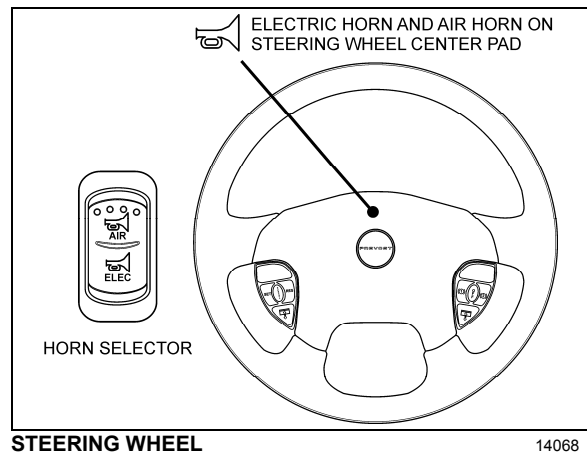

**TRANSMISSION RETARDER**

The retarder can be operated using a hand lever mounted on the steering wheel column or using the service brake pedal.

To use the transmission retarder, it must be activated first by pressing one of the two Retarder/Engine Brake buttons on the steering wheel.

**Operating the Retarder Using the Hand Lever**

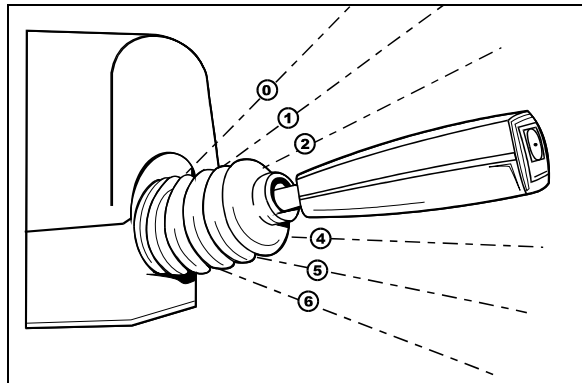

RETARDER HAND LEVER 07043

With the retarder enabled and the accelerator pedal released, move the output retarder lever clockwise from the first to the sixth position. The braking level for each position is as follows:

Position	Braking level (up to)
Initial ①	Varies with brake pedal
①	16%
②	33%
③	49%
④	71%
⑤	89%
⑥	100%

**NOTE**  
The output retarder lever is located on the right side of the steering column.

**Operating the Retarder Using the Brake Pedal**

With the retarder enabled, the accelerator pedal released and the output retarder lever in the initial position ①, depressing the brake pedal will engage both the service brake and the transmission retarder. This is referred to as retarder-brake blending. The further the pedal is depressed, the more total braking power is provided. Refer to "OTHER FEATURES" chapter for

further information about the transmission retarder.

**NOTE**  
If the wheels start to lock up on slippery roads, the output retarder will automatically deactivate until the wheels start to turn.

**FOOT-OPERATED CONTROLS**

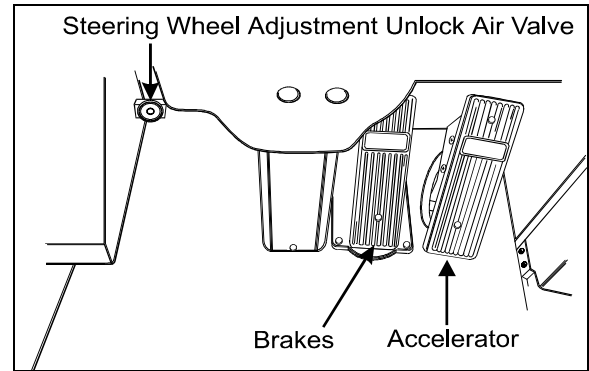

FOOT OPERATED CONTROLS 18118A

**SERVICE BRAKES**

The coach is equipped with a dual braking system. The front brakes operate differently from the drive and tag axle brakes.

The dual braking system becomes a modulated emergency system if a pressure drop occurs in the rear brake system. Only the drive and tag axles are equipped with parking brakes.

Service brakes are applied by depressing the brake pedal. Braking increases with the amount of pressure applied to the foot pedal. Refer to "Other Features" chapter under "Anti-lock Braking System". When the brake pedal is depressed, the brake lights turn ON automatically.

For safe and effective braking, the air system pressure should reach at least 95 psi (655 kPa) in both the primary and secondary circuits.

A warning light and a buzzer will sound when the air pressure in either the primary or secondary circuits drops below 70 psi (483 kPa). If this occurs, stop the coach; determine the cause of the pressure loss before proceeding. The brake pedal can be used in conjunction with the transmission retarder. Refer to Transmission Output Retarder in this section.

**DANGER**

Immediately report any brake system problem to the nearest Prevost or Prevost-authorized service center.

Do not "fan" or "pump" the brake pedal. This practice does not increase brake system effectiveness but rather reduces system air pressure thereby causing reduced braking effectiveness.

**CAUTION**

"Riding" the brake by resting one's foot on the brake pedal when not braking can cause abnormally high brake temperature, can damage and cause premature wear of brake components and reduce brake effectiveness.

**ACCELERATOR PEDAL**

Controls engine RPM as needed.

**NOTE**

The accelerator pedal will not operate when the front door is open.

**ALLISON AUTOMATIC TRANSMISSION**

The transmission is fully automatic: Proper ranges should be automatically selected according to driving speeds to improve vehicle performance and control. The speed ratio of the power converter changes automatically as vehicle speed increases and direct-drive goes in and out as necessary. The speed ratio is modulated by vehicle speed and accelerator pedal position. You will find the complete transmission operation instructions and driving tips in the **Allison Bus Series Operator's Manual** included in your vehicle's publication box.

**OPERATION**

When a button is depressed on the transmission control pad, the corresponding letter or number is displayed indicating the transmission is ready to operate in the selected range. If the transmission control module (TCM) detects a serious problem in the transmission, a buzzing tone sounds for 5 seconds and the "CHECK TRANS" light on the dashboard illuminates to warn the driver that the transmission is held in

gear. If another button is depressed, the buzzing sound will continue until the original range is selected.

**NOTE**

As a light bulb and systems check, the "CHECK TRANS" light will illuminate when the ignition switch is turned to ON. After about two seconds the light will turn off. If the "CHECK TRANS" light remains on, the self-diagnostic system has detected a problem. If the problem disappears, the light will go out, but a trouble code will remain stored in the TCM.

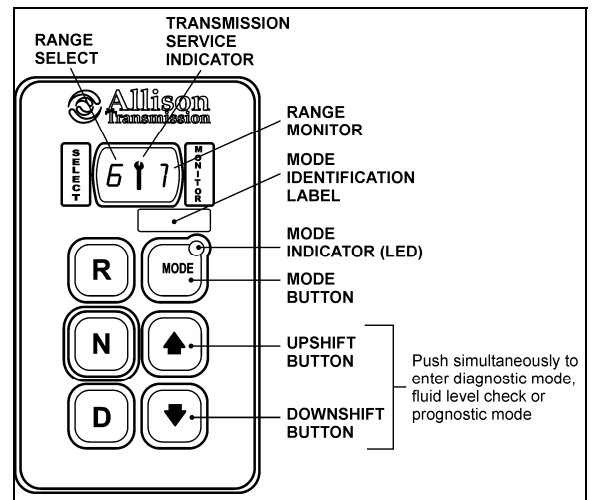

ALLISON PUSHBUTTON SHIFT SELECTOR 07142

**PUSHBUTTON SHIFT SELECTOR**

The pushbutton shift selector has the following elements:

**R** (Reverse) — Press this button to select Reverse.

**N** (Neutral) — Press this button to select Neutral.

**D** (Drive) — Press this button to select Drive. The highest forward range available will appear in the digital display window under SELECT. The transmission will start out in the lowest available forward range, displayed under MONITOR, and advance automatically to the highest range.

**▲ ▼** — Press respectively the ▲ (Upshift) or ▼ (Downshift) arrow button when in DRIVE to request the next higher or lower range. One press changes gears by one range. If the button is held down, the selection will scroll up or down until the button is released or until the highest or lowest possible range is selected. Protection mechanisms inhibit selecting ranges that are not

appropriate for the current speed or which may damage driveline components.

**MODE** — The MODE button can allow the driver to enable a secondary shift mode that has been programmed into the TCM unit. The name of the secondary mode appears on the MODE IDENTIFICATION label adjacent to the MODE button. Pressing the MODE button activates the PERFORMANCE shift schedule and illuminates the mode indicator (LED).

**NOTE**

*When the diagnostic display mode has been entered, the MODE button is used to view and toggle through diagnostic code information. Refer to Appendix C for more details about **diagnostic code display procedure** and **fluid level check** using the pushbutton shift selector.*

**FUNCTIONS OF THE “MODE” BUTTON**

Both ECONOMY (default mode at starting of the engine) and PERFORMANCE (secondary shift mode) modes are equivalent from the first to the fourth gear as the transmission upshifts at around 2000 rpm.

The ECONOMY mode allows for upshifts in fifth and sixth gear at around 1700 rpm. This is a more efficient operation of the transmission and thereby helps improve fuel economy.

The PERFORMANCE mode keeps upshifts at 2000 rpm in fifth and sixth gears. This makes for better performance than the economy mode but with higher fuel consumption. It is recommended this mode be selected while driving up or down grades. The mode indicator (LED) is illuminating when PERFORMANCE mode is selected.

**TRANSMISSION SERVICE INDICATOR**

 — This indicator will illuminate upon the detection of a service issue relating to clutch, filter or fluid life. The appearance of the indicator (lit steadily, flashing, etc.) varies for each of the conditions monitored by the system. Refer to appendix C for more details about **diagnostic code display procedure, fluid level check or prognostic features** (Oil Life Monitor, Filter Life Monitor and Transmission Health Monitor) using the pushbutton shift selector.

Illuminated at startup for a bulb check, this indicator will then turn off if no service conditions exist.

**DESCRIPTION OF AVAILABLE RANGES**

**Reverse (R)**

Use this position to back-up the vehicle. Stop completely before shifting from forward to reverse or from reverse to forward. Touch the reverse (R) button, “R” will be displayed and the reverse warning signal will be activated.

**Neutral (N)**

Use this position to start engine. Select neutral (N) when checking vehicle accessories and for extended periods of engine idle operation; parking brake must then be applied. The push-button shifter will automatically select neutral when the master switch is turned ON.

**NOTE**

*The automatic transmission does not have a park (P) position. Select neutral (N) and apply parking brake when the vehicle is left unattended. A warning buzzer will sound if the engine is stopped and the parking brake has not been applied when foot pressure is removed from the brake pedal.*

 **DANGER**

Always put the transmission in NEUTRAL and apply parking brake before leaving driver's seat.

 **DANGER**

The vehicle service brakes or park brake must be applied whenever NEUTRAL is selected to prevent unexpected vehicle movement.

 **CAUTION**

Volvo Diesel engines should not be idled for extended periods at "slow" idle. For extended idling, engine should run at "fast" idle.

 **CAUTION**

Do not allow your vehicle to "coast" in neutral. This practice can result in transmission damage. Also, no engine braking is available in neutral.



**Drive (D)**

Use this position for all normal driving conditions. After touching this pad, the vehicle will start in first or second range and will automatically upshift to a higher range as output speed increases. As the vehicle slows down, output speed decreases, the transmission automatically downshifts to the correct range. If a locked brake or a slick surface condition should occur, the TCM (Transmission Control Module) will command converter operation (disconnect lockup) and inhibit downshifts for a period of time or until normal wheel speed has been restored.

***IMPORTANT NOTE***

*Brake pedal must be applied when selecting Drive (D) otherwise the transmission will stay in neutral (N).*

- First range (1):

Select this range when pulling through mud and snow or when speed control is needed for driving up steep grades. This range also provides maximum engine braking power or retarder braking effect. In the lower ranges (1, 2, 3 and 4), the transmission will not upshift above the highest gear selected unless engine overspeed is detected.

***NOTE***

*The transmission should normally be allowed to shift by itself, but manual shifting can be done as described below.*

- Second range (2)

Select this range when operating in heavy and congested traffic. The transmission will start in first and automatically upshift to second. When slowing, the transmission will automatically downshift to first range. Low ranges provide progressively greater engine and retarder braking power (the lower the range, the greater the engine and retarder braking effect).

- Third and fourth ranges (3 and 4)

Select these ranges when driving on moderate grades or when load and traffic conditions limit speed.



**WARNING**

Service brakes should not be used to control the speed of vehicle on long, steep descents. Instead, lower transmission ranges should be used (in conjunction with output retarder. Refer to "Engine Brake" and "Transmission Retarder" headings in "Other Features" chapter for details regarding both systems. This procedure keeps service brakes cool and ready for emergency stopping.



**CAUTION**

When descending in lower ranges, care must be taken that engine speed does not exceed 2,450 rpm.

**VOLVO I-SHIFT TRANSMISSION**

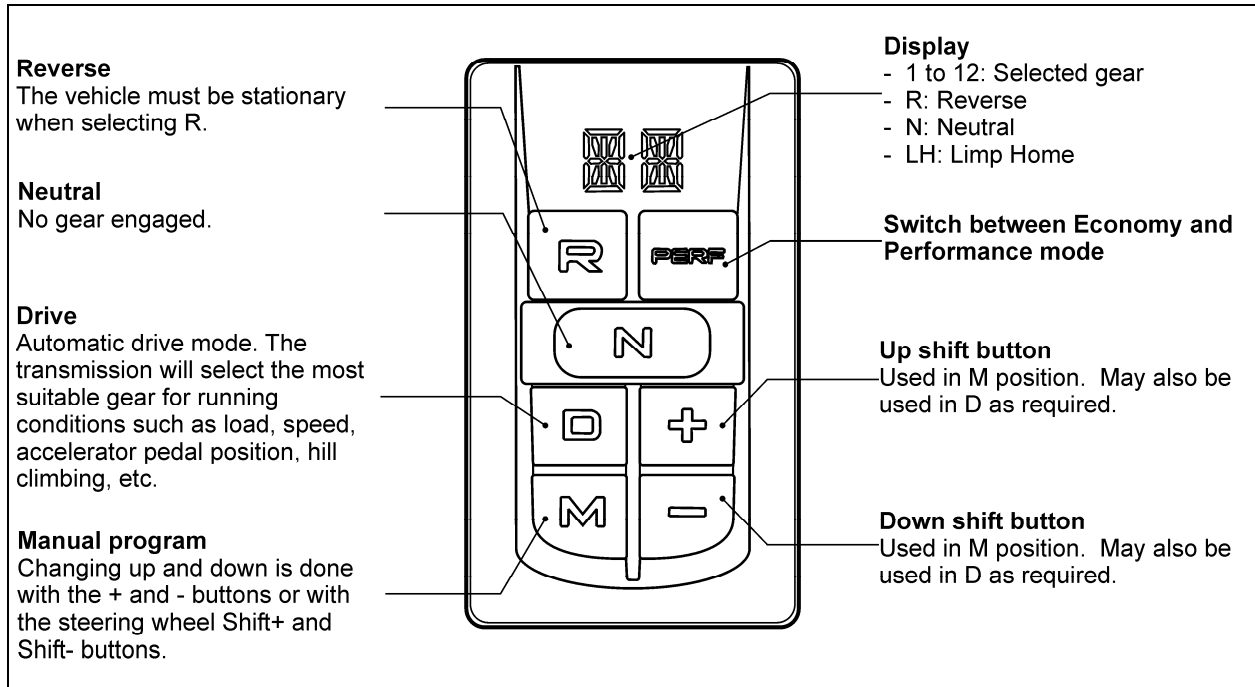

I-SHIFT PUSHBUTTON SELECTOR

07145

I-Shift transmission is an automated gearbox with 12 forward gears and 2 reverse gears. The clutch operation and gear shifting are fully automatically so that the driver can concentrate on the traffic.

**PUSHBUTTON SHIFT SELECTOR**

The pushbutton shift selector has four gear positions: R, N, D and M.

R= Reverse

N= Neutral

D= Drive

M= Manual program

It is not possible to shift neither directly from R position to D or M position nor from D or M position to R position. N position must be selected first. If the driver executes such gear shifts, the transmission will shift automatically to N position.

**R ⇔ N ⇔ D or M**

**DISPLAY**

Status of the I-Shift transmission is shown on the Driver Information Display (DID). Displayed information is position, selected gear and driving mode.

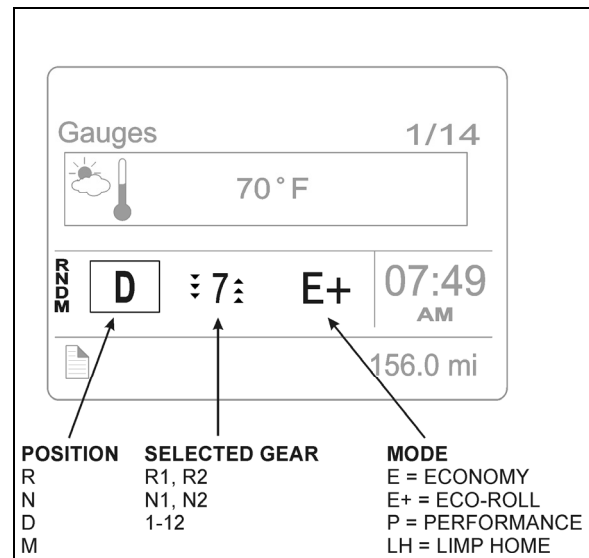

I-SHIFT PUSHBUTTON SELECTOR

07145

**ACCELERATOR PEDAL**

When changing gear, the accelerator pedal should not be released. The system will govern the clutch, gearbox and engine speed. The system selects the gear and the point in time for gear changing for optimum driving performance based on accelerator pedal position, road inclination, etc.

**ECONOMY AND PERFORMANCE MODE**

When the engine is started, the transmission is in Economy mode. The transmission automatically selects shift points and engine parameters to maximize fuel economy. Economy mode is primarily used when driving under normal conditions.

The Performance mode gives driveability the highest priority for optimum driving in traffic condition and gradeability.

**NOTE**  
*Operating the vehicle in Performance mode for extended periods can result in a loss of fuel economy.*

**ECO-ROLL MODE (FREEWHEEL FUNCTION)**

Eco-Roll reduces fuel consumption by automatically disengaging the driveline when the engine is not needed to maintain vehicle speed. When Eco-Roll is active, the engine speed is temporarily reduced to idle. Eco-Roll can be used during normal driving with the accelerator pedal or while in cruise control mode.

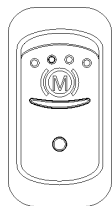

Eco-Roll is only available when the engine brake is in Auto mode (A). First, set the dashboard Engine Brake switch to the ON position.

When Eco-Roll is enabled, the DID shows E+. When Eco-Roll intervenes, the selected gear displayed in the DID (7–12) will change momentarily to N1 or N2.

Eco-Roll disengages as soon as the brake pedal or the accelerator pedal is depressed, but it remains available. To disable Eco-Roll, set the dashboard Engine Brake switch to the OFF position. Eco-Roll is not available when the Engine Brake Low (1) or Engine Brake High (2) modes are selected.

When Eco-Roll is enabled, it activates automatically, but only when the following conditions exist:

- Accelerator pedal is released.
- Service brake is released.
- Engine brake is in Auto mode (A).
- Transmission pushbutton shift selector is in the D position
- Transmission is operating in the Economy mode.
- Vehicle is operating on a downhill or uphill grade not greater than 2%.
- Selected gear is greater than 6.
- Brake cruise set speed is greater than 3 mph (5 km/h) above cruise set-speed.
- Vehicle speed is less than 78 mph (125 km/h).
- Electronic Stability Control (ESC) and antilock brake system (ABS) are not active.
- Exhaust Aftertreatment System regeneration is not active.

**LIMP HOME MODE**

Limp home is an emergency mode that can be engaged if a fault has occurred in the gearbox that prevents the vehicle from being driven in automatic, manual or reverse modes.

**NOTE**  
*Limp Home mode should only be used for moving short distances.*

To activate the Limp Home mode:

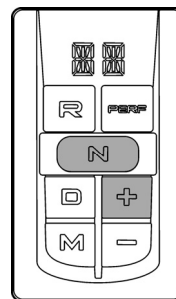

- Simultaneously press **N** and **+** buttons. Activating can only be done while the vehicle is stationary.
- Select **M** position or **R** position as required.

The driver can select gears for forward driving or for reversing using the **+** and **-** button when position **M** (manual program) or **R** (reverse) is selected.

## 74 Controls and Instruments

The following gears are available:

Forward driving - 1, 3 & 5

Reverse driving - R1

To select the reverse driving in Limp Home mode, simply select position R. Gear changing can only be done while the vehicle is stationary.

### To Deactivate the Limp Home Mode

The Limp Home Mode will be deactivated when the ignition is turned off.

## STARTING AND STOPPING

### Starting

The pushbutton shift selector must be in the N position or the engine will not start. If the pushbutton shift selector is not in neutral, a starter protection message will appear in the DID along with the INFORMATION telltale and an audible warning.

If there is not enough air pressure in the I-Shift air tank, a low air supply message will appear in the DID along with the INFORMATION telltale light and an audible warning. Start the engine and allow the air pressure to build in the tank. Wait until the message and the telltale light turn off before attempting to shift the transmission into gear.

The brake pedal must be pressed down when passing from the N position to another position otherwise pressing the buttons will have no effects.

### Stopping

When parking the vehicle, always apply the parking brake and place the pushbutton shift selector to the N position. Make sure the parking brake is holding the vehicle before leaving the driver position. Failure to do so can result in unexpected vehicle movement and can cause serious personal injury or death.

When the vehicle is stopped:

1. Apply the parking brake.
2. Select the N position on the pushbutton shift selector.
3. Turn off the engine.

## STARTING THE VEHICLE UPHILL AND DOWNHILL

### Hilly Operating Conditions

When starting the vehicle on an uphill slope:

1. Press the brake pedal.
2. Select the D position on pushbutton shift selector. The driver can use the – button to select a lower start gear if wanted.
3. Quickly move your foot from the brake pedal and completely depress the accelerator pedal.



### CAUTION

Always use the brakes to hold the vehicle stationary on an uphill stop. Never hold the vehicle stationary on an uphill slope using the accelerator pedal. The clutch could overheat, which could cause it to breakdown.

The I-Shift transmission clutch is a dry disc type, with **no torque converter**. Never allow the clutch to slip in a too high gear when starting the vehicle. If the clutch overheats, a high clutch load message or clutch protection active message will appear in the DID along with the CHECK telltale light and an audible warning.



### DANGER

The vehicle can roll when stopped on a hill or grade, or when the vehicle is starting from a stop on a hill or grade. Always use the brakes to hold the vehicle stationary on a hill or grade. Failure to do so can result in serious personal injury or death.

### Hill Start Assist

Hill Start Assist provides anti-roll assistance during the transition from standing still to starting on a grade. The brake system maintains pressure in the brake chambers for 3 seconds after the service brake pedal is released, which allows time to the driver to move is foot from the brake pedal to the accelerator pedal.

Hill Start Assist is only intended to temporarily hold the vehicle on a grade before the vehicle is put into motion. The vehicle brake must be applied, independent of HILL START ASSIST, to hold the vehicle on a grade for an extended period of time.

When available, Hill Start Assist is enabled at starting of the engine. The Hill Start Assist telltale light in the instrument cluster will blink to indicate that the feature is temporarily disabled. If a Hill Start Assist fault occurs, the Hill Start Assist telltale light in the instrument cluster will illuminate and the feature is permanently unavailable until the fault is repaired.

When Hill Start Assist is enabled, it activates automatically, but only when the following conditions exist:

- Vehicle speed is zero.
- Vehicle is on an incline or decline greater than 2%.
- Shift selector is in the D position on an incline or R position on a decline.
- Service brake is applied.
- ESC (Electronic Stability Control) is functioning normally.
- There has been no ESC activity in the preceding stops.

When the service brake pedal is released, the brakes are applied for approximately 3 seconds or until the accelerator pedal is depressed, whichever occurs first.

 <b>WARNING</b>
Always apply parking brake before leaving driver's seat. The driver must not leave the vehicle when the engine is running and a gear is selected.

**DRIVING**

The most efficient way to operate the vehicle is to use the automatic drive program, which is the D position on the pushbutton shift selector. Gear changing is automatic and the driver can concentrate on the road ahead.

<b>NOTE</b>
When driving in automatic drive mode (position D), the engine brake control should be in the Auto mode (Ⓐ) to maximize the integration of the transmission and brake system according to Eco-Roll mode. This means optimum performance and fuel economy at all times.

**D Position**

With the pushbutton shift selector in the D position, the transmission will automatically upshift and downshift as necessary to maintain the desired vehicle speed for the current driving conditions.

At starting of the vehicle, the gearbox selects between gear 1-6 the most suitable start gear with respect to weight and road's gradient. The driver can select a pulling away gear different than the one selected by using the + and - buttons.

When the vehicle is moving in automatic drive mode, the driver can intervene manually, while maintaining the accelerator pedal depressed, by selecting a higher or lower gear using the + and - buttons. The arrows in the display show how many gears are available to change up or down.

Whenever gear changing is not desired while in automatic drive mode, change the pushbutton shift selector from D to M. No further gear changes will be carried out and the current gear will remain engaged.

 <b>CAUTION</b>
There is a risk of over-revving the engine when the transmission is locked in a gear. Damage to the engine may occur. To lock the transmission in the current gear, change the pushbutton shift selector from the D position to the M position. This function can be used for all 12 forward gears. To return to the automatic drive mode, set the pushbutton shift selector back to the D position.

**M Position**

It is possible to drive the vehicle with full manual gear changing or take over from the automatic gear changing system whenever required. Gear changing is done by first selecting the manual position M.

## 76 Controls and Instruments

In manual shift mode, the driver use the + and – buttons to select gears.

The transmission will not automatically change gears as the driving conditions change. The current gear is displayed in the DID along with the up and down arrows. The number of available upshifts and downshifts will change as driving conditions change.

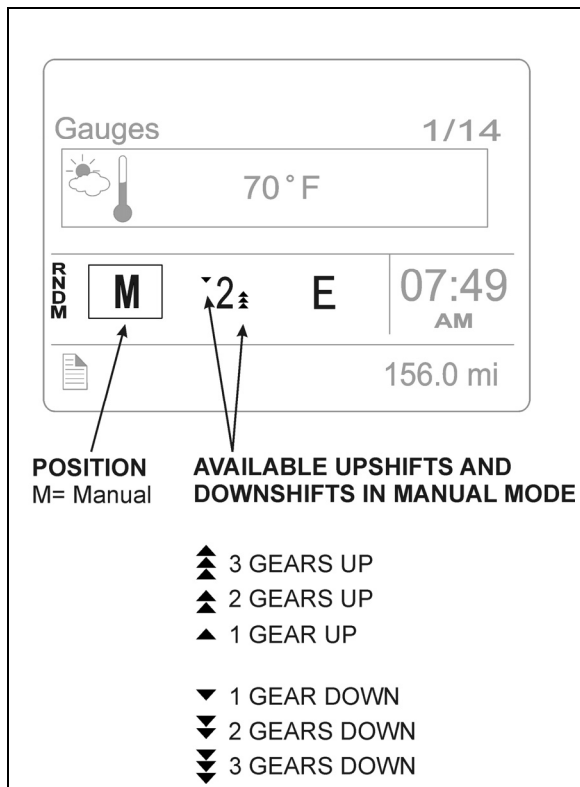

When changing a gear, the accelerator pedal should not be released.



### CAUTION

Starting in a too high gear exposes the clutch to high levels of wear.



### CAUTION

The driver must avoid over-revving the engine.

### R Position

The system will select R2 automatically when the pushbutton shift selector is set to R, but if wanted, the driver can select R1 as reverse gear manually using the – button. During reverse, it is possible to shift between gear R1 and R2 using the + and – buttons.

### TOWING



### CAUTION

When towing the vehicle, the transmission output shaft must not be allowed to spin or turn. If the vehicle is towed with the drive wheels still in contact with the road surface, the vehicle axle shafts or driveline must be removed or disconnected. Do not attempt to push or pull-start the vehicle.



### CAUTION

Make sure axle shafts or driveshaft are installed correctly after towing. Tighten axle shaft and driveshaft nuts to the correct torque settings. Do not invert shafts.

<b>EXHAUST AFTERTREATMENT SYSTEM.....</b>	<b>79</b>
FILTRATION AND REGENERATION UNIT .....	79
SELECTIVE CATALYTIC REDUCTION UNIT .....	81
DEF TANK LEVEL – DRIVER WARNING AND INDUCEMENT .....	83
DEF QUALITY – DRIVER WARNING AND INDUCEMENT .....	84
SCR SYSTEM TAMPERING – DRIVER WARNING AND INDUCEMENT .....	85
<b>DRIVER INFORMATION DISPLAY (DID) MENUS.....</b>	<b>86</b>
<b>DRIVING MODE MENU .....</b>	<b>86</b>
GAUGES.....	86
FUEL DATA .....	88
TIME / DISTANCE .....	88
VEHICLE MESSAGES .....	89
RESET TRIP DATA .....	89
<b>NON-DRIVING/STATIONARY MODE MENUS .....</b>	<b>89</b>
DISPLAY SETTINGS.....	89
DIAGNOSTICS .....	91
PRE-TRIP ASSISTANT .....	92
DATA LOG.....	93
AFTERTREATMENT .....	94
PASSWORD .....	95
<b>ALLISON TRANSMISSION ELECTRONIC CONTROLS.....</b>	<b>95</b>
<b>TRANSMISSION RETARDER .....</b>	<b>95</b>
<b>ENGINE BRAKE.....</b>	<b>96</b>
EXHAUST BRAKE.....	96
VOLVO ENGINE BRAKE (VEB).....	96
ENGINE BRAKE – AUTO MODE (WITH I-SHIFT TRANSMISSION ONLY) .....	97
<b>ANTILOCK BRAKING SYSTEM (ABS)- AUTOMATIC TRACTION CONTROL (ATC) – ELECTRONIC STABILITY CONTROL (ESC).....</b>	<b>97</b>
<b>DRIVER CONTROLLED DIFFERENTIAL LOCK (DCDL) .....</b>	<b>98</b>
OPERATION TIPS.....	98
LOCKING THE DCDL.....	98
UNLOCKING THE DCDL .....	98
<b>RETRACTABLE TAG AXLE.....</b>	<b>98</b>
<b>VARIABLE ASSISTANCE STEERING GEAR (OPTIONAL) .....</b>	<b>99</b>
<b>KEYLESS ENTRY SYSTEM .....</b>	<b>99</b>
KEYLESS OPERATING INSTRUCTIONS .....	99
PROGRAMMING A PERSONAL CODE .....	99

## 78 Other Features

---

REMOTE ENTRY TRANSMITTER.....	100
PROGRAMMING TRANSMITTERS.....	100
<b>SLIDE-OUT OPERATION .....</b>	<b>101</b>
SAFETY PRECAUTIONS .....	101
FRONT AND REAR SLIDE-OUT OPERATION .....	101
SLIDE-OUT MANUAL OVERRIDE PROCEDURE.....	102
SLIDE-OUT TROUBLESHOOTING .....	105
TRUBLESHOOTING – OPERATING CONDITIONS, CONTROL & MECHANICAL COMPONENTS .....	106



## EXHAUST AFTERTREATMENT SYSTEM

The exhaust aftertreatment system consists of two units, the filtration and regeneration unit and the selective catalytic reduction SCR unit.

### FILTRATION AND REGENERATION UNIT

The aftertreatment system primary function is to capture and oxidize (regenerate) the particulate matter (soot) in the engine exhaust gases and to reduce NOx. To achieve this goal, the exhaust aftertreatment system is split into two main sections: the exhaust gases first enter the **Diesel Oxidation Catalyst (DOC)** and **Diesel Particulate Filter (DPF)** assembly to capture and regenerate the soot on a regular or passive basis, then the exhaust gases flow through the **catalytic converter** to reduce NOx to minimum level. Through constant monitoring of the exhaust gas temperature and the system back pressure, EMS is able to manage regeneration.

#### Passive regeneration

Passive regeneration is the process by which the particulate matter is oxidized due to the heat generated by the engine internal combustion process. During normal highway operation, exhaust temperatures alone are usually high enough to oxidize accumulating soot. In low ambient temperatures, however, or in some stop-and-go applications, the system needs a little help to regenerate, or clean itself. This process is called "active" regeneration.

#### Active regeneration







Active regeneration is necessary when the engine internal combustion process alone does not generate enough heat. A dosing system injects a mist of diesel fuel into the exhaust system to increase and maintain the aftertreatment system temperature. Exhaust temperature must be above 572°F (300°C) to initiate the oxidation catalyst, which in turn oxidizes the injected diesel fuel molecules to achieve up to 1200°F (650°C) exhaust temperature at the particulate filter. This process of active regeneration takes place during the normal operation cycle of the vehicle without charges in performance or control for the operator. EPA2010 compliant Volvo engines produce less soot, so less active or stationary regeneration will be required.

#### Stationary (parked) regeneration

In a small number of specific engine duty cycles, engine control module may not be capable of completing an active regeneration. In these situations, the operator will be notified that a stationary or parked regeneration may be required. A DPF telltale light will illuminate indicating the need for user interaction. The lamp gives the operator a grace period to allow this process to take place at a time when most convenient for the operator. This process requires the vehicle to be parked while a driver or maintenance technician initiates the regeneration process using the DID menus. Once initiated, the stationary regeneration process will be complete in about 45 minutes.

The driver will be notified of the need for a stationary regeneration (parked) by illumination of the DPF REGENERATION telltale light.

## Diesel particulate filter clogging sequence – Instrument cluster telltale light

<b>LEVEL 1</b>	 solid	<p><b>REGENERATION NEEDED</b></p> <p><i>Diesel particulate filter is becoming full</i></p> <p><i>The DPF REGENERATION telltale light illuminates to notify the driver that a stationary regeneration (parked) will be required soon. When this lamp is lit, initiate stationary regeneration process at an appropriate time of day. <b>THERE IS NO URGENCY AT THIS LEVEL.</b></i></p>
<b>LEVEL 2</b>	 flashing	<p><b>REGENERATION REQUIRED</b></p> <p><i>Diesel particulate filter full</i></p> <p><i>If no DPF regeneration occurs after the initial DPF REGENERATION telltale light illumination, the lamp will begin blinking and a stationary regeneration should be initiated as soon as possible in order to prevent from entering into Level 3.</i></p>
<b>LEVEL 3</b>	 flashing + 	<p><b>ATD SERVICE REQUIRED</b></p> <p><b>ENGINE DERATE ACTIVE</b></p> <p><i>Diesel particulate filter overfull</i></p> <p><i>If the flashing DPF REGENERATION telltale light is still ignored, the CHECK telltale light will illuminate. In that situation, engine performance is limited. Perform a parked regeneration IMMEDIATELY to avoid further derate and prevent from entering into Level 4.</i></p>
<b>LEVEL 4</b>	 flashing +  + 	<p><b>ATD SERVICE REQUIRED</b></p> <p><b>ENGINE SHUTDOWN ACTIVE</b></p> <p><i>A serious engine problem has occurred. The DPF may be over its maximum capacity.</i></p> <p><i>If a stationary regeneration is still not initiated, a standard Engine Protection Shutdown sequence will occur. All of the following dashboard lamps will be present:</i></p> <p><i>Blinking DPF REGENERATION telltale light;</i>  <i>Solid CHECK telltale light;</i>  <i>Solid STOP telltale light.</i></p> <p><i>Once engine derate and/or shutdown sequence is completed, a stationary regeneration must occur to continue vehicle operation. If the driver continues to operate the vehicle without regeneration, additional measures will be taken to protect the engine and ATD from damage, up to and including engine shutdown. Parked regeneration might no longer be possible.</i></p> <p><b><i>If engine protection has been initiated and forces the engine to shutdown, you CAN immediately re-start the engine and perform the necessary steps in order to initiate a stationary regeneration.</i></b></p>

**Initiating a Stationary (Parked) Regeneration**

**NOTE**  
 At starting of the engine, if a stationary regeneration is required, the engine coolant temperature must reach 140°F (60°C) before any stationary regeneration may be initiated and completed. Permit the engine to idle for a short while or drive the vehicle until engine temperature increases sufficiently.

 **WARNING**  
 Do not initiate a stationary regeneration in a closed area like a garage. Stationary regenerations must be undertaken outdoors only.

 **WARNING**  
 During stationary regeneration, exhaust temperature may reach up to 1200°F (650°C) at the particulate filter. Before initiating stationary regeneration, make sure that the DPF outlet diffuser is clear of objects and that no one is working near the DPF outlet diffuser.

 **WARNING**  
 Hot surfaces. Keep yourself clear of all hot Aftertreatment Device components, particularly during and after active or stationary regeneration. Hot surfaces can cause serious burns.

**NOTE**  
**STATIONARY REGENERATION**  
 This process requires the vehicle to be parked while the driver or a maintenance technician initiates the regeneration process.

The DPF REGENERATION telltale light illuminates to notify the driver of the need and urgency of a manual stationary regeneration.



DPF REGENERATION telltale light

If stationary regeneration is not performed, this telltale light will blink, indicating that a stationary regeneration is required immediately. If stationary regeneration is still not performed,

“engine power derate and shutdown” sequence may occur as per level 1 to level 4 sequence.

To initiate a stationary regeneration:

- Park the vehicle in a clear area, vehicle speed must be 0 mph (0 km/h);
- Engine must be on normal idle and fully warmed up (coolant temperature above 140°F/60°C);
- Apply parking brakes and set the transmission to neutral (N).
- Press the DID ENTER button and then get to the DID Aftertreatment menu. Select sub-menu Request Parked REGEN and press ENTER button to confirm and initiate regeneration.

The regeneration will begin. Turn off the air conditioning to reduce engine load. The engine idling speed will increase to 1600 rpm. Once the regeneration is completed, the engine speed will return to normal idle.

**Voluntary Interruption of a Stationary Regeneration**

It is possible to interrupt a stationary regeneration at all time. To do so, set the ignition key to the OFF position or get to the DID’s Aftertreatment menu, select Cancel REGEN and press ENTER button to confirm. You can stop regeneration simply by releasing the parking brake. Use this procedure in order to move the vehicle in a safe area.

If regeneration is interrupted, it is very important to reinitiate the regeneration as soon as possible.

**SELECTIVE CATALYTIC REDUCTION UNIT**

Selective Catalytic Reduction (SCR) is a technology that uses Diesel Exhaust Fluid (DEF) and a catalytic converter to reduce nitrogen oxides (NOx) emissions.

SCR is an exhaust aftertreatment system that injects small amount of DEF into the exhaust gas between the DPF and the selective reduction catalytic converter. DEF turns to ammonia and carbon dioxide when heated. The exhaust stream then passes over a catalyst, the ammonia reacts with the NOx to form nitrogen and water vapor.

The basic elements of the SCR system consist of a 15.9 gallons (60 liters) DEF tank complete

with pump, lines and heating system, a dosing injector, a catalytic converter and the control and monitoring system.

### Diesel exhaust fluid DEF

When handling DEF solution, it is important that electrical connectors to be connected or well encapsulated, otherwise there is a risk that the DEF will cause oxidation that cannot be removed. Water or compressed air will not help, since DEF quickly oxidizes certain metals. If a disconnected connector comes into contact with the DEF solution, it must be replaced immediately to prevent the DEF solution from creeping further into the copper wiring, which takes place at a speed of about 2.4 in (60 mm) per hour.



### CAUTION

Diesel Exhaust Fluid (DEF) is a nontoxic aqueous solution of urea (32.5%) and ultra-pure water (67.5%). Urea is a compound of nitrogen that turns to ammonia when heated. The fluid is non flammable, and is not dangerous when handled as recommended. However, it is highly corrosive to certain metals, especially copper and brass.

When detaching hoses and components, do not spill DEF on disconnected or unsealed connectors. If DEF is spilled on a disconnected or unsealed connector, the connector must be removed immediately and replaced.

Things to know about spilt diesel exhaust fluid (DEF):

- If urea solution comes into contact with the skin, rinse with plenty of water and remove contaminated clothing.
- If urea solution comes into contact with the eyes rinse for several minutes and call for medical help if necessary.
- If inhaled breathe fresh air and call for medical help if necessary.
- Do not allow the DEF solution to come into contact with other chemicals.
- The DEF solution is not flammable. If the DEF solution is exposed to high temperatures, it breaks down into ammonia and carbon dioxide.

- The DEF solution is highly corrosive to certain metals, including copper and aluminum.
- If the DEF solution is spilled onto the vehicle, wipe off the excess and rinse with water. Spilled DEF solution can form concentrated white crystals on the vehicle. Rinse off these crystals with water.



### WARNING

DEF spilt onto hot components will quickly vaporize. Turn your face away!







### Diesel Exhaust Fluid (DEF) Consumption

DEF consumption is related to fuel consumption. In order to meet EPA2010 requirements, DEF tanks are sized so one refill will be necessary every two refills of the fuel tank.

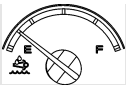

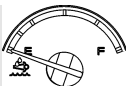

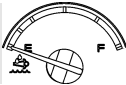
### Selective catalytic reduction – Driver warning and inducement

SCR system components must not be removed, altered or modified in any way. In order to protect the SCR system from tampering, inducement measures will occur if the following states are detected:

- Disconnection of DEF tank level sensor
- Blocked DEF line or dosing valve
- Disconnection of DEF dosing valve
- Disconnection of DEF pump
- Disconnection of SCR wiring harness
- Disconnection of NOx sensor

DEF TANK LEVEL			
DRIVER WARNING AND INDUCEMENT			
CONDITION	TELLTALE LIGHT AND MESSAGE IN THE DRIVER INFORMATION DISPLAY		INDUCEMENT
<p>There is only 2.6 gallons (10 liters) of DEF remaining in the tank. The actual DEF level gauge indicates about 12% DEF remaining.</p> 	 lighted solid	message: <ul style="list-style-type: none"> <li>• DEF LOW</li> </ul>	None
<p>There is only 0.8 gallons (3 liters) of DEF remaining in the tank. The actual DEF level gauge indicates "Empty".</p> 	 Flashing	message: <ul style="list-style-type: none"> <li>• DEF TANK NEAR EMPTY</li> <li>• ENGINE IN DERATE</li> <li>• ADD DEF</li> </ul>	Gradual engine torque reduction of 25%
<p>The DEF tank is empty and the DEF level gauge indicates "Empty".</p> <p>moreover</p> <p>a diesel fuel refueling is done and the diesel fuel level gauge increases <u>more than</u> 15% (approx. 34 gallons/130 liters)</p> <p>or</p> <p>the vehicle remains stationary (speed=0) for 20 min. with engine OFF or at idle.</p> 	 Flashing	message: <ul style="list-style-type: none"> <li>• VEHICLE SPEED LIMITED TO 5 mph (8 km/h)</li> <li>• ADD DEF</li> </ul>	<p>Vehicle road speed limited (RSL) to 5 mph (8 km/h)</p> <p>The vehicle has to remain stationary before 5 mph (8 km/h) road speed limit becomes active</p> <p><i>NOTE: Repeated acts of tampering will result in more severe inducement.</i></p>

<b>DEF QUALITY</b>			
<b>DRIVER WARNING AND INDUCEMENT</b>			
CONDITION	TELLTALE LIGHT AND MESSAGE IN THE DRIVER INFORMATION DISPLAY	INDUCEMENT	
Poor DEF quality detected (dilution)  Emission of initial diagnostic troubleshooting code (DTC).	<b>CHECK</b>  lighted solid	message: <ul style="list-style-type: none"> <li>• SCR PERFORMANCE LOW</li> <li>• ENGINE WILL DERATE SOON</li> </ul>	None
1 hour after poor DEF quality detection (chronological time after the initial tampering DTC emission).	<b>CHECK</b>  lighted solid	message: <ul style="list-style-type: none"> <li>• SCR MALFUNCTION</li> <li>• ENGINE IN DERATE</li> <li>• CHECK SCR TO AVOID 5 mph (8km/h) LIMIT</li> </ul>	Gradual engine torque reduction of 25%.
3 hours after poor DEF quality detection (chronological time after the initial tampering DTC emission)  moreover  a diesel fuel refueling is done and the diesel fuel level gauge increases <u>more than</u> 15% (approx. 34 gallons/130 liters)  or  the vehicle remains stationary (speed=0) for 20 min. with engine OFF or at idle.	<b>CHECK</b>  lighted solid	message: <ul style="list-style-type: none"> <li>• SERVICE SYSTEM SCR</li> <li>• 5 mph (8km/h) LIMIT</li> </ul>	Vehicle road speed limited (RSL) to 5 mph (8 km/h)  The vehicle has to remain stationary before 5 mph (8 km/h) road speed limit becomes active
<p><b>Conditions to temporarily exit the 5 mph (8 km/h) road speed limit inducement</b></p> <p><b>First engine restart:</b> At the first engine restart, the engine returns to the 25% torque reduction until proper DEF quality evaluation occurs. If poor DEF quality is detected during the next monitoring cycle then the 8 km/h (5 mph) speed limitation will resume after vehicle is stationary for 20 minutes.</p> <p>After the second engine restart, Premium Tech Tool is required to exit the 5 mph (8 km/h) RSL.</p> <p><b>With Premium Tech Tool:</b> Invoke 25% torque reduction until proper DEF quality evaluation occurs. If poor DEF quality is detected during the next monitoring cycle then the 8 km/h (5 mph) speed limitation will resume after vehicle is stationary for 20 minutes.</p> <p>Repeating poor DEF quality within 40 hours since correction will resume the inducement stage.</p> <p>If correction occurs during road speed limitation, repeating poor DEF quality will invoke immediate 25% engine torque reduction, then 5 mph (8 km/h) road speed limitation upon vehicle stationary state of 20 minutes.</p>			

SCR SYSTEM TAMPERING		
DRIVER WARNING AND INDUCEMENT		
CONDITION	TELLTALE	INDUCEMENT
Tampering detected Tampering DTC pending.	 lighted solid	None
Tampering detected Tampering DTC confirmed.	 lighted solid	None
1 hour after tampering DTC detection (chronological time after the initial tampering DTC emission).	 lighted solid	Gradual engine torque reduction of 25%.
3 hours after tampering DTC detection (chronological time after the initial tampering DTC emission).  moreover  a diesel fuel refueling is done and the diesel fuel level gauge increases <u>more than</u> 15% (approx. 34 gallons/130 liters)  or  the vehicle remains stationary (speed=0) for 20 min. with engine OFF or at idle.	 lighted solid	Vehicle road speed limited (RSL) to 5 mph (8 km/h)  The vehicle has to remain stationary before 5 mph (8 km/h) road speed limit becomes active.
Correcting the SCR tampering condition will exit inducement.  Repeating SCR tampering within 40 hrs since correction will resume the inducement at the same inducement stage and timer status existing at the time of correction.  If correction occurs during road speed limitation, repeating tampering will invoke immediate 25% engine torque reduction, then 5 mph (8 km/h) road speed limitation upon vehicle stationary state of 20 minutes.		

## DRIVER INFORMATION DISPLAY (DID) MENUS

There are Driving and Non-Driving menus. Several sub-menus are password-protected while the vehicle is parked. The Non-Driving menu is accessible only when the vehicle is parked.

### “DRIVING” MODE MENUS

#### Gauges

1. Current Gear Position (I-Shift)
2. Outside Temperature
3. Engine Oil Temperature
4. Transmission Fluid Temperature
5. Compass
6. Accessories Air Pressure
7. A/C Compressor Pressure
8. Battery Voltage
9. Allison Transmission Oil Life

#### Fuel Data

1. Fuel flow
2. Trip Fuel Used
3. Distance to Empty

#### Time-Distance

1. Time and Date
2. Alarm Clock
3. Distance to Destination
4. Average Trip Speed
5. Estimated Time of Arrival (ETA)

#### Vehicle Messages

#### Reset Trip Data

### “NON-DRIVING/STATIONARY” MODE MENUS

#### Display Settings

1. Language
2. Units
3. Time/Date
4. Favorite Display Setting
5. Display Light
6. Change Password

#### Diagnostics

1. View Active Faults
2. View Inactive Faults
3. Cluster Selftest
4. Part Number
5. Reset Inactive Faults
6. Vehicle Tests

#### Pre-Trip Assistant

1. Exterior Light Inspection
2. Air Leakage Monitor

#### Datalog

1. Vehicle ID
2. Total Data
3. Trip Data
4. Reset Trip Data

#### Aftertreatment

1. Request Parked REGEN
2. ATS Status
3. Cancel REGEN

#### Password

1. Enter Password

## GAUGES

There are several gauges in this menu. The gauges are used to view current status of important functions in the vehicle.

### 1. Current Gear Position (I-Shift transmission)

Indicates the current gear position selected on the I-Shift transmission.

D= drive  
N= neutral  
R= reverse  
M= manual

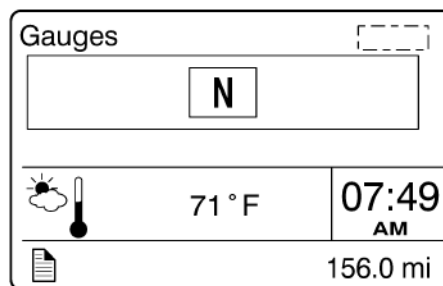

### 2. Outside Temperature

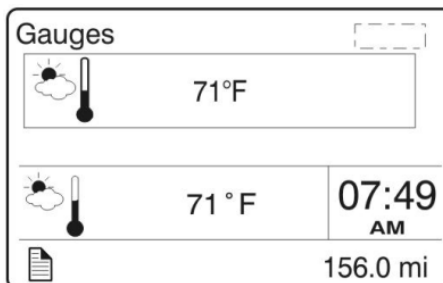



**3. Engine Oil Temperature**

Selection this gauge will display the engine oil temperature.

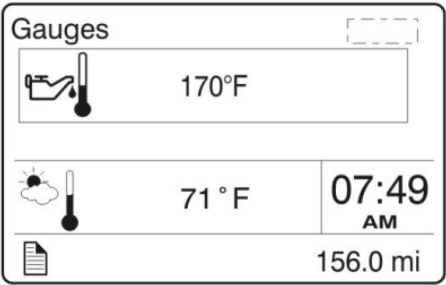

**4. Transmission Fluid Temperature**

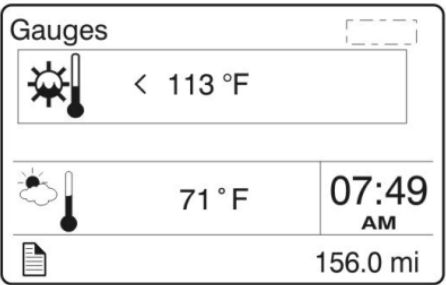

**5. Compass**

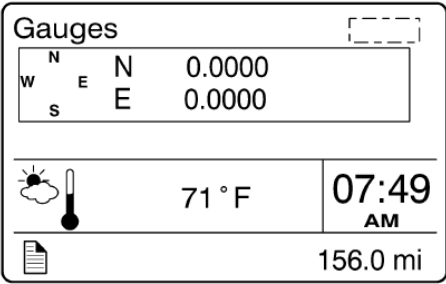

**6. Accessories Air Pressure**

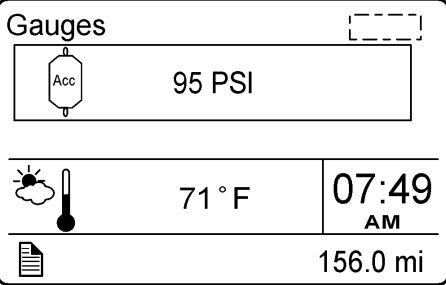

**7. Battery Voltage**

Displays the current 12-volts and 24-volts system voltage.

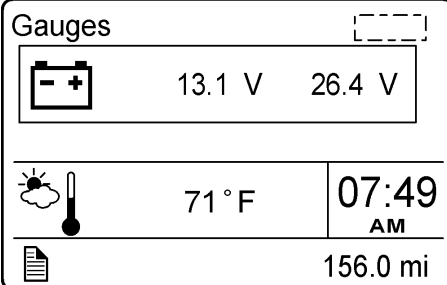

**8. A/C Compressor Pressure**

Displays the A/C compressor suction pressure value (LoS=low side) and discharge pressure value (HiS=high side).

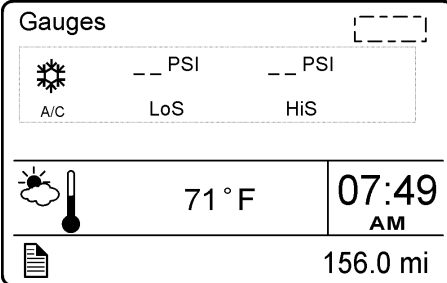

**9. Allison Transmission Oil Life**

Displays the percentage of the calculated remaining life of the transmission oil. New oil is displayed as 99%. Refer to Appendix C for more details.

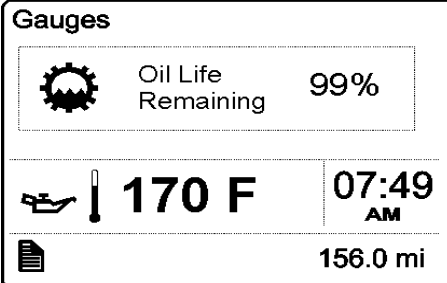

**FUEL DATA**

The Fuel Data menu provides information on the fuel consumption of the vehicle in various situations. For example, how much fuel has been used, how much fuel is remaining, how much fuel is remaining before refueling the vehicle.

**1. Fuel Flow (gph)**

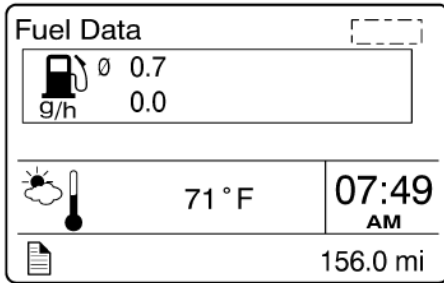

**2. Trip Fuel Used**

Indicates the total fuel consumption since the last reset.

*NOTE: Use Reset function before each new trip.*

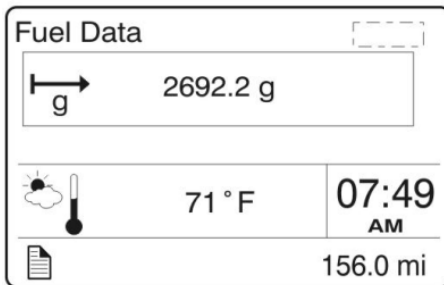

**3. Distance to Empty**

Indicates the distance that can be traveled with the quantity of fuel that remains in the tank.

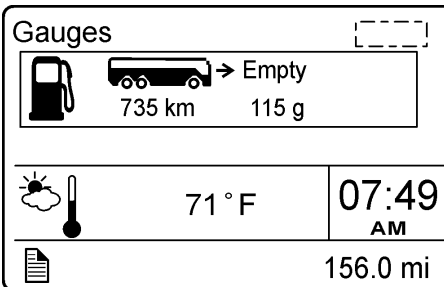

**TIME/DISTANCE**

The time and date can be set in the Time/Distance menu. The alarm clock can also be set from this menu. Following the alarm clock menu is the Distance to Destination selection, which allows the operator to see the distance to travel before destination. Average trip speed is also shown. By specifying the distance to your destination, the vehicle can calculate the estimated time of arrival (ETA).

**1. Time And Date**

Adjust time and date with this menu. The instrument cluster has its own internal battery, so the date and date setting is keep in memory even if the vehicle's battery is disconnected.

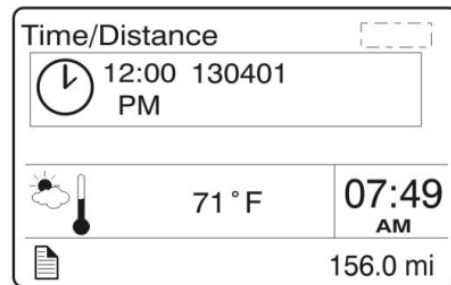

**2. Alarm Clock**

Use this function to program an alarm on the instrument cluster clock.

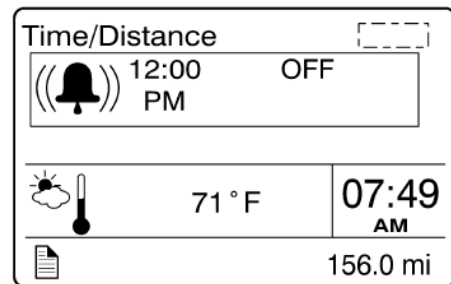

**3. Distance to Destination**

If the distance to be traveled before reaching the destination was entered in Estimated Time of Arrival (ETA) menu, this function will display the remaining distance to be traveled before reaching destination. Two independent driving distances can be entered, for example, 1 could be for leg 1 distance and 2 would be the entire trip.

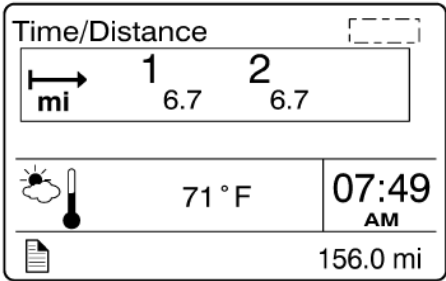

**4. Average Trip Speed**

This function displays the average speed for the current travel. The average trip speed is calculated as the distance traveled divided by the time the engine has been running (since the last reset). Two average trip speeds can be measured. Use Reset function before each new travel to start new measurements.

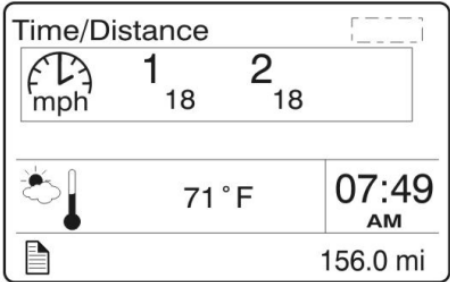

**5. Estimated Time of Arrival (ETA)**

This function will display the estimated time of arrival if the distance to be traveled is entered first, in this menu. To set distance to be traveled, press ENTER and enter the distance left to drive in mile or km using the DID control buttons.

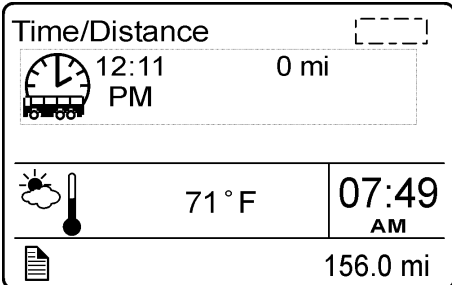

**VEHICLE MESSAGES**

Use this function to consult the vehicle active messages that were previously displayed as pop-up messages and then acknowledged. When consulting a message, the corresponding STOP, CHECK or INFORMATION warning light will illuminate. Scroll through the messages using the up/down button. Press ESC button to return to main menu.

**RESET TRIP DATA**

When the Reset Trip Data menu is open, pressing and holding down the Enter button for more than 1 second resets the functions listed below. This function will permit to the system to calculate new value from the point of resetting.

- Trip Fuel Used
- Average Trip Speed

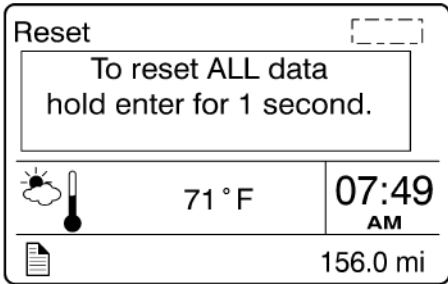

**NON-DRIVING/STATIONARY MODE MENUS**

**DISPLAY SETTINGS**

The Display Settings menu is used to change languages and units. The password, time and date can also be changed. The backlight and contrast of the display screen can be adjusted.

**1. Language**

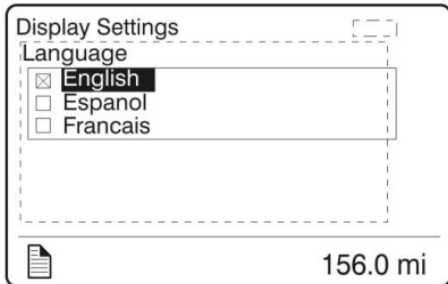

**2. Units**

Use this function to select desired unit formats for:

- Distance (miles or km);
- Fuel consumption (km/l, l/100km, mpg US or IMP);
- Temperature (°C or °F).

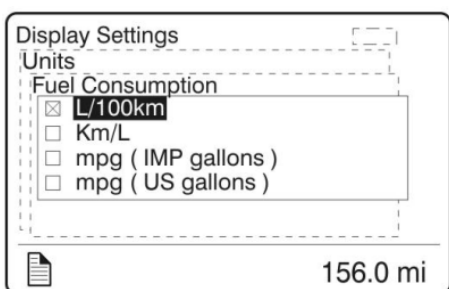
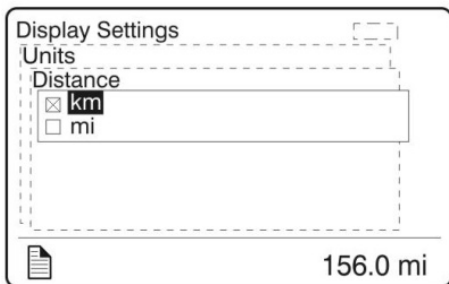

**3. Time/Date**

Select the time and date format (am, pm, 24h) using this function.

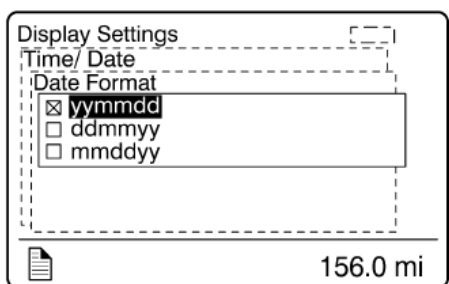

**4. Favorite Display Setting**

Use this menu to select your favorite display gauges 1, 2 and 3 and replace the default gauges. On vehicles provided with the I-Shift transmission, Favorite Display Gauge 3 cannot be edited as it is kept for display of the transmission status.

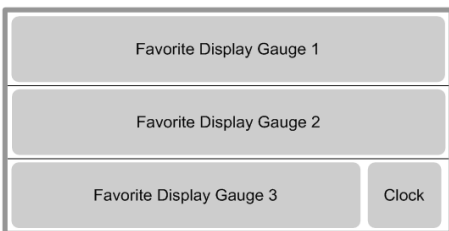

Example: You wish to display the engine oil temperature at the Gauge 1 position.

1. Use UP/DOWN button until Gauge 1 position is selected.
2. Press ENTER button to confirm.
3. Use UP/DOWN button to scroll through the available gauges. When the engine oil temperature gauge is displayed, press ENTER button to confirm (repeat steps 1-3 to change Gauge 2 and Gauge 3 if needed).

**5. Display Light**

The Display Light menu has three sub-menus:

- Contrast  
Adjust the contrast with the UP/DOWN button and press ENTER button to confirm.
- Backlight  
In this menu, the display lighting can be adjusted relative to other instrument lighting with the UP/DOWN button.
- Night/Day  
Use the Night/Day menu to choose a dark background with light text and images or a light background with dark text and images. Press ENTER button to toggle between Night and Day.

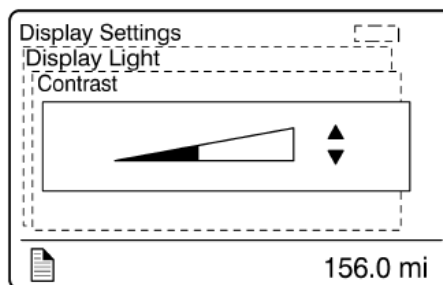

**6. Change Password**

Use this menu to change the current password. This menu is only accessible if the correct password is entered. The default password is 0000.

1. Mark which password is to be changed with the display UP/DOWN button.
2. Confirm with ENTER button.
3. Set the first digit with the UP/DOWN button.
4. Step to the next digit using ENTER button.
5. Step backwards with ESC button.

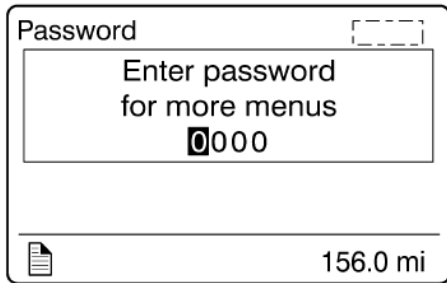

**DIAGNOSTICS**

The Diagnostics menu enables fault tracing on the control units in the vehicle to check for faults. Instrument tests are available to check the telltales, gauges, display and speaker. The part number of a control unit can be identified in the part number menu.

**1. View Active Fault**

A list of the control units on the vehicle is displayed. Use this function to check for active faults on specific control units.

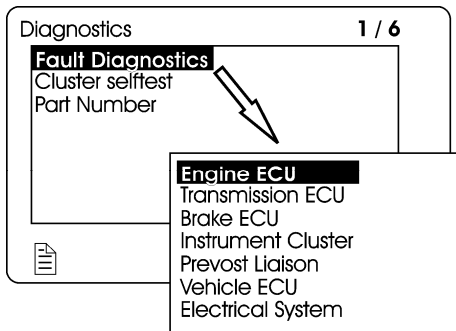

**2. View Inactive Fault**

Use this function to check for inactive faults on specific control units.

**3. Cluster Selftest**

Use this menu to check proper functioning of the following components:

- Telltale lights
- Analog gauges
- Display
- Speakers

The following table describes the available tests. To cancel a test, press the ESC button).

Telltale lights test	Telltale lights illuminate for approximately five seconds. Press the Esc button to cancel the test.
Analog gauges	The indicators move forwards and backwards between the end positions. They do not show any particular value. This is just a check to confirm that the indicators move, and to make sure the operators are working. Press the Esc button to cancel the test.
Display test	The entire display lights up until the Esc button is pressed.
Speaker Test	A sound is emitted through the speakers. Press the Esc button to cancel the test.

**4. Part Number**

A list of the control units on the vehicle with their part numbers is displayed in the Part Number menu.

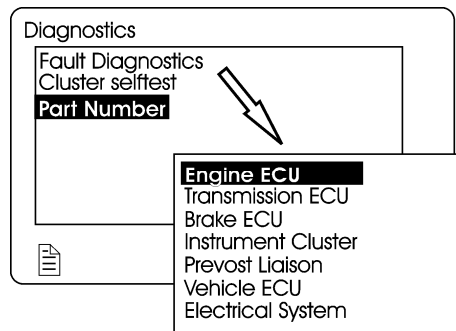

**5. Reset Inactive Faults**

Use this menu to delete an inactive fault for a particular control unit. Note: it is not possible to delete inactive faults of the Engine ECU.

**6. Vehicle Test**

Use this menu to perform tests of the dashboard switches. You can also test some electrical components with this menu (electrical motors, contactors, etc.). For more information, refer to section 06: Electrical, under "Test mode for electric motors" paragraph of the Maintenance Manual.

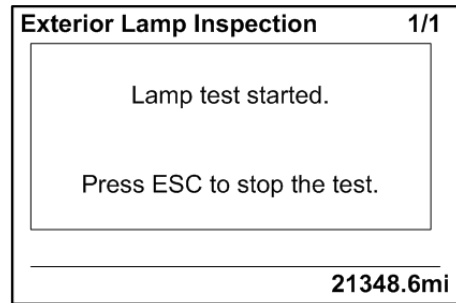
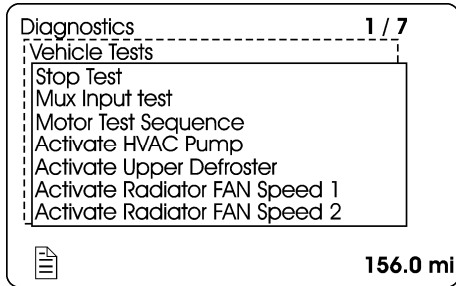

**PRE-TRIP ASSISTANT (option)**

The Pre-Trip Assistance option is a tool to assist the driver in completing the pre-trip inspection of the vehicle. This option is not a substitute for a complete pre-trip inspection. If any system of the vehicle does not pass inspection, the error must be corrected before operating the vehicle. The available pre-trip tests include the Exterior Light Inspection check, and the Air Leakage check.



**1. Exterior Light Inspection**

The Exterior Light Inspection check repeatedly turns all exterior lights on/off for the vehicle. This allows the operator to start the test, exit the vehicle and do a visual check that all exterior lighting is functioning properly.

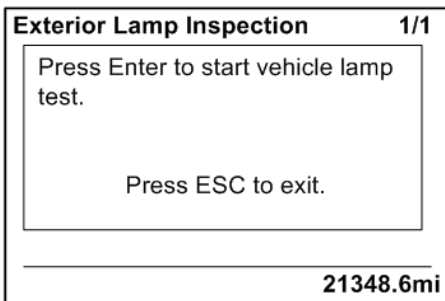

**2. Air leakage Monitor**

The Air Leakage check allows the driver to accurately measure the amount of air pressure drop in the front and rear brake air systems. After selecting this test from the DID, you are prompted to apply the service brake for 60 seconds. After applying and holding the service brake for 60 seconds, the DID will display the amount of pressure drop in the brake system.

Before starting the test through the DID, complete the following:

- a. Start the engine and check that the brake systems air pressure is greater than 100 psi.
- b. Turn engine off.
- c. Release the brakes and allow the system to settle (air gauge needle stops moving).
- d. Press the ENTER button to start the test.

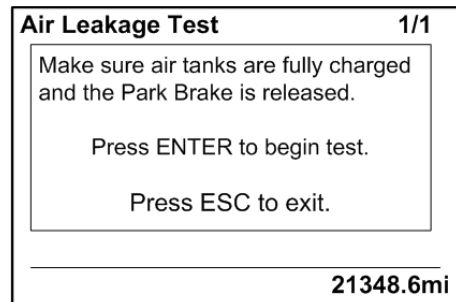

- e. If the air tanks pressure is too low to perform the test (pressure must be greater than 100 psi), the following messages will appear.

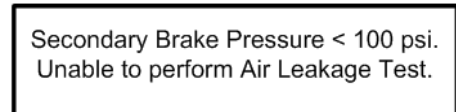
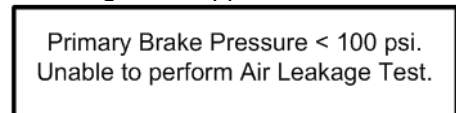

- f. You must press and hold brake pedal for 60 seconds, as instructed.

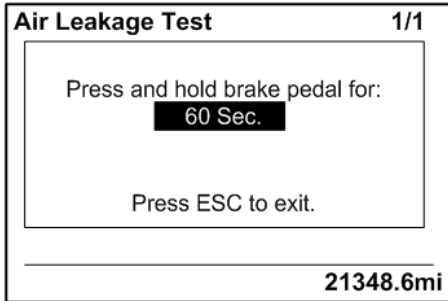

- g. Once the brake pressure test is completed the pressure leak test results are displayed.

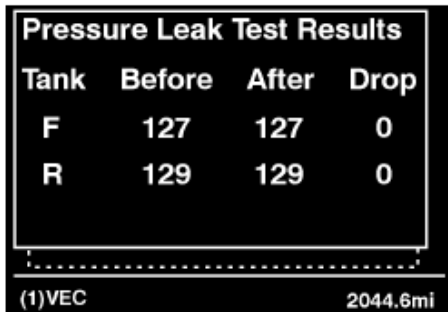

**DATA LOG**

**1. Vehicle ID**

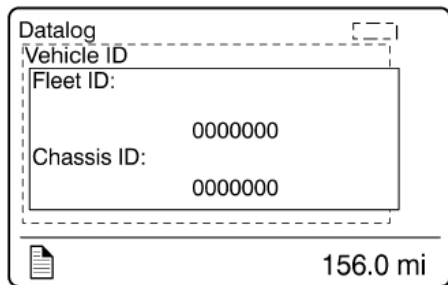

**2. Total Data**

Total Data menu indicates the accumulated engine values that have been logged during the lifetime of the engine ECU.

Available information:

- Total distance traveled
- Total fuel used
- Total engine hours
- Total idle time
- Total PTO hours
- total engine revolutions

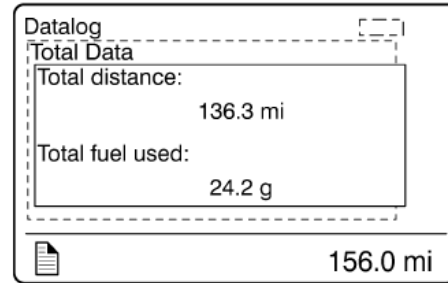

**3. Trip Data**

This menu displays the trip information listed below. This function must be reset before each measurement (before each new trip or leg) using the Reset Trip Data menu.

Available information for the trip or leg is:

- Trip distance (miles or km)
- Trip fuel average (mpg, liter/100km; km/liter)
- Trip fuel used (gallons or liters)
- Trip duration on cruise control (hours)
- Trip duration with engine rpm greater than economy rpm (hours)
- Trip duration while engine rpm is greater than the desire maximum rpm RPM Limit set in Fleet Limits sub-menu (hours)
- Trip fuel used with engine rpm greater than the economy rpm (gallons/liters)
- Trip average speed (mph, km/h)
- Trip duration with speed greater than the maximum desired speed as set in Fleet Limits sub-menu (hours)
- Trip engine hours
- Trip duration on engine idle (hours)
- Trip fuel used while in engine idle (gallons, liters)

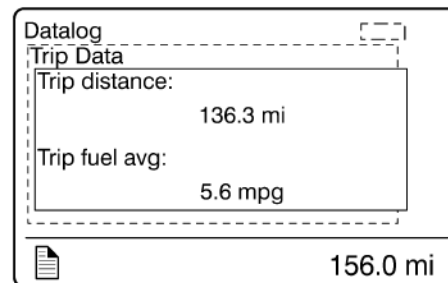

**4. Reset Trip Data**

This menu can only be accessed if the correct password has been entered.

Use this function to reset measurements of the Trip Data menu before each new trip or leg.

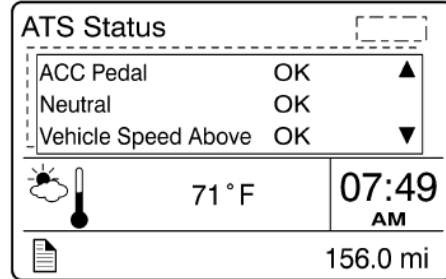
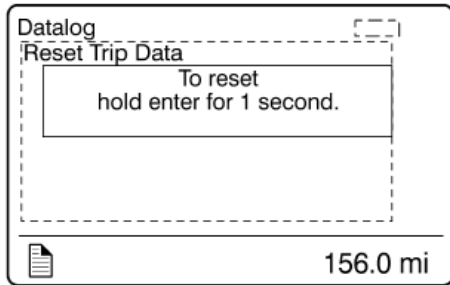

**AFTERTREATMENT**

This menu permits to the driver to initiate a stationary regeneration, to check the status of the aftertreatment system and to interrupt regeneration.

**1. Request Parked REGEN**

Use this function to initiate a stationary (parked) regeneration.

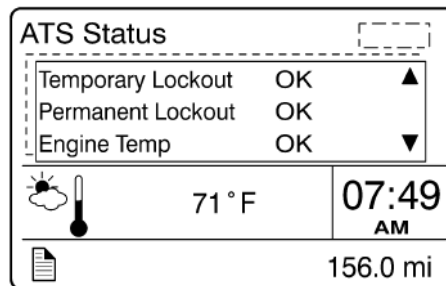
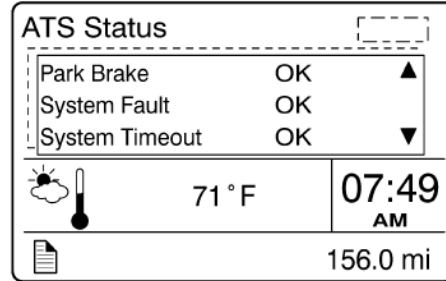
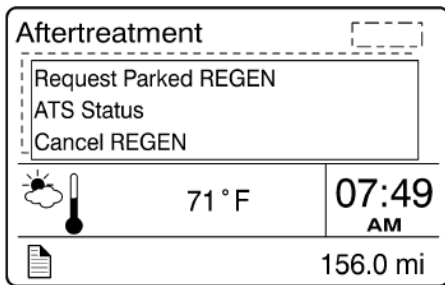

**2. ATS Status**

The Aftertreatment status sub-menus provide information about the conditions required for performing regeneration. The status can be OK (regeneration allowed), CHECK (regeneration not allowed) or N/A (not applicable). When ATS Status is selected, the following sub-menus are available.

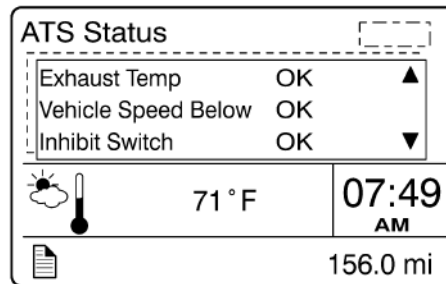
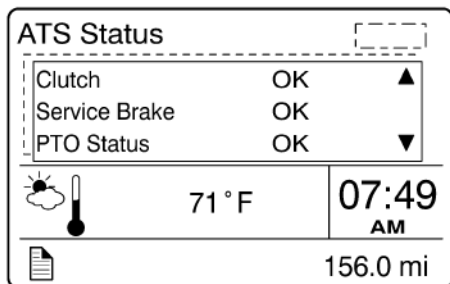

**Soot Level Gauge**

From the ATS Status sub-menu, you can view the soot level for the Aftertreatment system. When the soot level is high, regeneration is necessary. L1, L2, L3 and L4 under the scale correspond to Level 1 up to Level 4 (see Diesel particulate filter clogging sequence – Engine indicator lamp).



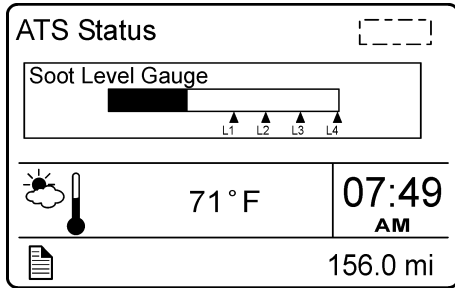

**3. Cancel REGEN**

From the Aftertreatment main menu, you can cancel a REGEN cycle.



**PASSWORD**

Certain functions are password-protected. These passwords give the user access to all password-protected functions. The default password is 0000.

**1. Password**

The following menus are password-protected and marked with a key symbol in the menus:

- Change Password
- Fleet ID
- Reset Trip Data
- Fault Diagnostics
- Inactive Faults

**ALLISON TRANSMISSION ELECTRONIC CONTROLS**

The Allison Transmission electronic controls have four major elements: The Transmission Control Module (TCM), the Throttle Position Sensor (TPS), speed sensors and the transmission shift selector control pad. Refer to "Controls & Instruments" chapter. These components work together to electronically control the functions of the transmission. The throttle sensor, speed sensors and shift selector transmit information to the TCM. The TCM processes this information and then sends signals to actuate specific solenoids located on the control valve body in the transmission. The

action of the solenoids affects hydraulic circuits, which in turn control the upshifts, downshifts, and lock-up functions. In addition to controlling the operation of the transmission, the transmission electronic controls monitor the system for abnormal conditions.

When one of these conditions is detected, the Allison electronic control system is programmed to automatically respond in a manner which is safe for the driver, the vehicle and the transmission. The Allison electronic control system turns ON the CHECK TRANS light on the dashboard, which serves as a fault indicator.

To enhance troubleshooting and to allow interrogation of the TCM for valuable service information, the shift selector display on the transmission control pad or an optional diagnostic tool can be used. For information about reading and interpreting diagnostic codes, refer to Appendix C, "Allison Transmission Diagnostic Troubleshooting Codes (DTC)".

**TRANSMISSION RETARDER**

The transmission retarder is an optional device that helps to reduce the speed of a vehicle. It improves vehicle control, increases driving safety and permits more economical operation. The retarder provides slowing power when it is most needed, such as when descending mountain roads, in stop-and-go traffic and on crowded freeways.

The transmission retarder is a vehicle-slowng device, not a vehicle-stopping device. It is not a substitute for the service braking system. The service brake must be used to bring the vehicle to a complete stop.

The retarder is provided with control buttons on the steering wheel and a lever on the steering column (refer to "CONTROLS AND INSTRUMENTS" chapter).

***NOTE***  
*Extended use will raise the temperature of the transmission oil.*

The retarder helps to reduce speed on grades without using the vehicle's conventional service braking system. A retarder greatly increases the service life of brake pads and discs, resulting in reduced brake maintenance costs.

***NOTE***  
*The stoplights automatically illuminate when the vehicle is slowing down due to the application of the transmission retarder.*

**NOTE**

For vehicles equipped with the Antilock Braking System (ABS), as the wheels start to lock-up on slippery roads, the output retarder automatically deactivates until the wheels roll freely.

**ENGINE BRAKE****WARNING**

A vehicle speed retarding device (such as engine brake) is not intended to replace the service brake systems on your vehicle nor intended to bring your vehicle to a stop. A vehicle speed retarding device is only intended to reduce the speed of your vehicle under certain conditions.

Several types of engine brake can be installed or are standard on certain engines. All are used to reduce wear on the vehicle brake linings.

**WARNING**

When descending significant grades, use the service brake as little as possible. If the engine does not slow the vehicle to a safe speed, apply service brake and shift to a lower range. Let the engine (and engine brake) slow the vehicle. Keep brakes cool and ready for emergency stopping.

**NOTE**

When driving with cruise control, the exhaust brake automatically engages if the selected cruise speed is exceeded by approximately 4 mph (7 km/h). The exhaust brake is then disengaged when the speed has returned close to selected cruise speed, provided that the engine brake was previously enabled.

**NOTE**

On vehicles equipped with the I-Shift transmission, any increase of the braking power, such as from Auto mode (A) to Engine Brake Low (1), from Auto mode (A) to Engine Brake High (2) or from Engine Brake Low (1) to Engine Brake High (2) will deactivate the cruise control.

**EXHAUST BRAKE**

The exhaust brake provides about 66 % of the total available engine braking power. The exhaust brake is most effective at high engine speeds (1500 to 2300 rpm). The exhaust brake is automatically disengaged if the engine speed drops to or below 1100 rpm.

This engine brake mode provides low braking power by containing the exhaust gases in the exhaust manifold, thereby making the engine work against the back pressure. This provides a retarding force on the drive wheels.

The following must be in effect for the exhaust brake function:

- The engine brake switch found on the dashboard is set to the ON position
- The **Retarder/Engine Brake Low** (1) button on the steering wheel controls is depressed
- Accelerator pedal is fully released
- Engine speed exceeds 1150 rpm

**VOLVO ENGINE BRAKE (VEB)**

VEB has a higher braking effect than the exhaust brake. This engine brake mode is most effective at high engine speeds (1500 to 2300 rpm). It is automatically disengaged if engine speed drops below 1000 rpm.

The VEB is engaged using the **Retarder/Engine Brake High** (2) button located on the steering wheel. It works together with the exhaust brake to provide to provide 100 % of the maximum available braking power.

The engine brake control on the steering wheel is achieved by the use of three buttons: OFF, LOW (1) and HIGH (2). With the Engine Brake LOW (1) button depressed, only the exhaust brake is engaged. With the Engine Brake HIGH (2) button, both the exhaust brake and the compression brake are activated.

VEB = Exhaust Brake + Compression Brake

The following must be in effect for the VEB to function:

- The engine brake switch found on the dashboard is set to the ON position
- The **Retarder/Engine Brake Low** (2) button on the steering wheel controls is depressed
- The vehicle speed is over 7.5 mph (12 km/h)

- Engine temperature is greater than 110°F (43°C)
- Accelerator pedal is fully released
- Engine speed exceeds 1150 rpm

### ENGINE BRAKE – AUTO MODE (A) (WITH I-SHIFT TRANSMISSION ONLY)

The Auto mode (A) supplies 66 % of the maximum available braking power. To engage the engine brake Auto mode (A), set the engine brake switch to the ON position.

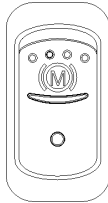

Engine Brake switch



When in Auto mode (A), the engine brake engages simultaneously with service brakes upon pressing of the brake pedal. The engine braking power varies with the brake pedal position. The further the pedal is depressed, the more total braking power is provided.

To switch to the engine brake Auto mode (A) when the engine brake is already engaged in Low (1) or High (2) braking power, simply press the Engine Brake OFF switch located on the steering wheel.

### ANTILOCK BRAKING SYSTEM (ABS) – AUTOMATIC TRACTION CONTROL (ATC) – ELECTRONIC STABILITY CONTROL (ESC)

The purpose of the Antilock Braking System (ABS) is to maintain vehicle stability and control during braking and to minimize the stopping distance in any road condition.

On slippery roads and more generally in emergency situations, over-braking frequently induces wheel locking. Wheel locking greatly increases braking distance on any road surface. Locked wheels also impede directional

control and cause severe tire abrasion. An anti-lock braking system provides maximum braking performance while maintaining adequate control on slippery roads.

The basis of ABS is constant monitoring of wheel parameters during braking. Sensors on each wheel of the front and drive axles constantly measure wheel speed during braking. This information is transmitted to a four-channel electronic processor which senses when any wheel is about to lock. Modulating valves quickly adjust brake pressure (up to 5 times every second) to prevent wheel lock. Each wheel is therefore controlled according to the available grip.

In this way, the vehicle is brought to a stop in the shortest possible time while remaining stable and under the driver's control.



### CAUTION

Vehicles following ABS-equipped vehicles may not be able to brake as fast on slippery roads. Whenever possible, warn other drivers by depressing the brake pedal lightly several times before braking.

In addition to the ABS function, advanced models of Bendix controllers provide an **Automatic Traction Control (ATC)** feature. Bendix ATC can improve vehicle traction during acceleration, and lateral stability while accelerating through curves. ATC utilizes **Engine Torque Limiting (ETL)** where the ECU communicates with the engine's controller and/or **Differential Braking (DB)** where individual wheel brake applications are used to improve vehicle traction.

Advanced models of Bendix controllers also provide ABS-based stability features referred to as **ESC® Electronic Stability Control**.

The Bendix ESC system is an ABS-based stability system that enhances vehicle stability by both reducing engine throttle and by applying vehicle braking based on actual vehicle dynamics. Accordingly, the ESC system is available only on specific approved vehicle platforms after vehicle application and development efforts and validation testing. Only certain limited variations of an approved vehicle platform are permitted without further validation of the ESC system application.

**DANGER**

In the case where a vehicle equipped with the ESC system pulls a trailer, the latter must be equipped with ABS.

ESC stability system consists of Yaw Control (YC) and Roll Stability Program (RSP) features.

**CAUTION**

Even with ESC-equipped vehicles, the driver remains responsible for ensuring vehicle stability during operation.

### **DRIVER CONTROLLED DIFFERENTIAL LOCK (DCDL)**

By actuating the electric switch, the driver can lock or unlock differential action.

The purpose of the DCDL is to provide maximum vehicle traction and control on unfavorable road or highway surfaces. When the DCDL is actuated, a clutch collar completely locks the differential case, gearing, and axle shafts together. This feature maximizes traction to both wheels. The lock position will also protect against spinout damage to the differential. The DCDL should not be actuated when favorable road conditions exist.

#### **OPERATION TIPS**

1. The DCDL can be locked or unlocked if the vehicle is standing still or moving at a constant low speed when the wheels are not spinning, slipping, or losing traction.
2. When the DCDL is locked, operate the vehicle at low speeds. DCDL will not engage and will disengage in speed higher than 5 MPH (8 km/h).
3. When the DCDL is locked, the vehicle's turning radius will increase. This condition is called "understeer." The driver must use caution, good judgment and drive at low speeds when operating the vehicle with the DCDL locked.
4. Always unlock the DCDL as soon as the need for maximum traction has passed and the vehicle is traveling on a good road or highway.

5. Do not lock the DCDL when the wheels are slipping or losing traction, or damage to the axle can result.
6. Do not lock the DCDL when the vehicle is traveling down steep grades, or potential loss of vehicle stability could occur.

#### **LOCKING THE DCDL**

When encountering poor road or highway conditions where maximum traction is needed, follow the recommended procedures:

1. Without the wheels spinning, slipping or losing traction, flip the DCDL control switch to the "LOCK" position while maintaining a constant vehicle speed.
2. Let up momentarily on the accelerator to relieve torque on the gearing, allowing the DCDL to lock.
3. When the DCDL is fully locked, the vehicle will have an "understeer" condition when making turns. Proceed cautiously over poor road or highway conditions.

#### **UNLOCKING THE DCDL**

When the vehicle can safely operate and driving conditions have improved, disengage the DCDL following the recommended procedures:

1. Flip the control switch to the "UNLOCK" position, when the vehicle is stopped or when traveling at low speed while the wheels are not spinning, slipping or losing traction.
2. Let up momentarily on the accelerator to relieve torque on the gearing, allowing the DCDL to unlock.
3. Resume driving at normal speed using good driving judgment.

### **RETRACTABLE TAG AXLE**

The standard lifting of the tag axle is controlled by a valve located on the left lateral console. The valve can be switched to either the WHEELS UP or WHEELS DOWN position. The axle will be raised or lowered by air pressure according to the position of the valve switch. Refer to "Controls & Instruments" chapter.

The tag axle service brakes operate only when the tag axle is in the WHEELS DOWN position. When the tag axle is in the WHEELS UP position, the corresponding indicator light will illuminate and a beep will sound to alert the

driver of the tag axle's position. Lifting the tag axle shortens the wheelbase and allows tighter turning. This is very useful in tight maneuvering areas like in a parking lot or when negotiating a tight corner. Raising the tag axle transfers extra weight and additional traction to the drive wheels providing improved control on slippery roads.



## CAUTION

Do not use tag axle in raised position for an extended period. Raising tag axle increases load on the drive axle, suspension and tires.

Do not drive vehicle with tag axle raised when speed is exceeding 12 mph (20 Km/h).

In order to prevent damage to the suspension, always raise the tag axle before lifting the coach.

## VARIABLE ASSISTANCE STEERING GEAR (OPTIONAL)

The steering effort is controlled automatically in relation to vehicle speed. For more information, refer to Maintenance Manual Section 14: Steering.

## KEYLESS ENTRY SYSTEM

By using this system, you can lock or unlock the entrance door and the baggage and service compartment doors. The keyboard is located below the entrance door handle. The master code in the microprocessor/relay module is pre-programmed by the manufacturer and cannot be deleted. Moreover, you can program your own entry code (e.g. a birthday or part of a social security number).

The master code is:

- Printed on the owner's wallet card;
- Printed on three decals, joined to the owner's wallet card;
- Printed on decal affixed to the keyless system microprocessor/relay module in the front console.

When you use the keyless entry system, the keyboard and step lights illuminate.

Do not push the buttons with a key, pencil or any other hard or sharp object as the buttons could be damaged. Although each button is provided with two digits separated by a vertical line, there

is only one contact per button. Press in the center of the button (between the two digits, on the vertical line).

You must unlock the entrance door before you unlock any other baggage or service compartment door. If you let more than five seconds pass between the numbers you press, the system shuts down, and you have to enter your code again. If the keyless entry system does not work properly, use the key to lock or unlock entrance or compartment doors.

## KEYLESS OPERATING INSTRUCTIONS

1. To unlock the entrance door and disarm the anti-theft alarm, enter the permanent factory code or the personal code. After pressing the fifth digit, the door will unlock. During the night, press any button to illuminate the keyboard, and then enter the code.
2. When pressing any button, the keyboard lights up for five seconds and the step lights illuminate for twenty-five seconds.
3. To unlock the baggage and service compartment doors, press button 3|4 within five seconds of entering the code.
4. To lock entrance door, compartments and arm the anti-theft alarm system all at the same time, press buttons 7|8 and 9|0 simultaneously.

## PROGRAMMING A PERSONAL CODE

### NOTE

*To avoid erasing your personal code from the system memory, you should connect the keyless entry system to house batteries, otherwise the code will be erased each time battery main disconnect switches are set to the OFF position.*

You can program one personal code to unlock the entrance door and compartments. This code does not replace the permanent code that is factory programmed into the system. Use your personal code in the same manner that you would use the original code.

Do not choose a code that presents the numbers in sequential order, such as 1|2, 3|4, 5|6, 7|8, 9|0. Studies show that people who idly press the buttons usually press a sequential pattern. Also, do not select a code that uses the same button five times. Thieves can easily figure out these types of codes.

## 100 Other Features

1. Choose and memorize your personal code.
2. Enter the original code, and within five seconds, press button 1|2.
3. Within five seconds of pressing button 1|2, enter your personal code, pressing each button within five seconds of the previous digit. The keyboard light will immediately turn OFF if the code is correctly entered.

The keyless entry system registers your personal code. To unlock the entrance door, you can use either code.

To erase your personal code, enter the original code, press button 1|2, then wait six seconds.

### REMOTE ENTRY TRANSMITTER

Up to four hand held (key fob) transmitters can control electronic door lock system.

**To lock the entrance door and the baggage compartment doors simultaneously and arm the intrusion protection and anti-theft system:**

- Press LOCK  on the transmitter once.

#### **NOTE**

*The intrusion protection and anti-theft system will be set after a 30 seconds delay.*

**To confirm that the entrance door and baggage compartment doors have been locked and that the intrusion protection and anti-theft system is armed:**

- Press LOCK  again within five seconds of the first lock. The front and rear side markers will flash once if the doors have locked. If the entrance door or one of the baggage compartment doors is open, a door ajar signal prevents arming of the system.

**To unlock the entrance door:**

- Press UNLOCK  on the transmitter. This will unlock the door and disarm the intrusion protection and anti-theft system.

**To unlock the baggage compartment doors:**

- Press UNLOCK  a second time within five seconds of the first unlock.

**To set off the personal security alarm:**

- Press the red PANIC  button on any transmitter. The horn will sound and the

marker lights will flash for a maximum of three minutes.

**To deactivate the personal security alarm:**

- Press the red PANIC  button again on any transmitter or turn the ignition key ON.

#### **NOTE**

*The remote entry features will not function when the ignition is in the ON or ACC position.*

### PROGRAMMING TRANSMITTERS

To program additional transmitters or replacing a lost or broken transmitter, all transmitters for a vehicle must be programmed at the same time. The receiver assembly module erases all previous transmitters from memory. When the transmitters are programmed or reprogrammed, the receiver assembly module can store up to four transmitters in memory.

**To program or reprogram transmitters into the remote/keyless entry system, perform the following steps:**

- Make sure that the anti-theft system is not armed or triggered.
- Turn the ignition key from OFF to ON and wait about 10 seconds. If you do not respect this 10 seconds delay, the remote entry transmitters reprogram will not be possible.
- On the dashboard, press the Central Locking System switch 4 times (to lock position) slowly to enter programming mode.
- If the system has successfully entered programming mode, the horn will beep one time.
- Press UNLOCK  on the transmitter. The horn will beep to confirm that the transmitter has been programmed.
- Repeat step 4 for each other transmitters (up to 3 other transmitters).
- Turn ignition OFF to exit programming mode.
- Test each transmitter separately (try all the functions).

## SLIDE-OUT OPERATION

### SAFETY PRECAUTIONS

Before operating both slide-out units, proceed to the following verifications:

- Make sure that the area outside of the slide-out is clear and that there are no persons or objects within 3 feet of the slide-out outside wall. ***Serious personal injury or damage to the vehicle components may occur.***
- Make sure that the area inside the motor home where the room retracts (30" for the front and 24" for the rear slide-out) is free of people or obstacles. ***Serious personal injury or damage to the vehicle components may occur.***
- In temperatures below freezing point, make sure that the entire sliding surface outside the slide-out is free of snow, ice or sleet. ***Failure to clear all ice or snow may seriously damage the inflatable seal.***
- The parking brake must be applied.
- The transmission must be in the "NEUTRAL" position.
- Open a window to avoid slide-out movement restriction.
- Level the vehicle.

### FRONT AND REAR SLIDE-OUT OPERATION

#### Preliminary condition for the slide-out operation

Before extending or retracting the slide-out, please make sure all the following conditions are met:

1. Make sure the air pressure is 110 psi minimum on the auxiliary air pressure gauge.
2. Make sure the parking brake is applied and that transmission is in the "NEUTRAL" position.
3. Turn the ignition key to the "ON" position, start the engine and set the RPM to fast idle.



### CAUTION

Before extending or retracting the slide-out, always open a window to avoid movement restriction and to prevent the motor from stopping in overcurrent because of a vacuum or pressure build up inside the vehicle.

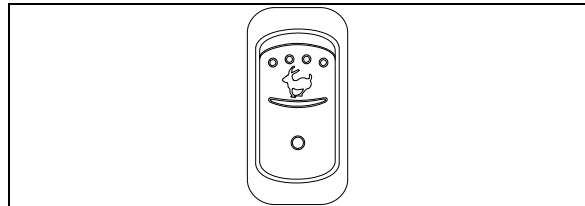

FAST IDLE BUTTON

06264

### Slide-out extending operation

With the ignition switch to the "ON" position and the engine running, press and hold down the handheld control rocker switch to the "OUT" position. The green indicator light "ROOM IN OPERATION" will come on to indicate that the slide-out operation cycle is activated. The following actions will be done in sequence:

- Deflation of the inflatable seal
- Movement of the slide-out to its full "OUT" position

Then releasing the rocker switch will permit the following actions:

- Re-inflation of the seal

When the rocker switch is released, the green indicator light goes out. Note that for safety reasons, releasing the rocker switch will stop the slide-out movement instantly. At any time, releasing the rocker switch from the "OUT" position and pressing it to the "IN" position will reverse the operation.



### CAUTION

The inflatable seals can be re-inflated only when the slide-out is in its full "OUT" or full "IN" position. Do not leave the slide-out in any position other than the full extended or closed position as water infiltration may occur.

**NOTE**

Handheld control green indicator light blinking. A green light blinking indicates an error condition or missing operation condition on the slide-out operated by this handheld control. Refer to SLIDE-OUT TROUBLESHOOTING at the end of this section if that situation occurs.

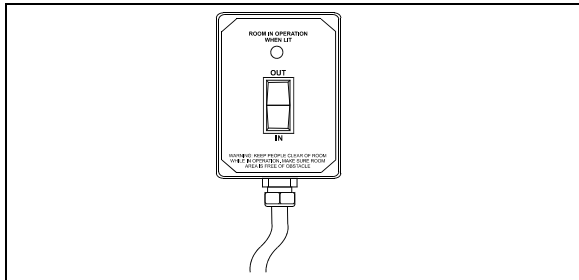

SLIDE-OUT HANDHELD CONTROL

26034

**Slide-out retracting operation**

With the ignition switch to the "ON" position and the engine running, press and hold down the rocker switch to the "IN" position to retract the slide-out. Note that the green indicator light "ROOM IN OPERATION" will come on. When the movement of the slide-out to its full "IN" position is completed, the rocker switch can be released to allow the re-inflation of the seal. The green indicator light goes out as the rocker switch is released. At any time during the slide-out movement, releasing the rocker switch will stop the operation instantly.



**CAUTION**

The inflatable seals can be re-inflated only when the slide-out is in its full "OUT" or full "IN" position. Do not leave the slide-out in any position other than the full extended or closed position as water infiltration may occur.

**SLIDE-OUT MANUAL OVERRIDE PROCEDURE**

In case of power retracting system failure, it is possible to use the manual override procedure to retract or extend the slide-out.

The manual override procedure consist in rotating the slide-out motor shaft extension using a cordless power drill with a 3/8" hexagonal bit.

However, it is very important to follow all the instructions very carefully to assure that the

inflatable seal or the retraction mechanisms are not damaged.

**Preliminary conditions for manual override procedure**

Before using the slide-out manual override procedure, make sure that the problem cannot be solved by one of the following simple checks:

- Make sure that none of the breakers are tripped (the breakers are located inside the VEC on the slide-out control panel and the main slide-out breaker is located in the engine R.H. side access compartment).
- Make sure the barking brake is applied and that transmission is in the "NEUTRAL" position.
- Make sure the voltage is high enough by running the engine at fast idle or having the battery charger connected.



**CAUTION**

Before extending or retracting the slide-out, always open a window to avoid movement restriction and to prevent the motor from stopping in overcurrent because of a vacuum or pressure build up inside the vehicle.

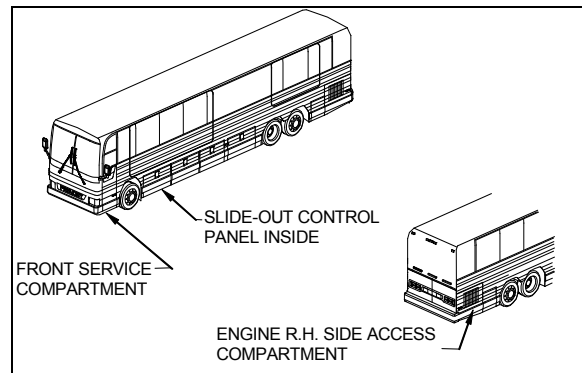

COMPARTMENTS LOCATION

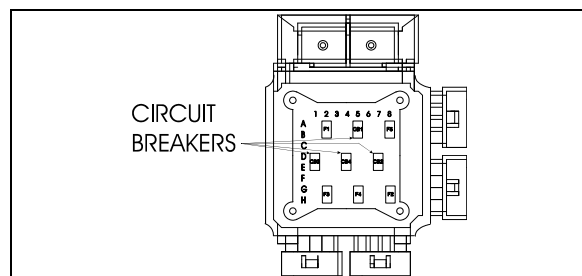

VEC CIRCUIT BREAKERS ON SLIDE-OUT CONTROL PANEL



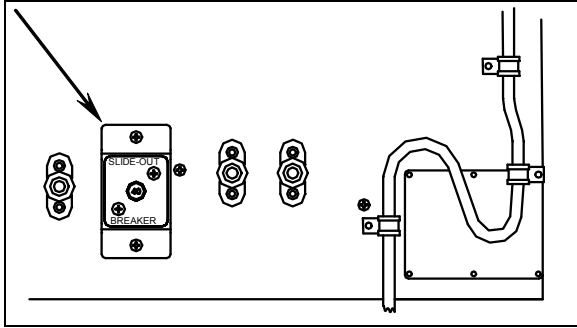

**MAIN SLIDE-OUT BREAKER IN ENGINE R.H. SIDE ACCESS COMPARTMENT**

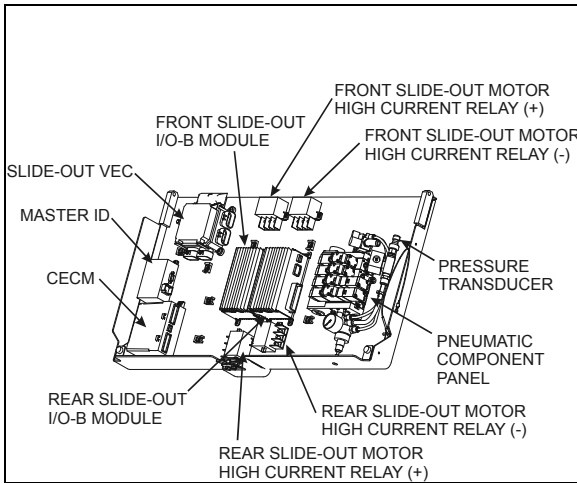

**SLIDE-OUT CONTROL PANEL**

**Manual retracting procedure – Front and rear slide-out**

1. Turn the ignition switch to the "OFF" position, and remove the ignition key for more safety.
2. Deflate the inflatable seal by using the relieving shut-off valve located on the slide-out control panel. Turn the handle clockwise to deflate the seal. Make sure the pressure indicator reading is "0 psi".



**CAUTION**

The pressure in the inflatable seal must be completely relieved to prevent any damage to the seal.

**NOTE**

When air pressure is relieved using the shut-off valve, the normal extending and retracting operation cycle is disabled, for that reason the slide-out cannot be moved using the handheld control.

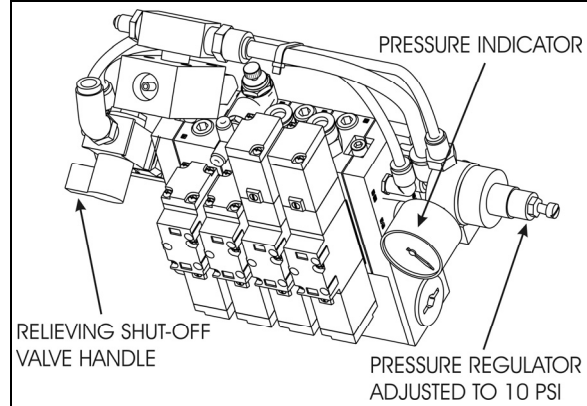

**INFLATABLE SEAL RELIEVING SHUT-OFF VALVE**

3. To move the slide-out, use a cordless power drill with a 3/8" hexagonal bit on the shaft extension of the slide-out motor.
4. Rotate the slide-out motor shaft extension with the power drill until the slide-out comes to its closed position.
5. Once the slide-out room is lined up to its closed position, remove the tool from the motor.

**NOTE**

The front slide-out motor is located inside the 2<sup>nd</sup> baggage compartment while the rear slide-out motor is accessible from inside the vehicle, under the bed structure.

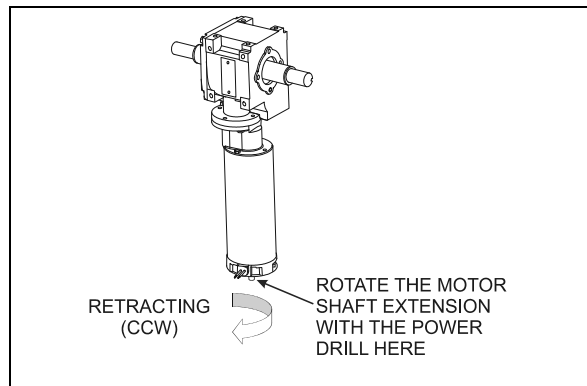

**SLIDE-OUT MOTOR ROTATION**



**CAUTION**

Slow down on the closing speed as the slide-out approaches its closed position. As soon as the "in limit" stoppers come in contact with their bearing surface, stop immediately the power drill rotating movement. Not doing so could overload the drive mechanism and cause damage to the reduction gearbox.

## 104 Other Features

- Finally, the inflatable seal can be re-inflated by turning the shut-off valve handle counterclockwise. Check the pressure gage on the inflatable seal regulator to see if the pressure is increasing to 10 psi.

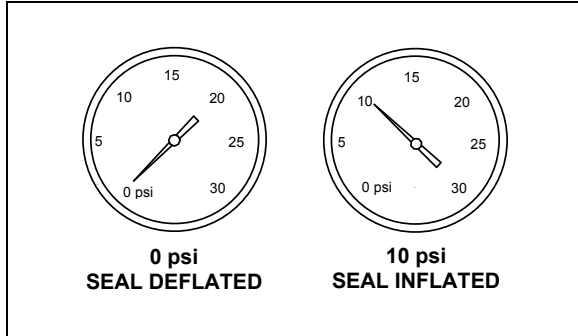

INFLATABLE SEAL PRESSURE GAGE

### NOTE

The slide-out control system inhibits transmission range selection to prevent the vehicle from moving if the slide-out is not in its full "IN" position.

### Manual extending procedure – Front and rear slide-out

- Apply parking brake to disengage the security pin from the receptacle.
- Turn the ignition switch to the "OFF" position, and remove the ignition key for more safety.
- Deflate the inflatable seal by using the relieving shut-off valve located in the slide-out control panel. Turn the handle clockwise to deflate the seal. Make sure the pressure indicator reading is "0 psi".



### CAUTION

The pressure in the inflatable seal must be completely relieved to prevent any damage to the seal.

### NOTE

When air pressure is relieved using the shut-off valve, the normal extending and retracting operation cycle is disabled, for that reason the slide-out cannot be moved with the handheld control.

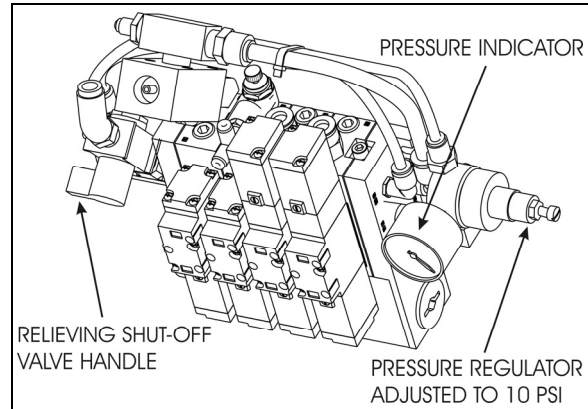

INFLATABLE SEAL RELIEVING SHUT-OFF VALVE

- To move the slide-out, use a cordless power drill with a 3/8" hexagonal bit on the shaft extension of the slide-out motor.
- Rotate the slide-out motor shaft extension with the power drill until the slide-out comes to its opened position.
- Once the slide-out is lined up to its opened position, remove the tool from the motor.

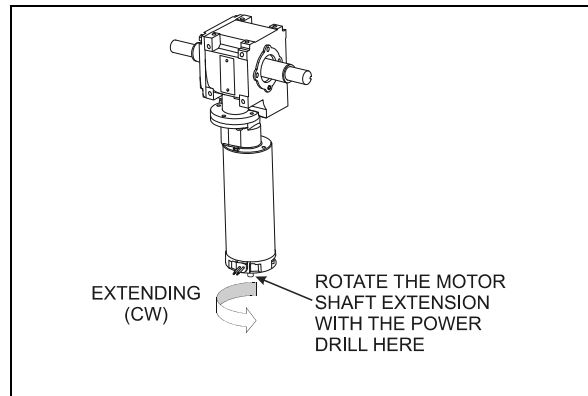

SLIDE-OUT MOTOR ROTATION

### NOTE

The front slide-out motor is located inside the 2<sup>nd</sup> baggage compartment while the rear slide-out motor is accessible from inside the vehicle, under the bed structure.



### CAUTION

Slow down on the closing speed as the slide-out approaches its extended position. As soon as the "out limit" stoppers come in contact with their bearing surface, stop immediately the power drill rotating movement. Not doing so could overload the drive mechanism and cause damage to the reduction gearbox.

7. Finally, the inflatable seal can be re-inflated by turning the shut-off valve handle counterclockwise. Check the pressure gage on the inflatable seal regulator to see if the pressure is increasing to 10 psi.

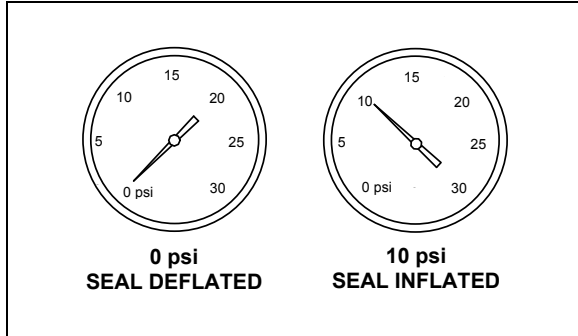

**INFLATABLE SEAL PRESSURE GAGE**

***NOTE***

*The slide-out control system inhibits transmission range selection to prevent the vehicle from moving if the slide-out is not in its full "IN" position.*

If applicable, the MCD shows the device ID, the fault messages or fault codes recorded. When more than one fault is recorded, an arrow pointing down appears on the right of the display. Use the down arrow to see all the fault messages.

Once the problem corrected, the MCD still shows the fault as being active. You have to leave the FAULT DIAGNOSTIC menu, wait approximately 20 to 30 seconds and then return to FAULT DIAGNOSTIC to request a new diagnostic of the ELECTRICAL SYSTEM from the CECM. The MCD should display the fault as being inactive.

## SLIDE-OUT TROUBLESHOOTING

### Error condition or missing operation condition

When an error condition or a missing operation condition is present on a slide-out, the green indicator light on its respective handheld control starts blinking upon releasing of the IN/OUT rocker switch.

Turning the ignition OFF and ON again, will stop the blinking and reset the fault. If the error condition or a missing operation condition is still present, the blinking will start again the next time that the slide-out is operated. So, to get a fault diagnostic, use the MCD right after operating the slide-out without cycling the ignition switch.

### Fault diagnostic

To get more specific information about the error condition or the missing operation condition, request a diagnostic from the slide-out CECM using the dashboard message center display (MCD). Check if there are active errors in the slide-out electrical system. With the SYSTEM DIAGNOSTIC menu, highlight FAULT DIAGNOSTIC and then highlight ELECTRICAL SYSTEM to request a diagnostic of the electrical system from the CECM. Press the enter key.

**TROUBLESHOOTING – OPERATING CONDITIONS, CONTROL & MECHANICAL COMPONENTS**

PROBLEM	CAUSE	CORRECTIVE ACTION
<p>The slide-out functions normally but the handheld control green indicator light blinks</p>	<ul style="list-style-type: none"> <li>A. Something is defective and may eventually create an issue if not repaired. The problem may be:</li> <li>B. Faulty limit sensor causing the slide-out to stop in overcurrent;</li> <li>C. CAN network problem causing the transmission inhibit safety to be non-operational;</li> <li>D. Vacuum pressure transducer disconnected or damaged (vacuum is applied for a fixed time of 7 seconds);</li> <li>E. Seal inflating valve solenoid open circuit (the seal is not re-inflated and water can penetrate in the vehicle);</li> <li>F. Security pin valve solenoid open circuit (the security pin is not extended while vehicle is riding).</li> </ul>	<p>Request a diagnostic from the electrical system using the MCD SYSTEM DIAGNOSTIC menu.</p>
<p>The slide-out does not extend</p>	<ul style="list-style-type: none"> <li>A. The parking brake is not seen by the controller as being applied;</li> <li>B. Not enough air pressure in the accessory air tank to permit proper operation of the vacuum generator;</li> <li>C. Faulty vacuum generator, connection to the vacuum generator open, seal deflating valve solenoid open circuit;</li> <li>D. I/O-B module output defective, regulated 5-volt supply to sensors shorted to ground, "out limit" sensor shorted to ground, connection to the motor negative relay solenoid open circuit;</li> </ul>	<ul style="list-style-type: none"> <li>A. Make sure the parking brake is applied. Confirm parking brake application with the parking brake light on the telltale panel.</li> <li>B. Run the engine at fast idle a few minutes to increase air pressure in the accessory air tank and try again.</li> <li>C. Turn the relieving shut-off valve handle clockwise to deflate the inflatable seal, disconnect the pressure transducer. Do not forget to reconnect the pressure transducer and to close the relieving shut-off valve. Failure to do so could damage the seal and lead to water infiltration;</li> <li>D. Operate the slide-out with the manual override procedures.</li> </ul>
<p>The slide-out does not retract</p>	<ul style="list-style-type: none"> <li>A. Not enough air pressure in the accessory air tank to permit proper operation of the vacuum generator;</li> <li>B. Faulty vacuum generator, connection to the vacuum generator open, seal deflating valve solenoid open circuit;</li> <li>C. I/O-B module output defective, "in limit" sensor shorted to ground, connection to the motor positive relay solenoid open circuit;</li> </ul>	<ul style="list-style-type: none"> <li>A. Run the engine at fast idle a few minutes to increase air pressure in the accessory air tank and try again.</li> <li>B. Turn the relieving shut-off valve handle clockwise to deflate the inflatable seal, disconnect the pressure transducer. CAUTION, do not forget to reconnect the pressure transducer and to close the relieving shut-off valve. Failure to do so could damage the seal and lead to water infiltration;</li> <li>C. Operate the slide-out with the manual override procedures.</li> </ul>

PROBLEM	CAUSE	CORRECTIVE ACTION
When extending, the slide-out stops after having extended by 1 inch	The security pin valve solenoid circuit is shorted to (+) 24-volt and the pin remains engaged;	Disconnect air supply from the safety pin cylinder;
Transmission DRIVE range or REVERSE cannot be selected (the slide-out telltale light is illuminating).	<ul style="list-style-type: none"> <li>A. Slide-out not in full "in" position;</li> <li>B. Faulty "in limit" sensor. The slide-out is retracted but the controller doesn't see it as retracted.</li> </ul>	<ul style="list-style-type: none"> <li>A. Retract slide-out.</li> <li>B. Confirm that all slide-outs are retracted. On the slide-out control panel, disconnect the 5 pins green connector on the I/O-B module to disable the transmission inhibit. CAUTION, this is a temporary measure, the vehicle must be serviced as soon as possible.</li> </ul>
Slide-out does not retract or extend when depressing the control switch.	<ul style="list-style-type: none"> <li>A. Electrical motor failure;</li> <li>B. Speed reduction gearbox failure;</li> <li>C. Security pin still engaged in receptacle;</li> </ul>	<ul style="list-style-type: none"> <li>A. Replace motor.</li> <li>B. Inspect gearbox components, particularly: bronze wheel or first reduction stage output shaft. Replace damaged components.</li> <li>C. Disengage pin and check if air cylinder is damaged.</li> </ul>
Slide-out is not straight once retracted or during retracting or extending operation.	<ul style="list-style-type: none"> <li>A. Broken rack tooth;</li> <li>B. Faulty rack attachment;</li> <li>C. Faulty shaft key at speed reduction gearbox or jaw coupling;</li> <li>D. Pinion keyless bushing slipping;</li> <li>E. Shaft breaking;</li> <li>F. Flange bearing attachment loosen;</li> </ul>	<ul style="list-style-type: none"> <li>A. Replace rack.</li> <li>B. Tighten mounting bolts, apply proper torque and use Loctite threadlocker (replace rack if necessary).</li> <li>C. Replace key or component having a damaged keyway.</li> <li>D. Realign slide-out and apply proper torque to keyless bushing.</li> <li>E. Replace shaft.</li> <li>F. Reposition shaft and tighten flange bearing mounting bolts.</li> </ul>
Slide-out moves out slightly when vehicle is traveling.	Lower "in limit" stoppers are not leaning against the structure at the moment when the "in limit" sensor detects the magnet;	Adjust the sensor position in order to have contact of the stoppers against the structure at the time when the system stops the slide-out retraction.
Slide-out moves when vehicle is moving.	Inflatable seal not inflated	Check seal condition and seal air supply system.
Slide-out retracts or extends with difficulty.	Foreign matters accumulated in the linear bearing;	Inspect the linear bearing end seals to see if they are in good condition. If not, replace the end seals and clean the inside of linear bearing.

## 108 Other Features

PROBLEM	CAUSE	CORRECTIVE ACTION
Slide-out oscillates vertically when retracting or extending	<ul style="list-style-type: none"> <li>A. Linear bearing balls hardened due to a too heavy load;</li> <li>B. Linear bearing mounting bolts loosen;</li> </ul>	<ul style="list-style-type: none"> <li>A. If balls clearance is excessive, replace linear bearing.</li> <li>B. Tighten mounting bolts.</li> </ul>
Slide-out vibrating or noisy when extending or retracting	<ul style="list-style-type: none"> <li>A. Acetal plastic block rubbing against the slide-out structure;</li> <li>B. Worn-out anti-friction coating on wiper seal around slide-out;</li> <li>C. Lower acetal plastic block rubbing against rail;</li> </ul>	<ul style="list-style-type: none"> <li>A. Realign acetal plastic block.</li> <li>B. Replace wiper seal.</li> <li>C. Remove lower acetal plastic block and machine down 1mm (0.039").</li> </ul>
Top of slide-out moves sideways when vehicle is moving	Roof reinforcing rod misadjusted;	Readjust as per procedure.
Slide-out does not retract up to its full "in" position	Interference between the exterior extrusion and the vehicle upper horizontal member above the slide-out;	<ul style="list-style-type: none"> <li>A. Check for straightness of horizontal member and adjust the roof reinforcing rod.</li> <li>B. Check for outer wiper seal lip straightness on the slide-out roof.</li> </ul>
Bottom of slide-out not flush with vehicle body	<ul style="list-style-type: none"> <li>A. Broken or misadjusted lower "in limit" stopper;</li> <li>B. Lower "in limit" stoppers are not leaning against the structure at the moment when the "in limit" sensor detects the magnet;</li> <li>C. Acetal plastic block serving as leaning surface for lower "in limit" stopper broken or moved;</li> </ul>	<ul style="list-style-type: none"> <li>A. Replace or adjust lower "in limit" stopper.</li> <li>B. Adjust the sensor position in order to have contact of the stoppers against the structure when slide-out is stopped.</li> <li>C. Replace or adjust acetal plastic block proper position.</li> </ul>
Top of slide-out not flush with vehicle body	<ul style="list-style-type: none"> <li>A. Broken or misadjusted leveling or retaining screw;</li> <li>B. Faulty upper "in limit" stopper;</li> </ul>	<ul style="list-style-type: none"> <li>A. Check and replace screw.</li> <li>B. Replace upper "in limit" stopper.</li> </ul>
Lower edge of slide-out not parallel with vehicle body opening	Faulty leveling and retaining screw (8 screws on each side).	Inspect screws, replace and adjust slide-out level.
Watertightness problem	<ul style="list-style-type: none"> <li>A. Inflatable seal and/or wiper seal damaged or unstuck;</li> <li>B. Insufficient air pressure in the seal;</li> <li>C. No air pressure in the slide-out pneumatic system;</li> <li>D. Sealant missing;</li> </ul>	<ul style="list-style-type: none"> <li>A. Check both seals condition.</li> <li>B. Check the pressure regulator, the relieving shut-off valve and the seal valve condition.</li> <li>C. Check the slide-out air pressure inlet valve condition and the accessory air tank pressure.</li> <li>D. Check the exterior extrusion screws, the windows and the exterior panels sealant condition.</li> </ul>

PROBLEM	CAUSE	CORRECTIVE ACTION
	<ul style="list-style-type: none"> <li>E. Wiper seal draining hole clogged;</li> <li>F. Faulty water recovery pan;</li> <li>G. Faulty internal gutter;</li> </ul>	<ul style="list-style-type: none"> <li>E. Unclog draining hole.</li> <li>F. Check the recovery pan.</li> <li>G. Check internal gutter.</li> </ul>
Knocking sound at end of travel when extending slide-out	Inner stoppers misadjusted;	Readjust the inner stoppers.
Knocking sound when parking brake is released	Security pin retracts too rapidly;	Adjust security pin air flow regulator.
Inflatable seal damaged or removed, or wiper seal unstuck from the structure.	<ul style="list-style-type: none"> <li>A. Slide-out has been retracted or extended with the manual procedure with the inflatable seal not deflated;</li> <li>B. Pressure transducer malfunction;</li> <li>C. Faulty roof reinforcing rod adjustment;</li> <li>D. Seal valve malfunction;</li> <li>E. Excessive load in the slide-out;</li> <li>F. Slide-out not centered in the structure opening;</li> </ul>	<ul style="list-style-type: none"> <li>A. Always deflate the seal when manually retracting or extending the slide-out.</li> <li>B. Check the pressure transducer condition, replace if necessary.</li> <li>C. Readjust the roof reinforcing rod.</li> <li>D. Check the seal valve condition.</li> <li>E. Reduce load or distribute load evenly in order to respect the deflection criterion and slide-out load capacity.</li> <li>F. Readjust the slide-out height and center horizontally in opening.</li> </ul>
Friction at end of travel when in full OUT position or at beginning of retraction	Interference between upper structure key and upper inner stopper;	Readjust the upper inner stopper.





## **Starting and Stopping Procedures    111**

---

<b>STARTING THE ENGINE</b> .....	<b>112</b>
STARTING FROM THE DRIVER'S SEAT .....	112
STARTING FROM THE ENGINE COMPARTMENT .....	112
<b>COLD WEATHER STARTING</b> .....	<b>113</b>
<b>ENGINE BLOCK HEATER</b> .....	<b>113</b>
<b>JUMP STARTING</b> .....	<b>114</b>
<b>ENGINE WARM-UP</b> .....	<b>115</b>
<b>ALLISON TRANSMISSION WARM-UP</b> .....	<b>115</b>
<b>I-SHIFT TRANSMISSION - STARTING THE VEHICLE AT LOW TEMPERATURES</b> .....	<b>115</b>

### STARTING THE ENGINE

In normal circumstances, the engine should be started from the driver's seat. However, a rear-start panel in the engine compartment permits starting the engine from that location, mainly for maintenance purposes.

#### STARTING FROM THE DRIVER'S SEAT

- Apply the spring-loaded parking brakes by pulling the parking brake control button all the way up;
- Make sure that the starter selector switch located in the engine compartment is set to the *NORMAL* position;
- Place transmission in neutral;
- Turn ignition key to *START* position (refer to "Controls and Instruments" chapter), release the key after the engine starts.
- Brake pedal must be applied when selecting Drive (D) otherwise the transmission will stay in neutral (N).

 <b>CAUTION</b>
Do not engage starter for more than 15 seconds at a time. If engine does not start within 15 seconds, release ignition key and let starter cool for one minute before attempting to restart.

 <b>CAUTION</b>
Do not press accelerator pedal before starting. This could result in an electronic control unit fault and degrade the fuel system control.

 <b>CAUTION</b>
Special precautions are necessary with turbocharged engines to avoid possible turbine damage. After starting, run the engine at slow idle for two minutes to allow lubricating oil to reach the turbocharger. Then run the engine at fast idle. Let oil pressure reach normal operating range before driving.

<i>NOTE</i>
<i>If engine does not start, return key to OFF position before attempting to restart.</i>

<i>NOTE</i>
<i>If the accelerator pedal is depressed before starting, release and wait 30 seconds before attempting to restart.</i>

#### Stopping the Engine

- Apply parking brake and place transmission in neutral (N);
- Allow engine to idle for at least two minutes before shutting engine *OFF*. This insures that the turbine speed drops and allows time for the engine exhaust gas temperature to drop to about 300°F (150°C);
- Shut off all electrical loads;
- Turn the ignition key to the *OFF* position.

 <b>CAUTION</b>
Do not shut <i>OFF</i> engine when running above slow idle.

 <b>CAUTION</b>
Set the battery master switch (master cut-out) to the <i>OFF</i> position after parking and when left unattended for an extended period of time.

#### STARTING FROM THE ENGINE COMPARTMENT

Switches to start and stop the engine from inside the engine compartment are mounted on a small panel above the air filter.

 <b>DANGER</b>
Apply parking brake and place transmission in neutral (N) before starting engine from inside the engine compartment.

Set the battery master switches (ignition and master cut-out) to the *ON* position;

Set the starter selector switch to the *REAR START* position;

Press the *REAR START* push-button switch. Release push-button after the engine starts.

 <b>DANGER</b>
Do not wear loose clothing when working near engine. Stand clear of rotating components.

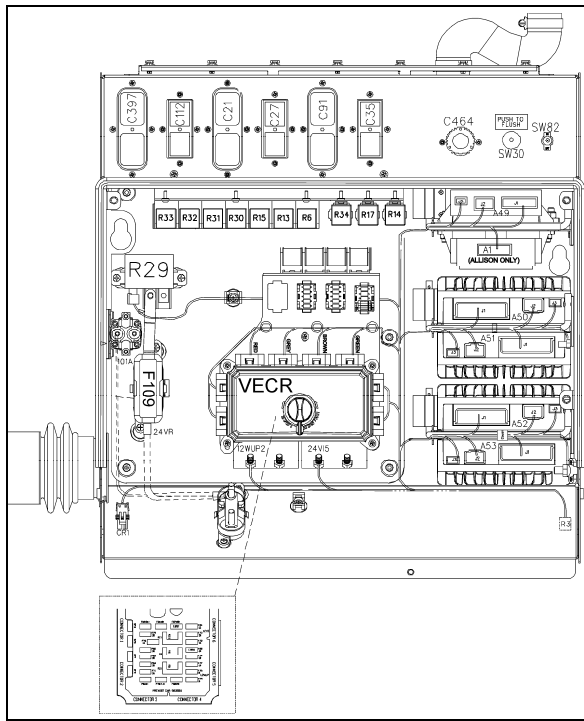

REAR ELECTRICAL PANEL SAFETY SWITCH 06621

**CAUTION**

Refer to cautions in “Starting From The Driver’s Seat” in this chapter

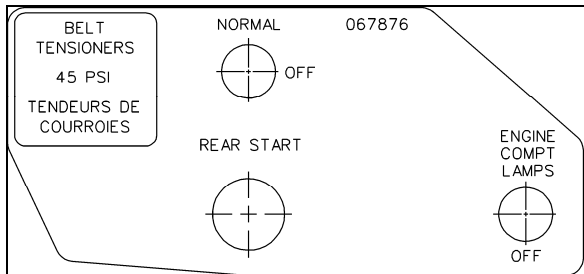

REAR START PANEL 06622

**DANGER**

Rotating shafts can be dangerous. You can snag cloths, skin, hair, hands, etc. This can cause a serious injury or death. Do not work on a shaft (with or without a guard) when the engine is running.

**Stopping the Engine**

To stop the engine, set the starter selector switch to the OFF position.

**CAUTION**

Do not stop engine by any other method.

**COLD WEATHER STARTING**

When starting a cold engine, the intake air should be warmed up by using the intake air preheater. Turn the ignition switch to the ON position. The preheater will not engage at coolant temperature above 54°F (12°C). If the coolant temperature is below 54°F (12°C), the preheater will engage and will light the preheater telltale between 0 and 50 seconds, depending on the engine coolant temperature. Wait before the preheater telltale has turned off before starting the engine.

If necessary, once the engine has started, the preheater will reengage (post heating) for the same length of time as the preheat time.

**WARNING**

Do not use ether or other combustibile starting aid fluid on any engine equipped with an intake air preheater. If the engine is equipped with a preheater, introduction of ether or similar starting aids could cause a fire or explosion resulting in severe property damage, serious personal injury or death.

Engines not equipped with an intake air preheater may, depending on coolant temperature, take longer to start. If this should happen, DO NOT release the ignition key until the engine has started (while still observing the 15 second maximum cranking time).

**ENGINE BLOCK HEATER**

The vehicle may be equipped with an engine immersion-type electric block heater to assist cold weather starting. The 110-120 VAC power connector is located to the right, behind the engine compartment rear doors. Connect the female plug of an extension cord to the 110-120 VAC male outlet. Plug the extension cord into a 110-120 VAC power source only. Use the engine block heater whenever the vehicle is parked for an extended period of time in cold weather and when a 110-120 VAC power source is available.



**CAUTION**

Use only a 110-120 VAC power source. Use only grounded (three prongs) extension cords with a minimum rated capacity of 15 amps. Disconnect the extension cord before starting. Before driving, make sure the extension cord is disconnected and the engine compartment door is closed.

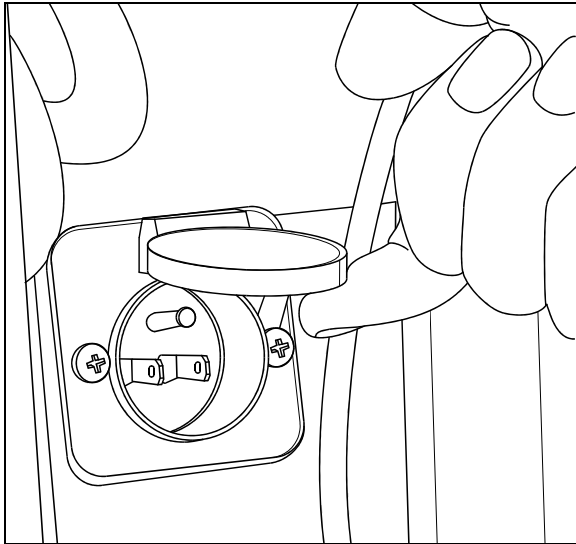

110-120 VOLTS CONNECTOR

06390

**JUMP STARTING**

In order to avoid damage to solid-state electrical components, it is important that jumper (booster) cables be used correctly and only in emergencies. To jump start, use another 24 volt DC, negative grounded, power source. Use only jumper cables rated at 500 cranking amperes.



**DANGER**

Injury, explosion, battery acid damage or charging system overload may result if these jump starting procedures are not precisely followed.



**WARNING**

Wear eye protection and remove rings, metal jewelry and watches with metal bands.



**DANGER**

The battery could rupture or explode if jump started when the run-down battery fluid is frozen or if the battery fluid level is low. Check condition of run-down battery before attempting to jump start.



**DANGER**

The gases given off by batteries while jump starting are explosive. Do not smoke near batteries.



**CAUTION**

Do not let the two vehicles touch. Keep a walk-through distance between the two vehicles. Make sure positive (red) and negative (black) jumper cable clamps do not touch.



**CAUTION**

Never connect the jumper cable to the negative terminal post of the run-down battery.



**CAUTION**

Do not jump start if a maintenance-free battery has a yellow test indicator. Have the battery replaced.



**WARNING**

Before attempting to jump start, make sure the parking brake is applied and the transmission is in neutral (N). Turn off all lights, heaters and other electrical accessories.

To jump start, proceed as follows:

1. Connect one end of the red jumper cable to the positive (+) post of the booster power source. If the good battery is in another vehicle, that vehicle's engine must be shut *OFF* before connecting;
2. Connect the other end of the same red jumper cable to the positive (+) terminal bar on the battery;

3. Connect one end of the black jumper cable to the negative (-) post on the booster power source;
4. Connect the other end of the same black jumper cable to the negative (-) terminal on the structure; If the good battery is in another vehicle, start that vehicle's engine;
5. Let the engine run for a few minutes, then start the vehicle with the run-down battery;
6. Disconnect the jumper cables in reverse order given in steps 1 through 4.

**NOTE**  
*Jumper cables must be rated at 500 cranking amperes. If jumper cable length is 20 feet (6 m) or less, use 2/0 (AWG) gauge wires. If cable length is between 20 to 30 feet (6 to 9 m), use 3/0 (AWG) gauge wires.*

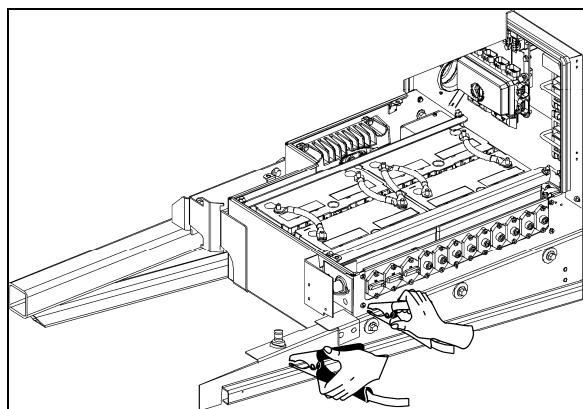

JUMP STARTING

06645

**ENGINE WARM-UP**

After starting the engine, keep the parking brake applied and let the engine run at slow idle for two minutes to allow lubricating oil to reach the turbocharger. Increase engine speed to fast idle, using the FAST IDLE switch located on the dashboard for five minutes, without loading the engine. Monitor the gauges and indicator lights to make sure all conditions are normal. If an

abnormal condition is observed, stop the engine immediately and have the condition corrected.

**DANGER**

Never let the engine run in an enclosed, non-ventilated area. Engine exhaust fumes contain dangerous gases which can be fatal if inhaled. Before warming up the engine, open the door(s) or move the vehicle outside.

**NOTE**  
*The engine will reach normal operating temperature shortly after driving. Avoid driving at full throttle until engine coolant temperature reaches 140°F (60°C).*

**ALLISON TRANSMISSION WARM-UP**

When the transmission temperature falls below -20°F (-29°C), the CHECK TRANS telltale light illuminates after the engine is started. In this case, the transmission will be locked in neutral (N) until the transmission temperature rises above -20°F (-29°C) and the CHECK TRANS telltale light goes out. The transmission will only operate in first or reverse gears until it reaches normal operating temperature.

**I-SHIFT TRANSMISSION - STARTING THE VEHICLE AT LOW TEMPERATURES**

For outside temperatures between -4°F (-20°C) and -22°F (-30°C), the transmission will require a warming up phase once the engine is started. The engine must be operated for at least 10 minutes with the vehicle at a standstill until the transmission oil has warmed up.

For outside temperatures below -22°F (-30°C), warm air must be used to heat the transmission up to a temperature above -22°F (-30°C) before the engine is started.



## Safety Features And Equipment 117

---

<b>EMERGENCY EXITS</b> .....	<b>118</b>
ELECTRIC AWNING WINDOWS .....	118
ELECTRIC SLIDING WINDOWS.....	118
FIXED WINDOWS .....	118
<b>EMERGENCY AIR-FILL VALVES</b> .....	<b>118</b>
<b>EMERGENCY AND PARKING BRAKES</b> .....	<b>119</b>
<b>SAFETY EQUIPMENT</b> .....	<b>119</b>
AUTOMATIC FIRE DETECTION AND SUPPRESSION SYSTEM (ASSS).....	119
TIRE PRESSURE MONITORING SYSTEM (TPMS) .....	120
FIRE EXTINGUISHERS .....	124
FIRST AID KIT .....	124
WARNING REFLECTORS .....	124
JACK AND TOOLS .....	125
SPARE PARTS KIT .....	125
<b>CHANGING WHEELS</b> .....	<b>125</b>
JACKING POINTS .....	125
HYDRAULIC JACK.....	126
<b>TOWING</b> .....	<b>126</b>
<b>DAYTIME RUNNING LIGHTS</b> .....	<b>127</b>
<b>FOG LIGHTS</b> .....	<b>127</b>
<b>CORNERING AND DOCKING LIGHTS</b> .....	<b>127</b>
<b>COMPARTMENT LIGHTING</b> .....	<b>127</b>
<b>MUD FLAPS AND SPLASH GUARDS</b> .....	<b>127</b>
<b>BACK-UP CAMERA</b> .....	<b>127</b>
<b>BACK-UP ALARM</b> .....	<b>127</b>
BACK-UP ALARM CANCEL SWITCH.....	127

## EMERGENCY EXITS

Locate and learn how to use all possible emergency exits. Inform all guests or passengers of the location of exits and how to use them in case of an emergency.

### ELECTRIC AWNING WINDOWS

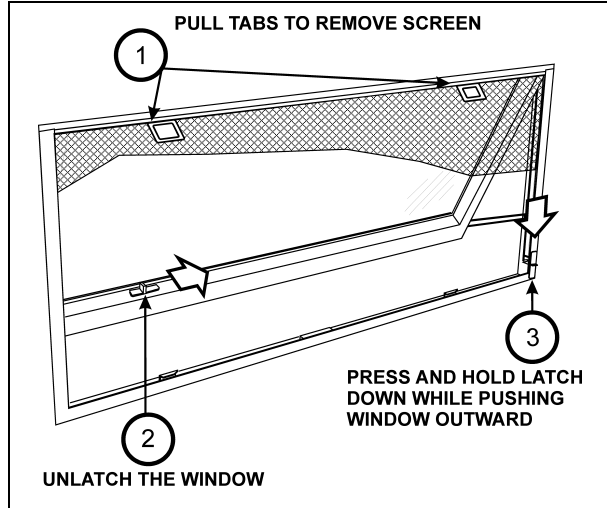

ELECTRIC AWNING WINDOW

18584

### ELECTRIC SLIDING WINDOWS

Electric (power) sliding windows can be used as emergency exits.

- Remove the screen assembly,
- Pull down on both red release latches simultaneously and rotate the sash inwards approximately 10 degrees.
- Lift the sash up and out to disengage the bottom of the sash from the window frame.

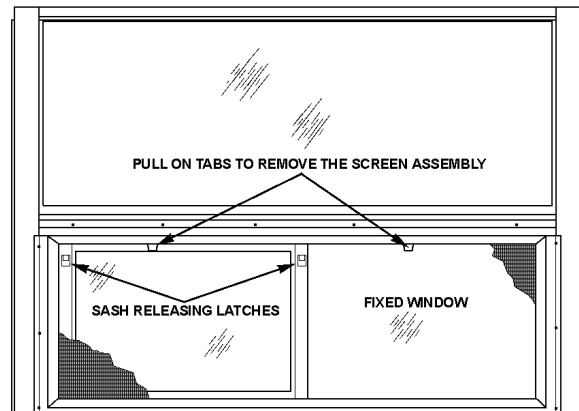

ELECTRIC SLIDING WINDOW

18206

### FIXED WINDOWS

Fixed windows are glued to the structure of the vehicle; they do not open and are very hard to break. Do not attempt to open, instead find and use the entrance door, the nearest awning or sliding window or a roof escape hatch.

### EMERGENCY AIR-FILL VALVES

The vehicle is equipped with two air system emergency fill valves to supplement the air system when air pressure is low and the engine cannot be operated. One valve is located inside the front service compartment. The other valve is located inside the engine compartment.

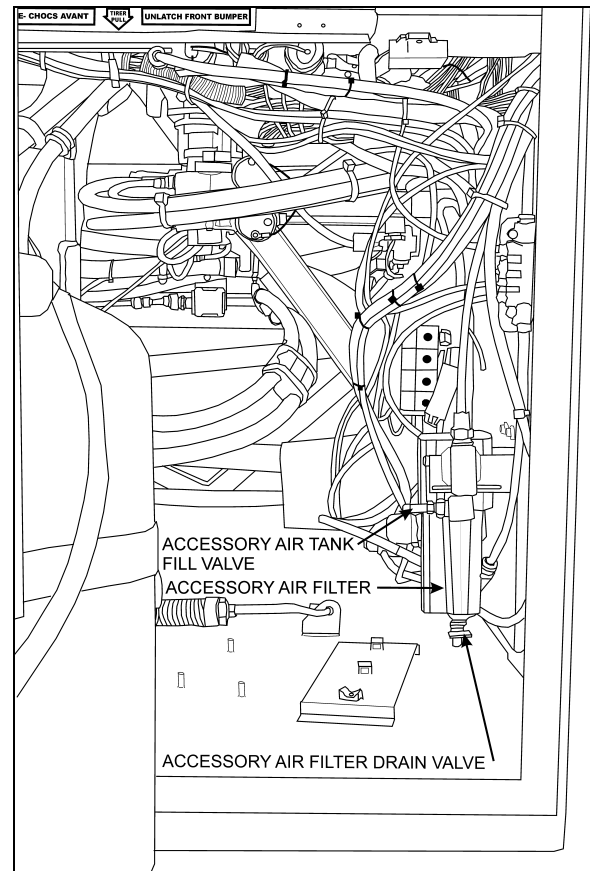

FRONT SERVICE COMPARTMENT

12218

Both air system emergency fill valves are fitted with standard tire valve stems. The air systems can be filled using any standard external air supply line. The fill valve located in the engine compartment supplies air for all systems (brakes, suspension and accessories). The fill valve located in the service compartment supplies air for accessories only.





**CAUTION**

Air filled through the two emergency fill valves will pass through the standard air filtering system. Do not fill air at any other location. Do not exceed 120 psi (827 kPa).

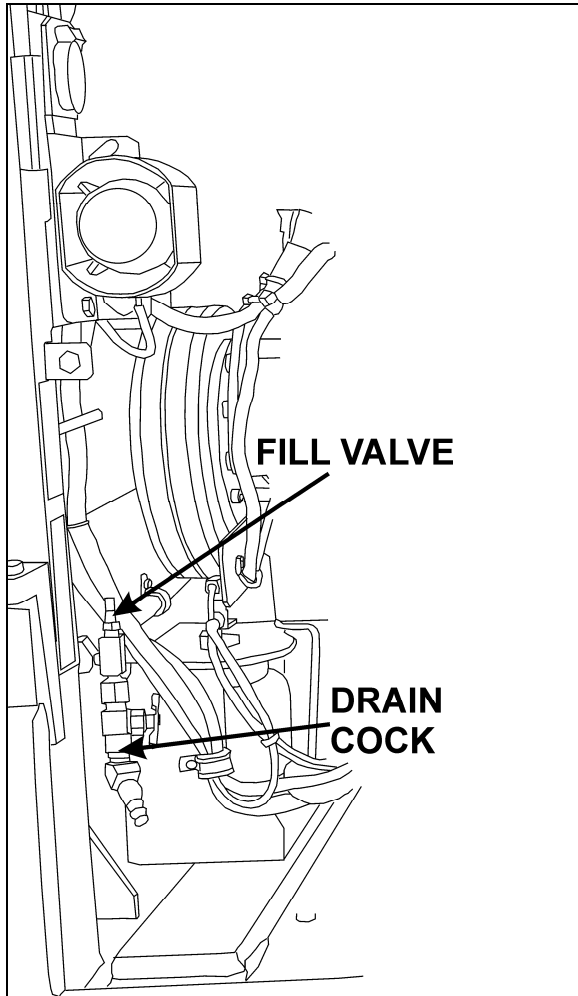

FILL VALVE IN ENGINE COMPARTMENT 12162

**EMERGENCY AND PARKING BRAKES**

During normal operation, if air pressure in both brake circuits drops below 40 psi (276 kPa), spring-loaded emergency parking brakes will be immediately applied at full capacity to the drive axle wheels to stop the vehicle.

Spring-loaded parking brakes are applied by pulling up the control valve knob located on the L.H. lateral console.

Parking brakes are not designed to be used as service brakes. For normal driving conditions,

the control valve knob must remain in the down position.



**DANGER**

Always apply the parking brakes before leaving the driver's seat.

**NOTE**

Only use the parking brakes to supplement the service brakes to stop the vehicle in emergency conditions. The stopping distance will be considerably longer than when using normal service brakes.

**NOTE**

Before releasing the parking brakes by pushing down the control valve knob, check the pressure gauges to make sure that the brake system air pressure is greater than or equal to 95 psi (655 kPa).

**NOTE**

A beep will sound if the ignition switch has been turned off without applying the parking brakes. The same beep will sound if pressure is still applied to the service brake pedal.

**NOTE**

The stoplights will automatically turn on when the parking brake is applied and the ignition key is turned to the ON position.

**SAFETY EQUIPMENT**

**AUTOMATIC FIRE DETECTION AND SUPPRESSION SYSTEM (AFSS) (OPTIONAL)**

The vehicle may be equipped with the optional Automatic Fire Detection and Suppression System (AFSS).

**System operation**

When a fire is detected inside the engine compartment, the system sends a fire alarm signal to the **Protection Panel** located in the Driver's area near the lateral control panel. The **Protection Panel** immediately turns on the fire "ALARM" lamp and sounds the audio alarm. After a 15-second time delay the engine is automatically shut down. The fire extinguisher is discharged simultaneously with engine shutdown.

**NOTE**

The **Manual Activation Switch** is used when immediate discharge of the fire extinguisher and engine shutdown is desired.

**NOTE**

The **Protection Panel** continuously monitors system integrity and displays the information via the “SYSTEM OK” and fire “TROUBLE” indicators.

**Operational sequence (fire)**

1. A fire detector or liner thermal detector detects a fire in the engine compartment and sends a signal to the **Protection Panel** in the driver’s area.
2. The fire “ALARM” lamp on the **Protection Panel** will illuminate solid red and an audible alarm will sound.
3. The operator shall bring the vehicle to a safe stop.
4. The system automatically shuts down the vehicle engine and discharges the extinguisher into the engine compartment 15 seconds after the fire alarm starts unless advanced or delayed by the operator.
  - If the operator presses the **Manual Activation Switch**, all delays will terminate and the engine shutdown and extinguisher discharge will occur immediately.
  - If the operator presses and releases the **Delay Engine Stop** switch once, the engine shutdown and extinguisher discharge will be delayed by an additional 15 seconds.



**WARNING**

The engine will stop 15 seconds after the fire alarm starts. The operator must be prepared to bring the vehicle to a safe stop as soon as the alarm sounds. Steering may become difficult after engine shutdown. If more time is required, the “DELAY ENGINE STOP” switch may be pressed and released for an additional 15 seconds delay.



**WARNING**

The extinguisher discharge may cause an obscuring cloud behind and near the vehicle.

5. The red fire “ALARM” lamp and audible alarm will stay on. The yellow fire “TROUBLE” lamp will also be on indicating a discharged extinguisher.
6. The system must be reset and the fire extinguisher removed and replaced in accordance with the System Reset portion of the Kidde Dual Spectrum Operation & Maintenance Manual.

**TIRE PRESSURE MONITORING SYSTEM (TPMS) (OPTIONAL)**

The vehicle may be equipped with the optional Tire Pressure Monitoring System (TPMS).

**Description**

System includes the following elements:

- Special tire valves;
- RF sensor inside each tire, fixed to the valve;
- 3 antennas to receive the sensors RF signal (one in the front spare tire compartment, one above the L.H. side rear wheels and one above the R.H. side rear wheels);
- A TPMS receiver connected to the antennas and located in the front electrical compartment, above the CECM;
- A TPMS display built in the L.H. dashboard panel;
- A “FLAT TIRE” telltale panel indicator.

The section of the special tire valves located inside the tire is dome-shaped to allow fixing the sensor.

Sensors provide continuous tire pressure and temperature reading.

The normal sensor battery lifespan is 5 years. The remaining lifespan is displayed as a percentage in the TPMS display.

**NOTE**

It is recommended to check the remaining battery lifespan when changing the tires in order to replace the sensors at the same time if they are due for replacement before the next change.

The screw fixing the sensor to the valve can only be used once because the threads are powder-coated to lock the sensor in place and prevent unfastening.

The telltale panel indicator illuminates for 3 seconds when the ignition switch is turned ON to check the display operation and the communication between the display and the vehicle multiplex system. This confirms the communication between the TPMS display and CECM.

**Settings Menu**

- Set Wheel ID

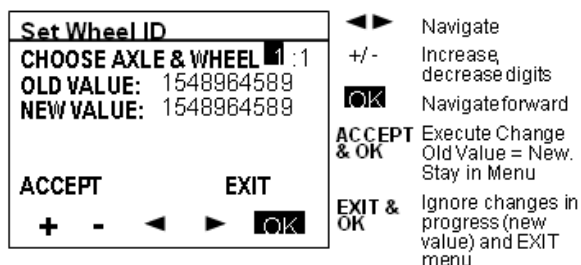
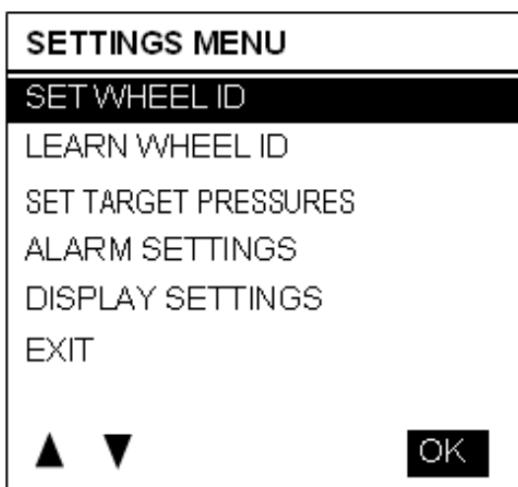

- Learn Wheel ID

This menu allows learning new wheel sensors ID. The user can learn only one wheel, several wheels or all wheels of the vehicle. The sequence automatically jumps to the next wheel such that a user can initiate all wheels without having to come back to the display between each wheel.

The display uses a pressure change as the criteria to recognize which wheel sensor the operator wants to get assigned to a given location. The amount of pressure change required is established at 2 PSI.

A pressure change of about 3 PSI is needed to wake up a sensor and then an extra amount of pressure change of 2 PSI is needed to trigger the display. The operator has to create a pressure change by at least 6 PSI and then wait for the display to recognize the pressure change. The wait time correspond to the sensor sampling rate.

When entering the menu, the axle 1, wheel 1 is selected by default as a starting point for the learning. The user can select another axle with +/- , move the cursor to the wheel number with the right arrow and select another wheel with the +/- or move the cursor down to the start learning button.

After the start learning button is selected, the display stores the first transmission it gets from each sensor ID into the “initial pressure” for that sensor ID. Then it compares each subsequent pressures received for that sensor ID with the initial one and when the comparison shows a delta pressure exceeding the defined level required, this sensor ID is assigned to the selected tire location.

Once a wheel ID has been assigned, the display increments the number of Wheels done and it moves the axle/wheel to the next one in the sequence waiting for another sensor to come up with a pressure change. Within one learning session, the display remembers which sensor has been assigned and it will not assign it twice.

The sequence increments to the next wheel on the same axle counting wheels from left to right and then moves to the next axle counting axles from front to rear.

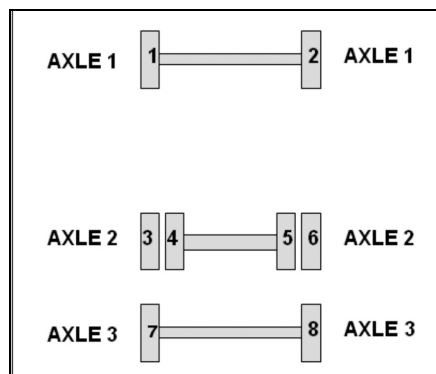

The display activates the next wheel parameter each time a wheel is done. This parameter is use by the vehicle electronic to activate an audible signal on the vehicle thus providing a feedback to the user that he can move to the next wheel.

The spare Tire can be done by selecting the axle/wheel “spare” which is internally encoded to 15:1.

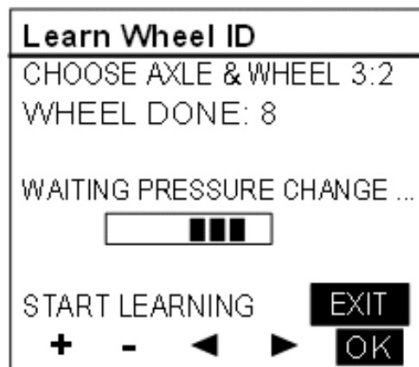
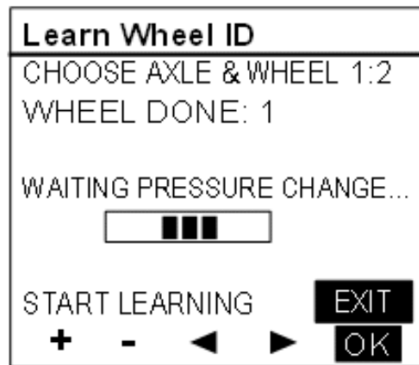
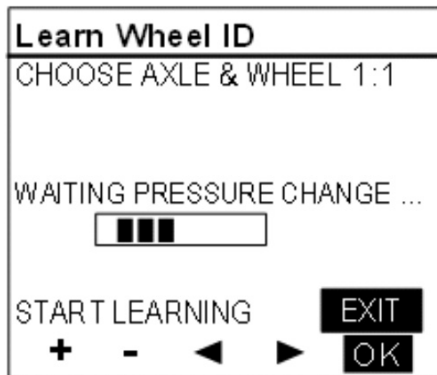
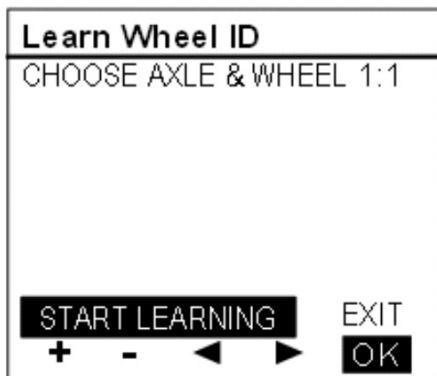
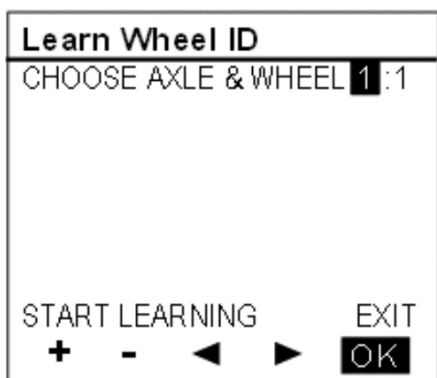
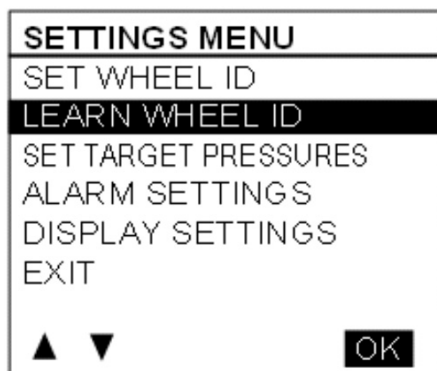

- Set Target Pressures

This menu allows the end user fine tuning the target pressure setting to account for the specific operating conditions (cold weather operation or unloaded operation). The end user can readjust the target pressure within +30% and -20% of the factory set target pressure but not outside this range.

The factory set target pressure is always kept in permanent memory into the TPMS display and cannot be edited by the end user.

When the user enters a new target value, the user cannot select values outside the valid range.

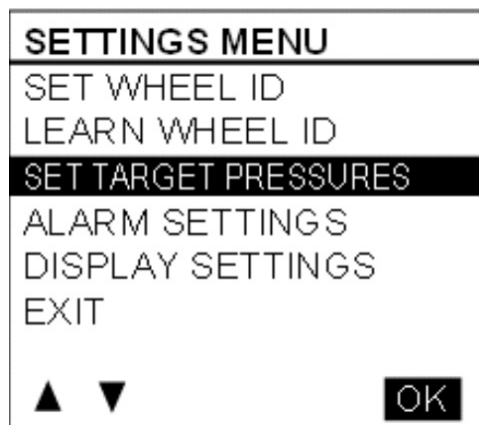

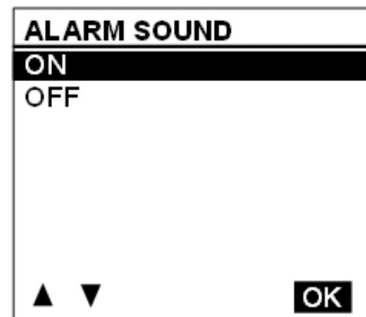
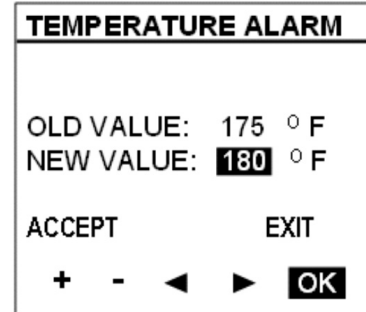
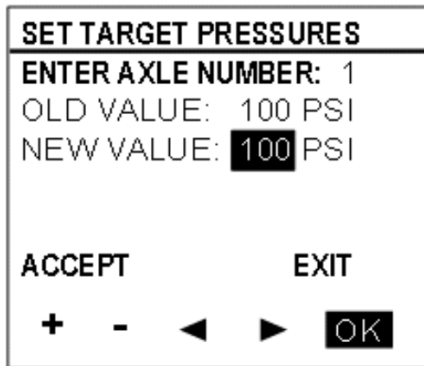

- Alarm Settings

When selecting the Alarm Settings Menu, a sub menu containing Pressure Alarm and Temperature Alarm appears.

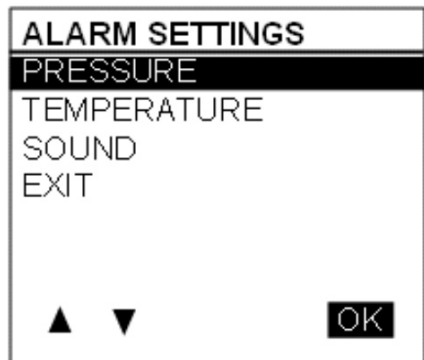
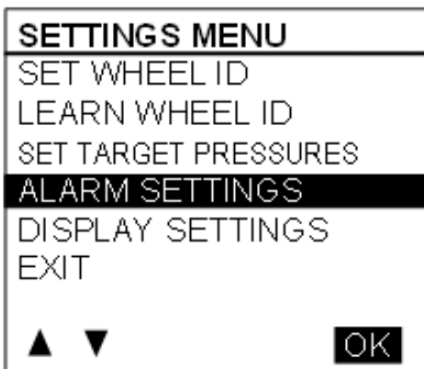

- Display Settings

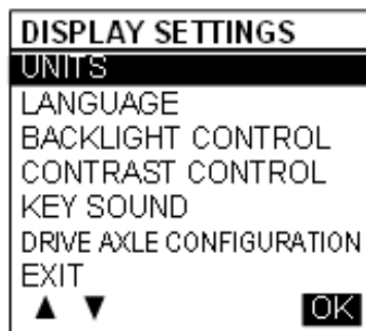
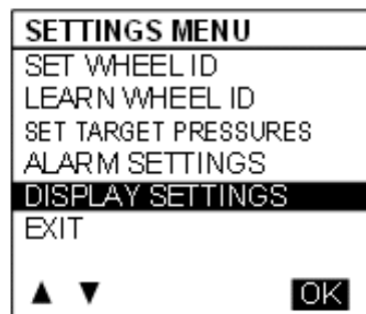

When selecting Pressure Alarm the screen pressure alarm shown below appears. A similar screen is defined for temperature settings. The cursor can be moved to highlight the number beside “new value”, “ACCEPT” or “EXIT”. +/- allows increasing or decreasing the numbers. Pressure alarms changes are allowed in steps of 1 PSI in the range from 5 to 20 PSI. Temperature alarms in steps of 5°F (2°C) in the range from 150 to 180 °F (64 to 82 °C). Pressing OK with “ACCEPT” highlighted applies the change and exits to the previous menu. Pressing OK when “EXIT” is highlighted exits without changes.

Units

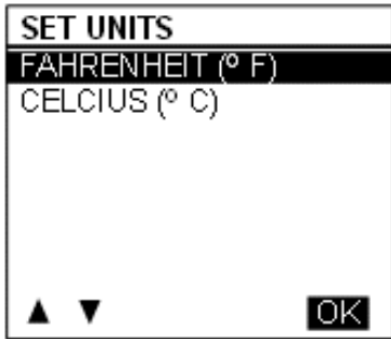

Languages



Backlight Intensity

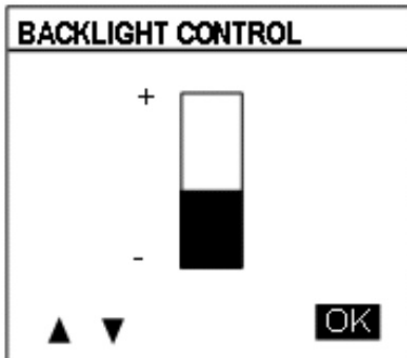

Key Sound

Turns key press sound ON/OFF.

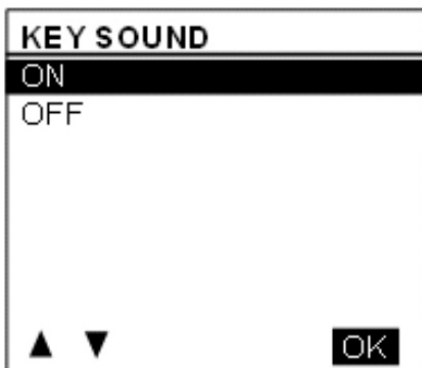

Tire / Axle Configuration

Pressing the up down arrow when the number of tires is highlighted allows flipping the number to 2 or 4 which are the only valid choices.

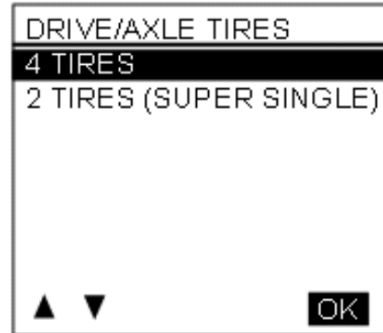

Refer to "Appendix E" for Troubleshooting Guide on TPMS system.

**FIRE EXTINGUISHERS**

Two fire extinguishers are located on the vehicle L.H. side just behind the driver's seat. Instructions for use are found on the extinguishers. Make sure you know how to operate fire extinguishers in case of an emergency.

**FIRST AID KIT**

The optional first aid kit is usually stored near the driver's seat. A white cross over red background decal identifies the first aid kit.

**WARNING REFLECTORS**

A kit containing three triangular reflectors is provided to warn other drivers on the road in case of a breakdown. The kit is located on the ceiling of the first R.H. side baggage compartment, but may have been relocated by the converter. The reflectors provide visible warning of an emergency situation. The three reflectors should be placed as indicated on the box cover. These reflectors comply with FMVSS 125 (Federal Motor Vehicle Safety Standards).

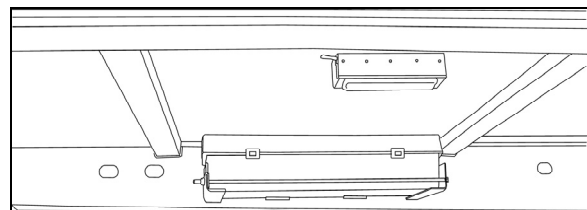

FRONT BAGGAGE COMPARTMENT

**JACK/TOOLS**

A kit for jacking up the vehicle is stored in the first R.H. side baggage compartment, attached to the forward bulkhead of the compartment. The kit includes a:

- 30 ton bottle jack;
- Bumper wrench;
- Wheel nut wrench and lever.

**SPARE PARTS KIT**

The vehicle may be equipped with a spare parts kit (optional). The kit contains parts such as bulbs, circuit breakers, belts, etc. The spare parts kit is stored in the first baggage compartment.

**CHANGING WHEELS**

In case of a flat tire, turn **ON** the hazard flashers and bring the vehicle to a stop on the side of the road. Apply the parking brake. Make sure the vehicle is parked safely away from traffic. Set up the triangular reflectors in accordance with applicable highway regulations.

We suggest that you **do not** attempt to change a wheel. First, the wheel and tire are very heavy and usually there is no space available to put the removed flat. Second, the wheel nuts, especially those on inner dual, can become very tight after being on for only a short time. Often a heavy air wrench is required to get these nuts loose. We suggest you get help via CB radio or cellular phone. There are tire service trucks all over the country that can bring a wheel and make the change safely.

**JACKING POINTS**

Twelve jacking points are located on the vehicle: three are located on each side of the frame and two are located under each axle. Refer to the following illustrations for the location of jacking points.

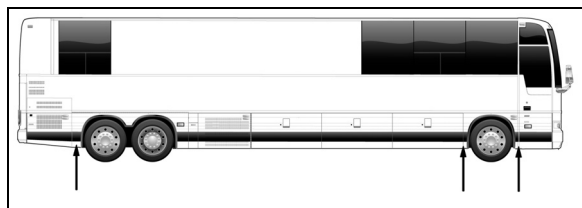

JACKING POINTS ON FRAME

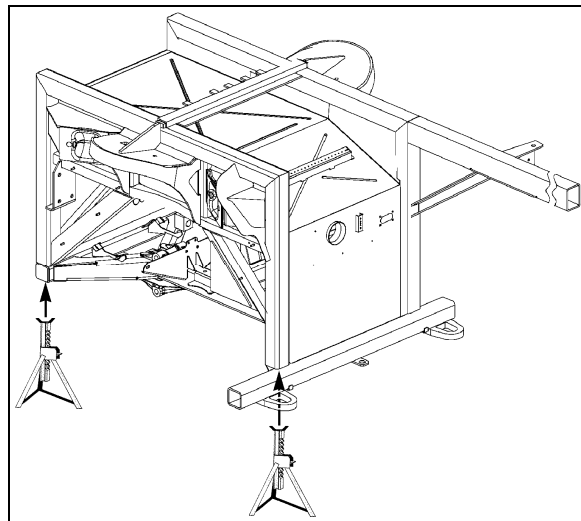

FRONT SUB-FRAME JACKING POINTS

18645

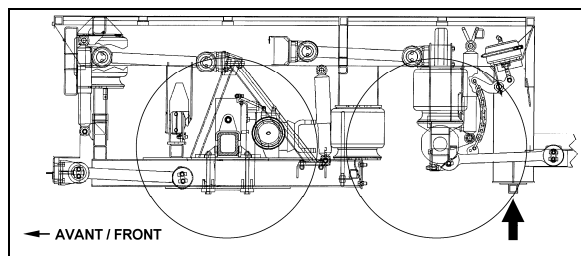

REAR SUB-FRAME JACKING POINTS



**WARNING**

The suspension of the vehicle must be in the normal ride position before jacking. The level low system must be in the **OFF** position prior to turning **OFF** the ignition key.

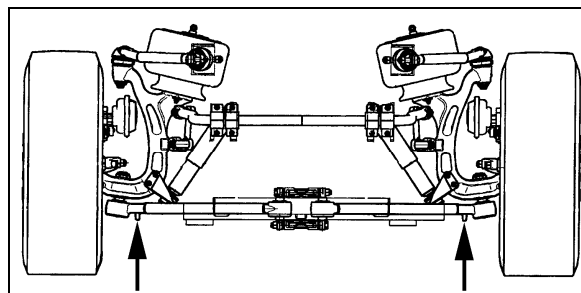

JACKING POINTS ON FRONT SUSPENSION

16139

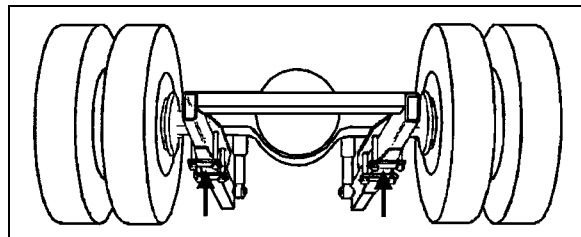

JACKING POINTS ON DRIVE AXLE

11005



**WARNING**

Always retract the tag axle before jacking the vehicle from the front and drive axle jacking points to prevent damage to suspension components.

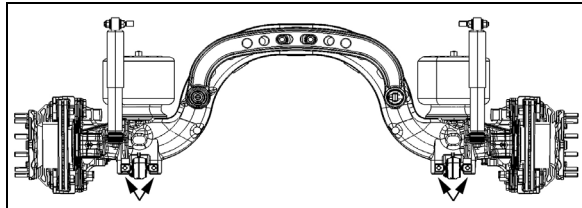

JACKING POINTS ON TAG AXLE

11029



**WARNING**

The jacking points on the tag axle must be used for raising the tag axle only.

Several kinds of hydraulic jacks can be used. Only jack at the specified jacking points. Jack must support the following capacities:

Front axle: 20,000 lb (9 100 kg);

Drive axle: 40,000 lb (18 200 kg).

**HYDRAULIC JACK**

To raise: turn release valve clockwise. Insert handle in socket and raise by pumping.

To lower: remove handle and turn the release valve slowly counterclockwise.

Always keep ram and extension screw retracted when jack is not in use.

Service: Check oil level when jack fails to raise to full height. Lower ram completely with release valve open and jack in upright position, remove filler plug and refill to level of filler hole with hydraulic jack oil. Never use brake fluid.



**DANGER**

Jack is intended for lifting only. Do not get under the vehicle or load for any reason unless it is properly supported with safety stands and securely blocked.



**DANGER**

Do not overload jack above rated capacity. Prevent "side loading", make sure load is centered on ram. Do not push or tilt load off jack.

**TOWING**

To prevent damage to the vehicle, use the two tow eyes located under the back bumper and/or fixed to the vehicle's frame between the front axle and the front bumper. Use only a solid link tow bar and a safety chain to tow the vehicle. If required, connect an auxiliary air supply to the vehicle so brakes can be operated while towing.

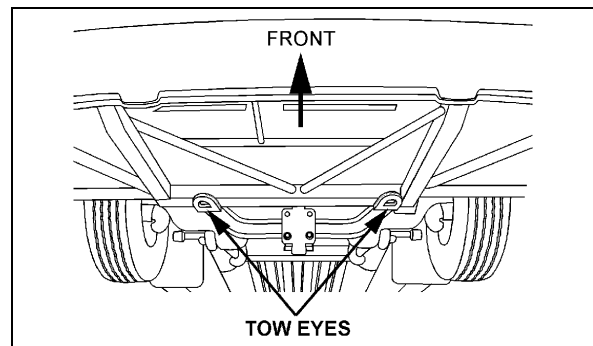

TOW EYES

18003A



**DANGER**

During a towing operation, the driver should be alone inside the vehicle.



**CAUTION**

To prevent damage to the drive train components, disconnect axle shafts or driveshaft before towing. Do not attempt to push or pull-start a vehicle equipped with an automatic transmission.

**NOTE**

*Make sure axle shafts or driveshaft are installed correctly after towing. Tighten axle shaft and driveshaft nuts to the correct torque settings. Do not invert shafts.*



## DAYTIME RUNNING LIGHTS

The low beams come *ON* automatically at reduced intensity when the engine is started and the parking brake is released. The daytime running lights provide added safety by making the traveling vehicle more visible to other drivers.

The lights are not used when:

- Engine is stopped;
- Parking brake is applied;
- The exterior lighting switch is turned to the OFF position.

 <b>WARNING</b>
<p>Do not drive with the daytime running lights at night. For night driving, turn <i>ON</i> the headlights by depressing the exterior lighting rocker switch to the second position. The daytime running lights do not provide sufficient illumination for safe driving at night.</p>

## FOG LIGHTS

Fog lights provide better visibility in fog and precipitation. They improve visibility immediately in front of the vehicle. They also provide added safety.

<i><b>NOTE</b></i>
<p><i>Some states or provinces may restrict the use of fog lights. Verify local state or provincial regulations before using.</i></p>

## CORNERING AND DOCKING LIGHTS

The vehicle may be equipped with up to four halogen cornering lights. Two lights are installed at the front of the vehicle, on each side as standard equipment. Two optional lights may be installed on each side at the rear of the vehicle. When activated, the front lights illuminate at the same time as the turn signal flashers to increase lateral visibility while turning. The rear lights illuminate when the reverse (R) range is selected to increase visibility while backing-up the vehicle. All four lights will illuminate when the docking position is selected using the rocker switch. Refer to chapter: "Controls and Instruments".

## COMPARTMENT LIGHTING

Baggage and front service compartment lights are automatically turned *ON* when the corresponding compartment door is opened. A telltale light on the dashboard illuminates when the baggage compartment door is open.

## MUD FLAPS AND SPLASH GUARDS

Mud flaps are installed behind each front and tag axle wheel in order to minimize dirt on the lower panels of the vehicle and prevent stones and debris from being thrown at vehicles traveling behind the vehicle. Splash guards may be installed behind each dual wheel of the drive axle to prevent stone projectiles from being thrown at the tag axle wheels.

## BACK-UP CAMERA

An optional back-up camera is available which provides the driver with visual assistance when backing-up.

The TV monitor may be mounted on the left side pillar. It switches *ON* automatically when the transmission is in the reverse (R) range.

## BACK-UP ALARM

The back-up alarm alerts pedestrians and other drivers when the vehicle is being backed-up. Take extra precautions whenever backing-up. If necessary, use a guide to provide directions when backing-up. Both the alarm and optional camera are automatically activated when the transmission is put in the reverse (R) range.

## BACK-UP ALARM CANCEL SWITCH

A rocker switch located on the L.H. side dashboard panel allows the driver to cancel the back-up alarm system (as for example: at night on a camping site).

<i><b>NOTE</b></i>
<p><i>After use, return to normal operation.</i></p>



<b>CLEANING</b> .....	<b>131</b>
SEAT UPHOLSTERY .....	131
PLASTIC AND VINYL .....	132
WINDOWS .....	132
STAINLESS STEEL .....	132
FORMICA .....	132
CARPET .....	132
RUBBER COMPONENTS .....	132
FLOOR CLEANING .....	132
EXTERIOR SURFACES .....	132
WINDSHIELD .....	133
<b>FLUID LEVEL VERIFICATION</b> .....	<b>133</b>
ENGINE OIL LEVEL .....	133
TRANSMISSION OIL LEVEL .....	134
POWER STEERING FLUID LEVEL .....	135
COOLING FAN RIGHT ANGLE GEARBOX OIL LEVEL .....	136
DRIVE AXLE WHEEL BEARING OIL LEVEL .....	136
FRONT AND TAG AXLE WHEEL HUBS .....	136
COOLANT FLUID LEVEL .....	136
WINDSHIELD WASHER & HEADLIGHTS WASHER RESERVOIRS .....	137
<b>OTHER VERIFICATIONS</b> .....	<b>137</b>
AIR TANK PURGE .....	137
FIRE EXTINGUISHERS .....	138
FUEL FILTER / WATER SEPARATOR .....	138
AIR COMPRESSOR BELT TENSION ADJUSTMENT .....	139
FAN AND ALTERNATOR DRIVE BELTS .....	139
BACK-UP CAMERA .....	139
AIR FILTER RESTRICTION INDICATOR .....	139
A/C AND HEATING SYSTEM AIR FILTERS .....	140
HOSE INSPECTION .....	140
LUBRICATION .....	141
WHEELS AND TIRES .....	141
WHEEL BEARINGS .....	141
SERVICE BRAKE TEST .....	141
PARKING/EMERGENCY BRAKE TEST .....	141
<b>EXTERIOR LIGHTING VERIFICATION</b> .....	<b>141</b>
<b>GENERAL RECOMMENDATIONS</b> .....	<b>143</b>

**130 Care and Maintenance**

---

**COMPONENTS IDENTIFICATION ..... 145**  
**WALK-AROUND INSPECTION (BEFORE EVERY TRIP) ..... 146**

**CLEANING**

The cleaning information provided in this section is regarded as recommended cleaning practices. Cleaning results may vary depending on the condition of the stain. Always clean stains promptly for best results.

*NOTE*  
 Use only approved cleaning products such as PrevoSt A.P.C., all purpose cleaner (PrevoSt # 683664). Never use stain protection products on new fabrics. To prevent permanent staining of fabrics, clean stains soon after they occur. Incorrect treatment of stains can worsen them. Get help from a cleaning specialist to remove stubborn stains.

 **CAUTION**  
 Custom fabrics and materials may require different cleaning and maintenance practices. Consult your converter.

**SEAT UPHOLSTERY**

Firmly beat the fabric with a blunt object, such as a wooden paddle, to release dust and dirt. Vacuum the seat fabric in the direction of the stitching using an upholstery nozzle.

*NOTE*  
 The abrasive nature of dirt and grit. will reduce upholstery life expectancy. Vacuum regularly.

**Removal Of Stains And Marks**

Depending on the nature of the stain, apply one of the two methods explained below to remove stains and marks on wool plush.

Method One:

1. Apply a nonflammable solvent (Trichloroethylene) to stained area with a clean, white absorbent rag;
2. Clean stain by starting at the outer edges of the stain and working in toward the center;
3. Blot affected area frequently with a clean, dry absorbent cloth to prevent stain rings caused by excess solvent.

 **DANGER**  
 Use solvents in a well ventilated area. Open all windows and doors.

Method Two

1. Wet the stain with a solution of household detergent and lukewarm water. Do not soak the stain;
2. Rub the stain with a damp cloth;
3. Rinse cloth after each application.

 **CAUTION**  
 Do not use soap, soap powder, ammonia, soda, bleach or cleaning products containing any of these compounds.

**Beverage Stains**

Remove beverage stains by following method one. If stain persists, repeat method one using methylated spirits instead of solvent.

**Alcoholic Beverage Stains**

Remove alcoholic beverage stains by wetting the stain with water, then cleaning following method two.

**Burns**

Scrape burnt area using a knife or razor blade then clean following method two. Consult an upholstery specialist when dealing with extensive burns.

**Cosmetic Stains**

Remove stains left by cosmetics by following method one then method two.

**Ink Stains**

Remove ink stains following method two. If stain persists, apply a warm oxalic acid solution. Rinse with water.

**Blood, Urine Or Vomit Stains**

Remove such stains by following method two.

**Copying Ink - Ball-Point Pen Ink**

Treat with methylated spirits, blotting frequently to avoid spreading stain, followed by method two.

**Marking Ink (Felt-tip Pens)**

Treat with Methyl-Ethyl-Ketone (MEK) followed by method two.

**Oil, Grease And Paint**

Remove excess using a knife. Treat with method one followed by method two. If stain persists, repeat procedure.

**Rust Stains**

Remove rust stains by following method two. Apply a warm oxalic acid solution to stained area. Rinse with water.

**Tar**

Soften tar with benzene, then treat using method one followed by method two.

**Chewing Gum**

Soften gum with cyclohexane. Carefully scrape off stains using a sharp knife or razor blade.

**PLASTIC AND VINYL**

Clean plastic and vinyl trim using a clean damp cloth or sponge. For vinyl trim marks, use a lukewarm all purpose cleaner or a mild saddle soap. Remove water spots and soap traces using a clean damp cloth or sponge. Dry with a clean soft cloth.

Remove grease, tar or oil stains with a clean cloth or sponge and an all purpose or solvent-type vinyl cleaner.

Apply a colorless vinyl or leather protective product to maintain the luster and pliability of the plastic or vinyl surface.

**WINDOWS**

Clean the inside of the windows with a solution of one part vinegar to ten parts water.

**STAINLESS STEEL**

Use a stainless steel cleaner and follow the manufacturer's instructions. Stainless steel cleaning solution may be ordered from Prevost Car Inc. quoting part number 68-0356.

**FORMICA**

Remove stains on formica surfaces with a household detergent, methylated spirits or mineral turps. Clean with a mild abrasive and water solution if stain persists.

**CARPET**

Vacuum carpets regularly to prolong carpet life.

**RUBBER COMPONENTS**

Use only pure water or glycerin to clean stains on rubber components.

 <b>CAUTION</b>
Never use solvents on rubber components.

**FLOOR CLEANING**

Clean vinyl floors with a quality nonionic detergent cleaner. Follow the manufacturer's recommendations for cleaning.

Remove any excess detergent solution using a wet/dry vacuum or mop. Rinse floor with a solution of one part Clorox to ten parts warm water.

Polish dry floor using a high-speed buffer and a smooth red 3-M polishing pad.

Mop floor periodically with a solution of 5 per cent Clorox in warm water.

<i><b>NOTE</b></i>
<i>For custom or special floor covering materials, consult the manufacturer or your converter for information on how to clean and maintain these types of floors.</i>

**EXTERIOR SURFACES**

Frequent washing and waxing of the vehicle exterior will help protect the finish and luster. The paint finish is attacked by the abrasive effects of airborne particles and corrosive pollutants.

Before washing the exterior of the vehicle, close the fresh air dampers using the "REC" button located on HVAC control panel and on the air intake duct in the evaporator compartment. Install keyhole protectors to prevent water from penetrating. Rinse vehicle with water to remove all loose dirt. Wash vehicle using a quality brand car wash soap. Follow manufacturer's recommendations for cleaning. Rinse well with water.

The vehicle exterior should be cleaned, waxed and buffed when water droplets no longer form on the painted surfaces.

 **CAUTION**  
Hot water can damage paint. Keep water cool or lukewarm.

 **CAUTION**  
Make sure cleaning solutions are not harmful to painted surfaces. Read the manufacturer's instructions before using.

 **CAUTION**  
Do not spray water jet directly into fresh air inlet dampers.

 **CAUTION**  
Do not aim high pressure water jet at radiator doors. This could damage the radiator fins.

To prevent corrosion, remove caked-on dirt and road salt from the vehicle underbody using a high pressure water jet. Clean wheel housings, bumpers, muffler, tailpipe and brackets.

Carry out corrosion prevention cleaning at least twice a year. Spray underneath of the vehicle and let soak before cleaning. Let engine and exhaust system cool down before cleaning.

**Tar Or Oil**

Remove tar or oil as soon as possible with an approved automotive tar and oil remover or turpentine. Thoroughly clean area with car wash soap and water. Let dry, then wax.

**Insects**

Remove insect stains as soon as possible with lukewarm soap and water or insect remover.

**Tree Sap**

Remove tree sap or bird droppings with lukewarm soap and water. Do not allow to harden.

**WINDSHIELD**

To prevent windshield wiper streaking, keep silicone sprays away from windshield. Remove road film and wax build-up from windows with lukewarm soap and water or with an alcohol-based cleaning agent. If a chamois is used to

dry and polish glass, use it exclusively for that purpose.

**Wiper Blades**

To avoid tearing frozen wiper blades, loosen them before removing. Remove and clean wiper blades periodically with an alcohol-based cleaning solution. Clean wiper blades using a sponge or soft cloth.

**FLUID LEVEL VERIFICATION**

Periodic inspection of oil level is the most economical and easiest way to help your vehicle perform at its best. Rigorous oil level inspection and replacement will greatly help minimize expensive and unscheduled repairs.

**ENGINE OIL LEVEL**

Check engine oil level when engine is still warm and with vehicle parked on a level surface. Shut OFF engine and wait at least 10 minutes for oil to drain into oil pan before checking. Check engine oil level daily or before each trip. Add oil as required. Do not overfill. Remove dipstick, wipe clean and fully reinsert to ensure an accurate reading. Remove dipstick and check engine oil level.

**Do not** let the oil level fall below the marking on the dipstick. **Do not** overfill so the level is above the upper marking on the dipstick. Add oil through the oil filler pipe as required in order to maintain level within the safe range

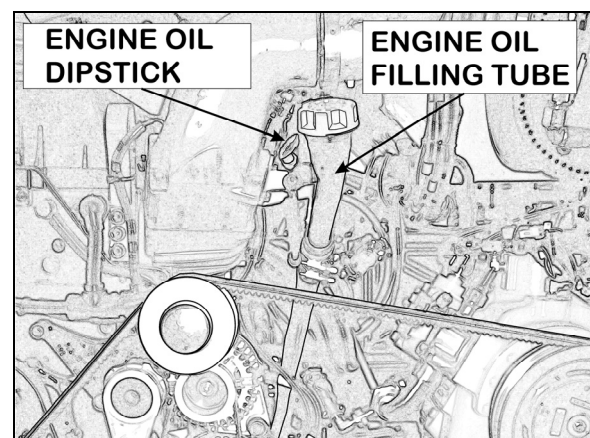

ENGINE BOIL DIPSTICK - VOLVO D13 ENGINE 01192

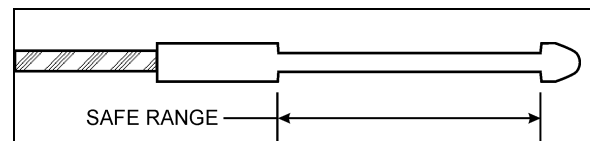

VOLVO D13 ENGINE OIL LEVEL DIPSTICK 01195

**TRANSMISSION OIL LEVEL**

DANGER

To prevent personal injury, do not service transmission wearing loose clothing. Stand clear of the engine and rotating components while checking the oil level.

CAUTION

Do not mix fluid types or brands because of possible incompatibility.

CAUTION

Use clean fluid and containers when filling transmission. Never use containers that have contained water or anti-freeze (Glycol).

**Allison Automatic Transmission Oil Level**

Transmission fluid level may be checked using dipstick or transmission control pad display. For more information on how to use the shift selector display to check the transmission oil level, refer to Appendix C under "Allison transmission oil level check using the pushbutton shift selector" in this manual.

The transmission fluid level dipstick is accessible through the engine compartment rear door and is located on the left side of the engine.

To check the transmission fluid level, a "cold check" and a "hot check" must be performed. A cold check must be made when the transmission fluid is between 60°F and 120°F (16°C and 50°C).

***NOTE***

*Perform the cold check first to verify the transmission fluid level before performing the hot check.*

To prevent dirt and foreign matter from entering the transmission, clean the end of the oil fill tube before removing dipstick. To remove dipstick, unscrew filler cap approximately three turns and pull out dipstick.

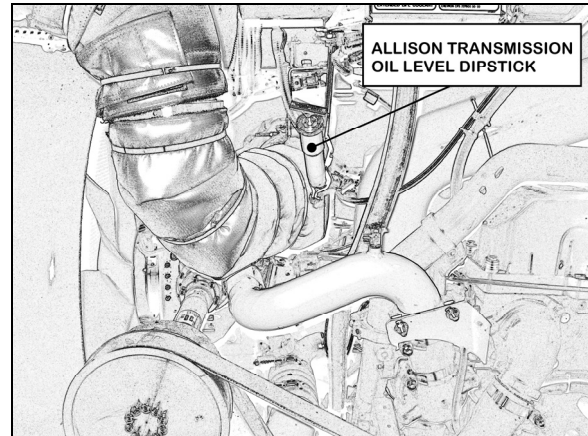

ENGINE L. H. SIDE

01189

- **Cold Check**

Run the engine until the transmission fluid temperature is between 60°F and 120°F (16°C and 50°C). With the engine idling, make sure the parking brake is applied and the transmission is in neutral (N). Remove and wipe the dipstick with a clean cloth. Check oil level. If the oil level is within the COLD RUN band, the oil level is correct and a hot check can be performed. If the oil level is on or below the lower line of the COLD RUN band, add oil until the level lies within the COLD RUN band. If the oil level is above the COLD RUN band, drain oil until the level is within the band.

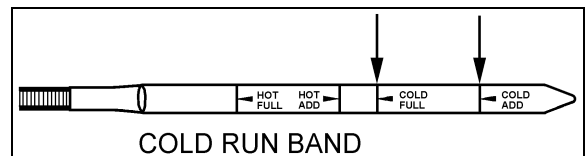

TRANSMISSION FLUID LEVEL DIPSTICK (TYPICAL) 07050

CAUTION

The oil level rises as oil temperature rises. Do not add oil above the "cold run" band before the transmission reaches 180°F to 220°F (82°C to 104°C).

- **Hot Check**

Make sure the transmission fluid temperature is between 180°F and 220°F (82°C and 104°C) before performing the hot check. Run the engine between 1,000 and 1,200 RPM for approximately one minute to purge air from the system. With the engine idling and the parking brake applied, shift transmission from forward (D) to reverse (R) and back into neutral (N) to fill clutch cavities with oil. Remove and clean



dipstick, then check oil level. If the oil level is on or under the lower HOT RUN line, add just enough oil to bring up the level to the middle of the HOT RUN band.

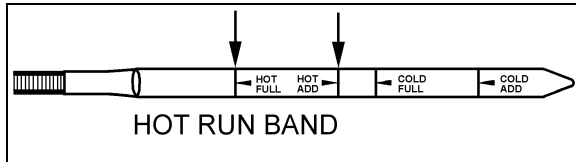

TRANSMISSION FLUID LEVEL DIPSTICK (TYPICAL) 07049

Replace dipstick and tighten the filler tube cap until the rubber seal is correctly seated.



**CAUTION**

Do not overfill transmission fluid reservoir. Severe damage may result.

**I-Shift Transmission Oil Level**

Check the transmission oil level at each service interval. Park the vehicle on a level surface. Check the oil level through the sight glass on the side of the transmission. Add oil as necessary. Always use the correct Volvo approved synthetic oil (Castrol Syntrans SAE 75W85).

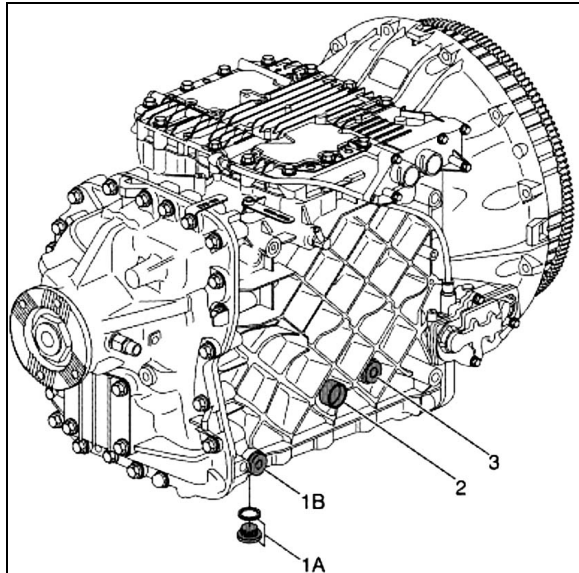

I-SHIFT TRANSMISSION OIL CHANGE

- Vehicle should be on horizontal ground when oil is changed;
- Do not check oil level straight after a journey (incorrect measurement). Undertake the check once the transmission oil has cooled down (lower than 104°F or 40 °C);
- Check oil level using transmission sight glass (2) ;

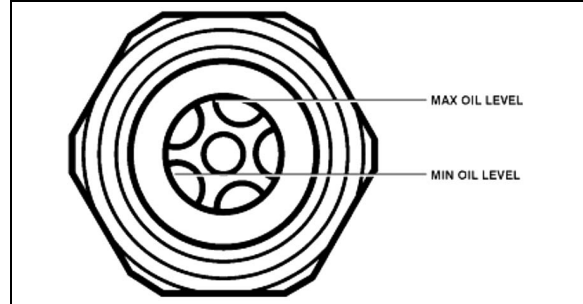
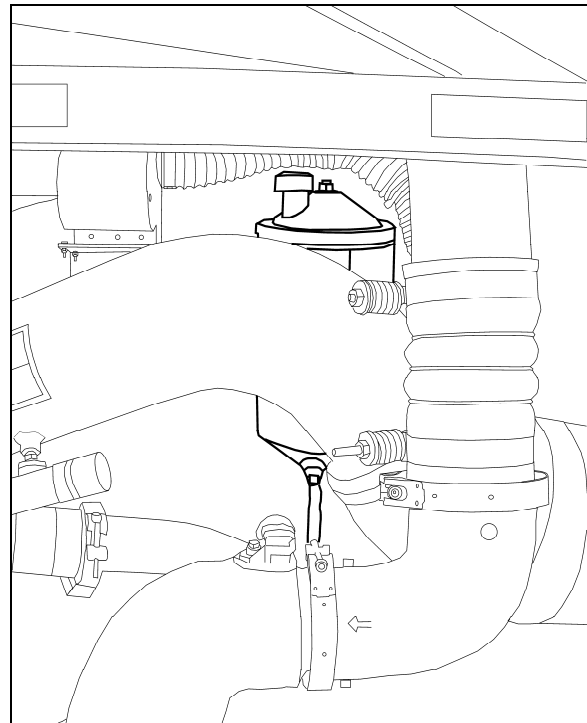

FIGURE 1: SIGHT GLASS FOR CHECKING OIL LEVEL

- Add oil through the oil filling point if necessary (3) ;
- Torque tighten fill plug to 26±4 Lb-Ft (35±5 Nm).

**POWER STEERING FLUID LEVEL**

The vehicle is equipped with a power steering system. The hydraulic fluid tank is located in the engine compartment.



ENGINE COMPARTMENT

14059

Check fluid level as follows:

1. Stop engine, open engine compartment doors and place rear start switch to OFF position;
2. Unscrew and remove the dipstick located on top of the fluid tank and wipe with a clean rag;

3. Replace dipstick in tank, then remove to check fluid level;
4. Add hydraulic fluid until it reaches the FULL mark on the dipstick (use Dexron II, Dexron IIE, Dexron III or Mercon fluid type);
5. Replace and tighten dipstick;
6. Place engine rear start switch to *NORMAL* position. Close engine compartment doors.

**COOLING FAN RIGHT ANGLE GEARBOX OIL LEVEL**

Check cooling fan right angle gearbox oil level as follows:

1. Stop engine, open engine compartment doors and place engine rear start switch to *OFF* position;
2. Remove side oil filler plug;
3. Add oil through the top or side oil filling point if the oil level has fallen below the side oil filling point;
4. The oil level is correct once the top of the oil has reached the bottom of the side oil filling point or once oil has already started to escape from the side oil filling point;
5. Replace the seal and screw the side and top filler plugs back in;
6. Place engine rear start switch to *NORMAL* position. Close engine compartment door.

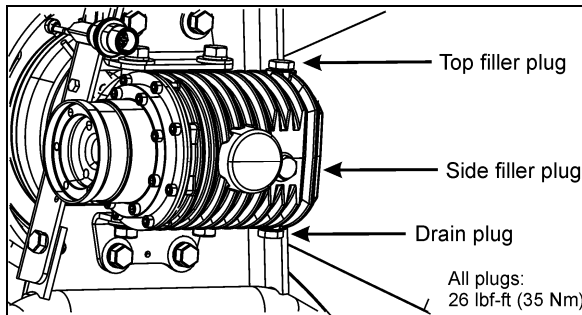

RIGHT ANGLE GEARBOX OIL LEVEL CHECK 05118

**DRIVE AXLE WHEEL BEARING OIL LEVEL**

Drive axle wheel bearings are lubricated by the differential oil. Maintain differential oil at correct level to ensure adequate lubrication of drive axle wheel bearings at all times.

**FRONT AND TAG AXLE WHEEL HUBS**

The unitized hub bearings used on the NDS range of axles, are non-serviceable items. Bearings are pre-adjusted, lubricated and have seals fitted as part of the manufacturing process. The bearings are greased for life and there is no need or facility for re-lubrication.

**COOLANT FLUID LEVEL**

Coolant level is correct when coolant is visible through the surge tank sight glass when cold. If coolant level is low, fill system with the same 50-50 mixture normally used. **Do not** mix two different types of coolant. Refer to the Maintenance Manual for proper coolant type specifications or see the label affixed near the coolant surge tank on the vehicle.

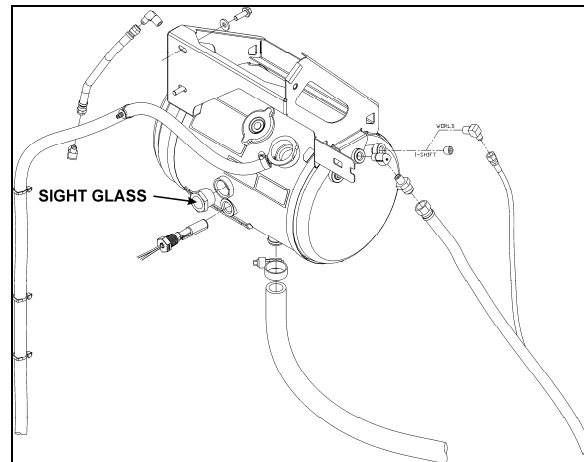

COOLANT LEVEL SIGHT GLASS 05094

**WARNING**

Hot engine coolant is under high pressure. Allow engine to cool down before adding coolant.

**CAUTION**

On Volvo D13 engine, use **only** Extended Life Coolant (ELC). **Do not** add supplemental coolant additives (SCA) to extended life coolant. **Do not** use a coolant filter containing Supplemental Coolant Additives (SCA).

**WINDSHIELD WASHER & HEADLIGHTS WASHER RESERVOIRS**

The windshield washer reservoir and headlights washer reservoir are located in the front service compartment. The windshield washer reservoir has a capacity of 5.3 US gallons (20 liters) while the headlights washer reservoir has a capacity of 2.6 US gallons (10 liters). Check fluid level regularly.

The windshield spray jets are located on the windshield wipers and are angled to spray towards the center of the windshield.

Adjust the headlights washer nozzles according to the instructions found in section 23 of the maintenance manual. You may use water or windshield washer fluid as well.

	<p><b>CAUTION</b></p>
<p>During cold weather days, use windshield washer fluid suitable for freezing temperature only.</p>	

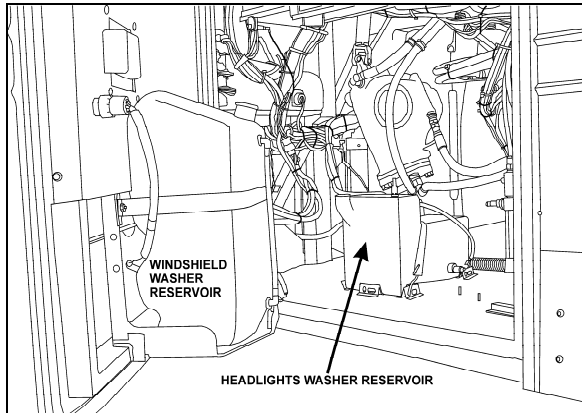

**FRONT SERVICE COMPARTMENT RESERVOIRS** 18381

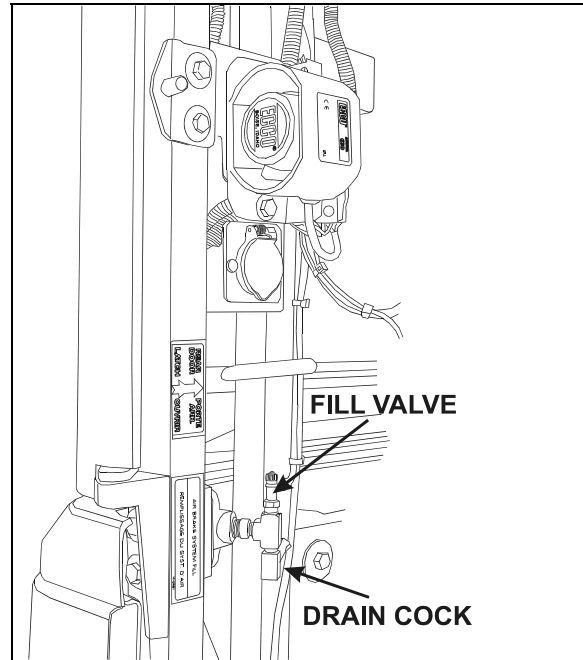

**ENGINE COMPARTMENT** 12130

The accessory air tank drain cock is accessible from the front service compartment. The wet air tank drain cock is accessible from the engine compartment. All air tanks are equipped with a drain cock underneath the tank. Refer to the "Lubrication and Service Check Point Chart" in the "Maintenance Manual" for tank locations.

Drain tanks by turning cocks counterclockwise.

**OTHER VERIFICATIONS**

**AIR TANK PURGE**

The vehicle may be equipped with up to twelve air tanks. Purge accessory and wet air tanks before each trip. The primary and secondary air tanks must be purged at every oil change. Oil changes should be scheduled at least every 12,500 miles (20 000 km).

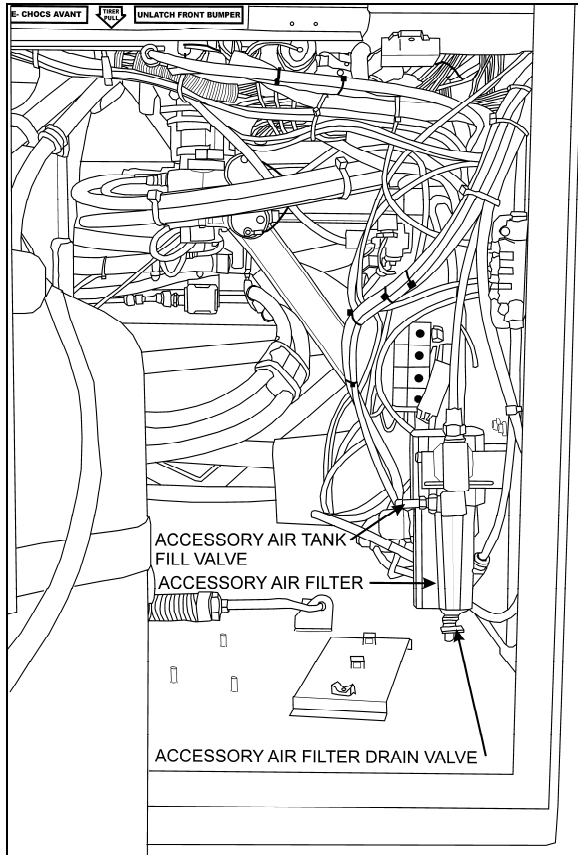

FRONT SERVICE COMPARTMENT

12218

**FIRE EXTINGUISHERS**

Inspect fire extinguishers monthly to insure operation in emergency situations.

On extinguishers with a pressure gauge, the needle should be in the green or *NORMAL* range. Refill or replace extinguisher if pressure is below normal;

Check that seal on handle is intact;

Check that hose nozzle is in good condition and the nozzle is free of obstruction;

Keep fire extinguishers clean.

**FUEL FILTER / WATER SEPARATOR**

A primary fuel filter is installed on the engine. This filter may consist of a filter cartridge with a drain valve at the bottom, or a filter cartridge, a water separation bowl and may have a fuel heater built in. It is used to prevent water from entering the fuel system. The primary fuel filter should be drained periodically or when the telltale light on the dashboard illuminates if equipped with this system. To drain water, loosen the drain valve below the separator. Close the drain valve when finished.

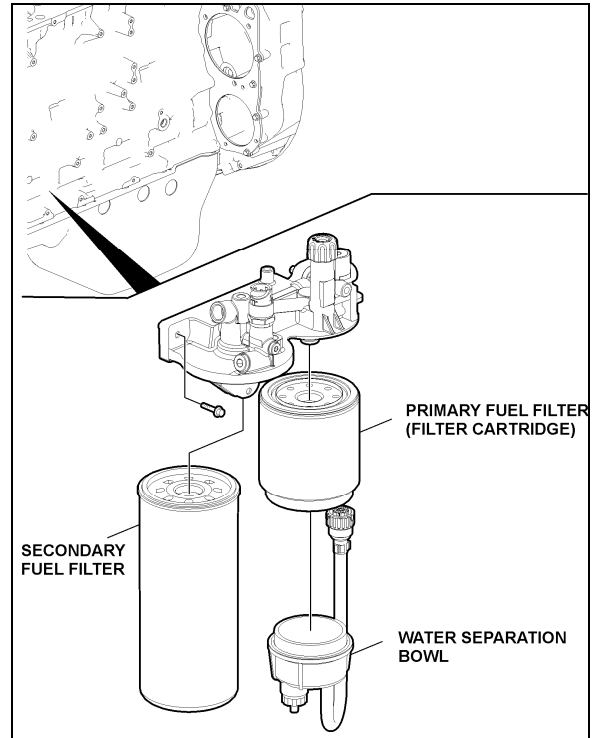

FUEL FILTERS WITH VOLVO D13 ENGINE

03085

The optional Fuel Pro 382 diesel fuel filter system consists of a permanently mounted fuel processor, a replaceable filter element, a filter element cover and collar and a fluid filter base assembly. This system is installed between the fuel tank and the fuel pump and replaces the primary fuel filter. The filter serves as a water separator as well as a fuel filter. To drain, turn ¼ turn the drain valve below filter, close when water has been flushed out.

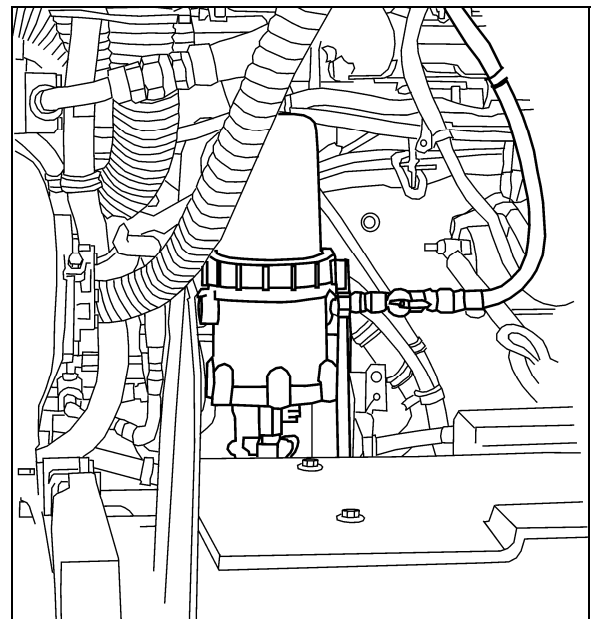

DAVCO FUEL PRO 382 INSTALLATION

03032

**A/C COMPRESSOR BELT TENSION ADJUSTMENT**

The air conditioning compressors are driven by V-belts.

Belt tensioning is applied through air bellows which are adjusted by an air pressure regulating valve mounted in the engine compartment, right behind the belt tensioning pressure control valve. The correct pressure of 35 psi (241 kPa) is set at the factory. Periodically verify the pressure at the regulating valve using a tire pressure gauge and correct if necessary.

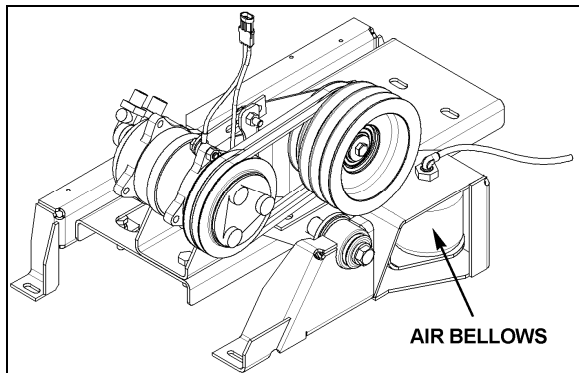

**AIR BELLOWS** 01059

For belt replacement, air pressure must be released from bellows by means of the belt tensioning pressure control valve. This valve, mounted close to the pressure regulating valve, is manually operated. Before handling, be sure that all engine stopping safety precautions have been observed.

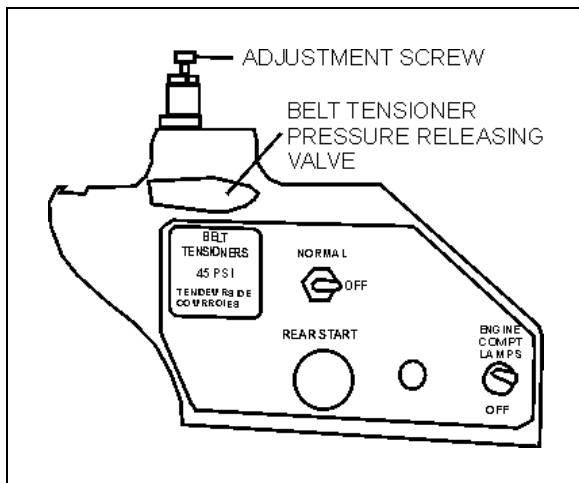

**PRESSURE REGULATING VALVE** 12175

- Refer to the Parts Manual, Maintenance Manual or "Service Bulletins" for recommended belt sizes and tension settings;

- Periodically inspect belt and pulleys for wear or damage;
- Do not treat belts with any compounds. Keep belts dry.

**FAN AND ALTERNATOR DRIVE BELTS**

These belts have automatic belt tensioner to keep the correct tension without adjustment.

**BACK-UP CAMERA**

The optional back-up camera is located on the rear cap. To clean the camera's protective glass, spray with soapy water. Wipe with a clean damp rag or wiper blade.

**! DANGER**

To avoid injury, do not clean camera with transmission in reverse (R). Shut off engine and apply parking brake before cleaning.

**! CAUTION**

To prevent scratches to the camera protective glass, do not wipe with dry rag. Use a clean damp rag.

**AIR FILTER RESTRICTION INDICATOR**

A filter restriction indicator (optional) is used to monitor the vacuum level between the air filter and engine. A red marker is displayed when the air filter is clogged. When a red marker is displayed, the air filter must be replaced. Reset by pressing on the indicator's extremity.

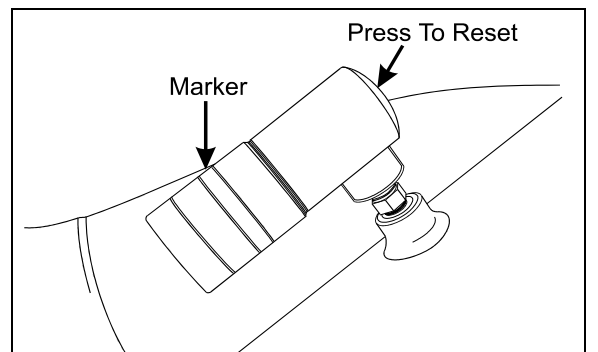

**RESTRICTION INDICATOR** 01052

The filter restriction indicator is located on the engine air intake duct.

**A/C AND HEATING SYSTEM AIR FILTERS**

For maximum air conditioning and heating system efficiency, air filters should be inspected and cleaned as required in maintenance schedule to ensure proper ventilation of the evaporator and heating radiator cores. To clean filters, back flush with water, then dry with air.

**CAUTION**

Do not use high pressure water jet to avoid damaging filter.

**CAUTION**

Be sure not to reverse filter upon installation.

**Driver's HVAC Unit Air Filters**

The driver's HVAC unit air filters are located behind the R.H. console. To gain access to the A/C filters, unscrew the grill located at the top step of the entrance door steps. Remove the filters for cleaning or replacement.

**NOTE**

*If the windshield is continuously fogged, check that the driver's air filters are not clogged.*

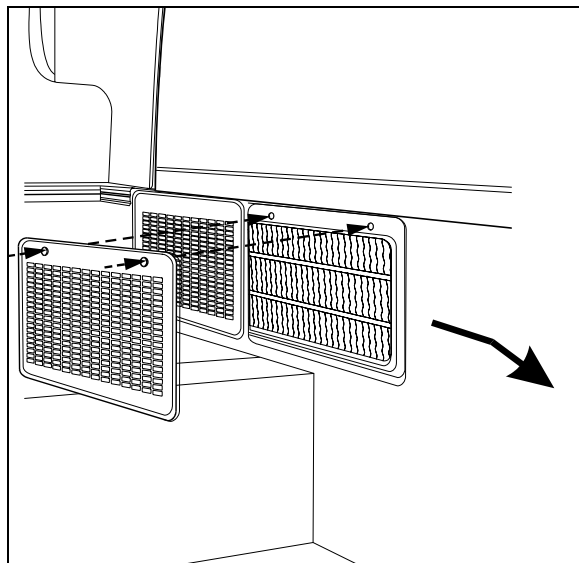

ACCESS TO DRIVER'S HVAC UNIT AIR FILTERS 22172

**Cabin HVAC Unit Air Filters**

The cabin HVAC unit air filters are located in the evaporator compartment on driver's side of the vehicle. To access, open the baggage

compartment forward of the evaporator compartment. An access door held shut by three retaining tabs is located in the wall separating the baggage compartment and the evaporator compartment. Remove the access door, slide out the top then bottom filter for maintenance purposes.

**CAUTION**

Be sure not to install filters in inverted position.

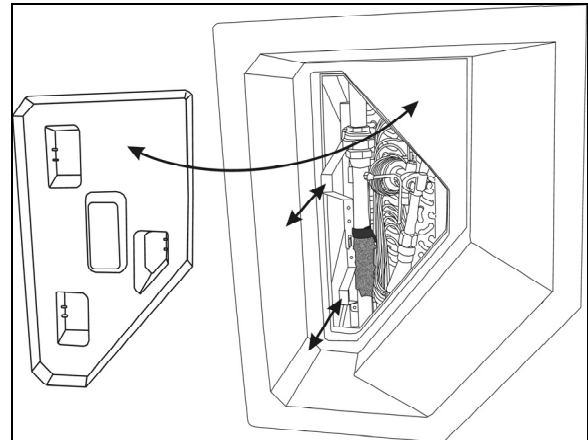

CABIN HVAC UNIT ACCESS DOOR & AIR FILTERS REMOVAL 22178

**HOSE INSPECTION**

Inspect hoses regularly to ensure efficient, economical and safe operation of the engine and related equipment.

Inspect hoses for leaks. Carefully inspect all fittings, clamps and ties. To prevent chafing, make sure hoses are not touching shafts, couplings, heated surfaces, sharp edges or other parts. Since hose clamps and ties can vibrate loose or fail over time, inspect frequently and tighten or replace as necessary.

Correct leaking hoses immediately. Failure to correct leaks can cause severe damage to the equipment, as well as increase operating costs due to lost fluids. Treat fuel and oil leaks as an immediate fire hazard.

**WARNING**

Fire hazard - personal injury and property damage may result from fire caused by leaking flammable fluids.

**Hose Service Life**

Hoses have a limited service life. Thoroughly inspect hoses annually. Look for surface damage or indications of twisted, worn, crimped, cracked or leaking lines. Replace damaged hoses immediately.

Hoses should be replaced during major overhaul or after a maximum of five years service. Make sure replacement hoses match the original equipment manufacturer's specifications.

**LUBRICATION**

Grease all lubrication points during scheduled maintenance. For heavy loads or extended use, lubricate more often. Refer to the end of this chapter or to Maintenance Manual, section 24 for information on lubrication.

**WHEELS AND TIRES**

Check for loose wheel nuts. Both aluminum alloy and steel wheel nuts should be tightened to 450 to 500 foot-pounds (610 to 680 Nm.) torque.

Keep the tires inflated to the recommended inflation pressure to prolong tire life and for safety.

**NOTE**  
*Recommended tire inflation pressures are given in the "Coach Final Record", placed in the technical publications package supplied with the vehicle. The cold tire inflation pressures are on the Department of Transport certification plate located on the L.H. console besides the driver's seat.*

 **WARNING**  
 Do not exceed maximum inflation pressure. Incorrect tire pressure increases tire wear and could lead to loss of driving control because of reduced road handling. Check tire pressure regularly.

**WHEEL BEARINGS**

Check wheel bearing cover for overheating (especially after brake work) during fuel stops by touching the wheel bearing cover.

**SERVICE BRAKE TEST**

Check for correct pressure build-up. Pressure loss should not exceed 3 psi/minute (21 kPa/minute) with engine stopped and without brake applied. Perform a full brake application. Air loss should not exceed 7 psi/minute (48 kPa/minute).

**PARKING / EMERGENCY BRAKE TEST**

Release parking/emergency brakes. Pump service brake pedal until air pressure drops to 65 psi (448 kPa). Make sure the warning buzzer operates and that the emergency brakes apply (the control valve knob lifts up). Allow air pressure to reach 95 psi (655 kPa) before releasing parking brake.

Driving the vehicle while the parking brake is applied should not be possible.

**EXTERIOR LIGHTING VERIFICATION**

**Exterior Lighting Test Mode**

This useful function allows quick verification of the vehicle exterior lights.

**Activating the test mode:**

When the vehicle is stationary (parking brake applied), pull up the multi-function lever 3 times within 3 seconds to activate the test mode. This test can be done when the engine is not running providing that the battery charge is sufficient (above 24.0 volts).

The telltale panel alarm emits a sound each second to remind that the test mode is in progress.

**Stopping the test mode:**

To stop the test mode, pull up the multi-function lever once or turn the ignition OFF or remove the parking brake.

**IMPORTANT NOTE**  
*The test mode is useful to check the functioning of the multiplex outputs and the exterior lights. It doesn't test the functionality of the commands related to the exterior lighting. For a complete testing, the directional signal commands, the headlights commands and the brake pedal have to be checked before. Once these commands tested, activate the test mode to check the exterior lighting.*

### Using the test mode:

First, test the functionality of the commands related to the exterior lighting:

- Activate the right directional signal and check that the corresponding telltale light illuminates.
- Activate the left directional signal and check that the corresponding telltale light illuminates.
- Press on the brake pedal and check that the STOP telltale light illuminates.

Once these commands tested, activate the test mode to check the exterior lighting by pulling up the multi-function lever 3 times within 3 seconds.

Go to the front of the vehicle and check the lights:

- First the left and right directional signals.
- Identification lights and clearance lights.
- Low beams.
- High beams.

Go to the left side of the vehicle:

- Directional signals.
- Marker lights.
- Directional signals.
- Marker lights.

Go to the rear of the vehicle:

- Directional signals.
- Identification lights and clearance lights.
- Stoplights and taillights.
- Back-up lights and back-up alarm (option).

<b><i>IMPORTANT NOTE</i></b>
------------------------------

<p><i>To check the back-up lights and back-up alarm, you must flip the starter selector switch to REAR START position. (If the engine is running, do this quick enough so that the engine does not stop).</i></p>
---

Go to the right side of the vehicle (same sequence as left side).



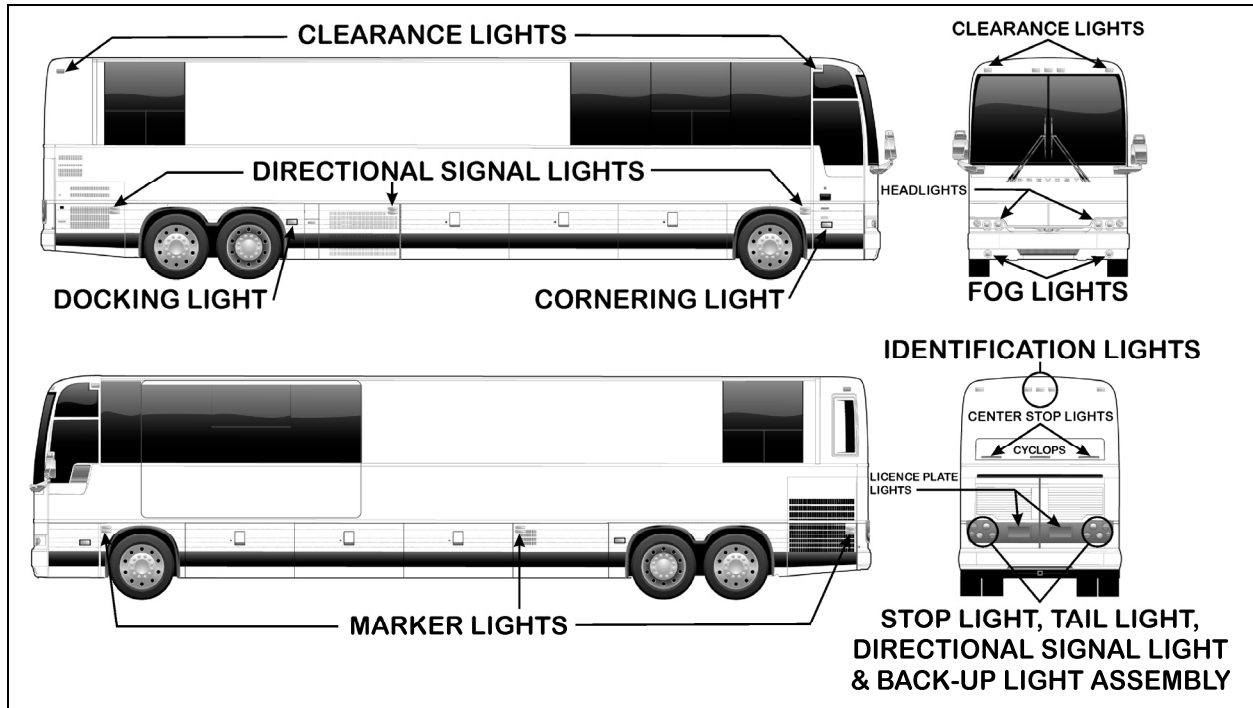

VARIOUS LIGHTS LOCATION

**GENERAL RECOMMENDATIONS**

- Understand basic principles of vehicle operation;
- Always maintain the vehicle in good running condition;
- Do not drive with low fuel. If the fuel tank runs dry, the engine will not start until the air is bled from the fuel system. Refer to "Maintenance Manual" for more information;
- Allow engine to run for at least two minutes at slow idle before shutting OFF;
- Engine should be at idle when shifting from neutral (N) to forward (D) or from neutral (N) to reverse (R);
- The automatic transmission does not have a park (P) position. Place transmission in neutral (N) position and apply parking brake when the vehicle is stopped. A warning buzzer will sound if the engine is stopped and the parking brake has not been applied when foot pressure is removed from the brake pedal;
- Always follow the procedures described in this manual;
- Unless stated otherwise, shut OFF the engine before performing all servicing, lubrication and maintenance tasks;

- Do not attempt to push or pull-start a vehicle equipped with an automatic transmission;
- The vehicle may be damaged if towed with the axle shafts or driveshaft connected. Do not push or pull-start the vehicle in first or reverse gears;
- Two chemical fire extinguishers are stored near the back of the driver's seat. In case of fire, immediately evacuate all occupants. Human life safety is the first priority. Do not attempt to extinguish the fire if there is immediate danger or risk for personal injury;
- When driving on ice and snow, accelerate and decelerate gradually.

	<p><b>WARNING</b></p>
<p>Report all problems affecting passenger or driver safety to your service center or an authorized service center. Have problems corrected immediately.</p>	

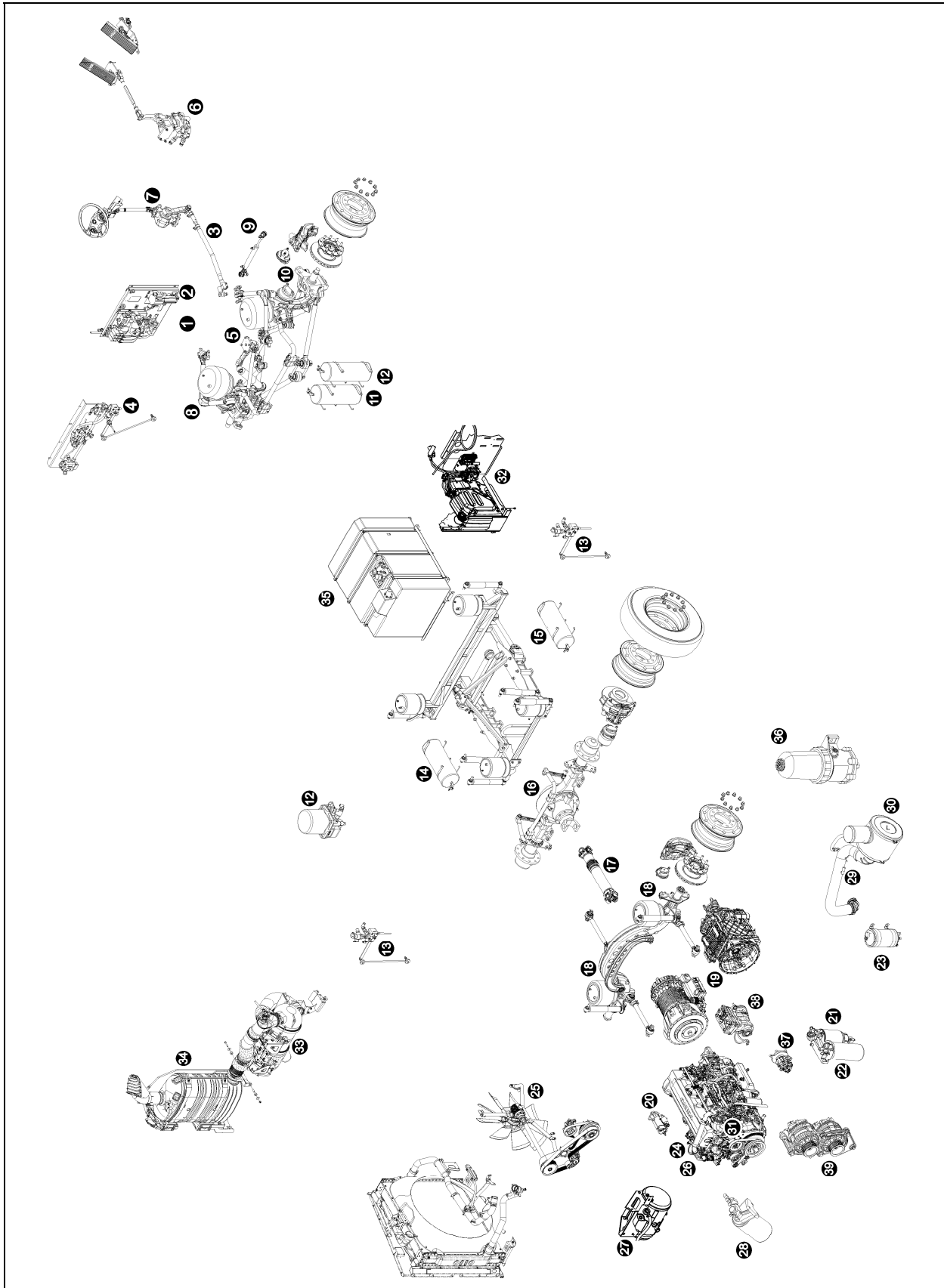

COMPONENTS IDENTIFICATION (REPRESENTATION MAY DIFFER SLIGHTLY FROM AN ACTUAL VEHICLE)

<b>COMPONENTS IDENTIFICATION</b>			
<b>1</b>	<b>Accessories air tank drain cock</b>	<b>21</b>	<b>Primary fuel filter</b>
<b>2</b>	<b>Accessories air filter</b>	<b>22</b>	<b>Secondary fuel filter</b>
<b>3</b>	<b>Steering drag link</b>	<b>23</b>	<b>Power steering fluid tank</b>
<b>4</b>	<b>Height control valve (front)</b>	<b>24</b>	<b>Engine oil filter</b>
<b>5</b>	<b>Bell crank</b>	<b>25</b>	<b>Cooling fan gearbox</b>
<b>6</b>	<b>Dual brake application valve (E-10P)</b>	<b>26</b>	<b>Allison transmission oil dipstick</b>
<b>7</b>	<b>Steering column U-joints</b>	<b>27</b>	<b>Engine coolant surge tank</b>
<b>8</b>	<b>Upper A-arm ball joint</b>	<b>28</b>	<b>Coolant filter &amp; conditioner</b>
<b>9</b>	<b>Hydraulic power cylinder</b>	<b>29</b>	<b>Engine air filter restriction indicator</b>
<b>10</b>	<b>Steering king pin</b>	<b>30</b>	<b>Engine air filter</b>
<b>11</b>	<b>Secondary air tank</b>	<b>31</b>	<b>Engine oil dipstick and filler tube</b>
<b>12</b>	<b>Accessories air tank</b>	<b>32</b>	<b>DEF tank</b>
<b>13</b>	<b>Height control valve (rear)</b>	<b>33</b>	<b>Diesel particulate filter</b>
<b>14</b>	<b>Wet air tank</b>	<b>34</b>	<b>SCR catalytic converter</b>
<b>15</b>	<b>Primary air tank</b>	<b>35</b>	<b>Diesel fuel tank</b>
<b>16</b>	<b>Differential</b>	<b>36</b>	<b>Davco Fuel Pro 382 fuel filter</b>
<b>17</b>	<b>Propeller shaft</b>	<b>37</b>	<b>Power steering pump</b>
<b>18</b>	<b>Tag axle lever pivot</b>	<b>38</b>	<b>Air compressor</b>
<b>19</b>	<b>Transmission</b>	<b>39</b>	<b>Alternators</b>
<b>20</b>	<b>Starter</b>		

**WALK-AROUND INSPECTION (BEFORE EVERY TRIP)**

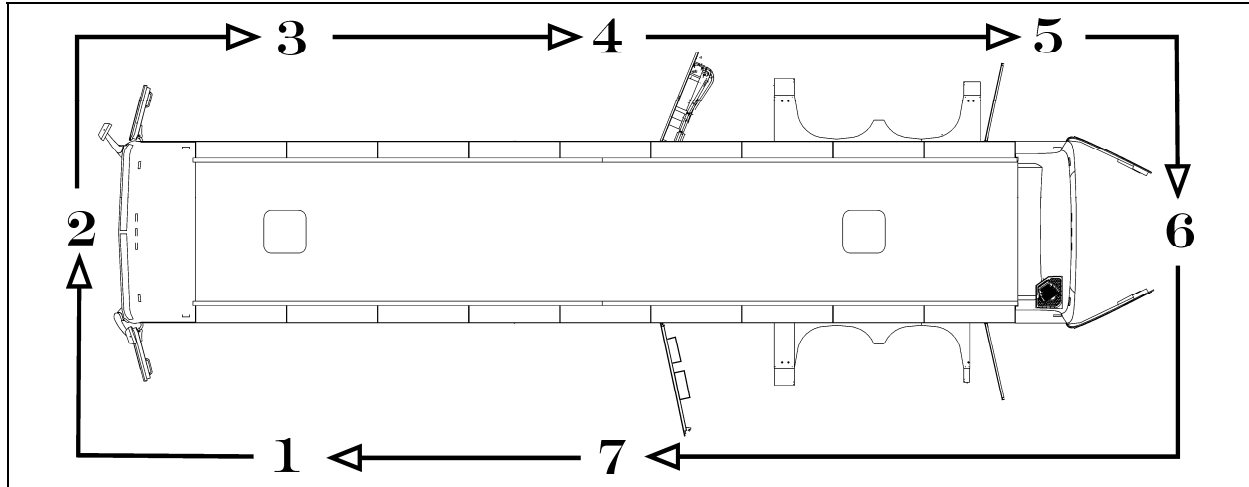

**NOTE**

*Inspect the vehicle in a circular manner as shown in the illustration.*

**Approaching the Vehicle**

- Check under the vehicle for oil, fuel, coolant leaks or other signs of damage.
- Check exterior body surfaces for signs of breaks or damage.
- Check that baggage and service compartment doors are properly closed.

**Preparation**

- Drain accumulated water from accessory and wet air tanks.
- Close air tank drain valves.
- Start the engine and let the air pressure build up to normal. Stop engine.
- Switch on hazard warning flashers.
- Make sure parking brakes are applied.

**Step 1: Front Left Side of the Vehicle**

- Check condition of wheel rim. Especially look for cracks, missing nuts, bent or broken studs.
- Check condition of tire: properly inflated, no serious cuts, bulges, tread wear or any signs of misalignment; valve stem not touching wheel or rim; valve cap in place.

- Check windshield and headlights washer reservoir fluid level and add if necessary.

**Step 2: Front of the Vehicle**

- Check for damage and clean if dirty.
- Check windshield wiper arms for proper spring tension.
- Check wiper blades for any damage, “dead” rubber and attachment to arm.
- Check clearance and identification lights, they should be clean, operating and of the proper color. Refer to “Exterior Lighting Verification” in Care and Maintenance chapter.
- Turn on headlights. High and low beams should be operating and lenses clean. If equipped, check fog lights. Refer to “Exterior Lighting Verification” in Care and Maintenance chapter.
- Left and right front turn signal lights clean, operating and proper color. Refer to “Exterior Lighting Verification” in Care and Maintenance chapter.
- Check to see that there is no mud, snow, ice build-up or other obstruction in front of the ACB radar sensor, if applicable.

**Step 3: Front Right Side of the Vehicle**

- Check condition of wheel rim. Especially look for cracks, missing nuts, bent or broken studs.
- Check condition of tire: properly inflated, no serious cuts, bulges, tread wear or any signs of misalignment; valve stem not touching wheel or rim; valve cap in place.

**Step 4: Rear Right Side of the Vehicle**

- Check condition of wheels and rims. Especially look for cracks, missing nuts, bent or broken studs.
- Check condition of tires: properly inflated, no serious cuts, bulges, tread wear or any signs of misalignment; valve stems not touching wheels or rims; valve caps in place and no objects stuck between the wheels.

**Step 5: Engine Compartment Right Side Area**

- Check engine and surrounding areas for coolant, oil and fuel leaks.
- Check fuel/filter water separator and drain if necessary. Check for leaks.
- Check wiring harness for signs of damage.

**Step 6: Engine Compartment**

- Check engine and surrounding areas for coolant, oil and fuel leaks.
- Check wiring harness for signs of damage.
- Check condition of drive belts.
- Check engine crankcase oil level, add if necessary.
- Check Allison transmission fluid level (can also be checked from push-button shift selector), add if necessary.
- Check power steering reservoir fluid level, add if necessary.
- Check coolant surge tank fluid level, add if necessary.

- Check air cleaner restriction indicator, replace air cleaner when red signal locks in full view.
- Check stop light, tail light, directional signal light and back-up light assembly; operating, clean and proper color. Refer to "Exterior Lighting Verification" in Care and Maintenance chapter.

**Step 7: Rear Left Side of the Vehicle**

- Check condition of wheels and rims. Especially look for cracks, missing nuts, bent or broken studs.
- Check condition of tires: properly inflated, no serious cuts, bulges, tread wear or any signs of misalignment; valve stems not touching wheels or rims; valve caps in place and no objects stuck between the wheels.

**Inside the Vehicle**

- Check for proper operation of the entrance door.
- Check steps; clean them if there is any substance that makes them slippery, which makes vehicle entry/exit hazardous.
- Check that emergency exit windows can be opened then close all windows securely.
- Verify proper operation of windshield wiper/ washer.
- Adjust and clean mirrors for adequate rear view vision.
- Start engine and check for proper operation of all gauges and indicator lights.
- Check for proper operation of electric and air horns and back-up alarm.

Perform a brake test. Check both primary and secondary pressure gauges.



<b>DIMENSIONS AND WEIGHTS</b> .....	<b>152</b>
<b>CAPACITIES</b> .....	<b>152</b>
<b>FUEL TYPE</b> .....	<b>152</b>
BIODIESEL FUELS .....	152
<b>WHEELS AND TIRES</b> .....	<b>153</b>
RECOMMENDED TIRE INFLATION PRESSURE AT MAXIMUM COLD LOAD .....	153
<b>BELTS</b> .....	<b>153</b>
<b>ENGINE</b> .....	<b>153</b>
<b>ALLISON TRANSMISSION</b> .....	<b>153</b>
GEAR RATIOS .....	154
<b>VOLVO I-SHIFT TRANSMISSION</b> .....	<b>154</b>
GEAR RATIOS .....	154
<b>PROPELLER SHAFT</b> .....	<b>154</b>
<b>BRAKES</b> .....	<b>154</b>
BRAKE CHAMBER EFFECTIVE AREA .....	154
<b>AIR SYSTEM</b> .....	<b>154</b>
<b>ANTILOCK BRAKING SYSTEM (ABS)</b> .....	<b>154</b>
TROUBLESHOOTING AND TESTING .....	154
<b>AUTOMATIC TRACTION CONTROL (ATC) – ELECTRONIC STABILITY CONTROL (ESC)</b> .....	<b>154</b>
<b>STEERING</b> .....	<b>155</b>
<b>ELECTRICAL SYSTEM</b> .....	<b>155</b>
<b>SUSPENSION</b> .....	<b>155</b>
INDEPENDENT FRONT SUSPENSION .....	155
DRIVE AXLE .....	155
TAG AXLE .....	155
<b>ALIGNMENT SPECIFICATIONS</b> .....	<b>155</b>
INDEPENDENT FRONT SUSPENSION .....	156
DRIVE AXLE .....	156
TAG AXLE .....	156
<b>COOLING SYSTEM</b> .....	<b>156</b>
<b>FUEL SYSTEM</b> .....	<b>156</b>
<b>EXHAUST SYSTEM</b> .....	<b>156</b>
<b>HEATING AND AIR CONDITIONING</b> .....	<b>157</b>
SMALL HVAC SYSTEM .....	157
COMPRESSOR (for small HVAC system) .....	157
CENTRAL HVAC SYSTEM .....	157
COMPRESSOR (for central HVAC system) .....	157
<b>OIL SPECIFICATIONS</b> .....	<b>157</b>

## 150 Technical Information

---

ENGINE.....	157
ALLISON AUTOMATIC TRANSMISSION.....	157
I-SHIFT TRANSMISSION.....	157
DIFFERENTIAL.....	157
FAN RIGHT ANGLE GEARBOX.....	158
POWER STEERING RESERVOIR.....	158
<b>PLATES AND CERTIFICATION .....</b>	<b>158</b>
SAFETY CERTIFICATION .....	158
DOT CERTIFICATION PLATE .....	159
EPA ENGINE LABEL .....	159
<b>VEHICLE IDENTIFICATION NUMBER (VIN) .....</b>	<b>159</b>
<b>COACH FINAL RECORD .....</b>	<b>159</b>



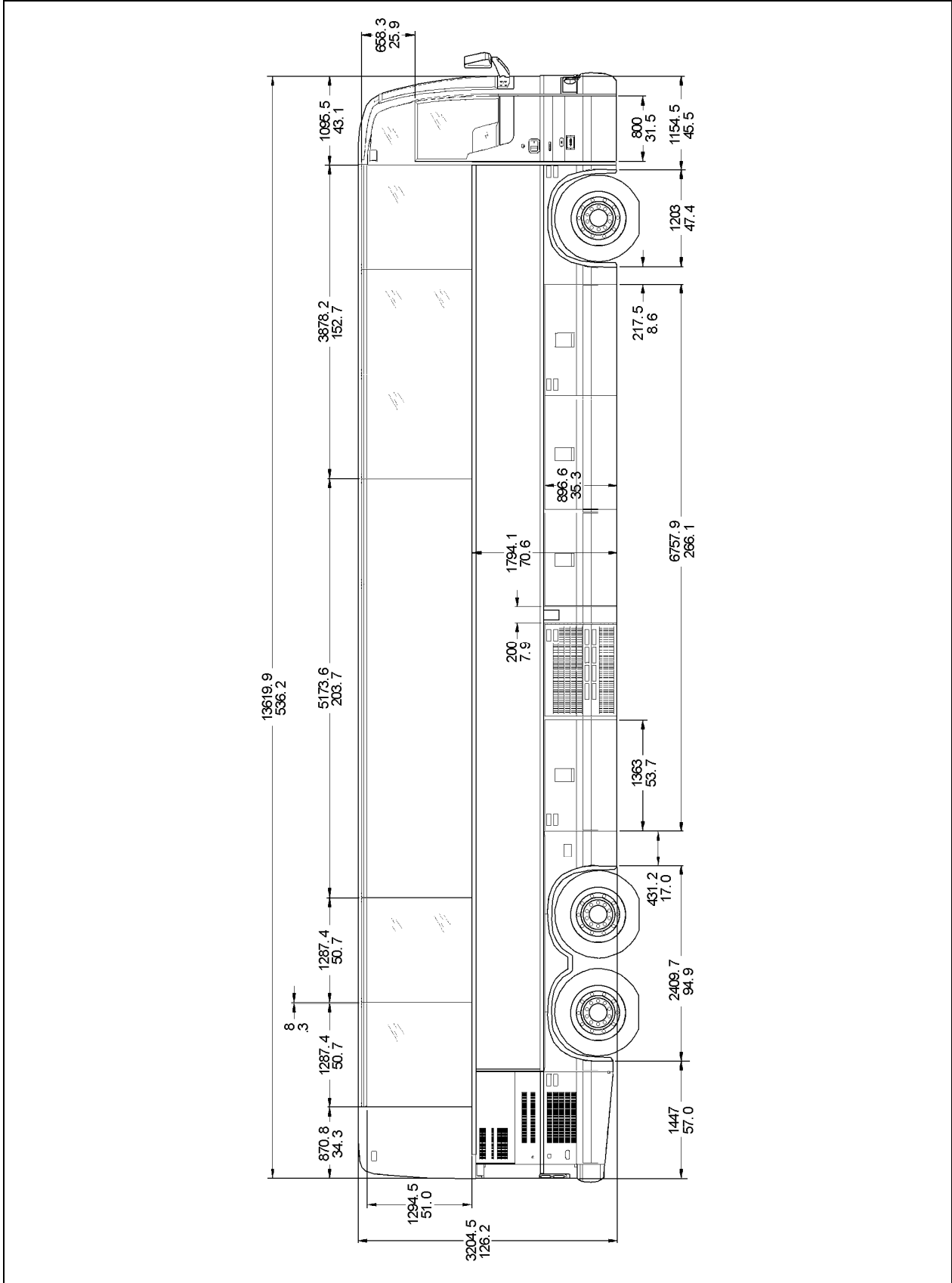

MTH XLII-45E OVERALL DIMENSIONS

DIMENSIONS AND WEIGHTS	X3-45 VIP Le Mirage XLII	
	Overall length (including bumpers)	45' (13,7 m)
Overall width	102" (2,59 m)	
Overall height	148 3/4" (3,78 m)	
Wheelbase (center of front axle to center of drive axle)	X3-45 VIP: 314" (7976 mm) Le Mirage XLII: 339" (8611 mm)	
Floor height from ground	48 1/2" (1,23 m)	
Ground clearance	11" (280 mm)	
Step height from ground	15" (380 mm)	
Step height (other steps)	7" (178 mm)	
Headroom	89" (2261 mm)	
Entrance door opening width	30" (762 mm)	
Front overhang	68 3/4" (1746 mm)	
Rear overhang	X3-45 VIP: 107 3/4" (2736 mm) Le Mirage XLII: 82 3/4" (2102 mm)	
Front track	85.9" (2,18 m)	
Drive track	76.7" (1,95 m)	
Rear track	83.6" (2,12 m)	
Turning circle radius (exterior front corner)	X3-45 VIP: 41'-10" (12751 mm) Le Mirage XLII: 44'-3" (13487 mm)	
	X3-45 VIP	Le Mirage XLII
Curb weight (before conversion)	N/A	N/A
Gross Vehicle Weight Rating (G.V.W.R.)	51,400 lb (22 861 kg)	54,500 lb (24 721 kg)
Front axle Gross Axle Weight Rating (G.A.W.R.)	18,000 lb (8 165 kg)	18,000 lb (8 165 kg)
Drive axle (G.A.W.R.)	21,400 lb (9 253 kg)	22,500 lb (10 206 kg)
Tag axle (G.A.W.R.)	12,000 lb (5 443 kg)	14,000 lb (6 350 kg)

The Gross Vehicle Weight Rating (G.V.W.R.) and the Gross Axle Weight Rating (G.A.W.R.) for front, drive and tag axles are listed on a

certification plate located on the L.H. control panel in driver's section.

CAPACITIES	Le Mirage XLII	X3-45 VIP
Volvo D13 Engine oil (in crankcase)	38 U.S. qrts (36 l)	
Fuel tank (legal capacity equal to 95% of volume)	208 U.S. gal. (787 l)	
Cooling system	24 U.S. gal. (91 l)	
Allison Transmission (does not include external circuit)	6 U.S. gal. (23 l) 6.9 U.S. gal. (26 l) with retarder	
I-Shift transmission	16 U.S. qts (15 l)	
Differential oil	20 U.S. qts (18,7 l)	
Power steering reservoir	4.0 U.S. qts (3,8 l)	
A/C compressor oil	4.5 U.S. qts (4,3 l)	
Windshield washer reservoir	5.3 U.S. gal. (20 l)	
Refrigerant	24.1 lb (11 kg)	

### FUEL TYPE

Diesel engines for 2007 and later model year vehicles are designed to operate only with **Ultra Low Sulfur Diesel** (ULSD) fuel, which can contain no more than 15 ppm sulfur.

	<b>CAUTION</b>
<p>ULSD fuel is necessary to avoid fouling the engine's Exhaust AfterTreatment System. Use of fuel other than ULSD will reduce the efficiency and durability of the engine.</p>	

### BIODIESEL FUELS

ULSD-B5 biodiesel may be used. B5 tells you the percentage of biodiesel mixed in with ULSD. B5 is 5% biodiesel and 95% ULSD.

Fuel used must meet engine manufacturer's specification for biodiesel fuel. Concerning the use of biodiesel with Volvo D13 engines, refer to Volvo's specifications.

Biodiesel fuels are alkyl esters of long chain fatty acids derived from renewable resources. Biodiesel fuels made from soybean or rapeseed oil through the proper transesterification reaction process are recommended. Other feedstock

source of biodiesel fuels such as animal fat and used cooking oils are not recommended. Biodiesel fuels meeting ASTM D6751 specification and from BQ-9000 accredited producer, prior to blending can be mixed up to 5% maximum by volume in petroleum diesel fuel. The resulting mixture must meet the fuel properties of ASTM D975 specification. Failures attributed to the use of biodiesel fuel will not be covered by Volvo or Prevost product warranty. Also, any engine performance problem related to the use of biodiesel fuel would not be recognized nor considered as Volvo or Prevost's responsibility.

**WHEELS AND TIRES**

- Drive Axle Aluminum forged wheels ...9" X 22½"
- Drive Axle Super Single Aluminum forged wheels .....14" X 22½"
- Drive Axle Tires .....315/80 R 22½"
- Tag & Front Axle Wheels ..... 10½" X 22½"
- Tag & Front Axle Tires .....365/70 R 22½"

**RECOMMENDED TIRE INFLATION PRESSURE AT MAXIMUM COLD LOAD**

The recommended tire inflation pressures are given in the applicable documents supplied with the vehicle. In addition, maximum cold tire inflation pressures are listed on the Department of Transport's certification plate, affixed on the panel behind the driver's seat. For special tire selection, a "PREVOST COACH SPECIAL SPECIFICATION" chart is supplied with the vehicle and is affixed next to the DOT certification plate, located on the left wall close to the driver's seat.

**NOTE**  
 Bus Shells vehicles, before being converted, are not at their maximum weight and tire pressures are adjusted at lower level than the maximum allowed appearing on the DOT plate. Tires pressure must be re-adjusted once converted.

**WARNING**  
 Special tire selection may lower maximum allowable speed limit, even below posted speed limit. For maximum safety, check with tire manufacturer.

Vehicles equipped with TPMS: The TPMS target pressures are factory set to equal the prevailing

tire pressure at delivery time. When tire pressures are increased to account for higher vehicle weight, the TPMS set point need to be increased accordingly.

**CAUTION**  
 These tire pressures are established in accordance with the maximum allowable load on each axle. A lower pressure is recommended if the axle load is less than the above specifications. Weigh vehicle fully loaded and pressurize according to tire manufacturer's recommendations.  
 For non standard tire and wheel specifications, see Prévost tire pressure tabulation in "Coach Final Record" or special specification chart affixed next to the DOT certification plate.

**BELTS**

Use	Model	Qty
Cooling fan drive belt	Multi V-14 Rib 14PK2526	1
A/C system 05G compressor	V Belt BX-100 9212-0404	2
A/C small system Sanden compressor	V-Belt A-41 9012-2041	2
Alternator (twin Bosch)	Multi-V-8 Rib 8PK1935	1

**NOTE**  
*Belts specifications may vary. For proper belt selection, always consult your vehicle Coach Final Record.*

**ENGINE**

Volvo D13 engine displacing 12.8 liters. The engine is an inline six cylinder, four stroke, turbocharged, air to air charge cooled, diesel engine with SOHC with 4 valves per cylinder.  
 Power ..... 435 HP (324 kW)  
 Torque.....1,700 lbf•ft (2304 Nm)  
 Power ..... 500 HP (373 kW)  
 Torque.....1,770 lbf•ft (2400 Nm)  
 Recom. cruise speed range ..... 1400-1800rpm  
 Full dress, dry weight ..... 2519 lb

**ALLISON TRANSMISSION**

Allison Transmission MH4000 electronically controlled six speed automatic transmission (MH4000R with the optional output retarder).

**GEAR RATIOS**

1 <sup>st</sup> .....	3.510
2 <sup>nd</sup> .....	1.906
3 <sup>rd</sup> .....	1.429
4 <sup>th</sup> .....	1.000
5 <sup>th</sup> .....	0.737
6 <sup>th</sup> .....	0.639
Reverse .....	4.801
Converter .....	1.9
Differential ratio .....	4.30
Differential ratio (optional) .....	3.91
Differential ratio (optional) .....	4.10
Differential ratio (optional) .....	4.56
Differential ratio (optional) .....	4.88

**VOLVO I-SHIFT TRANSMISSION**

Technologically advanced twelve speed automated mechanical transmission

**GEAR RATIOS**

1 <sup>st</sup> .....	14.94
2 <sup>nd</sup> .....	11.73
3 <sup>rd</sup> .....	9.04
4 <sup>th</sup> .....	7.09
5 <sup>th</sup> .....	5.54
6 <sup>th</sup> .....	4.35
7 <sup>th</sup> .....	3.44
8 <sup>th</sup> .....	2.70
9 <sup>th</sup> .....	2.08
10 <sup>th</sup> .....	1.63
11 <sup>th</sup> .....	1.27
12 <sup>th</sup> .....	1.00
Reverse 1 <sup>st</sup> .....	17.48
Reverse 2 <sup>nd</sup> .....	13.73
Differential ratio .....	2.50
Maximum input torque.....	1850 Lb-Ft (2500 Nm)

**PROPELLER SHAFT**

Hayes-Dana SPL250 type tubular shafts. It is provided with heavy-duty universal joints.

**BRAKES**

The features of the braking system include a dual system where the front and rear circuits are completely independent from each other. The brakes are Knorr air operated disc type brakes with ABS and automatic slack adjusters on front drive and tag axles. Model 24/24 spring brakes on drive axle provide emergency and parking

brakes. Emergency brake application will be automatic if pressure drops below 40 psi. At 60 psi a warning light and buzzer will come on so the driver can bring the vehicle to a safe stop simply by a conventional application of the foot brake pedal.

**BRAKE CHAMBER EFFECTIVE AREA:**

Front axle .....	24 in <sup>2</sup> (service)
Drive axle .....	24 in <sup>2</sup> (service)
.....	24 in <sup>2</sup> (emergency/parking)
Tag axle .....	14-16 in <sup>2</sup> (service)

**AIR SYSTEM**

Compressed air is provided by a twin cylinder, 31.8 cfm Wabco, gear-driven, water-cooled and engine oil lubricated air compressor.

**ANTI-LOCK BRAKING SYSTEM (ABS)**

The anti-lock braking system has one Electronic Control Unit (ECU) controlling a four channel system. One wheel slip sensor is mounted at each front axle and drive axle wheel. The Tag axle wheels are slave to the drive axle wheels.

The Electronic Control Unit (ECU) is maintenance free. Its operating voltage is 24 ± 6 volts DC. The thermal operating range for the ECM is from -40 to 167°F (-40 to 75°C).

The solenoid control valves are maintenance free. Their operating voltage is 24 (+4.8, -2.4) volts DC. The rated current draw is 1.65 amps. The thermal operating range of the solenoid control valves is from -40 to 176°F (-40 to 80°C).

**TROUBLESHOOTING AND TESTING**

For troubleshooting and testing of the vehicle's anti-lock braking system, refer to Meritor WABCO Maintenance Manual: "Anti-Lock Brake Systems For Trucks, Tractors and Buses" or use dashboard Message Center Display (MCD) Diagnostic Mode under ECU Diagnostic: "ABS".

**AUTOMATIC TRACTION CONTROL (ATC) – ELECTRONIC STABILITY CONTROL (ESC)**

In addition to the ABS function, vehicle may be equipped with an advanced model of Bendix EC-60 controller to provide an **Automatic Traction Control (ATC)** feature. Bendix ATC can improve vehicle traction during acceleration, and

lateral stability while accelerating through curves. ATC utilizes **Engine Torque Limiting (ETL)** where the ECU communicates with the engine's controller and/or **Differential Braking (DB)** where individual wheel brake applications are used to improve vehicle traction.

The EC-60 advanced model controller also provides ABS-based stability features referred to as **ESC® Electronic Stability Control**.

Refer to Maintenance Manual, Section 12: Brake and Air System for more information on this system.

 <b>CAUTION</b>
<p>Even with ESC-equipped vehicles, the driver remains responsible for ensuring vehicle stability during operation.</p>

 <b>DANGER</b>
<p><b>ESC may reduce the vehicle speed automatically.</b></p> <p>ESC can make the vehicle <b>decelerate automatically</b>. ESC can slow the vehicle with or <b>without the operator applying the brake</b>, and <b>even when the throttle is being applied</b>.</p>

**STEERING**

- Tilt steering wheel and telescopic steering column
- Volvo hydraulic pump gear driven from engine drive.
- Hydraulic reservoir and dipstick accessible from engine compartment.
- Integral hydraulic assisted steering gear
- System pressure: 2175 psi (15 000 kPa)

**ELECTRICAL SYSTEM**

- 24 volt, negative ground
- 12 volt exterior lighting
- Two 28 volt, 120 amp, self-regulated, belt-driven, air-cooled HD 10 Bosh alternators.
- Four 12 volt, group 31 format maintenance-free batteries connected in series/parallel. Cold cranking capacity is 950 amps (each

battery) with a reserve capacity of 195 minutes.

- 100 amp battery equalizer.
- 12 volt, 145 amp, air-cooled, belt-driven, additional alternator (optional).

**SUSPENSION**

Goodyear rolling lobe type air springs (bellows) are used throughout.

**INDEPENDENT FRONT SUSPENSION**

- 2 Bellows (14.5") for a G.A.W.R. of 18,000 lb;
- 2 Shock absorbers;
- 2 Upper V-Links;
- 2 Lower V-Links;
- 2 Torque rods;
- 2 Steering Levers;
- 1 Leveling valve;
- 1 sway bar (1¾" diameter).

**DRIVE AXLE**

- 4 Bellows (11");
- 4 Shock absorbers;
- 3 Radius rods;
- 1 Panhard rod;
- 2 Leveling valves.

**TAG AXLE**

- 2 Bellows (11");
- 2 Shock absorbers;
- 3 Radius rods;
- 1 Lateral Panhard rod.

**ALIGNMENT SPECIFICATIONS**

Use wheel alignment systems which work with angle measurements only, such as Josam or Hunter systems. Alignment specifications are listed in the following tables:

INDEPENDENT FRONT SUSPENSION						
Load	Minimum value		Nominal value		Maximum value	
	Non-converted	Converted	Non-converted	Converted	Non-converted	Converted
Right camber (degrees)	0.2	-0.150	0.35	0.0	0.55	0.200
Left camber (degrees)	0.2	-0.150	0.35	0.0	0.55	0.200
Right caster (degrees)	2.55		2.8		3.05	
Left caster (degrees)	2.55		2.8		3.05	
Total toe-in (degrees)	0.08		0.10		0.12	

DRIVE AXLE			
	Minimum value	Nominal value	Maximum value
Thrust angle (degrees)	-0.04	0	0.04

TAG AXLE			
	Minimum value	Nominal value	Maximum value
Parallelism (degrees)	-0.02	0	0.02

**COOLING SYSTEM**

- Copper fin radiator and aluminum charge air cooler arranged one behind the other, Valeo made.
- 3 speed fan clutch ECU controlled.
- Rubber insulated from the body.
- Expansion tank above radiator and remote mounted.
- System pressure 14 psi.
- One (1) 185° F thermostat.
- System capacity 24 us gal (DDC S60).
- Coolant filter.
- Radiator fan: 34 inches (WE) or 36 inches (W5) fan, belt and shaft driven.

**FUEL SYSTEM**

208 US gallons polyethylene polyethylene equipped with:

- Anti-spill device.
- Safety filler cap, providing filling access on R.H. side of vehicle.
- Pressure relief valve.
- Electric fuel gage.
- Fuel cooler.
- Low level signal at 26 us gallon/98 liters.
- Primary filter 25 microns (standard).
- Fuel pro 382 filter available as an option as a primary filter.
- Secondary filter 3 to 5 microns.
- Shut-off valve on fuel supply line.

**EXHAUST SYSTEM**

One all stainless steel exhaust system including:

- Catalytic converter to reduce NOx.
- FleetGuard assembly made of a DOC (Diesel Oxidation Catalyst and a DPF (Diesel Particulate Filter). Noise, vibration and heat insulated. This assembly is mounted to the bus structure and is accessible through an exterior access door.
- Tail pipe diffuser and rain deviation device.
- Exhaust pipe with Insulation and a flexible section.
- Exhaust to rear left hand top of rear cap.

## HEATING AND AIR CONDITIONING

Two air conditioning systems are available: the large capacity (central HVAC system) or the small capacity A/C (small HVAC system). Vehicles equipped with the large capacity A/C benefit from a combination heating and cooling system that provides adequate capacity of conditioned and filtered air for all climatic conditions. Fresh air is drawn into the system from the left (driver's) side of the vehicle. Return air is taken from the middle of the vehicle. The driver's heater and defogger are controlled separately from the central unit. An air mixture selector enables air to be drawn into the system from outside the vehicle or recirculated. Driver's air provides cooling for the driver's area only, maximizing available baggage space for other uses. The small capacity A/C enables cooling the driver's area only.

SMALL HVAC SYSTEM	
Air conditioning capacity	2 tons
Refrigerant type	134a
Air flow	450 cfm (12,7 m <sup>3</sup> /min)

COMPRESSOR (For small HVAC system)	
Number of cylinders	7
Operating speed	700 to 6 000 rpm
Oil capacity	6.0 U.S. oz (0,18 l)
Approved oil	SP-20 (PAG)

CENTRAL HVAC SYSTEM	
Air conditioning capacity	7.5 tons
Refrigerant type	134a
Heating capacity	152 000 Btu/h
Air flow	2 600 cfm (73,6 m <sup>3</sup> /min)

COMPRESSOR (For central HVAC system)	
Number of cylinders	6
Operating speed	400 to 2 200 rpm (1,750 rpm, nominal)
Minimum speed for lubrication	400 rpm
Oil capacity	4.5 U.S. qts (4,3 l)
Approved oil	Castrol SW-68 (POE)

### NOTE

The previously mentioned oils are suitable for use with reciprocating compressors using refrigerant R-134a and with evaporator temperatures above -40°F (-40°C).

## OIL SPECIFICATIONS

### ENGINE

Use SAE 15W-40 meeting API classification CJ-4 is required in 2007 diesel engines.

The Volvo D13 engine oil specification is designated EO-O Premium Plus (or VDS-4). EO-O Premium Plus oils exceed the new API service category CJ-4.



### CAUTION

CJ-4 contains less than 1% ash which is key to achieving maximum diesel particulate filter cleaning intervals. Use of high ash engine oils will reduce the cleaning interval on the Diesel Particulate Filter (DPF). DPF regenerates the combustible soot, but the ash (a product of the oil lubricant package) slowly accumulates in the channels of the DPF.

### ALLISON AUTOMATIC TRANSMISSION

Allison Transmission recommends the following fluids:

- Castrol TranSynd™ or TES-295 specification equivalent fluid;
- Dexron-III® automatic transmission fluid;

### I-SHIFT TRANSMISSION

The I-Shift transmission must be filled with Castrol Syntrans grade 75W-85 oil.

### DIFFERENTIAL

Multigrade gear oil meeting MIL-PRF-2105E: 85W/140 is recommended for use in drive axle. This lubricant performs well over a broad temperature range, providing good gear and bearing protection in a variety of climates. If temperature drops below 10°F (-12°C), 80W/90 should be used, and below -15°F (-26°C), 75W/90 should be used. In extreme conditions or for better performance, full synthetic gear oil can be used.

**FAN RIGHT ANGLE GEARBOX**

Use Synthetic Gear Lubricant SAE 75W-90.

**POWER STEERING RESERVOIR**

Use Automatic Transmission Fluid (ATF) Dexron-IIIE or Dexron-III for this system.

**PLATES AND CERTIFICATION**

The main components of the vehicle such as engine, transmission, axles and chassis are identified by different serial numbers. It may be necessary to locate these numbers for warranty purposes.

The engine data plate is located on the rocker cover. The engine serial and model number and a list of the optional engine equipment are written on this plate. Refer to this information when ordering replacement parts. Also the engine data plate certifies that the engine conforms to federal and any state exhaust emissions regulations.

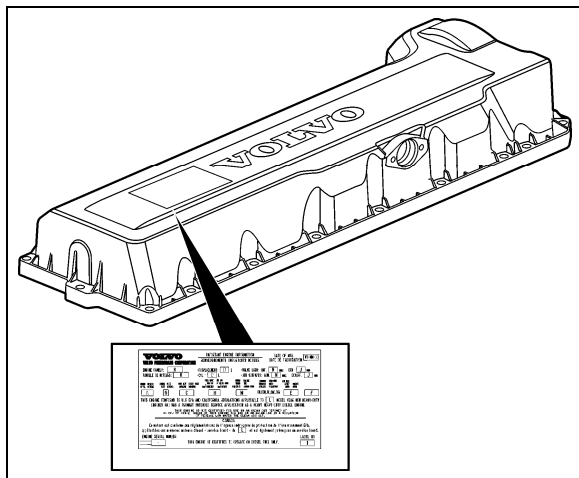

**VOLVO D13 ENGINE DATA PLATE** 00052

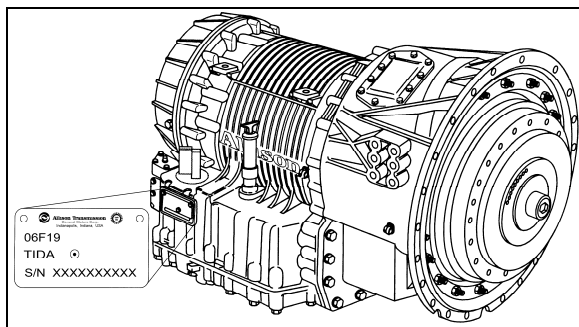

**TRANSMISSION DATA PLATE** 07139

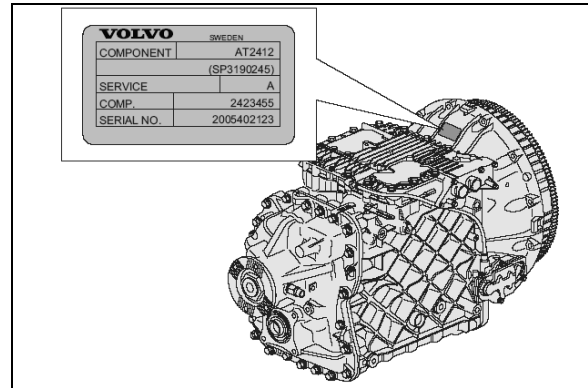

**I-SHIFT TRANSMISSION** 00040

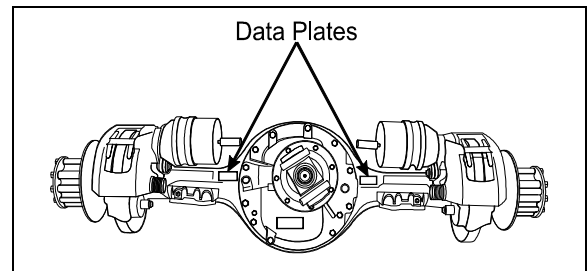

**DRIVE AXLE** 11019

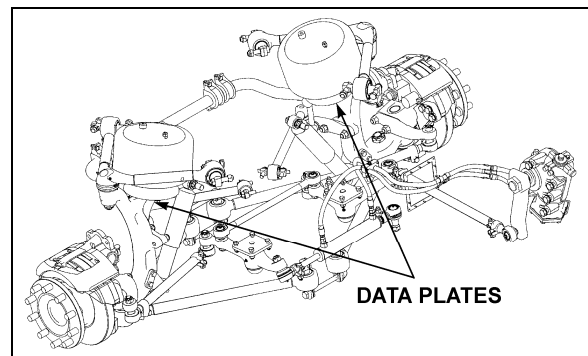

**INDEPENDENT FRONT SUSPENSION** 16176

**SAFETY CERTIFICATION**



Vehicle components meet specifications and standards as follows:

- Material and parts conform to ASTM and/or SAE standards in effect at the time of manufacture.
- All factory-installed interior materials meet FMVSS 302 for fire resistance.
- Certified according to Provincial, State and Federal Safety standards (Canadian and US) BMCSS, FMVSS and CMVSS.
- Other applicable certification labels are affixed to the component.



**DOT CERTIFICATION PLATE**

This certifies that vehicles manufactured by Prévost Car Inc. comply with all Federal Motor Vehicle Safety Standards at the time of manufacture. Information such as gross vehicle weight rating and tire pressure is also marked on this plate. The DOT Certification plate is affixed to L.H. control panel.

		<b>PREVOST</b>			
INCOMPLETE VEHICLE MANUFACTURED BY : PREVOST CAR INC. / VEHICULE INCOMPLET FABRIQUE PAR : STE-CLAIRE, QUE.					
DATE OF MFG. / DATE DE FAB. : _____					
G.V.W.R. : 24721 KG. (54500 LBS). / P.N.B.V. :					
AXLES/ESSELX	G.A.W.R./P.N.B.E.	TIRES/PNEUS	RIMS/JANTES	COLD INFLATION PRESS./ FROID KPA (PSI)	SINGLE OR DUAL SIMPLE OU DOUBLE
FRONT: AVANT:	8165 (18000)	365/70R22.5 (L)	22.5X10.5	724 (105)	S
INT. DIFF.:	10206 (22500)	315/80R22.5 (L)	22.5X9 (OUT) 22.5X8.25 (IN)	655 (95)	D
REAR: PANDEM:	6350 (14000)	365/70R22.5 (L)	22.5X10.5	552 (80)	S
THIS INCOMPLETE VEHICLE CONFORMS TO ALL APPLICABLE U.S. FEDERAL MOTOR VEHICLE SAFETY STANDARDS IN EFFECT ON THE DATE OF MANUFACTURE SHOWN ABOVE. IF COMPLETED IN ACCORDANCE WITH THE INSTRUCTIONS OF INCOMPLETE VEHICLE DOCUMENTS FURNISHED PURSUANT TO CFR PART 568, CONFORMITY TO THE OTHER SAFETY STANDARDS IS NOT SUBSTANTIALLY AFFECTED BY THE DESIGN OF THE INCOMPLETE VEHICLE.					
VEHICLE IDENTIFICATION NO. / NO. IDENTIFICATION VEHICULE : _____					
#405444					

DOT CERTIFICATION PLATE 00016

The Vehicle Identification Number is stamped on a plate located on the windshield frame pillar (driver's side). The VIN is visible from the outside of the vehicle. Make sure the correct vehicle identification number is given when ordering replacement parts. Using the VIN when ordering parts will facilitate processing.

**NOTE**

Record the VIN in the vehicle documentation and keep with company records. The VIN will normally be used for vehicle registration and for obtaining vehicle insurance coverage.

**COACH FINAL RECORD**

The Coach Final Record is a record of all data pertaining to the assembly of the vehicle. This record is shipped to the new customer via a courier company. Retain this record in the company records office for reference and safe-keeping.

**VEHICLE IDENTIFICATION NUMBER (VIN)**

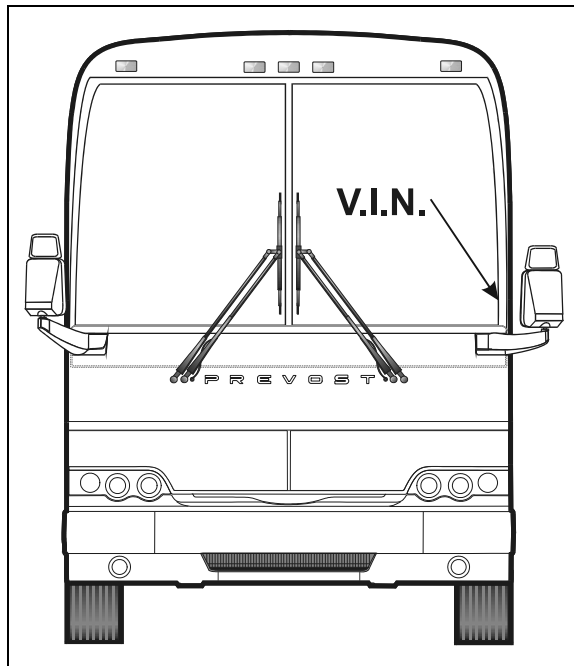

VEHICLE IDENTIFICATION NUMBER 00017



ABBREVIATION	DESCRIPTION
ABS	Antilock Brake System / Système de freinage antiblocage
A/C	Air Conditioning / Air climatisé
AFSS	Automatic Fire Suppression System / Système automatique de détection et d'extinction des incendies
ATC	Automatic Traction Control (Bendix) / Système d'antidérapage automatique
CECM	Chassis Electronic Control Module
CVC	Chauffage, Ventilation et Climatisation / heating, ventilation and air conditioning HVAC
DCDL	Driver Controlled Differential Lock / Verrouillage du différentiel
DDR	Diagnostic Data Reader
DEF	Diesel Exhaust Fluid / Fluide d'échappement diesel FED
DEL	Diode Électroluminescente / Light Emitting Diode LED
DID	Driver Information Display / Écran d'affichage du panneau des instruments
D-MIC	Driver Microphone / Microphone du conducteur
DPF	Diesel Particulate Filter / Filtre à particules
DTC	Diagnostic Troubleshooting Code / Code d'anomalie
DUFS	Diesel Ultra Faible en Soufre / Ultra Low Sulfur Diesel ULSD
ECM	Electronic Control Module / Unité de commande électronique
ECU	Electronic Control Unit / Unité de commande électronique
EECU	Engine Electronic Control Unit / Unité de commande électronique du moteur
EGR	Exhaust Gas Recirculation / Recirculation des gaz d'échappement
ESC	Electronic Stability Control / Dispositif électronique de contrôle de la stabilité
ESC	Escape / Échap
ESP	Electronic Stability Program (Bendix) / Dispositif électronique de contrôle de la stabilité
E+	Eco-Roll
FAP	Filtre À Particules / Diesel Particulate Filter DPF
FDA	Following Distance Alert / Alerte de distance
FED	Fluide d'Échappement Diesel / Diesel exhaust fluid DEF
GECU	Gear selector Electronic Control Unit / Unité de commande électronique du sélecteur de vitesses
G-MIC	Guide Microphone / Microphone du guide
HVAC	Heating, Ventilation and Air Conditioning / Chauffage, Ventilation et Climatisation CVC
IA	Impact Alert / Alerte de collision
IFS	Independent Front Suspension / suspension avant indépendante
LED	Light Emitting Diode / diode électroluminescente DEL
MPH	Miles Per Hour / Milles à l'heure
PPT	Premium Tech Tool
PTO	Power Take Off / Prise de pouvoir
SCR	Selective Catalytic Reduction / Réduction catalytique sélective
TCM	Transmission Control Module / Module de commande de la transmission
TCS	Traction Control System / Dispositif d'antipatinage
TECU	Transmission Electronic Control Unit / Unité de commande électronique de la transmission
TPMS	Tire Pressure Monitoring System / Système de surveillance de la pression des pneus
TWS	Threshold Warning System / Système avertisseur du seuil de porte
ULSD	Ultra Low Sulfur Diesel / Diesel Ultra Faible en Soufre DUFS
VCADS	Outil informatisé de diagnostic
VEB	Volvo Engine Brake / Frein moteur Volvo
VECF	Vehicle Electrical Center Front
VECR	Vehicle Electrical Center Rear
VECU	Vehicle Electronic Control Unit / Unité de commande électronique du véhicule
VSS	Video and Sound Selector / Sélecteur audio-vidéo
WCL	Wheelchair Lift / Système d'élévation de fauteuils roulants



## **Appendix A – Service Literature      163**

---

<b>SERVICE LITERATURE.....</b>	<b>164</b>
<b>NOTICE.....</b>	<b>165</b>
DECLARATION OF THE MANUFACTURING DEFECTS TO THE GOVERNMENT OF THE UNITED STATES .....	165
DECLARATION OF THE MANUFACTURING DEFECTS TO THE CANADIAN GOVERNMENT .....	165
DECLARATION OF THE MANUFACTURING DEFECTS TO PRÉVOST.....	165

## **SERVICE LITERATURE**

Visit our web sit at [www.prevostcar.com](http://www.prevostcar.com) for on-line product information and technical publications!

Additional copies of the following service literature are available upon request and at low cost.

- \* **Maintenance Manual**
- \* **Owner's Manual**
- \* **Parts Manual**
- \* **Service Center Directory**

To order, please call Prevost Parts toll free 1-800-463-8876 or write to:

### **PRÉVOST PARTS INC.**

2955-A Watt Street  
Sainte-Foy, QC G1X 3W1  
CANADA

**Please specify the complete vehicle serial number.**

**Allow 30 days for delivery.**

## **NOTICE**

### **DECLARATION OF THE MANUFACTURING DEFECTS TO THE GOVERNMENT OF THE UNITED STATES**

If you believe that your vehicle has defect which could cause a crash or could cause injury or death, you should immediately inform the National Highway Traffic Safety Administration (NHTSA) in addition to notifying Prévost.

If NHTSA receives similar complaints, it may open an investigation, and if it finds that a safety defect exists in a group of vehicles, it may order a recall and remedy campaign.

However, NHTSA cannot become involved in individual problems between you, your dealer, or Prévost.

To contact NHTSA you may either call the toll-free Auto Safety Hotline at **1-800-424-9393** (or **366-0123**) in the Washington, D.C. area) or write to:

**NHTSA**  
**U.S. Department of transportation**  
**Washington, D.C. 20590**

You can also obtain other information about motor vehicle safety from the Hotline.

### **DECLARATION OF THE MANUFACTURING DEFECTS TO THE CANADIAN GOVERNMENT**

If you live in Canada and you believe that your vehicle has a safety defect, you should immediately inform Transport Canada and Prévost. You may write to:

**Transport Canada**  
**Box 8880**  
**Ottawa, ON K1G 3J2**

### **DECLARATION OF THE MANUFACTURING DEFECTS TO PRÉVOST.**

In addition to notify the NHTSA (or Transport Canada), please contact Prévost at **1-418-831-2046**. Or you may write to:

**Prévost**  
**After-Sales Service Department**  
**850 Olivier Road**  
**St-Nicolas, QC G7A 2N1**  
**CANADA**





## Troubleshooting

Problem/Symptom	Probable Causes	Actions
Vehicle does not Start	Rear Start selector switch is not in the NORMAL position.	<ol style="list-style-type: none"> <li>1. Check that the rear start selector switch is flipped up to NORMAL start position and retry cranking.</li> <li>2. Flip the rear start selector switch to “Rear Start” and start the vehicle from the rear.</li> </ol>
	<p>CAN network problem (Multiplex)</p> <p>Module A53 not powered or is defective</p> <p>Engine ECM does not receive the ignition signal</p> <p>Engine ECM is not powered</p>	<p>If the vehicle does not start from the rear:</p> <ol style="list-style-type: none"> <li>1. Verify that module A53 is powered:                             <ol style="list-style-type: none"> <li>a) Check the SYSTEM DIAGNOSTIC menu of the Driver Information Display (DID). Select FAULT DIAGNOSTIC and ELECTRICAL SYSTEM. The message “No Response ModA53, Active”, indicates a power problem on the module or a CAN network problem.</li> <li>b) Check / reset circuit breakers CB1 and CB9.</li> <li>c) Check / replace fuse F74 and F80.</li> <li>d) Probe gray connector on module to see if it is powered.</li> </ol> </li> <li>2. Verify that the engine ECM is powered and get the ignition signal. Check / replace fuse F78 and F79.</li> </ol>
<p>None of the Multiplexed functions are operating, including the basic limp-home functions (door opening, flashers, wipers in speed 1)</p> <p>Three dashes “---“ appear in the telltale panel instead of the outside temperature</p> <p><i>Note: The sunshades are still functioning since these are not multiplexed</i></p>	<p>The program version in the CECM is different than the program in the I/O modules and the CECM is forcing all I/O modules to stay inactive</p>	<ol style="list-style-type: none"> <li>1. Engage the auto-programming of the I/O modules: Turn the ignition key to the OFF position then turn the ignition key ON. The letters CAN will appear in the telltale LCD panel for about 3 minutes. Everything shall get back to normal once the letters CAN are replaced with outside temperature display.</li> <li>2. Try disconnecting the green connector on the CECM and reconnect.</li> <li>3. If step 1 and 2 are ineffective, try disconnecting the Master ID module completely and repeat step 1.</li> <li>4. Try disconnecting the CECM completely, leave it disconnected and see if the limp-home functions (start of the vehicle from the engine compartment, wipers speed 1, flashers, etc ) are functioning.</li> </ol>

**168 Appendix B – Troubleshooting Guide for Multiplex Vehicles**

Problem/Symptom	Probable Causes	Actions
<p>Many secondary functions (not essential for driving) not functioning (interior lighting, driver's area lighting, wiper speed 2 and intermittent).</p> <p>Outside temperature display in the telltale LCD panel displays three dashes "---"</p> <p>Marker lights and clearance lights are turned ON when setting ignition to the ON position.</p>	<p>The CECM module does not receive 24 V power.</p> <p>The CAN network is not working. It could be caused by a short on the network, an open circuit, a problem with the CECM or the CECM being disconnected from the network.</p>	<ol style="list-style-type: none"> <li>1. Check / reset circuit breaker CB2 (2<sup>nd</sup> from the bottom. Check / replace fuse F1.</li> <li>2. Operate in limp-home mode by starting the vehicle from the engine compartment (REAR START). All functions essential to drive are available.</li> </ol>
<p>No temperature control in the cabin area.</p> <p>Cabin temperature display indicates two dashes "--"</p>	<p>Problem with the temperature sensor located in the evaporator compartment air intake or the sensor wiring.</p>	<p>Manually control the temperature by playing with the cabin (passenger) set point. Set above 22°C (72°F) to heat and below 22° C (72°F) to cool.</p>
<p>Defroster fan not functioning</p> <p>Windshield wipers not functioning in speed 1 or intermittent</p>	<p>Module A47 is not powered or is faulty</p>	<ol style="list-style-type: none"> <li>1. Check the SYSTEM DIAGNOSTIC menu of Driver Information Display (DID). Select FAULT DIAGNOSTIC and ELECTRICAL SYSTEM. The message "No Response ModA47, Active" indicates a power problem on the module. (A CAN network problem would show the same message but doesn't produce these symptoms).</li> <li>2. Check / reset circuit breaker CB3.</li> <li>3. Check / replace fuse F5 and F16.</li> <li>4. Probe gray connector on module to see if it is powered.</li> </ol>
<p>Windshield wipers not functioning in speed 1 or intermittent</p>	<p>No power on R23</p>	<p>Check / replace fuse F82</p>
<p>HVAC condenser fans not functioning in speed 1</p>	<p>Circuit breaker CB7 tripped and not reset</p>	<p>Check / reset circuit breaker CB8</p>
<p>HVAC condenser fans not functioning in speed 2</p>	<p>Circuit breaker CB7 tripped and not reset</p>	<p>Check / reset circuit breaker CB5</p>
<p>Windshield washer not functioning</p>	<p>Module A46 is not powered or is faulty</p>	<ol style="list-style-type: none"> <li>1. Check the SYSTEM DIAGNOSTIC menu of Driver Information Display (DID). Select FAULT DIAGNOSTIC and ELECTRICAL SYSTEM.</li> </ol>

Problem/Symptom	Probable Causes	Actions
Defroster fan is functioning but no heat or cooling available in the driver area.		<p>The message “No Response ModA46, Active” indicates a power problem on the module. (A CAN network problem would show the same message but doesn't produce these symptoms).</p> <ol style="list-style-type: none"> <li>2. Check / reset circuit breaker CB3.</li> <li>3. Check / replace fuse F12 or F13.</li> <li>4. Probe gray connector on module to see if it is powered.</li> </ol>
<p>Low beam headlights and front flasher on left side not functioning</p> <p>Electric horn not functioning</p>	Module A45 is not powered or is faulty	<ol style="list-style-type: none"> <li>1. Check the SYSTEM DIAGNOSTIC menu of Driver Information Display (DID). Select FAULT DIAGNOSTIC and ELECTRICAL SYSTEM. The message “No Response ModA45, Active” indicates a power problem on the module. (A CAN network problem would show the same message but doesn't produce these symptoms).</li> <li>2. Check / reset circuit breaker CB1.</li> <li>3. Check / replace fuse F33 and F34.</li> <li>4. Probe gray connector on module to see if it is powered.</li> </ol>
Low beam headlights and flasher on right side not functioning	Module A48 is not powered or is faulty	<ol style="list-style-type: none"> <li>1. Check the SYSTEM DIAGNOSTIC menu of Driver Information Display (DID). Select FAULT DIAGNOSTIC and ELECTRICAL SYSTEM. The message “No Response ModA48, Active” indicates a power problem on the module. (A CAN network problem would show the same message but doesn't produce these symptoms).</li> <li>2. Check / reset circuit breaker CB1.</li> <li>3. Check / replace fuse F33 and F34.</li> <li>4. Probe gray connector on module to see if it is powered.</li> </ol>
<p>Rear flashers not functioning</p> <p>Stoplights and center stoplights not functioning</p>	Module A51 is not powered or is faulty	<ol style="list-style-type: none"> <li>1. Check the SYSTEM DIAGNOSTIC menu of Driver Information Display (DID). Select FAULT DIAGNOSTIC and ELECTRICAL SYSTEM. The message “No Response ModA51, Active” indicates a power problem on the module. (A CAN network problem would show the same message but doesn't produce this symptom).</li> </ol>

**170 Appendix B – Troubleshooting Guide for Multiplex Vehicles**

Problem/Symptom	Probable Causes	Actions
		<ol style="list-style-type: none"> <li>2. Check / reset circuit breaker CB1.</li> <li>3. Check / replace fuse F80.</li> <li>4. Probe gray connector on module to see if it is powered.</li> </ol>
<p>Engine is overheating and radiator fan clutch does not engage</p> <p>The A/C compressor clutch does not engage</p>	<p>Module A52 is not powered or is faulty</p>	<ol style="list-style-type: none"> <li>1. Check the SYSTEM DIAGNOSTIC menu of Driver Information Display (DID). Select FAULT DIAGNOSTIC and ELECTRICAL SYSTEM. The message “No Response ModA52, Active” indicates a power problem on the module. (A CAN network problem would show the same message but doesn't produce this symptom).</li> <li>2. Check / reset circuit breaker CB7.</li> <li>3. Check / replace fuse F65.</li> <li>4. Probe gray connector on module to see if it is powered.</li> </ol>
<p>Evaporator fan not functioning</p>	<p>Circuit breaker CB4 tripped</p> <p>Module A54 is not powered or is faulty</p>	<ol style="list-style-type: none"> <li>1. Check / reset circuit breaker CB4.</li> <li>2. Check the SYSTEM DIAGNOSTIC menu of Driver Information Display (DID). Select FAULT DIAGNOSTIC and ELECTRICAL SYSTEM. The message “No Response ModA54, Active” indicates a power problem on the module. (A CAN network problem would show the same message but doesn't produce this symptom).</li> <li>3. Check / reset circuit breaker CB7.</li> <li>4. Check / replace fuse F67, F68.</li> <li>5. Probe gray connector on module to see if it is powered.</li> </ol>
<p>HVAC condenser fans not functioning in speed 1</p>	<p>Module A54 is not powered or is faulty</p>	<ol style="list-style-type: none"> <li>1. Check the SYSTEM DIAGNOSTIC menu of Driver Information Display (DID). Select FAULT DIAGNOSTIC and ELECTRICAL SYSTEM. The message “No Response ModA54, Active” indicates a power problem on the module. (A CAN network problem would show the same message but doesn't produce this symptom).</li> <li>2. Check / reset circuit breaker CB7.</li> <li>3. Check / replace fuse F67, F68.</li> <li>4. Probe gray connector on module to see if it is powered.</li> </ol>

Problem/Symptom	Probable Causes	Actions
Fire alarm telltale light and audible alarm always ON and there is no fire or high temperature in the engine compartment	Short-circuited fire sensor or defective sensor	Prior to start the vehicle, cycle the ignition key to the ON position, OFF position and then ON position again and then start the vehicle. This will deactivate the fire alarm function. This has to be repeated each time the vehicle is re-started.
The vehicle is parked and the electrical horn is activated to indicate a fire in the engine compartment but there is no fire	Short-circuited fire sensor or defective sensor	Cycle the ignition key between the ON and OFF position twice within 3 seconds. This will deactivate the fire alarm function. This has to be repeated each time the vehicle is parked.
A single light, a group of LED lights or another function of the vehicle is not functioning	The multiplex outputs are protected in current by an internal "soft-fuse". When an output is shorted, it turns OFF and stays OFF until the "soft-fuse" is reset	Turn the ignition key to the OFF position and turn to the ON position again. This resets all "soft-fuses".
No backlighting in the instrument cluster	Circuit breaker CB9 is tripped or fuse F21 blown.	Check / reset circuit breaker CB9 Check / replace fuse F21.
The radiator fan clutch does not function and the engine is overheating		<ol style="list-style-type: none"> <li>1. Set the ignition key to the ON position.</li> <li>2. Activate the dashboard Telltale Light Test switch 3 times within 4 seconds.</li> <li>3. In the engine compartment, set the starter selector switch to REAR START and then start the engine from the rear.</li> </ol> <p>While in this mode, the rear start push-button can be used to manually engage the fan clutch. The Multiplex system knows when the engine is already running, and it will not activate the starter.</p> <ol style="list-style-type: none"> <li>4. Press the push-button one time to engage the clutch in 1<sup>st</sup> speed, press a second time to engage in 2<sup>nd</sup> speed, press a third time to stop the fan, press once again to return to 1<sup>st</sup> speed.</li> </ol> <p>If the fan clutch does not engage using this procedure then the clutch is faulty or the wiring between the multiplex module and the clutch is faulty. Mechanically lock the fan clutch as described in section 05: COOLING SYSTEM of the maintenance manual.</p>



## **Appendix C – Allison Diagnostic Troubleshooting Codes 173**

---

<b>DIAGNOSTIC TROUBLESHOOTING CODES (DTC) – ALLISON 4<sup>TH</sup> GENERATION CONTROLS ....</b>	<b>174</b>
DIAGNOSTIC TROUBLESHOOTING CODES (DTC) OVERVIEW.....	174
DIAGNOSTIC CODES – ALLISON 4 <sup>TH</sup> GENERATION CONTROLS .....	174
DIAGNOSTIC CODE DISPLAY AND CLEARING PROCEDURE - ALLISON 4 <sup>TH</sup> GENERATION CONTROLS .....	175
DIAGNOSTIC CODE RESPONSE .....	176
ALLISON TRANSMISSION DIAGNOSTIC TROUBLESHOOTING CODES (DTC) AND DESCRIPTIONS .....	177
<b>ALLISON TRANSMISSION OIL LEVEL CHECK USING THE PUSH-BUTTON SHIFT SELECTOR....</b>	<b>181</b>
EXITING THE FLUID LEVEL DISPLAY MODE.....	181
<b>CONTROL SYSTEM PROGNOSTICS.....</b>	<b>182</b>
OIL LIFE MONITOR.....	182
FILTER LIFE MONITOR.....	182
TRANSMISSION HEALTH MONITOR .....	183

## DIAGNOSTIC TROUBLESHOOTING CODES (DTC) — ALLISON 4<sup>TH</sup> GENERATION CONTROLS

### DIAGNOSTIC TROUBLESHOOTING CODES (DTC) OVERVIEW

Diagnostic codes (DTC) are numerical indications relating to a malfunction in transmission operation. These codes are logged in a list in the TCM memory with the most severe or most recent code listed first. A maximum of five codes (numbered d1 to d5) may be listed in memory at one time. As codes are added, the oldest inactive code is dropped from the list. If all codes are active, the code with the lowest priority that is not included on the severity list is dropped from the list.

Diagnostic codes (DTC) and code information may be accessed through the pushbutton shift selector or using an Allison DOC™ diagnostic tool.

The TCM separately stores the active and inactive codes. An active code is any code that is current in the TCM decision-making process. Inactive codes are codes that are retained in the TCM memory and will not necessary affect the TCM decision-making process. Inactive codes are useful in determining if a problem is:

- Isolated ;
- Intermittent ;
- Result from a previous malfunction.

The TCM may automatically delete a code from memory if it has not recurred. If the condition which generated the code is active, the LED indicator on the selector will be illuminated simultaneously with the display of the code. If the condition which generated the code no longer exists, the LED is not illuminated and the code is maintained only as a historical record of the prior condition. An illuminated MODE INDICATOR (LED) during normal operation signifies secondary shift mode operation.



### DIAGNOSTIC CODES – ALLISON 4<sup>TH</sup> GENERATION CONTROLS

When the diagnostic mode is entered, the first code (position d1) is displayed as follows:

Exemple: Code P0722

Displayed as: **d1...P...07...22**

The code list position is the first item displayed, followed by the DTC. Each item is displayed for about one second. The display cycles continuously until the next code list position is accessed by pressing the **MODE** button. The following example shows how DTC P0722 is displayed on the pushbutton shift selector.

SELECT	d	1	MONITOR
		P	
	0	7	
	2	2	

- d1 (code list position) – The position which a code occupies in the list. Positions are displayed as « d1 » through « d5 » (code list position 1 through code list position 5).
- P0722 (DTC) – The diagnostic troubleshooting code number referring to the general condition or area of fault detected by the TCM.

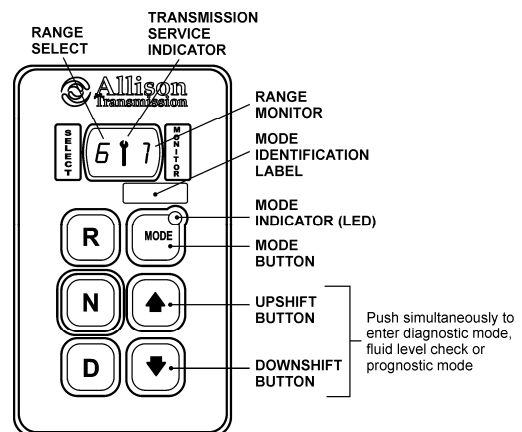



**DIAGNOSTIC CODE DISPLAY AND CLEARING PROCEDURE – ALLISON 4<sup>TH</sup> GENERATION CONTROLS**

Diagnostic codes can be read and cleared by two methods:

- Using an Allison DOC™ diagnostic tool. For specific instructions on how to use an Allison DOC™ diagnostic tool, refer to the User Guide.
- Using the pushbutton shift selector.

*To begin the diagnostic process:*

1. Bring the vehicle to a stop at a safe location.
2. Apply the parking brake.

*To display stored codes:*

1. Simultaneously press the ▲ (Up) and ▼ (Down) arrow buttons five times to access the Diagnostic Display Mode.

***NOTE***

*To access the Oil Level Display Mode, simultaneously press the ▲ (Up) and ▼ (Down) arrow buttons once. Consult paragraph: « ALLISON TRANSMISSION OIL LEVEL CHECK USING THE PUSHBUTTON SHIFT SELECTOR » at the end of this section.*

2. Observe the digital display for code (d1).
3. Press the MODE button to see the next code (d2) – repeat for subsequent codes (d3, d4 & d5).

***NOTE***

*Be sure to record all codes displayed before they are cleared. This is essential for troubleshooting.*

***NOTE***

*The Diagnostic Display Mode can be entered for viewing codes at any speed. Codes can only be cleared when the output speed = 0 and no output speed sensor failure is active*

Active indicators (MODE INDICATOR LED) and inactive codes can be cleared manually, while in the diagnostic display mode, after the condition causing the code is identified.

*To clear active indicators and inactive codes:*

1. While in Diagnostic Display Mode, press and hold the MODE button for 10 seconds to clear both active indicators and inactive codes.
2. Begin operating as normal. Have the transmission checked at the earliest opportunity by an Allison Transmission distributor or dealer.

***NOTE***

*All active indicators are cleared at TCM power down.*

*Some codes will clear their active indicator when the condition causing the code is no longer detected by the TCM.*

## 176 Appendix C – Allison Diagnostic Troubleshooting Codes

---

*The Diagnostic Display Mode can be exited by any of the following methods:*

- Press simultaneously the ▲ (Up) and ▼ (Down) arrow buttons at the same time on the pushbutton shift selector.
- Press any range button «D», «N» or «R» on the pushbutton shift selector (the shift will be commanded if it is not inhibited by an active code).
- Wait until the calibrated time (approximately 10 minutes) has passed. The system will automatically return to the normal operating mode.
- Turn off power to the TCM (shut off the engine using the ignition key).

### ***NOTE***

*If clearing a code while locked in a «D» (Drive) or «R» (Reverse) position (fail-to-range), the transmission will still be in «D» (Drive) or «R» (Reverse) when the clearing procedure is completed. «N» (Neutral) must be manually selected.*

### **DIAGNOSTIC CODE RESPONSE**

The following responses are used in the "Diagnostic Troubleshooting Code List and Inhibited Operation Description" table to command safe operation when diagnostic codes are sent.

#### **DNS - Do Not Shift Response**

Release lock up clutch and inhibit lock up operation.  
Inhibit all shifts.  
Turn *ON* the CHECK TRANS light.  
Display the range attained.  
Ignore any range selection inputs from the shift selector.

#### **DNA - Do Not Adapt Response**

The TCM stops adaptive shift control while the code is active.

#### **SOL OFF - SOLenoid OFF Response**

All solenoids are commanded *OFF* (turning solenoids "A" and "B" off electrically cause them to be on hydraulically).

#### **RPR - Return to Previous Range Response**

When the speed sensor ratio or C3 pressure switch test associated with a shift not successful, the TCM commands the same range as commanded before the shift.

#### **NNC - Neutral No Clutches Response**

When certain speed sensor ratio or C3 pressure switch tests are not successful, the TCM commands a neutral condition with no clutches applied.

**ALLISON TRANSMISSION DIAGNOSTIC TROUBLESHOOTING CODES (DTC) AND DESCRIPTIONS**

<b>DTC</b>	<b>Description</b>	<b>CHECK TRANS Light</b>	<b>Inhibited Operation Description</b>
C1312	Retarder Request Sensor Failed Low	No	May inhibit retarder operation if not using J1939 datalink
C1313	Retarder Request Sensor Failed High	No	May inhibit retarder operation if not using J1939 datalink
P0122	Pedal Position Sensor Low Voltage	No	Use default throttle values. Freezes shift adapts.
P0123	Pedal Position Sensor High Voltage	No	Use default throttle values. Freezes shift adapts.
P0218	Transmission Fluid Over Temperature	No	Use hot mode shift schedule. Holds fourth range. TCC is inhibited. Freezes shift adapts.
P0561	System Voltage Performance		
P0562	System Voltage Low		
P0563	System Voltage High		
P0602	TCM Not Programmed	Yes	Lock in Neutral
P0610	TCM Vehicle Options (Trans ID) Error	Yes	Use TID A calibration
P0613	TCM Processor	No	All solenoids off
P0614	Torque Control Data Mismatch - ECM/TCM	Yes	Allows operation only in reverse and second range.
P0634	TCM Internal Temperature Too High	Yes	SOL OFF (hydraulic default)
P063E	Auto Configuration Throttle Input Not Present	Yes	Use default throttle values
P063F	Auto Configuration Engine Coolant Temp Input Not Present	No	None
P0658	Actuator Supply Voltage 1 (HSD1) Low	Yes	DNS, SOL OFF (hydraulic default)
P0659	Actuator Supply Voltage 1 (HSD1) High	Yes	DNS, SOL OFF (hydraulic default)
P0667	TCM Internal Temperature Sensor Circuit Range / Perform		
P0668	TCM Internal Temperature Sensor Circuit Low		
P0669	TCM Internal Temperature Sensor Circuit High		
P0701	Transmission Control System Performance		
P0702	Transmission Control System Electrical (TransID)	Yes	Use TID A calibration
P0703	Brake Switch Circuit Malfunction	No	No Neutral to Drive shifts for refuse packer. TCM inhibits retarder operation if a TPS code is also active.
P0708	Transmission Range Sensor Circuit High Input	Yes	Ignore defective strip selector inputs
P070C	Transmission Fluid Level Sensor Circuit – Low Input	No	None
P070D	Transmission Fluid Level Sensor Circuit – High Input	No	None
P0711	Transmission Fluid Temperature Sensor Circuit Performance	Yes	Use default sump temp
P0712	Transmission Fluid Temperature Sensor Circuit Low Input	Yes	Use default sump temp
P0713	Transmission Fluid Temperature Sensor Circuit High Input	Yes	Use default sump temp
P0716	Turbine Speed Sensor Circuit Performance	Yes	DNS, Lock in current range
P0717	Turbine Speed Sensor Circuit No Signal	Yes	DNS, Lock in current range
P071A	RELS Input Failed On	Yes	Inhibit RELS operation
P071D	General Purpose Input Fault	Yes	None

**178 Appendix C – Allison Diagnostic Troubleshooting Codes**

<b>DTC</b>	<b>Description</b>	<b>CHECK TRANS Light</b>	<b>Inhibited Operation Description</b>
P0720	Output Speed Sensor Circuit		
P0721	Output Speed Sensor Circuit Performance	Yes	DNS, Lock in current range
P0722	Output Speed Sensor Circuit No Signal	Yes	DNS, Lock in current range
P0726	Engine Speed Sensor Circuit Performance	No	Default to turbine speed
P0727	Engine Speed Sensor Circuit No Signal	No	Default to turbine speed
P0729	Incorrect 6 <sup>th</sup> Gear Ratio	Yes	DNS, Attempt 5 <sup>th</sup> , then 3 <sup>rd</sup>
P0730	Incorrect Neutral Gear ratio		
P0731	Incorrect 1 <sup>st</sup> Gear ratio	Yes	DNS, Attempt 2 <sup>nd</sup> , then 5 <sup>th</sup>
P0732	Incorrect 2 <sup>nd</sup> Gear ratio	Yes	DNS, Attempt 3 <sup>rd</sup> , then 5 <sup>th</sup>
P0733	Incorrect 3 <sup>rd</sup> Gear ratio	Yes	DNS, Attempt 4 <sup>th</sup> , then 6 <sup>th</sup>
P0734	Incorrect 4 <sup>th</sup> Gear ratio	Yes	DNS, Attempt 5 <sup>th</sup> , then 3 <sup>rd</sup>
P0735	Incorrect 5 <sup>th</sup> Gear ratio	Yes	DNS, Attempt 6 <sup>th</sup> , then 3 <sup>rd</sup> , then 2 <sup>nd</sup>
P0736	Incorrect Reverse Gear ratio	Yes	DNS, Lock in Neutral
P0741	Torque Converter Clutch System Stuck Off	Yes	None
P0776	Pressure Control Solenoid 2 Stuck Off	Yes	DNS, RPR
P0777	Pressure Control Solenoid 2 Stuck On	Yes	DNS, RPR
P0796	Pressure Control Solenoid 3 Stuck Off	Yes	DNS, RPR
P0797	Pressure Control Solenoid 3 Stuck On	Yes	DNS, RPR
P0842	Transmission Pressure Switch 1 Circuit Low	Yes	DNS, Lock in current range
P0843	Transmission Pressure Switch 1 Circuit High	Yes	DNS, Lock in current range
P0847	Transmission Pressure Switch 2 Circuit Low		
P0848	Transmission Pressure Switch 2 Circuit High		
P088A	Transmission Fluid Filter Deteriorated		
P088B	Transmission Fluid Filter Very Deteriorated		
P0880	TCM Power Input Signal	No	None
P0881	TCM Power Input Signal Performance	No	None
P0882	TCM Power Input Signal Low	Yes	DNS, SOL OFF (hydraulic default)
P0883	TCM Power Input Signal High	No	None
P0894	Transmission Component Slipping	Yes	DNS, Lock in first
P0960	Pressure Control Solenoid Main Mod Control Circuit Open	Yes	None
P0961	Pressure Control Solenoid (PCS) MM System Performance		
P0962	Pressure Control Solenoid Main Mod Control Circuit Low	Yes	DNS, SOL OFF (hydraulic default)
P0963	Pressure Control Solenoid Main Mod Control Circuit High	Yes	None
P0964	Pressure Control Solenoid 2 (PCS2) Control Circuit Open	Yes	DNS, SOL OFF (hydraulic default)
P0965	Pressure Control Solenoid (PCS) 2 System Performance		
P0966	Pressure Control Solenoid 2 (PCS2) Control Circuit Low	Yes	DNS, SOL OFF (hydraulic default)
P0967	Pressure Control Solenoid 2 (PCS2) Control Circuit High	Yes	DNS, SOL OFF (hydraulic default)
P0968	Pressure Control Solenoid 3 (PCS3) Control Circuit Open	Yes	DNS, SOL OFF (hydraulic default)
P0969	Pressure Control Solenoid (PCS) 3 System Performance		
P0970	Pressure Control Solenoid 3 (PCS3) Control Circuit Low	Yes	DNS, SOL OFF (hydraulic default)
P0971	Pressure Control Solenoid 3 (PCS3) Control Circuit High	Yes	DNS, SOL OFF (hydraulic default)
P0973	Shift Solenoid 1 (SS1) Control Circuit Low	Yes	DNS, SOL OFF (hydraulic default)
P0974	Shift Solenoid 1 (SS1) Control Circuit High	Yes	DNS, SOL OFF (hydraulic default)

<b>DTC</b>	<b>Description</b>	<b>CHECK TRANS Light</b>	<b>Inhibited Operation Description</b>
P0975	Shift Solenoid 2 (SS2) Control Circuit Open	Yes	7-speed: Allow 2 through 6, N, R
P0976	Shift Solenoid 2 (SS2) Control Circuit Low	Yes	7-speed: Allow 2 through 6, N, R Inhibit TCC operation
P0977	Shift Solenoid 2 (SS2) Control Circuit High	Yes	7-speed: Allow 2 through 6, N, R
P0989	Retarder Pressure Sensor Failed Low	No	None
P0990	Retarder Pressure Sensor Failed High	No	None
P1739	Incorrect Low Gear Ratio	Yes	Command 2 <sup>nd</sup> and allow shifts 2 through 6, N, R
P1891	Throttle Position Sensor PWM Signal Low Input	No	Use default throttle values
P1892	Throttle Position Sensor PWM Signal High Input	No	Use default throttle values
P2184	Engine Coolant Temperature Sensor Circuit Low Input	No	Use default engine coolant values
P2185	Engine Coolant Temperature Sensor Circuit High Input	No	Use default engine coolant values
P2637	Torque Management Feedback Signal (SEM)	Yes	Inhibit SEM
P2641	Torque Management Feedback Signal (LRTP)	Yes	Inhibit LRTP
P2670	Actuator Supply Voltage 2 (HSD2) Low	Yes	DNS, SOL OFF (hydraulic default)
P2671	Actuator Supply Voltage 2 (HSD2) High	Yes	DNS, SOL OFF (hydraulic default)
P2685	Actuator Supply Voltage 3 (HSD3) Low	Yes	DNS, SOL OFF (hydraulic default)
P2686	Actuator Supply Voltage 3 (HSD3) High	Yes	DNS, SOL OFF (hydraulic default)
P2714	Pressure Control Solenoid 4 (PCS4) Stuck Off	Yes	DNS, RPR
P2715	Pressure Control Solenoid 4 (PCS4) Stuck On	Yes	DNS, SOL OFF (hydraulic default)
P2718	Pressure Control Solenoid 4 (PCS4) Control Circuit Open	Yes	DNS, SOL OFF (hydraulic default)
P2719	Pressure Control Solenoid (PCS) 4 System Performance		
P2720	Pressure Control Solenoid 4 (PCS4) Control Circuit Low	Yes	DNS, SOL OFF (hydraulic default)
P2721	Pressure Control Solenoid 4 (PCS4) Control Circuit High	Yes	DNS, SOL OFF (hydraulic default)
P2723	Pressure Control Solenoid 1 (PCS1) Stuck Off	Yes	DNS, RPR
P2724	Pressure Control Solenoid 1 (PCS1) Stuck On	Yes	DNS, RPR
P2727	Pressure Control Solenoid 1 (PCS1) Control Circuit Open	Yes	DNS, SOL OFF (hydraulic default)
P2728	Pressure Control Solenoid (PCS) 1 System Performance		
P2729	Pressure Control Solenoid 1 (PCS1) Control Circuit Low	Yes	DNS, SOL OFF (hydraulic default)
P2730	Pressure Control Solenoid 1 (PCS1) Control Circuit High	Yes	DNS, SOL OFF (hydraulic default)
P2736	Pressure Control Solenoid 5 (PCS5) Control Circuit Open	Yes	Inhibit retarder operation
P2737	Pressure Control Solenoid (PCS) 5 System Performance		
P2738	Pressure Control Solenoid 5 (PCS5) Control Circuit Low	Yes	Allow 2 through 6, N, R. Inhibit retarder and TCC operation
P2739	Pressure Control Solenoid 5 (PCS5) Control Circuit High	Yes	Inhibit retarder operation
P2740	Retarder Oil Temperature Hot	No	None
P2742	Retarder Oil Temperature Sensor Circuit – Low Input	No	Use default retarder temp values
P2743	Retarder Oil Temperature Sensor Circuit – High Input	No	Use default retarder temp values
P2761	TCC PCS Control Circuit Open	Yes	Inhibit TCC operation
P2762	TCC PCS Control Circuit Range / Performance		
P2763	TCC PCS Control Circuit High	Yes	Inhibit TCC operation
P2764	TCC PCS Control Circuit Low	Yes	7-speed: Allow 2 through 6, N, R. Inhibit TCC operation
P2772	Four Wheel Drive Low Switch Circuit Performance		
P278A	Kickdown Input Failed ON	No	Inhibit kickdown operation

## 180 Appendix C – Allison Diagnostic Troubleshooting Codes

DTC	Description	CHECK TRANS Light	Inhibited Operation Description
P2793	Gear Shift Direction Circuit	Yes	Ignores PWM input from shift selector
P2808	Pressure Control Solenoid 6 (PCS6) Stuck Off	Yes	DNS, RPR
P2809	Pressure Control Solenoid 6 (PCS6) Stuck On	Yes	DNS, RPR
P2812	Pressure Control Solenoid 6 (PCS6) Control Circuit Open	Yes	DNS, SOL OFF (hydraulic default)
P2813	Pressure Control Solenoid (PCS) 6 System Performance		
P2814	Pressure Control Solenoid 6 (PCS6) Control Circuit Low	Yes	DNS, SOL OFF (hydraulic default)
P2815	Pressure Control Solenoid 6 (PCS6) Control Circuit High	Yes	DNS, SOL OFF (hydraulic default)
U0001	Hi Speed CAN Bus Reset Counter Overrun (IESCAN)	No	Use default values, inhibit SEM
U0010	CAN BUS Reset Counter Overrun	No	Use default values, inhibit SEM
U0100	Lost Communications with ECM/PCM (J1587)	Yes	Use default values
U0103	Lost Communication with Gear Shift Module (Shift Selector) 1	Yes	Maintain range selected, observe gear shift direction circuit
U0115	Lost Communication with ECM	Yes	Use default values
U0291	Lost Communication with Gear Shift Module (Shift Selector) 2	Yes	Maintain range selected, observe gear shift direction circuit
U0304	Incompatible Gear Shift Module 1 (Shift Selector) ID	Yes	Ignore shift selector inputs
U0333	Incompatible Gear Shift Module 2 (Shift Selector) ID	Yes	Ignore shift selector inputs
U0404	Invalid Data Received From Gear Shift Module (Shift Selector) 1	Yes	Maintain range selected, observe gear shift direction circuit
U0592	Invalid Data Received From Gear Shift Module (Shift Selector) 2	Yes	Maintain range selected, observe gear shift direction circuit

### **ALLISON TRANSMISSION OIL LEVEL CHECK USING THE PUSH-BUTTON SHIFT SELECTOR**

Oil level codes are obtained as follows:

1. Park vehicle on a level surface, select «N» (neutral) on the pushbutton shift selector and apply parking brake.
2. Press simultaneously the ▲ (Up) and ▼ (Down) arrow buttons once.
3. Oil level codes are displayed in 2 minutes (e.g. display will flash and 8, 7, 6, 5, ...; countdown will occur during the 2 minutes) once the following parameters are met:
  - **Waiting time, vehicle must be stationary for at least 2 minutes to allow the oil to settle;**
  - **Engine at idle;**
  - **Oil at normal operating temperature, between 140°F (60°C) and 220°F (104°C);**
  - **Transmission in «N» (Neutral);**
  - **Transmission output shaft stopped;**
  - **Oil level sensor present and working.**

After 2 minutes, the display will flash one of the codes shown below:

<b>CODE</b>	<b>CAUSE OF CODE</b>
OL...OK	Oil level is correct
OL...LO... 1	Oil Level is LOw 1 quart
OL...LO... 2	Oil Level is LOw 2 quart
OL...LO... 3	Oil Level is LOw 3 quarts
OL...LO... 4	Oil Level is LOw 4 or more quarts
OL...HI... 1	Oil Level is Hlgh 1 quart
OL...HI... 2	Oil Level is Hlgh 2 quarts
OL...HI... 3	Oil Level is Hlgh 3 or more quarts
OL... – (fc)	Oil Level is invalid. Source of invalid reading is defined by a two-character fault code (fc)

***NOTE***

*Note that the quantities LO 4 and HI 3 are the largest values displayed and that the actual variation in oil level may exceed these numbers.*

***NOTE***

*Failure to meet one of the above parameters will stop the two minute countdown. One of the codes shown hereafter will indicate the cause of the countdown interruption. Once all parameters are met, the countdown will continue from where it left off.*

If the fluid level check cannot be completed, an Invalid for Display fault is reported. This condition is reflected by the display of "OL", followed by "–", followed by one or two additional characters. The displayed characters define the cause of the fault, which may be either a system malfunction or an improper condition for conducting the check.

<b>CODE</b>	<b>CAUSE OF FAULT CODE</b>
OL...-...0X	Waiting period is not complete
OL...-...EL	Engine speed (rpm) too low
OL...-...EH	Engine speed (rpm) too high
OL...-...SN	N (neutral) must be selected
OL...-...TL	Sump oil temperature too low
OL...-...TH	Sump oil temperature too high
OL...-...SH	Output shaft rotation
OL...-...FL	Sensor failure

#### **EXITING THE FLUID LEVEL DISPLAY MODE**

To exit the Oil Level Display Mode, press any range button: «R», «N» or «D» at any time.

## CONTROL SYSTEM PROGNOSTICS

The transmission control system includes the provision for the user to monitor various transmission operating parameters. Transmission operating parameters monitored by the prognostics feature are:

- Oil Life Monitor
- Filter Life Monitor
- Transmission Health Monitor



### NOTE

*The prognostics package requires the use of TranSynd™ or an Allison approved TES-295 licensed fluid in the transmission and Allison High Capacity filters. If any other fluids or filters are used, Prognostic mode **must be disabled**. Prognostic information will not be accurate with any other fluids or filters and could result in missed maintenance activities resulting in transmission damage.*

*Refer to TES 295 Approved Fluids list, found under the Service/Fluids heading on the home page of the Allison Transmission web site.*

**[www.allisontransmission.com](http://www.allisontransmission.com)**

When a specified threshold is detected for any of the serviceable conditions, the TRANSMISSION SERVICE indicator  is illuminated to alert the operator. Failure to attend to the service condition and reset the TRANSMISSION SERVICE indicator within a defined operating period will result in illumination of the CHECK TRANS light on the dashboard telltale panel, indicating the increased probability that the service condition will develop into a more serious condition.

To access the Prognostic Mode functions, simultaneously press the  (Up) and  (Down) arrow buttons repeatedly. See the reference table at the end of this section.

### • OIL LIFE MONITOR

The display message denotes the calculated remaining life of the transmission fluid. This value is based on the established life for the required baseline fluid, and then is continuously adjusted for cumulative effects of such operating parameters as operating time, retarder operation, output shaft revolutions and shift frequency.

**Display:** The display is a two-digit number, denoting percentage of the fluid life which remains. New fluid is displayed as 99%.

The TRANSMISSION SERVICE indicator  will be illuminated, denoting a required change of transmission fluid, when the remaining fluid life reaches approximately 1–2 %. The indicator will be lit steadily upon each initialization of the TCM, and will remain on steady for approximately 1–2 minutes after the first selection of “D” (drive) range each time, until service is performed and the indicator is reset.

Failure to perform maintenance and reset the TRANSMISSION SERVICE indicator within a defined period will result in the illumination of the CHECK TRANS light on the dashboard telltale panel and diagnostic code P0897 Transmission Fluid at Limit will be set.

**Reset:** The TRANSMISSION SERVICE indicator can be reset by a message over the SAE J1939 communication interface, with the Allison DOC™ for PC diagnostic program, or by depressing and holding the MODE button for ten (10) seconds while the Oil Life Monitor function is displayed. It may also be reset by selecting N-D-N-D-N-R-N on the shift selector, pausing briefly (less than 3 seconds) between each selector movement, with the ignition on and the engine not running.



### CAUTION

Required calendar-based oil & filter change intervals (based on month) still apply because Oil Life Monitor function cannot measure time while ignition power is OFF.

If the Oil Life Monitor function has not indicated the need for a fluid change before 60 month (five years) have passed, it will be necessary to change the fluid and filters per calendar requirements and reset the system.

### • FILTER LIFE MONITOR

The display message denotes operating status of the transmission main fluid filter, based on the measured pressure drop across the filter. The feature is not functional at transmission sump temperatures below 40 °C (105 °F). Both the main and lube filters **must be** changed when the TRANSMISSION SERVICE indicator  shows the main filter should be changed.



**Display:** An acceptable filter life status is displayed as "OK". An unacceptable filter life status is displayed as "LO".

Once the programmed threshold for maximum filter pressure drop has been observed and verified, the diagnostic code P088A Transmission Filter At/Over Limit will be recorded to indicate that the filter has reached the end of its designed life. At the next initialization of the TCM, the TRANSMISSION SERVICE indicator  will flash for approximately 1–2 minutes after the first selection of "D" (drive) range. Thereafter, the indicator will illuminate and flash upon each TCM initialization, continuing to flash for 1–2 minutes after the first selection of a drive range each time, until service is performed and the indicator is reset.

Failure to perform maintenance and reset the monitor after a calibration-defined number of warnings will result in the illumination of the CHECK TRANS light on the dashboard telltale panel and diagnostic code P088B will be recorded to indicate a highly deteriorated filter.

**Reset:** The feature will reset automatically when the main fluid filter has been changed and the pressure drop across the filter no longer exceeds the threshold value. A manual reset can be performed by depressing and holding the MODE button for ten (10) seconds while the Filter Life Monitor function is displayed. It may also be reset by selecting N-R-N-R-N-D-N on the shift selector, pausing briefly (less than 3 seconds) between each selector movement, with the ignition on and the engine not running.

• **TRANSMISSION HEALTH MONITOR**

The display message denotes clutch life status, as determined by monitored changes and the calculated running clearance of the transmission clutches C1, C2, C3, C4 & C5.

**Display:** An acceptable clutch life status is displayed as "OK". An unacceptable clutch life status is displayed as "LO". The specific clutch(es) for which the function indicates "LO" cannot be identified with the shift selector. Allison DOC™ for PC-Service Tool displays clutch condition as OK or NOT OK for each clutch, C1 through C5.

The TRANSMISSION SERVICE indicator will be illuminated, indicating the need for clutch maintenance, when the remaining clutch life reaches approximately 10%, or if the running clearance exceeds a maximum value which may

indicate a non-wear-related issue. Thereafter, the indicator will be lit upon each initialization of the TCM, and will remain on steady during all vehicle operation until service is performed and the indicator is reset.

Failure to perform maintenance and reset the monitor after a number of warnings will result in the illumination of the CHECK TRANS light on the dashboard telltale panel and diagnostic code P2789 Clutch Adaptive learning at Limit will be set.

**Reset:** The feature will reset automatically upon elimination of the clutch clearance condition which initiated it. The indicator can also be manually reset using the Allison DOC™ for PC diagnostics program if necessary.

184 Appendix C – Allison Diagnostic Troubleshooting Codes

▲ (up) & ▼ (down) arrow buttons pressed simultaneously	DESCRIPTION	SELECT	MONITOR
1 <sup>st</sup> press	<b>Allison transmission oil level check</b> Other codes will be displayed	" _ "	" _ "
2 <sup>nd</sup> press	<b>Oil Life Monitor</b> Oil life remaining will range from 99% down to 00%	" O " Some number from 9 to 0	" M " Some number from 9 to 0
3 <sup>rd</sup> press	<b>Filter Life Monitor</b> Present life of filter is OK Present life of filter is low	" F " " O " " L "	" M " " K " " O "
4 <sup>th</sup> press	<b>Transmission Health Monitor</b> Shows "OK" until remaining life of one or more of the clutch(es) wear enough so that the programming changes One or more of the clutches C1 through C5 have worn enough to change the program	" O " " O " " L "	" K " " K " " O "
5 <sup>th</sup> press	<b>Display of diagnostic codes</b> Other codes will be displayed	" d "	" 1 "

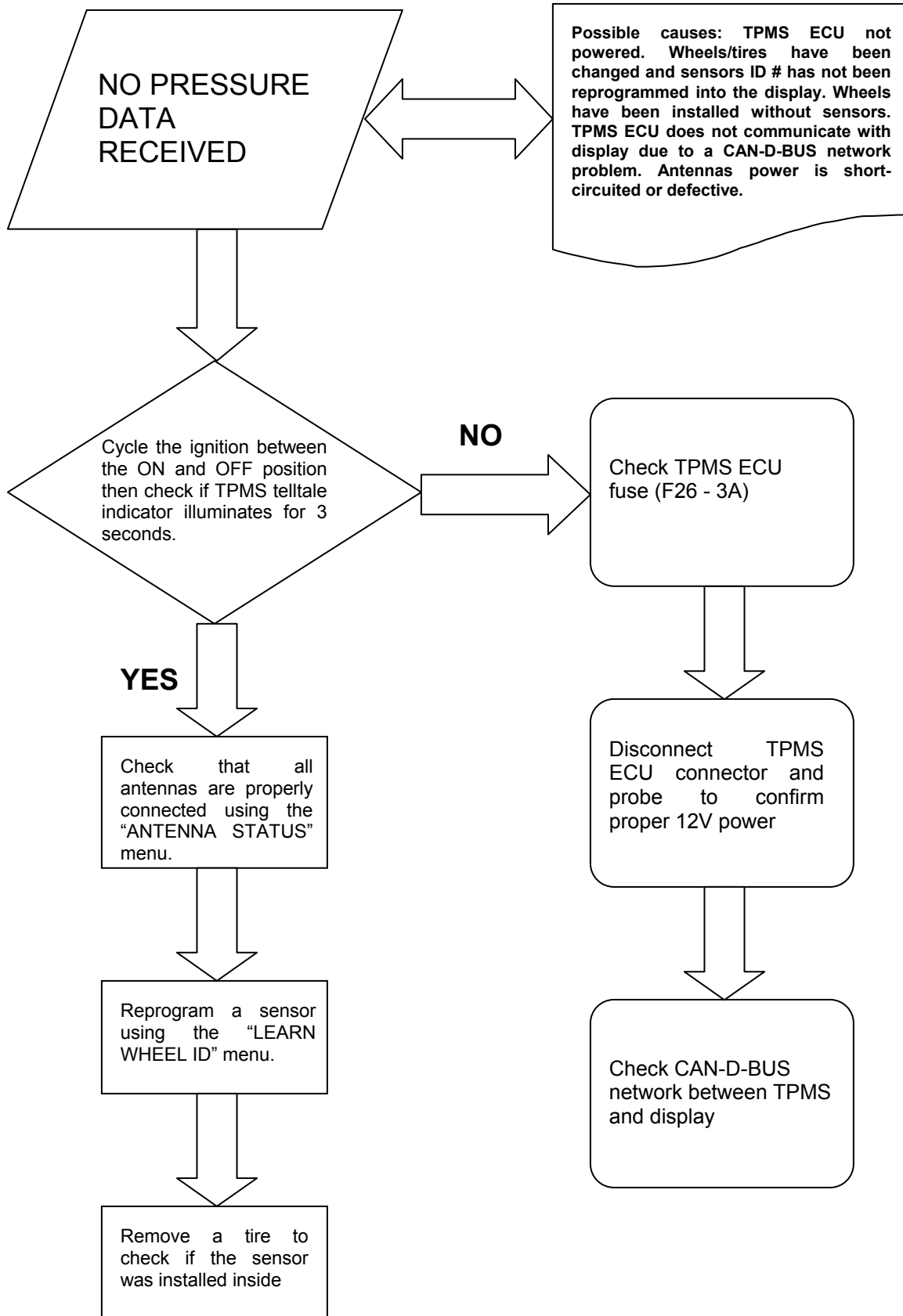

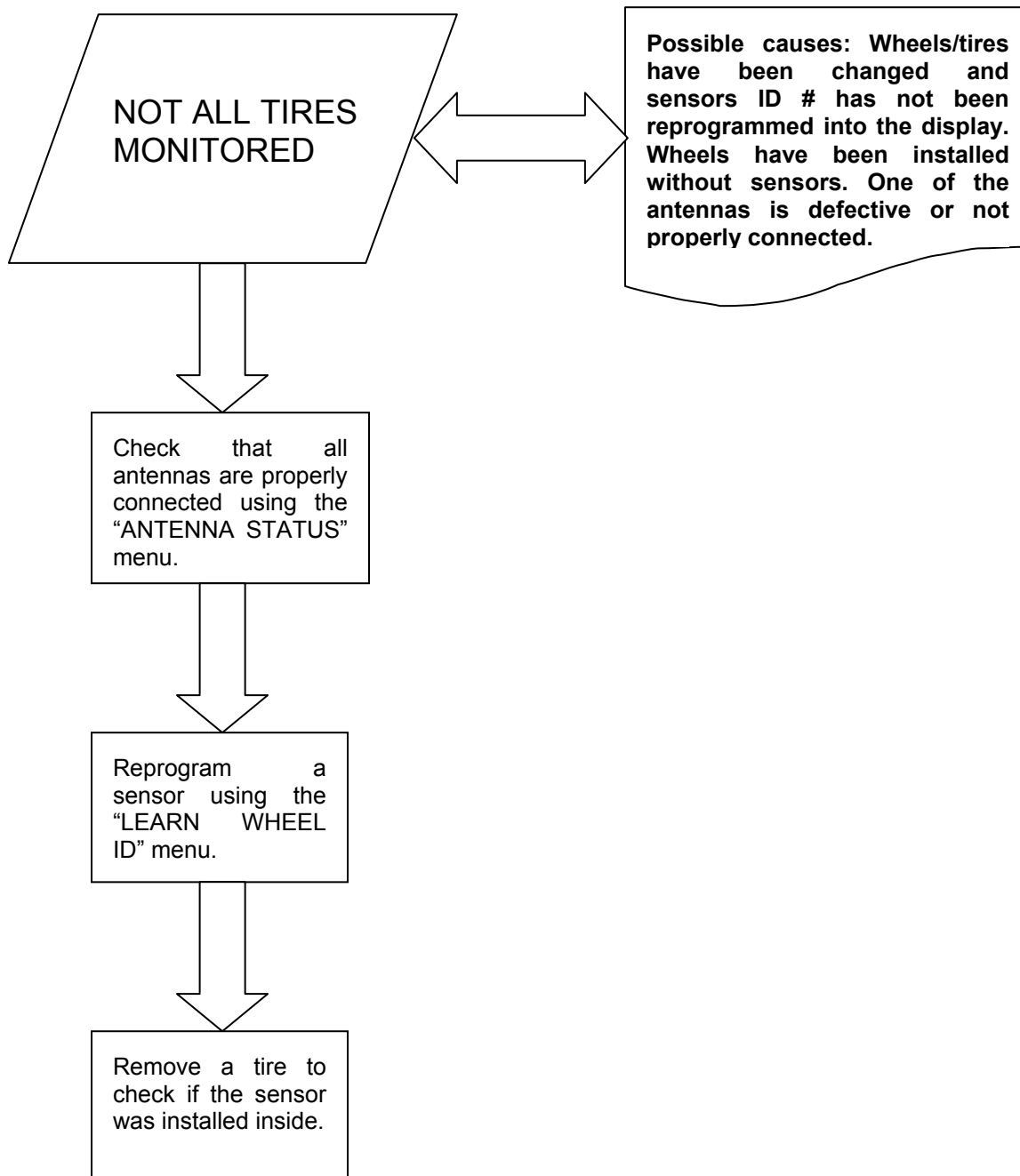

110-120 VOLT CONNECTOR ..... 15

**A**

ABBREVIATIONS ..... 161

ADJUSTABLE HVAC REGISTERS .....20

AIR SYSTEM ..... 154

ALIGNMENT SPECIFICATIONS ..... 155

    DRIVE AXLE ..... 156

    INDEPENDENT FRONT SUSPENSION ..... 156

    TAG AXLE ..... 156

ALLISON AUTOMATIC TRANSMISSION .....69

    DESCRIPTION OF AVAILABLE RANGES.....70

    FUNCTIONS OF THE "MODE" BUTTON .....70

    OPERATION .....69

    PUSH BUTTON SHIFT SELECTOR.....69

    TRANSMISSION SERVICE INDICATOR.....70

ALLISON TRANSMISSION..... 153

    GEAR RATIOS ..... 154

ALLISON TRANSMISSION ELECTRONIC CONTROLS .....95

ALLISON TRANSMISSION WARM-UP ..... 115

ANTILOCK BRAKING SYSTEM (ABS) ..97, 154

    TROUBLESHOOTING AND TESTING ..... 154

APPENDIX A – SERVICE LITERATURE ..... 163

    SERVICE LITERATURE.....164

    NOTICE.....165

APPENDIX B – TROUBLESHOOTING GUIDE FOR MULTIPLEX VEHICLES ..... 167

APPENDIX C – ALLISON DIAGNOSTIC TROUBLESHOOTING CODES ..... 173

    CONTROL SYSTEM PROGNOSTICS ..... 182

    DIAGNOSTIC TROUBLESHOOTING CODES (DTC) – ALLISON 4<sup>TH</sup> GENERATION CONTROLS.....174

    ALLISON TRANSMISSION OIL LEVEL CHECK USING THE PUSH-BUTTON SHIFT SELECTOR ..... 181

APPENDIX D – TPMS TROUBLESHOOTING GUIDE..... 185

AUTOMATIC FIRE DETECTION AND SUPPRESSION SYSTEM (AFSS) ..... 31, 119

AUTOMATIC TRACTION CONTROL (ATC)..... 97, 154

**B**

BACK-UP ALARM..... 127

    BACK-UP ALARM CANCEL SWITCH.....127

BACK-UP CAMERA ..... 15, 127

BAGGAGE COMPARTMENTS ..... 12

BELTS..... 153

BRAKES ..... 154

    BRAKE CHAMBER EFFECTIVE AREA ..... 154

**C**

CAPACITIES..... 152

CARE AND MAINTENANCE..... 129

CATALYTIC CONVERTER ACCESS DOOR. 10

CHANGING WHEELS ..... 125

    HYDRAULIC JACK.....126

    JACKING POINTS.....125

CLEANING..... 131

    CARPET .....132

    EXTERIOR SURFACES.....132

    FLOOR CLEANING.....132

    FORMICA.....132

    PLASTIC AND VINYL.....132

    RUBBER COMPONENTS .....132

    SEAT UPHOLSTERY .....131

    STAINLESS STEEL .....132

    WINDOWS .....132

    WINDSHIELD .....133

COACH FINAL RECORD ..... 159

COLD WEATHER STARTING..... 113

COMPARTMENT LIGHTING..... 127

COMPONENTS IDENTIFICATION ..... 145

CONDENSER COMPARTMENT (A/C) ..... 11

CONTROL SWITCHES .....43

    AIR VENTS .....47

HVAC CONTROL MODULES .....46  
 L.H. DASHBOARD PANEL .....43  
 R.H. DASHBOARD PANEL.....45  
**CONTROLS AND INSTRUMENTS... 23**  
 COOLING SYSTEM.....156  
 CORNERING AND DOCKING LIGHTS.....127

**D**

DASHBOARD .....42  
 DAYTIME RUNNING LIGHTS .....127  
 DEFENSIVE DRIVING PRACTICES .....2  
 DIMENSIONS AND WEIGHTS .....152  
 DRIVER CONTROLLED DIFFERENTIAL  
 LOCK (DCDL) .....98  
     LOCKING THE DCDL .....98  
     OPERATION TIPS .....98  
     UNLOCKING THE DCDL .....98  
 DRIVER INFORMATION DISPLAY (DID)  
 MENUS .....86  
 DRIVER’S SEAT - DELIVERY .....18  
 DRIVER’S AND CO-PILOT’S SEATS –  
 /SR/ (OPTIONAL).....18  
     ELECTRIC ISRI SEATS .....18  
     PNEUMATIC ISRI SEATS.....18  
 DRIVING MODE MENU .....86  
     FUEL DATA.....88  
     GAUGES .....86  
     RESET TRIP DATA.....89  
     TIME / DISTANCE.....88  
     VEHICLE MESSAGES .....89

**E**

ELECTRICAL SYSTEM .....155  
 ELECTRONIC STABILITY CONTROL (ESC) ....  
 .....97, 154  
 EMERGENCY AIR-FILL VALVES .....118  
 EMERGENCY AND PARKING BRAKES .....119  
 EMERGENCY EXITS.....118  
     ELECTRIC AWNING WINDOW .....118

ELECTRIC SLIDING WINDOWS .....118  
 FIXED WINDOWS.....118  
 ENGINE .....153  
 ENGINE BLOCK HEATER .....113  
 ENGINE BRAKE .....96  
     ENGINE BRAKE – AUTO MODE (WITH I-SHIFT  
     TRANSMISSION ONLY) .....97  
     EXHAUST BRAKE .....96  
     VOLVO ENGINE BRAKE (VEB).....96  
 ENGINE COMPARTMENT COMPONENTS....8  
     ENGINE COMPARTMENT R.H. SIDE DOOR....9  
     ENGINE COMPARTMENT REAR DOORS .....9  
 ENGINE WARM-UP .....115  
 ENTRANCE DOOR .....14  
     KEYLESS ENTRY SYSTEM .....14, 99  
 EVAPORATOR COMPARTMENT.....11  
 EXHAUST AFTERTREATMENT SYSTEM .....79  
     DEF TANK LEVEL – DRIVER WARNING AND  
     INDUCEMENT .....83  
     DEF QUALITY – DRIVER WARNING AND  
     INDUCEMENT .....84  
     FILTRATION AND REGENERATION UNIT .....79  
     SCR SYSTEM TAMPERING – DRIVER  
     WARNING AND INDUCEMENT .....85  
     SELECTIVE CATALYTIC REDUCTION UNIT ...81  
 EXHAUST AFTERTREATMENT SYSTEM  
 ACCESS DOOR .....10  
 EXHAUST SYSTEM .....156  
 EXTERIOR LIGHTING VERIFICATION .....141

**F**

FLUID LEVEL VERIFICATION .....133  
     COOLANT FLUID LEVEL.....136  
     COOLING FAN RIGHT ANGLE GEARBOX OIL  
     LEVEL .....136  
     DRIVE AXLE WHEEL BEARING OIL LEVEL..136  
     ENGINE OIL LEVEL.....133  
     FRONT AND TAG AXLE WHEEL HUBS .....136  
     POWER STEERING FLUID LEVEL .....135  
     TRANSMISSION OIL LEVEL .....134

WINDSHIELD WASHER & HEADLIGHTS  
 WASHER RESERVOIRS .....137

FOG LIGHTS .....127

FOOT-OPERATED CONTROLS .....68

ACCELERATOR PEDAL.....69

SERVICE BRAKES .....68

FRONT ELECTRICAL AND SERVICE  
 COMPARTMENT .....11

FUEL AND DIESEL EXHAUST FLUID (DEF)  
 FILLER DOOR .....13

FUEL SYSTEM .....156

FUEL TYPE.....152

BIODIESEL FUELS .....152

**G**

GENERAL RECOMMENDATIONS .....143

**H**

HEATING AND AIR CONDITIONING .....157

CENTRAL HVAC SYSTEM .....157

COMPRESSOR (for central HVAC system) ....157

COMPRESSOR (for small HVAC system) .....157

SMALL HVAC SYSTEM .....157

**I**

IGNITION SWITCH .....26

INDEX ..... 187

INSIDE MIRROR.....20

INSTRUMENT CLUSTER.....48

ANALOG INCATORS .....49

DRIVER INFORMATION DISPLAY .....56

TELLTALE LIGHTS .....52

I-SHIFT TRANSMISSION – STARTING THE  
 VEHICLE AT LOW TEMPERATURES .....115

**J**

JUMP STARTING .....114

**K**

KEYLESS ENTRY SYSTEM .....99

KEYLESS OPERATING INSTRUCTIONS .....99

PROGRAMMING A PERSONAL CODE .....99

PROGRAMMING TRANSMITTERS.....100

REMOTE ENTRY TRANSMITTER.....100

KEYS .....26

ENTRANCE DOOR KEY .....26

EXTERIOR COMPARTMENTS KEY.....26

FUEL FILLER DOOR KEY .....26

**L**

LATERAL CONTROL PANEL .....28

12-VOLT DC POWER OUTLET .....31

ACCESSORY POCKET .....31

ASHTRAY .....31

AUTOMATIC FIRE DETECTION AND  
 SUPPRESSION SYSTEM (AFSS) .....31

CIGARETTE LIGHTER .....30

CONTROL SWITCHES .....28

CRUISE CONTROL .....31

LEVEL LOW SYSTEM .....29

MIRROR CONTROLS .....29

PARKING BRAKES CONTROL VALVE.....30

TAG AXLE CONTROL VALVE .....30

TIRE PRESSURE MONITORING SYSTEM  
 (TPMS).....38

TRAILER AIR SUPPLY CONTROL VALVE .....31

TRANSMISSION CONTROL PAD .....28

**M**

MUD FLAPS AND SPLASH GUARDS .....127

**N**

NON-DRIVING / STATIONARY  
 MODE MENUS .....89

AFTERTREATMENT .....94

DATA LOG .....93

DIAGNOSTICS.....91

DISPLAY SETTINGS .....89  
 PASSWORD .....95  
 PRE-TRIP ASSISTANT.....92  
 NOTICE.....165

**O**

OIL SPECIFICATIONS .....157  
     ALLISON AUTOMATIC TRANSMISSION.....157  
     DIFFERENTIAL.....157  
     ENGINE.....157  
     FAN RIGHT ANGLE GEARBOX .....158  
     I-SHIFT TRANSMISSION.....157  
     POWER STEERING RESERVOIR.....158  
 OTHER FEATURES..... 77  
 OTHER PRECAUTIONS.....3  
 OTHER VERIFICATIONS .....137  
     A/C AND HEATING SYSTEM AIR FILTERS...140  
     AIR COMPRESSOR BELT TENSION  
     ADJUSTMENT.....139  
     AIR FILTER RESTRICTION INDICATOR .....139  
     AIR TANK PURGE .....137  
     BACK-UP CAMERA .....139  
     FAN AND ALTERNATOR DRIVE BELTS .....139  
     FIRE EXTINGUISHERS .....138  
     FUEL FILTER / WATER SEPARATOR.....138  
     HOSE INSPECTION .....140  
     LUBRICATION .....141  
     PARKING/EMERGENCY BRAKE TEST .....141  
     SERVICE BRAKE TEST .....141  
     WHEEL BEARINGS .....141  
     WHEELS AND TIRES .....141

**P**

PLATES AND CERTIFICATION .....158  
     DOT CERTIFICATION PLATE .....159  
     EPA ENGINE LABEL .....159  
     SAFETY CERTIFICATION .....158  
 PROPELLER SHAFT .....154

**R**

RADIATOR DOOR..... 10  
 REAR VIEW MIRRORS..... 15  
 RECLINING BUMPER COMPARTMENT ..... 13  
 REMOTE ENTRY TRANSMITTER.....27, 100  
 RETRACTABLE TAG AXLE .....98

**S**

SAFE OPERATING PRACTICES..... 2  
 SAFETY BELTS..... 19  
 SAFETY EQUIPMENT ..... 119  
     AUTOMATIC FIRE DETECTION AND  
     SUPPRESSION SYSTEM (AFSS) .....119  
     FIRE EXTINGUISHERS .....124  
     FIRST AID KIT .....124  
     JACK AND TOOLS.....125  
     SPARE PARTS KIT.....125  
     TIRE PRESSURE MONITORING SYSTEM  
     (TPMS) .....120  
     WARNING REFLECTORS .....124  
 SAFETY FEATURES AND  
 EQUIPMENT ..... 117  
 SAFETY PRECAUTIONS ..... 1  
 SERVICE LITERATURE..... 164  
 SLIDE-OUT OPERATION ..... 101  
     FRONT AND REAR SLIDE-OUT OPERATION101  
     SAFETY PRECAUTIONS.....101  
     SLIDE-OUT MANUAL OVERRIDE  
     PROCEDURE .....102  
     SLIDE-OUT TROUBLESHOOTING .....105  
     TROUBLESHOOTING – OPERATING  
     CONDITIONS, CONTROL & MECHANICAL  
     COMPONENTS.....106  
 STARTING AND STOPPING  
 PROCEDURES ..... 111  
 STARTING THE ENGINE..... 112  
     STARTING FROM THE DRIVER'S SEAT.....112  
     STARTING FROM THE ENGINE  
     COMPARTMENT .....112  
 STEERING COLUMN CONTROLS..... 65



HORNS .....67

MULTI-FUNCTION LEVER .....65

STEERING WHEEL CONTROLS.....66

TRANSMISSION RETARDER .....68

STEERING WHEEL ADJUSTMENT .....20

STEERING .....155

SUNSHADES (BLINDS) .....20

SUSPENSION.....155

    DRIVE AXLE .....155

    INDEPENDENT FRONT SUSPENSION .....155

    TAG AXLE .....155

**T**

TECHNICAL INFORMATION..... 149

TIRE PRESSURE MONITORING SYSTEM  
(TPMS).....38, 120

TOWING.....126

TRAILER HITCH .....16

TRANSMISSION RETARDER .....68, 95

**V**

VARIABLE ASSISTANCE STEERING  
GEAR (OPTIONAL) .....99

VEHICLE EXTERIOR..... 5

VEHICLE IDENTIFICATION  
NUMBER (VIN) .....159

VEHICLE INTERIOR..... 17

VOLVO I-SHIFT TRANSMISSION.....72, 154

    ACCELERATOR PEDAL .....73

    DISPLAY .....72

    DRIVING.....75

    ECONOMY AND PERFORMANCE MODE .....73

    ECO-ROLL MODE (FREEWHEEL FUNCTION)73

    GEAR RATIOS .....154

    LIMP HOME MODE.....73

    PUSHBUTTON SHIFT SELECTOR .....72

    STARTING AND STOPPING.....74

    STARTING THE VEHICLE UPHILL AND  
    DOWNHILL.....74

TOWING.....76

**W**

WALK-AROUND INSPECTION  
(BEFORE EVERY TRIP) ..... 146

WHEELS AND TIRES ..... 153

    RECOMMENDED TIRE INFLATION  
    PRESSURE AT MAXIMUM COLD LOAD .....153

WINDOWS .....20, 132

    AWNING WINDOWS.....20, 118

    DRIVER'S POWER WINDOW .....20

    FIXED WINDOWS .....20, 118

    SLIDING WINDOWS .....21, 118