

Ground Distribution

Electronic gnd to Dash harness

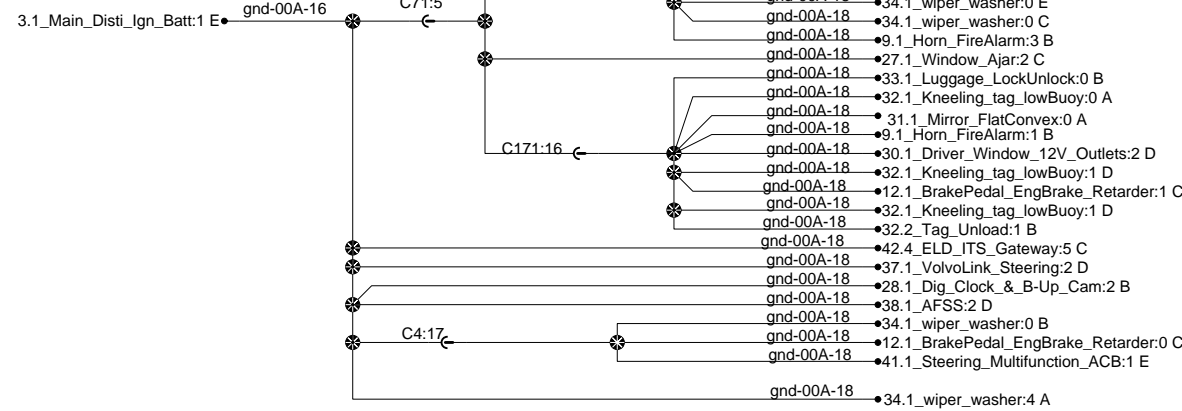

Dash stud

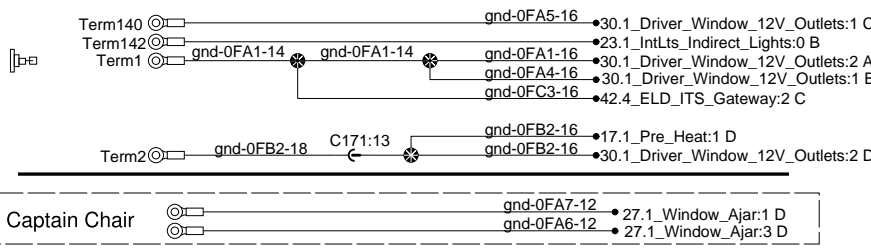

Electronic gnd on FJB

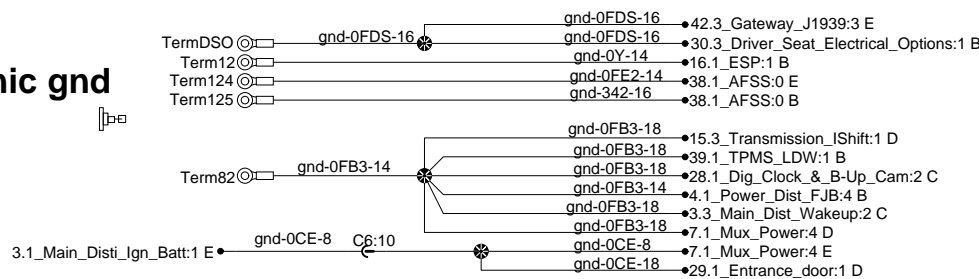

Front stud

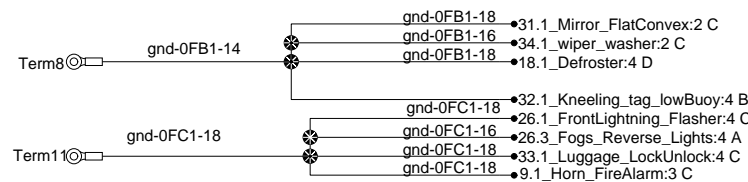

RH Console stud

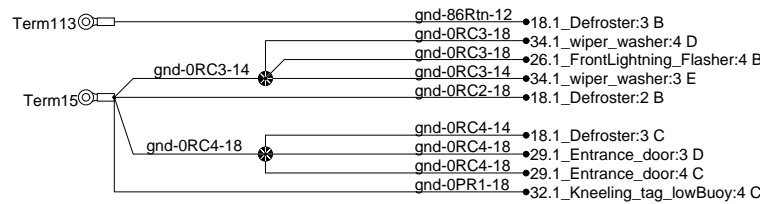

Chassis gnd Parcel Rack stud

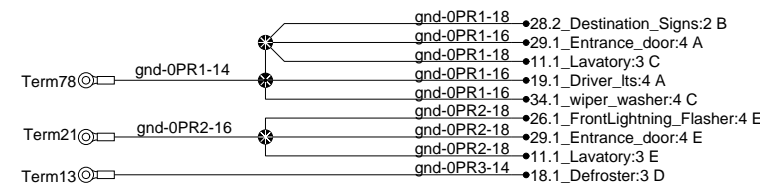

Condensor cmpt. stud

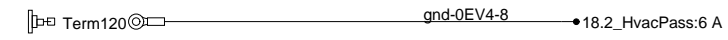

Evaporator cmpt. stud

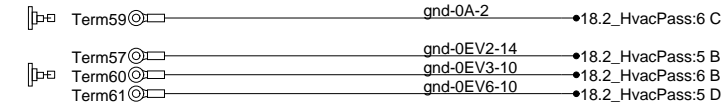

Electronic gnd to Rr mux 0G

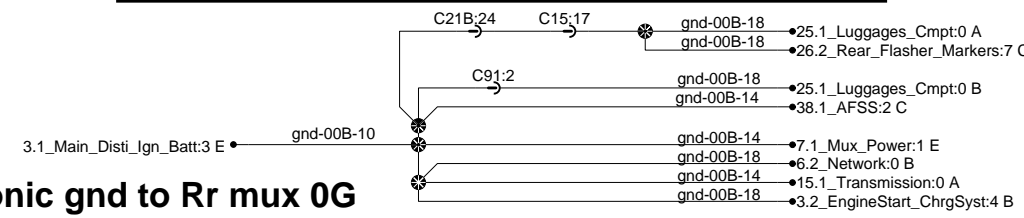

RJB stud Chassis Gnd

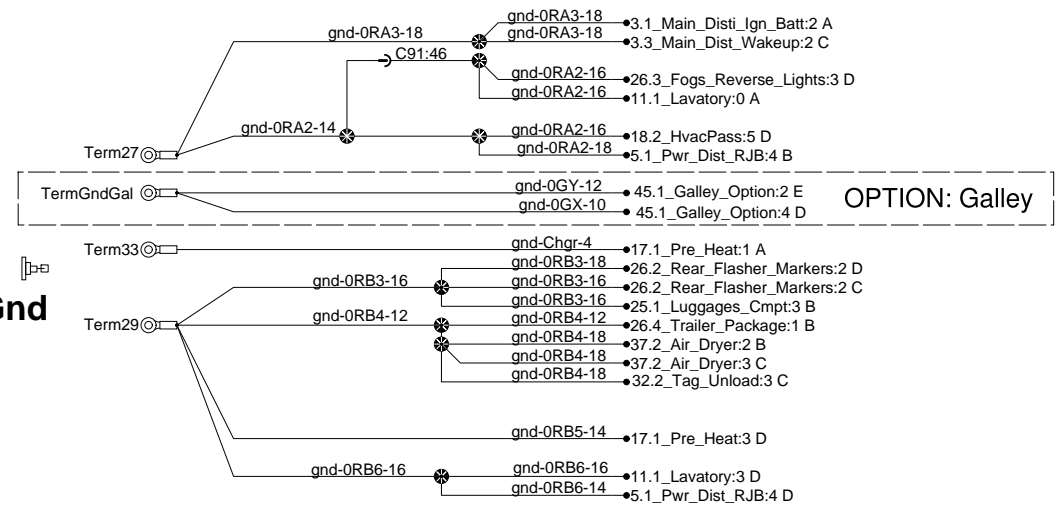

Lavatory Stud

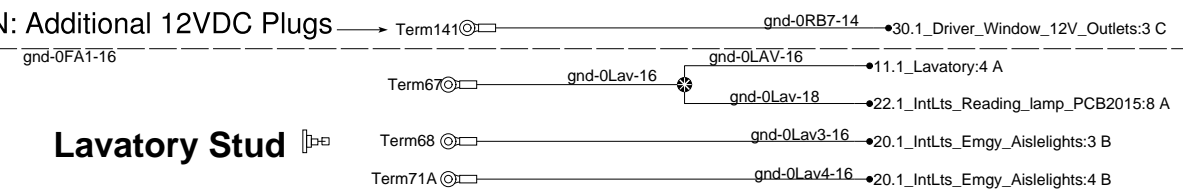

Eng. cmpt gnd stud

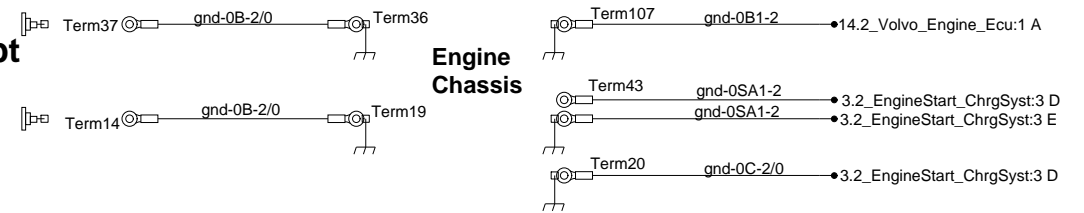

Engine Chassis

