

PREVOST[®]

COACH MANUFACTURER

X3-45 COMMUTER OPERATING MANUAL

DOB Bus Number Series 2490-2789



Final Version Rev. 1 – January 2015

PA1604 January 2015

Featuring:

- GHG14 regulations engine
- ZF Axle
- Parcel rack evaporator

REVISION	DESCRIPTION	DATE
01	Page updates	01/09/2015

This PREVOST X3-45 Commuter operating manual conforms to the new GHG 2014 regulations. This manual has been prepared for the Metropolitan Transportation Authority (MTA) to thoroughly acquaint the driver and service technicians with the equipment and features of the coach in order to fully appreciate and safely enjoy this vehicle. Prevost is committed to the continuous improvement of coach quality, reliability, durability and safety. With innovative features, the X3-45 Commuter coach was designed with passenger and driver safety and comfort in mind.

This manual contains information available at the time of publication.

NOTE

Pictures and illustrations in this manual are used for reference only and may differ slightly from the actual vehicle, however, key components addressed in the manual are represented as accurately as possible.

Driver's controls and instruments incorporate advanced technology for enhanced driving ease and security. This manual describes the main features, instruments and controls, and servicing requirements for the equipment. Read this manual carefully to take advantage of the coach's advanced features and to ensure optimum safety and passenger comfort.

Keep this manual in the coach at all times. Make sure this manual is kept with the coach when ownership is transferred. Please use the appropriate card at the end of this manual to promptly notify Prevost of any change of address or transfer of ownership. This will ensure we provide fast and reliable coach service to all coach operators.

DANGER, WARNING, CAUTION and *NOTE* are used throughout this manual to emphasize important points when necessary:



DANGER

Directs the operator's attention to unsafe practices which could result in serious personal injury or death.



WARNING

Directs the operator's attention to unsafe practices which could result in serious personal injury or severe damage to the vehicle.



CAUTION

Directs the operator's attention to unsafe practices where personal injury is not likely but damage to vehicle components could occur.

NOTE

Indicates supplementary information essential to the proper operation of the vehicle.

The service life of the coach depends on the kind of attention it receives. Pay close attention to the **DANGER, WARNING, CAUTION** and *NOTE*. Read the various notices and instructions posted throughout the coach and attached to equipment.

Since continuous improvement is a primary focus at Prevost, we reserve the right to make changes anytime, without notice, and without incurring any obligation.

Before reproducing or copying this manual, in whole or in part, written consent must be obtained from Prevost.

CRITICAL EMISSION-RELATED MAINTENANCE

Source of parts and repair:

A repair shop or person of the owner's choosing must maintain, replace, or repair emission control devices and systems per manufacturer's recommendations.

Replacement of tires that are GHG certified:

The original equipment tires installed on this vehicle at the factory were certified to the U.S. EPA Greenhouse Gas (GHG) and **National Highway Traffic Safety Administration (NHTSA)** Fuel Efficiency regulations. Replacement of these tires should be with a tire of equal or lower rolling resistance levels (TRRL or Crr). Please consult your tire supplier(s) for appropriate replacement tires.

Maintaining a GHG certified tire:

In order to maintain the certified rolling resistance of the tires which optimize fuel economy, the maintenance procedures provide by the tire manufacturer must be followed.

EVENT DATA RECORDING DEVICES

This PREVOST vehicle is equipped with a device generally referred to as an "event data recorder" or "EDR." Please note that while the term "event data recorder" is typically used throughout the motor vehicle industry, not every EDR is the same; i.e., they do not all record the same data elements.

The EDR on this PREVOST vehicle records vehicle speed, engine RPM, time and date, plus a variety of pedal and switch positions, both before and after an "event." Sudden vehicle deceleration or the occurrence of certain other vehicle operational characteristics will define (trigger) an "event."

For any questions about this vehicle EDR device, contact a PREVOST Service Center or a regional service manager.

SECTION 1 SAFETY PRECAUTIONS.....1-1

SECTION 2 COACH EXTERIOR.....2-1

SECTION 3 COACH INTERIOR.....3-1

SECTION 4 CONTROLS AND INSTRUMENTS.....4-1

SECTION 5 OTHER FEATURES.....5-1

SECTION 6 STARTING AND STOPPING PROCEDURE.....6-1

SECTION 7 SAFETY FEATURES AND EQUIPMENT.....7-1

SECTION 8 CARE AND MAINTENANCE.....8-1

SECTION 9 TECHNICAL INFORMATION.....9-1

SECTION 10 ABBREVIATIONS.....10-1

SECTION 11 APPENDIX A – SERVICE LITERATURE11-1

SECTION 12 APPENDIX B – ALLISON TRANSMISSION’S OTHER FEAT.....12-1

SECTION 1 SAFETY PRECAUTIONS

SAFE OPERATING PRACTICES 2

DEFENSIVE DRIVING PRACTICES..... 2

OTHER PRECAUTIONS 3

1-2 SAFETY PRECAUTIONS

SAFE OPERATING PRACTICES

To ensure safe and reliable operation, heed the following safety precautions.

- Operation and maintenance of the vehicle must be performed only by qualified personnel.
- Before driving, conduct a walk around inspection and check that all baggage compartment doors and equipment access doors are securely shut.
- Make sure good visibility is maintained at all times. Keep windshields clean and free of obstructions.
- Adjust the driver's seat so that all controls can be reached easily.
- Always wear your safety belt when driving.
- Check the instrument panel frequently. Do not operate the vehicle when dials or indicators do not indicate normal operating conditions.
- Always pay attention to pedestrians passing in front and behind the vehicle. Always yield to pedestrians at pedestrian walkways.
- Do not drive over obstacles on the road. Empty boxes, piles of leaves, and snowdrifts could conceal hidden dangers that could damage the vehicle suspension and underbody.
- When turning or changing lanes, signal your intention well in advance.
- When approaching to make a right turn, reduce the space between the vehicle and the curb to make sure another vehicle cannot pass on the right. Since the vehicle makes wide turns, allow enough space to make safe turns.
- Switch from high beams to low beams when meeting or following other vehicles within 500 feet (150 meters).
- Never leave the vehicle unattended with the engine running or with the key in the ignition. Turn off the engine, remove keys and apply the parking brake before leaving the vehicle.
- Shut-off the engine before refueling, adding oil, performing maintenance or servicing tasks, unless stated otherwise.
- Fuel is highly flammable and explosive. Do not smoke when refueling. Keep away from open flames or sparks.

- Do not run the engine or HVAC system with access doors left open. Close compartment doors before operating any equipment.
- Do not remove the surge tank filler cap or the cooling system pressure cap when the engine is hot. Let the engine cool down before removing filler caps.
- Do not attempt to push or pull-start the vehicle.
- The service life of the vehicle depends on the kind of maintenance it receives. Always record any problems and report them immediately to maintenance personnel.

DEFENSIVE DRIVING PRACTICES

- For city driving, allow a four to six second travel interval between your vehicle and the vehicle ahead. Increase this travel interval to six to eight seconds for highway driving. Increase time interval for driving at night or in foul weather.
- Be prepared to stop when approaching an intersection. The stopping distance of the vehicle increases with the weight and speed.
- Establish eye-to-eye contact with other drivers and with pedestrians. Use, high beam and low beam headlights, turn signals and horn as needed.
- On highway, don't stare at the road ahead. Keep your eyes moving. Check mirrors and dashboard instruments frequently.
- To keep the vehicle from drifting across lanes during highway driving, always look over the horizon on the road ahead.
- Adjust your speed to road conditions, traffic and visibility. Never exceed the posted speed limits.
- If another vehicle is following close behind, reduce your speed to let the vehicle pass.
- For additional information about safe operation and defensive driving practices, contact the local department of motor vehicles authority.

OTHER PRECAUTIONS

**WARNING**

This vehicle is not designed to carry standing passengers.

**DANGER**

Make sure that electrical current or air pressure is removed before performing any work. A part may be energized even if the ignition switch is OFF. A part may be under pressure even if all tanks are empty. Before performing any work on the vehicle, refer to wiring diagrams and/or air schematics to thoroughly understand the system.

**WARNING**

CALIFORNIA PROPOSITION 65:

Diesel engine exhaust and some of its constituents are known to the State of California to cause cancer, birth defects and other reproductive harm.

Battery posts, terminals and other related accessories contain lead and lead compounds, chemical known to the State of California to cause cancer and other reproductive harm.

Batteries also contain other chemicals known to the State of California to cause cancer.

Wash hands after handling.

**CAUTION**

Disconnect all electronic control modules before welding. If modules (MCM, ECM, TCM, ECU, and ABS) are not disconnected before welding is done, there is a high risk of damaging the electronic components (EPROM, Chip). Refer to procedure described in Maintenance Manual.

SECTION 2 COACH EXTERIOR

X3-45 COMMUTER EXTERIOR VIEWS	2
ENGINE COMPARTMENT OVERVIEW	3
ENGINE COMPARTMENT.....	4
ENGINE COMPARTMENT CURBSIDE DOOR.....	4
ENGINE COMPARTMENT REAR DOOR.....	4
EXHAUST AFTERTREATMENT SYSTEM ACCESS DOOR.....	5
ENGINE RADIATOR DOOR	5
SCR CONVERTER ACCESS DOOR	6
CONDENSER COMPARTMENT (A/C).....	6
EVAPORATOR COMPARTMENT.....	7
COOLANT HEATER COMPARTMENT	8
FRONT ELECTRICAL AND SERVICE COMPARTMENT	8
BAGGAGE COMPARTMENTS	9
FUEL AND DIESEL EXHAUST FLUID (DEF) FILLER DOOR	10
BI-FOLD ENTRANCE DOOR	11
<i>OPENING DOOR</i>	<i>11</i>
<i>CLOSING DOOR</i>	<i>11</i>
WHEELCHAIR LIFT ACCESS DOORS	11
REAR VIEW MIRRORS.....	11
HUBODOMETER.....	12

2-2 COACH EXTERIOR

X3-45 COMMUTER EXTERIOR VIEWS

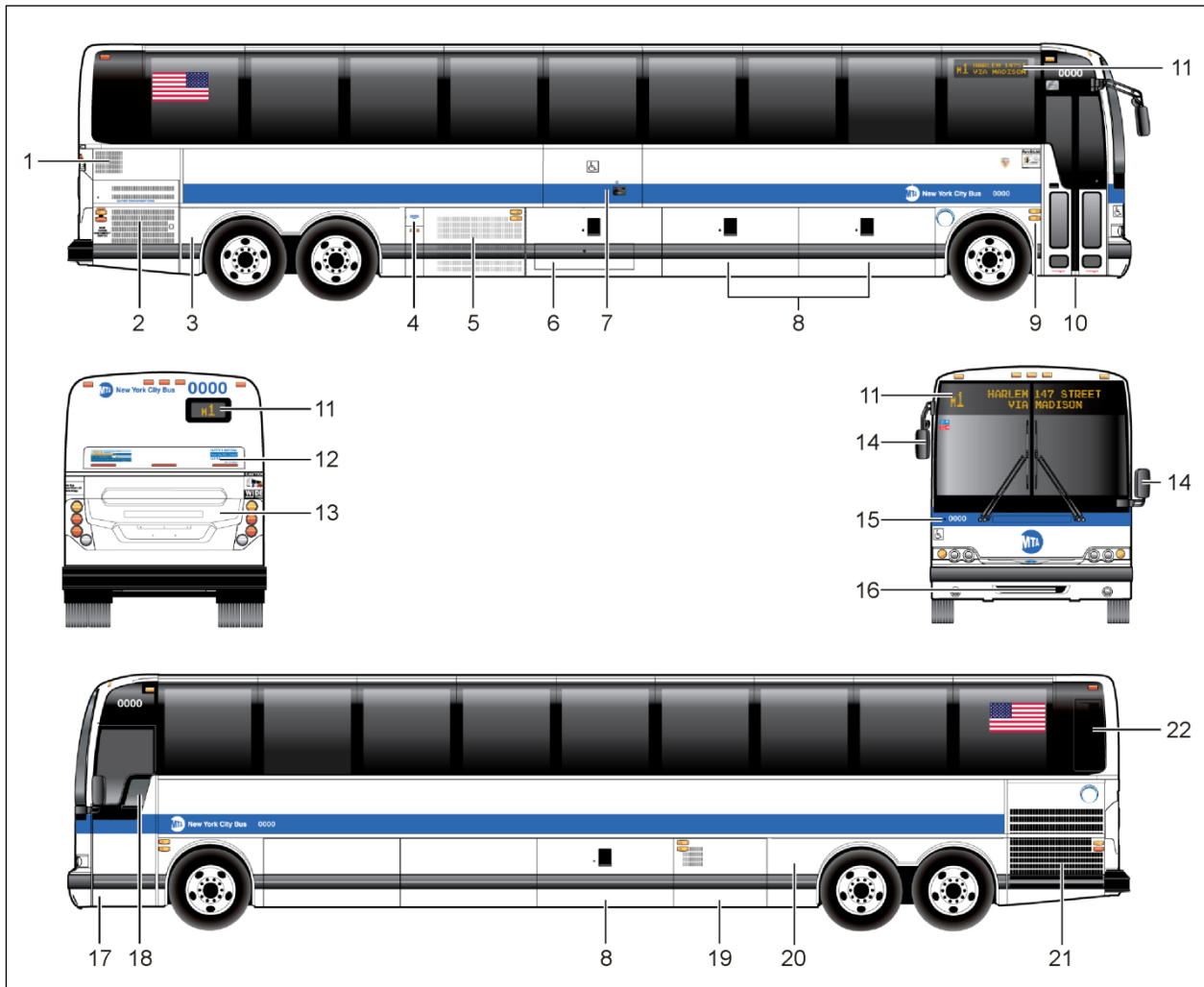

X3-45 EXTERIOR VIEW (TYPICAL)

18606

- | | |
|-------------------------------------------------|----------------------------------------------------|
| 1. Engine air intake | 12. Exhaust aftertreatment system access door |
| 2. Engine compartment curbside door | 13. Engine compartment rear door |
| 3. Hinged rear fenders | 14. Rear-view mirrors |
| 4. Fuel filler neck & DEF filler neck door | 15. Transmission retarder off indicator light |
| 5. Condenser compartment | 16. Front towing air supply connectors access door |
| 6. Lift mechanism access door | 17. Front electrical and service compartment |
| 7. Wheelchair access door | 18. Driver's power window |
| 8. Baggage compartment | 19. Evaporator compartment |
| 9. Entrance door control switch | 20. Coolant heater & air dryer compartment |
| 10. Bi-fold entrance door | 21. Radiator door |
| 11. Electronic destination sign or route number | 22. SCR converter access door |

ENGINE COMPARTMENT OVERVIEW

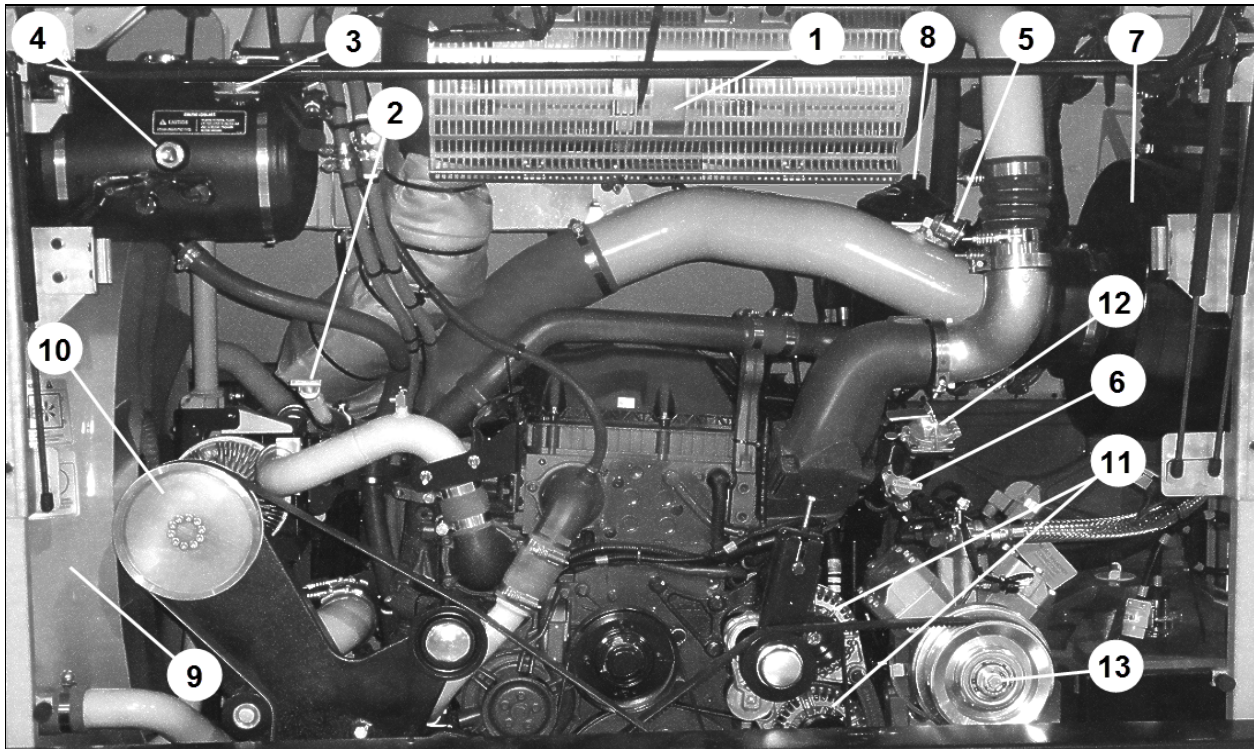

ENGINE COMPARTMENT FEATURING VOLVO D13 ENGINE

01184

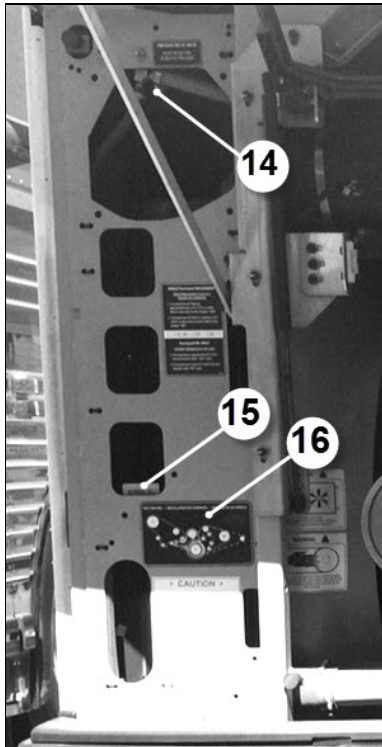

ENGINE COMPT. LEFT SIDE VIEW

1. Diesel Oxidation Catalyst (DOC) & Diesel Particulate Filter (DPF)
2. Allison Transmission fluid dipstick
3. Coolant fluid surge tank filler cap
4. Coolant fluid surge tank sight glass
5. Air filter restriction indicator
6. Engine oil dipstick
7. Air filter;
8. Power steering fluid reservoir
9. Radiator fan shroud
10. Radiator fan drive mechanism
11. Alternators
12. Engine oil filler tube
13. A/C compressor
14. Coolant fluid pressure relief valve
15. Radiator door opening lever
16. Belt routing tag

ENGINE COMPARTMENT

ENGINE COMPARTMENT CURBSIDE DOOR

This door can be open using the exterior compartment key.

The engine compartment curbside door offers two different opening amplitudes, one for normal access and the second when wider maintenance access is needed. This door provides access to the following:

- Booster terminals;
- Engine compartment rear door release handle;
- Engine block heater 120-volts connector;
- Battery charger 120-volts connector (on curbside door);
- Rear electrical panel;
- Rear junction panel;
- Battery compartment with main circuit breakers;
- Air system fill valve;
- Curbside door cooling fan.

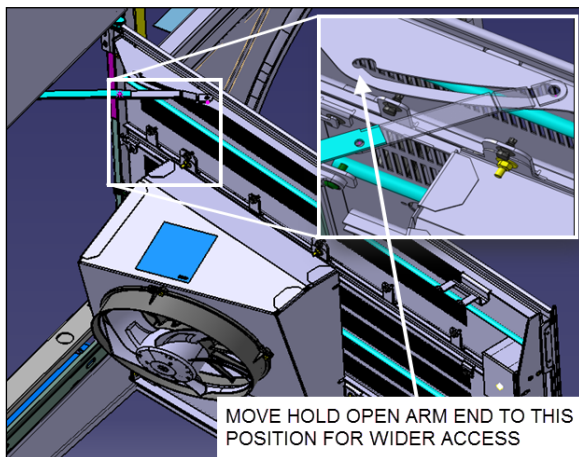

ENGINE COMPARTMENT CURBSIDE DOOR

18559_3



WARNING

AUTOMATIC FAN DRIVE

Keep clear of curbside door cooling fan when engine is running. Fan may engage without warning.



ENGINE COMPARTMENT R.H. SIDE

18607_2

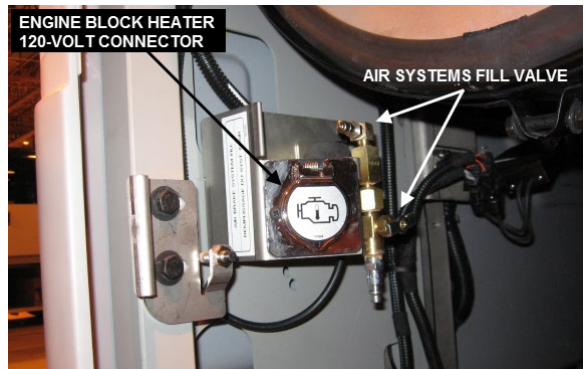

ENGINE BLOCK HEATER 120 VOLTS CONNECTOR

ENGINE COMPARTMENT REAR DOOR

To open the engine compartment rear door, open the engine compartment curb side door first and then pull the yellow handle located on the rear door. Grab the side of the door in the middle, pull and lift the door.

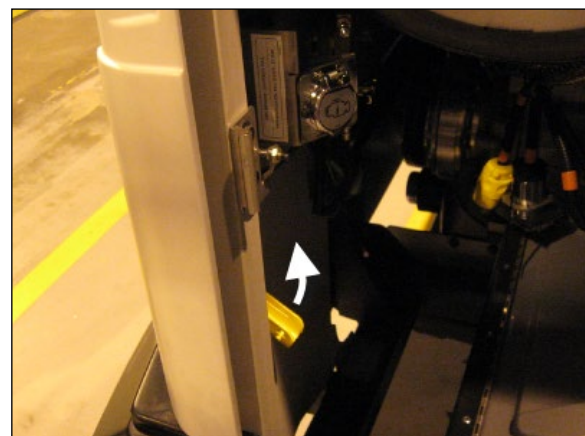

OPENING ENGINE COMPARTMENT REAR DOOR

A catch engages to maintain the door in the full open position. To close the door, slightly lift up the door and release the catch before firmly shutting down the door.

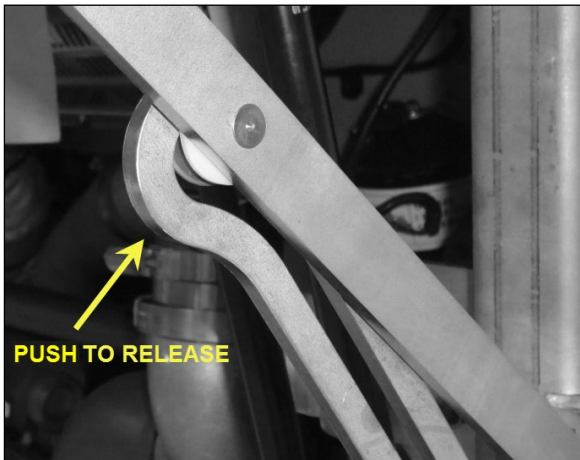

REAR DOOR SAFETY CATCH

Turn the lights ON in the engine compartment using the switch on the rear start panel.



WARNING

Unless otherwise specified, do not run engine when the engine compartment rear doors are open. Close the engine compartment rear doors before starting the engine.

The door swings out to provide access to the following:

- Engine;
- Alternators;
- A/C compressor;
- Rear Gauge;
- Engine starting selector (refer to section; Starting and Stopping Procedures);
- Coolant line shutoff valves;
- Certification plates;
- Engine coolant surge tank and filler cap;
- Air filter restriction indicator;
- Engine oil dipstick and filler tube;
- Power steering fluid reserve tank;
- Allison transmission fluid dipstick;

EXHAUST AFTERTREATMENT SYSTEM ACCESS DOOR

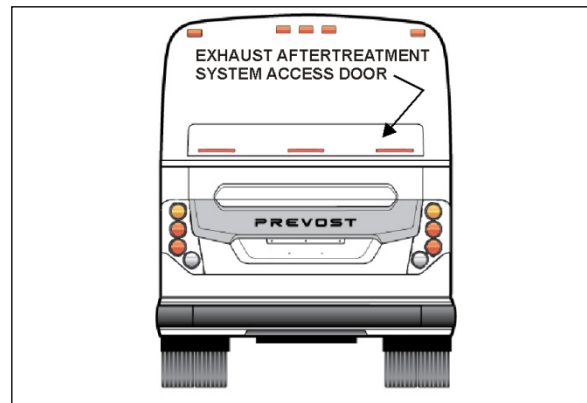

The engine door must be open before opening the exhaust aftertreatment system access door. To open the access door, lower the latch release lever, using a flat tip screwdriver.

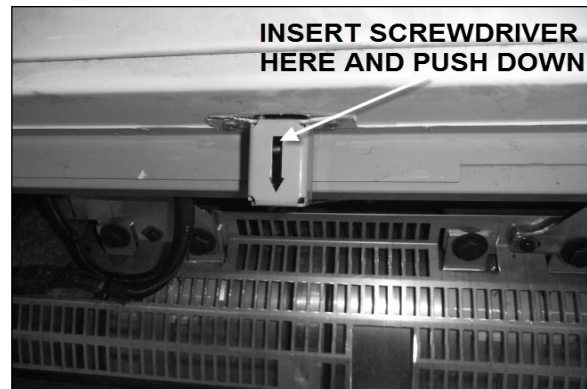

To close the door, lower the door and push against the release lever spring to latch the door shut.

ENGINE RADIATOR DOOR

First open the engine compartment doors before opening the radiator door. The release lever is located near the radiator. Pull the release lever forward to open the radiator door.



RELEASE LEVER

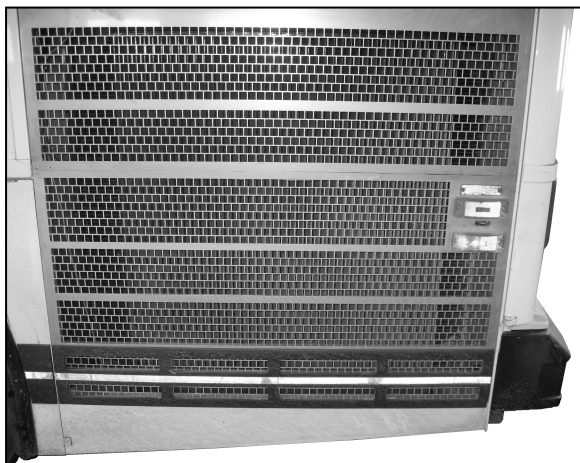

RADIATOR DOOR 18560

SCR CONVERTER ACCESS DOOR

To gain access to the SCR converter, open the radiator door first. At the top of the radiator compartment, pull the catch connecting rod to unlock the catalytic converter access door and lift the door open.

Hold the door open by inserting the support rod free end into the receptacle located on the left side of the DPF.

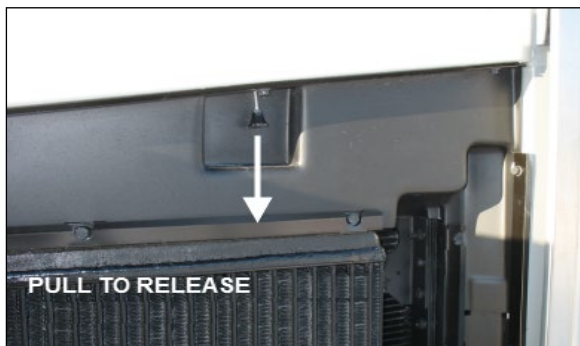

UNLOCKING SCR CONVERTER ACCESS DOOR

WARNING

After inserting the support rod into the receptacle, make sure the rod supports the door securely from falling down on to your head or body.

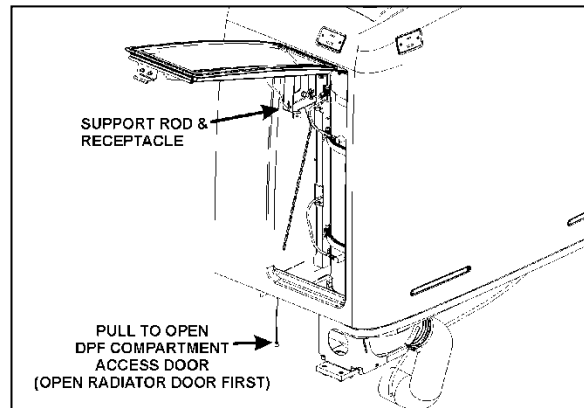

ACCESS TO THE SCR CONVERTER 04023

WARNING

External and internal temperatures remain hot long after engine has been shutdown. Allow the Exhaust Aftertreatment System to cool before handling. Wear protective clothing and glove while servicing.

CONDENSER COMPARTMENT (A/C)

Open the fuel filler neck access hatch and push the lever down to unlatch the condenser compartment door.

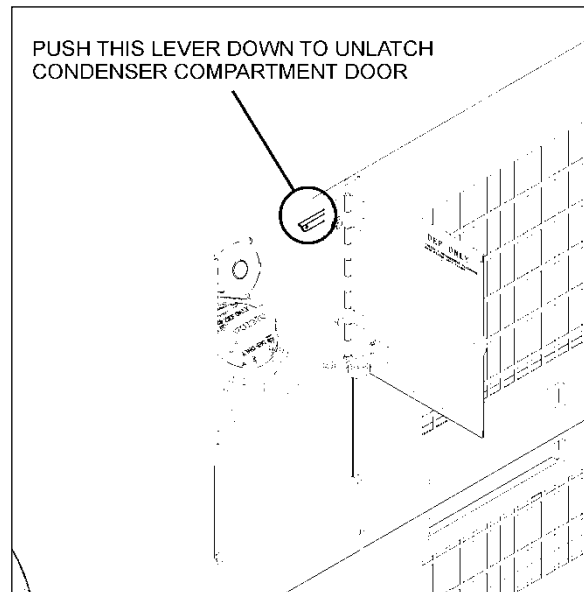

OPENING CONDENSER DOOR

The condenser compartment provides access to the following:

- Diesel Exhaust Fluid (DEF) Tank
- Condenser;
- Condenser fans and motors;
- Filter dryer and moisture indicator;
- Receiver tank;

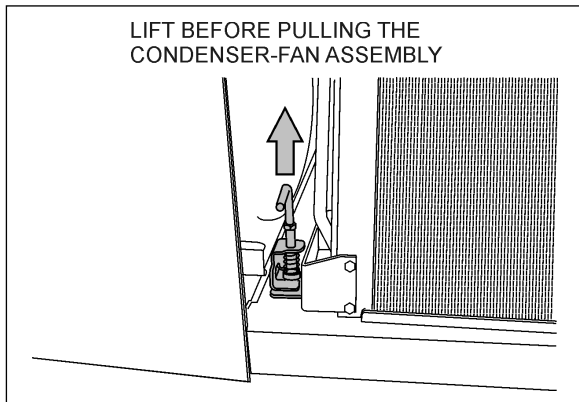

PULLING THE CONDENSER-FAN ASSEMBLY

CAUTION

Only the strap should be used to pull the condenser-fan assembly open. Damage to condenser could result if pulling by other means.



CONDENSER COMPARTMENT STRAP

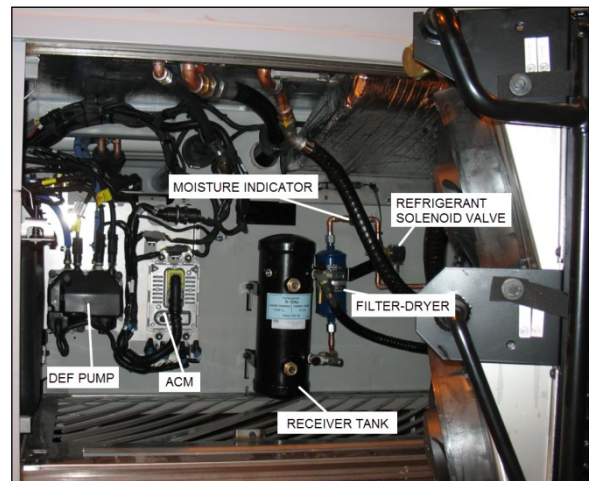

CONDENSER COMPARTMENT (A/C)

22299

EVAPORATOR COMPARTMENT

The evaporator compartment door release latch is located in the baggage compartment located to its left. Pull the release latch then slide your hand in the opening to depress the evaporator compartment door secondary lock and swing open.

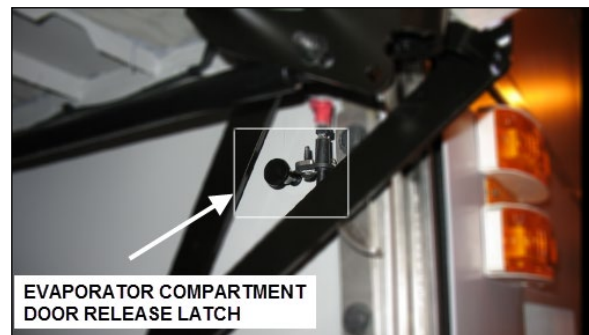

EVAPORATOR COMPARTMENT DOOR RELEASE LATCH

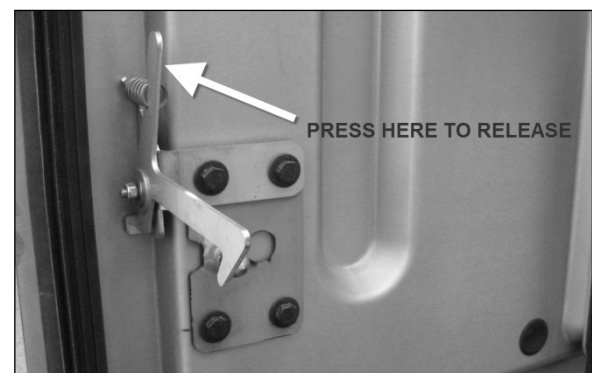

EVAPORATOR COMPARTMENT DOOR SECONDARY LOCK LEVER

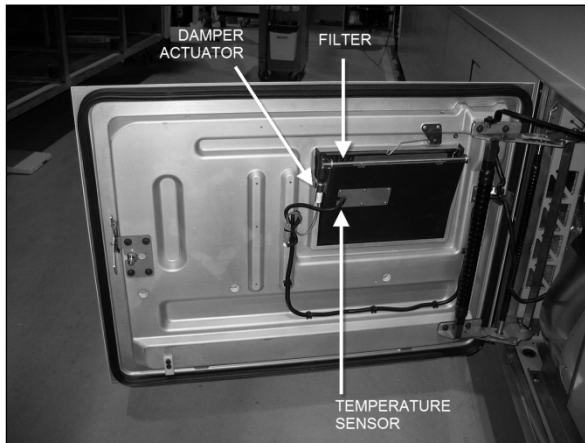

EVAPORATOR COMPARTMENT DOOR

The door features a recirculation damper actuator, a temperature sensor and a cleanable filter.

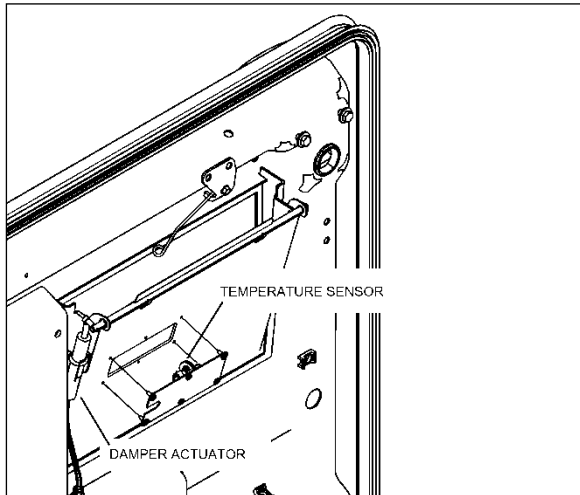

RECIRCULATION DAMPER AND TEMP. SENSOR 22302_A

COOLANT HEATER COMPARTMENT

The hot water recirculating pump and the air dryer are found inside this compartment located aft of the evaporator compartment. To gain access, lift the rear fender.



COOLANT HEATER COMPARTMENT

Rear fenders are hinged for maintenance on brakes and suspension. Each rear fender panel has two mechanical spring loaded holding devices fixing it to the vehicle's structure. Push the rod sideways to disengage the lock.

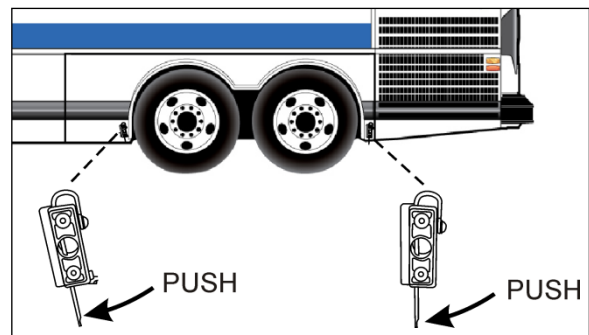

LIFTING REAR FENDERS

FRONT ELECTRICAL AND SERVICE COMPARTMENT

Use the exterior compartment door key to open the front electrical and service compartment door from outside the coach. The front electrical and service compartment provides access to the following:

- Front terminal block;
- VECU;
- Vehicle Electrical Center Front (VECF), MCM and Multiplex Modules;
- C226 connector (MCM) type DB9 for laptop diagnostic tool;
- Relays and fuses;
- Tag axle control valve;
- ABS Electronic Control Unit (ECU);
- Emergency door unlatch valve;
- Master Interlock cancel switch;
- Windshield washer reservoir;
- Accessories system fill valve;
- Accessories air tank pressure relief cock;

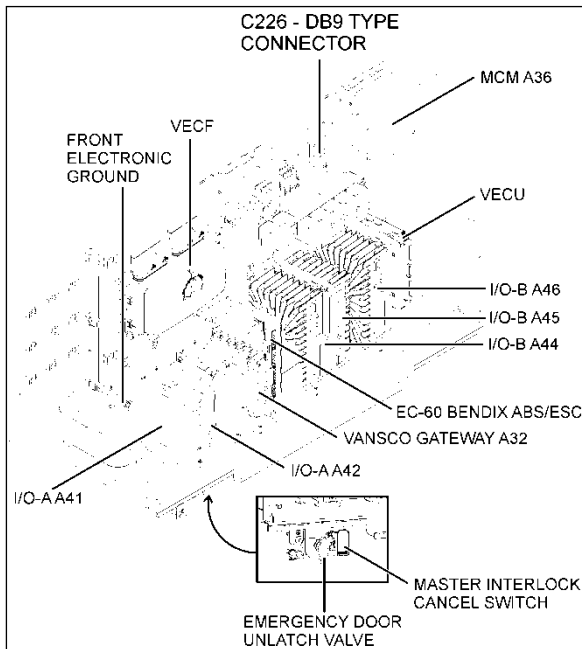

FRONT SERVICE COMPARTMENT ELECTRICAL PANEL



FRONT SERVICE COMPARTMENT

The light in the front electrical and service compartment turns *ON* automatically when the door is opened.

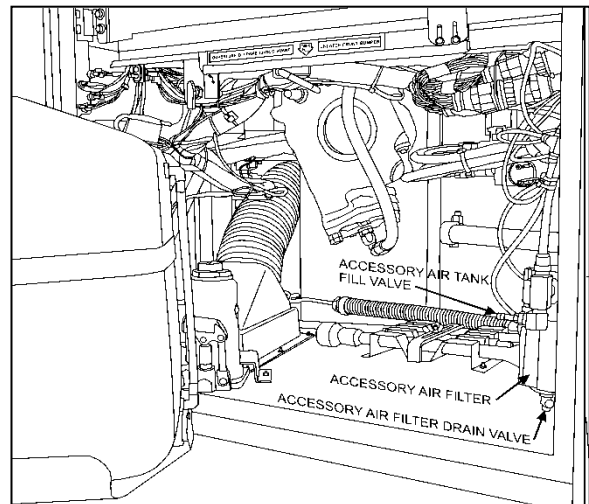

FRONT SERVICE COMPARTMENT

18611

BAGGAGE COMPARTMENTS

The compartments can be locked or unlocked by using the provided "GM" key. The baggage compartments may also be locked using a seal on the operating handle.

2-10 COACH EXTERIOR

Note that the two front compartments are only accessible from curb side while the third rear is accessible from both sides.

Lift up operating handle to release the latch, and then pull the door open by the handle rod. Pressurized cylinders assist the opening and closing of the baggage compartment doors and hold the doors open.

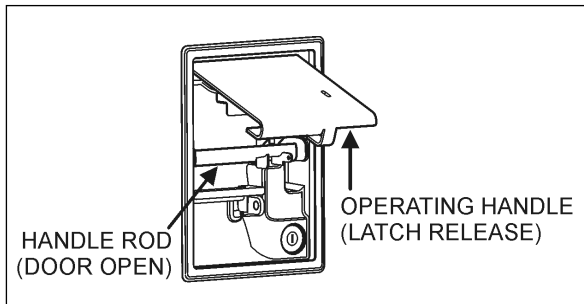

BAGGAGE DOOR LOCK AND LEVER

18693

To close, pull down the door by the handle rod. Complete the closing of the door by returning the operating handle to its initial position.



CAUTION

Do not slam shut the baggage compartment doors. Damage to door weather-stripping or locking mechanism could result.

Lights in the baggage compartments turn **ON** automatically when the door is opened.



BAGGAGE DOOR CATCH

18612

NOTE

For added safety, open the door until the catch assist in holding the door in the open position.



WARNING

To avoid injury, keep hands clear of baggage compartment door edge and door frame when closing.

FUEL AND DIESEL EXHAUST FLUID (DEF) FILLER DOOR

The fuel and Diesel Exhaust Fluid (DEF) filler door is located on the R.H. side of the coach providing easy filling. A spring keeps the door either open or shut. The vehicle is equipped with Emco Wheaton POSI/LOCK 105 Automatic DRY-BREAK Fuelling System; the POSI/LOCK Filler Neck Assembly is installed on the fuel tank and requires the use of POSI/LOCK Refueling Nozzle for proper operation.

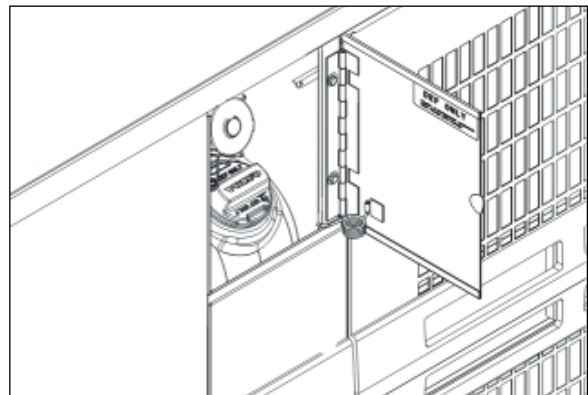

FUEL & DEF FILLER DOOR

03046

NOTE

Provided the vehicle is parked on level ground, an automatic nozzle will automatically shut off when fuel tank is approximately 95% full.



CAUTION

Diesel exhaust fluid DEF will begin to crystallize and freeze at 12°F (-11°C) and expand by 7% when frozen. To allow expansion without damaging the DEF tank, do not fill the tank with more than 15.9 gallons (60 liters).



CAUTION

Do not fill to more than 95% of the fuel tank capacity. Do not "top off" the tank, doing so may result in fuel spillage when the fuel expands.

BI-FOLD ENTRANCE DOOR

Lock or unlock the bi-fold entrance door from outside the vehicle by turning the key in the door lock (counterclockwise to lock, clockwise to unlock). The entrance door can be unlocked from the inside using the small lever located on the door.

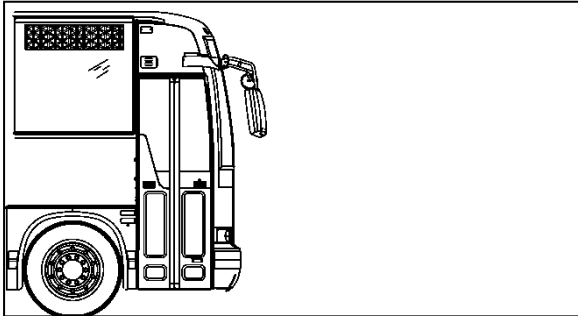

ENTRANCE DOOR 18001

Opening door

Opening the door requires only one push on exterior or interior door operating buttons. The door will open to full open position.

Closing door

To close the door, **push and hold** the exterior or interior door operating buttons. The door can be closed to any position by releasing the operating button when the desired position is attained. However, the door is not locked in any position other than fully closed. The door can therefore be closed further or opened by pushing or pulling on the door by hand.

NOTE

The interior and exterior door operating buttons are disabled when the ignition is set to the OFF position for more than 15 minutes. To reactivate, press and hold the exterior button in the open position.

The exterior door operating button is disabled when the ignition is set to the ON position.

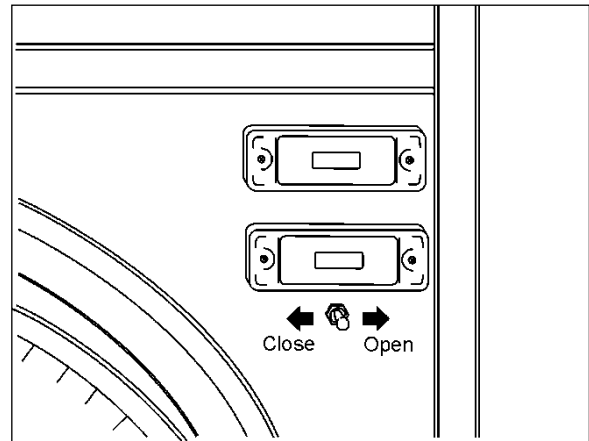

ENTRANCE DOOR EXTERIOR SWITCH 18599

Door Operation Logic

Once the door is fully open or closed, the system holds pressure in the door cylinder, holding the door in that position.

The interior door opening button flashes when the vehicle speed is below 3 mph to indicate that the driver is allowed to open the door.

Emergency Entrance Door Opening

Refer to “Safety Features and Equipment” section.

WHEELCHAIR LIFT ACCESS DOORS

Refer to “Other Features” for more information on operating the wheelchair lift.

REAR VIEW MIRRORS

The vehicle is equipped with flat-type and convex-type rear-view mirrors. Convex mirrors give a wide angle view. Objects viewed in convex-type rear-view mirrors appear smaller and are actually closer than they appear.

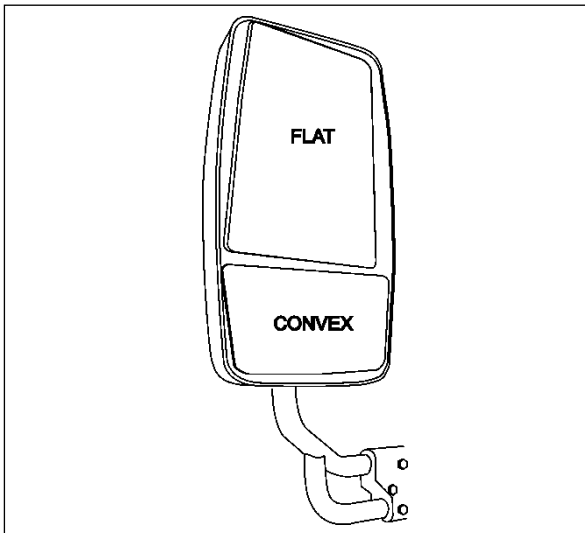

REAR VIEW MIRRORS (R.H. SHOWN)

L.H. and R.H. side mirrors are basically the same except that the R.H. side mirror support arm is also equipped with a round convex type mirror to provide better visibility in front of the vehicle R.H. side corner.



CAUTION

Round convex type mirror is not adjustable.

The mirrors are adjusted using the controls located on the L.H. control panel. Refer to "Controls & Instruments" section. Manual adjustment is also possible.

HUBODOMETER

An odometer is installed on the curbside drive axle wheel hub. The odometer calculates the total distance traveled by the coach since manufacture, including factory road testing.

NOTE

It is normal for the hubodometer, the engine ECM and the vehicle odometer to disagree on the total mileage.

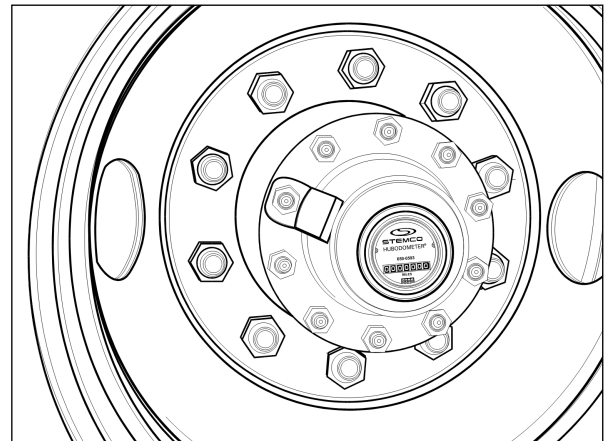

HUBODOMETER

13012

SECTION 3 COACH INTERIOR

STEERING WHEEL ADJUSTMENT	2
AISLE MIRROR.....	2
ADJUSTABLE HVAC REGISTERS.....	2
DRIVER’S SEAT – RECARO	2
ADJUSTMENT.....	2
SAFETY BELTS.....	3
PASSENGER SEATS	4
SEAT RECONFIGURATION FOR MOBILITY DEVICES	4
MOBILITY DEVICE SECUREMENT BELT OPERATION.....	5
WHEELCHAIR OCCUPANT RESTRAINT	5
OVERHEAD CONSOLE	5
ADJUSTABLE AIR REGISTERS	5
STOP REQUEST.....	5
READING LIGHTS	5
WINDOWS	5
PANORAMIC WINDOWS	5
<i>FIXED WINDOWS</i>	<i>5</i>
<i>EMERGENCY WINDOWS</i>	<i>5</i>
DRIVER’S POWER WINDOW	6
<i>DRIVER’S WINDOW SHADES</i>	<i>6</i>
WINDSHIELD.....	6
VENTILATION HATCH	6
OVERHEAD COMPARTMENTS	6

3-2 COACH INTERIOR

STEERING WHEEL ADJUSTMENT

Push on the valve button located in the foot-operated control housing to unlock the steering wheel for tilt and telescopic adjustment (refer to “Controls and Instruments” section).

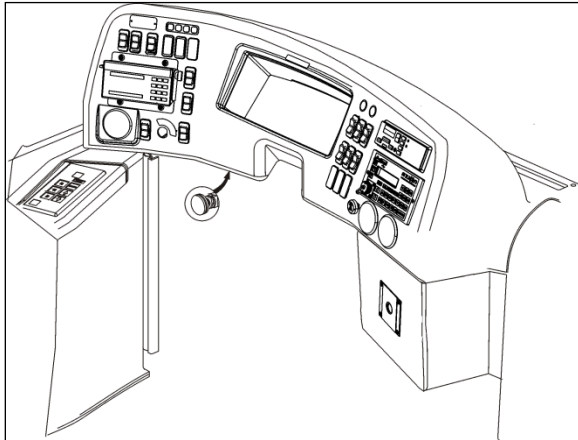

TILT AND TELESCOPIC ADJUSTMENT

18670_1



DANGER

Do not adjust the steering wheel while driving. Loss of control could result. Park the vehicle safely and apply parking brakes before adjusting the steering wheel.

AISLE MIRROR

A central mirror allows the driver to see in the aisle. Adjust mirror manually.

ADJUSTABLE HVAC REGISTERS

The HVAC system has adjustable registers to control air flow around the driver’s area. Three are located on the dashboard; two on the R.H. side and one on the L.H. (refer to Controls & Instruments section). Another one is located close to the door, below the modesty panel wall for step de-icing. The direction and volume of air flow are adjustable manually.

Use the HVAC control panel to set air temperature.

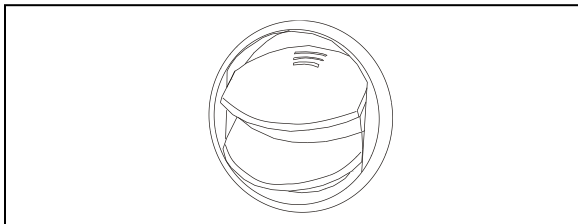

AIR REGISTER

22249

DRIVER’S SEAT – RECARO

The coach is equipped with a Recaro Ergo MS seat.



DANGER

The driver’s seat must be adjusted to allow the driver easy access to the coach controls. Never adjust seat while driving vehicle as this could result in loss of vehicle control.



DANGER

Make sure that seat is adjusted and that safety belt is buckled up before driving vehicle.

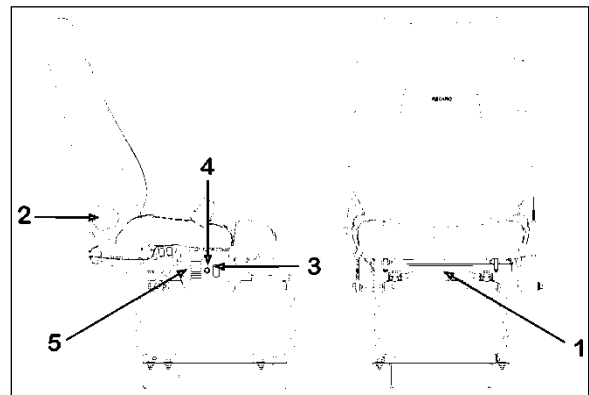

ADJUSTMENT

Seat can be adjusted to the desired driving position by following the instructions listed below.



DRIVER’S SEAT ADJUSTMENT (RECARO)

18333

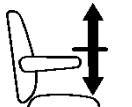
ITEM	DESCRIPTION
1	 <p>Fore and Aft To adjust distance between driver and dashboard, pull handle (1) up and slide the seat forward or backward. Release handle to lock the seat in position.</p>
2	 <p>Backrest Turn hand wheel recline (2) to adjust backrest to the desired angle.</p>
3	 <p>Up and Down Toggle up/down switch (3) to adjust height of the seat.</p>

4  **Fore and Aft Auto Actuator**

To adjust distance between driver and dashboard, push auto actuator (4) and slide the seat forward or backward. Release button to lock the seat in position.

5  **Lumbar Support**

Use the 3-cell lumbar switches (5) to adjust lumbar support.

SAFETY BELTS

The driver's seat is equipped with a 2-point retractable safety belt as required by State and Federal regulations. The safety belt is 70-inch long. To fasten, pull seat belt out of the retractor and insert the latch plate into the buckle until it clicks. No special adjustment is required since the reel device is self-adjusting. If seat belt operation becomes defective, report to maintenance personnel immediately.

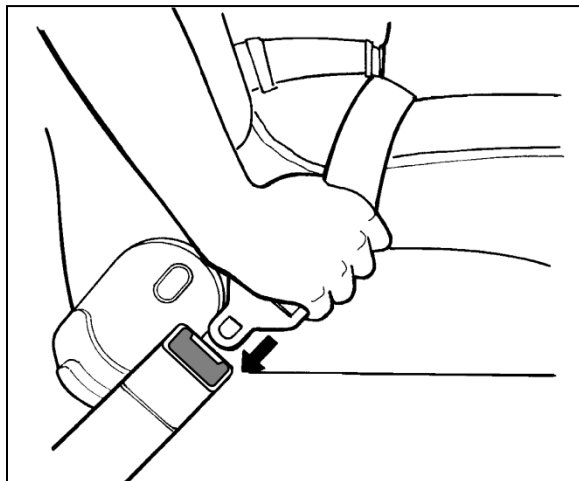

FASTENING SEATBELT

18028

NOTE

The safety belt must be pulled out slowly and continuously, otherwise it will lock the reel before the latch plate reaches the buckle. If this happens, allow the belt to retract completely and repeat the procedure correctly.

 **WARNING**

A snug fit with the lap belt positioned low on the hips is necessary to maximize driver safety. The belt should not be worn twisted. Avoid pinching belt and/or belt hardware in seat mechanism. Do not wear belt over rigid or breakable objects, such as eyeglasses, pens or keys as these may cause injuries.

To unfasten belt, press the red button in center of buckle and allow belt to retract. If the belt does not fully retract, pull it out and check for kinks or twists. Make sure that it remains untwisted as it retracts.

 **WARNING**

Most State and Provincial laws require that safety belts be worn when they are supplied with the seat.

NOTE

The vehicle is equipped with a belt detection system; a warning alarm will be heard if the vehicle is moving above 3 mph (5 km/h) with the safety belt unfastened.

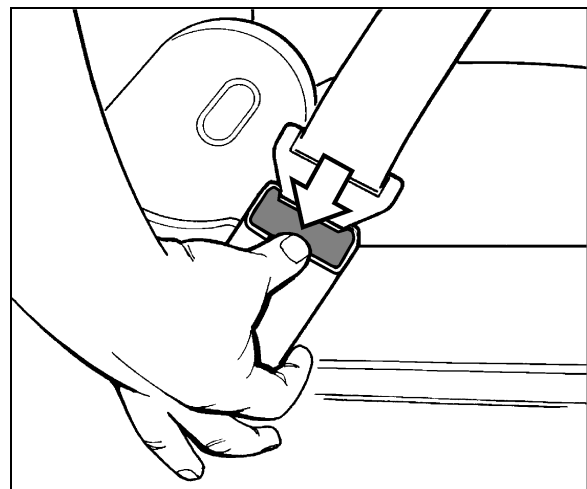

UNFASTENING SEATBELT

18029

 **CAUTION**

Never bleach or dry clean safety belt.

3-4 COACH INTERIOR

PASSENGER SEATS

The seat layout accommodates 57 seated passengers.

It features twenty (20) two-passengers fixed seats, six (6) two-passenger reconfigurable seats and five (5) fixed rear cross single seats.

On window side, the two passenger fixed seats are wall mounted to ease floor cleaning between the seat base and wall.

Passenger seat backrests can be reclined by using the button located on the armrest. Push on the button and adjust backrest to the desired angle. Release button to lock backrest in position. The fixed rear cross seats are non-reclining.

A fold-up armrest is installed on the aisle side of the seat. A fixed armrest is installed on the window side.

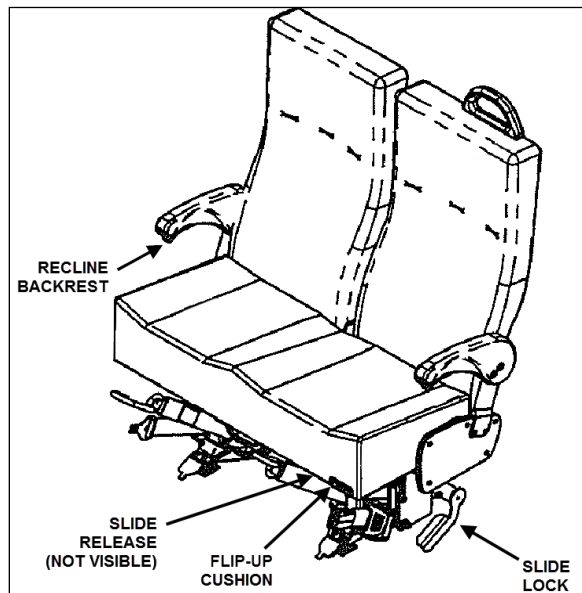

PASSENGER SEAT

18689

SEAT RECONFIGURATION FOR MOBILITY DEVICES

The layout features four (4) sliding, flip-up, and two (2) fixed flip-up, two-passenger seats.

They are placed in the center section for easy reconfiguration to accommodate mobility devices.

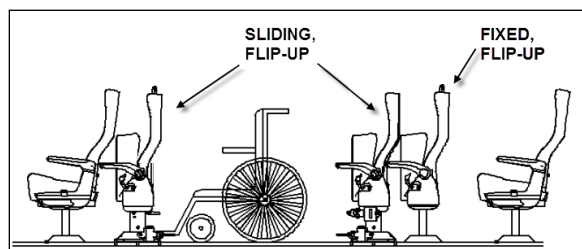

SEAT RECONFIGURATION

18691

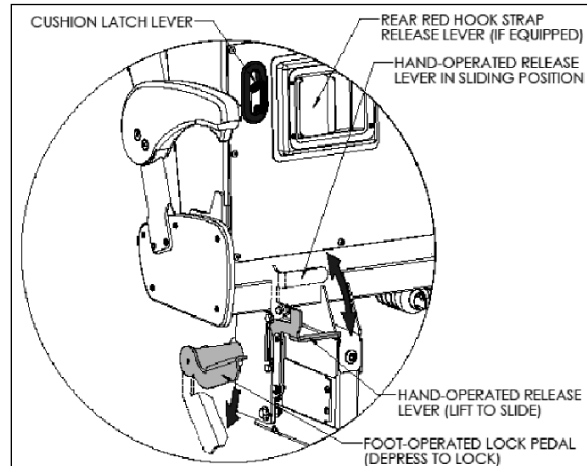

SLIDING SEAT LEVERS

18699

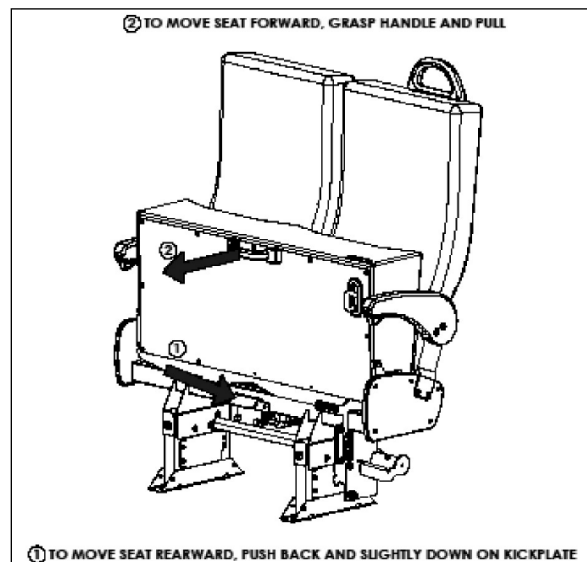

MOVING THE SLIDING SEATS

18690

Refer to the specific detailed instructions on the actual seats for safe and proper operation.

SEATED to STOWED position

- A cushion latch lever is located underneath the aisle cushion to flip the seat cushions up. Pull to release.
- A hand-operated release lever releases the seat for sliding. Fully lift to slide.
- Place the seat to the stowed position using the handle if pulling or kick plate if pushing.
- A foot-operated lock pedal is along the pedestal. Depress pedal until hand-operated lever lowers automatically.
- Rotate aisle-side armrest upward.

STOWED to SEATED position

- Fully lift hand-operated release lever
- Place the seat to the seated position using the handle if pulling or kick plate if pushing.
- Depress foot-operated lock pedal until hand-operated lever lowers automatically.
- Pull cushion latch lever upward and rotate cushion down to the seated position.
- Rotate aisle-side armrest downward.

Passengers boarding with scooters will need scooter belts for proper securement. Four (4) 16" belts are included in the bus for this purpose.

MOBILITY DEVICE SECUREMENT BELT OPERATION

Refer to the information on the actual seats.

WHEELCHAIR OCCUPANT RESTRAINT

Refer to the information on the actual seats.

OVERHEAD CONSOLE

One airplane type overhead console is installed above each row of twin seats to provide a total of 107 ft³ of storage capacity. Such amenities as reading lights, air vents and stop request service are controlled from this panel.

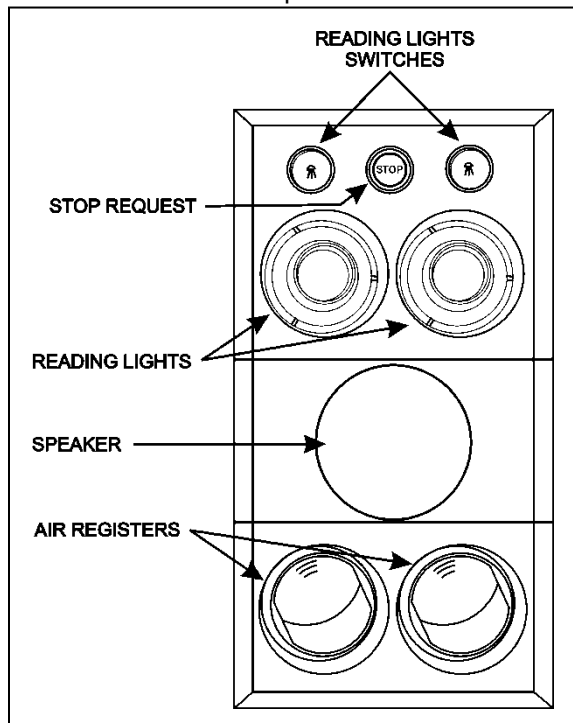

OVERHEAD CONSOLE

23137

ADJUSTABLE AIR REGISTERS

Manually adjustable registers located on the overhead console provide air flow to the passengers. Air flow can be directed, passengers can orient individual registers by rotating the nozzle. To adjust air flow, passengers must open or close the flaps. Activation of the fans is done by depressing a rocker switch on the dashboard. Refer to Controls & Instruments section.

STOP REQUEST

Passengers can request a stop for disembarking by pressing the "STOP" request button on the overhead console. This will illuminate the button and activate a warning sound in the driver area, this will also light-up a warning signal on the dashboard. Press the "STOP" request button a second time to cancel the stop request.

A "STOP" request button is provided for the wheelchair occupant on the window sill of the coach, within easy reach. Pressing this "STOP" request button will sound two gongs to identify the wheelchair occupant.

READING LIGHTS

Reading lights are mounted underneath the overhead storage compartments. Depressing a rocker switch located on the dashboard (refer to Controls & Instruments section) will activate the reading light circuit and allow passenger control of reading lights.

WINDOWS

The coach is equipped with frameless flush-mounted "Galaxsee" windows all around and a split-window windshield for maximum visibility.

PANORAMIC WINDOWS

Panoramic side windows come in single pane glass. Some of these windows are of the fixed type; they are bonded to the structure and cannot be opened. Others can be easily opened to serve as emergency exits.

Fixed Windows

These windows are bonded to the structure and form an integral part of the body of the vehicle, helping reduce vibration and noise. Fixed windows cannot be opened.

Emergency Windows

These windows can be opened from inside the vehicle as emergency exits. A riveted tag on

3-6 COACH INTERIOR

window sills indicates the location of the emergency windows. To open an emergency window, lift the window release bar (sill) and push the window open from the bottom.

To close, lift the release bar and pull the window into position. Push down on release bar to lock the window shut.

For more information on emergency features, refer to “Safety Features and Equipment” section.

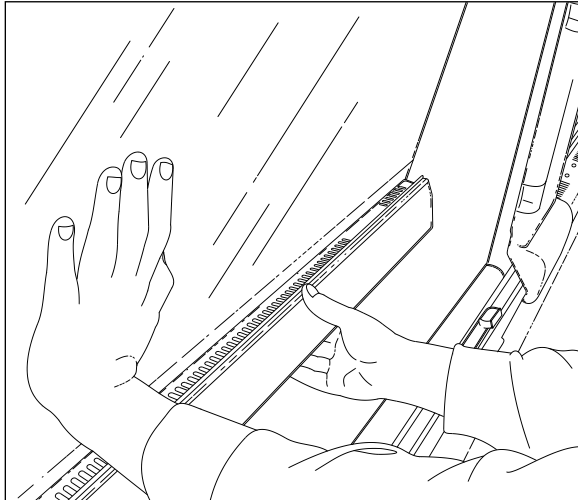

EMERGENCY WINDOW OPENING

18391

DRIVER'S POWER WINDOW

The driver has a power window on the left side of the coach. The windows are controlled by a rocker switch located on the driver's control panel. Refer to “Controls and Instruments” section.

Driver's window shades

This vehicle is provided with a spring release type sun shade on the driver's left side window. To operate, pull down the shade by its hem to the appropriate position and release. It will remain in position. To raise, depress the unlocking lever and guide the shade back up using the other hand.

WINDSHIELD

Two manually-operated shades are installed behind the windshield. To operate, pull down the shade by its hem to the appropriate position and release. It will remain in position. To retract, pull the release cord.

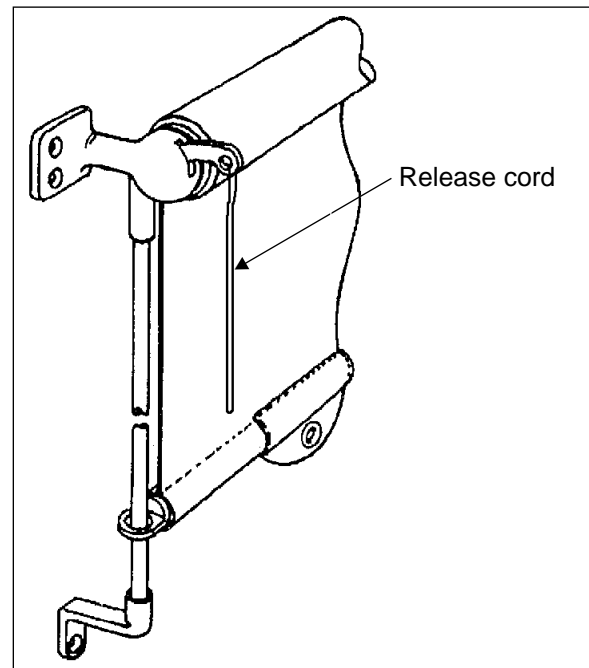

SPRING RELEASE SUNSHADE

23019

VENTILATION HATCH

A ventilation hatch is installed in the ceiling at the rear of the coach and at the front of the coach. To open the hatch, push up with both hands and pull down to close. The ventilation hatch can be completely opened for emergency egress. Refer to “Safety Features and Equipment” section.

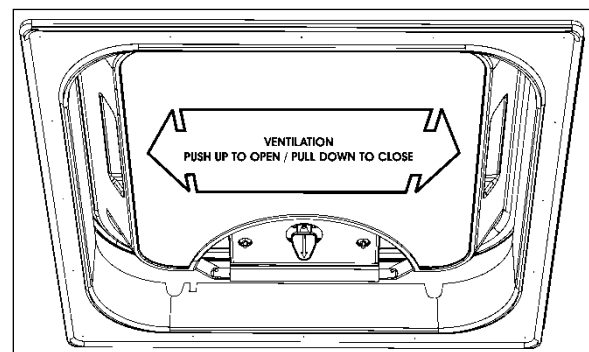

VENTILATION HATCH



WARNING

Be aware of coach overhead clearance when traveling under overpasses with the ventilation hatch(es) open. Check for maximum clearance height.

OVERHEAD COMPARTMENTS

Passenger carry on baggage is stored in overhead compartments on each side of the

coach. A first aid kit and a 5 lbs fire extinguisher are located in the first front curb side overhead storage compartment.

To open the closed overhead storage compartments, push the handle in to release the latch, then let go. A pressurized cylinder opens the door.

NOTE

The overhead storage compartments have a minimum amount of separators installed to facilitate inspection for left behind items.

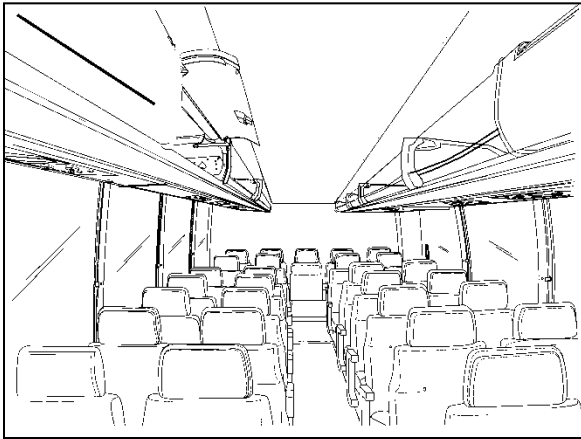
**OVERHEAD STORAGE COMPARTMENTS**

18603

SECTION 4 CONTROLS AND INSTRUMENTS

KEYS	3
ENTRANCE DOOR AND EXTERIOR COMPARTMENT DOORS KEY	3
IGNITION SWITCH	3
LATERAL CONTROL PANEL	5
TRANSMISSION CONTROL PAD (1)	6
CONTROL SWITCHES (2)	6
<i>BACK-UP ALARM CANCEL SWITCH</i>	6
<i>KNEELING</i>	6
<i>POWER WINDOW SWITCH</i>	6
<i>ENTRANCE DOOR INTERLOCK CANCEL SWITCH</i>	6
MIRROR CONTROLS	6
PARKING BRAKES CONTROL VALVE (4)	6
SILENT ALARM SWITCH (6)	7
EMERGENCY/PARKING BRAKES OVERRULE CONTROL VALVE (BRAKE RELEASE)	7
MOBILE VIEW STATUS & TAG SWITCH (8)	7
OBD DIAGNOSTIC TOOL RECEPTACLE	7
AUTOMATIC FIRE DETECTION AND SUPPRESSION SYSTEM (AFSS)	7
DASHBOARD	8
CONTROL SWITCHES	8
L. H. DASHBOARD PANEL	9
R. H. DASHBOARD PANEL	12
DRIVER'S HVAC CONTROL UNIT	14
AIR VENTS	15
ELECTRONIC DESTINATION SIGN	16
INSTRUMENT CLUSTER	19
ANALOG INDICATORS	20
TELLTALE LIGHTS	23
STOP, CHECK AND INFORMATION TELLTALE LIGHTS	25
<i>STOP TELLTALE LIGHT</i>	25
<i>CHECK TELLTALE LIGHT</i>	25
ACKNOWLEDGING MESSAGES	25
DRIVER INFORMATION DISPLAY	25
<i>SELECTING A MENU</i>	26
<i>TO CHANGE SETTINGS</i>	26
PICTOGRAMS DISPLAYED ON THE DRIVER INFORMATION DISPLAY (DID)	27
<i>WARNING PICTOGRAMS, POP-UP MESSAGE PICTOGRAMS, VERIFICATIONS AND INFORMATION</i>	27
<i>STATUS LINE PICTOGRAMS</i>	30
HORN	31
FOOT-OPERATED CONTROLS	31
HEADLIGHT BEAM TOGGLE SWITCH	31
LEFT TURN SIGNAL SWITCH	31
RIGHT TURN SIGNAL SWITCH	31
ELECTRIC HORN	31

4-2 CONTROLS AND INSTRUMENTS

DISTRESS SIGNAL SWITCH	32
BRAKE PEDAL	32
ACCELERATOR PEDAL.....	32
ALLISON AUTOMATIC TRANSMISSION	32
OPERATION	32
PUSHBUTTON SHIFT SELECTOR.....	33
PRIMARY AND SECONDARY SHIFT MODES.....	33
DESCRIPTION OF AVAILABLE RANGES.....	33
<i>R (REVERSE)</i>	33
<i>N (NEUTRAL)</i>	33
<i>D (DRIVE)</i>	34

KEYS

ENTRANCE DOOR AND EXTERIOR COMPARTMENT DOORS KEY

Use this key to lock or unlock the entrance door, the baggage compartment doors, the electrical and service compartment doors, WCL door and inverter access hatch.

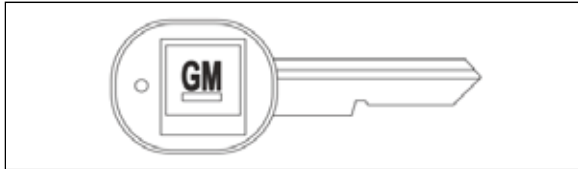

IGNITION SWITCH

Coaches are equipped with an ignition lever instead of an ignition key. Use the ignition lever to activate the electrical circuit by turning it to the ON position.

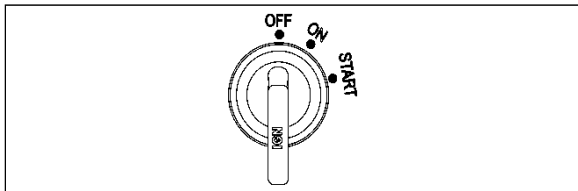

IGNITION SWITCH POSITIONS

06354

For further details, refer to STARTING AND STOPPING PROCEDURES section in this manual.

4-4 CONTROLS AND INSTRUMENTS

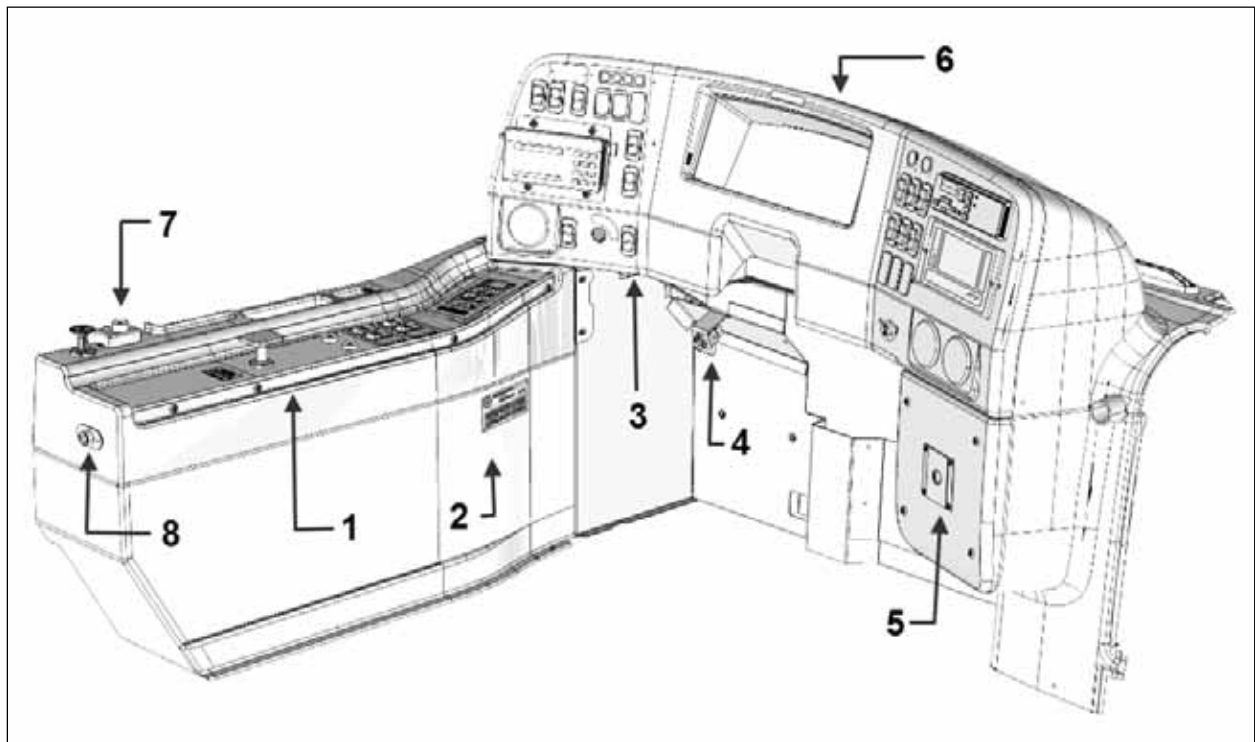

DRIVER'S SECTION

18671_1

1. Lateral control panel
2. DOT certification plate
3. Diagnostic tool receptacle (OBD)
4. Foot operated steering wheel adjustment unlock air valve
5. BCIS Farebox connection switch
6. Dashboard
7. Mobile view panic button
8. Silent Alarm Switch

LATERAL CONTROL PANEL

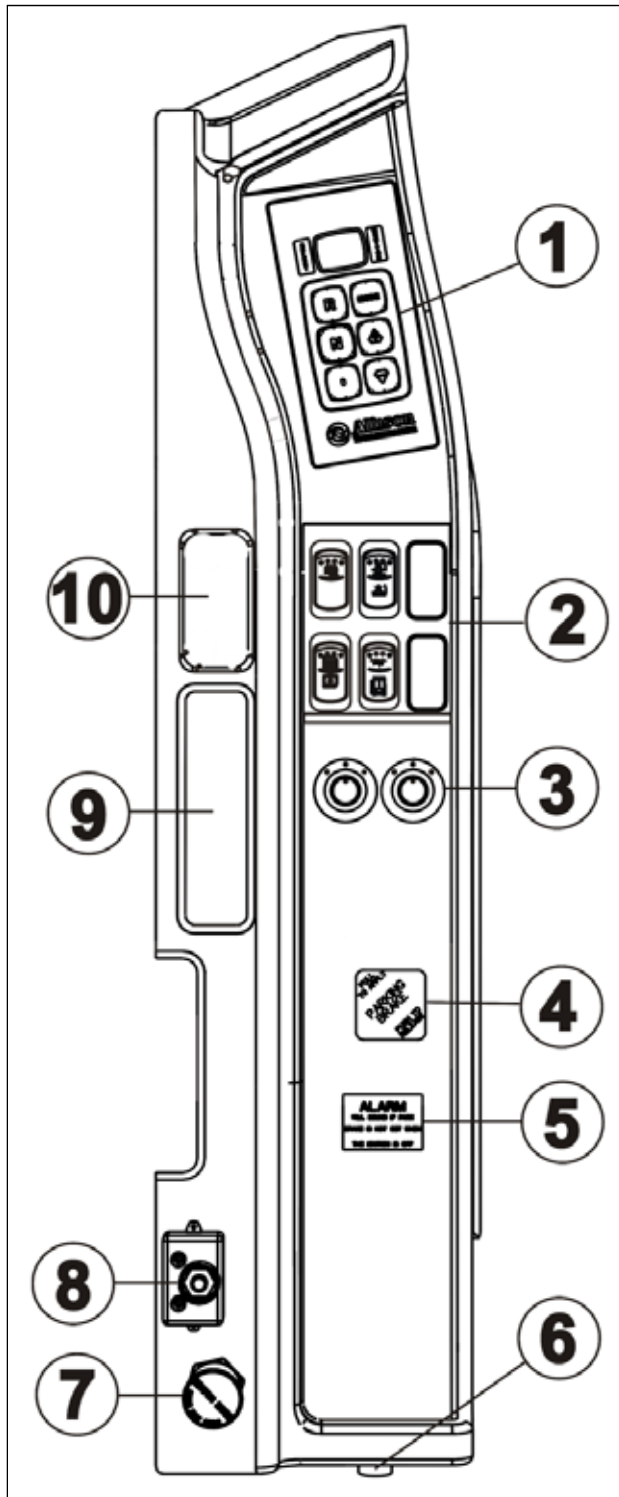

1. Transmission control pad
2. Control switches
3. Mirrors controls
4. Parking brakes control valve
5. Parking brake alarm warning decal
6. Silent Alarm Switch
7. Emergency Parking Brakes Override
8. Mobile View Status & Tag switch
9. Utility Compartment
10. Utility Compartment

LATERAL CONTROL PANEL

06704_2

TRANSMISSION CONTROL PAD (1)

The Allison transmission control pad is located on the lateral control panel. Refer to "Automatic Transmission" in this section for operating instructions and more information.

CONTROL SWITCHES (2)

Back-Up Alarm Cancel Switch

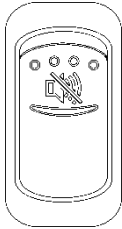

06338

Use this rocker switch to cancel the back-up alarm.

NOTE: Normal operation resumes after leaving reverse gear.

Kneeling

Momentarily press the rocker switch downwards to lower the front end of the coach. Momentarily press the rocker switch upwards to raise the coach to the normal driving height. Refer to OTHER FEATURES section for more information.

06250

NOTE

This coach is equipped with an interlock system which automatically applies the parking brake when the kneeling system is activated.

Power Window Switch

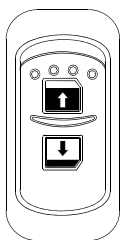

06338

Use this rocker switch to open or close the driver's power window.



CAUTION

Close power window when parked or leaving the coach unattended.

Entrance Door Interlock Cancel Switch

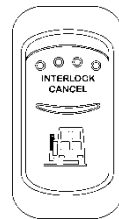

06266

This switch enables moving the vehicle while the entrance door is open for maintenance purposes or in case of emergency.



DANGER

Unless absolutely necessary, always apply parking brakes before canceling entrance door interlock

MIRROR CONTROLS

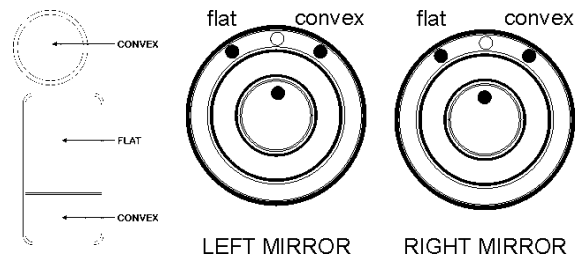

MIRROR CONTROLS

06374

Turn left pointer knob counterclockwise for flat mirror adjustments and to the right for convex mirror adjustments, then use the joystick control to adjust the selected mirror's viewing angle. Adjust the right outside mirror similarly but by using the right side control.

MIRROR CONTROLS

06374_1

PARKING BRAKES CONTROL VALVE (4)

Spring-loaded parking brakes are applied by pulling up the control valve knob. Push down to release brakes. Refer to SAFETY FEATURES AND EQUIPMENT section.



PARKING BRAKE CONTROL VALVE

12129_3

SILENT ALARM SWITCH (6)

Use this switch to signal an emergency and ask for immediate assistance. A message will be sent via the Motorola system to the monitoring station.

EMERGENCY/PARKING BRAKES OVERRULE CONTROL VALVE (BRAKE RELEASE) (7)

During normal operation, if air pressure in any brake circuit drops below 60 psi, spring-loaded emergency brake will be immediately applied at full capacity to the drive axle wheels to stop the vehicle. Search and correct the cause of this pressure drop before driving vehicle.

The coach is equipped with the parking brake overrule system, which allows the vehicle to be driven to the nearest safe parking area even if air pressure is below 60 psi. To actuate the parking brakes overrule system, push and hold down the control valve located on the lateral control panel.

MOBILE VIEW STATUS & TAG SWITCH (8)

This switch combines real-time recorder status indicators and the “Tag Event” input in the Mobile View device.

The Tag Event provides a discrete and silent way to record and log important events trough the Mobile View device, these events can be easily reviewed later-on.

The Tag Event is activated by depressing the switch built-in push button.

The recorder video status is provided by red and green LED indicators on the switch.

LED Status indicators:

- Green: Normal Operation
- Red: Check System
- None: Check System

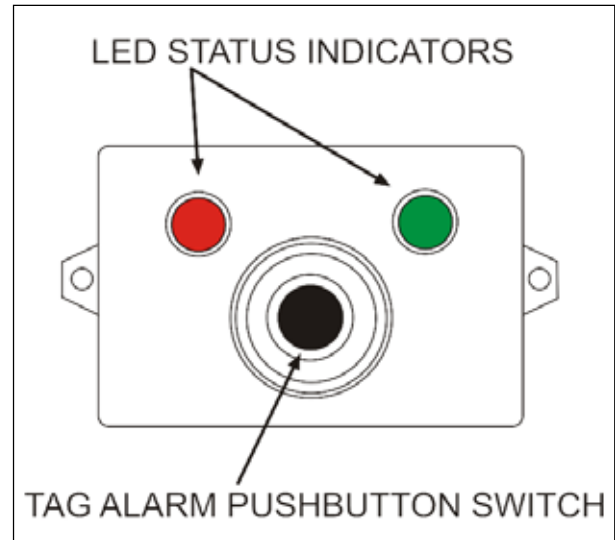

MOBILE VIEW STATUS/TAG SWITCH

06776_2

OBD DIAGNOSTIC TOOL RECEPTACLE

To ease troubleshooting, a diagnostic tool (OBD II) can be connected through this receptacle.

AUTOMATIC FIRE DETECTION AND SUPPRESSION SYSTEM (AFSS)

Refer to SAFETY FEATURES AND EQUIPMENT for more information on *Kidde Dual Spectrum* Automatic Fire detection and Suppression System (AFSS).

4-8 CONTROLS AND INSTRUMENTS

DASHBOARD

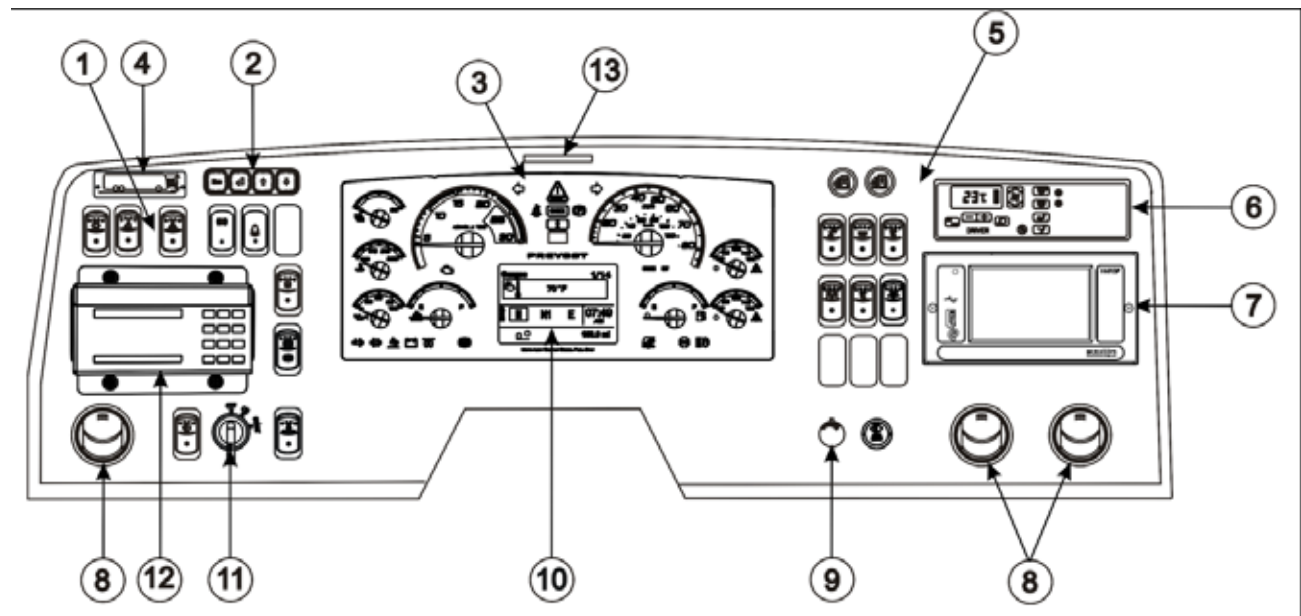

DASHBOARD

06761_1

1. L. H. Dashboard Panel
2. Driver Information Display (DID) Keyboard
3. Instrument Cluster
4. Vehicle Clearance Information
5. R. H. Dashboard Panel
6. HVAC Control Unit
7. Electronic Destination Sign Central Control Unit
8. Air Vents
9. Brightness Control
10. DID (Driver Information Display)
11. Ignition Switch (Lever)
12. Radio control
13. Minimum Operating Air Pressure Warning Tag

CONTROL SWITCHES

Many switches are equipped with a LED indicator to inform the driver at a glance which features are active. Switches are described in the order they appear, from left to right, top to bottom.

L. H. DASHBOARD PANEL

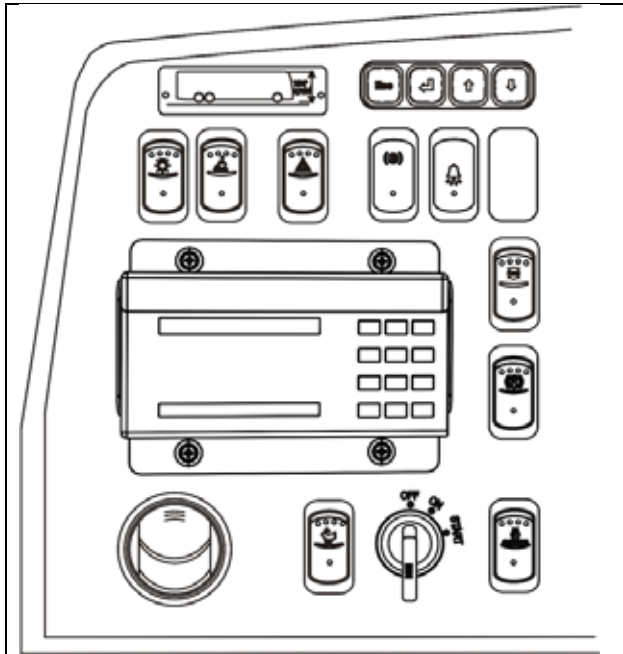

The L.H. dashboard panel includes controls for the operation of the coach; it also includes the ignition switch, radio control and an adjustable air vent.

L. H. DASHBOARD PANEL

06762_1

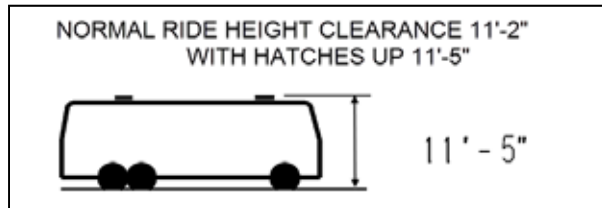

Vehicle height information with hatches up and down.



WARNING

Vehicle clearance is higher when the ventilation hatch is open or if additional equipment is installed on the roof.

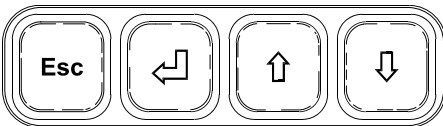

06399

Driver Information Display (DID)

This standard feature gathers stores and displays important information about the vehicle's operation on a display screen on the lower center portion of the cluster. Refer to "Driver Information Display" in OTHER FEATURES section for a description of how to set up and operate the Driver Information Display.

4-10 CONTROLS AND INSTRUMENTS

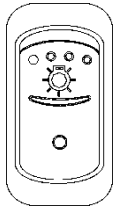

06254

Headlights and Exterior Lighting

Off position – Daytime running lights only

Press this rocker switch to turn on the following lights:

First position – Front parking lights, clearance lights, tail lights, license plate lights and marker lights.

Second position - Push down fully to turn *ON* the headlights, the controls and instrument lights and all lights from first position.

NOTE

Daytime running lights will be automatically cancelled when the exterior lighting switch is fully depressed (second position).

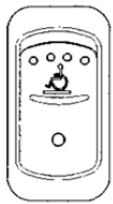

06268

Wheelchair Lift Power Switch

Activate the optional wheelchair lift by pressing down on the rocker switch. Refer to OTHER FEATURES section and to wheelchair lift system's Operator's Manual for operating instructions.

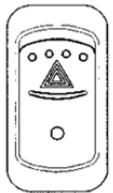

06256

Hazard Warning Flashers

Press the rocker switch to make all turn signal lights flash at once. The dashboard telltale lights will flash when the hazard warning flashers are *ON*.



CAUTION

Do not use the hazard flashers for an extended period of time unless necessary because the electrical circuits are activated when the hazard switch is depressed.



06774

Stop Light Indicator

This indicator light will illuminate simultaneously with the vehicle rear brake lights.



06771

Stop Request Warning Light

This warning light will illuminate and an audible warning sound will be heard when one of passenger pushes the stop request button on the overhead console to request a stop for disembarking.

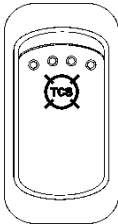

06758

Traction Control System Mud/Snow Mode

On certain road conditions, it may be useful to retard the intervention of the traction control system TCS during vehicle acceleration. The Mud/Snow function allows greater engine power and more wheel spin during TCS operation. This function may be helpful to set the vehicle in motion on iced road for example.

Press the Mud/Snow switch to turn on this function. The TCS/ESC telltale blinks slowly when the TCS Mud/Snow mode is active. Always remember to turn the Mud/Snow feature off when driving on a firm road surface.

A new ignition cycle or a second pressing of the Mud/Snow switch will turn this function off.



Transmission Retarder

Press this rocker switch to activate the transmission retarder. Refer also to "Transmission Retarder" in OTHER FEATURES section.

NOTE

Deactivating the transmission retarder will turn on the indicator light located at the front of the coach.

Secondary use - Regeneration Inhibit Override

Flip this rocker switch 4 times (4 transitions from OFF to ON) within 2 seconds to override the regeneration inhibit function through geofencing and allow parked regeneration.

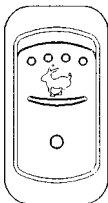

Fast Idle

For extended idling periods, run the engine at fast idle. Press down the rocker switch to engage fast idle. This increases the engine speed to approximately 1,000 rpm. Return to normal idle before driving or when stopping engine.



CAUTION

Reduce the engine to normal idle before shutting the engine off.

NOTE

If the parking brake is released and/or the transmission is engaged with the engine running at fast idle, the engine will return to normal idle and remain there as long as the parking brake is not applied and/or transmission is not placed in neutral (N).

The engine will return to fast idle once the parking brake is applied or neutral (N) selected.

4-12 CONTROLS AND INSTRUMENTS

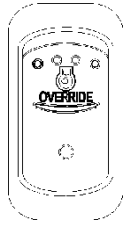

06265

Engine Stop Override (with Automatic Fire Detection and Suppression System)

Press the Engine Stop Override switch on the dashboard or the Delay Engine Stop switch on the AFSS protection panel to delay the engine shutdown and extinguisher discharge by an additional 15 seconds.



CAUTION

Use this function if you are not prepared to bring the vehicle to a safe stop (i.e. on a railroad track, in intersection).

R. H. DASHBOARD PANEL

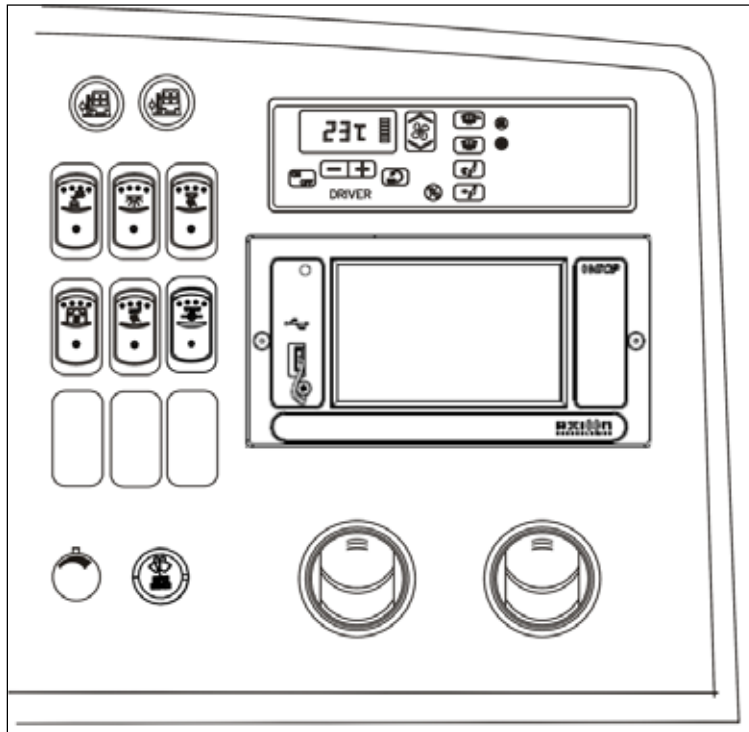

R. H. DASHBOARD PANEL

06724_1

The HVAC control module, electronic destination sign control unit as well as the cluster dimmer switch, interior lighting control switches, entrance door operating buttons, miscellaneous door operating buttons, miscellaneous control switches and air vents are located on the R.H. dashboard panel.



CLOSE



OPEN

Entrance Door Operating Buttons

Press the red (R.H. button) button to open the door. The door will open to full open position.

06464 Press and hold the green (L.H. button) button to close the door.



WARNING

The door mechanism has no automatic safety protection to avoid injury to bystanders. The driver is responsible for the safe operation of the door.

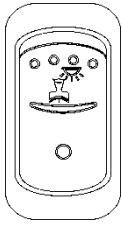

06244

Driver's Area Lighting

Press the rocker switch to illuminate the ceiling lights in the driver's area as needed.



06239

Interior Lighting

Press this rocker switch to the first position to illuminate the aisle fluorescent lighting. Press down the second position to illuminate the in-station fluorescent lights.



06240

Reading Lights

This switch powers the reading light circuit enabling passengers to operate their personal reading lights. Refer to COACH INTERIOR section.

	<p>CAUTION</p>
<p>To avoid running down the batteries when the engine is OFF, turn off the lights or connect the optional battery charger to a 110 - 120 volt ac power supply.</p>	



06245

Passenger Overhead Air Registers

Press the switch to start the air register fans. The fans are connected to a sensor and their speed will increase automatically if the outside temperature reach 60 deg. F or if the inside temperature rises above the set point.



06240_1

First Row Reading Lights Cancel Switch

This switch is used to cancels the first row reading lights. This function is useful to minimize glare in the windshield during night driving.

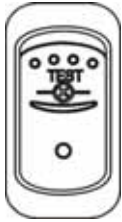

06262

LED Light Test

Press this switch while ignition is in the *ON* position to illuminate the LED lights. Perform this test to verify all of the LED lights in the interior of the bus. LED lights will extinguish automatically after about three seconds.



06249

Brightness Control

Adjusts the brightness of the dashboard instruments and switches.



06249

Wiper/Washer Control

Push the control to activate the windshield washer. Turn the button to activate the wipers. The first position activates the wipers intermittently. The second position is the slow speed and the third position is for high speed wiping.

DRIVER'S HVAC CONTROL UNIT

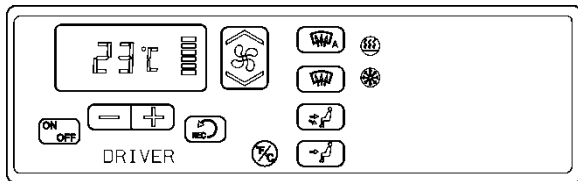

22333

The vehicle is divided into two areas:

- 1 - Driver's area (driver's HVAC unit)
- 2 - Passengers' area (central HVAC unit)

Fresh air is fed in each area and has a separate return air and discharge air duct.

The driver's HVAC control unit is used to control heating, ventilation, air conditioning and defroster in the driver's area. The passenger's area HVAC unit (central unit) has a preset temperature of 68°F (20°) and is fully automatic. It turns on at starting of the engine. No inputs are required from the driver to control the passenger's HVAC unit.

NOTE

It is recommended to run engine at fast idle to operate the air conditioning system when vehicle is stationary.

This will improve A/C compressor performance and provide adequate electrical power to the multiple A/C system fans.

When the system is running, keep roof ventilation hatch and door closed to prevent cooling loss.

To prevent battery run-down, the central HVAC unit will not operate if the charging system is not working properly.

When the HVAC system is in operation, park at least 4 feet from other vehicles or buildings to allow sufficient air flow through the condenser core.

The driver's HVAC unit may be turned ON by pressing the ON/OFF button.

Also, the driver's HVAC unit turns on automatically at starting of the engine and uses the settings kept in memory before turning off of the system.

The HVAC control unit performs a self-test every time it is turned on. Codes are shown on displays or flashed on control buttons. Refer to the Maintenance Manual for more information on the diagnostic codes.

In cold weather, the A/C compressor starts automatically when the two following conditions are satisfied:

1. The outside temperature is above 32°F.
2. The increasing passenger's area temperature has reached 7°F under the set point. At this moment, enough heat is available from the engine to warm up the area while the air conditioning will remove moisture in air and prevent fogging up of the windows.

NOTE

Upon starting, if the outside temperature is above 32°F (0°C) and then drops below 32°F (0°C), the compressor will keep running up to a temperature of 15°F (-9°C) to prevent fogging up of the windows.

Heating Mode Indicator



This red LED illuminates when system is heating.

22131

Cooling Mode Indicator



This green LED illuminates when the system is cooling (when the compressor clutch is engaged).

22134

Fan Speed

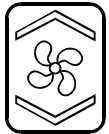

22135

The driver's fan has six speeds. Increase speed by pressing on the upper portion of the button, decrease by pressing on the lower portion.

Recirculate



22138

Closes or opens the driver's and passenger's unit fresh air damper.

A red LED in the top right corner of the button illuminates when air is recirculated.

This feature is automatically cancelled when defogging is activated.

Driver's area temperature setting

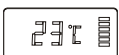

22303

The temperature displayed on the driver's HVAC control unit is the temperature set point.

To increase the temperature set point, press on the "+" sign, to decrease the temperature set point, press on the "-" sign. Temperature range is between 60°F and 82°F (16°C to 28°C). Setting for a temperature set point above 82°F (28°C) will keep the coolant valve open and "FUL" will be displayed.



22132

In case of interior temperature sender unit failure, the coolant valve will remain open and three lines "---" will be displayed.



WARNING

Warm temperatures may cause drowsiness and affect alertness while driving. Keep the temperature comfortable but not too high.

Windshield Defogger

Upon pressing this button, the dashboard damper sends air only to the lower windshield. The fan is turned on to maximum speed, the fresh air damper opens completely (REC off) and the driver set point is increased to 4°F (2°C) over the passenger's section set point.



22305

The dashboard damper sends air only to the lower windshield when activated. The footwell damper is closed also but the fan speed can be reduced or increased.



22139

NOTE

Upon starting of the vehicle, when the ambient temperature is very cold in and out of the vehicle, the HVAC control unit will permit a temperature overshoot up to 3° over the passenger's area set point to help warming up of the area because some parts of the vehicle like the seats and the overhead compartments accumulate cold.

Panel and Footwell



22137

The dashboard damper sends air to the panel vents and footwell.

Panel



22136

Air is sent to panel registers. The footwell damper is closed.

Temperature Degree Selector



22133

Toggles temperature units between Fahrenheit and Celsius. The HVAC control unit must be on. Also toggles the outside temperature units displayed on the telltale panel.

AIR VENTS



Three adjustable driver air vents in the dashboard and one near the door feed air to the driver's compartment. Use the HVAC control panel to set air temperature and fan speed.

ELECTRONIC DESTINATION SIGN

The electronic Destination Sign System (DSS) is automatically activated when the ignition switch is turned to the ON position.

The destination sign database is programmed with a computer via “Data Transit Software” and then transferred in the central control unit.

Each message is assigned a code that the operator can enter on the OSCP (Operator’s System Control Panel) for the related info to be displayed.



DESTINATION SIGN CENTRAL CONTROL UNIT ICON

To enter a destination:

- Consult your Transit Authority code list.
- Press the destination sign icon on the main screen to access the destination sign OSCP menu.
- Press the <Dest> button.

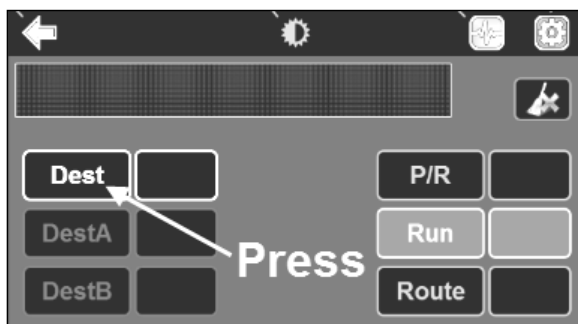

DESTINATION SIGN OSCP MENU

- Using the alphanumeric keyboard enter *the code* for the destination to be displayed (1).
- Press <ENTER> to validate your choice (2).

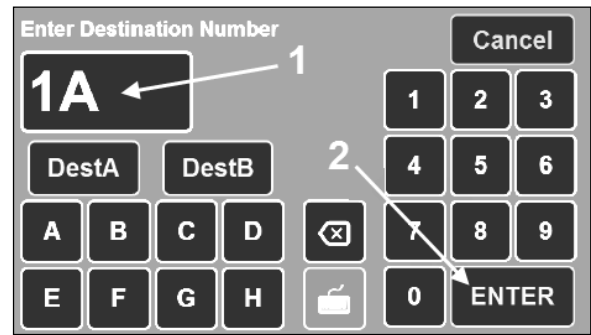

DESTINATION SIGN ALPHANUMERIC KEYBOARD

When the destination code is entered, OSCP displays the following information:

- Destination number displays in the Dest field (1).
- Front destination content (message) is displayed in the text field (2).

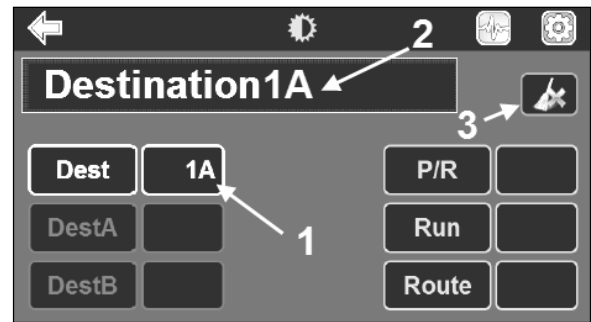

OSCP MESSAGE AND NUMBER

Use the ERASE key at the top right of the screen to delete or cancel the last entry on the control unit (3).

NOTE

<DestA> and <DestB> buttons can be used to store two destination numbers.

When a destination number is entered in the Dest field, press <DestA> or <DestB> to store your choice, press again to recall the associated destination number.

To enter a route number:

- Consult your Transit Authority code list.
- Press <Route>.

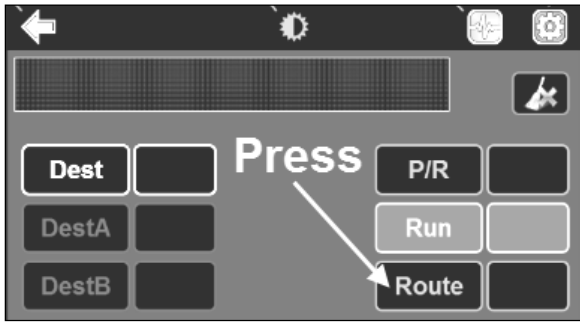

DESTINATION SIGN OSCP MENU

- Using the alphanumeric keyboard enter the route number for the destination to be displayed (1).
- Press <ENTER> to validate your choice (2).

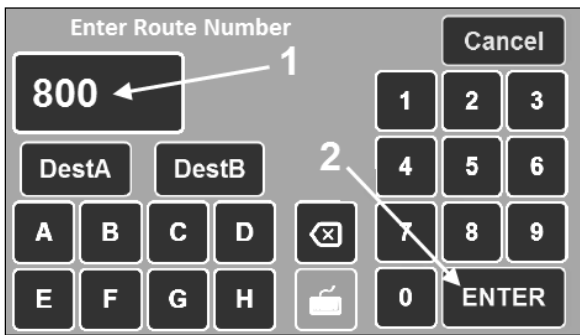

DESTINATION SIGN ALPHANUMERIC KEYBOARD

When the route number is entered, OSCP displays the following information:

- Destination number displays in the Dest field (1).
- Route number displays in the Route field (2).
- Route number and front destination content (message) is displayed in the text field (3).

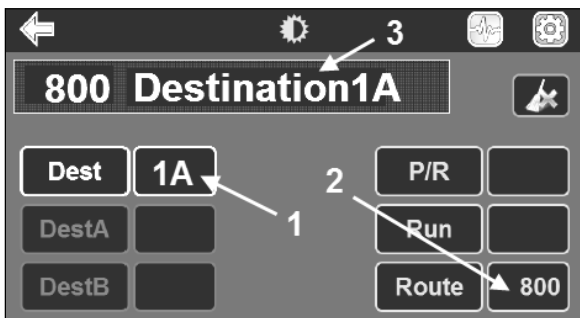

DESTINATION ROUTE, TEXT AND NUMBER

To enter a run number:

- Press <Run>.

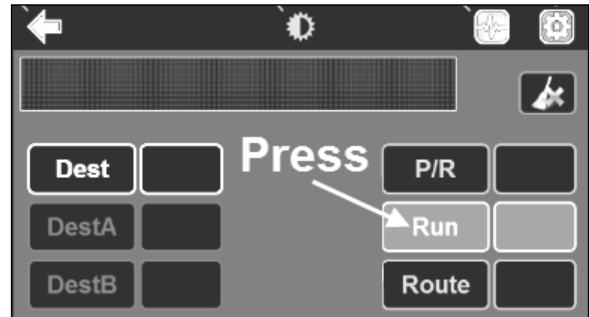

DESTINATION SIGN OSCP MENU

- Using the alphanumeric keyboard enter the run number to be displayed (1).
- Press <ENTER> to validate your choice (2).

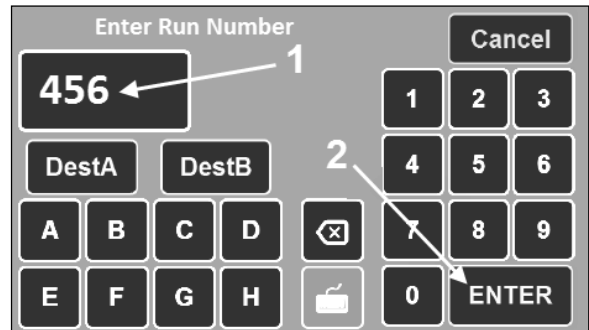

RUN NUMBER ON KEYBOARD



DESTINATION, ROUTE AND RUN NUMBERS

Setting screen brightness:

- Press the intensity icon at the top of the main menu screen.

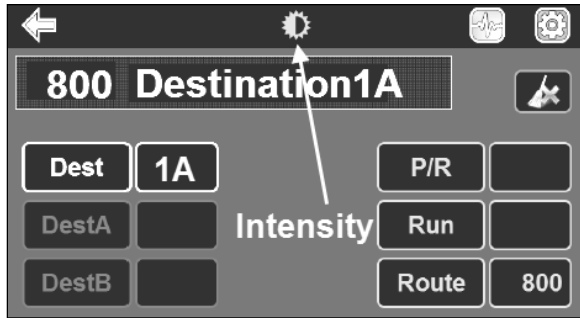

INTENSITY ICON

- Use the two arrows to set the desired brightness.
- Press <Exit> to confirm brightness level.

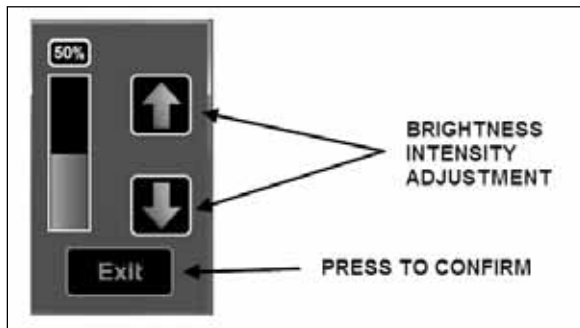

BRIGHTNESS ADJUSTMENT

Distress Signal (Emergency Mode)

The electronic destination sign is equipped with a distress signal function activated using a foot switch located on the floor, just in front of the driver seat.

When activated, a warning message will be displayed on all exterior destination signs to prompt passer-by to call for help on behalf of the operator and allow emergency services to easily identify the vehicle needing assistance.

To deactivate the message, press the footswitch a second time, press the Dest A button followed by the Enter button.

NOTE

Several other functions are available through the touchscreen menu. Refer to Destination Sign User manuals included with the vehicle documentation for additional information about programming, downloading, troubleshooting and others menu options.

INSTRUMENT CLUSTER

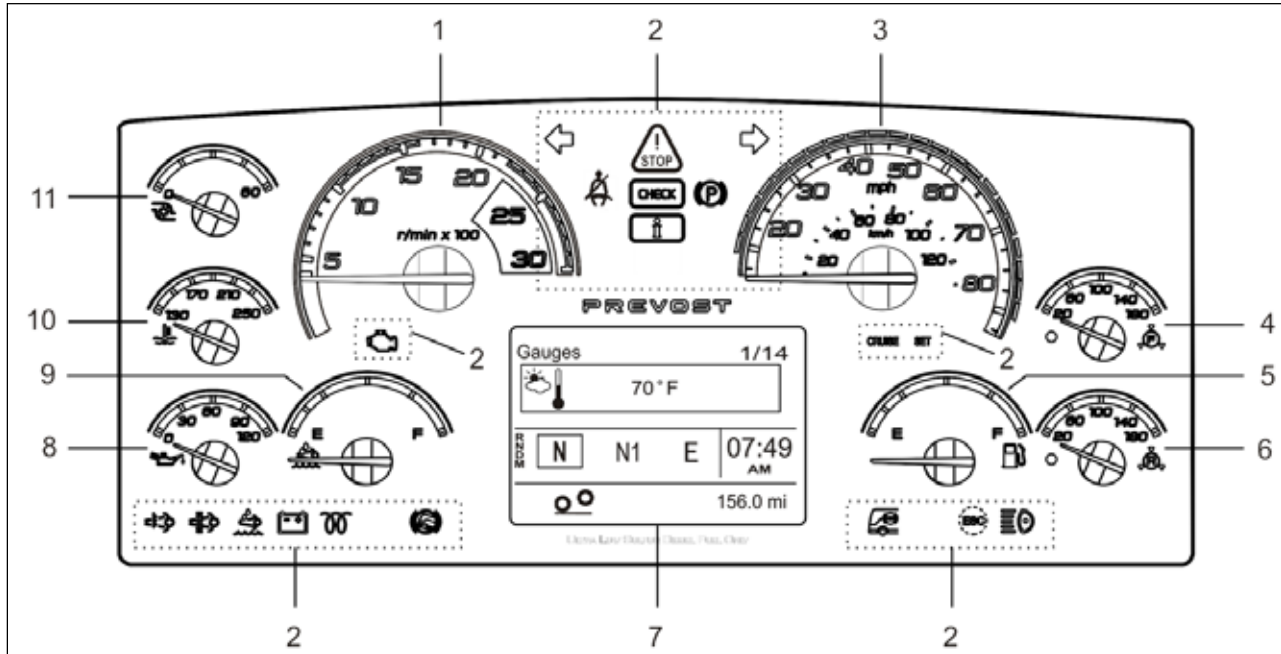

06727_e

- 1. Tachometer
- 2. Telltale lights
- 3. Speedometer
- 4. Front brake air pressure (secondary)
- 5. Fuel level
- 6. Rear brake air pressure (primary)
- 7. Driver Information Display (DID)
- 8. Oil pressure indicator
- 9. DEF level (Diesel Exhaust Fluid) indicator
- 10. Engine coolant temperature
- 11. Turbo boost pressure

The instrument cluster includes the analog instruments. It also presents two devices to communicate information to the driver, the telltale lights and the Driver Information Display (DID).

Indications and warnings are presented according to three levels of attention required:

1. The Telltale Lights

The highest level of attention. The telltale lights are temporary and exceptional; they present information critical to safety or vehicle integrity.

2. The Pop-Up Messages

The second level of attention. The pop-up messages appear in the Driver Information Display DID without the driver's intervention and

acknowledgement. Pop-up messages present supplemental information to the driver.

3. The Status Line

The lowest level of attention. The status line monitors certain systems and gives feedback to the driver concerning current actions and functions.

ANALOG INDICATORS

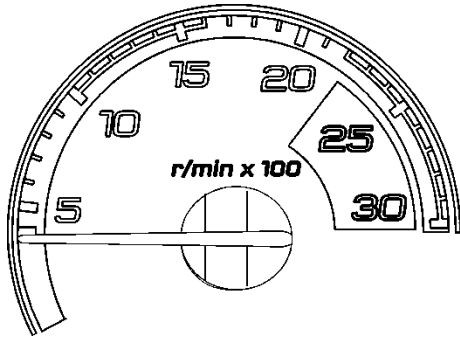

Tachometer (rpm x 100)

Indicates the operating speed of the engine in hundreds of revolutions per minute. The tachometer serves as a guide for gear shifting and helps to prevent engine over-speeding when driving downhill with the engine brake operating. Use the green field for normal driving (1000 to 1600 rpm).

06728



CAUTION

Never allow the engine to go into the red field. This could lead to severe engine damage.



Speedometer (mph, km/h)

06729_1

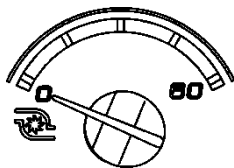

06730

Turbo boost pressure (psi)

Indicates the turbo boost pressure in psi. This pressure should be the same at a given engine temperature, speed, and load. An unusual reading could indicate an engine failure.

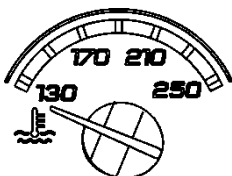

06731

Engine coolant temperature (°F)

Indicates the operating temperature of the engine coolant in °f. The normal reading should be between 170°f and 222°f (80°c to 106°c).

The temperature limit is dependent on the electronic program for the engine model. When coolant temperature is excessive, the stop telltale light turns on, an audible alarm sounds and a pop-up message appears on the DID. The engine protection system will automatically derate and stop the engine in 30 seconds. Stop at the first safe place where the problem can be checked.

If the temperature remains below or exceeds the normal temperature range, the cooling system should be checked for problems.



Stop telltale light

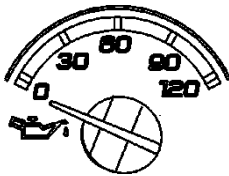

06732

Engine Oil Pressure (Psi)

Indicates the engine oil pressure in psi. When the oil pressure is too low, the stop telltale light turns on, an audible alarm sounds and a message appears on the DID. The engine protection system will automatically derate and stop the engine in 30 seconds. Bring the vehicle to a safe stop where the problem can be checked.



STOP telltale light



OIL PRESSURE pictogram

	WARNING
<p>Failure to take necessary action when the stop telltale light is on can ultimately result in automatic engine derate and shutdown.</p>	

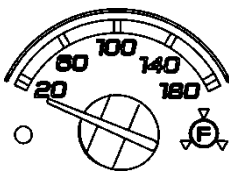

06737

Front Brake Air Pressure (Psi) – Secondary System

Indicates the front brake air system pressure in psi. The normal operating pressure is from 122 to 140 psi.

A low air pressure indicator LED illuminates when the front air system pressure drops below 75 psi. If the air pressure drops further, the STOP telltale light will turn on, an audible alarm will sound and a message will appear on the DID.



STOP telltale light

	WARNING
<p>Do not drive the coach when the brake air pressure is low.</p>	

NOTE
<p>Do not refer to dashboard instruments during adjustment or repair procedures. Use only calibrated gauges.</p>

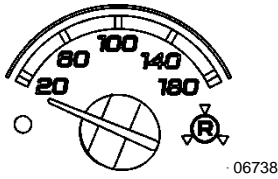

Rear Brake Air Pressure (Psi) – Primary System

Indicates the rear brake air system pressure in psi. The normal operating pressure is from 122 to 140 psi.

A low air pressure indicator LED illuminates when the rear air system pressure drops below 75 psi. If the air pressure drops further, the STOP telltale light will turn on, an audible alarm will sound and a message will appear in the DID.



STOP telltale light

	WARNING
Do not drive the coach when the brake air pressure is low.	

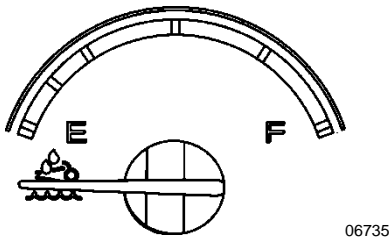

DEF level

Indicates the amount of DEF (diesel exhaust fluid) remaining in the DEF tank. The DEF tank is considered as being full when it contains 16 gallons (60 liters) of DEF. DEF consumption will be approximately 2% of the diesel fuel consumed.

	CAUTION
DEF will begin to crystallize and freeze at 12°f (-11°c). DEF expands by approximately 7% when frozen. In order to permit DEF expansion without causing damages to the DEF tank, do not fill the DEF tank with more than 16 gallons (60 liters).	

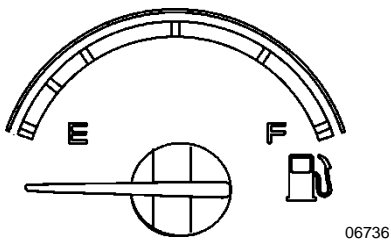







Fuel Level









Indicates the amount of fuel remaining in the fuel tank. At the beginning of the red area, there is approximately 48 gallons (182 liters) left in the tank.



NOTE
<i>A pop-up message will appear in the DID informing that there is only 24 gallons (92 liters) left in the fuel tank.</i>

TELLTALE LIGHTS

The telltale lights illuminate during 5 seconds at the start of every ignition cycle as a light bulb check.

	<p>Stop</p> <p>Indicates that a serious problem has been detected. Immediately park the coach in a safe place and stop the engine. This telltale light may be accompanied with a message in the DID and a diagnostic troubleshooting code will be stored to ease identification of the problem. WARNING: Failure to take necessary action when the STOP telltale light is on can ultimately result in automatic engine derate and shutdown.</p>		
	<p>Check</p> <p>Indicates that a problem has been detected and must be checked at the next stop. This telltale light may be accompanied with a message in the DID and a diagnostic troubleshooting code will be stored to ease identification of the problem.</p>		
	<p>Information</p> <p>This information telltale is not activated in this vehicle but will be visible during a few seconds when the vehicle ignition key is turned ON.</p>		
	<p>Turn Signal Indicators</p> <p>Flashes when the right or left turn signals are activated. Signal right and left turns by operating the foot control switches. See "Foot Operated Controls" in this section.</p> <table border="1" data-bbox="375 1062 1414 1178"> <tr> <td data-bbox="375 1062 1414 1104"> <p><i>NOTE</i></p> </td> </tr> <tr> <td data-bbox="375 1104 1414 1178"> <p><i>The turn signals are automatically activated when the vehicle is backing up or when the Wheel Chair Lift is in function.</i></p> </td> </tr> </table>	<p><i>NOTE</i></p>	<p><i>The turn signals are automatically activated when the vehicle is backing up or when the Wheel Chair Lift is in function.</i></p>
<p><i>NOTE</i></p>			
<p><i>The turn signals are automatically activated when the vehicle is backing up or when the Wheel Chair Lift is in function.</i></p>			
	<p>Safety belt Warning</p> <p>This telltale will notify the driver that the safety belt is not buckled up. If the vehicle speed reaches 3mph, the telltale will start to flash and an audible alarm will be heard.</p>		
	<p>Parking Brake Or Emergency Brake Applied</p> <p>Illuminates when the emergency/parking brake is applied. The control valve is located on the L.H. control panel. This telltale will also flash and an audible alert will be heard if ignition is set to off and the parking brake is not engaged or if no brakes (service or parking) are applied while the vehicle is in neutral below 3 mph (5 km/h).</p>		
	<p>Aftertreatment System Malfunction (Malfunction Indicator Lamp)</p> <p>Indicates a failure of an emission control device. May illuminate at the same time as the CHECK amber warning light. The lamp will go out after 3 completed <i>ignition on-ride-ignition off</i> cycles. Vehicle can be driven to end of shift. Call for service.</p>		

	<p>High Exhaust System Temperature (HEST)</p> <p>Illuminates to notify the driver that the DPF is in active regenerative mode and that exhaust gas temperature at the exhaust system diffuser are potentially hazardous.</p> <div style="border: 1px solid black; padding: 5px;">  <p>WARNING</p> <p>During regeneration, exhaust temperature may reach up to 1200°F (650°C) at the particulate filter. When parking the vehicle, if this telltale light is illuminating, make sure that the exhaust system diffuser is away from people or any flammable materials, vapors or structures.</p> </div>
	<p>DPF Regeneration Request</p> <p>Illuminates to notify the driver that a manual stationary regeneration will be required soon. The flashing state indicates a more severe condition requiring regeneration. Refer to “Exhaust Aftertreatment System” paragraph in OTHER FEATURES section.</p>
	<p>Low DEF Level</p> <p>Illuminates when there is between 1.6 and 0.8 gallons (6 and 3 liters) of DEF left in the tank.</p> <div style="border: 1px solid black; padding: 5px;">  <p>CAUTION</p> <p>This telltale light starts flashing when there is less than 0.8 gallons (3 liters) left in the tank. It may flash in conjunction with the check engine and / or stop engine lights</p> <p>If the vehicle is kept in operation with an empty DEF tank, and engine derate will eventually occur, limiting the speed to 5 mph.</p> </div>
	<p>Alternators</p> <p>This telltale indicates that both alternators are not charging.</p> <div style="border: 1px solid black; padding: 5px;"> <p><i>NOTE</i></p> <p>“Charging System Malfunction” message will also appears in the DID</p> </div> <p>This telltale will also flash and an audible signal will be heard if the battery charger is plugged to an outside source and the parking brake is removed.</p>
	<p>Intake Air Preheater On – Wait Before Starting</p> <p>Illuminates when the intake air preheater element is in function. Wait until this telltale light has turned off before starting the engine. For more information on this feature, refer to paragraph “Cold Weather Starting” in STARTING AND STOPPING PROCEDURES section.</p>
	<p>Hill Start Assist</p> <p>This function is not activated in this vehicle.</p>

	Illuminates when the ABS is not available or when the ABS is malfunctioning. After startup, since the ABS system does not operate at less than 4 mph (7 km/h), the indicator will remain illuminated until the coach reaches that speed. Refer to OTHER FEATURES section.
	<p>Electronic Stability Control (ESC)</p> Quickly flashes every time the electronic stability intervenes. Will also flash when Mud/Snow mode is turned on using the Mud/Snow switch.
	<p>High Beam</p> Illuminates when the high beams are selected. High and low beams are selected with the foot operated controls. Refer to “Foot Operated Controls” paragraph in this section.

STOP, CHECK AND INFORMATION TELLTALE LIGHTS

STOP and CHECK telltale lights illuminate automatically to draw the attention of the driver and their associated messages are displayed in the DID. More than one message (see “Acknowledging Messages” below) can be active at the same time. A displayed message can be replaced by a new message provided the new message has a higher priority. Only fault codes that have a direct impact on vehicle operation are displayed. All fault codes are stored in the appropriate ECU for access by service technicians.

STOP Telltale Light

In the event of a serious fault, the red STOP telltale light comes on and an audible alarm will sound if the engine is running. An illuminated stop message light indicates a serious problem has been detected, and the driver must respond immediately to the problem.



When illuminating, this telltale light means the vehicle must be safely pulled off the road and stopped. In some instances, the engine must be switched off immediately.

 <p>WARNING</p>
Failure to stop and take necessary action when the stop telltale light is on can result in automatic engine derate and shutdown.

In some cases preventive action may be taken by the engine ECU to protect the engine. For further details, refer to “Engine Protection System” in STARTING AND STOPPING PROCEDURES section.

CHECK Telltale Light

This telltale light means that a fault or an abnormal operating condition has been detected. The vehicle must be checked at the next stop.



If the CHECK telltale light illuminates, an associated message is displayed in the DID. Always pay attention to the associated messages (see “Acknowledging Messages” below).

ACKNOWLEDGING MESSAGES

A fault message associated to a STOP or CHECK telltale light must be acknowledged by pressing the ESCAPE or ENTER button after which the display returns to the same status that existed before the fault occurred. All messages can be acknowledged. Acknowledged but inactive messages are displayed again when the ignition key is turned to the START position or they can be read in the DID menu. Refer to OTHER FEATURES for more information on the DID menus.

DRIVER INFORMATION DISPLAY

The DID (Driver Information Display) is located in the center of the instrument cluster. It displays digital gauges, main menus and sub-menus that provide necessary and important information to the driver. The information available to the driver depends on vehicle configuration, and whether the vehicle is in operation or parked. For the list

of the available menus and sub-menus, refer to “Driver Information Display Menu” in OTHER FEATURES section.

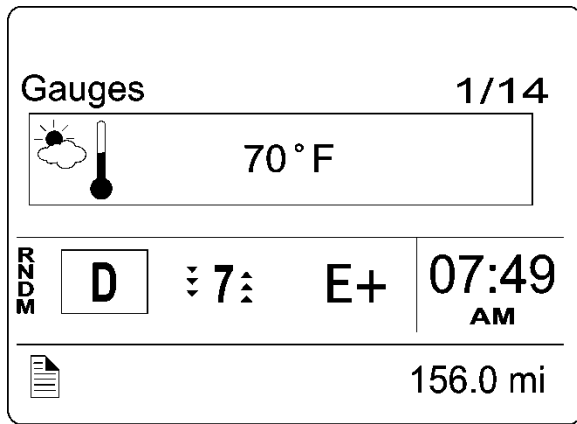

06746

The outside air temperature, fuel flow and the odometer (Allison transmission) are part of the default display. You can replace the default display by your selection of favorite gauges using the Driver Information Display sub-menu Favorite Display Setting. Refer to *Other Features* section for more information.

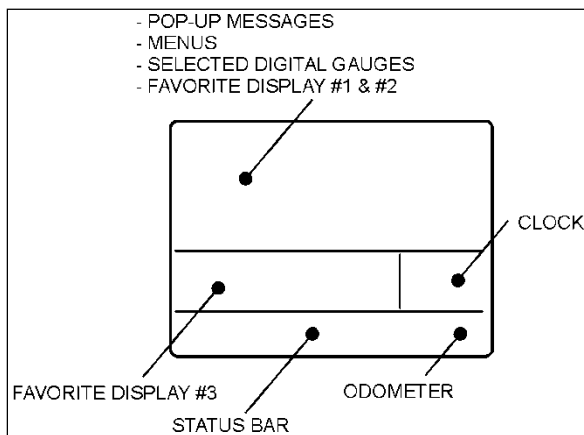

06742

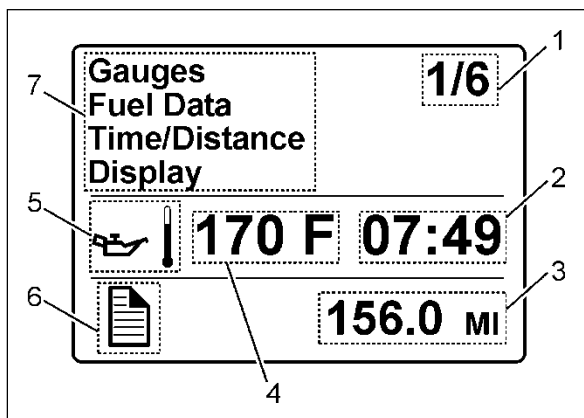

06743

1. Indicates first of six available menus (varies by menu)
2. Clock
3. Odometer
4. Value or data (in this example, the engine oil temperature)
5. Pictogram relevant to the displayed value or data
6. Status bar active pictogram
7. Messages or available menus

Selecting a menu

Menus are placed in a cascade arrangement. Use the Driver Information Display (DID) keyboard to scroll through them.

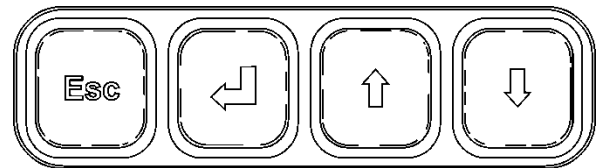

To select a menu:

1. Press the or **ESC** button to display the list of available menus.
2. Use the button to scroll up or down through the menus.
3. Use the button to open a menu.
4. Use the **ESC** button to return to the previous menu or display or to cancel a setting or operation.

To change settings

To change a setting, like the clock for example:

5. Use the button to increase or decrease the numerical value of the selected field.
6. Use the button to confirm your choice and to move to the next field.

- Press the **ESC** button to return to the previous field or to cancel a setting or operation.

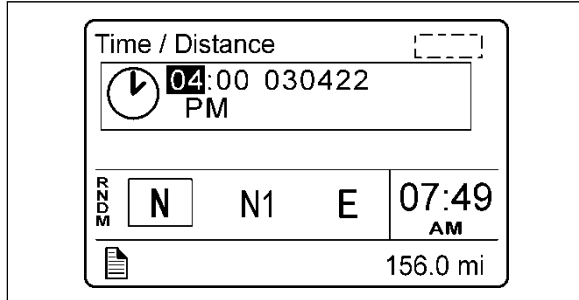







PICTOGRAMS DISPLAYED ON THE DRIVER INFORMATION DISPLAY (DID)



NOTE









In certain situations, the pictogram displayed represents a system or a function of the vehicle. A particular pictogram may be displayed with different messages. In that situation, it is very important to pay attention to the message displayed with the pictogram.







Warning pictograms, pop-up message pictograms, verifications and information pictograms



DRIVER INFORMATION DISPLAY GAUGE MENU PICTOGRAMS	
Pictogram	Description
	Date and time
	Outside air temperature
	Icing condition If the exterior temperature is between 32 to 35°f, the outside air temperature pictogram described above is replaced by this popup
	High engine temperature
	Transmission oil temperature
	Accessories air pressure Normal pressure should be between 122 and 140 psi.

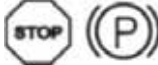



4-28 CONTROLS AND INSTRUMENTS





	<p>A/C compressor pressure</p> <p>This pictogram is displayed with a/c compressor suction pressure value (low side) and discharge pressure value (high side).</p>
	<p>Battery voltage</p> <p>This pictogram is displayed with both the 12-volt and 24-volt electrical system current voltage value. When the engine is running, the 24-volt electrical system voltage value should be between 26,5 et 28,0 volts.</p>
	<p>Battery state of charge</p>

POP-UP MESSAGES	
Pictogram	Description
	<p>High coolant temperature</p>
	<p>High engine temperature</p>
	<p>Low Engine oil pressure</p>
	<p>Low accessories air pressure Low air in interlock brake system. Normal pressure should be between 122 and 144 psi.</p>
	<p>A/C Fail</p>
	<p>Wait to start</p> <p>This pictogram illuminate at any instance of starter lockout.</p>
	<p>Low brake or ABS air pressure</p> <p>This pictogram indicates that the air pressure value measured by the gauges of the front and/or rear brakes is low.</p>
	<p>Engine door ajar</p> <p>This pictogram indicates that the engine compartment door is ajar.</p>
	<p>Upper WCL door open</p> <p>This pictogram indicates that the upper wheel chair lift is open or unlocked.</p>

	<p>Lower or small WCL door open This pictogram indicates that the lower or small wheel chair lift is open or unlocked.</p>
	<p>Wheelchair lift This pictogram indicates that the wheelchair lift system is enabled and the wheelchair access door or the lift compartment door is open. It is necessary to stow the wheelchair lift, close the doors and set the wheelchair lift system enable switch to the off position to permit release of the parking brake or kneel the vehicle.</p>
	<p>Parking brake applied</p>
	<p>Remove parking brake These two pictograms are displayed if the driver tries to move or accelerate the vehicle with the parking brake applied.</p>
	<p>Tag axle lifted with vehicle speed > 12mph This pictogram appears if the vehicle speed exceeds 12 mph (20 km/h) while the tag axle is raised.</p>
	<p>Suspension Level Low With Vehicle Speed > 12mph This pictogram and message appear if the vehicle speed exceeds 12 mph (20 km/h) while the front suspension of the vehicle (kneeling) is lowered.</p>
	<p>TCS Status Icon This pictogram indicates that the traction control system is active. It is displayed in conjunction with the ESC telltale.</p>
	<p>Soot level critically high This pictogram indicates that the soot level in the diesel particulate filter is critically high or unidentifiable.</p>
<p>ENGINE COOLANT LEVEL CRITICALLY LOW</p>	<p>Critically low coolant level</p>
<p>DOOR POWER FAILURE</p>	<p>Door power failure This popup indicate that there is no power at the door control module or at one of the door solenoids</p>
<p>CHARGING SYSTEM MALFUNCTION</p>	<p>Charging system This popup appears in conjunction with the battery telltale if both alternators are not charging</p>
<p>REDUCE SPEED TO OPEN DOOR</p>	<p>Speed Switch Door controller in open position at speed over 2mph</p>
<p>DOOR INTERLOCK FAILED TO DISABLE THE ACCELERATOR PEDAL (THROTTLE)</p>	<p>Throttle malfunction This popup indicates that the door interlock failed to disable the accelerator pedal</p>

	<p>Fire in engine compartment</p> <p>This pictogram appears if a fire is detected in the engine compartment while the vehicle is on the road. A distinctive alarm informs the driver when a fire is detected. In case of fire detection when parked (parking brake applied, engine running or not), the electric horn is activated to alert the driver. Refer to <i>Safety Features And Equipment</i> section.</p> <div style="border: 1px solid black; background-color: #cccccc; padding: 5px; margin: 10px 0;">  <p>WARNING</p> </div> <p>In case of a fire, stop the vehicle immediately, stop the engine and evacuate the vehicle.</p> <div style="border: 1px solid black; padding: 5px; margin: 10px 0;"> <p><i>NOTE</i></p> <p><i>It is possible to cancel an alarm while on the road. To do so, stop the vehicle. Cycle the ignition between the ON and OFF position and then start the vehicle normally. This can be done on a temporary basis when a false alarm is activated by a defective fire detector. The driver can go on without being annoyed by the alarm.</i></p> </div> <div style="border: 1px solid black; padding: 5px; margin: 10px 0;"> <p><i>NOTE</i></p> <p><i>To stop the electric horn alarm when parked, cycle the ignition between the ON and OFF position twice within 3 seconds.</i></p> </div> <div style="border: 1px solid black; padding: 5px; margin: 10px 0;"> <p><i>NOTE</i></p> <p><i>For extinguisher's location, refer to SAFETY FEATURES AND EQUIPMENT section.</i></p> </div>
-----------------------------------------------------------------------------------	------------------------------------------------------------------------------------------------------------------------------------------------------------------------------------------------------------------------------------------------------------------------------------------------------------------------------------------------------------------------------------------------------------------------------------------------------------------------------------------------------------------------------------------------------------------------------------------------------------------------------------------------------------------------------------------------------------------------------------------------------------------------------------------------------------------------------------------------------------------------------------------------------------------------------------------------------------------------------------------------------------------------------------------------------------------------------------------------------------------------------------------------------------------------------------------------------------------------------------------------------------------------------------------------------------------------------------------------------------------------------------------------------------------------------------------------------------------------------------------------------------------------------------------------------------------------------------------------------------------------------

Status Line Pictograms	
Pictogram	Description
	<p>Raised tag axle</p>
	<p>DPF Regeneration inhibited</p> <p>Confirms that IVN regeneration inhibit function is active because the vehicle is inside of a geofence. When flashing, this pictogram indicates an IVN issue inhibiting regeneration as well.</p>
	<p>Test mode</p> <p>Indicate that the vehicle test mode has been initiated manually.</p>
	<p>Entrance door interlock</p> <p>Confirms that the entrance door interlock is enabled.</p>

	<p>Entrance door interlock disabled Indicates that the entrance door interlock is disabled through the use of the entrance door interlock cancel switch or the master interlock switch.</p>
	<p>Kneeling/front suspension active Indicates that the front suspension is lowered (kneeling).</p>
	<p>Allison transmission retarder Confirms that the Allison transmission retarder is OFF.</p>
	<p>Allison transmission retarder – braking level 0, 1, 2, 3, 4, 5, 6 Indicate the retarder level. Refer to “Transmission Retarder” heading in this section.</p>

HORN

The electric horn is operated from the steering wheel center pad or from the foot-operated switch.

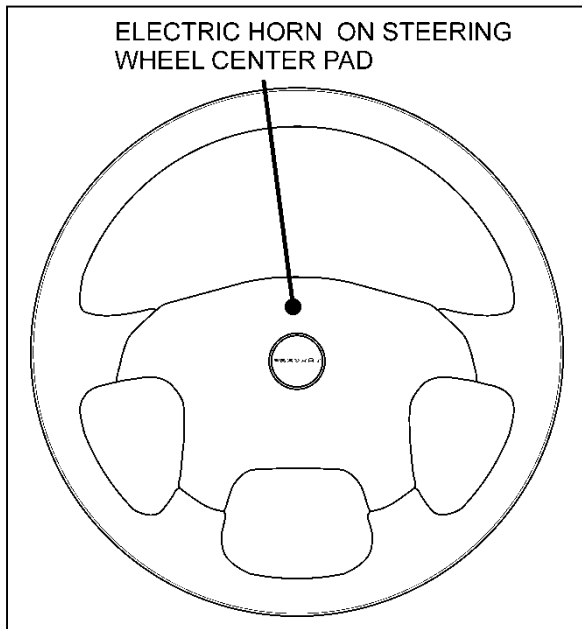

STEERING WHEEL

NOTE

When the vehicle is stationary, the electric horn will sound to inform the driver that a fire is detected in the engine compartment.

FOOT-OPERATED CONTROLS

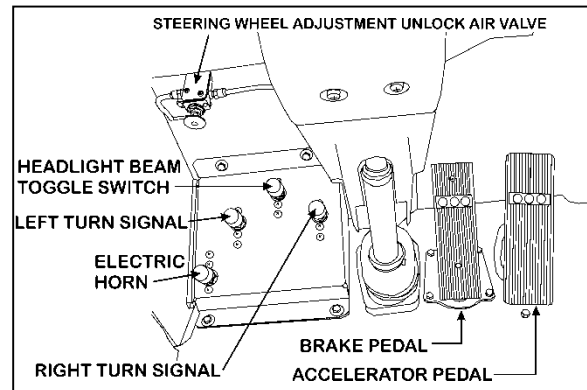

FOOT-OPERATED CONTROLS

00023A

HEADLIGHT BEAM TOGGLE SWITCH

Toggle between high and low beams by pressing the foot-operated switch.

LEFT TURN SIGNAL SWITCH

Press the foot-operated switch to signal a left turn.

RIGHT TURN SIGNAL SWITCH

Press the foot-operated switch to signal a right turn.

ELECTRIC HORN

Press the foot-operated switch to activate the electric horn (city horn).

DISTRESS SIGNAL SWITCH

Press the foot-operated distress signal switch to signal an emergency and ask for immediate assistance. A warning message will be displayed on all exterior destination signs (see *electronic destination sign* in this section for more information).

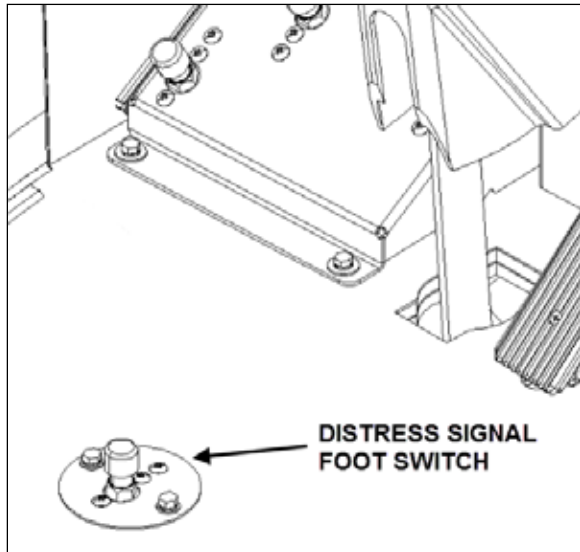

DISTRESS SIGNAL SWITCH

BRAKE PEDAL

The coach is equipped with a dual braking system. The front brakes operate from a different air pressure source from the drive and tag axle brakes. The dual braking system becomes a modulated emergency system if a pressure drop occurs in the primary brake system.

Service brakes are applied by depressing the brake pedal. Braking increases with the amount of pressure applied to the foot pedal. Refer to Other Features section under Antilock Braking System. When the brake pedal is depressed, the brake lights turn on automatically.

For safe and effective braking, the air system pressure should reach at least 120 psi in both the primary and secondary circuits. A warning LED and an audible alert will sound when the air pressure in either the primary or secondary circuit drops below 75 psi. If this occurs, stop the coach; determine the cause of the pressure loss before proceeding. The brake pedal can be used in conjunction with the transmission retarder. Refer to Transmission Output Retarder in this section.



DANGER

Immediately report any brake system problem to your company or directly to the nearest Prevost or Prevost-approved service center.

Do not "fan" or "pump" the brake pedal. This practice does not increase brake system effectiveness but rather reduces system air pressure thereby causing reduced braking effectiveness.



CAUTION

"Riding" the brake by resting one's foot on the brake pedal when not braking can cause abnormally high brake temperature, can damage and cause premature wear of brake components and reduce brake effectiveness.

ACCELERATOR PEDAL

Controls engine RPM as needed.

NOTE

The accelerator pedal will not operate when the entrance door is open.

ALLISON AUTOMATIC TRANSMISSION

The transmission is fully automatic: Proper ranges should be automatically selected according to driving speeds to improve vehicle performance and control. The speed ratio of the power converter changes automatically as vehicle speed increases and direct-drive goes in and out as necessary. The speed ratio is modulated by vehicle speed and accelerator pedal position. You will find the complete transmission operation instructions and driving tips in the **Allison 5th Generation Bus Series Operator's Manual** included in your vehicle's publication box.

OPERATION

When a button is depressed on the transmission control pad, the corresponding letter or number is displayed indicating the transmission is ready to operate in the selected range. If the transmission control module (TCM) detects a serious problem in the transmission, the CHECK telltale lights on the dashboard.

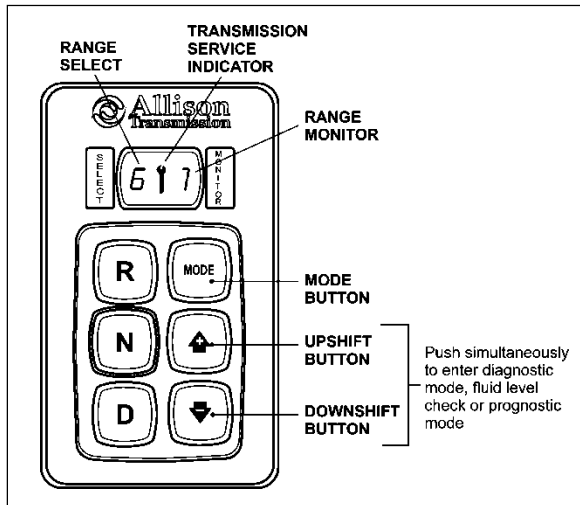

ALLISON PUSHBUTTON SHIFT SELECTOR 07142

PUSHBUTTON SHIFT SELECTOR

The pushbutton shift selector has the following elements:

R: Press to select Reverse gear.

N: Press to select Neutral.

D: Press to select Drive. The highest forward range available will appear in the digital display window under SELECT. The transmission will start out in the lowest available forward range, displayed under MONITOR, and advance automatically to the highest range.

▲ ▼ : Press respectively the ▲ (Upshift) or ▼ (Downshift) arrow button when in DRIVE to request the next higher or lower range. One press changes gears by one range. If the button is held down, the selection will scroll up or down until the button is released or until the highest or lowest possible range is selected. Protection mechanisms inhibit selecting ranges that are not appropriate for the current speed or which may damage driveline components.

MODE: Pressing the MODE button allows the driver to select the secondary shift mode that has been programmed into the TCM unit.

NOTE

When the diagnostic display mode has been entered, the MODE button is used to view and toggle through diagnostic code information. Refer to appendix B for more details about **diagnostic code display procedure** and **fluid level check** using the pushbutton shift selector.

PRIMARY AND SECONDARY SHIFT MODES

In the **primary shift mode** which is the default mode at starting of the engine, the transmission controller automatically selects between ECONOMY and SUPER ECONOMY shift schedules, based on the vehicle's actual payload and the grade on which it is operating. This is called Load Based Shift Scheduling (LBSS).

In the **secondary shift mode**, only the SUPER ECONOMY shift schedule (SESS) is available. No switching is done between shift schedules. The secondary shift mode is available only if selected by the driver, using the MODE button. When the secondary mode is activated, "MODE" illuminates on the display.

DESCRIPTION OF AVAILABLE RANGES

R (Reverse)

Press the «R» button to select reverse. Completely stop the vehicle and let the engine return to idle before shifting from forward range «D» to reverse «R» or from reverse to forward range. The reverse warning signal will be activated when this range is selected.

N (Neutral)

Use this position to start engine. Select «N» (Neutral) when checking vehicle accessories and for extended periods of engine idle operation; parking brake must then be applied. *The pushbutton shift selector automatically select «N» (Neutral) when the ignition switch is turned ON.*

NOTE

The automatic transmission does not have a park «P» position. Select «N» (Neutral) and apply parking brake when the vehicle is left unattended. An audible alert will sound if the engine is stopped and the parking brake is not applied.

WARNING

Before leaving driver's seat, always put the transmission in NEUTRAL and apply parking brake.

WARNING

The vehicle service brake or park brake must be applied whenever NEUTRAL is selected to prevent unexpected vehicle movement.



CAUTION

Diesel engines should not be idled for extended periods at "slow" idle. For extended idling, engine should run at "fast" idle.



CAUTION

Do not allow your vehicle to "coast" in neutral «N». This practice can result in transmission damage. Also, no engine braking is available in neutral.

D (Drive)

Use this position for all normal driving conditions. After touching this pad, the vehicle will start in first or second range and will automatically upshift to a higher range as output speed increases. As the vehicle slows down, output speed decreases, the transmission automatically downshifts to the correct range. If a locked brake or a slick surface condition should occur, the TCM (Transmission Control Module) will command converter operation (disconnect lockup) and inhibit downshifts for a period of time or until normal wheel speed has been restored.

IMPORTANT NOTE

Brake pedal must be applied when selecting «D» (Drive) otherwise the transmission will stay in «N» (Neutral).

NOTE

The transmission should normally be allowed to shift by itself, but manual shifting can be done as described below.

1 (First range)

Select this range when pulling through mud and snow, when speed control is needed for driving up or down steep grades or when maneuvering in tight spaces. This range also provides maximum driving torque and engine braking power or retarder braking effect. In the lower ranges (1, 2, 3 and 4), the transmission will not upshift above the highest gear selected unless engine overspeed is detected.

(Second range)

Select this range when operating in heavy and congested traffic. The transmission will start in first and automatically upshift to second. When

slowing, the transmission will automatically downshift to first range. Low ranges provide progressively greater engine and retarder braking power (the lower the range, the greater the engine and retarder braking effect).

3, 4 (Third and fourth ranges)

Select these ranges when driving on moderate grades or when load and traffic conditions limit speed.



WARNING

Service brake should not be used to control the speed of vehicle on long, steep descents. Instead, lower transmission ranges should be used (in conjunction with output retarder. Refer to "Engine Brake" and "Transmission Retarder" headings in Section 5 *Other Features* for details regarding both systems. This procedure keeps service brake cool and ready for emergency stopping.



CAUTION

When descending in lower ranges, care must be taken that engine speed does not exceed 2,450 rpm.

SECTION 5 OTHER FEATURES

EXHAUST AFTERTREATMENT SYSTEM	3
FILTRATION AND REGENERATION UNIT	3
<i>Passive regeneration</i>	3
<i>Stationary (parked) regeneration</i>	3
<i>Diesel particulate filter clogging sequence – Instrument cluster telltale light</i>	4
<i>Initiating a Stationary (Parked) Regeneration</i>	5
<i>Voluntary Interruption of a Stationary Regeneration</i>	5
SELECTIVE CATALYTIC REDUCTION UNIT	5
<i>Diesel exhaust fluid DEF</i>	6
<i>Diesel Exhaust Fluid (DEF) Consumption</i>	6
SELECTIVE CATALYTIC REDUCTION – DRIVER WARNINGS AND INDUCEMENTS	6
DRIVER INFORMATION DISPLAY (DID) MENUS	9
« GAUGES » MENU	10
« FUEL DATA » MENU.....	11
« TIME/DISTANCE » MENU	11
« VEHICLE MESSAGES » MENU.....	12
« RESET TRIP DATA » MENU	12
« DISPLAY SETTINGS » MENU	13
« DIAGNOSTICS » MENU	14
« PRE-TRIP ASSISTANCE (OPTION) » MENU	15
« DATA LOG » MENU	16
« AFTERTREATMENT » MENU	17
« PASSWORD » MENU	18
« BRAKE LINING REMAINING » MENU.....	19
REAR GAUGE - ENGINE COMPARTMENT	19
START-UP MODE.....	19
IGNITION MODE.....	19
SELF-DIAGNOSTIC MODE.....	19
MESSAGE CENTER DISPLAY	19
<i>Drive Mode Screen</i>	20
<i>Priority Messages</i>	20
<i>Settings and Diagnostic Screens</i>	21
TRANSMISSION OUTPUT RETARDER	24
ANTILOCK BRAKING SYSTEM (ABS)	24
KNEELING SYSTEM	25
UNLOADING TAG AXLE	25
RETRACTABLE TAG AXLE	25
IN-STATION LIGHTING	25
WHEELCHAIR LIFT SYSTEM	26
WHEELCHAIR LIFT SYSTEM DOORS	26
BEFORE OPERATING THE WHEELCHAIR LIFT	27
<i>Normal Lift Operation – To Enter Vehicle</i>	27
<i>Normal Lift Operation – To Exit Vehicle</i>	27

5-2 OTHER FEATURES

THRESHOLD WARNING SYSTEM (TWS) ADJUSTMENT.....	29
<i>Adjust Aiming of Acoustic Sensor Beam</i>	29
<i>Test Aim of Acoustic Sensor Beam</i>	29
<i>Adjust Acoustic Sensor Timing</i>	29
INTERIOR APPOINTMENTS	30
<i>Wheelchair Restraint System</i>	31
<i>Wheelchair Occupant Restraint</i>	31
EMERGENCY OPERATION.....	31
<i>To manually deploy the platform</i>	31
<i>To manually raise the platform</i>	32
<i>To manually lower the platform</i>	33
<i>To manually stow the platform</i>	33
WHEELCHAIR LIFT REMOVAL FOR STORING OR MAINTENANCE PURPOSES	34
WHEELCHAIR LIFT INSTALLATION	34

EXHAUST AFTERTREATMENT SYSTEM

The exhaust aftertreatment system consists of two units, the filtration/regeneration unit and the selective catalytic reduction SCR unit.

FILTRATION AND REGENERATION UNIT

The aftertreatment system primary function is to capture and oxidize (regenerate) the particulate matter (soot) in the engine exhaust gases and to reduce NOx. To achieve this goal, the exhaust aftertreatment system is split into two main sections: the exhaust gases first enter the **Diesel Oxidation Catalyst (DOC)** and **Diesel Particulate Filter (DPF)** assembly to capture and regenerate the soot on a regular or passive basis, then the exhaust gases flow through the **catalytic converter** to reduce NOx to minimum level. Through constant monitoring of the exhaust gas temperature and the system back pressure, EMS is able to manage regeneration.

Passive regeneration

Passive regeneration is the process by which the particulate matter is oxidized due to the heat generated by the engine internal combustion process. During normal highway operation, exhaust temperatures alone are usually high enough to oxidize accumulating soot. In low ambient temperatures, however, or in some stop-and-go applications, the system needs a little help to regenerate, or clean itself, a stationary regeneration is then required.







Stationary (parked) regeneration

In a small number of specific engine duty cycles, engine control module may not be capable of completing a passive regeneration. In these situations, the operator will be notified that a parked regeneration may be required. A DPF telltale light will illuminate indicating the need for user interaction. The lamp gives the operator a grace period to allow this process to take place at a time when most convenient for the operator. This process requires the vehicle to be parked while a driver or maintenance technician initiates the regeneration process using the DID menus. Once initiated, the stationary regeneration process will be complete in about 45 minutes.

The driver will be notified of the need for a stationary regeneration (parked) by illumination of the DPF REGENERATION telltale light.

5-4 OTHER FEATURES

Diesel particulate filter clogging sequence – Instrument cluster telltale light

<p>LEVEL 1</p>	 steady	<p>REGENERATION NEEDED</p> <p><i>Diesel particulate filter is becoming full</i></p> <p><i>The DPF REGENERATION telltale light illuminates to notify the driver that a stationary regeneration (parked) will be required soon. When this lamp is lit, initiate stationary regeneration process at an appropriate time of day. THERE IS NO URGENCY AT THIS LEVEL.</i></p>
<p>LEVEL 2</p>	 flashing	<p>REGENERATION REQUIRED</p> <p><i>Diesel particulate filter full</i></p> <p><i>If no DPF regeneration occurs after the initial DPF REGENERATION telltale light illumination, the lamp will begin blinking and a stationary regeneration should be initiated as soon as possible in order to prevent from entering into Level 3.</i></p>
<p>LEVEL 3</p>	 flashing + 	<p>ATD SERVICE REQUIRED</p> <p>ENGINE DERATE ACTIVE</p> <p><i>Diesel particulate filter overfull</i></p> <p><i>If the flashing DPF REGENERATION telltale light is still ignored, the CHECK telltale light will illuminate. In that situation, engine performance is limited. Perform a parked regeneration IMMEDIATELY to avoid further derate and prevent from entering into Level 4.</i></p>
<p>LEVEL 4</p>	 flashing +  + 	<p>ATD SERVICE REQUIRED</p> <p>ENGINE SHUTDOWN ACTIVE</p> <p><i>A serious engine problem has occurred. The DPF may be over its maximum capacity.</i></p> <p><i>If a stationary regeneration is still not initiated, a standard Engine Protection Shutdown sequence will occur. All of the following dashboard lamps will be present:</i></p> <p><i>Blinking DPF REGENERATION telltale light;</i> <i>Solid CHECK telltale light;</i> <i>Solid STOP telltale light.</i></p> <p><i>Once engine derate and/or shutdown sequence is completed, a stationary regeneration must occur to continue vehicle operation. If the driver continues to operate the vehicle without regeneration, additional measures will be taken to protect the engine and ATD from damage, up to and including engine shutdown. Parked regeneration might no longer be possible.</i></p> <p><i>If engine protection has been initiated and forces the engine to shut down, you CAN immediately re-start the engine and perform the necessary steps in order to initiate a stationary regeneration.</i></p>

Initiating a Stationary (Parked) Regeneration**NOTE**

At starting of the engine, if a stationary regeneration is required, the engine coolant temperature must reach 140°F (60°C) before any stationary regeneration may be initiated and completed. Permit the engine to idle for a short while or drive the vehicle until engine temperature increases sufficiently.

**WARNING**

Do not initiate a stationary regeneration in a closed area like a garage. Stationary regenerations must be undertaken outdoors only.

**WARNING**

During stationary regeneration, exhaust temperature may reach up to 842°F (450°C) at the particulate filter, it will go down to 788°F (420°C) after the catalytic converter and then will be further reduced to 554°F (290°C) at the diffuser outlet. Before initiating stationary regeneration, make sure that the exhaust outlet diffuser is clear of objects and that no one is working close to the exhaust outlet diffuser.

**WARNING**

Hot surfaces. Keep yourself clear of all hot Aftertreatment Device components, particularly during and after active or stationary regeneration. Hot surfaces can cause serious burns.

NOTE**STATIONARY REGENERATION**

This process requires the vehicle to be parked while the driver or a maintenance technician initiates the regeneration process.

The DPF REGENERATION telltale light illuminates to notify the driver of the need and urgency of a manual stationary regeneration.



DPF REGENERATION telltale light

If stationary regeneration is not performed, this telltale light will blink, indicating that a stationary

regeneration is required immediately. If stationary regeneration is still not performed, “engine power derate and shutdown” sequence may occur as per level 1 to level 4 sequence.

To initiate a stationary regeneration:

- Park the vehicle in a clear area, vehicle speed must be 0 mph (0 km/h);
- Engine must be on normal idle and fully warmed up (coolant temperature above 140°F/60°C);
- Apply parking brakes and set the transmission to neutral (N).
- Press the DID ENTER button and then get to the DID Aftertreatment menu. Select sub-menu Request Parked REGEN and press ENTER button to confirm and initiate regeneration.

The regeneration will begin. Turn off the air conditioning to reduce engine load. The engine idling speed will increase to 1200 rpm. Once the regeneration is completed, the engine speed will return to normal idle.

Voluntary Interruption of a Stationary Regeneration

It is possible to interrupt a stationary regeneration at all time. To do so, get to the DID's Aftertreatment menu, select Cancel REGEN and press ENTER button to confirm. You can stop regeneration simply by releasing the parking brake. Use this procedure in order to move the vehicle in a safe area.

**CAUTION**

To avoid damages to the system components, do not set the ignition key to the OFF position to interrupt a stationary regeneration.

If regeneration is interrupted, it is very important to reinitiate the regeneration as soon as possible.

SELECTIVE CATALYTIC REDUCTION UNIT

Selective Catalytic Reduction (SCR) is a technology that uses Diesel Exhaust Fluid (DEF) and a catalytic converter to reduce nitrogen oxides (NOx) emissions.

SCR is an exhaust aftertreatment system that injects small amount of DEF into the exhaust gas between the DPF and the selective reduction catalytic converter. DEF turns to ammonia and carbon dioxide when heated. The

5-6 OTHER FEATURES

exhaust stream then passes over a catalyst, the ammonia reacts with the NO_x to form nitrogen and water vapor.

The basic elements of the SCR system consist of a 15.9 gallons (60 liters) DEF tank complete with pump, lines and heating system, a dosing injector, a catalytic converter and the control and monitoring system.

Diesel exhaust fluid DEF

When handling DEF solution, it is important that electrical connectors to be connected or well encapsulated, otherwise there is a risk that the DEF will cause oxidation that cannot be removed. Water or compressed air will not help, since DEF quickly oxidizes certain metals. If a disconnected connector comes into contact with the DEF solution, it must be replaced immediately to prevent the DEF solution from creeping further into the copper wiring, which takes place at a speed of about 2.4 in (60 mm) per hour.



CAUTION

Diesel Exhaust Fluid (DEF) is a nontoxic aqueous solution of urea (32.5%) and ultra-pure water (67.5%). Urea is a compound of nitrogen that turns to ammonia when heated. The fluid is non flammable, and is not dangerous when handled as recommended. However, it is highly corrosive to certain metals, especially copper and brass.

When detaching hoses and components, do not spill DEF on disconnected or unsealed connectors. If DEF is spilled on a disconnected or unsealed connector, the connector must be removed immediately and replaced.

Things to know about spilt diesel exhaust fluid (DEF):

- If urea solution comes into contact with the skin, rinse with plenty of water and remove contaminated clothing.
- If urea solution comes into contact with the eyes rinse for several minutes and call for medical help if necessary.
- If inhaled breathe fresh air and call for medical help if necessary.
- Do not allow the DEF solution to come into contact with other chemicals.

- The DEF solution is not flammable. If the DEF solution is exposed to high temperatures, it breaks down into ammonia and carbon dioxide.
- The DEF solution is highly corrosive to certain metals, including copper and aluminum.
- If the DEF solution is spilled onto the vehicle, wipe off the excess and rinse with water. Spilled DEF solution can form concentrated white crystals on the vehicle. Rinse off these crystals with water.



WARNING

DEF spilt onto hot components will quickly vaporize. Turn your face away!







Diesel Exhaust Fluid (DEF) Consumption



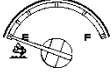

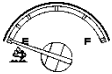

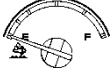

DEF consumption is related to fuel consumption. In order to meet EPA requirements, DEF tanks are sized so one refill will be necessary every two refill of the fuel tank.

SELECTIVE CATALYTIC REDUCTION – DRIVER WARNINGS AND INDUCEMENTS









SCR system components must not be removed, altered or modified in any way. In order to protect the SCR system from tampering, inducement measures will occur if the following states are detected:

- Disconnection of DEF tank level sensor
- Blocked DEF line or dosing valve
- Disconnection of DEF dosing valve
- Disconnection of DEF pump
- Disconnection of SCR wiring harness
- Disconnection of NO_x sensor
- Disconnected exhaust temperature sensor
- Disconnected DEF temperature sensor
- Disconnected DEF quality sensor

DEF TANK LEVEL DRIVER WARNINGS AND INDUCEMENTS			
Conditions / Triggers	DEF Tank LOW LEVEL Indicator, DID Message and audible warning		Inducement
1 Normal DEF tank level sensor reads between 100% and 10%	None		None
3 DEF tank near empty DEF tank level sensor reads less than 5%		 blinking	None
4 DEF tank empty and one (1) hour of operation in engine derate mode		 blinking	(3/4) DEF TANK EMPTY ENGINE IN DERATE 5 MPH LIMIT IF VEHICLE NOT MOVING FOR 20 MIN 
5 DEF tank empty 1. Diesel fuel refueling done with a fuel level sensor reading increase of 15%, or more 2. Vehicle stationary (speed=0) for 20 minutes with engine off or at idle		 blinking	(4/4) REFILL DEF TANK VEHICLE SPEED LIMITED TO 5 MPH (8 KM/H) 

DEF QUALITY DRIVER WARNINGS AND INDUCEMENTS			
Conditions / Triggers	Amber Warning Light & Did Message And Audible Warning		Inducement
1 Good DEF quality	None		None
2 Poor DEF quality detected	 solid	(1/4) DEF QUALITY OK TO CONTINUE DRIVING 	Engine will derate 25% in < 60 mins
3 Poor DEF quality detected and one (1) hour of operation with active diagnostic troubleshooting code	 solid	(2/4) DEF QUALITY OK TO CONTINUE DRIVING 	Poor def quality detected Engine derated 25% engine will derate 40% in <240 mins
4 Poor DEF quality detected and four (4) hours of operation with active diagnostic troubleshooting code	 solid	(3/4) SERVICE DEF 5 MPH LIMIT IF VEHICLE NOT MOVING FOR 20 MIN 	Engine derated 40% 5 mph (8km/h) limit after next 20 min vehicle stop
5 Poor DEF quality detected Diesel fuel refueling done with a fuel level sensor increase of 15% or more or Vehicle stationary (speed=0) for 20 minutes with engine off or at idle or Key cycle trigger	 solid	(4/4) POOR DEF QUALITY 5 MPH LIMIT SERVICE DEF SYSTEM 	Service DEF 5 mph (8km/h) limit

5-8 OTHER FEATURES

SCR SYSTEM TAMPERING DRIVER WARNINGS AND INDUCEMENTS				
Conditions / Triggers		Amber Warning Light, Did Message And Audible Warning		Inducement
1	Normal No diagnostic troubleshooting code active	None		None
3	An SCR fault has been detected Continue driving	 solid	(1/4) SRC SYSTEM OK TO CONTINUE DRIVING  3 cycles of 2 beeps	25% Engine torque reduction in 60 minutes
4	An SCR fault has been detected Continue driving	 solid	(2/4) SRC SYSTEM OK TO CONTINUE DRIVING  3 cycles of 2 beeps	Engine torque derated 25% 40% Engine torque reduction in 240 minutes
5	An SCR fault has been detected	 solid	(3/4) SCR SYSTEM 5 MPH LIMIT IF VEHICLE NOT MOVING FOR 20 MIN  3 cycles of 2 beeps	Engine torque derated 40% Vehicle speed limited to 5 mph (8 km/h) if vehicle is immobilized for more than 20 min
6	An SCR fault has been detected Diesel fuel refueling done with a fuel level sensor increase of 15% or more or Vehicle stationary (speed=0) for 20 minutes with engine off or at idle or Key cycle trigger	 solid	(4/4) SCR SYSTEM 5 MPH LIMIT SERVICE SYSTEM  continuous cycle of 2 beeps	Vehicle speed limited to 5 mph (8km/h)

DRIVER INFORMATION DISPLAY (DID) MENUS

There are Driving and Non-Driving menus. Several sub-menus are password-protected while the vehicle is parked. The Non-Driving menu is accessible only when the vehicle is parked.

Refer to “Driver Information Display” in CONTROLS AND INSTRUMENTS section for details on how to scroll through DID menus or select an item whose setting is to be changed.

DRIVING MODE MENUS	NON-DRIVING/STATIONARY MODE MENUS
Gauges <ol style="list-style-type: none"> 1. Outside Temperature 2. Engine Oil Temperature 3. Transmission Fluid Temperature 4. Accessories Air Pressure 5. A/C Compressor Pressure 6. Battery Voltage 7. Battery State Of Charge 	Display Settings <ol style="list-style-type: none"> 1. Language 2. Units 3. Time/Date 4. Favorite Display Setting 5. Display Light 6. Change Password
Fuel Data <ol style="list-style-type: none"> 1. Fuel Flow / ECO % 2. Trip Fuel Used 3. Distance to Empty 	Diagnostics <ol style="list-style-type: none"> 1. View Active Faults 2. View Inactive Faults 3. Cluster Self-Test 4. Part Number 5. Reset Inactive Faults 6. Vehicle Tests
Time-Distance <ol style="list-style-type: none"> 1. Time and Date 2. Alarm Clock 3. Trip Odometer 1 and 2 4. Average Trip Speed 5. Estimated Time of Arrival (ETA) 	Pre-Trip Assistance <ol style="list-style-type: none"> 1. Exterior Light Inspection 2. Air Leakage Monitor
Vehicle Messages	Datalog <ol style="list-style-type: none"> 1. Vehicle ID 2. Total Data 3. Trip Data 4. Reset Trip Data
Reset Trip Data	Aftertreatment <ol style="list-style-type: none"> 1. Request Parked REGEN 2. ATS Status 3. Cancel REGEN
	Password <ol style="list-style-type: none"> 1. Enter Password
	Brake Lining Remaining

5-10 OTHER FEATURES

« GAUGES » MENU

There are several gauges in this menu. The gauges are used to view current status of important functions in the vehicle.

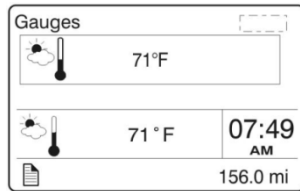

1. Outside Temperature

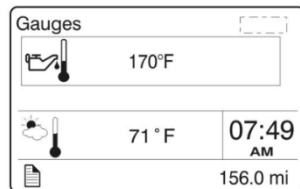

2. Engine Oil Temperature

Selecting this gauge will display the engine oil temperature.

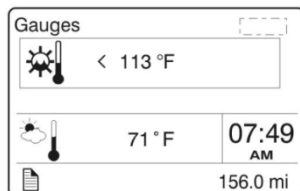

3. Transmission Fluid Temperature

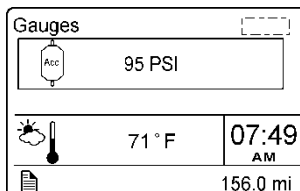

4. Accessories Air Pressure

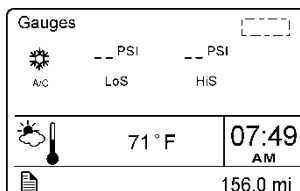

5. A/C Compressor Pressure

Displays the A/C compressor suction pressure value (LoS=low side) and discharge pressure value (HiS=high side).

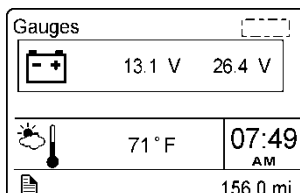

6. Battery Voltage

Displays current 12-volts and 24-volts system voltage.

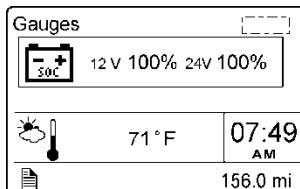

7. Battery State Of Charge

When equipped with PRIME option, displays the state of charge of the 12-volt and 24-volt battery banks.

« FUEL DATA » MENU

The Fuel Data menu provides information on the fuel consumption of the vehicle in various situations. For example, how much fuel has been used, how much fuel is remaining before refueling the vehicle.

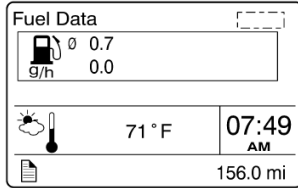

1. Fuel Flow (gph)

The lower numerical value indicates the instantaneous fuel consumption. In this menu, you can reset the upper numerical value which is the average fuel consumption. To reset, hold ENTER button for 1 second.

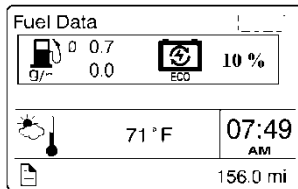

When equipped with PRIME, the percentage of trip made on regenerated electricity is also displayed.

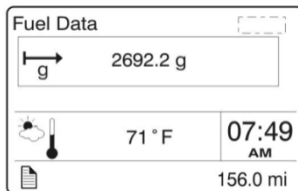

2. Trip Fuel Used

Indicates the total fuel consumption (gallons/liters) since the last reset. Note: You should use Reset function before each new trip.

You can reset the fuel consumption value in this menu. To reset, hold ENTER button for 1 second.

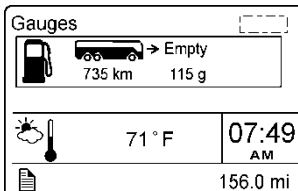

3. Distance to Empty

The left numerical value indicates the distance that can be traveled with the quantity of fuel that remains in the tank as indicated by the right numerical value.

« TIME/DISTANCE » MENU

The time and date can be set in the Time/Distance menu. The alarm clock can also be set from this menu. Following the alarm clock menu is the Trip Odometer 1 and 2 selection, which allows the operator to see the distance travelled since the last reset. Average trip speed is also shown. By specifying the distance to your destination, the vehicle can calculate the estimated time of arrival (ETA).

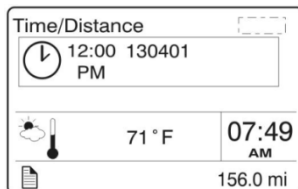

1. Time And Date

Adjust time and date with this menu. The instrument cluster has its own internal battery, so the date and date setting is keep in memory even if the vehicle's battery is disconnected.

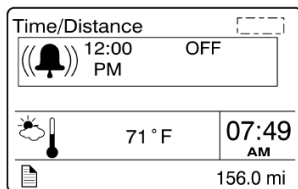

2. Alarm Clock

Use this function to program and activate an alarm on the instrument cluster clock. When the alarm clock goes off, a warning signal is sounded. The alarm shuts off after 60 seconds or if the ESCAPE button is depressed.

5-12 OTHER FEATURES

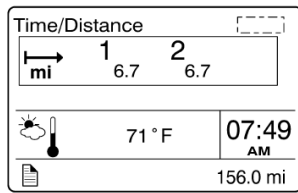

3. Trip Odometer 1 and 2

Allows the operator to see the distance travelled since the last reset. You can reset the trip odometer 1 or 2 in this menu. To reset, depress ENTER button, use UP/DOWN button to select between odometer 1 or 2 and then hold ENTER button for 1 second.

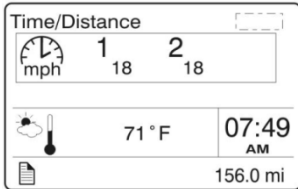

4. Average Trip Speed

This function displays the average speed for the current travel. The average trip speed is calculated as the distance traveled divided by the time the engine has been running (since the last reset). Two average trip speeds can be measured, corresponding to leg 1 and leg 2. Use Reset function before each new travel to start new measurements.

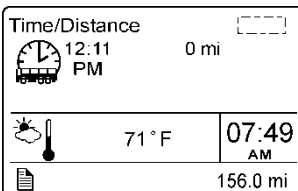

5. Estimated Time of Arrival (ETA)

This function will display the estimated time of arrival if the distance to be traveled is entered first, in this menu. To set distance to be traveled, press ENTER and enter the distance left to drive in mile or km using ENTER and UP/DOWN buttons.

« VEHICLE MESSAGES » MENU

Use this function to consult the vehicle active messages that were previously displayed as pop-up messages and then acknowledged. When consulting a message, the corresponding STOP, CHECK or INFORMATION warning light will illuminate. Scroll through the messages using the up/down button. Press ESC button to return to main menu.

« RESET TRIP DATA » MENU

When the Reset Trip Data menu is open, pressing and holding down the Enter button for 1 second resets the functions listed below. This function will permit to the system to calculate new value from the point of resetting.

- Fuel Flow
- Trip Fuel Used
- Average Trip Speed

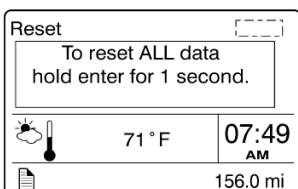

« DISPLAY SETTINGS » MENU

The Display Settings menu is used to change languages and units. The password, time and date can also be changed. The backlight and contrast of the display screen can be adjusted.

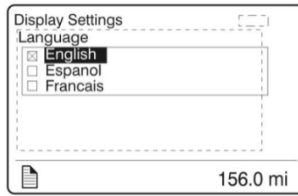

1. Language

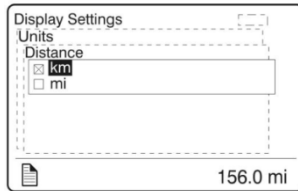

2. Units

Use this function to select desired unit formats for:

- Distance (miles or km);
- Fuel consumption (km/l, l/100km, mpg US or IMP);
- Temperature (°C or °F).

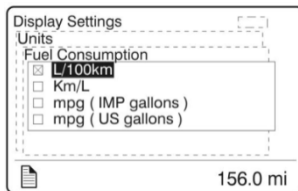

3. Time/Date

Select the time and date format (am, pm, 24h) using this function.

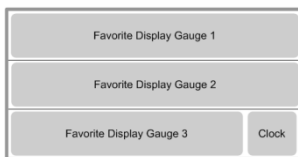
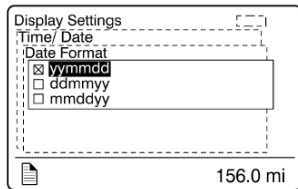

4. Favorite Display Setting

Use this menu to select your favorite display gauges 1, 2 and 3 and replace the default gauges. On vehicles provided with the I-Shift transmission, Favorite Display Gauge 3 cannot be edited as it is kept for display of the transmission status.

Example: You wish to display the engine oil temperature at the Gauge 1 position.

- Use UP/DOWN button until Gauge 1 position is selected.
- Press ENTER button to confirm.

Use UP/DOWN button to scroll through the available gauges. When the engine oil temperature gauge is displayed, press ENTER button to confirm (repeat steps 1-3 to change Gauge 2 and Gauge 3 if needed).

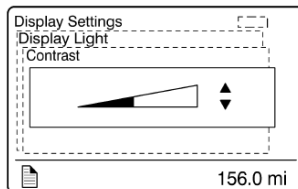

5. Display Light

The Display Light menu has three sub-menus:

• Contrast

Adjust the contrast with the UP/DOWN button and press ENTER button to confirm.

• Backlight

In this menu, the display lighting can be adjusted relative to other instrument lighting with the UP/DOWN button.

• Night/Day

Use the Night/Day menu to choose a dark background with light text and images or a light background with dark text and images. Press ENTER button to toggle between Night and Day.

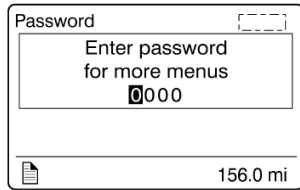

6. Change Password

Use this menu to change the current password. This menu is only accessible if the correct password is entered. The default password is 0000.

- Mark which password is to be changed with the display UP/DOWN button.
- Confirm with ENTER button.
- Set the first digit with the UP/DOWN button.
- Step to the next digit using ENTER button.
- Step backwards with ESC button.

« DIAGNOSTICS » MENU

The Diagnostics menu enables fault tracing on the control units in the vehicle to check for faults. Instrument tests are available to check the telltales, gauges, display and speaker. The part number of a control unit can be identified in the part number menu.

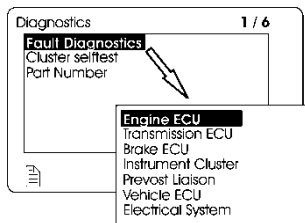

1. View Active Fault

A list of the control units on the vehicle is displayed. Use this function to check for active faults on specific control units.

2. View Inactive Fault

Use this function to check for inactive faults on specific control units.

3. Cluster Self test

Use this menu to check proper functioning of the following components:

- Telltale lights
- Analog gauges
- Display
- Speakers

The following table describes the available tests. To cancel a test, press the ESC button).

Telltale lights test	Telltale lights illuminate for approximately five seconds. Press the Esc button to cancel the test.
Analog gauges	The indicators move forwards and backwards between the end positions. They do not show any particular value. This is just a check to confirm that the indicators move, and to make sure the operators are working. Press the Esc button to cancel the test.
Display test	The entire display lights up until the Esc button is pressed.
Speaker Test	A sound is emitted through the speakers. Press the Esc button to cancel the test.

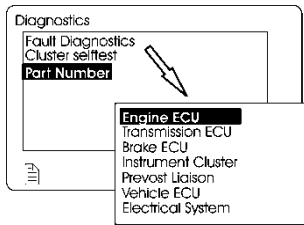

4. Part Number

A list of the control units on the vehicle with their part numbers is displayed in the Part Number menu.

5. Reset Inactive Faults

Use this menu to delete an inactive fault for a particular control unit. Note: it is not possible to delete inactive faults of the Engine ECU.

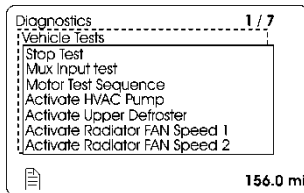

6. Vehicle Test

Use this menu to perform tests on several components and systems:

- dashboard switches (Mux Input Test)
- electric motors, valve and pump contactors (Motor Test Sequence)

In case of overheating of the engine due to a malfunction of the radiator fan clutch control, you can force activation of the fan clutch using ACTIVATE RADIATOR FAN SPEED 1, SPEED 2.

The DID status line will show TEST to confirm that one of the test modes is active. To cancel an active test, turn the ignition switch to the OFF position or press ESCAPE button, select STOP TEST submenu and then press ENTER button twice. "TEST" will disappear from the DID status line.

For further information concerning these functions, refer to section 06: Electrical, under "Troubleshooting And Testing The Multiplex Vehicles" paragraph of the Maintenance Manual.

« PRE-TRIP ASSISTANCE (OPTION) » MENU

The Pre-Trip Assistance option is a tool to assist the driver in completing the pre-trip inspection of the vehicle. This option is not a substitute for a complete pre-trip inspection. If any system of the vehicle does not pass inspection, the error must be corrected before operating the vehicle. The available pre-trip tests include the Exterior Light Inspection check, and the Air Leakage check.

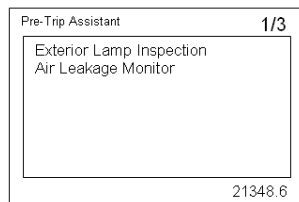

1. Exterior Light Inspection

The Exterior Light Inspection function turns on all the exterior lights simultaneously. This allows the operator to start the test, exit the vehicle and do a visual check that all exterior lights function properly. Press ESCAPE button to end the test and turn off all the exterior lights.

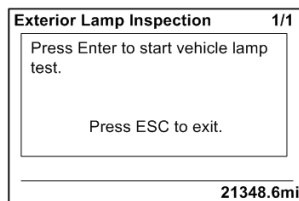

5-16 OTHER FEATURES

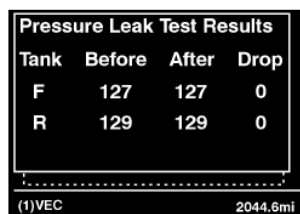
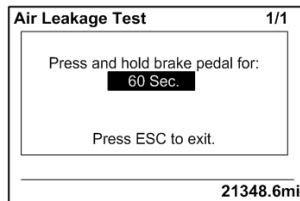
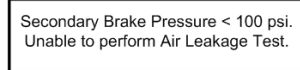
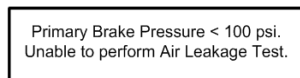
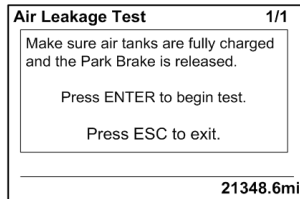
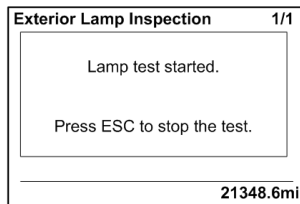

2. Air leakage Monitor

The Air Leakage check allows the driver to accurately measure the amount of air pressure drop in the front and rear brake air systems. After selecting this test from the DID, you are prompted to apply the service brake for 60 seconds. After applying and holding the service brake for 60 seconds, the DID will display the amount of pressure drop in the brake system.

Before starting the test through the DID, complete the following:

- Start the engine and check that the brake systems air pressure is greater than 100 psi.
- Turn engine off.
- Release the brakes and allow the system to settle (air gauge needle stops moving).
- Press the ENTER button to start the test.
- If the air tanks pressure is too low to perform the test (pressure must be greater than 100 psi), the following messages will appear.
- You must press and hold brake pedal for 60 seconds, as instructed.
- Once the brake pressure test is completed the pressure leak test results are displayed.

« DATA LOG » MENU

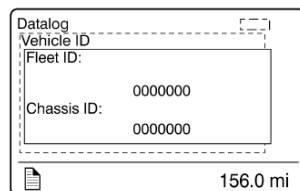

1. Vehicle ID

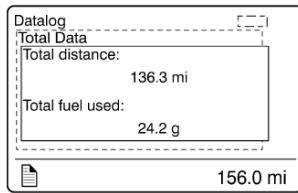

2. Total Data

Total Data menu indicates the accumulated engine values that have been logged during the lifetime of the engine ECU.

Available information:

- Total distance traveled
- Total fuel used
- Total engine hours
- Total idle time
- Total PTO hours
- total engine revolutions

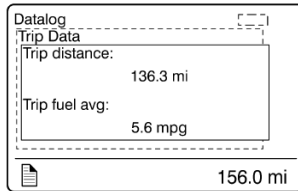

3. Trip Data

This menu displays the trip information listed below. This function must be reset before each measurement (before each new trip or leg) using the Reset Trip Data menu.

Available information for the trip or leg is:

- Trip distance (miles or km)
- Trip fuel average (mpg, liter/100km; km/liter)
- Trip fuel used (gallons or liters)
- Trip duration with engine rpm greater than economy rpm (hours)
- Trip duration while engine rpm is greater than the desired maximum rpm RPM Limit set in Fleet Limits sub-menu (hours)
- Trip fuel used with engine rpm greater than the economy rpm (gallons/liters)
- Trip average speed (mph, km/h)
- Trip duration with speed greater than the maximum desired speed as set in Fleet Limits sub-menu (hours)
- Trip engine hours
- Trip duration on engine idle (hours)
- Trip fuel used while in engine idle (gallons, liters)

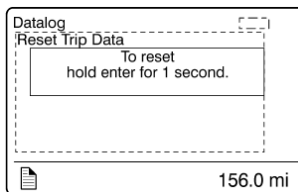

4. Reset Trip Data

This menu can only be accessed if the correct password has been entered. Use this function to reset measurements of the Trip Data menu before each new trip or leg.

« AFTERTREATMENT » MENU

This menu permits to the driver to initiate a stationary regeneration, to check the status of the aftertreatment system and to interrupt regeneration.

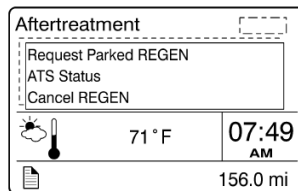

1. Request Parked REGEN

Use this function to initiate a stationary (parked) regeneration.

Even if parked regeneration is inhibited through the use of geofencing, a regeneration can nevertheless be initiated. To override IVN regeneration inhibit function and allow parked regeneration, flip the dashboard RETARDER switch 4 times (4 transitions from OFF to ON) within 2 seconds. Setting the ignition switch to OFF will cancel and return to normal geofencing operation.

5-18 OTHER FEATURES

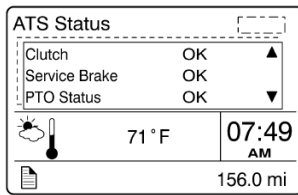

2. ATS Status

The Aftertreatment status sub-menus provide information about the conditions required for performing regeneration. The status can be OK (regeneration allowed), CHECK (regeneration not allowed) or N/A (not applicable). When ATS Status is selected, the following sub-menus are available.

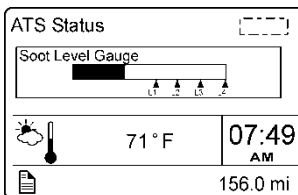
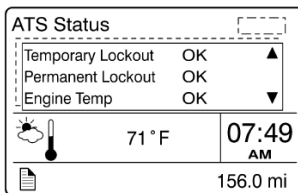
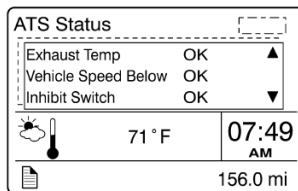
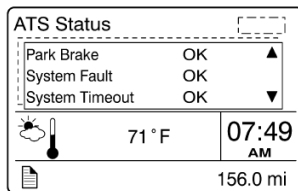
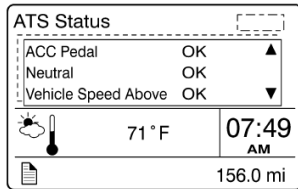

Soot Level Gauge

From the ATS Status sub-menu, you can view the soot level for the Aftertreatment system. When the soot level is high, regeneration is necessary. L1, L2, L3 and L4 under the scale correspond to Level 1 up to Level 4 (see Diesel particulate filter clogging sequence – Engine indicator lamp).



3. Cancel REGEN

From the Aftertreatment main menu, you can cancel a REGEN cycle.

« PASSWORD » MENU

Certain functions are password-protected. These passwords give the user access to all password-protected functions. The default password is 0000.

1. Password

The following menus are password-

protected and marked with a key symbol in the menus:

- Change Password
- Fleet ID
- Reset Trip Data
- Fault Diagnostics
- Inactive Faults

« BRAKE LINING REMAINING » MENU

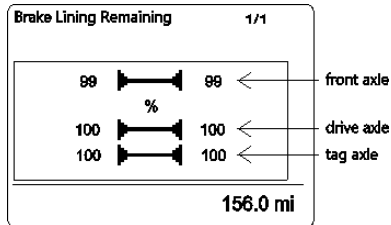

The numerical values indicate the brake lining remaining in term of percentage. New brake pads are displayed as 100%.

REAR GAUGE - ENGINE COMPARTMENT

The vehicle rear control panel is equipped with a combination tachometer / message display center intended to help the technician with the control and verification of the engine, transmission, UDS system (ACM) parameters among others.

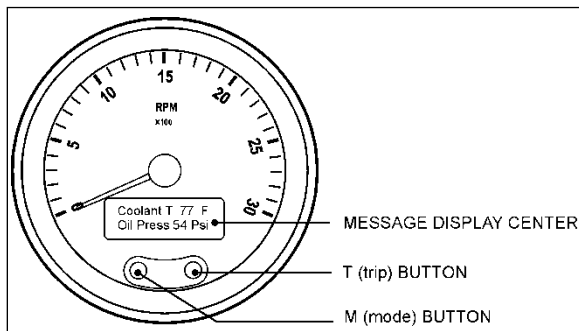

ENGINE COMPARTMENT REAR GAUGE ON REAR START CONTROL PANEL

START-UP MODE

Gauge pointer will drive to zero position. The pointers will then drive up scale, pausing at half scale, before completing the sweep to full scale.

MESSAGE CENTER DISPLAY

The message display is a graphical, backlit, LCD that displays information to the technician. In addition to basic odometer functions, a variety of customer-defined options will be displayed. Fault codes will also be displayed as they are received. Instrumentation diagnostics can be viewed on the LCD as well.

The pointers will then return to zero position before moving to the commanded position.

During the upscale sweep of the pointer, the LCD will turn all its segments off for one second and then display the opening message. The opening message is the Prevost logo.

IGNITION MODE

The ignition mode is active as long as the ignition switch is set to the ON position. The ignition is the normal operational mode of the system.

SELF-DIAGNOSTIC MODE

The self-diagnostic mode is entered through a menu selection using the LCD.

The self-diagnostic includes the following tests:

- Gauges
- LCD
- Binary Inputs
- Analog Inputs
- Communications
- Error codes on Engine, Transmission or UDS

5-20 OTHER FEATURES

Drive Mode Screen

At startup the default drive mode screen is coolant temperature and oil pressure. When the display of engine hours is enabled, then engine hours and oil pressure is displayed on startup.

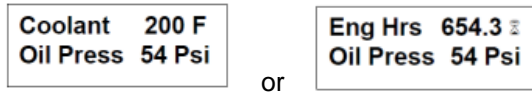

LCD Display Selection

Pressing **M** and **T** together toggles units between English and Metric. Pressing the **T** button changes the LCD display parameters.

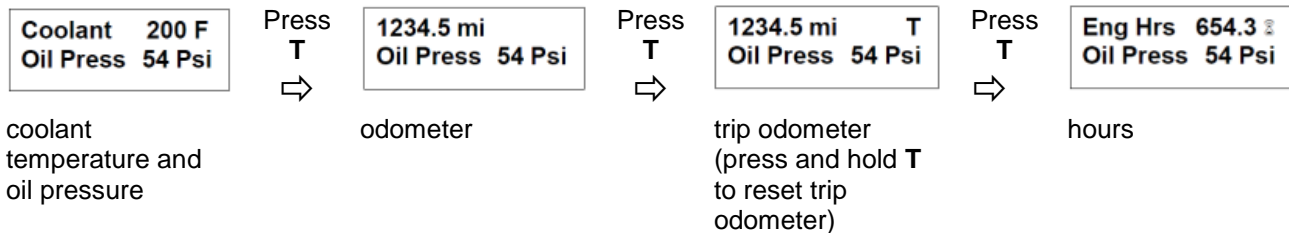

Priority Messages

No Priority Message will be displayed during the first 10 seconds after ignition ON.

Priority messages can be generated by the engine, transmission or UDS controllers (ACM) or binary inputs.

Priority messages will interrupt the bottom line of the LCD in order to provide the technician with priority information.

A priority message is removed from the display only if its source expires or if the trip button acknowledges it. Some messages can be acknowledged. If acknowledged, it remains removed from the display and will only reappear if the source expires and reoccurs. If the ignition is turned off and then back on and a priority message is still active, it will display again.

If more than one priority message is active, each message will be displayed one after the other for three seconds each.

Assignment	Exact Text	Acknowledge?	Recur?	Turns off if
Engine Comm. Failure	ENG. COMM. ERROR	Yes	No	Communication is re-established
Trans Comm. Failure	TRANS. COM. ERROR	Yes	No	Communication is re-established
ABS Comm. Failure	ABS. COMM. ERROR	Yes	No	Communication is re-established
Inst Panel Comm Failure	IPANEL.COMM.ERROR	Yes	No	Communication is reestablished
High Coolant Temp Alert	CHECK COOL TEMP	Yes	No	DM1 Clears
Low Coolant Level	LOW COOLANT LEVEL	Yes	No	message clears after 30 sec
	LOW COOLANT LEVEL	Yes	No	Flag Clears
Check Coolant SNS	CHECK COOLANT SNS	Yes	No	Flag Clears
Low Oil Pressure Alert	LOW OIL PRESSURE	Yes	No	DM1 clears
High Trans Temp Alert	CHECK TRANS TEMP	Yes	No	DM1 clears
Wait to Start	WAIT TO START	Yes	No	Msg clears
Water in Fuel	WATER IN FUEL	Yes	No	Msg clears
Engine Maintenance	ENG. MAINTENANCE	Yes	No	DM1 clears
+ Stop Engine	STOP ENGINE !!	No	No	Msg clears
Check Engine	CHECK ENGINE !	Yes	No	Msg clears
Transmission Maintenance	TRANSMMAINTENANCE	Yes	No	DM1 clears
Network Fail	NETWORK FAILURE	Yes	No	Input clears

Check Transmission	CHECK TRANSMIS.	Yes	No	Msg clears
Stop Transmission	STOP TRANSMIS.!!	No	No	DM1 clears
Fire Alarm Detect	FIRE ALARM	No	No	Input Clears
ABS Maintenance	ABS.MAINTENANCE	Yes	No	DM1 clears
Check ABS	CHECK ABS!	Yes	No	Msg clears
Alternator charging failure	CHARGING FAILURE	Yes	No	Binary input or flag turn off
Low Battery	LOW BATTERY VOLT.	Yes	No	12V voltage > 12V for 30sec or 24V voltage > 24V for 30sec
High Battery	HIGH BATTERY VOLT	Yes	No	12V voltage < 17V for 30sec or 24V voltage < 30V for 30sec
Check Diesel Particle Filter	DIESEL.PART.FILT..	Yes	No	Message clears
Change Diesel Particle Filter	DIESEL.PART.FILT.	Yes	No	Message clears
Low Primary Air Pressure	LOW.PRIMARY AIR	No	No	Air pressure ≥ 75 psi
Low Secondary Air Pressure	LOW.SECONDARY.AIR	No	No	Air pressure ≥ 75 psi

Settings and Diagnostic Screens

The Settings and Diagnostic screens can be accessed when the drive mode screen is displayed and the **M** button is pressed for longer than 5 seconds or if no CAN messages are seen then holding the **M** button will enter the menu.

Once in the Settings and Diagnostics menu, pressing the **M** or **T** buttons separately moves the reverse video highlight up or down through the list, as indicated by the arrows. The highlighted item is selected when both **M** and **T** buttons are pressed at the same time. If no button is pressed for 5 seconds, the LCD will go back to the standard Drive Screen. The items available in the menu are:

<p>1- Set Units 2- Contrast 3- Instrument Diag V Select ^</p>	<p>4- Engine Faults 5- Trans. Faults 6- UDS Faults V Select ^</p>	<p>7- Read Parameters 8- Brake Lining V Select ^</p>
---------------------------------------------------------------------------------------------------	-------------------------------------------------------------------------------------------------------	------------------------------------------------------------------------------

This menu exits to the drive mode screen when there has been inactivity for 5 seconds.

1 - Set Units

Selecting menu item 1 brings up the following screen that is used to select if values are to be displayed in metric units or English units. Pressing **M** or waiting 5 seconds exits to Settings and Diagnostics menu.

Current Units
ENGLISH
Press t for METRIC
Press m to Exit

2 – Contrast

Selecting menu item 2 displays a screen to allow setting the LCD contrast. Pressing the **M** (+) button will increase contrast while pressing the **T** (-) button will decrease contrast. After inactivity for 5 seconds this menu exits to the Settings and Diagnostics menu.

CONTRAST ADJUST
+ -

5-22 OTHER FEATURES

3 – Instrument Diag

Selecting menu item 3 in the Settings and Diagnostic menu will display the instrument diagnostic menu. There are 3 items in this menu and is navigated the same as the previous menu. This menu exits to the Settings and Diagnostics screen when there has been inactivity for 5 seconds.

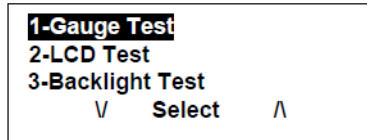

Gauge Test

Item 1 – The gauge pointer will be driven through three positions pausing at each position as shown in the LCD as a percentage of scale. This test will proceed and return to the Instrument Diagnostic menu. Pressing the **M** button will end the test and return to the Instrument Diagnostic menu.

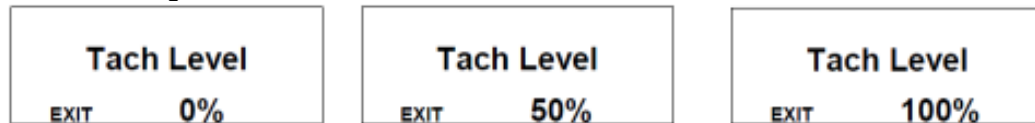

LCD Test

Item 2 –Displays the Prevost in normal then reverse video three times and then returns to the

Backlighting Test

Item 3 – Cycles the gauge and LCD backlight through 3 brightness levels twice displaying the corresponding intensity on the LCD. Pressing M during the test or allowing the test to complete returns the gauge to the Instrument Diagnostics menu.



4 – Engine Faults

For all ECU, an array is defined containing DTC, SPN & Specific FMI. If the SPN is not known, the value is displayed in decimal. For active faults, the array is filled with information obtained from DM1.

This screen displays DTC, SPN & associated FMI, otherwise, the Suspect Parameter Number (SPN) and Failure mode Identifier (FMI) as received from the engine for active faults via J1939.

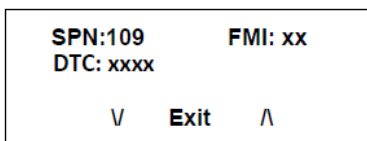

5 – Trans. Faults

For all ECU, an array is defined containing DTC, SPN & Specific FMI. If the SPN is not known, the value is displayed in decimal. For active faults, the array is filled with information obtained from DM1.

This screen displays DTC, SPN & associated FMI, otherwise, the Suspect Parameter Number (SPN) and Failure mode Identifier (FMI) as received from the transmission for active faults via J1939.

SPN:171 FMI: xx DTC: xxxx V Exit Λ

6 - UDS Faults (ACM, Aftertreatment System ECU)

For all ECU, an array is defined containing DTC, SPN & Specific FMI. If the SPN is not known, the value is displayed in decimal. For active faults, the array is filled with information obtained from DM1.

This screen displays DTC, SPN & associated FMI, otherwise the Suspect Parameter Number (SPN) and Failure mode Identifier (FMI) as received from the UDS (ACM) for active faults via J1939.

SPN:241 FMI: xx DTC: xxxx V Exit Λ

7 – Read Parameters

Selecting menu item 7 displays various parameters received by the rear gauge (engine RPM, boost pressure, engine load, transmission oil temp, engine coolant temp, engine oil pressure, primary air system pressure, secondary air system pressure, accessory air system pressure, fuel level, instantaneous fuel economy, average fuel economy, total engine hours, wheel based vehicle speed, gear engaged, 24V system voltage, 12V system voltage). The main use for these screens is in troubleshooting the system.

Eng RPM 775 RPM Boost Pr 5 Psi Eng Load 23 % V Exit Λ

Trans T 195 °F Coolant T 180 °F Oil Press 40 Psi V Exit Λ

Prim.Air 115Psi SecondAir 115Psi Acc Air 115Psi V Exit Λ

Fuel Level 74 % Inst Fuel 15.4 mpg Avg Fuel 12.6 mpg V Exit Λ

Hrs 123.45 hrs Speed 31.1 mph Gear Neutral V Exit Λ

24V Batt. 23.1V 12V Batt. 13.2V Eng RPM 775 RPM V Exit Λ

8 – Brake Lining (state)

Item 15 - A sub-menu is displayed to choose between 3 types of displaying:

- In 1/32 of inches
- In millimeters
- In %

Brake Lining in 1/32 inch Brake Lining in mm Brake Lining in %

The displaying in 1/32 of inches and millimeters requires two parameters:

- Corresponding value in 1/10 of millimeters for 100%
- Offset value in 1/10 of millimeters for 0%

5-24 OTHER FEATURES

The hardcoded value for these two parameters are:

Parameters	Default value (1/10mm)
100% value	150
0% value	50

The following message is displayed on the screen for showing the Brake Lining State, for a % displaying:

The front wheels are displayed on the left side of the screen, right side on the top. The value is expressed in % for each brake lining.

FR	DR	TR
FL	DL	TL

Brake Lining %		
100	53	43
98	55	42
<- FL Wheel Press m to Exit		

TRANSMISSION OUTPUT RETARDER

The transmission output retarder is a device that helps to reduce the speed of a vehicle. It improves vehicle control, increases driving safety and permits more economical operation. The retarder provides slowing power when it is most needed, such as when descending mountain roads, in stop-and-go traffic and on crowded freeways.

The transmission output retarder is a vehicle-slowng device, not a vehicle-stopping device. It is not a substitute for the service braking system. The service brake must be used to bring the vehicle to a complete stop.

NOTE

Extended use of transmission output retarder will raise the temperature of the transmission fluid.

The output retarder is provided with a switch located on the L.H. dashboard panel (refer to "CONTROLS AND INSTRUMENTS" section).

NOTE

Deactivating the transmission retarder will turn the indicator light located at the front of the coach ON.

Three levels of retarding power are available with the output retarder enabled: 1/3 of total retarding power is applied as soon as the brake pedal is pressed. If more force is applied to the brake pedal, 1/3 of retarding power is added. Finally, with full force applied to the brake pedal, an additional 1/3 of retarding power is added for a total of 100% of the available output retarding power.

Action	Retarding Power
Initial pressure on the brake pedal	33% of total retarding power
Additional pressure on service brake pedal	66% of total retarding power
Full force on the brake pedal	100% of total retarding power

NOTE

The stoplights automatically illuminate when the vehicle is slowing down after application of the transmission retarder.

NOTE

As the wheels start to lock up on slippery roads, the output retarder automatically deactivates until the wheels roll freely.

ANTILOCK BRAKING SYSTEM (ABS)

The purpose of the Antilock Braking System (ABS) is to maintain vehicle stability and control during braking and to minimize the stopping distance in any road condition.

On slippery roads and more generally in emergency situations, over-braking frequently induces wheel locking. Wheel locking greatly increases breaking distance on any road surface. Locked wheels also impede directional control and cause severe tire abrasion. An antilock braking system provides maximum braking performance while maintaining adequate control on slippery roads.

The basis of ABS is constant monitoring of wheel parameters during braking. Sensors on each wheel of the front and drive axles constantly measure wheel speed during braking. This information is transmitted to a four-channel electronic processor which senses when any wheel is about to lock. Modulating valves quickly adjust brake pressure (up to 5 times every second) to prevent wheel lock. Each wheel is therefore controlled according to the available grip.

In this way, the vehicle is brought to a stop in the shortest possible time while remaining stable and under the driver's control.



WARNING

Vehicles following ABS-equipped vehicles may not be able to brake as fast on slippery roads.

KNEELING SYSTEM

This system lowers the front end, enabling passengers to get on and off the coach without any difficulty.

NOTE

This coach is equipped with an interlock system which automatically applies the parking brake when the kneeling system is activated.

To operate, stop the coach, set the transmission to neutral (N), then push down the rocker switch located on the dashboard. (Refer to "Controls & Instruments" section). The parking brake will be applied automatically and a status line pictogram will appear on the DID to indicate that the front of the coach is being lowered.

To raise the front of the coach to its normal height, push up the rocker switch. The front end will rapidly rise up. The system will release the parking brake and shift the transmission to the previously selected range.



CAUTION

Avoid parking the coach too close to the sidewalk or to other obstacles which could damage the coach during kneeling.

NOTE

Kneeling is disabled when the entrance door is open.

NOTE

The kneeling system does not operate when the coach is traveling over 5 mph (8 km/h). Consequently, the driver cannot inadvertently operate the kneeling system at higher speeds.

UNLOADING TAG AXLE

To reduce the turning radius, the air springs pressure will be automatically reduced by 75% when the coach is moving at speed lower than 5 mph (8 km/h) and with more than 1½ turn from the steering.

RETRACTABLE TAG AXLE

The standard tag axle retraction system is controlled by a valve located in the front service compartment. The valve can be switched to either the WHEELS UP or WHEELS DOWN position. The axle will be raised or lowered by air pressure according to the valve position.

The tag axle service brakes operate only when the tag axle is in the WHEELS DOWN position. Never lower the tag axle while the coach is moving. When the tag axle is in the WHEELS UP position, the corresponding status line pictogram will appear in the DID. An audible alarm will sound to warn the driver if the vehicle speed exceeds 12 mph (20 km/h) with tag axle raised. The tag axle can be raised in tight maneuvering areas like in a parking lot or to make it easier to turn a short corner. The tag axle shortens the wheelbase and allows tighter turning. Raising the tag axle transfers extra weight and additional traction to the drive wheels providing improved control on slippery roads.



CAUTION

Do not use tag axle in raised position for an extended period. Raising tag axle increases load on the drive axle, suspension and tires.

Do not drive vehicle with tag axle raised when speed is exceeding 12 mph (20 km/h).

In order to prevent damage to the suspension, always raise the tag axle before lifting the coach.

IN-STATION LIGHTING

The in-station lighting system circuit is linked with the battery charger: When the charger is

5-26 OTHER FEATURES

connected to an external power source, the in-station lighting circuit can be energized without depleting the batteries.

The receptacle used for the battery charger is located on the engine compartment. R.H. side door.

WHEELCHAIR LIFT SYSTEM

Read and understand the RICON Service/Owner Manual before attempting to use the wheelchair lift. The instructions below are a quick reference and serve to complement the information provided by RICON.



WARNING

To operate the optional wheelchair lift, the coach must be parked on a flat and level surface, with the parking brake applied and the transmission in neutral gear.

Activate the lift mechanism circuit by pressing down on the wheelchair lift system power switch on the dashboard.

NOTE

Vehicle flashers will activate when pressing the WCL power switch.

WHEELCHAIR LIFT SYSTEM DOORS

To open the optional wheelchair lift access doors, the coach must be parked on a flat and level surface with the parking brake on. The wheelchair access door swings to the side and is maintained open by a locking mechanism. Open the wheelchair access door completely until it locks in the open position. To close the door, pull on the tab located on the inside of the door and slam the door shut.

Using the exterior compartment doors key, unlock and carefully lower the lift mechanism access door which is part of the baggage compartment door. The lift mechanism access door is located directly below the wheelchair access door. If the parking brake is not activated, a switch in the door will activate the parking brake when it detects the door is open. The wheelchair access door slides towards the front of the coach on the exterior side and is maintained open by a locking mechanism. Slide the wheelchair access door completely until it locks in the open position at the end of stroke.

To close the door, pull on the handle to release the locking mechanism and slide back the door in closed position.

NOTE

The wheelchair access door must be completely opened for the WCL to operate.

A light inside the vehicle illuminates the doorway when the wheelchair access door is open.

A pictogram appears on the DID when the lift mechanism access door or the wheelchair access door is open. Refer to Controls and Instruments section.

When either the lift mechanism access door or the wheelchair access door is open, the parking brake cannot be released and the transmission gear selector will not register any gear selection.

NOTE

The activation switch must be in the ON position for this interlock feature to be in effect.

If in motion and the access door opens, a telltale light will illuminate and an audible alert will sound.

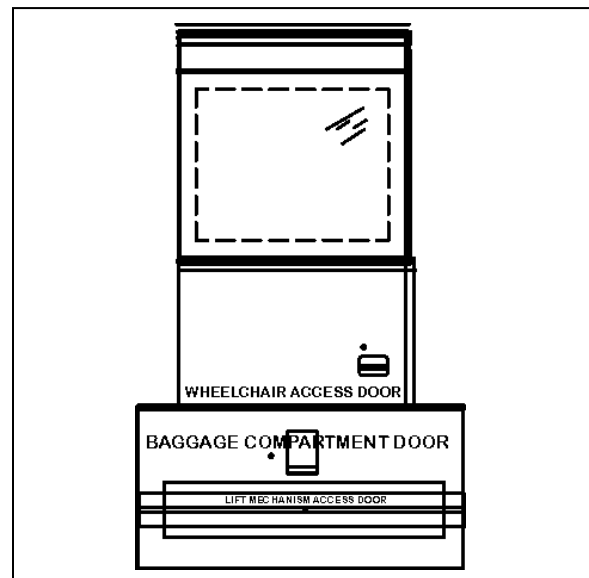

WHEELCHAIR LIFT SYSTEM DOORS

18615

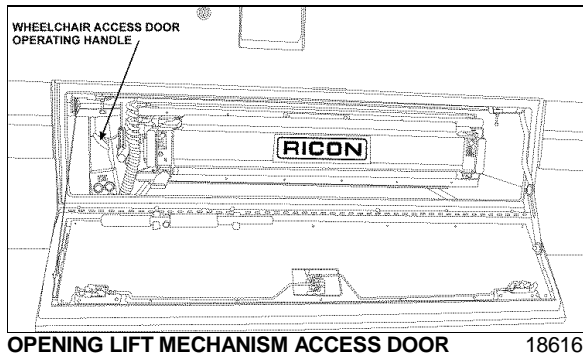

BEFORE OPERATING THE WHEELCHAIR LIFT

- Before operating lift, be certain vehicle is safely parked on a level area away from traffic. Provide at least 10 feet (3 meters) space for lift operation and passenger boarding.
- The lift operator must take special care to ensure that area is clear before deploying platform. Be certain there are no obstacles beneath platform.
- Open lift mechanism access door completely and secure.
- The vehicle and lift are equipped with a safety interlock system (i.e. transmission into neutral, parking brake applied). Be certain that it is in the proper mode before attempting to operate lift. The lift will not operate until this feature has been properly engaged.
- Turn on wheelchair lift power switch located on the dashboard.
- Enable lift control pendant by turning on Power switch located on pendant.
- A person that uses the wheelchair lift while standing (does not require mobility aid equipment) is referred to in this manual as a Standee.

Normal Lift Operation – To Enter Vehicle

1. **ACTIVATE INTERLOCK:** Set parking brake, place transmission in neutral.
2. **DEPLOY PLATFORM:** Buckle safety belt. Press and hold DEPLOY button until platform is fully deployed. NOTE: Platform cannot be moved up or down unless platform is fully extended.
3. **RAISE HANDRAILS:** Lift right handrail to vertical and push firmly down into its socket.

Repeat for left handrail. Verify that both handrails are latched in place by attempting to pull upward on them.

4. **LOWER PLATFORM:** Press and hold DOWN button until platform stops at ground level and rollstop opens completely.
5. **BOARD PLATFORM:** Position wheelchair in center of platform, facing outward if possible, and advise occupant to lock wheelchair brakes. Power should be turned off on electric-powered wheelchairs. Standee must stand near the center of the platform, facing in the direction of travel (into vehicle), and firmly grasp handrails. Do not stand on bridgeplate.
6. **BUCKLE SAFETY BELT.** Pull safety belt from retractor on left handrail and fasten to other handrail.
7. **PARTIALLY RAISE PLATFORM:** Press and hold UP button until platform stops at intermediate height.
8. **OPEN VEHICLE DOOR:** Fully open vehicle sliding door located above lift. The lift operator, or attendant should do this.
9. **RAISE PLATFORM:** Press and hold UP button until platform stops at floor height and bridgeplate lowers onto vehicle floor.
10. **EXIT PLATFORM:** Advise passenger to carefully enter vehicle.
11. **LOWER HANDRAILS:** Press release button at base of handrail and lift the left handrail upward out of its socket. Lower handrail to platform. Repeat for right handrail. Buckle safety belt.
12. **STOW PLATFORM:** Press and hold STOW button until platform reaches STOW height and then fully retracts into vehicle.

NOTE: Do not use DOWN button to lower platform partway prior to stowing, and then complete the stowing process by using IN button. This method may not properly stow platform.

Normal Lift Operation – To Exit Vehicle

1. **DEPLOY PLATFORM:** Press and hold DEPLOY button until platform is fully deployed.
2. **RAISE HANDRAILS:** Lift right handrail to vertical and push firmly down into its socket. Repeat for left handrail. Verify that both

5-28 OTHER FEATURES

handrails are latched in place by attempting to pull upward on them.

3. **BUCKLE SAFETY BELT.** Pull safety belt from retractor on left handrail and fasten to other handrail.
4. **PARTIALLY RAISE PLATFORM:** Press and hold UP button until platform stops at intermediate height.
5. **OPEN VEHICLE DOOR:** Fully open vehicle sliding door located above lift. The lift operator, or attendant should do this.
6. **RAISE PLATFORM:** Press and hold UP button until platform stops at floor height and bridgeplate lowers onto vehicle floor.
7. **BOARD PLATFORM:** Position wheelchair in center of platform, facing outward if possible, and advise occupant to lock wheelchair brakes. Power should be turned off on electric-powered wheelchairs. Standee must stand near the center of the platform, facing in the direction of travel (out of vehicle), and firmly grasp handrails. Do not stand on bridgeplate.
8. **LOWER PLATFORM:** Press and hold DOWN button until platform stops at ground level and rollstop opens completely.
9. **UNBUCKLE SAFETY BELT.**
10. **EXIT PLATFORM:** Carefully assist passenger off of platform.
11. **LOWER HANDRAILS:** Press release button at base of handrail and lift the left handrail upward out of its socket. Lower handrail to platform. Repeat for right handrail. Buckle safety belt.
12. **STOW PLATFORM:** Press and hold STOW button until platform reaches STOW height and then fully retracts into vehicle.

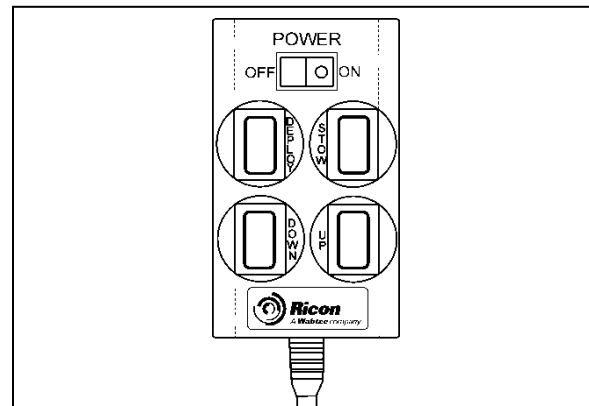
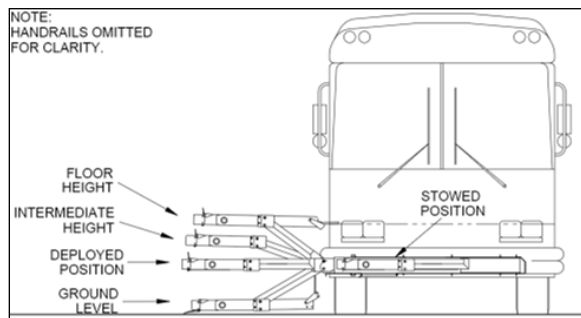

CONTROL PENDANT

23421



WARNING

Inspect the lift before each use as described in the RICON Owner's manual. If any unsafe condition exists, or if unusual noises or movements are noticed, DO NOT use and contact an authorized RICON dealer for repair.



WARNING

Read and comply with all warning labels and symbols affixed to the wheelchair lift.



WARNING

Do not operate with a load in excess of 660 lbs (300 Kg).

NOTE

The restraint belt acts as a safety device and it prevents raising or lowering the lift when not buckled.



WARNING

Use extreme care when rolling on or off the platform and lock the wheelchair brakes while stationary on the platform. Make sure the wheelchair fits safely on the platform. Keep arms and legs away from moving parts.

NOTE

The indicator light on the control device illuminates when power is supplied (when the lift electrical circuit is activated by the power switch on the dashboard).

THRESHOLD WARNING SYSTEM (TWS) ADJUSTMENT

There are three verifications to perform; 1) Adjust Aiming of Acoustic Sensor Beam, 2) Test Aim of Acoustic Sensor Beam, and 3) Adjust Acoustic Sensor Timing.

Adjustment of the sensor timing is done at the factory and should not need to be repeated in the field. Readjustment should only be considered if the sensor aiming could not be adjusted to ignore both the wheelchair in the aisle and the platform during its normal movement.

Adjust Aiming of Acoustic Sensor Beam

1. Place wheelchair with passenger in center aisle of coach, pointed at doorway where Threshold Warning System (TWS) is installed. The TWS should not detect a wheelchair and passenger when they are located this far from doorway.
2. Turn power to lift on (LED on TWS module will light steady) and indicator light on the control device illuminates. If wheelchair and passenger are detected by acoustic sensors the LED will flash, the buzzer will sound and the module red light will flash. If this occurs it is necessary to adjust aiming of sensors.

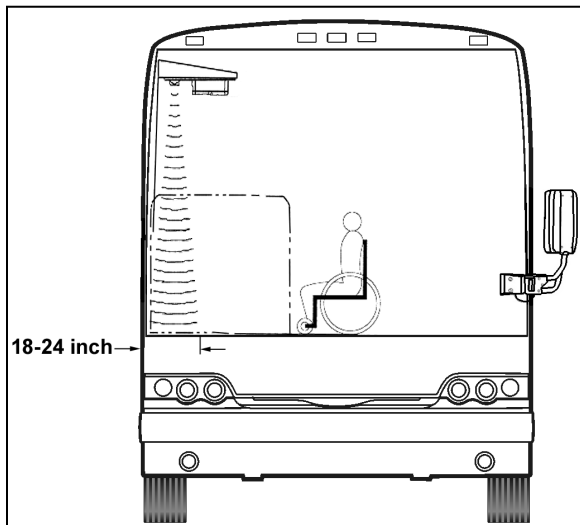

TWS AREA 23371

3. Turn sensor angle adjustment screw clockwise to move direction of beam away from center aisle and towards doorway. Stop adjustment when LED ceases to flash.

NOTE
Only in rare instances will adjustment be needed in the counterclockwise direction.

4. Move centerline of small wheels of wheelchair (with passenger) to within 24 inches of doorway and repeat aiming procedure in previous step.

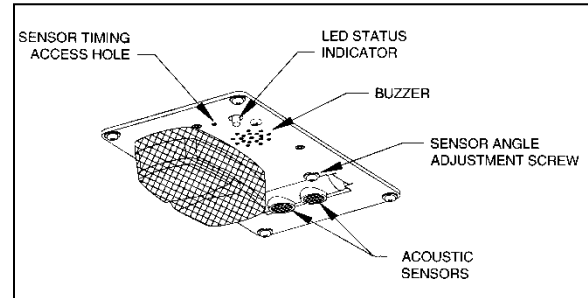

TWS MODULE DETAIL 23368

Test Aim of Acoustic Sensor Beam

1. Move wheelchair and passenger slowly towards doorway. TWS should detect wheelchair and passenger (LED will flash, buzzer will sound and the module red light will flash) when centerline of front wheels is between 18 and 24 inches from doorway.
2. Open vehicle access door above lift. Lower platform to ground and place wheelchair and passenger at rear of platform. Bridgeplate should be up. Raise platform to floor level. This normal platform motion with wheelchair and passenger aboard should not actuate TWS. If LED does flash (buzzer will also sound and module red light will flash), turn sensor adjustment screw slightly counterclockwise.

NOTE
If an adjustment is made, repeat the previous step where wheelchair is between 18 and 24 inches from doorway.

Adjust Acoustic Sensor Timing

1. Support a flat sheet of cardboard or similar material, directly beneath TWS module at a distance of 4½ feet below module. Sheet must be facing sensors.

NOTE
Before proceeding, visually inspect sensors to verify that they are pointing directly at floor, or nearly, and are not pointing off at an extreme angle.

5-30 OTHER FEATURES

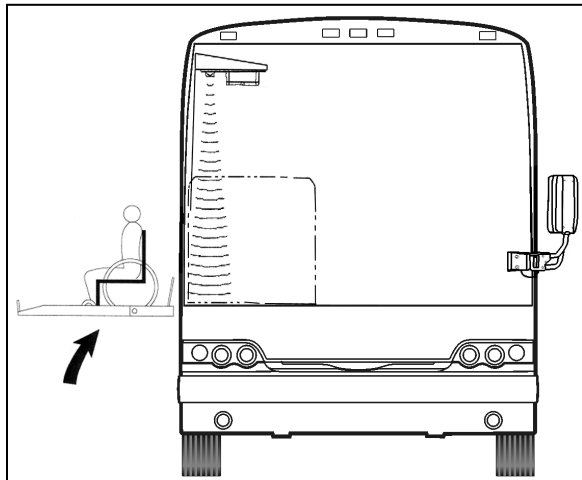

CHECKING NORMAL PLATFORM POSITION 23372

- Note the sensor timing access hole. This hole provides access to a plunger-actuated switch that sets the sensor timing. Insert a 1/16-inch diameter wire-like object into the access hole and press the plunger inward. The LED will flash momentarily while the module establishes the distance and then remain on steady. Release the plunger when the LED ceases to flash.

NOTE

It is important that objects, such as your body, tools, seats, etc., do not interfere with the beam while the adjustment is being made.

INTERIOR APPOINTMENTS

To accommodate a wheelchair, one row of regular seats must be folded and two rows of regular seats must be folded and slid away on one side of the coach. Seats may be folded on both sides of the coach to make room for a second wheelchair.

An electrical wheelchair or tri-wheeler may require sliding back seats from both sides of the coach to allow enough turnaround space.

Before reconfiguration of the seats, refer to instructions labels and placards on the actual seats.

Refer to the information on the actual seats for detailed passenger and wheelchair securement instructions.

Instructions labels and placards on the actual seats take precedence over any instructions in this manual.

To fold a set of seats, pull on cushion latch lever to lift and lock the seat cushion up.

(Refer to image)

To slide, fully lift the hand-operated release lever then slide the seat along the track according to suggested method on the seats.

Depress the foot-operated lock pedal to lock the seat in place.

Rotate aisle side armrest upwards.

The wheelchair occupants have a stop request and a reading light switch at their disposal on the window sill of the coach, within easy reach.

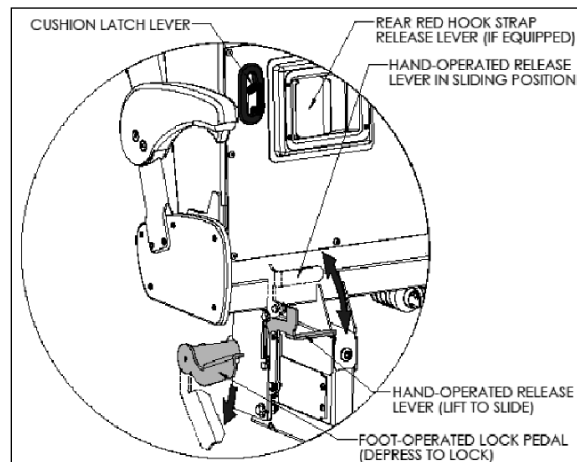

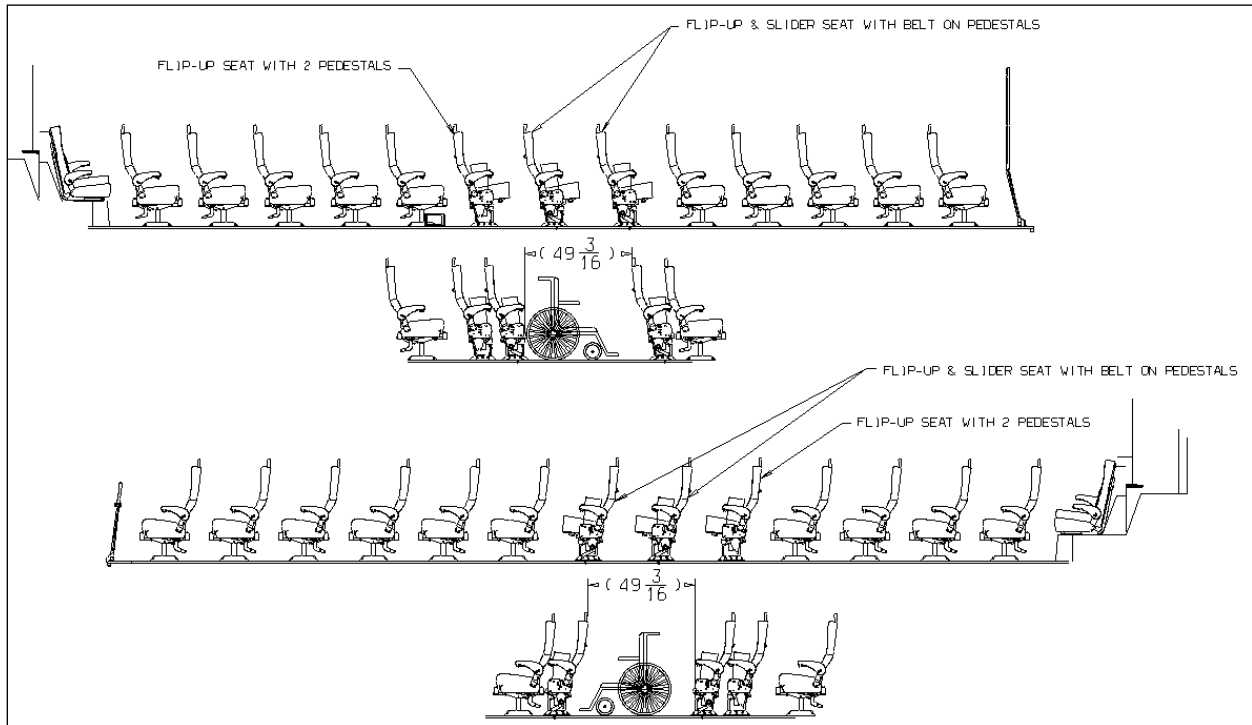

POSSIBLE SEATING ARRANGEMENTS

Wheelchair Restraint System

This 4-point anchoring system includes four retractors with restraint hook belts (red) located at the base of passengers seats. They must be placed at all four corners to secure the wheelchair frame. Separate blue “scooter belts” are provided to accommodate various wheelchair styles.

Refer to the information labels and placards on the actual seats for detailed proper securement instructions.

Instructions labels and placards on the actual seats take precedence over any instructions in this manual.

Wheelchair Occupant Restraint

The occupant restraint belt includes a black lap belt and a black shoulder belt with a tongue that attaches on the lap belt stud.

Refer to the information on the actual seats for detailed proper securement instructions.

Instructions labels and placards on the actual seats take precedence over any instructions in this manual.

must always be located on aisle side.

WARNING

A snug fit with the lap belt positioned low on the hips is necessary to maximize safety. The belt should not be worn or twisted. Avoid pinching the belt and/or hardware. Do not wear over rigid or breakable objects such as eyeglasses, pens or keys as these may cause injuries.

WARNING

Do not let restraint or safety belts rub against sharp edges. Do not bleach or dry clean.

EMERGENCY OPERATION

In the event of electrical power loss, manual operation of the lift is possible as explained below. It is recommended that manual operation be used only to exit from vehicle, not to enter vehicle.

To manually deploy the platform

Allow enough space for lift operation and passenger boarding. If a break down situation exists and the vehicle cannot be moved so that

CAUTION

Lap belt buckle including belt release button

5-32 OTHER FEATURES

the lift system can be operated safely, the operator must summon emergency assistance to move the vehicle before operating the lift.

1. Fully open wheelchair access and lift doors. Ensure that there are no obstacles in the path of the lift.

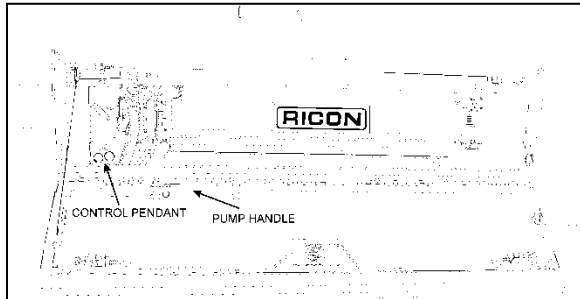

WHEELCHAIR LIFT MANUAL OPERATION

23375

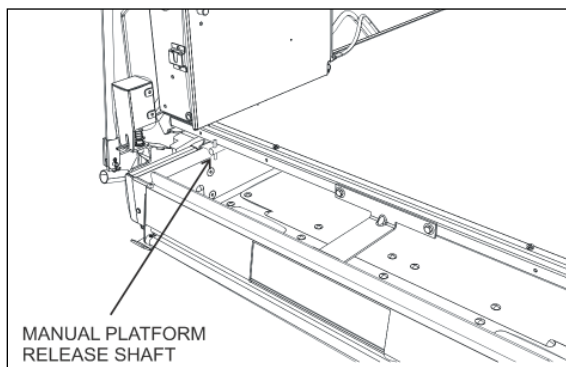

MANUAL PLATFORM RELEASE SHAFT

23334

2. Remove the pump handle from inside the lift mechanism access door.

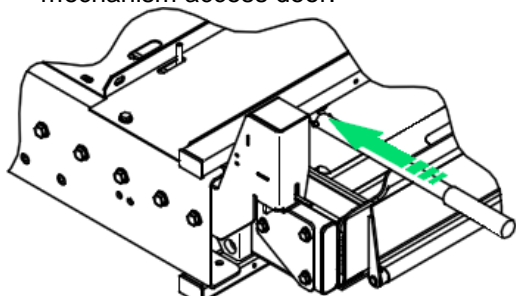

3. Turn the manual platform release shafts using pump handle extension to disengage the platform and then lift the stowlock mechanical catch.

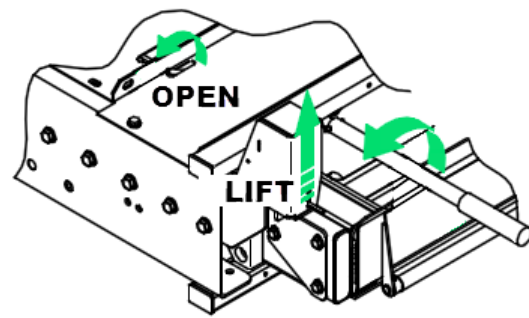

4. Grasp the platform and pull firmly until the lift is all the way out against the carriage stops.

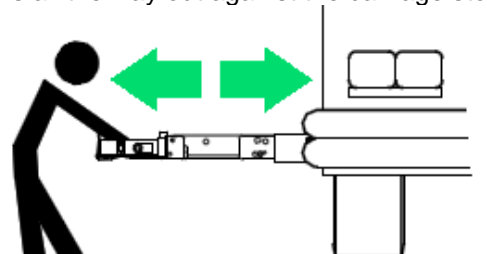

5. Turn the manual platform release shafts using pump handle extension back to previous position to lock the platform.

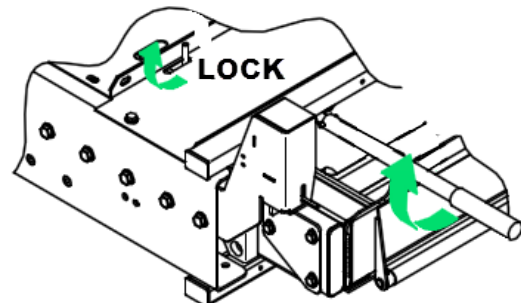

6. Lift right handrail to vertical and push firmly down into its socket. Repeat for left Handrail.

To manually raise the platform

1. Remove the pump handle from inside the lift mechanism access door.
2. Close the pump release valve by pushing the actuating rod DOWN (pumping the handle raises the platform when the release valve is closed).

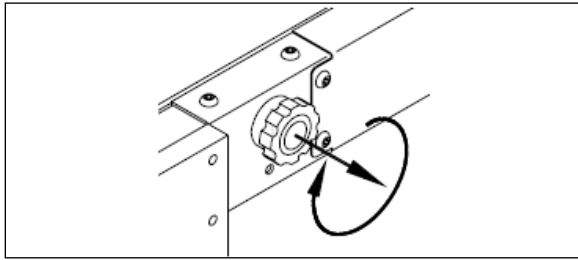

CLOCKWISE ROTATION CLOSSES ROLLSTOP 23275

3. Verify that rollstop is up (closed). Pull rollstop control knob out and rotate fully clockwise, if it isn't up.
4. Insert handle extension into manual backup pump handle socket and pump to raise the platform to the vehicle floor level.

	<p>CAUTION</p>
<p>During manual rising of the lift, do not raise the platform more than 1-1/2 inches above the vehicle floor level. Any excessive travel will make it difficult to enter the platform and/or damage the lift bridge plate actuator. The outer edge of the bridge plate must rest squarely on the vehicle floor.</p>	

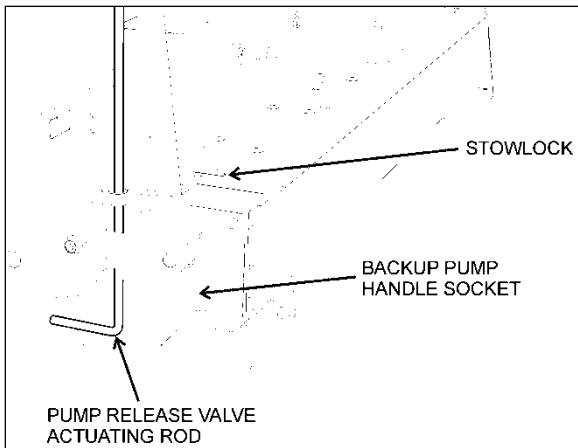

WHEELCHAIR LIFT MANUAL HYDRAULIC PUMP 23373

5. The lift passenger and attendant must follow the instructions to ENTER or EXIT the vehicle, as previously described.

To manually lower the platform

1. Verify that rollstop is up (closed). Pull rollstop control knob out and rotate clockwise, if it isn't up.
2. Slowly pull the pump release valve actuating rod UP until the platform begins to lower (opening the release valve lowers platform).

3. Allow the platform to reach ground level.
4. Push the pump release valve actuating rod back DOWN until lightly-snug.
5. Using the rollstop manual control knob, OPEN the rollstop. Pull rollstop control knob out and rotate fully counterclockwise. Rollstop must lie flat on ground.

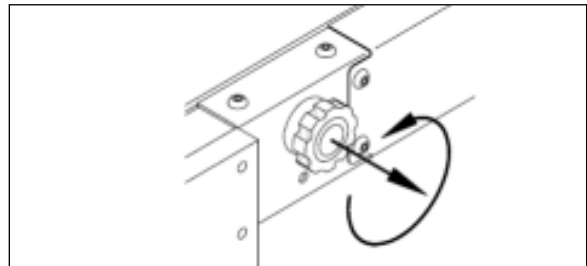

COUNTERCLOCKWISE ROTATION OPENS ROLLSTOP

6. The attendant and lift passenger should follow the instructions to ENTER or EXIT the vehicle, as described previously.

To manually stow the platform

1. Detach the restraint belt, lift each handrail up to unlock and fold handrails. Re-fasten restraint belt.
2. Raise or lower the platform to the deploy/stow position; the platform frame must be parallel to the side of the lift enclosure. If the exact position cannot be obtained, slightly low is preferred to slightly high.
3. Using the rollstop manual control knob and one hand on the rollstop, close the rollstop until it latches.
4. Turn the manual platform release shafts using pump handle extension to disengage the platform.
5. Use one person on each side of the lift to prevent mechanical binding.
6. With fingers up and palms forward, push the platform forcefully to start the lift moving inward. As the lift begins to move inward, maintain a constant pushing motion until the lift comes to rest completely inside the lift enclosure.
7. Push firmly and make sure that the platform manual release shafts have turned to lock the platform.

5-34 OTHER FEATURES

WHEELCHAIR LIFT REMOVAL FOR STORING OR MAINTENANCE PURPOSES

Disconnect connector located at compartment ceiling.

Remove 4 fixing bolts located inside compartment, on each side of platform.

Grasp the platform and pull firmly, sustaining a constant pull so that the platform slides onto the rails until the carriage come in contact with the stops.

Pull the platform until the rear carriage hit against the stops.

Remove platform completely.



WARNING

For better stability, keep the platform at minimum height when moving.



WARNING

Before moving platform, make sure that floor is level and free of obstacles.

WHEELCHAIR LIFT INSTALLATION

Raise the platform to proper level.

Insert the platform so that the rear carriage clears the stops.

Insert the platform until the front carriage clears the stops.

Lower the front of the platform.

Push firmly and make sure that the platform manual release shafts have turned to lock the platform.

Secure the 4 fixing bolts located inside compartment, on each side of platform. **Apply a torque of 60 lbf-ft.**

Reconnect connector located at compartment ceiling.



WARNING

When re-inserting platform into compartment, make sure that carriage wheels are properly aligned over the L. H. side triangular rail.

SECTION 6 STARTING AND STOPPING PROCEDURES

IGNITION SWITCH	2
STARTING THE ENGINE	2
STARTING FROM THE DRIVER'S SEAT	2
<i>STOPPING THE ENGINE</i>	3
STARTING FROM THE ENGINE COMPARTMENT	3
<i>STOPPING THE ENGINE</i>	4
COLD WEATHER STARTING	4
JUMP STARTING	5
ENGINE PROTECTION SYSTEM	5
AUTOMATIC ENGINE SHUTDOWN	6
IDLE SHUTDOWN TIMER	6
ENGINE WARM-UP	6
ALLISON TRANSMISSION WARM-UP	6

6-2 STARTING AND STOPPING PROCEDURES

IGNITION SWITCH

Coaches are equipped with an ignition lever instead of an ignition key. Use the ignition lever to activate the electrical circuit by turning it to the ON position.

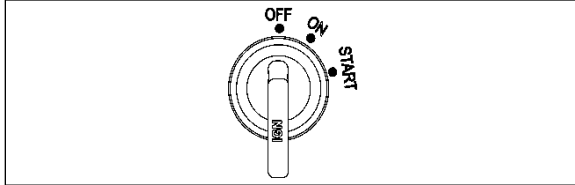

IGNITION SWITCH POSITIONS

06354



CAUTION

When the vehicle is parked overnight or for an extended period of time, the ignition switch should be set to the OFF position.

NOTE

When the battery master switch is set to the OFF position, all electrical supply from the batteries is cut off, with the exception of battery equalizer check module, ECM ignition and power supply, Allison TCM power, entrance door and fire alarm.

NOTE

Depending on vehicle, communication radio system power is supplied either directly from battery OR only with engine running. Refer to wiring diagram for details.

The ignition switch doubles as the battery master switch. Any position other than OFF activates the electrical circuits. Electrical circuits are also activated when the hazard switch is depressed. Two auxiliary master switches in series with the ignition switch are installed on the vehicle; one is located on the rear electrical panel and one in the engine compartment on the rear start panel, for maintenance ease.

The ignition switch is located on the lower left side of the dashboard. It has three positions:

Off - In the OFF position, ignition cannot take place.

The electrical circuits are not activated when the switch is in this position. Only the accessories connected directly to the batteries can be activated. Maintain the switch in this position when parked overnight or for an extended period.

On - Turn the lever clockwise to the first position to place the ignition switch to ON. Do not leave the lever in this position unless the engine is running.

Start - Use this position to crank the engine. The ignition switch is equipped with a starter protection which inhibits turning the lever to the START position if the lever has not previously been turned to the OFF position.

STARTING THE ENGINE

In normal circumstances, the engine should be started from the driver's seat. However, a rear-start panel in the engine compartment permits starting the engine from that location, mainly for maintenance purposes.

STARTING FROM THE DRIVER'S SEAT

1. Make sure the rear start selector switch located in the engine compartment is set to the NORMAL position and that the battery master switch (master cut-out) located on the rear electrical panel is set to the ON position.



REAR ELECTRICAL PANEL IN R.H. ENGINE COMPARTMENT

06621_1

2. Make sure the parking brake is applied, if not, apply the parking brake by pulling the parking brake control button all the way up.

NOTE

An electronic protection will prevent the engine from starting if the parking brake is not applied.

3. Turn ignition switch to ON and wait a few second;

NOTE

When the ignition is turned to ON, the M32QR ABS Pressure Modulator Valve solenoids are briefly energized. This can be audibly detected by a rapid cycling of the PMVs. If the air system is fully charged and the service brake pedal is depressed when ignition is turned to ON, the modulator valves create a sharp audible "chuff" of air pressure.

4. The transmission pushbutton shift selector automatically selects neutral (N) when the ignition switch is turned to ON;
5. With your foot off the accelerator pedal, turn ignition switch to START position, release the ignition switch after the engine starts. If the engine did not start, return the ignition switch to the OFF position before trying to restart the engine;
6. Brake pedal must be applied when selecting Drive (D) otherwise the transmission will stay in neutral (N).



CAUTION

Do not engage starter for more than 15 seconds at a time. If engine does not start within 15 seconds, release ignition key and let starter cool for one minute before attempting to restart.



CAUTION

Do not press accelerator pedal before starting. This could result in an electronic control unit fault and degrade the fuel system control.



CAUTION

Special precautions are necessary with turbocharged engines to avoid possible turbine damage. After starting, run the engine at normal idle for two minutes to allow lubricating oil to reach the turbocharger then run the engine at fast idle. Let oil pressure reach normal operating range before driving.

NOTE

If engine does not start, return key to OFF position before attempting to restart.

NOTE

If the accelerator pedal is depressed before starting, release and wait 30 seconds before attempting to restart.

Stopping the Engine

1. Apply parking brake and place transmission in neutral (N);
2. Allow engine to idle for at least two minutes before shutting engine OFF. This insures that the turbine speed drops and allows time for the engine exhaust gas temperature to drop to about 300°F (150°C);
3. Shut off all electrical loads;
4. Turn the ignition switch to the OFF position.



CAUTION

Do not shut OFF engine when running above normal idle.



CAUTION

Turn the battery master switch (master cut-out) to the OFF position after parking and when left unattended for an extended period of time.

STARTING FROM THE ENGINE COMPARTMENT

Switches to start and stop the engine from inside the engine compartment are mounted on a small panel above the air filter.



DANGER

Apply parking brake and place transmission in neutral (N) before starting engine from inside the engine compartment.

6-4 STARTING AND STOPPING PROCEDURES

1. Turn the battery master switches (ignition and master cut-out) to the *ON* position;



BATTERY MASTER SWITCH

2. Flip the starter selector switch to the *REAR START* position;

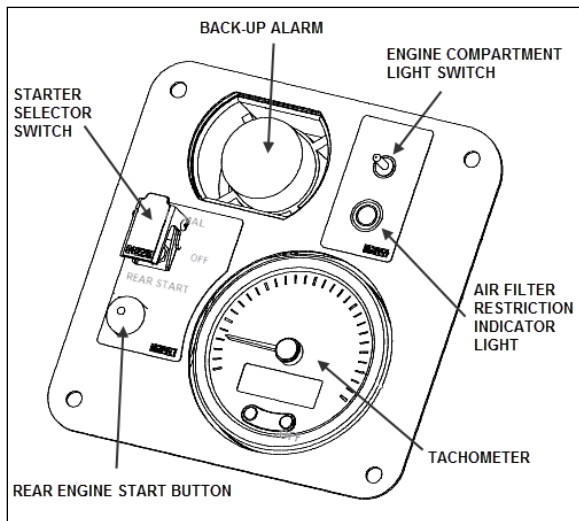

REAR START PANEL

06622_1

3. Press the *REAR START* push-button switch, release push-button after the engine starts.



DANGER

Do not wear loose clothing when working near engine. Stand clear of rotating components.



CAUTION

Refer to cautions in "Starting From The Driver's Seat" in this section



DANGER

Rotating shafts can be dangerous. You can snag cloths, skin, hair, hands, etc. This can cause a serious injury or death. Do not work on a shaft (with or without a guard) when the engine is running.

Stopping the Engine

To stop the engine from the engine compartment, flip the starter selector switch to the - position.



DANGER

Make sure parking brake is applied and entrance door interlock is not canceled before stopping the engine.



CAUTION

Do not stop engine by any other method.

COLD WEATHER STARTING

When starting a cold engine, the intake air should be warmed up by using the intake air preheater. Turn the ignition switch to the *ON* position. The preheater will not engage at coolant temperature above 54°F (12°C). If the coolant temperature is below 54°F (12°C), the preheater will engage and will light the preheater telltale between 0 and 50 seconds, depending on the engine coolant temperature. Wait before the preheater telltale has turned off before starting the engine.

If necessary, once the engine has started, the preheater will reengage (post heating) for the same length of time as the preheat time.





DANGER

Do not use ether or other combustibile starting aid fluid on any engine equipped with an intake air preheater. If the engine is equipped with a preheater, introduction of ether or similar starting aids could cause a fire or explosion resulting in severe property damage, serious personal injury or death.

JUMP STARTING

In order to avoid damage to solid-state electrical components, it is important that jumper (booster) cables be used correctly and only in emergencies. To jump start, use another 24 volt DC, negative grounded, power source. Use only jumper cables rated at 500 cranking amperes.

 **DANGER**
 Injury, explosion, battery acid damage or charging system overload may result if these jump starting procedures are not precisely followed.

 **WARNING**
 Wear eye protection and remove rings, metal jewelry and watches with metal bands.

 **DANGER**
 The gases given off by batteries while jump starting are explosive. Do not smoke near batteries.

 **CAUTION**
 Do not let the two vehicles touch. Keep a walk-through distance between the two vehicles. Make sure positive (red) and negative (black) jumper cable clamps do not touch.

 **CAUTION**
 Never connect the jumper cable to the negative terminal post of the run-down battery.

 **WARNING**
 Before attempting to jump start, make sure the parking brake is applied and the transmission is in neutral (N). Turn off all lights, heaters and other electrical accessories.

 **CAUTION**
 Choose a booster vehicle which produces comparable amperage as your vehicle.

To jump start, proceed as follows:

1. Remove the protective plug from the booster block bulkhead connector located in the engine curbside compartment;
2. Connect to the bulkhead connector. If the boosting battery is in another vehicle, that vehicle's engine must be shut OFF before connecting;
3. Disconnect the jumper cable.
4. Install protective plug on the booster block terminal.

NOTE
Jumper cables must be rated at 500 cranking amperes. If jumper cable length is 20 feet (6 m) or less, use 2/0 (AWG) gauge wires. If cable length is between 20 to 30 feet (6 to 9 m), use 3/0 (AWG) gauge wires.

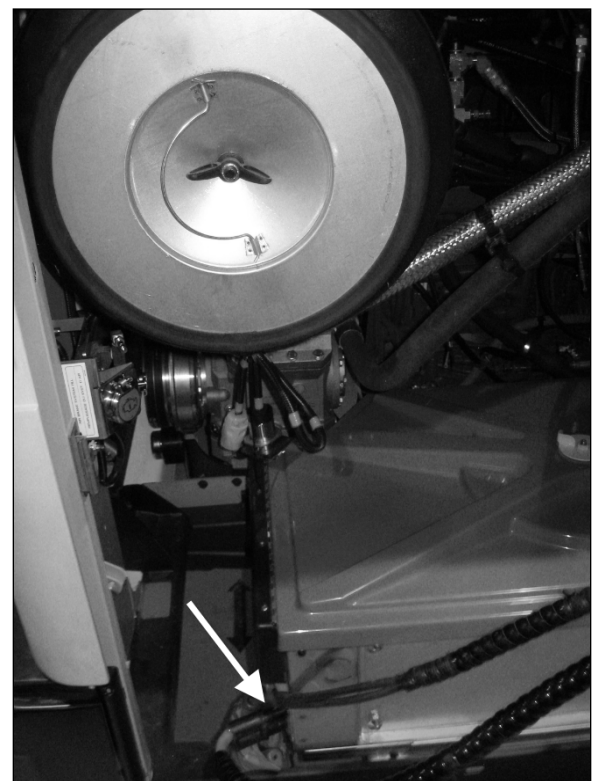

BOOSTER BLOCK LOCATION

ENGINE PROTECTION SYSTEM

The engine protection will automatically derate or stop the engine when certain engine conditions reach a critical stage.

6-6 STARTING AND STOPPING PROCEDURES

In the event of a serious fault, the red STOP telltale light comes on and an audible alarm will sound if the engine is running.



An illuminated STOP telltale light indicates a serious problem has been detected, and the driver must respond immediately to the problem. The vehicle must be safely pulled off the road and stopped. In some instances, the engine must be switched off immediately.

AUTOMATIC ENGINE SHUTDOWN

Prior to an actual automatic shutdown, the engine will automatically derate, go to idle, and then stop as the vehicle speed gets below 2 mph.

The engine shutdown protection will automatically derate and stop the engine when one or more of the conditions listed below reaches a critical point:

- High engine coolant temperature
- High engine oil temperature
- Low engine oil pressure
- High crankcase pressure (rate of change)

After the automatic engine shutdown sequence, the engine may be restarted. To do so, turn the ignition switch to the OFF position during 7 seconds and then turn it back to ON. However, it will only operate for 30 seconds unless the problem is resolved.

Use this function sparingly and in order to move the vehicle to a safe parking place only. Excessive use may result in severe engine damage.



WARNING

Failure to take necessary action when the STOP telltale light is on can ultimately result in automatic engine derate and shutdown.

IDLE SHUTDOWN TIMER

The idle shutdown timer is programmed to shut down the engine after 15 minutes of engine idling time.

The engine will shut down at the set time under the following conditions:

- Vehicle speed is 0;
- Engine is running at normal or fast idle speed;
- The engine coolant temperature is above 120°F (49°C);
- The temperature inside the vehicle is between 59°F (15°C) and 81°F (27°C);
- The parking brake is applied;
- The transmission is in neutral (N);
- The wheelchair lift system is not in use;

Pressing the fuel pedal will prevent engine shutdown and restart countdown.

ENGINE WARM-UP

After starting the engine, keep the parking brake applied and let the engine run at normal idle for two minutes to allow lubricating oil to reach the turbocharger. Increase engine speed to fast idle, using the FAST IDLE switch located on the dashboard for five minutes, without loading the engine. Monitor the gauges and indicator lights to make sure all conditions are normal. If an abnormal condition is observed, stop the engine immediately and have the condition corrected.



DANGER

Never let the engine run in an enclosed, non-ventilated area. Engine exhaust fumes contain dangerous gases which can be fatal if inhaled. Before warming up the engine, open the door(s) or move the vehicle outside.

NOTE

The engine will reach normal operating temperature shortly after driving. Avoid driving at full throttle until engine coolant temperature reaches 140°F (60°C).

ALLISON TRANSMISSION WARM-UP

When the transmission temperature falls below -20°F (-29°C), the CHECK telltale light illuminates after the engine is started, and a reminder tone will sound. In this case, the transmission will be locked in neutral (N) until the transmission temperature rises above -20°F (-29°C) and the CHECK telltale light goes out. The transmission will only operate in first or reverse gears until it reaches normal operating temperature.

SECTION 7 SAFETY FEATURES AND EQUIPMENT

EMERGENCY EXITS	2
SIDE WINDOWS.....	2
ROOF HATCH.....	2
EMERGENCY ENTRANCE DOOR OPENING.....	3
EMERGENCY EQUIPMENT	3
FIRE SUPPRESSION SYSTEM (AFSS).....	3
<i>STARTING THE VEHICLE AFTER TRIGGERING OF A FIRE ALARM</i>	5
FIRE EXTINGUISHER	5
WARNING REFLECTORS	5
HOISTING, JACKING POINTS	5
TOWING	5
EMERGENCY AIR-FILL VALVES AND QUICK CONNECTOR FITTINGS	5
EMERGENCY AND PARKING BRAKES	6
DAYTIME RUNNING LIGHTS	6
COMPARTMENT LIGHTING	7
BACK-UP ALARM	7
ESSENTIAL FUNCTIONS TO OPERATE THE VEHICLE (BASIC LIMP-HOME FUNCTIONS)	7
AVAILABLE FUNCTIONS.....	7

7-2 SAFETY FEATURES AND EQUIPMENT

EMERGENCY EXITS

Locate and learn how to use all possible emergency exits. It is good practice to inform passengers of the location of exits and how to use them in case of an emergency.

SIDE WINDOWS

Some side windows can be opened from the inside for emergency exit. A riveted tag located on the bottom of each passenger window indicates the location of the nearest emergency exit.

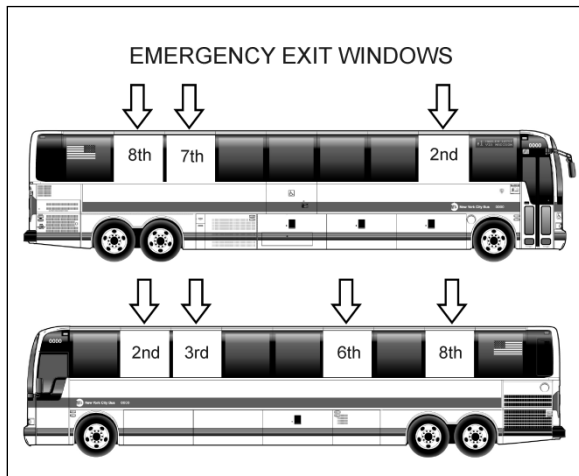

EMERGENCY EXIT WINDOWS (X3-45)

18617_2

To open a side window emergency exit, tilt up the release bar and push the bottom of the window outwards, as illustrated below. The window is hinged from the top and will not fall out.

To close the window, tilt up the release bar and pull the window back. Push down the release bar to lock shut.

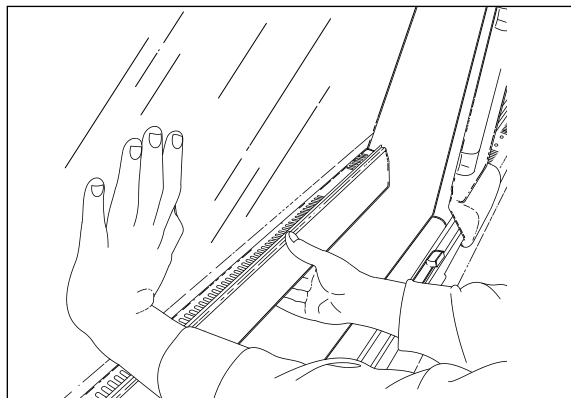

SIDE WINDOW EMERGENCY EXIT

18391

ROOF HATCH

A roof ventilation hatch, designed to be opened by occupants is installed in the roof at the rear of the vehicle. Another roof hatch is located in the front of the vehicle. The hatches can serve as emergency exits. In case of an emergency, push the ventilation hatch upwards (1). Turn knob $\frac{1}{4}$ turn (arrow pointing "TO EXIT") and then push knob to release the hatch (2). Push the escape hatch outwards (3). A decal with operating instructions is located on the hatch.

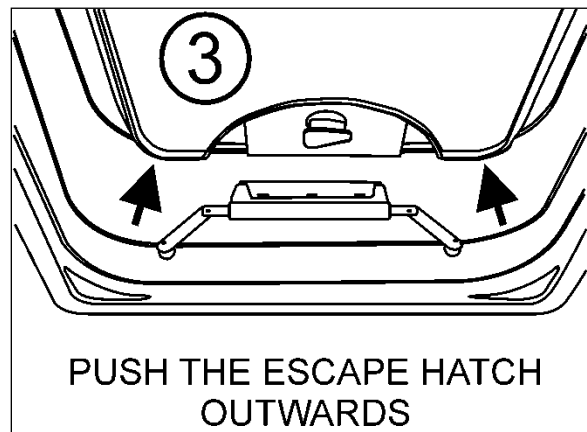
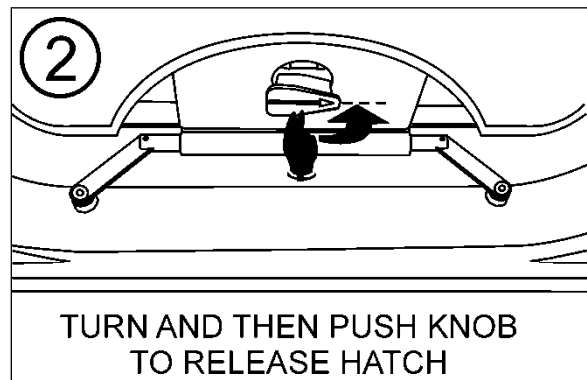
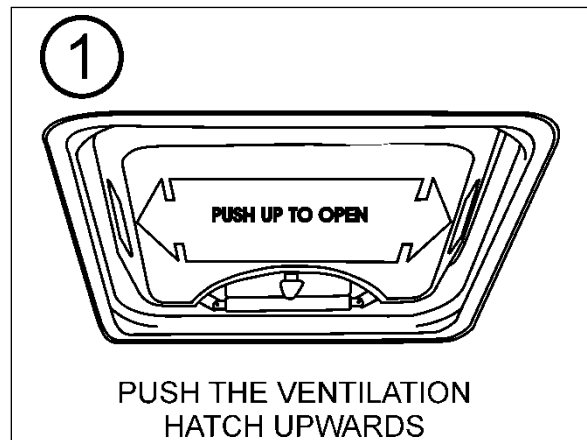

EMERGENCY ROOF ESCAPE OPENING

NOTE

In the event of ventilation blower motor failure, the roof hatch may be used to aid ventilation by pushing the hatch upwards.

**CAUTION**

Be aware of reduced vehicle overhead clearance when driving under overpasses with the roof hatch open.

To latch escape hatch after use, vent arms must be pushed upright in FULL OPEN VENT position. Insert edge firmly between the two sections of the bracket and then return knob to original position (arrow pointing "LATCHED") to lock the hatch. Finally, pull the hatch in to closed position, one side at a time.

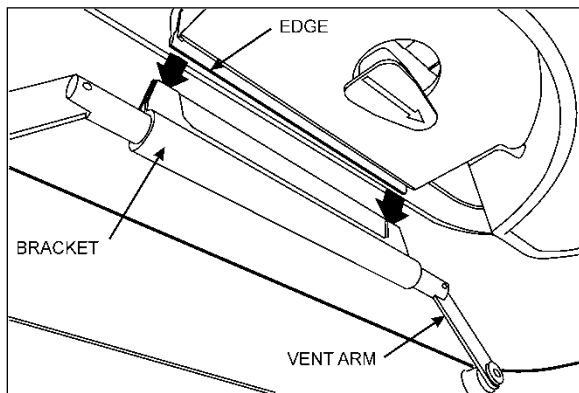

ROOF ESCAPE LATCHING

EMERGENCY ENTRANCE DOOR OPENING

An emergency release air valve located on the dashboard R.H. side near the entrance door allows emergency depletion of the door and latching cylinders. Another unlatch valve is located in the front service compartment and allows opening the door from the outside. To open the door in an emergency situation, first turn the unlatch valve in the direction of the arrows and push (or pull) the door open. To close the door after emergency opening, return the valve to its initial position, open the door using the door cylinder, then close the door normally.

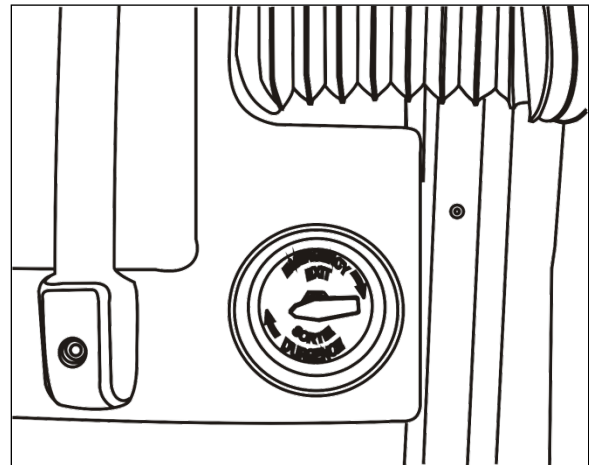

INTERIOR EMERGENCY RELEASE AIR VALVE 12164

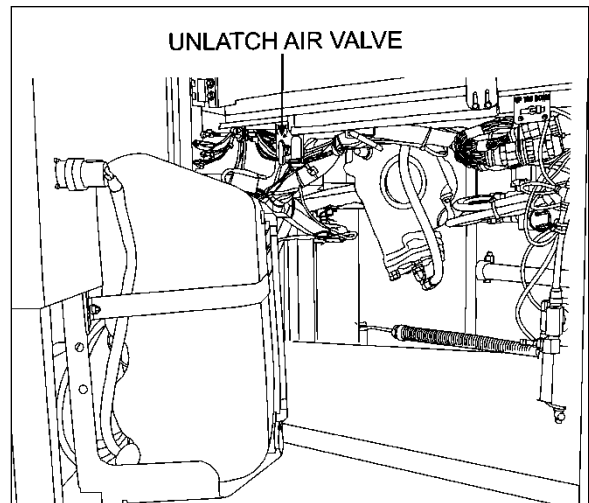

UNLATCH AIR VALVE LOCATION 12209

EMERGENCY EQUIPMENT**FIRE SUPPRESSION SYSTEM (AFSS)**

The coach is equipped with the Automatic Fire Detection and Suppression System (AFSS).

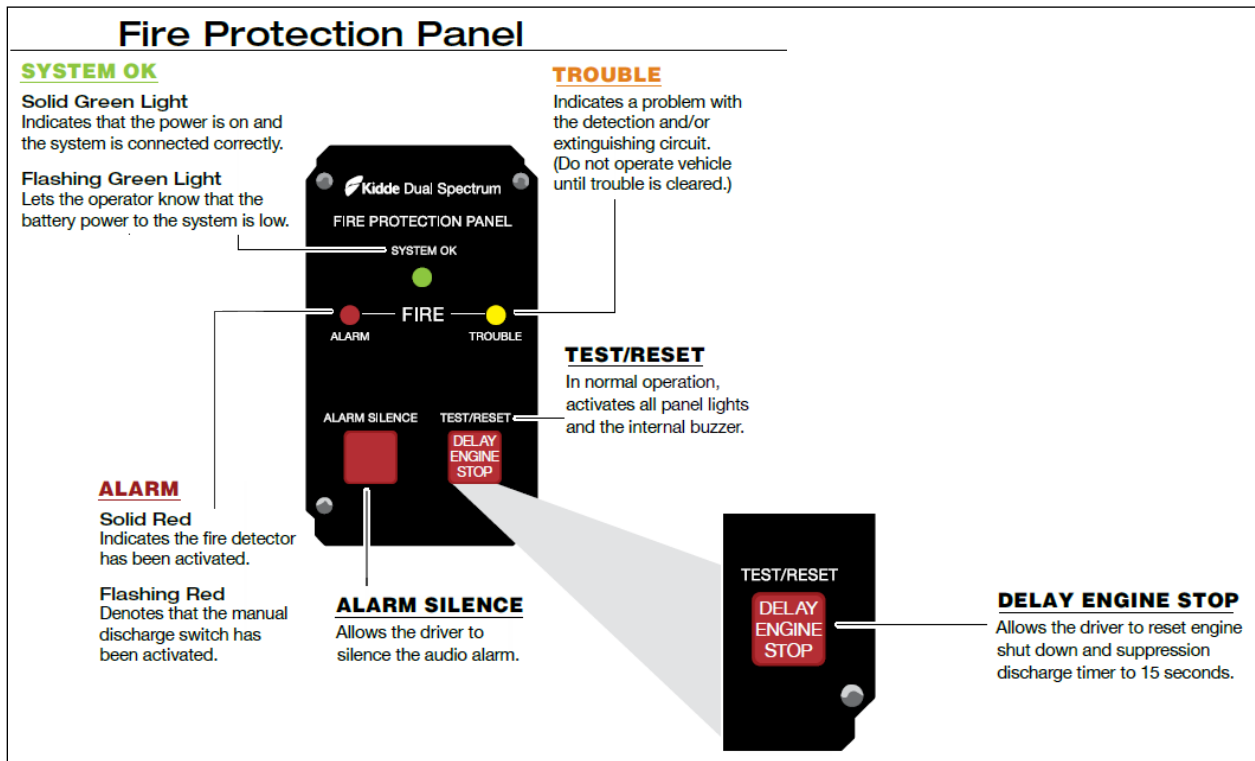

See below, a brief description of the system, the visual information provided and how it should be operated if a fire is detected.





System Operation

The protection panel and manual discharge is located in the operator's area and displays a number of lights which indicate the status of the system.

If a FIRE is detected:

-  ALARM light illuminates
-  The internal buzzer sounds
-  15 second count down begins for engine shut down and suppression discharge

NOTE: If you are not prepared to bring the vehicle to a safe stop you will need to depress the **DELAY ENGINE STOP** button.

-  Upon expiration of timer, engine shuts down
-  Suppression agent will discharge

NOTE: Activation of the manual discharge button will shut down the engine and immediately discharge the suppression system.

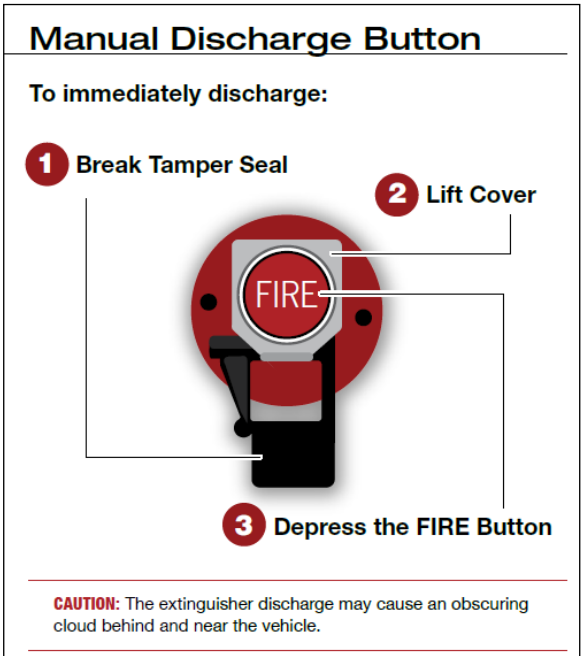

KIDDE IMAGES

Starting the Vehicle after Triggering Of a Fire Alarm

The vehicle may be started after a fire alarm without resetting the system. Refer to ignition switch sequence below. This will not reset the system; rather it will instruct the vehicle's multiplex system to ignore vehicle interface outputs from the protection panel. This feature is intended to be used only in emergency situations that require the vehicle to be restarted and moved a short distance prior to system reset. It should not be performed if the cause of the fire alarm has not been clearly identified and corrected.

To start the vehicle, perform this ignition switch sequence within 2 seconds:

1. From the on position, turn to **OFF**
2. Return to ON and START.

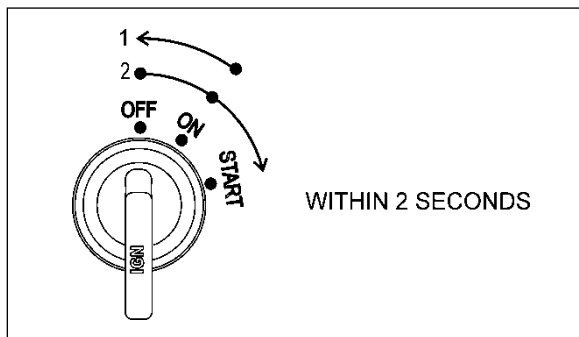

FIRE EXTINGUISHER

The 5 lbs fire extinguisher is located on the driver's L.H. side. Instructions for use are found on the extinguishers.



WARNING

Make sure you know how to operate the fire extinguishers in case of an emergency.

WARNING REFLECTORS

A kit containing three triangular reflectors is provided to warn other drivers on the road in case of a breakdown. The kit is located at the ceiling of the first baggage compartment. The reflectors provide visible warning of an emergency situation. The three reflectors should be placed as indicated on the box cover. These reflectors comply with FMVSS 125 (Federal Motor Vehicle Safety Standards).

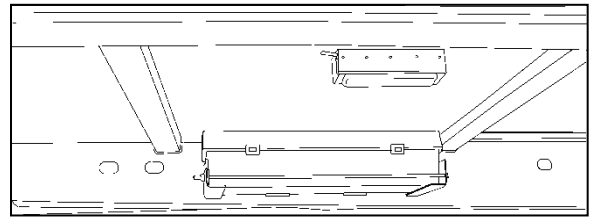

WARNING REFLECTORS LOCATION

23376

HOISTING, JACKING POINTS

For details concerning hoisting, jacking and towing points, refer to Maintenance Information MI14-01.

TOWING

For the complete towing procedure, refer to Maintenance Information MI13-88.

EMERGENCY AIR-FILL VALVES AND QUICK CONNECTOR FITTINGS

The vehicle is equipped with three (3) air system emergency air-fill valves to supplement the air system when air pressure is low and the engine cannot be operated.

Air system emergency valves are fitted with either standard tire valve stem or quick connector fitting. The air systems can be filled using any standard external air supply line.

Air-fill valves are as follows:

- 1- One air-fill valve fitted with standard tire valve stem located in the engine compartment supplies air for all systems through the air dryer (brakes, suspension and accessories).
- 2- One air-fill valve fitted with standard tire valve stem located in the front service compartment supplies air for accessories only.
- 3- One quick connect air-fill fitting identified **AIR SUPPLY** located behind the flip down access door on the front bumper supplies air from a tow truck for all systems through the air dryer (brakes, suspension and accessories).

One quick connector fitting identified **BRAKE** located behind the flip down access door on the front bumper supplies air for operation of the coach service brake from the tow truck.

7-6 SAFETY FEATURES AND EQUIPMENT

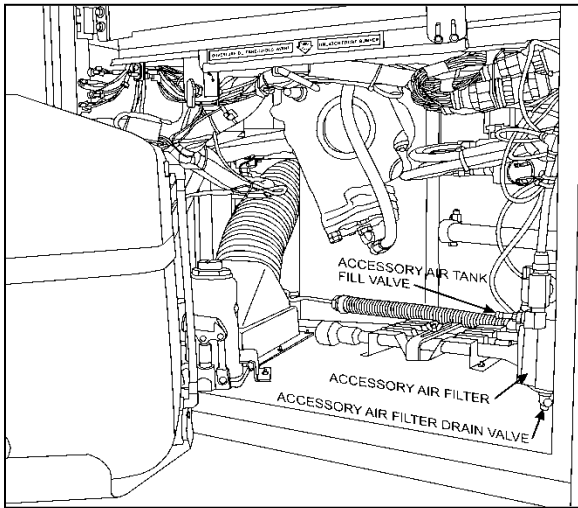

AIR-FILL VALVE IN FRONT SERVICE COMPARTMENT
12210

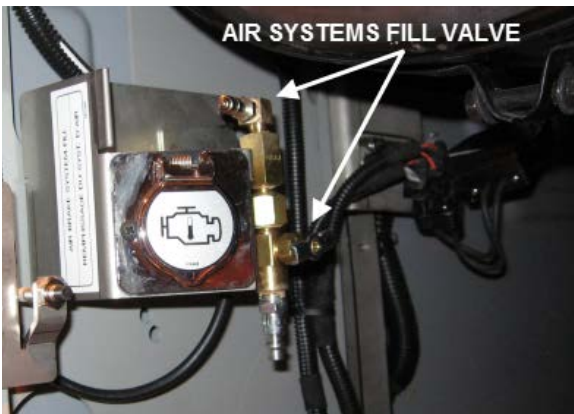

AIR-FILL VALVE IN ENGINE COMPARTMENT
12211_1



QUICK CONNECTOR FITTINGS ON FRONT BUMPER



CAUTION

Air filled through the three emergency air-fill valves will pass through the standard air filtering-drying system. Do not exceed 144 psi (993 kPa).

EMERGENCY AND PARKING BRAKES

During normal operation, if air pressure in all brake circuits drops below 60 psi, spring-loaded emergency brake will be immediately applied at full capacity to the drive axle wheels to stop the vehicle.

Spring-loaded parking brake is applied by pulling up the control valve knob located on the L.H. lateral console.

Parking brake is not designed to be used as a service brake. For normal driving conditions, the control valve knob must remain in the down position.



DANGER

Always apply the parking brake before leaving the driver's seat.

NOTE

Only use the parking brake to supplement the service brake to stop the vehicle in emergency conditions. The stopping distance will be considerably longer than when using normal service brake.

NOTE

Before releasing the parking brake by pushing down the control valve knob, check the pressure gauges to make sure that the brake system air pressure is greater than or equal to 95 psi (655 kPa)

NOTE

A beep will sound if the ignition switch has been turned off without applying the parking brake. The same beep will sound if pressure is still applied to the service brake pedal.

NOTE

The stoplights will automatically turn on when the parking brake is applied when the ignition key is turned to the ON position.

DAYTIME RUNNING LIGHTS

The inner lamps which are the high beams illuminate automatically when the engine is started and the parking brake is released to serve as daytime running lights. The daytime running lights provide added safety by making

the traveling vehicle more visible to other drivers during the day.

The daytime running lights system turns the headlights on when:

Engine is running;

Parking brake is released;

The exterior lighting switch is set to the OFF position or pressed to the first position.

 WARNING
<p>Do not drive with only the daytime running lights at night because the tail and marker lights are not turned on in that situation and the high beams can blind other drivers. For night driving, turn ON the headlights by depressing the exterior lighting rocker switch to the second position.</p>

COMPARTMENT LIGHTING

Baggage compartments and front service compartment lights are automatically turned ON when the corresponding compartment door is opened. A pictogram will appear on the status bar of the Driver Information Display (DID) when a baggage compartment door is open.

BACK-UP ALARM

The back-up alarm alerts pedestrians and other drivers when the vehicle is being backed-up. Take extra precautions whenever backing-up. If necessary, use a guide to provide directions when backing-up. The alarm is automatically activated when the transmission is put in the reverse (R) range.

ESSENTIAL FUNCTIONS TO OPERATE THE VEHICLE (BASIC LIMP-HOME FUNCTIONS)

Even with a defective MCM (Master Chassis Module) or a CAN network problem, essential

base functions are maintained to rear start the vehicle from the engine compartment and drive in a secure manner.

AVAILABLE FUNCTIONS

- Startup: Turn on the ignition in the driver's area and rear start the vehicle from the engine compartment,
- Opening the door: Functions normally,
- Closing the door: Manually pull on the door and it will lock automatically,
- Windshield wipers: Wipers functions at 1st speed only,
- Headlights: Low beams only,
- Directional signals: Rear and front only,
- Stoplights: 2 upper stoplights + high-mounted stoplight are functional,
- HVAC: Functional with set point fixed at 68°F (20°C), evaporator and condenser fixed at speed 1, defroster fixed at speed 4.

 CAUTION
<p>The following directives must be followed.</p> <ul style="list-style-type: none"> • Never connect a battery charger when the ignition is at the ON position on a vehicle with a CAN defective or certain functions will start up by themselves, • Disconnect the charger before starting the vehicle, if not the default functions will not activate, • If the default mode does not activate, try to turn the ignition OFF while ensuring that no charger is connected and then restart the vehicle.

SECTION 8 CARE AND MAINTENANCE

CLEANING	3
SEAT UPHOLSTERY	3
REMOVAL OF STAINS AND MARKS	3
BEVERAGE STAINS.....	3
ALCOHOLIC BEVERAGE STAINS	3
BURNS.....	3
COSMETIC STAINS.....	3
INK STAINS	3
BLOOD, URINE OR VOMIT STAINS	3
COPYING INK - BALL-POINT PEN INK.....	3
MARKING INK (FELT-TIP PENS)	4
OIL, GREASE AND PAINT	4
RUST STAINS	4
TAR.....	4
CHEWING GUM.....	4
PLASTIC AND VINYL.....	4
WINDOWS	4
STAINLESS STEEL.....	4
FORMICA.....	4
CARPET.....	4
RUBBER COMPONENTS	4
FLOOR CLEANING.....	4
EXTERIOR SURFACES.....	4
TAR OR OIL.....	5
INSECTS.....	5
TREE SAP.....	5
WINDSHIELD	5
WIPER BLADES	5
FLUID LEVEL VERIFICATION	5
ENGINE OIL LEVEL.....	5
TRANSMISSION OIL LEVEL	6
COLD CHECK.....	6
HOT CHECK	6
POWER STEERING FLUID LEVEL	7
COOLING FAN RIGHT ANGLE GEARBOX OIL LEVEL	7
DRIVE AXLE WHEEL HUBS	7
FRONT AND TAG AXLE WHEEL HUBS.....	8
COOLANT FLUID LEVEL	8
WINDSHIELD WASHER RESERVOIR	8
OTHER VERIFICATIONS.....	8
AIR TANK PURGE.....	8
FIRE EXTINGUISHER	9
PRIMARY FUEL FILTER.....	9
A/C COMPRESSOR BELTS	9
FAN AND ALTERNATOR DRIVE BELTS.....	10
ENGINE AIR FILTER RESTRICTION INDICATOR.....	10
A/C AND HEATING SYSTEM AIR FILTERS	10
DRIVER'S AREA AIR FILTERS	10

8-2 CARE AND MAINTENANCE

<i>PASSENGERS AREA AIR FILTER</i>	11
<i>AIR FILTERS IN THE OVERHEAD COMPARTMENTS</i>	11
HOSE INSPECTION.....	11
<i>HOSE SERVICE LIFE</i>	11
LUBRICATION.....	11
WHEELS AND TIRES.....	11
WHEEL BEARINGS.....	12
SERVICE BRAKE TEST.....	12
PARKING BRAKE TEST.....	12
EXTERIOR LIGHTING VERIFICATION.....	12
<i>EXTERIOR LIGHTING TEST MODE</i>	12
<i>PRIOR USING THE TEST MODE</i>	12
<i>ACTIVATING THE TEST MODE</i>	12
<i>STOPPING THE TEST MODE</i>	13
FIRST SERVICE ON NEW VEHICLE	14
ENGINE OIL.....	14
GENERAL RECOMMENDATIONS	14
WALK-AROUND INSPECTION (BEFORE EVERY TRIP)	17

CLEANING

The cleaning information provided in this section is regarded as recommended cleaning practices. Cleaning results may vary depending on the condition of the stain. Always clean stains promptly for best results.

Test an inconspicuous area prior to cleaning and follow the manufacturer's directions.

NOTE

Use only approved cleaning products. Never use stain protection products on new fabrics. To prevent permanent staining of fabrics, clean stains as soon as possible after they occur. Incorrect treatment of stains can worsen them. Get help from a cleaning specialist to remove stubborn stains.



CAUTION

Custom fabrics and materials may require different cleaning and maintenance practices. Consult your supplier.

SEAT UPHOLSTERY

Firmly beat the fabric with a blunt object, such as a wooden paddle, to release dust and dirt. Vacuum the seat fabric in the direction of the stitching using an upholstery nozzle.

NOTE

The abrasive nature of dirt and grit will reduce upholstery life expectancy. Vacuum regularly.

Always begin with lukewarm water and a white cloth for most stain removal before applying any cleaning agent.

Removal Of Stains And Marks

Depending on the nature of the stain, apply one of the two methods explained below to remove stains and marks on wool plush.

Method One:

1. Apply a nonflammable solvent to stained area with a clean, white absorbent rag;
2. Clean stain by starting at the outer edges of the stain and working in toward the center;
3. Blot affected area frequently with a clean, dry absorbent cloth to prevent stain rings caused by excess solvent.



WARNING

Use solvents in a well ventilated area. Open all windows and doors.

Method Two

1. Wet the stain with a solution of household detergent and lukewarm water. Do not soak the stain;
2. Rub the stain with a damp cloth;
3. Rinse cloth after each application.



CAUTION

Do not use soap, soap powder, ammonia, soda, bleach or cleaning products containing any of these compounds.

Beverage Stains

Remove beverage stains by following method one. If stain persists, repeat method one using methylated spirits instead of solvent.

Alcoholic Beverage Stains

Remove alcoholic beverage stains by wetting the stain with water, then cleaning following method two.

Burns

Scrape burnt area using a knife or razor blade then clean following method two. Consult an upholstery specialist when dealing with extensive burns.

Cosmetic Stains

Remove stains left by cosmetics by following method one then method two.

Ink Stains

Remove ink stains following method two. If stain persists, apply a warm oxalic acid solution. Rinse with water.

Blood, Urine Or Vomit Stains

Remove such stains by following method two.

Copying Ink - Ball-Point Pen Ink

Treat with methylated spirits, blotting frequently to avoid spreading stain, followed by method two.

8-4 CARE AND MAINTENANCE

Marking Ink (Felt-tip Pens)

Treat with Methyl-Ethyl-Ketone (MEK) followed by method two.

Oil, Grease And Paint

Remove excess using a knife. Treat with method one followed by method two. If stain persists, repeat procedure.

Rust Stains

Remove rust stains by following method two. Apply a warm oxalic acid solution to stained area. Rinse with water.

Tar

Soften tar with benzene, then treat using method one followed by method two.

Chewing Gum

Soften gum with cyclohexane. Carefully scrape off stains using a sharp knife or razor blade.

PLASTIC AND VINYL

Clean plastic and vinyl trim using a clean damp cloth or sponge. For vinyl trim marks, use a lukewarm all purpose cleaner or a mild saddle soap. Remove water spots and soap traces using a clean damp cloth or sponge. Dry with a clean soft cloth.

Remove grease, tar or oil stains with a clean cloth or sponge and an all purpose or solvent-type vinyl cleaner.

Apply a colorless vinyl or leather protective product to maintain the luster and pliability of the plastic or vinyl surface.

WINDOWS

Clean the inside of the windows with a solution of one part vinegar to ten parts water.

STAINLESS STEEL

Use a stainless steel cleaner and follow the manufacturer's instructions. Stainless steel cleaning solution may be ordered from Prevost Car Inc. quoting part number 68-0356.

FORMICA

Remove stains on Formica surfaces with a household detergent, methylated spirits or mineral turps. Clean with a mild abrasive and water solution if stain persists.

CARPET

Vacuum carpets regularly to prolong carpet life.

RUBBER COMPONENTS

Use only pure water or glycerin to clean stains on rubber components.



CAUTION

Never use solvents on rubber components.

FLOOR CLEANING

Clean vinyl floors with a quality nonionic detergent cleaner. Follow the manufacturer's recommendations for cleaning.

Remove any excess detergent solution using a wet/dry vacuum or mop. Rinse floor with a solution of one part Clorox to ten parts warm water.

Polish dry floor using a high-speed buffer and a smooth red 3-M polishing pad.

Mop floor periodically with a solution of 5 per cent Clorox in warm water.

NOTE

For custom or special floor covering materials, consult the manufacturer or your converter for information on how to clean and maintain these types of floors.



CAUTION

Using a water hose to clean the floor is prohibited since it could cause electrical shorts or damage the electrical system.

EXTERIOR SURFACES

Frequent washing and waxing of the vehicle exterior will help protect the finish and luster. The paint finish is attacked by the abrasive effects of airborne particles and corrosive pollutants.

Before washing the exterior of the vehicle, close the fresh air dampers using the "REC" button located on HVAC control panel and on the air intake duct in the evaporator compartment. Install keyhole protectors to prevent water from penetrating. Rinse vehicle with water to remove all loose dirt. Wash vehicle using a quality brand car wash soap. Follow manufacturer's recommendations for cleaning. Rinse well with water.

The vehicle exterior should be cleaned, waxed and buffed when water droplets no longer form on the painted surfaces.

 CAUTION
Hot water can damage paint. Keep water cool or lukewarm.

 CAUTION
<ul style="list-style-type: none"> • Make sure cleaning solutions are not harmful to painted surfaces. Read the manufacturer's instructions before using. • Do not spray water jet directly into fresh air inlet dampers. • Do not aim high pressure water jet at radiator doors. This could damage the radiator fins.

To prevent corrosion, remove caked-on dirt and road salt from the vehicle underbody using a high pressure water jet. Clean wheel housings, bumpers, muffler, tailpipe and brackets.

Carry out corrosion prevention cleaning at least twice a year. Spray underneath of the vehicle and let soak before cleaning. Let engine and exhaust system cool down before cleaning.

Tar Or Oil

Remove tar or oil as soon as possible with an approved automotive tar and oil remover or turpentine. Thoroughly clean area with car wash soap and water. Let dry, then wax.

Insects

Remove insect stains as soon as possible with lukewarm soap and water or insect remover.

Tree Sap

Remove tree sap or bird droppings with lukewarm soap and water. Do not allow to harden.

WINDSHIELD

To prevent windshield wiper streaking, keep silicone sprays away from windshield. Remove road film and wax build-up from windows with lukewarm soap and water or with an alcohol-based cleaning agent. If a chamois is used to dry and polish glass, use it exclusively for that purpose.

Wiper Blades

To avoid tearing frozen wiper blades, loosen them before removing. Remove and clean wiper blades periodically with an alcohol-based cleaning solution. Clean wiper blades using a sponge or soft cloth.

FLUID LEVEL VERIFICATION

Periodic inspection of oil and fluids levels is the most economical and easiest way to help your vehicle perform at its best. Rigorous oil level inspection and replacement will greatly help minimize expensive and unscheduled repairs.

ENGINE OIL LEVEL

Check engine oil level when engine is still warm and with vehicle parked on a level surface. Shut *OFF* engine and wait at least 10 minutes for oil to drain into oil pan before checking. Check engine oil level daily or before each trip. Add oil as required. Do not overfill. Remove dipstick, wipe clean and fully reinsert to ensure an accurate reading. Remove dipstick and check engine oil level.

Do not let the oil level fall below the marking on the dipstick. **Do not** overfill so the level is above the upper marking on the dipstick. Add oil through the oil filler pipe as required in order to maintain level within the safe range

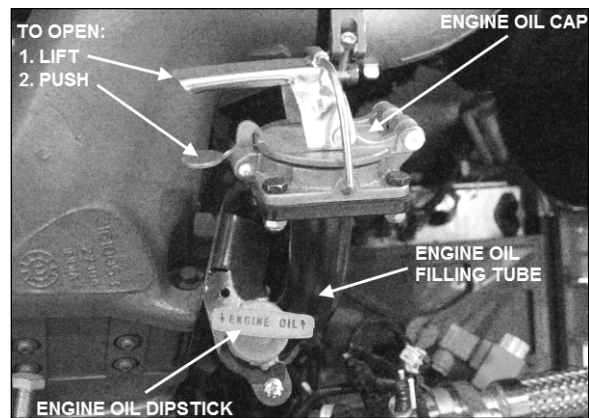

ENGINE OIL DIPSTICK - VOLVO D13 ENGINE 01192

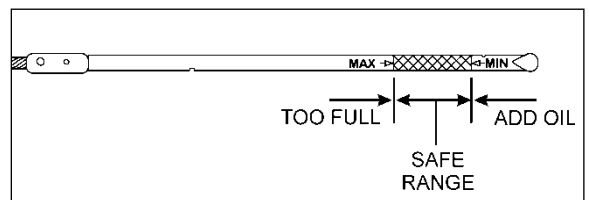

VOLVO D13 ENGINE OIL LEVEL DIPSTICK 01195

TRANSMISSION OIL LEVEL

DANGER

To prevent personal injury, do not service transmission wearing loose clothing. Stand clear of the engine and rotating components while checking the oil level.

CAUTION

Do not mix fluid types or brands because of possible incompatibility.



CAUTION

Use clean fluid and containers when filling transmission. Never use containers that have contained water or anti-freeze (Glycol).

Transmission fluid level may be checked using dipstick or transmission control pad display. The oil level sensor (OLS) is standard in your transmission. With the OLS and Allison 5th generation shift selector, you can get a more accurate electronic fluid level check than with a dipstick.

For more information on how to use the shift selector display to check the transmission oil level, refer to Appendix B under "Allison transmission oil level check using the pushbutton shift selector" in this manual.

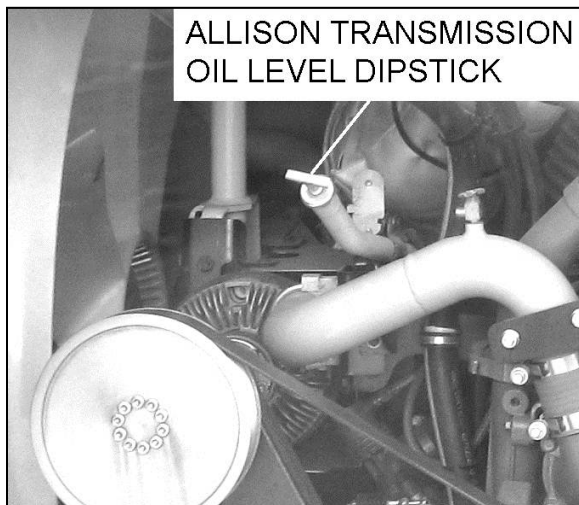
The transmission fluid level dipstick is accessible through the engine compartment rear door and is located on the left side of the engine.



ALLISON TRANSMISSION OIL LEVEL DIPSTICK

ENGINE L. H. SIDE

01189

To check the transmission fluid level, a "cold check" and a "hot check" must be performed. A cold check must be made when the transmission fluid is between 60°F and 120°F (16°C and 50°C).

NOTE

Perform the cold check first to verify the transmission fluid level before performing the hot check.

To prevent dirt and foreign matter from entering the transmission, clean the end of the oil fill tube before removing dipstick. To remove dipstick, unscrew filler cap approximately three turns and pull out dipstick.

Cold Check

Run the engine until the transmission fluid temperature is between 60°F and 120°F (16°C and 50°C). With the engine idling, make sure the parking brake is applied and the transmission is in neutral (N). Remove and wipe the dipstick with a clean cloth. Check oil level. If the oil level is within the COLD RUN band, the oil level is correct and a hot check can be performed. If the oil level is on or below the lower line of the COLD RUN band, add oil until the level lies within the COLD RUN band. If the oil level is above the COLD RUN band, drain oil until the level is within the band.

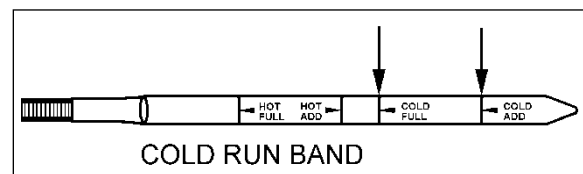

TRANSMISSION FLUID LEVEL DIPSTICK (TYPICAL) 07050



CAUTION

The oil level rises as oil temperature rises. Do not add oil above the "cold run" band before the transmission reaches 180°F to 220°F (82°C to 104°C).

Hot Check

Make sure the transmission fluid temperature is between 180°F and 220°F (82°C and 104°C) before performing the hot check. Run the engine between 1,000 and 1,200 RPM for approximately one minute to purge air from the system. With the engine idling and the parking brake applied, shift transmission from forward (D) to reverse (R) and back into neutral (N) to fill

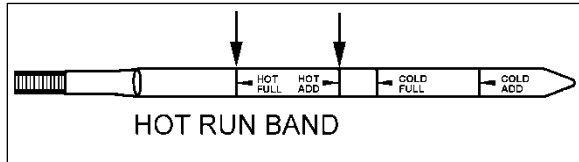
clutch cavities with oil. Remove and clean dipstick, then check oil level. If the oil level is on or under the lower HOT RUN line, add just enough oil to bring up the level to the middle of the HOT RUN band.



TRANSMISSION FLUID LEVEL DIPSTICK (TYPICAL) 07049

Replace dipstick and tighten the filler tube cap until the rubber seal is correctly seated.

	<h3>CAUTION</h3>
<p>Do not overfill transmission fluid reservoir. Severe damage may result.</p>	

POWER STEERING FLUID LEVEL

The power steering hydraulic fluid tank is located in the engine compartment, close to the engine air filter (refer to “Engine Compartment Overview” image in COACH EXTERIOR section).

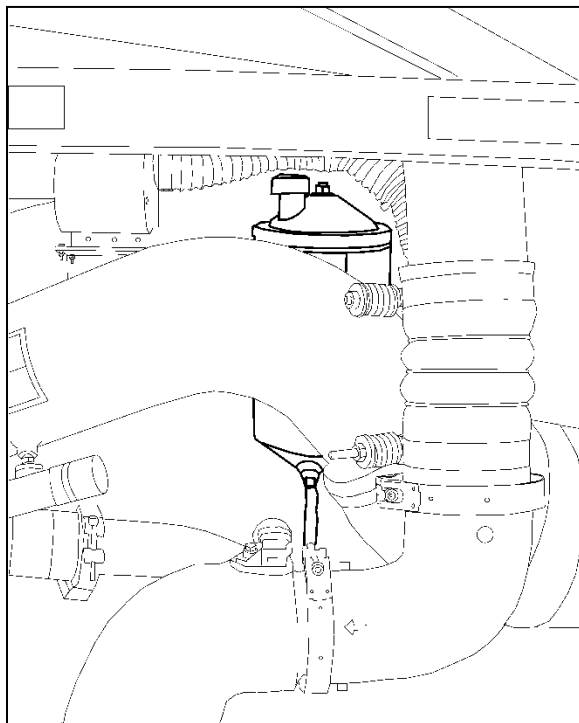

ENGINE COMPARTMENT 14059

Check fluid level as follows:

1. Stop engine, open engine compartment doors and place rear start switch to OFF position;

2. Unscrew and remove the dipstick located on top of the power steering fluid tank and wipe with a clean rag;
3. Replace dipstick in tank, then remove to check fluid level;
4. Add hydraulic fluid until it reaches the FULL mark on the dipstick;
5. Replace and tighten dipstick;
6. Place engine rear start switch to NORMAL position. Close engine compartment doors.

COOLING FAN RIGHT ANGLE GEARBOX OIL LEVEL

Check cooling fan right angle gearbox oil level as follows:

1. Stop engine, open engine compartment doors and place engine rear start switch to OFF position;
2. Remove side oil filler plug;
3. Add oil through the top or side oil filling point if the oil level has fallen below the side oil filling point;
4. The oil level is correct once the top of the oil has reached the bottom of the side oil filling point or once oil has already started to escape from the side oil filling point;
5. Replace the seal and screw the side and top filler plugs back in;
6. Place engine rear start switch to NORMAL position. Close engine compartment door.

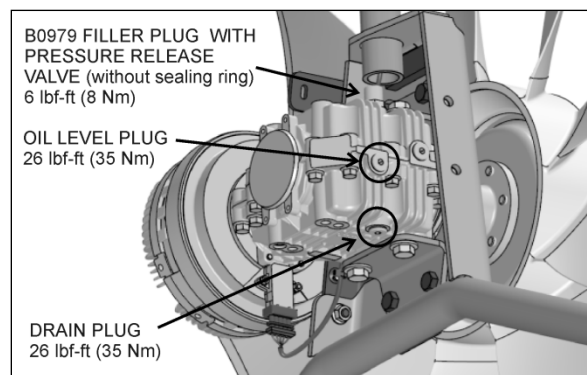

RIGHT ANGLE GEARBOX OIL LEVEL CHECK 05118

DRIVE AXLE WHEEL HUBS

The unitized bearings in the axle drive and the wheel ends are pre-lubricated for life and there is no need or facility for re-lubrication. Maintain differential oil at correct level to ensure adequate lubrication of carrier.

8-8 CARE AND MAINTENANCE

FRONT AND TAG AXLE WHEEL HUBS

The unitized hub bearings used on the NDS range of axles, are non-serviceable items. Bearings are pre-adjusted, lubricated and have seals fitted as part of the manufacturing process. The bearings are greased for life and there is no need or facility for re-lubrication.

COOLANT FLUID LEVEL

Check the coolant level when the engine is cold (room or ambient temperature).

- If the coolant level has reached the bottom of the sight glass, add coolant up to the middle of the sight glass.

Fill the tank as required with the same 50/50 water-antifreeze mixture already in the cooling system. **Do not** mix two different types of coolant. Refer to the Maintenance Manual for proper coolant type specifications or see the label affixed near the coolant surge tank on the vehicle.

When the coolant level reach the low coolant sensor, the red warning light located next to the tank in the engine compartment will illuminate to indicate the need to add coolant to the system.

If the coolant level reaches the coolant surge tank critically low level sensor, the STOP telltale light illuminates, a beeping tone is heard and "ENGINE COOLANT LEVEL CRITICALLY LOW" message appears in the DID. Stop the vehicle in a safe location and add coolant to the cooling system surge tank as soon as possible.

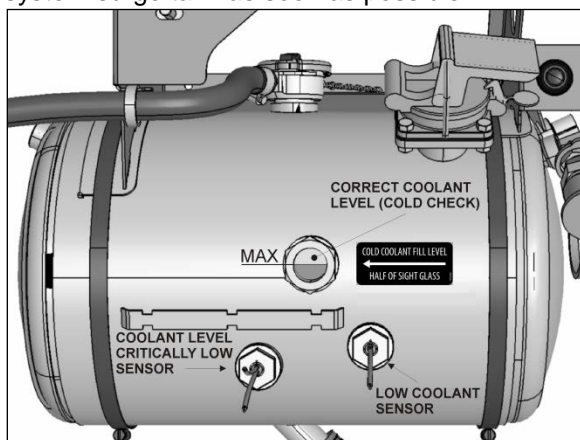

COOLANT LEVEL SIGHT GLASS

05094_3



WARNING

Hot engine coolant is under high pressure. Allow engine to cool down before adding coolant.

WINDSHIELD WASHER RESERVOIR

The windshield washer reservoir is located in the front service compartment door. The windshield washer reservoir has a capacity of 5.3 US gallons (20 liters). Check fluid level regularly.

The windshield spray jets are located on the windshield wipers and are angled to spray towards the center of the windshield.

You may use water or windshield washer fluid as well.

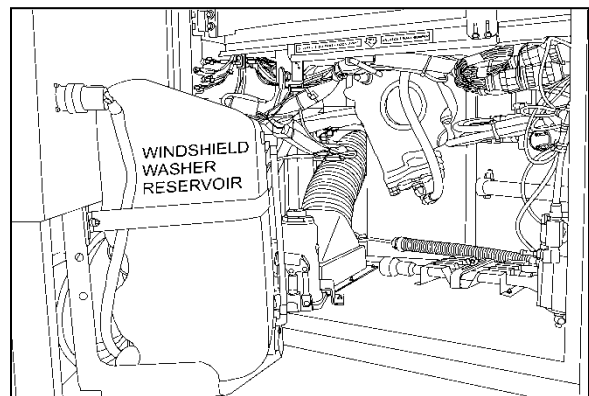

WINDSHIELD WASHER RESERVOIR

18619



CAUTION

During cold weather days, use windshield washer fluid suitable for freezing temperature only.

OTHER VERIFICATIONS

It is good practice to regularly inspect the vehicle for signs of component wear and to perform safety and maintenance routines.

AIR TANK PURGE

The vehicle is equipped with seven air tanks, including the ping tank.

The wet tank is equipped with an automatic drain valve and doesn't need to be purged manually.

The remaining tanks which are the primary, secondary, the accessory, kneeling, and parking brake overrule tanks are equipped with a drain cock underneath the tank and must be purged from moisture and contaminants every 12,000 miles. Drain tanks by turning drain cocks counterclockwise. The accessory air tank drain cock is accessible from the front service compartment. The parking brakes overrule air

tank is located at the ceiling of the last baggage compartment. Refer to the "Lubrication and Service Check Point Chart" in this chapter for tank locations.

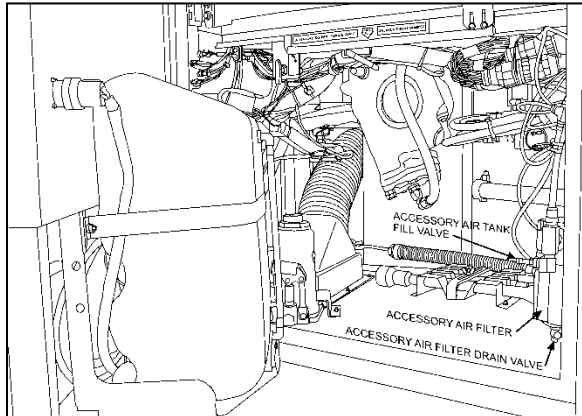

FRONT SERVICE COMPARTMENT 12210

FIRE EXTINGUISHER

Inspect fire extinguisher monthly to insure operation in emergency situations.

On extinguishers with a pressure gauge, the needle should be in the green or NORMAL range. Refill or replace extinguisher if pressure is below normal;

Check that seal on handle is intact;

Check that hose nozzle is in good condition and the nozzle is free of obstructions;

Keep fire extinguishers clean.

PRIMARY FUEL FILTER

A primary fuel filter is installed on the engine. This filter may consist of a filter cartridge with a drain valve at the bottom, or a filter cartridge, a water separation bowl and may have a fuel heater built in. It is used to prevent water from entering the fuel system. The primary fuel filter should be drained periodically or when the telltale light on the dashboard illuminates if equipped with this system. To drain water, loosen the drain valve below the separator. Close the drain valve when finished.

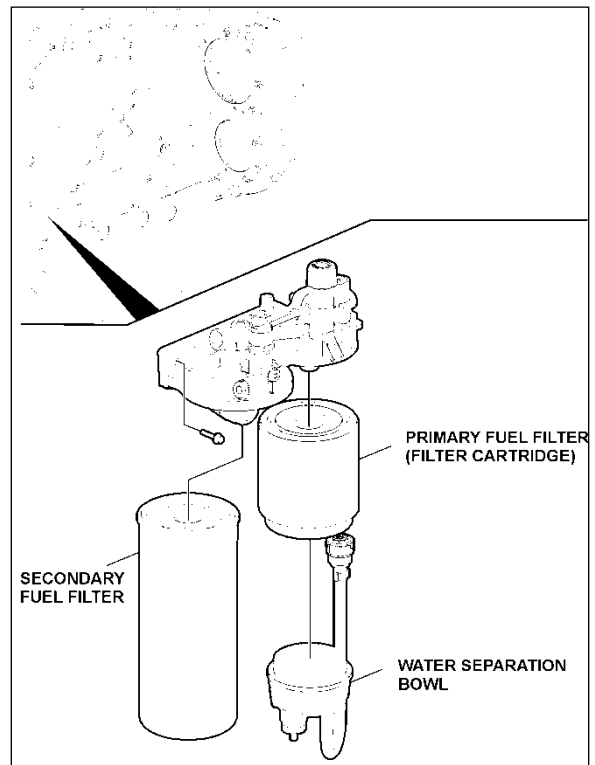

FUEL FILTERS WITH VOLVO D13 ENGINE 03085

A/C COMPRESSOR BELTS

The air conditioning compressor is driven by two V-belts.

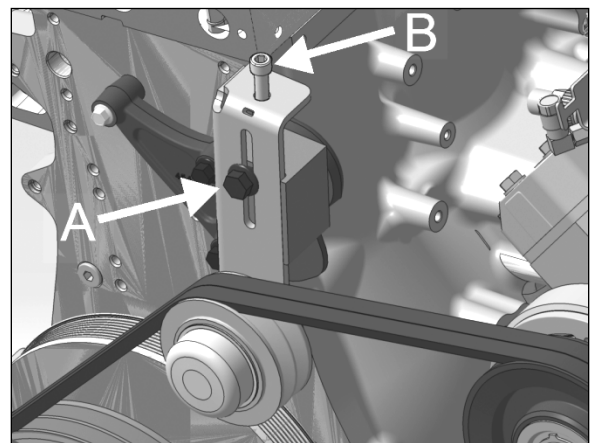

BELT TENSIONER

Belt tensioning is applied through the tensioner adjustment screw B. Loosen lock bolt A prior adjustment. Tighten lock bolt A to 43 lbf-ft once completed.

Belt tension should be within the following values:

- New belts: 90-100 lbs.
- Used belts: 75-85 lbs.

8-10 CARE AND MAINTENANCE

Check belt tension using a belt strand tension gauge.

- Once adjustment is completed, allow the engine to run for about ten minutes. Check belt tension and adjust if needed.
- Do not treat belts with any compounds. Keep belts dry.
- Periodically inspect belt and pulleys for wear or damage;

FAN AND ALTERNATOR DRIVE BELTS

These belts have automatic belt tensioner to keep the correct tension without the need for adjustment.

ENGINE AIR FILTER RESTRICTION INDICATOR

An engine air filter restriction indicator is located on the turbo air intake duct

It is used to monitor the vacuum level between the air filter and turbo. A red marker is displayed when the air filter is clogged.

Replace the air filter when a red marker is displayed on the indicator or upon illumination of the restriction indication light on the rear start panel. Reset by pressing on the restriction indicator's extremity.

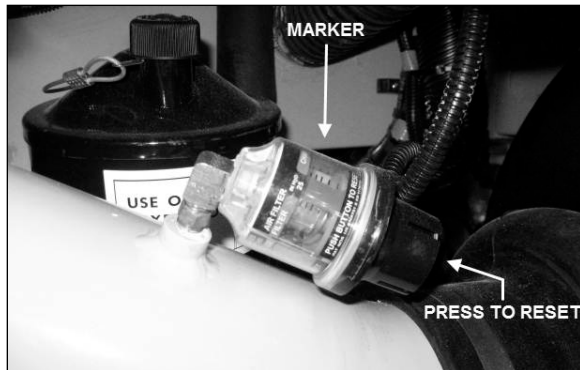

AIR FILTER RESTRICTION INDICATOR

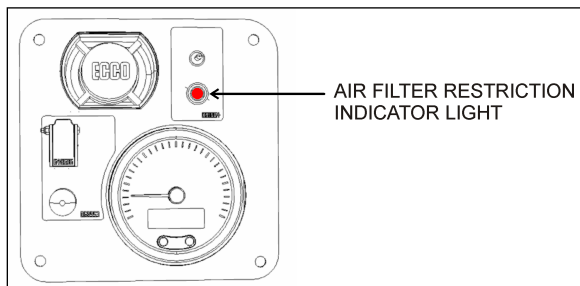

AIR FILTER RESTRICTION INDICATOR

A/C AND HEATING SYSTEM AIR FILTERS

For maximum air conditioning and heating system efficiency, air filters should be inspected, cleaned and replaced as required in maintenance schedule to ensure proper ventilation of the evaporator and heating radiator cores.

Driver's Area Air Filters

The driver HVAC system's air filter is located behind the dashboard R.H. side and it can be removed for cleaning or replacement. To gain access to the A/C filters, unscrew the grill located at the top step of the entrance door steps, remove the plastic cover holding the filter and slide out the air filter.

NOTE

If the windshield is continuously fogged, check that the driver's air filter is not clogged.

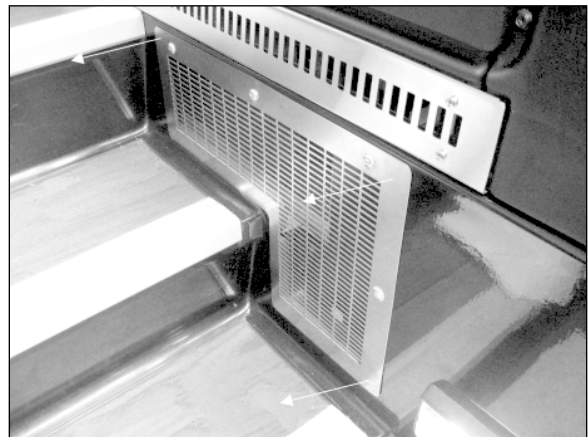

DRIVER'S AREA AIR FILTER GRILL REMOVAL

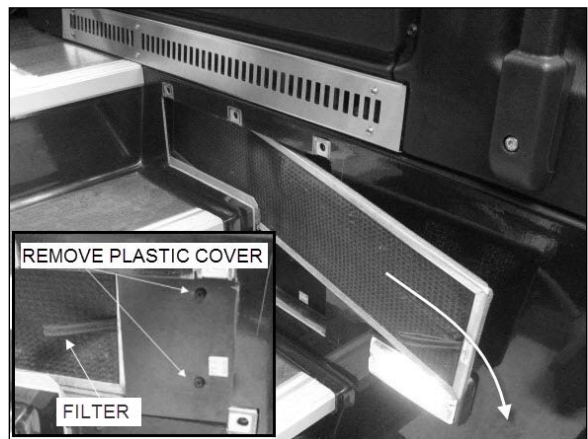

REMOVING DRIVER'S SECTION AIR FILTER

Passengers Area Air Filter

The central HVAC system's air filter is located in the evaporator compartment on driver's side of the vehicle. To access, open the evaporator compartment. An access panel marked "AIR FILTER" is located above the evaporator and heating coils. It is held shut by quarter-turn screws. Slide out the filters for maintenance purposes.

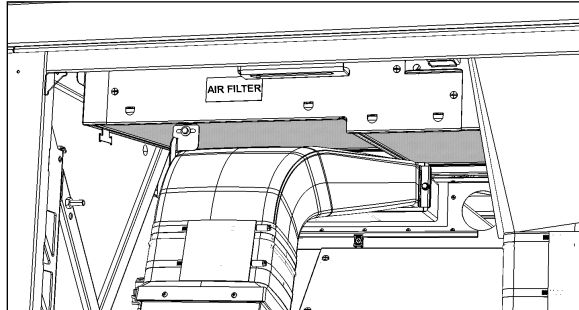

PASSENGERS AREA AIR FILTER REMOVAL 22306

CAUTION
Be sure not to install filter in inverted position.

Air Filters in the Overhead Compartments

Remove, clean or replace the air filter located behind each overhead baggage compartment fan. Slide the filter in and out using the tab fixed on the side of the filter.

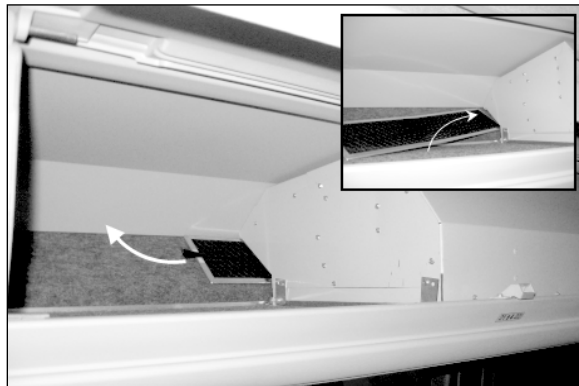

OVERHEAD COMPARTMENT FAN AIR FILTER

HOSE INSPECTION

Inspect hoses for leaks regularly to ensure efficient, economical and safe operation of the engine and related equipment. Carefully inspect all fittings, clamps and ties. To prevent chafing, make sure hoses are not touching shafts, couplings, heated surfaces, sharp edges or other parts. Since hose clamps and ties can

vibrate loose or fail over time, inspect frequently and tighten or replace as necessary.

Correct leaking hoses immediately. Failure to correct leaks can cause severe damage to the equipment, as well as increase operating costs due to lost fluids. Treat fuel and oil leaks as an immediate fire hazard.

WARNING
Personal injury and property damage may result from fire caused by leaking flammable fluids.

Hose Service Life

Hoses have a limited service life. Thoroughly inspect hoses annually. Look for surface damage or indications of twisted, worn, crimped, cracked or leaking lines. Replace damaged hoses immediately.

Hoses should be replaced during major overhaul or after a maximum of seven years service. Be certain replacement hoses match the original equipment manufacturer's specifications.

LUBRICATION

Grease all lubrication points during scheduled maintenance. For heavy loads or extended use, lubricate more often. Refer to the Maintenance Manual, section 24 for information on lubrication.

WHEELS AND TIRES

Check for loose wheel nuts. Inspect all types of rims for cracks. Cracks can appear in many places but typically radiate out from where a load is applied. Steel wheel nuts should be tightened to 450 to 500 foot-pounds (610 to 680 N.m.) torque.

Keep the tires inflated to the recommended inflation pressure to prolong tire life and for safety.

NOTE
Recommended tire inflation pressures are given in the "Coach Final Record", placed in the technical publications package supplied with the vehicle. The cold tire inflation pressures are on the Department of Transport certification plate located on the L.H. console besides the driver's seat. When special tires are installed by Prevost on a new vehicle, a special tire inflation chart is added next to the certification plate.



WARNING

Do not exceed maximum inflation pressure. Incorrect tire pressure increases tire wear and could lead to loss of driving control because of reduced road handling. Check tire pressure regularly.

WHEEL BEARINGS

Check wheel bearing cover for overheating (especially after using the service brakes) during fuel stops by touching the wheel bearing cover.



WARNING

If replacement tires are different from those described on the certification plate, pressure must be adjusted as requested in the Tire and Rim Association Manual.

SERVICE BRAKE TEST

Check for correct pressure build-up. Stop engine and check pressure gauge. Pressure loss should not exceed 3 psi/min (21 kPa/min) with engine stopped and without brake pedal applied. Air loss should not exceed 7 psi/min (48 kPa/min) with engine stopped and brake pedal fully applied.

A convenient way to proceed to the service brake test is with the use of the DID menu "Air Leakage Monitor". For more information, refer to "Driver Information Display (DID) Menus" in Section 5 *Other Features*.

PARKING BRAKE TEST

Release parking/emergency brake. Pump service brake pedal until air pressure drops to 65 psi (448 kPa). Make sure the warning buzzer operates and that the emergency brakes apply (the control valve knob lifts up). Allow air pressure to reach 95 psi (655 kPa) before releasing parking brake.

Driving the vehicle while the parking brake is applied should not be possible.

EXTERIOR LIGHTING VERIFICATION

Exterior Lighting Test Mode

This useful function allows quick verification of the vehicle exterior lights.

IMPORTANT NOTE

The test mode is useful to check the functioning of the multiplex outputs and the exterior lights. It doesn't test the functionality of the commands related to the exterior lighting. For a complete testing, the directional signal commands, the headlights commands and the brake pedal have to be checked before. Once these commands tested, activate the test mode to check the exterior lighting.

Prior using the test mode

First, test the functionality of the commands related to the exterior lighting:

- Press the right turn signal switch and check that the corresponding telltale light illuminates.
- Press the left turn signal switch and check that the corresponding telltale light illuminates.
- Activate the hazard warning flashers and check that the corresponding cluster telltale lights illuminate.
- Press the headlights rocker switch in first position and confirm that the instrument panel illuminates. Press the headlights rocker switch in second position and confirm that the headlights illuminate.
- Turn on the high beams and check that the corresponding cluster telltale light illuminates.

Once these commands tested, activate the test mode to check the exterior lighting:

- All marker lights, clearance lights and identification lights illuminate.
- High and low beam headlights illuminate.
- All directional signal lights and center stop lights flash.
- Stop lights and center high-mounted stop light (CHSL) illuminate every 4 seconds.

Activating the test mode

When the vehicle is stationary (parking brake applied), press the left and right turn signal foot switches simultaneously and release to activate the test mode.

This test can be done when the engine is running or when it is not running with the ignition

switch to the ON position, provided that the battery charge is sufficient (above 24.0 volts).

Once initiated, the exterior lighting test mode will turn off automatically after a delay of **120 seconds**.

NOTE

You can also **initiate and stop** the exterior lighting test mode with the use of the DID menu “Exterior Lamp Inspection”. For more information, refer to “Driver Information Display (DID) Menus” in Section 5 Other Features.

- **Stopping the test mode**
- The test mode will turn off automatically after a delay of **120 seconds**. To stop the test mode before the end of delay:
 - press either left or right turn signal foot switch
 - or
 - turn the ignition switch to OFF
 - or
 - remove the parking brake.

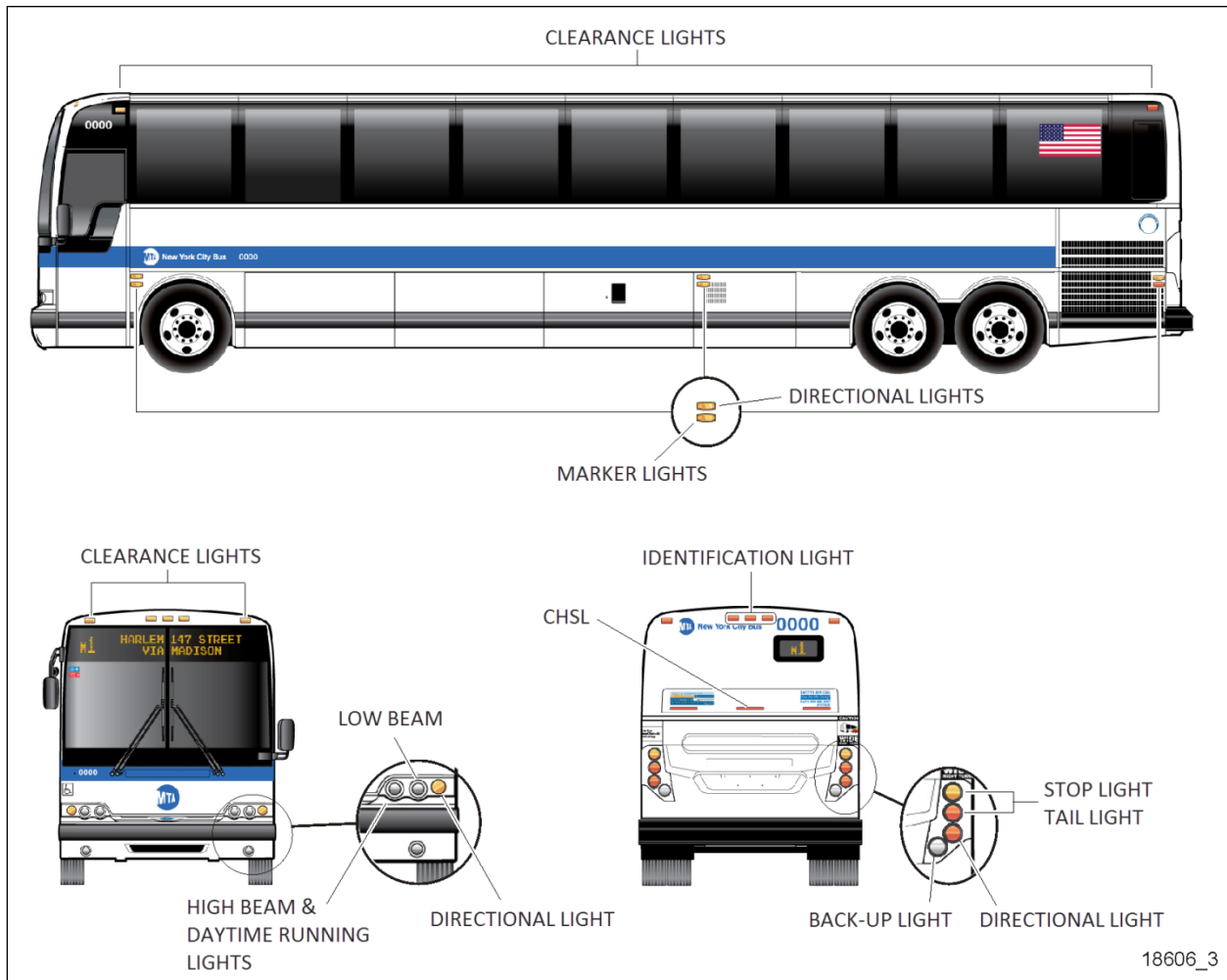

VARIOUS LIGHT LOCATIONS

FIRST SERVICE ON NEW VEHICLE

NOTE

Refer to Maintenance Manual for precise service schedule.

ENGINE OIL

Preliminary oil change is not required since the engine has been test-run at the factory. Change oil and filter as specified in Section 24 of the Maintenance Manual.

GENERAL RECOMMENDATIONS

- Understand basic principles of vehicle operation;
- Always maintain the vehicle in good running condition;
- Do not drive with low fuel. If the fuel tank runs dry, the engine will not start until the air is bled from the fuel system. Refer to "Maintenance Manual" for more information;
- Allow engine to run for at least two minutes at normal idle before shutting *OFF*;
- Engine should be at idle when shifting from neutral (N) to forward (D) or from neutral (N) to reverse (R);
- The automatic transmission does not have a park (P) position. Place transmission in neutral (N) position and apply parking brake when the vehicle is stopped. A warning buzzer will sound if the engine is stopped and the parking brake has not been applied when foot pressure is removed from the brake pedal;
- Always follow the procedures described in this manual;
- Unless stated otherwise, shut *OFF* the engine before performing all servicing, lubrication and maintenance tasks;
- Do not attempt to push or pull-start the coach;
- The vehicle may be damaged if towed with the axle shafts or driveshaft connected;
- The chemical fire extinguisher is located behind the driver's seat. In case of fire, immediately evacuate all occupants. Occupant safety is the first priority. Do not

attempt to extinguish the fire if there is immediate danger or risk for personal injury;

- When driving on ice and snow, accelerate and decelerate gradually;



WARNING

Report all problems affecting passenger or driver safety to a Prevost service center or an authorized service center. Have problems corrected immediately.

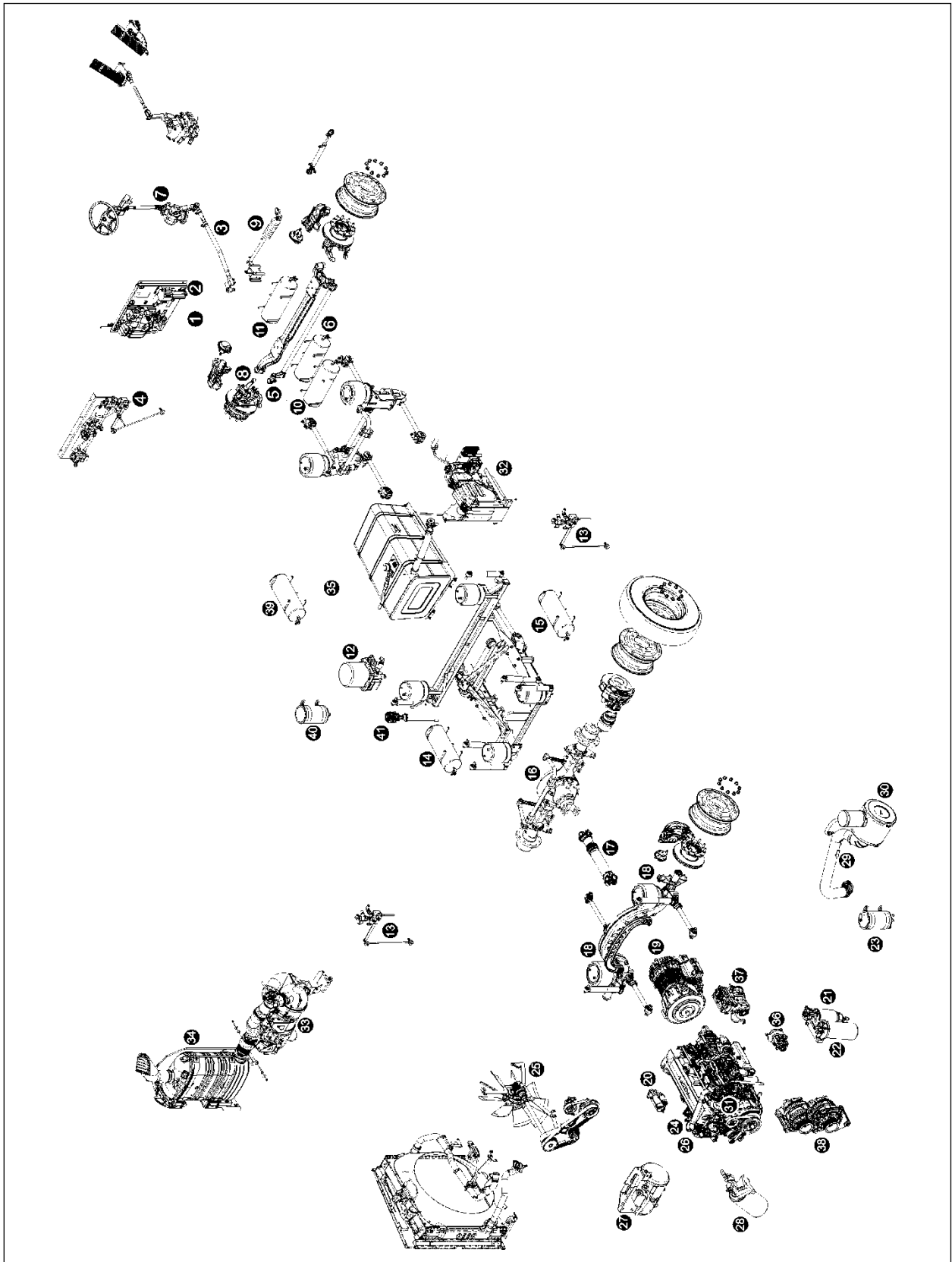

COMPONENTS IDENTIFICATION (COMPONENTS REPRESENTATION MAY DIFFER SLIGHTLY FROM AN ACTUAL VEHICLE)

8-16 CARE AND MAINTENANCE

24039_4

- | | | | |
|----|---------------------------------|----|---------------------------------------------------|
| 1 | Accessories air tank drain cock | 22 | Secondary fuel filter |
| 2 | Accessories air filter | 23 | Power steering fluid tank |
| 3 | Steering drag link | 24 | Engine oil filter |
| 4 | Height control valve (front) | 25 | Cooling fan gearbox |
| 5 | Steering tie rod | 26 | Allison transmission oil dipstick |
| 6 | Accessories air tank | 27 | Engine coolant surge tank |
| 7 | Steering column U-joints | 28 | Coolant filter & conditioner |
| 8 | Steering knuckle pins | 29 | Engine air filter restriction indicator |
| 9 | Steering damper cylinder | 30 | Engine air filter |
| 10 | Secondary air tank | 31 | Engine oil dipstick and filler tube |
| 11 | Kneeling air tank | 32 | DEF tank |
| 12 | Air dryer | 33 | Diesel particulate filter |
| 13 | Height control valve (rear) | 34 | SCR catalytic converter |
| 14 | Wet air tank | 35 | Diesel fuel tank |
| 15 | Primary air tank | 36 | Power steering pump |
| 16 | Differential | 37 | Air compressor |
| 17 | Propeller shaft | 38 | Alternators |
| 18 | Tag axle lever pivot | 39 | Emergency / parking Brakes Overrule Control Valve |
| 19 | Transmission | 40 | Air dryer purge tank |
| 20 | Starter | 41 | Haldex Consep® Condenser / Separator |
| 21 | Primary fuel filter | | |

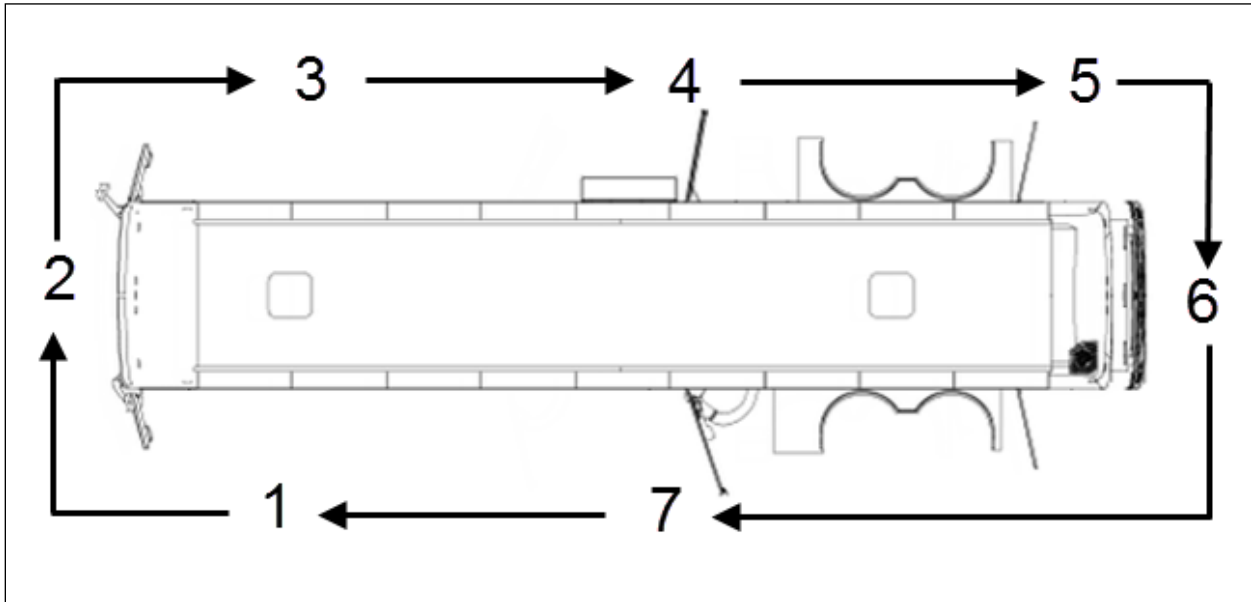
WALK-AROUND INSPECTION (BEFORE EVERY TRIP)**NOTE**

Inspect the coach in a circular manner as shown in the illustration.

Approaching the Coach

- Check under the coach for oil, fuel, coolant leaks or other signs of damage.
- Check exterior body surfaces for signs of breaks or damage.

Preparation

- Drain accumulated water from accessories tank.
- Close air tank drain valves.
- Start the engine and let the air pressure build up to normal. Stop engine.
- Switch on hazard warning flashers.
- Make sure parking brakes are applied.

Step 1: Front Left Side of the Coach

- Check condition of wheel rim. Especially look for cracks, missing nuts, bent or broken studs.
- Check condition of tire: properly inflated, no serious cuts, bulges, tread wear or any signs of misalignment; valve stem not touching wheel or rim; valve cap in place.
- Check windshield washer reservoir fluid level and add if necessary.

Step 2: Front of the Coach

- Check for damage and clean if dirty.
- Check windshield wiper arms for proper spring tension.
- Check wiper blades for any damage, “dead” rubber and attachment to arm.
- Check clearance and identification lights, they should be clean, operating and of the proper color. Refer to “Exterior Lighting Verification” in this section.
- Turn on headlights. High and low beams should be operating and lenses clean. Refer to “Exterior Lighting Verification” in this section.
- Left and right front turn signal lights clean, operating and proper color. Refer to “Exterior Lighting Verification” this section.

Step 3: Front Right Side of the Coach

- Check condition of wheel rim. Especially look for cracks, missing nuts, bent or broken studs.
- Check condition of tire: properly inflated, no serious cuts, bulges, tread wear or any signs of misalignment; valve stem not touching wheel or rim; valve cap in place.

Step 4: Rear Right Side of the Coach

- Check condition of wheels and rims. Especially look for cracks, missing nuts, bent or broken studs.
- Check that baggage and service compartment doors are properly closed and cable locks are in place.
- Check condition of tires: properly inflated, no serious cuts, bulges, tread wear or any signs of misalignment; valve stems not touching wheels or rims; valve caps in place and no objects stuck between the wheels.

Step 5: Engine Compartment Right Side Area

- Check engine and surrounding areas for coolant, oil and fuel leaks.
- Check fuel filter/water separator and drain if necessary. Check for leaks.
- Check wiring harness for signs of damage.

Step 6: Engine Compartment

- Check engine and surrounding areas for coolant, oil and fuel leaks.
- Check wiring harness for signs of damage.
- Check condition of drive belts.
- Check engine crankcase oil level, add if necessary.
- Check Allison transmission fluid level (can also be checked from push-button shift selector), add if necessary.
- Check power steering reservoir fluid level, add if necessary.
- Check coolant surge tank fluid level, add if necessary.
- Check air cleaner restriction indicator, replace air cleaner when red signal locks in full view.
- Check that exhaust aftertreatment system access door is properly closed.
- Check stop light, tail light, directional signal light and back-up light assembly; operating, clean and proper color. Refer to "Exterior Lighting Verification" in this section.

Step 7: Rear Left Side of the Coach

- Check condition of wheels and rims. Especially look for cracks, missing nuts, bent or broken studs.
- Check that baggage and service compartment doors are properly closed and cable locks are in place.
- Check that catalytic converter access door is properly closed.
- Check condition of tires: properly inflated, no serious cuts, bulges, tread wear or any signs of misalignment; valve stems not touching wheels or rims; valve caps in place and no objects stuck between the wheels.

Inside the Coach

- Check for proper operation of the entrance door.
- Check steps; clean them if there is any substance that makes them slippery, which makes coach entry/exit hazardous.
- Check that emergency exit windows and roof escape hatches can be opened then close all windows and hatches securely.
- Verify proper operation of windshield wiper/washer.
- Adjust and clean mirrors for adequate rear view vision.
- Start engine and check for proper operation of all gauges and indicator lights.
- Check for proper operation of electric horns and back-up alarm.

Perform a brake test. Check both primary and secondary pressure gauges.

SECTION 9 TECHNICAL INFORMATION

OVERALL DIMENSIONS	2
DIMENSIONS, WEIGHTS AND CAPACITIES	4
FUEL TYPE	4
BIODIESEL FUELS	4
WHEELS AND TIRES	5
RECOMMENDED TIRE INFLATION PRESSURE AT MAXIMUM COLD LOAD	5
BELTS	5
VOLVO D13 ENGINE	5
ALLISON TRANSMISSION	5
PROPELLER SHAFT	5
BRAKES	5
BRAKE CHAMBER EFFECTIVE AREA	5
AIR SYSTEM	5
ANTILOCK BRAKING SYSTEM (ABS)	6
STEERING	6
ELECTRICAL SYSTEM	6
SUSPENSION	6
I-BEAM AXLE FRONT SUSPENSION	6
DRIVE AXLE	6
TAG AXLE	6
ALIGNMENT SPECIFICATIONS	6
COOLING SYSTEM	7
FUEL SYSTEM	7
EXHAUST SYSTEM	7
HEATING AND AIR CONDITIONING	7
OIL SPECIFICATIONS	8
ENGINE	8
ALLISON TRANSMISSION	8
DIFFERENTIAL	8
FAN RIGHT ANGLE GEARBOX	8
POWER STEERING	8
PLATES AND CERTIFICATION	8
SAFETY CERTIFICATION	9
DOT CERTIFICATION PLATE	9
VEHICLE IDENTIFICATION NUMBER (VIN)	9
COACH FINAL RECORD	9

9-2 TECHNICAL INFORMATION

OVERALL DIMENSIONS

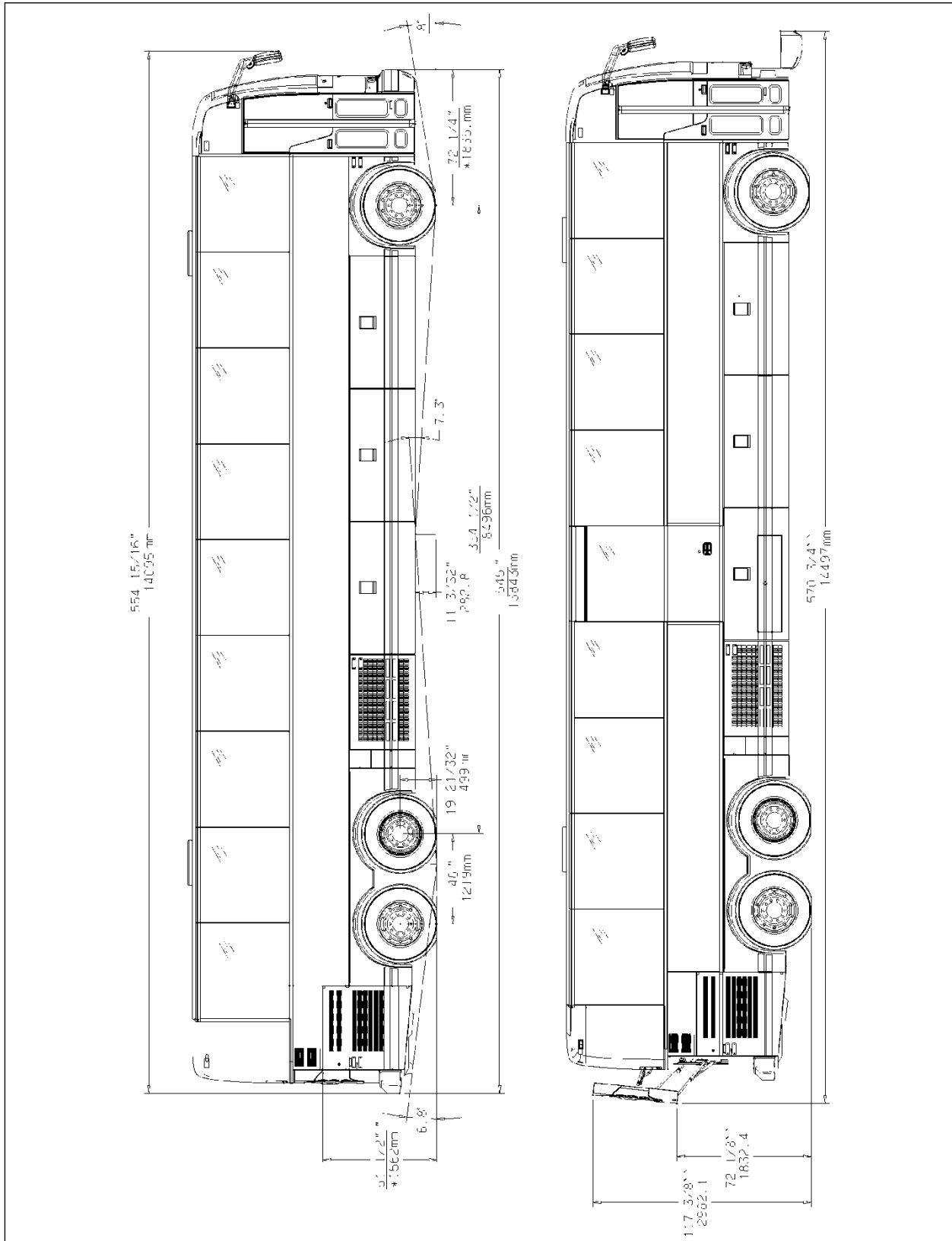

X3-45 COMMUTER OVERALL DIMENSIONS

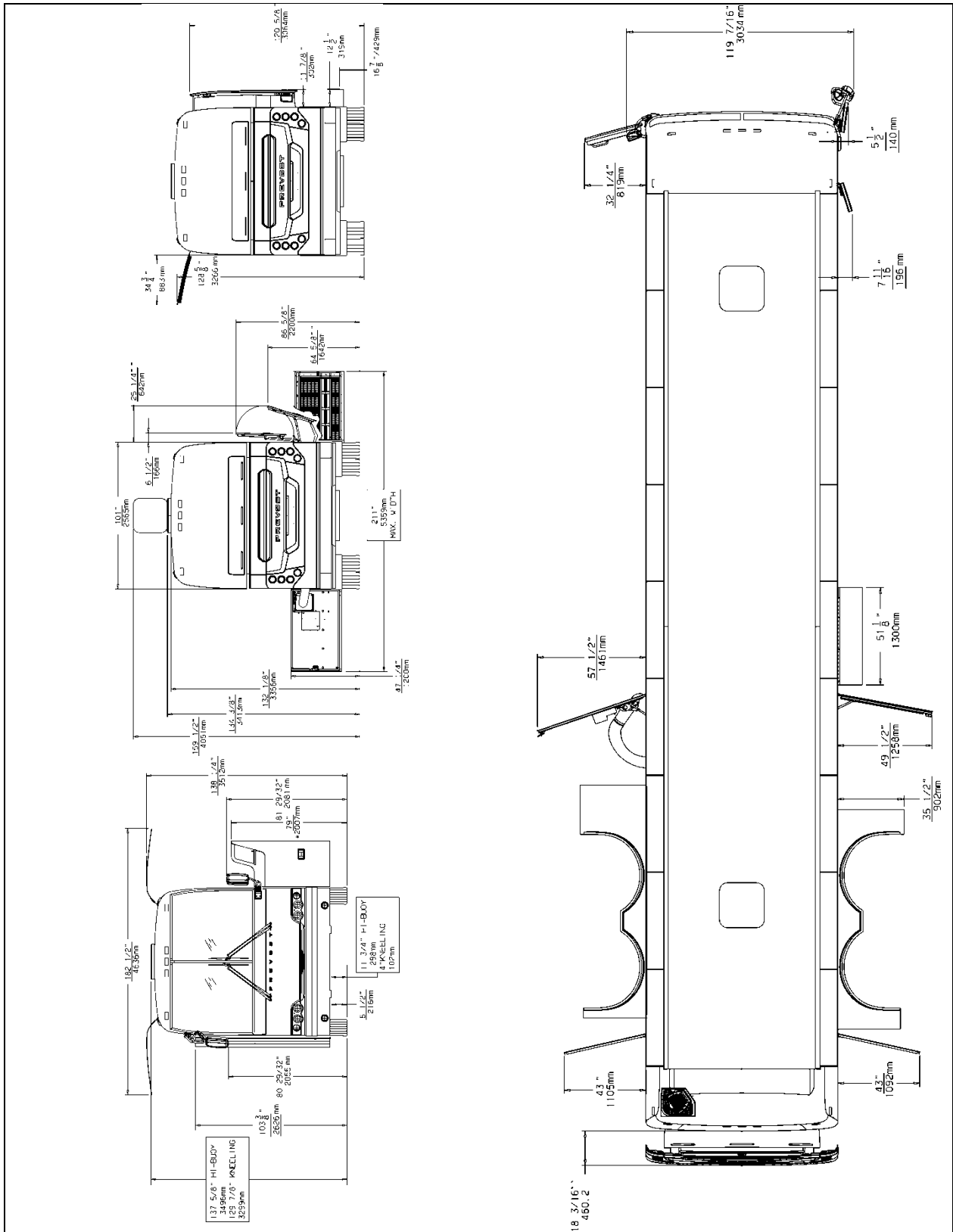

X3-45 COMMUTER OVERALL DIMENSIONS

9-4 TECHNICAL INFORMATION

DIMENSIONS, WEIGHTS AND CAPACITIES

DIMENSIONS AND WEIGHTS	
Overall length (including bumpers)	45 ft
Overall width	101 in
Overall height (hatches up)	138 in
Wheelbase (center of front axle to center of drive axle)	334 ½ in
Floor height from ground	48 ½ in
Ground clearance	11 in
First step height from ground	13 ½ in
Step height (other steps)	7 in
Headroom	80 in
Entrance door opening width	26 in
Front overhang	72 ¼ in
Rear overhang (tag axle down)	90 in
Front track	85.9 in
Drive track	76.7 in
Rear track (Tag axle)	83.6 in
Turning circle radius (I-Beam Axle)	47 ft 3 in
Curb weight	36,000 lbs
Gross Vehicle Weight Rating (G.V.W.R.)	48,000 lbs
Front axle Gross Axle Weight Rating (G.A.W.R.)	16,500 lbs
Drive axle (G.A.W.R.)	22,500 lbs
Tag axle (G.A.W.R.)	14,000 lbs

The Gross Vehicle Weight Rating (G.V.W.R.) and the Gross Axle Weight Rating (G.A.W.R.) for front drive and tag axles are listed on a certification plate located on the L.H. control panel in driver's section.

CAPACITIES	
Volvo D13 Engine oil (Total with filters)	41 U.S. qrts
Fuel tank (corresponding to 95% of gross capacity)	180 U.S. gal.
Cooling system	18.7 U.S. gal.
Diesel exhaust fluid (DEF)	15.9 U.S. gal.

CAPACITIES	
Allison Automatic Transmission (does not include external circuit)	6 U.S. gallons 6.9 U.S. gallons with retarder
Differential oil (approx)	19 qts
Power steering reservoir	4.0 qts
A/C compressor oil	2.8 qts (2.6L)
Windshield washer reservoir	5.3 U.S. gal.
Refrigerant	26 lb

FUEL TYPE

Diesel engines for 2007 and later model year vehicles are designed to operate only with **Ultra Low Sulfur Diesel** (ULSD) fuel, which can contain no more than 15 ppm sulfur.



CAUTION

ULSD fuel is necessary to avoid fouling the engine's Exhaust Aftertreatment System. Use of fuel other than ULSD will reduce the efficiency and durability of the engine.

BIODIESEL FUELS

Biodiesel up to a maximum of 20% blend (B20) may be used and will not affect the manufacturer's mechanical warranty as to engine and emissions system related components, provided the biofuel used in the blend conforms to ASTM D6751, B1 to B5 blends conform to ASTM D975, and B6 to B20 blends conform to ASTM D7467. Also, any engine performance problem related to the use of biodiesel fuel would not be recognized nor considered as Volvo or Prevost's responsibility.

However, Volvo engines are certified to comply with U.S. EPA and California emissions standards based upon the use of test fuels with specifications established by these regulatory agencies. Alternative fuels, including biodiesel, that are not substantially similar to the required test fuels may adversely affect engine emissions compliance. As a result, Volvo does not warrant the engine will conform to applicable Federal or California emissions limits when operated on biodiesel or other alternative fuels that are not substantially similar to specified test fuels used for certification.

WHEELS AND TIRES

Accuride steel wheels9" X 22½"

Tires 315/80 R22.5 load range "L"

RECOMMENDED TIRE INFLATION PRESSURE AT MAXIMUM COLD LOAD

The recommended tire inflation pressures are given in the applicable documents supplied with the vehicle. In addition, minimum cold tire inflation pressures are listed on the Department of Transport (DOT) certification plate, affixed on the left wall near the driver's seat.

	CAUTION
<p>These tire pressures are established in accordance with the maximum allowable load on each axle. A lower pressure is recommended if the axle load is less than the above specifications. Weigh vehicle fully loaded and pressurize according to tire manufacturer's recommendations. For non standard tire and wheel specifications, see Prevost tire pressure tabulation in "Coach Final Record".</p>	

	WARNING
<p>Special tire selection may lower maximum allowable speed limit, even below posted speed limit. For maximum safety, check with tire manufacturer.</p>	

BELTS

Use	Model	Qty
Cooling fan drive belt	Multi V-14 Rib 14PK2565	1
Bitzer A/C compressor	V Belt BX-71	2
Water pump	10PK1512	1
Alternator	Multi-V-8 Rib 8PK1575	1
Alternator (emergency)	8PK1512	1

NOTE
<i>Belts specifications may vary. For proper belt selection, always consult your vehicle Coach Final Record.</i>

VOLVO D13 ENGINE

Volvo D13 engine displacing 12.8 liters. The engine is an inline six cylinder, four stroke cycle, turbocharged, air to air charge cooled, diesel engine with SOHC with 4 valves per cylinder.

Power435 HP
 Torque..... 1,700 lbf•ft (2304 Nm)
 Operating range 1400-1800rpm
 Full dress, dry weight 2519 lb

ALLISON TRANSMISSION

Allison B500 (B500R with the optional output retarder) electronically controlled six speed automatic transmission.

Gear Ratios

1st3.510
 2nd 1.906
 3rd 1.429
 4th 1.000
 5th0.737
 6th 0.639
 Reverse..... 4.801
 Converter 1.9
 Differential ratio..... 3.82

PROPELLER SHAFT

Dana Spicer Life SPL250 type tubular shafts. It is provided with heavy-duty universal joints.

BRAKES

The features of the braking system include a dual system where the front and rear circuits are completely independent from each other. The brakes are air operated disc type brakes with automatic slack adjusters on front, drive and tag axles. The emergency/parking brakes are located on the drive axle.

BRAKE CHAMBER EFFECTIVE AREA

Front axle24 in²
 Drive axle 24/24 in² (service / emergency)
 Tag axle 16 in²

AIR SYSTEM

Compressed air is provided by a twin cylinder, 31.8 cfm Wabco, gear-driven, water-cooled and engine oil lubricated air compressor.

ANTILOCK BRAKING SYSTEM (ABS)

The antilock braking system has one Electronic Control Unit (ECU) controlling a four channel system. A wheel slip sensor is mounted at each front axle and drive axle wheel. The Tag axle wheels are slave to the drive axle wheels.

The Electronic Control Unit (ECU) is maintenance free. Its operating voltage is 24 ± 6 volts DC. The thermal operating range for the ECU is from -40 to 167°F (-40 to 75°C).

The solenoid control valves are maintenance free. Their operating voltage is 24 (+4.8, -2.4) volts DC. The rated current draw is 1.65 amps. The thermal operating range of the solenoid control valves is from -40 to 176°F (-40 to 80°C).

STEERING

- ZF 8098 integral hydraulic assisted steering gear;
- Volvo hydraulic pump gear driven from engine drive.
- Hydraulic reservoir and dipstick accessible from engine compartment.
- System pressure: 2320 psi (160 bars).
- Steering wheel diameter 18". Tilt steering wheel and telescopic steering column; pneumatically locked with foot operated switch for adjustment.
- Number of turns: 5¾.
- Outside turning radius: See Dimensions and Weight.

ELECTRICAL SYSTEM

- 24-volt, negative ground;
- 12-volt exterior lighting;
- Two 28 volts, 150 amp, self-regulated, belt-driven, air-cooled HD 10 Bosch alternators;
- Four 12 volt, Group 31 AGM batteries connected in series/parallel. Cold cranking capacity is 800 amps @ 0°F (-18°C) (each battery) with a reserve capacity of 200 minutes;
- 100 amp battery equalizer.

SUSPENSION

Goodyear rolling lobe type air springs (bellows) are used throughout.

I-BEAM AXLE FRONT SUSPENSION

- 2 Bellows (12"); for a G.A.W.R. of 16,500 lb;
- 2 Shock absorbers;
- 4 Radius rods;
- 1 Transverse radius rod;
- 1 Height control valve.
- 1 sway bar (1¾" diameter).

DRIVE AXLE

- 4 Bellows (11");
- 4 Shock absorbers;
- 3 Radius rods;
- 1 Panhard rod;
- 2 Height control valves.

TAG AXLE

- 2 Bellows (11");
- 2 Shock absorbers;
- 3 Radius rods;
- 1 Panhard rod.

ALIGNMENT SPECIFICATIONS

Use static wheel alignment systems which work with angle measurements only, such as Josam or Hunter systems. Static alignment specifications are listed in the following tables:

I-BEAM AXLE FRONT SUSPENSION			
	Minimum value	Nominal value	Maximum value
Right camber	-0.250°	0.125°	0.375°
Left camber	-0.250°	0.125°	0.375°
Right caster	2.0°	2.75°	3.5°
Left caster	2.0°	2.75°	3.5°
Total toe	0.04°	0.06°	0.08°

DRIVE AXLE ZF A-132			
	Minimum value	Nominal value	Maximum value
Thrust angle	±0.11°		
Total toe	0.15° toe-in	0°	0.15° toe-out

TAG AXLE			
	Minimum value	Nominal value	Maximum value
Thrust angle* (degrees)	-0.02	0	0.02
Total toe	0.08° toe-in	0°	0.02° toe-out

(*) Use the drive axle as reference

COOLING SYSTEM

- Extra capacity, copper fin radiator and aluminum charge air cooler arranged one behind the other.
- 3 speed fan clutch engine ECM controlled.
- Rubber insulated from the body.
- Expansion tank above radiator and remote mounted.
- System pressure 13 psi.
- 185° F thermostat.
- System capacity 24 us gal.
- Coolant filter.
- Radiator fan: 38 inches fan belt and drive shaft driven.

FUEL SYSTEM

Steel fuel tank

Fuel legal capacity (corresponding to 95% of gross capacity): 180 US gallons (681 liters).

Unusable fuel: 6.3 US gallons (24 liters).

Equipped with:

- Emco Wheaton fuel filling system.
- Provided with filling access on the right side of the coach with safety filler cap.
- Pressure relief valve.
- Electric fuel gauge.

- Low level signal at 26 US gallons/98.4 liters.
- Primary filter 25 microns (standard).
- Primary fuel filter with electrical water indicator (Volvo D13).
- Secondary filter 3 to 5 microns.
- Shut-off valve on fuel supply line.

EXHAUST SYSTEM

One all stainless steel exhaust aftertreatment system including:

- Catalytic converter to reduce NOx.
- FleetGuard assembly made of a DOC (Diesel Oxidation Catalyst and a DPF (Diesel Particulate Filter). Noise, vibration and heat insulated. This assembly is mounted to the bus structure and is accessible through an exterior access door.
- Tail pipe diffuser and rain deviation device.
- Exhaust pipe with insulation and a flexible section.
- Exhaust to rear left hand top of rear cap.
- Diesel exhaust fluid (DEF) tank (15.9 gal.) and injection system.

HEATING AND AIR CONDITIONING

The large capacity A/C provides adequate capacity of conditioned and filtered air for all climatic conditions. Fresh air is drawn into the system from the left (driver's) side of the vehicle. Return air is taken from the middle of the vehicle. The driver's heater and defogger are controlled separately from the central unit. An air mixture selector enables air to be drawn into the system from outside the vehicle or recirculated.

CENTRAL A/C	
Air conditioning capacity	9 tons
Refrigerant type	134A
Heating capacity	152 000 Btu/h
Air flow, overhead parcel rack evap.	450 cfm (12,7 m ³ /min)
Air flow, main A/C	2 600 cfm (73,6 m ³ /min)

9-8 TECHNICAL INFORMATION

COMPRESSOR (for central A/C)	
Make and model	Bitzer 4NFCY
Number of cylinders	4
Operating speed	500-3500 rpm
Oil capacity	2.6 quarts (2.5L)
Approved oil	Polyolester (ISO68) Bitzer BSE55 (POE)

OIL SPECIFICATIONS

ENGINE

Use Total Rubia TIR 10W-30 FE for best fuel economy. SAE 5W-30 & 15W-40 oils, meeting VDS-4 and CJ4, are also approved. CJ-4 is required in 2010 and later diesel engines.

The Volvo D13 engine oil specification is designated EO-O Premium Plus (or VDS-4). EO-O Premium Plus oils exceed the new API service category CJ-4.

ALLISON TRANSMISSION

Allison Transmission recommends the following fluids:

- Castrol TranSynd™ or TES-295 specification equivalent fluid;
- TES-389 specification equivalent fluid.

DIFFERENTIAL

Mobil Delvac synthetic gear oil 80W140.

FAN RIGHT ANGLE GEARBOX

Use Shell synthetic transmission oil MA 75W90 or equivalent.

POWER STEERING

Use Automatic Transmission Fluid Mobil DEXRON-VI ATF.

PLATES AND CERTIFICATION

The main components of the vehicle such as engine, transmission, axles and chassis are identified by different serial numbers. It may be necessary to locate these numbers for warranty purposes.

The engine data plate is located on the rocker cover. The engine serial and model number and a list of the optional engine equipment are

written on this plate. Refer to this information when ordering replacement parts. Also the engine data plate certifies that the engine conforms to federal and any state exhaust emissions regulations.

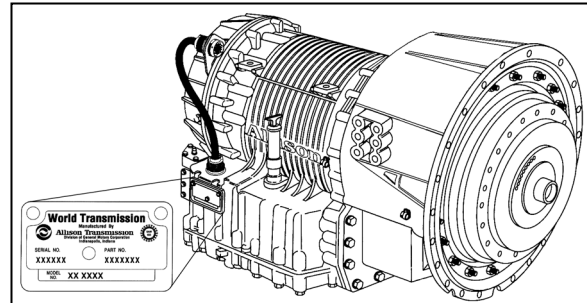

ALLISON TRANSMISSION

07076

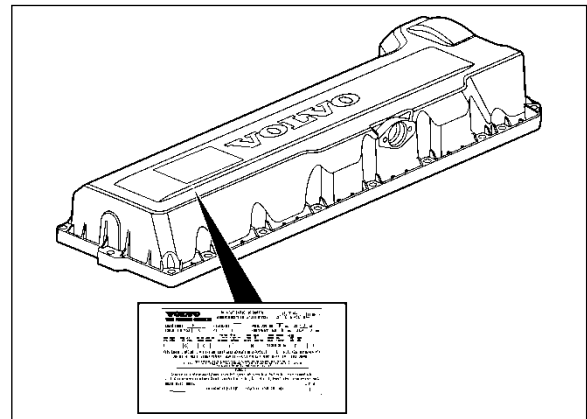

VOLVO D13 ENGINE DATA PLATE

00052

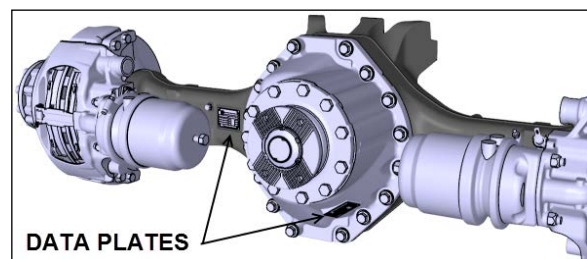

DATA PLATES

DRIVE AXLE

00007

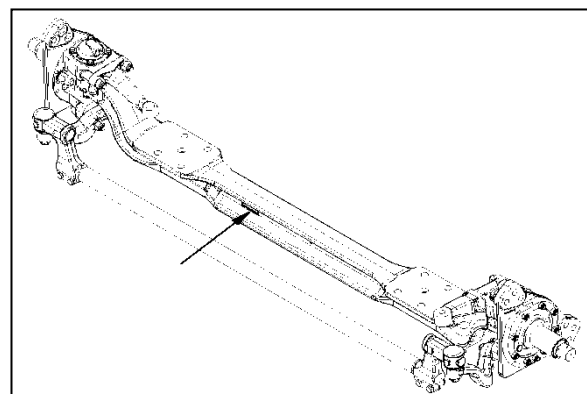

I-BEAM FRONT AXLE



00008

SAFETY CERTIFICATION

- Vehicle components meet specifications and standards as follows:
- Material and parts conform to ASTM and/or SAE standards in effect at the time of manufacture.
- All factory-installed interior materials meet FMVSS 302 for fire resistance.
- Certified according to Provincial, State and Federal Safety standards (Canadian and US) BMCSS, FMVSS and CMVSS.
- Other applicable certification labels are affixed to the component.

DOT CERTIFICATION PLATE

This certifies that vehicles manufactured by Prevost Car Inc. comply with all Federal Motor Vehicle Safety Standards at the time of manufacture. Information such as date of manufacture, model year, gross vehicle weight rating, tire types and inflation pressure is also etched on this plate. The DOT Certification plate is affixed to L.H. control panel.

		PREVOST			
MANUFACTURED BY : PREVOST FABRIQUE PAR : STE-CLAIRE, QUE.		DATE OF MFG. DATE DE FAB.			
G. V. W. R. : 21772 KG. (48000 LBS). P. N. B. V. :					
AXLES/ ESSEUX	G. A. W. R. / P. N. B. E. /	TIRES / PNEUS	RIMS / JANTES	COLD INFLATION PRESS. / A FROID	SINGLE OR DOUBLE SIMPLE OU DOUBLE
	KG (LBS)			KPA (PSI)	
FRONT:	7484 (16500)	315/80R22.5 (J)	22.5X9	827 (120)	S
INT. DIFF.:	10206 (22500)	315/80R22.5 (J)	22.5X9	586 (85)	D
REAR TANDEN:	6350 (14000)	315/80R22.5 (J)	22.5X9	689 (100)	S
THIS VEHICLE CONFORMS TO ALL APPLICABLE U.S. FEDERAL MOTOR VEHICLE SAFETY STANDARDS IN EFFECT ON THE DATE OF MANUFACTURE SHOWN ABOVE.					
VEHICLE IDENTIFICATION NO. NO. IDENTIFICATION VEHICULE		<input type="text" value="407644"/>			
		TYPE: BUS B/A		407644	

DOT CERTIFICATION PLATE 00016

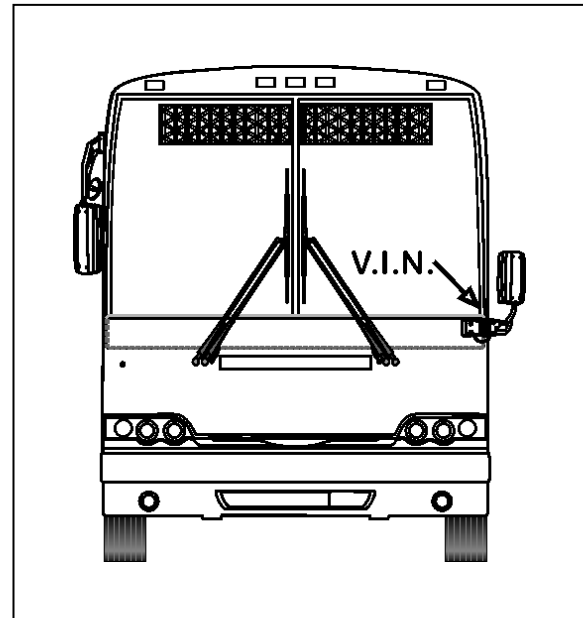

VEHICLE IDENTIFICATION NUMBER 00044

NOTE

Record the VIN in the vehicle documentation and keep with company records. The VIN will normally be used for vehicle registration, service reference needs and for obtaining vehicle insurance coverage.

COACH FINAL RECORD

The Coach Final Record is a record of all data pertaining to the assembly of the vehicle. This record is shipped to the new customer via a courier company. Retain this record in the company records office for reference and safe-keeping.

VEHICLE IDENTIFICATION NUMBER (VIN)

The Vehicle Identification Number is stamped on a plate located on the windshield frame pillar (driver's side). The VIN is visible from the outside of the vehicle. Make sure the correct vehicle identification number is given when ordering replacement parts. Using the VIN when ordering parts will facilitate processing.

SECTION 10 ABBREVIATIONS

ABS	Antilock Brake System
A/C	Air Conditioning
ACM	Aftertreatment Control Module
AFSS	Automatic Fire Suppression System
DEF	Diesel Exhaust Fluid
DID	Driver Information Display
DPF	Diesel Particulate Filter
DTC	Diagnostic Troubleshooting Code
ECM	Engine Control Module
ECU	Electronic Control Unit
EECU	Engine Electronic Control Unit
EGR	Exhaust Gas Recirculation
ESC	Escape
GECU	Gear selector Electronic Control Unit
HVAC	Heating, Ventilation and Air Conditioning
LED	Light Emitting Diode
MCM	Master Chassis Module
MPH	Miles Per Hour
PTT	Premium Tech Tool
PRIME	Power Recovery by Intelligent Management of Energy
SCR	Selective Catalytic Reduction
TCM	Transmission Control Module
TCS	Traction Control System
TECU	Transmission Electronic Control Unit
TWS	Threshold Warning System
ULSD	Ultra Low Sulfur Diesel
VCADS	Diagnostic Tool
VECF	Vehicle Electrical Center Front
VECR	Vehicle Electrical Center Rear
VECU	Vehicle Electronic Control Unit
WCL	Wheelchair Lift

SECTION 11 APPENDIX A - SERVICE LITERATURE

SERVICE LITERATURE 2

NOTICE 3

DECLARATION OF THE MANUFACTURING DEFECTS TO THE GOVERNMENT OF THE UNITED STATES 3

DECLARATION OF THE MANUFACTURING DEFECTS TO THE CANADIAN GOVERNMENT 3

DECLARATION OF THE MANUFACTURING DEFECTS TO PREVOST 3

SERVICE LITERATURE

Visit our web site at www.prevostcar.com for on-line product information and technical publications!

Additional copies of the following service literature are available on request and at low cost. These can be helpful to mechanics and drivers alike.

- * **Maintenance Manual**
- * **Operator's Manual**
- * **Parts Manual**
- * **Service Center Directory**

To order, call Prevost Parts toll free 1-800-463-8876 or write to:

PREVOST PARTS INC.

2955-A Watt Street
Sainte-Foy, (Quebec)
Canada G1X 3W1

Specify the complete vehicle serial number. Allow 30 days for delivery

NOTICE

DECLARATION OF THE MANUFACTURING DEFECTS TO THE GOVERNMENT OF THE UNITED STATES

If you believe that your vehicle has defect which could cause a crash or could cause injury or death, you should immediately inform the National Highway Traffic Safety Administration (NHTSA) in addition to notifying Prevest.

If NHTSA receives similar complaints, it may open an investigation, and if it finds that a safety defect exists in a group of vehicles, it may order a recall and remedy campaign.

However, NHTSA cannot become involved in individual problems between you, your dealer, or Prevest Car Inc.

To contact NHTSA you may either call the Auto Safety Hotline toll-free at **1-800-424-9393** (or **366-0123** in Washington, D.C. area) or write to:

**NHTSA
U.S. Department of transportation
Washington, D.C. 20590.**

You can also obtain other information about motor vehicle safety from the Hotline.

DECLARATION OF THE MANUFACTURING DEFECTS TO THE CANADIAN GOVERNMENT

If you live in Canada, and if you believe that your vehicle has a safety defect, you should immediately inform Transport Canada and Prevest. You may write to:

**Transport Canada
Box 8880
Ottawa, Ontario, K1G 3J2**

DECLARATION OF THE MANUFACTURING DEFECTS TO PREVOST.

In addition to notify the NHTSA (or Transport Canada), please contact Prevest at **1-418-831-2046**. Or you may write to:

**Prevest
After-sales service department
850 Olivier Road,
Saint-Nicolas (Quebec)
Canada, G7A 2N1**

**SECTION 12 APPENDIX B – ALLISON TRANSMISSION’S
OTHER FEATURES**

**ALLISON TRANSMISSION 5TH GENERATION OIL LEVEL CHECK USING THE PUSHBUTTON SHIFT
SELECTOR..... 2**

DIAGNOSTIC TROUBLESHOOTING CODES (DTC) — ALLISON 5TH GENERATION..... 3

 DIAGNOSTIC TROUBLESHOOTING CODES (DTC) OVERVIEW 3

 USING SHIFT SELECTOR FOR ACCESSING DIAGNOSICS INFORMATION 3

 DIAGNOSTIC TROUBLE CODE RESPONSE 4

 DIAGNOSTIC TROUBLESHOOTING CODES (DTC) LIST - ALLISON 5TH GENERATION CONTROLS 5

ALLISON TRANSMISSION 5th GENERATION OIL LEVEL CHECK USING THE PUSHBUTTON SHIFT SELECTOR

The oil level sensor (OLS) is standard in your transmission. With the OLS and Allison 5th generation shift selector, you can get a more accurate electronic fluid level check than with a dipstick.

Oil level codes are obtained as follows:

1. Park vehicle on a level surface, select «N» (neutral) on the pushbutton shift selector and apply parking brake.
2. Wait for at least 2 minutes to allow the oil to settle;
3. Press simultaneously the ▲ (Upshift) and ▼ (Downshift) arrow buttons once.
4. Oil level codes are displayed once the following parameters are met :
 - **The vehicle has been stationary for approximately 2 minutes to allow the oil to settle;**
 - **Engine at idle;**
 - **Oil at normal operating temperature, between 104°F (40°C) and 220°F (104°C);**
 - **Transmission in «N» (Neutral);**
 - **Transmission output shaft stopped;**
 - **Oil level sensor present and working.**

5. Correct fluid level is displayed as shown.



6. Low fluid level is displayed as shown. The number indicates the number of quarts of fluid



the transmission requires.

7. High fluid level condition with the number of quarts in excess is displayed as shown.



NOTE

Confirm a low fluid level condition by making a manual fluid level check.

8. To exit the Oil Level Display Mode, press any range button «R», «N» or «D» at any time.

NOTE

Note that the quantities LO 4 and HI 3 are the largest values displayed and that the actual variation in oil level may exceed these numbers.

If the fluid level check cannot be completed, an Invalid for Display fault is reported. Refer to table below to review the codes and conditions.

CODE	CAUSE OF FAULT CODE
SETTLING OX	Settling time too short
ENG RPM TOO LOW	Engine speed (rpm) too low
ENG RPM TOO HIGH	Engine speed (rpm) too high
MUST BE IN NEU	N (Neutral) must be selected
OIL TEMP TOO LOW	Sump fluid temperature too low
OIL TEMP TOO HIGH	Sump fluid temperature too high
VEH SPD TOO HI	Output shaft speed
SENSOR FAILED	Sensor failure

DIAGNOSTIC TROUBLESHOOTING CODES (DTC) — ALLISON 5TH GENERATION

DIAGNOSTIC TROUBLESHOOTING CODES (DTC) OVERVIEW

Diagnostic features are provided with the transmission control system to assist in troubleshooting of malfunctions and/or the monitoring of specific operating parameters. When a control system malfunction is detected, a series of Diagnostic Trouble Codes (DTCs) are used to identify and clarify the nature of the malfunction. These DTCs are each named by a 5 character alphanumeric string that refers to a diagnostic algorithm running pass/fail tests to help identify a malfunction in the transmission or vehicle operation. Most DTCs have some kind of diagnostic response that the operator notices, such as an illuminated CHECK light, selector display change, lock in range, or inhibit shifts condition.

DTCs are logged in the Transmission Control Module (TCM) memory by severity and by their active/inactive status with the most severe and active codes listed first. A maximum of five DTCs (numbered d1- d5) from most recent to oldest may be read from the shift selector. As DTCs are added, the oldest inactive DTC (historic) is dropped from the list. If all DTCs are active, the DTC with the lowest priority is dropped from the list.

An active code is any code that is current in the TCM decision-making process and has failed the DTC test(s) associated with that specific diagnostic algorithm. Historical codes, which are by definition inactive, are codes that are no longer failing their algorithm but are retained in the TCM in order to help the technician analyze possible causes and provide them direction if the vehicle is brought in before they are cleared from the queue.

DTCs can be cleared manually by the operator or they clear automatically from last (d5) to first (d1) in the queue after a number of engine starts, without becoming active again.

USING SHIFT SELECTOR FOR ACCESSING DIAGNOSICS INFORMATION

DTCs can be displayed on the display portion of the shift selector. A DTC is either active or historic. An active DTC is a DTC that is current in the TCM decision-making process. Historic DTCs are retained in the TCM memory and do not necessarily affect the TCM decision-making process.

Display Sequence

Up to five DTCs may be displayed one at a time from the selector once the diagnostic display mode has been initiated by the operator. Each DTC is 5 characters in length. The DTC status active or inactive is shown below the DTC.



Shows active DTC P0730

The operator presses the MODE button to read the next DTC in the queue (if any) or requests to exit diagnostics mode. The diagnostics mode times out and returns the selector to normal operating mode after approximately 10 minutes of operator inactivity.

Diagnostic Code Display and Clearing Procedure

Diagnostic codes can be read and cleared by two methods:

- Using an Allison DOC™ diagnostic tool. For specific instructions on how to use an Allison DOC™ diagnostic tool, refer to the User Guide.
- Using the pushbutton shift selector.

To begin the diagnostic process:

1. Bring the vehicle to a stop at a safe location.
2. Apply the parking brake.

12-4 APPENDIX B – Allison Transmission’s Other Features

To display stored codes:

1. Simultaneously press the ▲ (Upshift) and ▼ (Downshift) arrow buttons five times (Prognostics enabled) to access the Diagnostic Display Mode. With Prognostics disabled, press the ▲ (Upshift) and ▼ (Downshift) arrow buttons twice.
2. Press the MODE button to read the next code in the queue, if any.

To clear all active stored codes:

While in Diagnostic Mode, clear all active codes by pressing and holding the MODE button for approximately three seconds until the MODE message flashes. Release the MODE button. The MODE message should not remain illuminated if the active DTC shown in the display has cleared.

While in Diagnostic Mode, press and hold the MODE button for 10 seconds to clear both active codes and inactive codes. The MODE message flashes a second time indicating all codes are cleared from the queue.

Exiting Diagnostic Mode

Exit the diagnostic mode by one of the following methods:

1. Press simultaneously the ▲ (Upshift) and ▼ (Downshift) arrow buttons at the same time on the pushbutton shift selector.
2. Press any range button «D», «N» or «R» on the pushbutton shift selector.
3. After approximately 10 minutes of inactivity at the pushbutton shift selector, the diagnostic mode automatically exits and returns to normal operating mode.
4. Turn off power to the TCM (shut off the engine using the ignition key).

NOTE

<i>Be sure to record all codes displayed before they are cleared. This is essential for troubleshooting.</i>

NOTE

<i>If clearing a code while locked in a «D» (Drive) or «R» (Reverse) position (fail-to-range), the transmission will still be in «D» (Drive) or «R» (Reverse) when the clearing procedure is completed. «N» (Neutral) must be manually selected.</i>

DIAGNOSTIC TROUBLE CODE RESPONSE

The electronic control system is programmed to inform the operator of a problem with the transmission system via the CHECK light and shift selector display while it automatically takes action to protect the operator, vehicle, and transmission. When the Transmission Control Module (TCM) flags a Diagnostic Trouble Code (DTC) as active, the TCM may take a combination of diagnostic responses as listed in the table below.

CATEGORY OF RESPONSE	ACTIONS TAKEN
DNS - <u>Do Not Shift</u>	Release lock up (LU) clutch and inhibit lock up operation. Inhibit shifts from the current attained range. Turn on the CHECK light. Display the current attained range in the MONITOR window of the shift selector. Blank the SELECT window of the shift selector. Ignore any range selection inputs from the shift selector.
SOL OFF - <u>SOLenoid OFF</u>	All solenoids are commanded off, resulting in hydraulic default operation of the transmission – PCS1 & PCS2 are on hydraulically when off electrically.
RPR - Return to Previous Range	When the speed sensor ratio or PS1 tests do not pass, the TCM commands the same range as commanded before the shift.
NNC - Neutral No Clutches	When certain speed sensor ratio or PS1 tests do not pass, the TCM commands a neutral condition with no clutches applied.
DNA - <u>Do Not Adapt</u>	The TCM stops adaptive shift control while the code is active.

DIAGNOSTIC TROUBLESHOOTING CODES (DTC) LIST - ALLISON 5TH GENERATION CONTROLS

DTC	Description	CHECK Light	Inhibited Operation Description
C1312	Retarder Request Sensor Failed Low	No	May inhibit retarder operation if not using J1939 datalink
C1313	Retarder Request Sensor Failed High	No	May inhibit retarder operation if not using J1939 datalink
P0122	Pedal Position Sensor Circuit Low Voltage	No	Use default throttle values. Freezes shift adapts.
P0123	Pedal Position Sensor Circuit High Voltage	No	Use default throttle values. Freezes shift adapts.
P0218	Transmission Fluid Over Temperature	Yes	Use default sump temp
P0562	System Voltage Low	No	Inhibit TCC Operation, DNA
P0602	TCM Not Programmed	Yes	Lock in Neutral
P0604	Control module random access memory (RAM)	Yes	Lock in Neutral
P0614	Torque Control Data Mismatch - ECM/TCM	Yes	Allows operation only in reverse and second range.
P0634	TCM Internal Temperature Too High	Yes	SOL OFF (hydraulic default)
P0642	Sensor Reference Voltage "A" Circuit Low	Yes	Default sensor data used
P0643	Sensor Reference Voltage "A" Circuit High	Yes	Default sensor data used
P0657	Actuator Supply Circuit Voltage 1 Open (HSD 1)	Yes	SOL OFF, DNA, Inhibit TCC operation, Inhibit main modulation
P0658	Actuator Supply Voltage 1 (HSD1) Low	Yes	DNS, SOL OFF (hydraulic default)
P0659	Actuator Supply Voltage 1 (HSD1) High	Yes	DNS, SOL OFF (hydraulic default)
P0703	Brake Switch Circuit Malfunction	No	No Neutral to Drive shifts for refuse packer. TCM inhibits retarder operation if a TPS code is also active.
P0708	Transmission Range Sensor Circuit High Input	Yes	Ignore defective strip selector inputs
P070C	Transmission Fluid Level Sensor Circuit – Low Input	No	None
P070D	Transmission Fluid Level Sensor Circuit – High Input	No	None

12-6 APPENDIX B – Allison Transmission’s Other Features

DTC	Description	CHECK Light	Inhibited Operation Description
P0712	Transmission Fluid Temperature Sensor Circuit Low Input	Yes	Use default sump temp
P0713	Transmission Fluid Temperature Sensor Circuit High Input	Yes	Use default sump temp
P0715	Turbine Shaft Speed Sensor Circuit	Yes	DNS, Lock in current range
P0716	Turbine Shaft Speed Sensor Circuit Performance	Yes	DNS, Lock in current range
P0717	Turbine Shaft Speed Sensor Circuit No Signal	Yes	DNS, Lock in current range
P071A	RELS Input Failed On	Yes	Inhibit RELS operation
P071D	General Purpose Input Fault	Yes	None
P0720	Output Shaft Speed Sensor Circuit	Yes	DNS, Lock in current range
P0721	Output Shaft Speed Sensor Circuit Performance	Yes	DNS, Lock in current range
P0722	Output Speed Sensor Circuit No Signal	Yes	DNS, Lock in current range
P0725	Engine Speed Sensor Circuit	No	Default to turbine speed
P0726	Engine Speed Sensor Circuit Performance	No	Default to turbine speed
P0727	Engine Speed Sensor Circuit No Signal	No	Default to turbine speed
P0729	Incorrect 6 th Gear Ratio	Yes	DNS, Attempt 5 th , then 3 rd
P0731	Incorrect 1 st Gear ratio	Yes	DNS, Attempt 2 nd , then 5 th
P0732	Incorrect 2 nd Gear ratio	Yes	DNS, Attempt 3 rd , then 5 th
P0733	Incorrect 3 rd Gear ratio	Yes	DNS, Attempt 4 th , then 6 th
P0734	Incorrect 4 th Gear ratio	Yes	DNS, Attempt 5 th , then 3 rd
P0735	Incorrect 5 th Gear ratio	Yes	DNS, Attempt 6 th , then 3 rd , then 2 nd
P0736	Incorrect Reverse Gear ratio	Yes	DNS, Lock in Neutral
P0741	Torque Converter Clutch System Stuck Off	Yes	None
P0752	Shift Solenoid 1 Valve Performance-Stuck On	Yes	DNS
P0776	Pressure Control Solenoid (PCS) 2 Stuck Off	Yes	DNS, RPR
P0777	Pressure Control Solenoid 2 Stuck On	Yes	DNS, RPR
P0796	Pressure Control Solenoid 3 Stuck Off	Yes	DNS, RPR
P0797	Pressure Control Solenoid 3 Stuck On	Yes	DNS, RPR
P0842	Transmission Fluid Pressure Switch 1 Circuit Low	Yes	DNS, Lock in current range
P0843	Transmission Fluid Pressure Switch 1 Circuit High	Yes	DNS, Lock in current range
P0847	Transmission Fluid Pressure Switch 2 Circuit Low	Yes	None
P0848	Transmission Fluid Pressure Switch 2 Circuit High	Yes	None
P088A	Transmission Fluid Filter Maintenance Alert	No	None
P088B	Transmission Fluid Filter Maintenance Required	No	None
P0880	TCM Power Input Signal	No	None
P0881	TCM Power Input Signal Performance	No	None
P0882	TCM Power Input Signal Low	Yes	DNS, SOL OFF (hydraulic default)
P0883	TCM Power Input Signal High	No	None
P0894	Unexpected Mechanical Gear Disengagement	Yes	DNS, Lock in first
P0897	Transmission Fluid Deteriorated	No	None
P0960	Main Pressure Modulator Solenoid Control Circuit Open	Yes	None
P0962	Main Pressure Modulator Solenoid Control Circuit Low	Yes	DNS, SOL OFF (hydraulic default)
P0963	Main Pressure Modulator Solenoid Control Circuit High	Yes	None
P0964	Pressure Control Solenoid 2 (PCS2) Control Circuit Open	Yes	DNS, SOL OFF (hydraulic default)
P0966	Pressure Control Solenoid 2 (PCS2) Control Circuit Low	Yes	DNS, SOL OFF (hydraulic default)
P0967	Pressure Control Solenoid 2 (PCS2) Control Circuit High	Yes	DNS, SOL OFF (hydraulic default)

DTC	Description	CHECK Light	Inhibited Operation Description
P0968	Pressure Control Solenoid 3 (PCS3) Control Circuit Open	Yes	DNS, SOL OFF (hydraulic default)
P0970	Pressure Control Solenoid 3 (PCS3) Control Circuit Low	Yes	DNS, SOL OFF (hydraulic default)
P0971	Pressure Control Solenoid 3 (PCS3) Control Circuit High	Yes	DNS, SOL OFF (hydraulic default)
P0973	Shift Solenoid 1 (SS1) Control Circuit Low	Yes	DNS, SOL OFF (hydraulic default)
P0974	Shift Solenoid 1 (SS1) Control Circuit High	Yes	DNS, SOL OFF (hydraulic default)
P0976	Shift Solenoid 2 (SS2) Control Circuit Low	Yes	7-speed: Allow 2 through 6, N, R Inhibit TCC operation
P0977	Shift Solenoid 2 (SS2) Control Circuit High	Yes	7-speed: Allow 2 through 6, N, R
P097A	Shift Solenoid 1 (SS1) Control Circuit Open	Yes	Lock in range
P097B	Shift Solenoid 2 (SS2) Control Circuit Open	Yes	7-speed: Allow 2 through 6, N, R
P0989	Retarder Pressure Sensor Circuit Low	No	None
P0990	Retarder Pressure Sensor Circuit High	No	None
P1739	Incorrect Low Gear Ratio	Yes	Command 2 nd and allow shifts 2 through 6, N, R
P1790	Gear Shift Module 1 Calibrated Invalid	Yes	Shift selector language or units incorrect
P1791	Gear Shift Module 2 Calibrated Invalid	Yes	Shift selector language or units incorrect
P1891	Throttle Position Sensor PWM Signal Low	No	Use default throttle values
P1892	Throttle Position Sensor PWM Signal High	No	Use default throttle values
P2184	Engine Coolant Temperature Sensor 2 Circuit Low Input	No	Use default engine coolant values
P2185	Engine Coolant Temperature Sensor 2 Circuit High Input	No	Use default engine coolant values
P2637	Torque Management Feedback Signal (A)	Yes	Inhibit SEM
P2641	Torque Management Feedback Signal (B)	Yes	Inhibit L RTP
P2669	Actuator Supply Circuit Voltage 2 Open (HSD2)	Yes	SOL OFF, Inhibit TCC operation, Inhibit Main modulation, ONA
P2670	Actuator Supply Voltage 2 (HSD2) Low	Yes	DNS, SOL OFF (hydraulic default)
P2671	Actuator Supply Voltage 2 (HSD2) High	Yes	DNS, SOL OFF (hydraulic default)
P2684	Actuator Supply Circuit Voltage 3 Open (HSD3)	Yes	SOL OFF, Inhibit TCC operation, Inhibit Main modulation, ONA
P2685	Actuator Supply Voltage 3 (HSD3) Low	Yes	DNS, SOL OFF (hydraulic default)
P2686	Actuator Supply Voltage 3 (HSD3) High	Yes	DNS, SOL OFF (hydraulic default)
P2714	Pressure Control Solenoid 4 (PCS4) Stuck Off	Yes	DNS, RPR
P2715	Pressure Control Solenoid 4 (PCS4) Stuck On	Yes	DNS, SOL OFF (hydraulic default)
P2718	Pressure Control Solenoid 4 (PCS4) Control Circuit Open	Yes	DNS, SOL OFF (hydraulic default)
P2720	Pressure Control Solenoid 4 (PCS4) Control Circuit Low	Yes	DNS, SOL OFF (hydraulic default)
P2721	Pressure Control Solenoid 4 (PCS4) Control Circuit High	Yes	DNS, SOL OFF (hydraulic default)
P2723	Pressure Control Solenoid 1 (PCS1) Stuck Off	Yes	DNS, RPR
P2724	Pressure Control Solenoid 1 (PCS1) Stuck On	Yes	DNS, RPR
P2727	Pressure Control Solenoid 1 (PCS1) Control Circuit Open	Yes	DNS, SOL OFF (hydraulic default)
P2729	Pressure Control Solenoid 1 (PCS1) Control Circuit Low	Yes	DNS, SOL OFF (hydraulic default)
P2730	Pressure Control Solenoid 1 (PCS1) Control Circuit High	Yes	DNS, SOL OFF (hydraulic default)
P2736	Pressure Control Solenoid 5 (PCS5) Control Circuit Open	Yes	Inhibit retarder operation
P2738	Pressure Control Solenoid 5 (PCS5) Control Circuit Low	Yes	Allow 2 through 6, N, R. Inhibit retarder and TCC operation
P2739	Pressure Control Solenoid 5 (PCS5) Control Circuit High	Yes	Inhibit retarder operation

12-8 APPENDIX B – Allison Transmission’s Other Features

DTC	Description	CHECK Light	Inhibited Operation Description
P273F	Retarder Oil Temperature Sensor Over Temperature Condition	No	None
P2742	Retarder Oil Temperature Sensor Circuit – Low	No	Use default retarder temp values
P2743	Retarder Oil Temperature Sensor Circuit – High	No	Use default retarder temp values
P2761	TCC PCS Control Circuit Open	Yes	Inhibit TCC operation
P2763	TCC PCS Control Circuit High	Yes	Inhibit TCC operation
P2764	TCC PCS Control Circuit Low	Yes	7-speed: Allow 2 through 6, N, R. Inhibit TCC operation
P2789	Transmission Clutch Life Expired (Clutch Adaptive Learning at Limit)	No	None
P2793	Gear Shift Direction Circuit	Yes	Ignores PWM input from shift selector
P2808	Pressure Control Solenoid 6 (PCS6) Stuck Off	Yes	DNS, RPR
P2809	Pressure Control Solenoid 6 (PCS6) Stuck On	Yes	DNS, RPR
P2812	Pressure Control Solenoid 6 (PCS6) Control Circuit Open	Yes	DNS, SOL OFF (hydraulic default)
P2814	Pressure Control Solenoid 6 (PCS6) Control Circuit Low	Yes	DNS, SOL OFF (hydraulic default)
P2815	Pressure Control Solenoid 6 (PCS6) Control Circuit High	Yes	DNS, SOL OFF (hydraulic default)
U0073	CAN Communication Bus 1 Off	No	Use default values
U0074	CAN Communication Bus 2 Off	No	Use default values
U0100	Lost Communications with ECM A	Yes	Use default values
U0103	Lost Communication with Gear Shift Module (Shift Selector) 1	Yes	Maintain range selected, observe gear shift direction circuit
U0291	Lost Communication with Gear Shift Module (Shift Selector) 2	Yes	Maintain range selected, observe gear shift direction circuit
U0304	Incompatible Gear Shift Module 1 (Shift Selector)	Yes	Ignore shift selector inputs
U0333	Incompatible Gear Shift Module 2 (Shift Selector)	Yes	Ignore shift selector inputs
U0404	Invalid Data Received From Gear Shift Module (Shift Selector) 1	Yes	Maintain range selected, observe gear shift direction circuit
U0592	Invalid Data Received From Gear Shift Module (Shift Selector) 2	Yes	Maintain range selected, observe gear shift direction circuit